

# Integrated High Definition LED Television User's Guide:

58L9300U / 65L9300U / 84L9300U

If you need assistance:

Toshiba's Support Web site [support.toshiba.com](http://support.toshiba.com)

For more information, see "Troubleshooting" on page 177 in this guide.

### Owner's Record

The model number and serial number are on the back and side of your television. Record these numbers, whenever you communicate with your Toshiba dealer about this Television.

Model name: \_\_\_\_\_

Serial number: \_\_\_\_\_

Register your Toshiba Television at [register.toshiba.com](http://register.toshiba.com)

Note: To display a High Definition picture, the TV must be receiving a High Definition signal (such as an over-the-air High Definition TV broadcast, a High Definition digital cable program, or a High Definition digital satellite program). For details, contact your TV antenna installer, cable provider, or satellite provider.

GMA300022011  
9/13

# CHILD SAFETY:

## PROPER TELEVISION PLACEMENT MATTERS



### TOSHIBA CARES

- Manufacturers, retailers and the rest of the consumer electronics industry are committed to making home entertainment safe and enjoyable.
- As you enjoy your television, please note that all televisions – new and old- must be supported on proper stands or installed according to the manufacturer's recommendations. Televisions that are inappropriately situated on dressers, bookcases, shelves, desks, speakers, chests, carts, etc., may fall over, resulting in injury.

### TUNE IN TO SAFETY

- **ALWAYS** follow the manufacturer's recommendations for the safe installation of your television.
- **ALWAYS** read and follow all instructions for proper use of your television.
- **NEVER** allow children to climb on or play on the television or the furniture on which the television is placed.
- **NEVER** place the television on furniture that can easily be used as steps, such as a chest of drawers.
- **ALWAYS** install the television where it cannot be pushed, pulled over or knocked down.
- **ALWAYS** route cords and cables connected to the television so that they cannot be tripped over, pulled or grabbed.

### WALL OR CEILING MOUNT YOUR TELEVISION

- **ALWAYS** contact your retailer about professional installation if you have any doubts about your ability to safely mount your television.
- **ALWAYS** use a mount that has been recommended by the television manufacturer and has a safety certification by an independent laboratory (such as UL, CSA, ETL).
- **ALWAYS** follow all instructions supplied by the television and mount manufacturers.
- **ALWAYS** make sure that the wall or ceiling where you are mounting the television is appropriate. Some mounts are not designed to be mounted to walls and ceilings with steel studs or cinder block construction. If you are unsure, contact a professional installer.
- Televisions can be heavy. A minimum of two people is required for a wall or ceiling mount installation.

### MOVING AN OLDER TELEVISION TO A NEW PLACE IN YOUR HOME

- Many new television buyers move their older CRT televisions into a secondary room after the purchase of a flat-panel television. Special care should be made in the placement of older CRT televisions.
- **ALWAYS** place your older CRT television on furniture that is sturdy and appropriate for its size and weight.
- **NEVER** place your older CRT television on a dresser where children may be tempted to use the drawers to climb.
- **ALWAYS** make sure your older CRT television does not hang over the edge of your furniture.

## Dear Customer,

Thank you for purchasing this Toshiba LED TV. This document will help you use the many exciting features of your new LED TV. Before operating your LED TV, carefully read this manual completely.

### Safety Precautions

**WARNING: TO REDUCE THE RISK OF FIRE OR ELECTRIC SHOCK, DO NOT EXPOSE THIS APPLIANCE TO RAIN OR MOISTURE.**



**WARNING: TO REDUCE THE RISK OF ELECTRIC SHOCK, DO NOT REMOVE COVER (OR BACK). NO USER-SERVICEABLE PARTS INSIDE. REFER SERVICING TO QUALIFIED SERVICE PERSONNEL.**



The lightning flash with arrowhead symbol, within an equilateral triangle, is intended to alert the user to the presence of uninsulated "dangerous voltage" within the product's enclosure that may be of sufficient magnitude to constitute a risk of electric shock to persons.



The exclamation point within an equilateral triangle is intended to alert the user to the presence of important operating and maintenance (servicing) instructions in the literature accompanying the appliance.

### WARNING

Improper location and installation of a television can lead to the death of your child. Never place the television on furniture or in a location where children can climb up on and tip over the television. Please refer to the Child Safety information on page 2 and item 26) on page 4 in the Important Safety Instructions/Installation section.

### WARNING

To prevent injury, this apparatus must be securely attached to the floor/wall in accordance with the installation instructions. See item 26) on page 4.

**WARNING:** If you decide to wall mount this television, always use a mounting bracket that has been Listed by an independent laboratory (such as UL, CSA, ETL) and is appropriate for the size and weight of this television. The use of inappropriate or non-Listed mounting brackets could result in serious bodily injury and/or property damage. See "To Display your LED TV using a Wall Bracket:" on page 6.

### WARNING (for 84L9300 Series)

This apparatus has been designed with Class I construction and must be connected to a mains socket outlet with a protective earthing connection (third grounding pin)

### NOTE TO CATV INSTALLERS

This is a reminder to call the CATV system installer's attention to Article 820-40 of the U.S. NEC, which provides guidelines for proper grounding and, in particular, specifies that the cable ground shall be connected to the grounding system of the building, as close to the point of cable entry as practical. For additional antenna grounding information, see items 33) and 34) on page 5.

### Important Safety Instructions

- 1) Read these instructions.
- 2) Keep these instructions.
- 3) Heed all warnings.
- 4) Follow all instructions.
- 5) Do not use this apparatus near water.
- 6) Clean only with dry cloth.
- 7) Do not block any ventilation openings. Install in accordance with the manufacturer's instructions.
- 8) Do not install near any heat sources such as radiators, heat registers, stoves, or other apparatus (including amplifiers) that produce heat.
- 9) Do not defeat the safety purpose of the polarized or grounding type plug.
  - A polarized plug has two blades with one wider than the other.
  - A grounding type plug has two blades and a third grounding prong. The wide blade or the third prong are provided for your safety. If the provided plug does not fit into your outlet, consult an electrician for replacement of the obsolete outlet.
- 10) Protect the power cord from being walked on or pinched, particularly at plugs, convenience receptacles, and the point where they exit from the apparatus.
- 11) Only use attachments/accessories specified by the manufacturer.
- 12) Use only with the cart, stand, tripod, bracket, or table specified by the manufacturer, or sold with the apparatus. When a cart is used, use caution when moving the cart/apparatus combination to avoid injury from tip-over.
  - Wide blade
  - 58"/65"
  - 84"



84"



13) **Unplug this apparatus during lightning storms or when unused for long periods of time.**

14) **Refer all servicing to qualified service personnel.** Servicing is required when the apparatus has been damaged in any way, such as power-supply cord or plug is damaged, liquid has been spilled or objects have fallen into the apparatus, the apparatus has been exposed to rain or moisture, does not operate normally, or has been dropped.

## Additional Safety Precautions

14a) **CAUTION:** If the TV is dropped and the cabinet or enclosure surface has been damaged or the TV does not operate normally, take the following precautions:

- ALWAYS turn off the TV and unplug the power cord to avoid possible electric shock or fire.
- NEVER allow your body to come in contact with any broken glass or liquid from the damaged television. The LCD panel inside the TV contains glass and a toxic liquid. If the liquid comes in contact with your mouth or eyes, or your skin is cut by broken glass, rinse the affected area thoroughly with water and contact your doctor immediately.
- ALWAYS contact a service technician to inspect the TV any time it has been damaged or dropped.

15) **CAUTION:**

- To reduce the risk of electric shock, do not use the polarized plug with an extension cord, receptacle, or other outlet unless the blades can be inserted completely to prevent blade exposure.
- To prevent electric shock, match wide blade of plug to wide slot; fully insert.

16) **CAUTION:**

- Do not let children swallow any small parts included on or with the product or play with the plastic bag. Keep the small parts and the plastic bag out of the reach of children.

17) **CAUTION:**

- Do not let water or other liquids come into contact with the product, as it may result in damage.

18) **WARNING:**

- To prevent the spread of fire, keep candles or other open flames away from this product at all times.
- Keep the product away from direct sunlight, fire or a heat source such as a heater. This may reduce the product lifetime or result in fire.

## Installation, Care, and Service

### Installation

Follow these recommendations and precautions and heed all warnings when installing your TV:

19)  **WARNING: NEVER expose batteries to excessive heat such as sunshine or fire.**

20) ALWAYS plug the product into an outlet that is located in such a manner that it can be easily unplugged in case the product requires service.

21) NEVER route the product's power cord inside a wall or similar enclosed area.

22) Never modify this equipment. Changes or modifications may void: a) the warranty, and b) the user's authority to operate this equipment under the rules of the Federal Communications Commission.

23)  **DANGER: RISK OF SERIOUS PERSONAL INJURY, DEATH, OR EQUIPMENT DAMAGE**

Never place the TV on an unstable cart, stand, or table. The TV may fall, causing serious personal injury, death, or serious damage to the TV.



24) When selecting a location for the TV,

- NEVER allow any part of the TV to hang over the edge of the supporting furniture,
- NEVER place the TV on tall furniture (for example, entertainment centers or bookcases) without anchoring both the furniture and the TV to a suitable support,
- Never place cloth or other material between the TV and the supporting furniture.
- NEVER allow children to climb on the TV.

25) To avoid damage to this product, never place or store the TV in direct sunlight; hot, humid areas; or areas subject to excessive dust or vibration.

26) Always place the TV on the floor or a sturdy, level, stable surface that can support the weight of the unit. Secure the TV using one of the following methods:

(1) Secure the TV with a mounting screw (Recommended.)

- Place the TV on a sturdy surface that has a sufficient thickness and screw the unit on the surface securely by using the mounting screw and the fall-prevention screw hole.

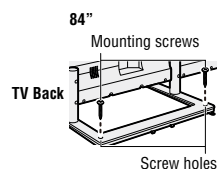
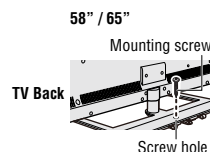



(2) Secure the TV with a sturdy strap to a wall stud, pillar, or other immovable structure. When connecting the strap:

- attach the strap to the TV using the hooks on the back of the TV, the clips on the pedestal, or the hole in the base of the pedestal, as available.
- make sure the strap is tight, secure, and parallel to the floor.

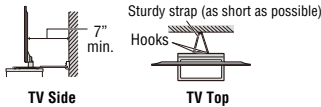

(3) Secure the TV with the fall-prevention band.

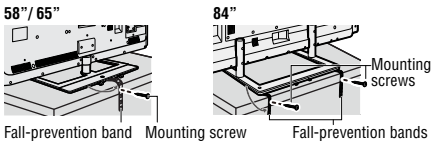

27) The apparatus shall not be exposed to dripping or splashing, and that no objects filled with liquids, such as vases, shall be placed on the apparatus.

28) Never block or cover the slots or openings in the TV cabinet back, bottom, and sides. Never place the TV:

- on a bed, sofa, rug, or similar surface;
- too close to drapes, curtains, or walls; or
- in a confined space such as a bookcase, built-in cabinet, or any other place with poor ventilation.

29) Always leave a space of at least 4 (four) inches around the TV. The slots and openings are provided to protect the TV from overheating and to help maintain reliable operation of the TV.

30) Never allow anything to rest on or roll over the power cord, and never place the TV where the power cord is subject to wear or abuse.

31) Never overload wall outlets and extension cords.

32) Always operate this equipment from a 120V AC, 60 Hz power source.

33) Always make sure the antenna system is properly grounded to provide adequate protection against voltage surges and built-up static charges (see Section 810 of the National Electric Code).

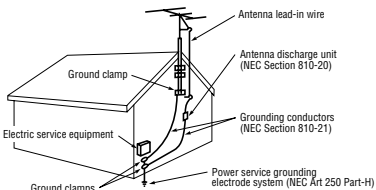

34) **! DANGER: RISK OF SERIOUS PERSONAL INJURY OR DEATH!**

- When installing a rooftop antenna, use extreme care to make sure you are never in a position where your body (or any item you are in contact with, such as a ladder or screwdriver) can accidentally touch overhead power lines. Never locate the antenna near overhead power lines or other electrical circuits.
- Never attempt to install any of the following during lightning activity: a) an antenna system; or b) cables, wires, or any home theater component connected to an antenna or phone system.

### Care

For better performance and safer operation of your TOSHIBA TV, follow these recommendations and precautions:

35) If you use the TV in a room whose temperature is 32° F (0° C) or below, the picture brightness may vary until the LCD warms up. This is not a sign of malfunction.

36) **! WARNING: RISK OF SERIOUS PERSONAL INJURY OR EQUIPMENT DAMAGE!**

- Never use chemicals (such as air fresheners, cleaning agents, etc.) on or near the TV pedestal. Studies indicate that plastics may weaken and crack over time from the combined effects of chemical agents and mechanical stress (such as the weight of the TV). Failure to follow these instructions could result in serious injury and/or permanent damage to TV and TV pedestal.
- Always unplug the TV before cleaning. Gently wipe the display panel surface (the TV screen) using a dry, soft cloth (cotton, flannel, etc.). A hard cloth may damage the surface of the panel. Avoid contact with alcohol, thinner, benzene, acidic or alkaline solvent cleaners, abrasive cleaners, or chemical cloths, which may damage the surface. Never spray volatile compounds such as insecticide on the cabinet. Such products may damage or discolor the cabinet.

37) Never hit, press, or place anything on the back cover. These actions will damage internal parts.

38) **⚡ RISK OF ELECTRIC SHOCK! !**  
Never spill liquids or push objects of any kind into the TV cabinet slots.

39) During a thunderstorm, do not touch the connecting cables or product.

40) For added protection of your TV from lightning and power surges, always unplug the power cord and

disconnect the antenna from the TV if you leave the TV unattended or unused for long periods of time.

- 41) Always unplug the TV to completely disconnect from mains power. When the TV is turned off using the on/off switch, it is not completely disconnected from power and a minute amount of current is still consumed.
- 42) During normal use, the TV may make occasional snapping or popping sounds. This is normal, especially when the unit is being turned on or off. If these sounds become frequent or continuous, unplug the power cord and contact a Toshiba Authorized Service Provider.

- 43)  **WARNING: RISK OF SERIOUS PERSONAL INJURY OR EQUIPMENT DAMAGE!**

Never strike the screen with a sharp or heavy object.

- 44) • The LCD screen of this product can be damaged by ultraviolet radiation from the sun. When selecting a location for the television, avoid locations where the screen may be exposed to direct sunlight, such as in front of a window.
- Never touch, press, or place anything on the LCD screen. These actions will damage the LCD screen. If you need to clean the LCD screen follow the instructions (in item 36) on page 5.

## Service

- 45)  **WARNING: RISK OF ELECTRIC SHOCK!** 

Never attempt to service the TV yourself. Opening and removing the covers may expose you to dangerous voltage or other hazards. Failure to follow this WARNING may result in death or serious injury. Refer all servicing not specified in this manual to a Toshiba Authorized Service Provider.

- 46) If you have the TV serviced:
- Ask the service technician to use only replacement parts specified by the manufacturer.
  - Upon completion of service, ask the service technician to perform routine safety checks to determine that the TV is in safe operating condition.

## Choosing a location for your LED TV

### To Display your LED TV on the included Pedestal Stand:

Observe the following safety precautions:

- 1) Read and follow the Pedestal Stand Assembly instructions included with the pedestal.

**58L9300U/65L9300U Series:**

**CAUTION:** Leave the TV standing in its packaging box until you have attached the support column and the stand. If the TV is laid down, it may become damaged.

**CAUTION:** Two or more people are required for installation to avoid injury or damage to the TV.

#### **84L9300U Series:**

**CAUTION:** Attach the stand while the TV is still in its packaging. Do not lay the TV down to attach the stand. Attaching the stand while the TV is laid down may damage the TV.

**CAUTION:** Four or more people are required for installation to avoid injury or damage to the TV.

**Note:** Extreme care should always be used when attaching the pedestal stand to avoid damage to the LCD panel.

- 2) Place the TV on a sturdy, level surface that can support the weight of the TV.
- 3) Be sure to secure the TV to a wall, pillar, surface, or other immovable structure see item 26) page 4 for additional details.

**CAUTION:** Always place the TV on the floor or a sturdy, level, stable surface that can support the weight of the unit. Secure the TV as described in item 26) of the Important Safety Instructions in this document.

### To Display your LED TV using a Wall Bracket:

If you decide to wall mount your LED TV, always use a wall bracket Listed by an independent laboratory (such as UL, CSA, ETL) that is appropriate for the size and weight of the TV (see page 3):

- 1) **CAUTION:** Two or more people are required for installation (for 58"/65").
- CAUTION:** Four or more people are required for installation (for 84").
- 2) Unplug and remove any cables and/or other component connectors from the rear of the TV.
- 3) Remove the screws of the VESA Mounting Pattern show in the table if applicable (for 84").
- CAUTION:** Do not use the screws removed from the back cover to attach the wall mount bracket to the TV.
- 4) Always use the screws supplied or recommended by the wall mount manufacturer.
- 5) Follow the instructions provided with your wall bracket. Before proceeding, make sure the appropriate bracket(s) are attached to the wall and the back of the TV as described in the instructions provided with the wall bracket.
- 6) After attaching the appropriate bracket(s) to the wall and the back of the TV, remove the pedestal stand from the TV, as described below.
- 7) VESA Mounting Pattern

TV Size	Hole Pattern (HxV)	Screw Size
58"	400x400 mm	M6
65"	400x400 mm	M6
84"	600x400 mm	M8

## Removing the Pedestal Stand

**Note:** *Extreme care should always be used when attaching the pedestal stand to avoid damage to the LCD panel.*

### 58L9300U/65L9300U Series:

- This process will require 2 or more people. Toshiba recommends using 3 people for this process. One person on each side of the TV and one person to remove the stand screws.
- Place the TV on a supporting surface around waist height. This will make it easier to lift the TV. Ensure the supporting surface can support the weight of the TV.
- With one person on each side of the TV,
  - the third person removes the four stand screws shown in the diagram below, then
  - two people lift the TV straight up off of the stand support to remove the pedestal stand from the TV.

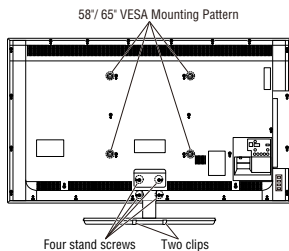

(Sample Illustration)

### 84L9300U Series:

- This process will require 4 or more people. Toshiba recommends using 5 people for this process. Two people on each side of the TV and one person to remove the stand screws.
- Place the TV on a supporting surface around waist height. This will make it easier to lift the TV. Ensure the supporting surface can support the weight of the TV.
- With two people on each side of the TV,
  - the fifth person removes the four stand screws shown in the diagram below, then
  - four people lift the TV straight up off of the stand support to remove the pedestal stand from the TV.

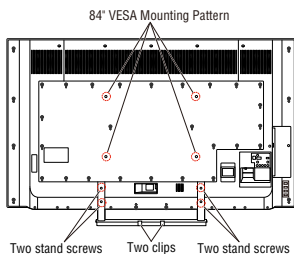

(Sample Illustration)

## Safety Precautions for 3D glasses

### Available 3D glasses

- 58"/84" : Toshiba FPT-AG03 (supplied)
- 65"/84" : Toshiba FPT-P100 (supplied)

- The 3D function has been designed for private use only. Please note that any commercial use of the 3D function or content provided on your TV could lead to copyright infringement of authors' rights.
- Viewing of 3D content requires compatible 3D glasses, compatible 3D display, compatible 3D playback device or 3D source and/or 3D capable HDMI™ cable.
- Carefully read instructions provided with your display and/or 3D glasses before 3D viewing. Warning

### DO NOT INGEST BATTERY, CHEMICAL BURN HAZARD. (For 58L9300U Only)

- This product contains a coin/button cell battery. If the coin/button cell battery is swallowed, it can cause severe internal burns in just 2 hours and can lead to death.
- Keep new and used batteries away from children. If the battery compartment does not close securely, stop using the product and keep it away from children.
- If you think batteries might have been swallowed or placed inside any part of the body, seek immediate medical attention.

### About handling the 3D glasses

#### Do not leave the 3D glasses or the accessories within the reach of small children.

Inhaling or swallowing them may cause suffocation or lesions in the stomach wall.

If swallowed, consult a doctor immediately.

#### Do not repair, modify, or disassemble the 3D glasses by yourself.

Doing so may cause a fire or cause you to become indisposed while viewing 3D images.

#### Do not expose the glasses to excessive heat such as sunshine or fire.

### Caution

#### About the 3D glasses

#### Do not use the 3D glasses if they are cracked, broken, or not working properly.

Continuing to use them in such a state may cause injury, eye strain, or minor discomfort.

#### Do not stand or walk while wearing 3D glasses.

You may lose your balance which could result in falls or other accidents.

#### Do not wear the 3D glasses for any purpose other than viewing 3D programming.

3D glasses do not function as sunglasses.

#### Do not drop, exert pressure on, or step on the 3D glasses.

Doing so may damage the glass section, which may result in injury.

Exposing the 3D glasses to liquid or excessive heat may damage the function.

- If your nose or temple turns red, or you feel any pain or discomfort, stop using the 3D glasses. Such symptoms may occur when wearing 3D glasses for long periods of time.
- Be careful not to pinch your fingers in the hinge of the 3D glasses.

### Cautions on watching the 3D images

- **Some viewers may experience a seizure or blackout when exposed to certain flashing images or lights contained in certain 3D television pictures or video games.**  
Anyone who has had a seizure, loss of awareness, or other symptoms linked to an epileptic condition, or has a family history of epilepsy, should contact a health care provider before using the 3D function.
- **Due to the possible impact on vision development, viewers of 3D video images should be age 6 or above.**  
Children and teenagers may be more susceptible to health issues associated with viewing in 3D and should be closely supervised to avoid prolonged viewing without rest.
- **Avoid using the 3D function when under the influence of alcohol.**
- **If you are ill or feel ill, you should refrain from viewing 3D images, and consult your health care provider as may be appropriate.**
- **If you experience any of the following symptoms when viewing 3D video images, stop viewing and contact your health care provider:**  
Convulsions, eye or muscle twitching, loss of awareness, altered vision, involuntary movements, disorientation, eye strain, nausea/vomiting, dizziness, headaches.
- **If you feel eye fatigue or other discomfort from viewing 3D video images, remove the 3D glasses and discontinue use until the condition is eliminated.**
- **Viewing in 3D may cause dizziness and/or disorientation for some viewers.**  
Therefore, to avoid injury do not place your TV near open stairwells, balconies, or wires.  
Also do not sit near objects that could be broken if accidentally hit.
- **When viewing 3D images, always wear 3D glasses.**  
Watching 3D images without 3D glasses may cause eye strain.  
Use specified 3D glasses.
- **When watching 3D images, do not wear 3D glasses at an angle and do not lie down.**  
If you watch while lying down or with the glasses tilted, the 3D effect is lost and it may cause eye strain.
- **It is recommended that the viewer's eyes and 3D glasses are level with the screen.**
- **If you have prescription eye glasses or contact lenses, wear the 3D glasses over them.**  
Watching 3D images without appropriate eyewear may cause eye strain.

- **If 3D images often appear in double or if you cannot see the images in 3D, stop viewing.**  
Continuous viewing may cause eye strain.
- **Due to the possible impact on vision development, viewers of 3D video images should be age 6 or above.**  
Children and teenagers may be more susceptible to health issues associated with viewing in 3D and should be closely supervised to avoid prolonged viewing without rest.
- **Watching TV while sitting too close to the screen for an extended period of time may cause eye strain.**  
The ideal viewing distance should be at least three times the screen height.

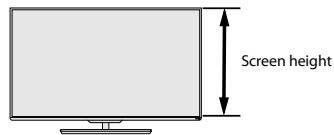

- **For 58L9300U Series: Use the 3D glasses in the following viewing angle.**  
Otherwise, you may not see the correct 3D image.  
Effective viewing angle:  
- Within 30° horizontal, 20° vertical

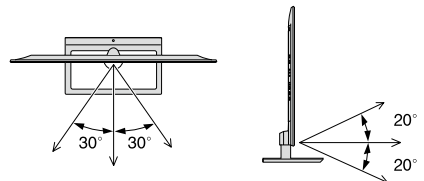

- **For 65L9300U/84L9300U Series: For optimal 3D effect and to avoid eye fatigue it is important that you properly select your viewing position.**  
The best viewing position is at the indicated viewing distance with your eyes at the same level as the center of the display as shown below. The center of the optimum viewing area varies from set to set. The usable viewing area is generally over the range shown in the table below (actual angle not depicted in drawing).

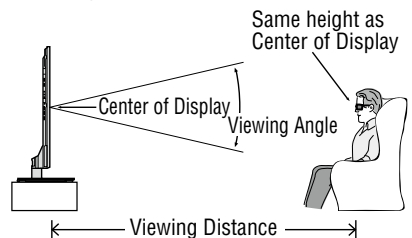

TV Size	Viewing angle	Viewing distance
65"	Approx. 16 deg.	Over 2.4 m
84"	Approx. 30 deg.	Over 3.1 m

**IMPORTANT:**

If you see a double image, your eyes are either too high or too low in relation to the horizontal center of the screen. Adjust your position so that it is closer to the center to avoid eye fatigue and to enjoy optimum 3D effects.

**Notes on handling the 3D glasses:**

- When cleaning the 3D glasses, gently wipe with a dry, soft cloth.
  - First, remove any dirt or dust from the 3D glasses.
  - Harsh rubbing or use of a dirty or coarse cloth will scratch the 3D glasses.
- Do not use benzene, paint thinner, alcohol, water, or abrasive cleaners, which may damage the 3D glasses.
- When not using the 3D glasses, put them in the supplied glasses pouch and store them away from high temperatures and humidity.
- Do not store the 3D glasses in areas of extreme heat or cold, as deformation can occur. If deformation occurs, replace the 3D glasses.
- The lenses of the 3D glasses are different from those of ordinary glasses, and are very thin. Be very careful in handling the 3D glasses as the lens can pop out easily.
- Do not put excessive force on the lenses.
- Do not scratch the surface of the lenses with sharp objects.
- Do not drop or bend the 3D glasses.

**Notes on IR communication (for 58L9300 Series):**

- Do not block the IR sensor for 3D glasses on the TV by placing objects in front of it.
- Do not cover the IR sensor on the 3D glasses with stickers or labels.
- Keep the IR sensor on the 3D glasses clean.
- The use of 3D glasses could interfere with other IR communication devices. Other IR communication devices may cause the 3D glasses not to work correctly. Use the TV and 3D glasses in a place where they will not interfere with other devices or products.

**Notes on watching the TV:**

- Proper 3D effects or 3D-to-2D conversion results may not be obtained depending on the received 3D content.
- 3D effect and image quality may vary depending upon content quality and display device capability/functionality/settings.
- (For 58L9300U Series) If you use any device, such as a mobile phone or mobile wireless device, near the 3D glasses, the 3D glasses may not work correctly.
- (For 58L9300U Series) Use the product in the following temperature range; otherwise, the quality of the 3D image or the reliability of the product cannot be guaranteed.
  - 3D glasses: 0° C - 40° C (32° F - 104° F)

- (For 58L9300U Series) If there is fluorescent lighting in the viewing area, it may flicker depending on the frequency of the light. In this case, reduce the brightness of the fluorescent light, or use another light. (It is not recommended to watch the TV in a dark room, especially for children.)
- Wear the 3D glasses properly, otherwise you may not see the correct 3D images.
- (For 58L9300U Series) When not viewing 3D images, take off the 3D glasses; otherwise, it may be difficult to see the display on other products such as PC, digital clock, or calculator, etc.
- The 2D to 3D conversion function is activated and controlled by you according to your personal preferences.
- The 2D to 3D conversion function is meant for enjoyment of 2D home video, and other 2D content you create, in 3D according to your personal preferences.
- The 2D to 3D conversion function is not intended for use with pre-recorded 2D copyrighted content owned by a third-party unless the copyright owner has given direct or indirect permission, or unless applicable law permits such use.

**FCC Caution**

To assure continued compliance, follow the attached installation instructions. Any changes or modifications not expressly approved by Toshiba America Information Systems, Inc. could void the user's authority to operate this device. Service Center or an experienced radio/TV technician for help.

**FCC Declaration of Conformity Compliance Statement (Part 15):**

Toshiba television models 58L9300 Series, 65L9300 Series, and 84L9300 Series comply with Part 15 of the FCC Rules.

Operation is subject to the following two conditions:

- (1) This device may not cause harmful interference, and
- (2) This device must accept any interference received, including interference that may cause undesired operation.

The party responsible for compliance to these rules is: Toshiba America Information Systems, Inc. 9740 Irvine Blvd., Irvine, CA 92618. Phone: 800-631-3811

*Note: This equipment has been tested and found to comply with the limits for a Class B digital device, pursuant to Part 15 of the FCC Rules. These limits are designed to provide reasonable protection against harmful interference in a residential installation. This equipment generates, uses, and can radiate radio frequency energy and, if not installed and used in accordance with the instructions, may cause harmful interference to radio communications. However, there is no guarantee that interference will not occur in a*

*particular installation. If this equipment does cause harmful interference to radio or television reception, which can be determined by removing and applying power to the equipment, the user is encouraged to try to correct the interference by one of the following measures:*

- Reorient or relocate the receiving antenna.
- Increase the separation between the equipment and receiver.
- Connect the equipment into an outlet on a circuit different from that to which the receiver is connected.
- Consult the dealer or an experienced radio/TV technician for help.

**Caution:** *Changes or modifications to this equipment not expressly approved by Toshiba could void the user's authority to operate this equipment.*

### Wireless Radio

For product available in the USA/Canada market, only channel 1–11 can be operated. Selection of other channels is not possible. The device could automatically discontinue transmission in case of absence of information to transmit, or operational failure. Note that this is not intended to prohibit transmission of control or signaling information or the use of repetitive codes where required by the technology. If this device is going to be operated in 5.15–5.25GHz frequency range, then it is restricted to an indoor environment only.

**Important:** *Any changes or modifications not expressly approved by the party responsible for compliance could void the user's authority to operate this equipment. This device and its antenna(s) must not be co-located or operating in conjunction with any other antenna or transmitter.*

**FCC Radiation Exposure Statement:** *This equipment complies with FCC radiation exposure limits set forth for an uncontrolled environment. This equipment should be installed and operated with minimum distance 20cm between the radiator & your body.*

### Important notes about your TV



The following symptoms are technical limitations of LCD Display technology and are not an indication of malfunction; therefore, Toshiba is not responsible for perceived issues resulting from these symptoms.

- 1) An afterimage (ghost) may appear on the screen if a fixed, non-moving image appears for a long period of time. The afterimage is not permanent and will disappear in a short period of time.
- 2) The LCD panel contained in this TV is manufactured using an extremely high level of precision technology; however, there may be an occasional pixel (dot of light) that does not operate properly (does not light, remains constantly lit, etc.). This is a structural property of LCD technology, is not a sign of malfunction, and is not covered under your warranty. Such pixels

are not visible when the picture is viewed from a normal viewing distance.

**Note:** *Interactive video games that involve shooting a "gun" type of joystick at an on-screen target may not work with this TV.*

### Trademark Information

- AutoView, Cinema Series, ClearScan, ColorMaster, ColorStream, CQ Engine, DynaLight, GameTimer, Native Mode, TriVector and Resolution+ are trademarks or registered trademarks of Toshiba America Information Systems, Inc.
- ActiveX is a registered trademark of the Microsoft Corporation.
- Android is a trademark of Google Inc.
-  Audyssey Premium Television™ is a trademark of Audyssey Laboratories, Inc. U.S. and foreign patents pending. Audyssey Premium Television™ is a suite of technologies that remove the acoustical problems caused by small speakers and drivers. Working together these technologies deliver a better translation of the audio content and make the television experience sound closer to the original.
- Blu-ray Disc™, Blu-ray™, and the logos are trademarks of the Blu-ray Disc Association
- CinemaNow is a registered trademark of BBY Solutions, Inc.
- DivX®, DivX Certified®, DivX Plus® HD and associated logos are trademarks of Rovi Corporation or its subsidiaries and are used under license.
-  Manufactured under license from Dolby Laboratories. Dolby and the double-D symbol are trademarks of Dolby Laboratories.
- The terms HDMI and HDMI High-Definition Multimedia Interface, and the HDMI logo are trademarks or registered trademarks of HDMI Licensing LLC in the United States and other countries.
- Intel and the Intel logo are trademarks of Intel Corporation in the U.S. and/or other countries.
- iTunes Store is a trademark of Apple Inc., registered in the U.S. and other countries.
- MPEG Layer-3 audio coding technology licensed from Fraunhofer IIS and Thomson.
- Netflix is a registered trademark of Netflix, Inc.
- Skype, the Skype logo and the "S" logo are trademarks of Skype and are used with the permission of Skype.



- VUDU, Vudu Apps, and Vudu HD Movies are trademarks or registered trademarks of VUDU, Inc
- Designed with UEI Technology™. Under License from Universal Electronics Inc. Portions © UEI 2000-2012.
- Wi-Fi is a registered mark of the Wi-Fi Alliance.
- All other brand and product names are trademarks or registered trademarks of their respective companies.
- THIS PRODUCT IS LICENSED UNDER THE AVC PATENT PORTFOLIO LICENSE FOR THE PERSONAL AND NONCOMMERCIAL USE OF A CONSUMER TO (i) ENCODE VIDEO IN COMPLIANCE WITH THE AVC STANDARD ("AVC VIDEO") AND/OR (ii) DECODE AVC VIDEO THAT WAS ENCODED BY A CONSUMER ENGAGED IN A PERSONAL AND NON-COMMERCIAL ACTIVITY AND/OR WAS OBTAINED FROM A VIDEO PROVIDER LICENSED TO PROVIDE AVC VIDEO. NO LICENSE IS GRANTED OR SHALL BE IMPLIED FOR ANY OTHER USE. ADDITIONAL INFORMATION MAY BE OBTAINED FROM MPEG LA, LLC. SEE [HTTP://WWW.MPEGLA.COM](http://www.MPEGLA.COM)
- THIS PRODUCT IS LICENSED UNDER THE VC-1 PATENT PORTFOLIO LICENSE FOR THE PERSONAL AND NONCOMMERCIAL USE OF A CONSUMER TO (i) ENCODE VIDEO IN COMPLIANCE WITH THE VC-1 STANDARD ("VC-1 VIDEO") AND/OR (ii) DECODE VC-1 VIDEO THAT WAS ENCODED BY A CONSUMER ENGAGED IN A PERSONAL AND NON-COMMERCIAL ACTIVITY AND/OR WAS OBTAINED FROM A VIDEO PROVIDER LICENSED TO PROVIDE VC-1 VIDEO. NO LICENSE IS GRANTED OR SHALL BE IMPLIED FOR ANY OTHER USE. ADDITIONAL INFORMATION MAY BE OBTAINED FROM MPEG LA, LLC. SEE [HTTP://WWW.MPEGLA.COM](http://www.MPEGLA.COM)
- THIS PRODUCT IS LICENSED UNDER THE MPEG-4 VISUAL PATENT PORTFOLIO LICENSE FOR THE PERSONAL AND NON-COMMERCIAL USE OF A CONSUMER FOR (i) ENCODING VIDEO IN COMPLIANCE WITH THE MPEG-4 VISUAL STANDARD ("MPEG-4 VIDEO") AND/OR (ii) DECODING MPEG-4 VIDEO THAT WAS ENCODED BY A CONSUMER ENGAGED IN A PERSONAL AND NON-COMMERCIAL ACTIVITY AND/OR WAS OBTAINED FROM A VIDEO PROVIDER LICENSED BY MPEG LA TO PROVIDE MPEG-4 VIDEO. NO LICENSE IS GRANTED OR SHALL BE IMPLIED FOR ANY OTHER USE. ADDITIONAL INFORMATION INCLUDING THAT RELATING TO PROMOTIONAL, INTERNAL AND COMMERCIAL USES AND LICENSING MAY BE OBTAINED FROM MPEG powered LA, LLC. SEE [HTTP://WWW.MPEGLA.COM](http://WWW.MPEGLA.COM)

## Copyright

This guide is copyrighted by Toshiba America Information Systems, Inc. with all rights reserved. Under the copyright laws, this guide cannot be reproduced in any form without the prior written permission of Toshiba. No patent liability is assumed, however, with respect to the use of the information contained herein.

©2013 by Toshiba America Information Systems, Inc. All rights reserved.

## Notice

The information contained in this manual, including but not limited to any product specifications, is subject to change without notice.

**TOSHIBA CORPORATION AND TOSHIBA AMERICA INFORMATION SYSTEMS, INC. (TOSHIBA) PROVIDES NO WARRANTY WITH REGARD TO THIS MANUAL OR ANY OTHER INFORMATION CONTAINED HEREIN AND HEREBY EXPRESSLY DISCLAIMS ANY IMPLIED WARRANTIES OF MERCHANTABILITY OR FITNESS FOR ANY PARTICULAR PURPOSE WITH REGARD TO ANY OF THE FOREGOING. TOSHIBA ASSUMES NO LIABILITY FOR ANY DAMAGES INCURRED DIRECTLY OR INDIRECTLY FROM ANY TECHNICAL OR TYPOGRAPHICAL ERRORS OR OMISSIONS CONTAINED HEREIN OR FOR DISCREPANCIES BETWEEN THE PRODUCT AND THE MANUAL. IN NO EVENT SHALL TOSHIBA BE LIABLE FOR ANY INCIDENTAL, CONSEQUENTIAL, SPECIAL, OR EXEMPLARY DAMAGES, WHETHER BASED ON TORT, CONTRACT OR OTHERWISE, ARISING OUT OF OR IN CONNECTION WITH THIS MANUAL OR ANY OTHER INFORMATION CONTAINED HEREIN OR THE USE THEREOF.**

# Contents

---

Chapter 1: Introduction .....	20
Safety icons.....	20
Features .....	21
Overview of installation, setup, and use .....	22
TV front and side panel controls and connections.....	24
Front panel .....	24
Left side.....	25
TV back panel controls and connections .....	26
Back panel controls .....	27
Back panel connections .....	28
Chapter 2: Connecting Your TV .....	29
Overview of cable types.....	29
Coaxial cable (F-type) .....	29
Standard AV cables (red/white/yellow) .....	29
Component video cables (red/green/blue) .....	30
HDMI™ cable (with HDMI Logo).....	30
Dual-wand IR blaster cable.....	30
Optical audio cable .....	31
Analog RGB (15-pin) computer cable .....	31
3.5mm Stereo to RCA Y-cable .....	31
LAN cable .....	32



---

About the connection illustrations .....	32
Connecting an antenna, satellite receiver, and/or cable TV box .....	32
Connecting DVD to ColorStream® or VCR to composite video .....	34
Connecting remote IR devices.....	35
Using the IR blaster OUT terminal .....	35
Connecting a digital audio system.....	38
Connecting an HDMI™ or DVI device to the HDMI™ input .....	39
Using the TV remote and HDMI™ CEC Control to control other devices .....	41
Connecting an HDMI™ audio system .....	42
Connecting a computer .....	43
Connecting a computer to the TV's PC IN terminal.....	43
Connect a computer to the TV's HDMI™ terminal.....	44
Connecting to a home network.....	45
Connecting the TV directly to a computer without an Internet connection .....	45
Connecting the TV to a home network without an Internet connection .....	46
Connecting the TV to a home network with an Internet connection - wired .....	47
Connecting the TV to a home network with an Internet connection - wireless.....	48
Connecting the AC cord on your TV (for 84L9300U Series).....	49
<b>Chapter 3: Using the Remote Control .....</b>	<b>50</b>
Controlling other devices .....	50
Installing batteries.....	50
Remote control effective range .....	52
Learning about the remote control .....	53

Chapter 4: nitial Setup and Menu .....	55
Initial setup .....	55
Performing the initial setup .....	56
Navigating the menu system .....	65
Quick Menu .....	66
Chapter 5: Setting up your TV .....	67
How to navigate the menu.....	67
Changing initial settings .....	67
Individual settings .....	67
Storing channels in memory (optional) .....	69
Skipping channels .....	70
Skipping video inputs .....	71
Labeling analog TV channels .....	71
Labeling video inputs.....	72
Configuring shared input.....	72
Chapter 6: Basic features.....	73
Using 3D functions.....	73
Viewing 3D images.....	75
Setting the 3D PIN code .....	81
Displaying 3D Important Information .....	84
Adjusting 2D to 3D depth .....	84
Switching left and right images .....	84
Adjusting your viewing position (for 65/84L9300U only) .....	84
Tuning Channels.....	85
Tuning to the next programmed channel .....	85
Tuning to a specific channel (programmed or unprogrammed).....	85
Using Channel Return.....	85
Selecting the video input to view.....	85
Using closed captions .....	86
Analog CC mode.....	87
Digital CC settings .....	88
Setting the PIN code.....	89

Entering a new PIN code .....	89
Changing or deleting your PIN code .....	89
Forgotten PIN code.....	90
Using parental controls .....	90
Blocking TV programs and movies by rating (V-Chip) .....	90
Downloading an additional rating system .....	91
Displaying ratings.....	93
Unlocking programs .....	93
Locking specific channels .....	93
Locking video inputs .....	94
Setting a time limit for games.....	94
Locking the control panel .....	94
Using HDMI™ CEC Control.....	95
Controlling HDMI™ CEC playback devices .....	96
HDMI™ CEC Control input source selection.....	97
Adjusting the amplifier's audio .....	97
Other HDMI™ CEC Control functions .....	98
Viewing the HDMI™ signal information .....	98
Using your computer with the TV.....	99
Adjusting the image.....	99
Setting the computer audio .....	100
Setting the timer to turn on the TV .....	100
Setting the sleep timer .....	101
Setting No Signal Power Down .....	102
Setting TV Power On Control .....	103
Displaying TV status information .....	104
Viewing support information .....	104
Resetting to Factory Defaults .....	105
Power failure .....	105
<b>Chapter 7: Picture and Sound Controls .....</b>	<b>106</b>
Selecting the picture size.....	106
Scrolling the picture .....	111
Using the Auto Aspect feature .....	111
Using the 4:3 Stretch .....	111

---

Adjusting the picture .....	112
Selecting the picture mode .....	112
Adjusting the picture quality .....	113
Using the advanced picture settings features .....	114
Resolution+ .....	114
Dynamic Contrast .....	114
DynaLight® .....	114
ClearScan® .....	115
MPEG NR .....	115
DNR .....	115
Ambient Light Sensor .....	116
ColorMaster™ .....	116
Base Color Adjustment .....	117
Color temperature .....	117
Fine Texture Restoration .....	118
Brilliance Restoration .....	118
3D Judder Cancellation .....	118
Resetting to the factory default .....	119
Setting the expert picture settings .....	120
Test Pattern .....	120
RGB Filter .....	120
White Balance .....	121
Adjusting the audio .....	122
Muting the sound .....	122
Selecting stereo/SAP broadcasts .....	122
Adjusting the audio balance .....	122
Adjusting the range .....	122
TV Speakers On/Off .....	123
Setting the Primary Audio Language .....	123
Selecting the optical audio output format .....	123
Using the Dolby® Digital Dynamic Range Control feature .....	124
Audyssey Premium Television™ .....	125
Using Audyssey EQ® for Wall Mounted or Table-top TVs .....	125

Using Audyssey Dynamic Volume® .....	126
Audyssey ABX™ .....	126
Using the surround sound feature .....	126
<b>Chapter 8: Advanced features .....</b>	<b>127</b>
Using your home network .....	127
When using a Wireless network connection .....	128
Setting up the Network .....	129
Wireless Setup .....	129
Advanced Network Setup .....	134
Network Connection Test .....	136
Using the software keyboard .....	137
Enter text using the software keyboard .....	138
Performing a Software Upgrade .....	139
Viewing the Software Licenses .....	139
Using Intel® WiDi .....	140
Changing the Intel® WiDi Device Name .....	141
Device List .....	141
Using the Cloud Service .....	141
Using the Cloud TV Service features .....	142
eMANUAL .....	142
Feature apps .....	143
Netflix® .....	143
VUDU™ HD Movies and VUDU™ Apps .....	144
Internet .....	144
Using Skype™ .....	147
MediaShare (Videos, Music, and Photos) .....	157
MediaShare specifications .....	157
Basic operation .....	158
Viewing movie files .....	161
Playing music files .....	166
Viewing photo files .....	168
Search .....	171
Network Device Setup .....	172
External Control Setup .....	172
Setting up the Media Renderer feature .....	172

Chapter 9: Cloud TV Companion Apps .....	174
Using Apps on a Tablet or Smart phone .....	174
Apps Control Profile .....	175
Pairing.....	176
Chapter 10:Troubleshooting .....	177
General troubleshooting .....	177
Picture problems.....	178
Sound problems.....	180
Remote control problems.....	180
Channel tuning problems .....	180
Closed caption problems.....	181
Rating blocking (V-Chip) problems .....	181
HDMI™ CEC Control operation .....	181
HDMI™ problems .....	182
Network problems.....	182
Wireless network problems.....	184
MediaShare problems .....	184
Cloud TV .....	185
Light Indicator.....	185
Power On/Standby light .....	185
If the problem persists after trying the solutions.....	185
Appendix A: Specifications.....	186
Television system .....	186
Channel coverage .....	186
Power source .....	186
Power consumption .....	187
Audio power .....	187
Speaker type .....	187
Video/audio terminals .....	187
Video/audio input .....	187
ColorStream® (component video) HD input.....	187
HDMI™ input .....	187
Digital audio output .....	188
PC input.....	188

---

Wireless connection .....	188
Ethernet .....	188
USB .....	188
SD card.....	188
Dimensions with table stand .....	188
Weight (mass) with stand .....	189
Operating conditions .....	189
Supplied accessories.....	189
Acceptable signal formats for PC IN, and HDMI™ , and 3D .....	190
PC IN signal formats.....	190
HDMI™ signal formats.....	191
3D Signal formats* .....	192
4K Video Support formats .....	192
Operating the TV with combination buttons .....	193
Appendix B:Wireless QWERTY keyboard with touchpad ....	194
International Key table .....	197
Index .....	198

# Chapter 1

## Introduction

---

### Safety icons

This manual contains safety instructions that must be observed to avoid potential hazards that could result in personal injuries, damage to your equipment, or loss of data. These safety cautions have been classified according to the seriousness of the risk, and icons highlight these instructions as follows:

---

**▲ DANGER** Indicates an imminently hazardous situation which, if not avoided, will result in death or serious injury.

---

---

**▲ WARNING** Indicates a potentially hazardous situation which, if not avoided, could result in death or serious injury.

---

---

**▲ CAUTION** Indicates a potentially hazardous situation which, if not avoided, may result in minor or moderate injury.

---

---

**CAUTION** Indicates a potentially hazardous situation which, if not avoided, may result in property damage.

---

---

**NOTE** Provides important information.

---



## Features

- ❖ **Integrated digital tuning (8VSB ATSC and QAM)** — Eliminates the need for a separate digital converter set-top box (in most cases).
- ❖ **3840 x 2160 display resolution.**
- ❖ **Quad FHD**— Allows you to enjoy high quality full HD pictures using the 4K panel and the 4K extended definition function.
- ❖ **Four HDMI™**—Digital, High-Definition Multimedia Interfaces with 1080p and limited 4K input support see [“3D Signal formats\\*” on page 192.](#)
- ❖ **HDMI™ capabilities ARC (Audio Return Channel)**—Enables the audio signal of the TV to be sent to an AV amplifier via an HDMI™ cable. See [“HDMI™ ARC \(Audio Return Channel\) feature” on page 42.](#)
- ❖ **HDMI™ CEC Control**—Allows control of external devices from the TV remote via HDMI™ connection. See [“Using the TV remote and HDMI™ CEC Control to control other devices” on page 41.](#)
- ❖ **ColorStream® HD**—High-resolution component video input.
- ❖ **Digital Audio Out**—Optical audio connection with Dolby® Digital optical output format, see [“Connecting a digital audio system” on page 38.](#)
- ❖ **CQ Engine™**—A powerful video processing engine with an array of advanced technology including Edge Enhancement, Dynamic Gamma, ColorMaster, Expert Mode and new DNR that creates superior picture quality.
- ❖ **DNR**—New Dynamic Noise Reduction technology that filters out video noise without decreasing picture sharpness for clean, crystal-clear images, see [“DNR” on page 115.](#)
- ❖ **PC IN (Analog RGB)**—Computer Input terminal, see [“Connecting a computer” on page 43.](#)
- ❖ **IR Blaster Out**— Controls infrared remote controlled devices from the TV.
- ❖ **Built-in WLAN**—Allows the television to access your home wireless network.
- ❖ **Intel® WiDi**—Technology allows direct wireless connection between the TV and Intel® WiDi equipped computers or mobile devices.
- ❖ **ColorMaster™**—Technology allows you to adjust the TV’s

standard colors, see [“ColorMaster™” on page 116](#).

- ❖ **ClearScan®**—Technology uses both frame interpolation technology and advanced backlight control with image synchronization to quadruple the TV refresh rate for an even clearer fast motion video. See [“ClearScan®” on page 115](#).
- ❖ **DynaLight®**—Backlight control monitors the brightness of each video frame and automatically adjusts backlight intensity based on the content to create higher dynamic contrast, for deeper blacks and increased depth. See [“DynaLight®” on page 114](#).
- ❖ **AutoView®**—Allows you to automatically adjust picture settings including Brightness, Contrast, Gamma, and Sharpness based on ambient room light conditions and incoming picture content to create the best possible picture settings without any manual adjustment.
- ❖ **Audyssey Premium Television™**—Includes innovative audio enhancement technologies that create clear, rich, and natural sound. These technologies include EQ®, ABX™, Dynamic Volume®, Volume Extension™, and Day/Night and Wall/Table Modes. See [“Audyssey Premium Television™” on page 125](#).
- ❖ **MediaShare**—Allows you to view photo files and play music or movie files, see [“MediaShare \(Videos, Music, and Photos\)” on page 157](#).
- ❖ **Cloud TV**—Enhanced content discovery includes real time streaming news, true social interaction features, and mobile device interaction. See [“Using the Cloud TV Service features” on page 142](#).
- ❖ **Wireless QWERTY keyboard with built-in touchpad**.
- ❖ **3D capability**—Allows you to view and experience 3D content on the television while using special glasses.

## Overview of installation, setup, and use

Follow these steps to set up your TV and begin using its many exciting features.

- 1 Carefully read the important safety, installation, care, and service information. Keep this manual for future reference.
- 2 To choose a location for the TV:
  - ❖ Read [“Important notes about your TV” on page 10](#).
  - ❖ Place the TV on the floor or a sturdy, level, stable surface that can support the weight of the unit. Secure the TV to a wall,

- pillar, or other immovable structure, see [24](#)) on page 4.
- ❖ Place the TV in a location where light does not reflect on the screen.
  - ❖ Place the TV far enough from walls and other objects to allow proper ventilation. Inadequate ventilation may cause overheating, which will damage the TV. THIS TYPE OF DAMAGE IS NOT COVERED UNDER THE TOSHIBA LIMITED WARRANTY.
- 3 Do not plug in any power cords until after you have connected all cables and devices to your TV.
  - 4 Before connecting cables or devices to the TV, review the functions of the TV's connections and controls, see [“Overview of cable types” on page 29](#).
  - 5 Connect your other electronic device(s) to the TV, see [“Connecting Your TV” on page 29](#).
  - 6 Install the batteries in the remote control, see [“Installing batteries” on page 50](#).
  - 7 See [“Using the Remote Control” on page 50](#) for an overview of the buttons on the remote control.
  - 8 After connecting all cables and devices, plug in the power cords for your TV and other devices. Then press the **POWER** button on the TV control panel or remote control to turn on the TV.

---

**NOTE** If the TV stops responding to the buttons on the remote control or TV control panel and you cannot turn the TV off or on, unplug the power cords for a few seconds and then plug them in and try again.

---

- 9 See [“Navigating the menu system” on page 65](#) for a quick overview of navigating the TV's menu system.
- 10 Program channels into the TV's channel memory, see [“Auto Tuning” on page 69](#).
- 11 For details on using the TV's features, see chapters 6, 7, and 8.
- 12 For help, refer to [“Troubleshooting” on page 177](#).
- 13 For technical specifications, see [“Specifications” on page 186](#).

## TV front and side panel controls and connections

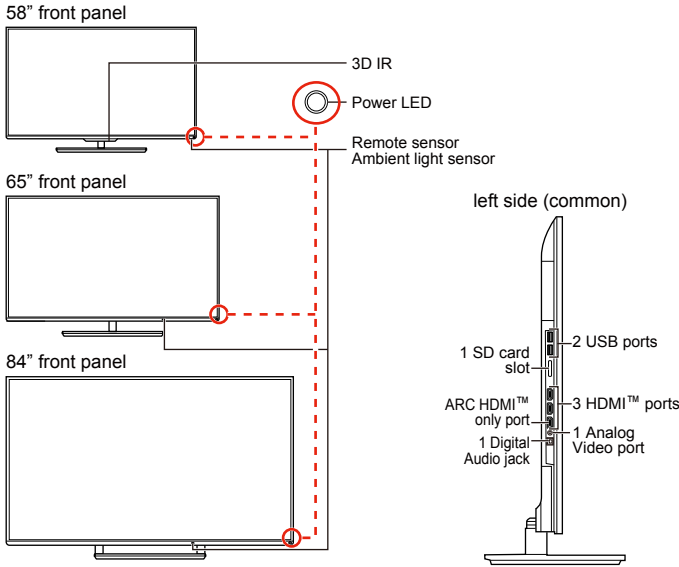

*(Sample Illustration) L9300U Series front and side panel controls and connections*

### Front panel

- 1 Power On/Standby LED**—Power indicator light, (glows green when the TV power is On).
- 2 Ambient light sensor**—This sensor detects the ambient light conditions to optimize the backlighting levels, see “[Ambient Light Sensor](#)” on page 116.
- 3 Remote Sensor**—Point the remote control toward this remote sensor, see “[Remote control effective range](#)” on page 52.
- 4 3D IR**—This sensor detects the 3D IR (for 58L9300U model only).

**Left side**

- 5 Analog Video Port**—Analog Video input. Connect using a commercially available conversion cable.
- 6 3 HDMI™ Ports**—High-Definition Multimedia Interface input receives digital audio and uncompressed digital video from an HDMI™ device or uncompressed digital video from a DVI device. HDMI™ connection is necessary to receive 1080p and 4K signals.
- 7 ARC HDMI™ only port**—Audio Return Channel (ARC) enables the audio signal of the TV to be sent to an AV amplifier via the HDMI cable.
- 8 Digital Audio Jack**—Optical audio output in Dolby® Digital or PCM (pulse-code modulation) format for connecting an external Dolby® Digital decoder, amplifier, A/V receiver, or home theater system with optical audio input.
- 9 2 USB Ports**—Used to access video, music, or photo files with USB device. Works with the wireless keyboard.
- 10 SD card slot**—Used to access video, music, or photo files with SD card.

TV back panel controls and connections

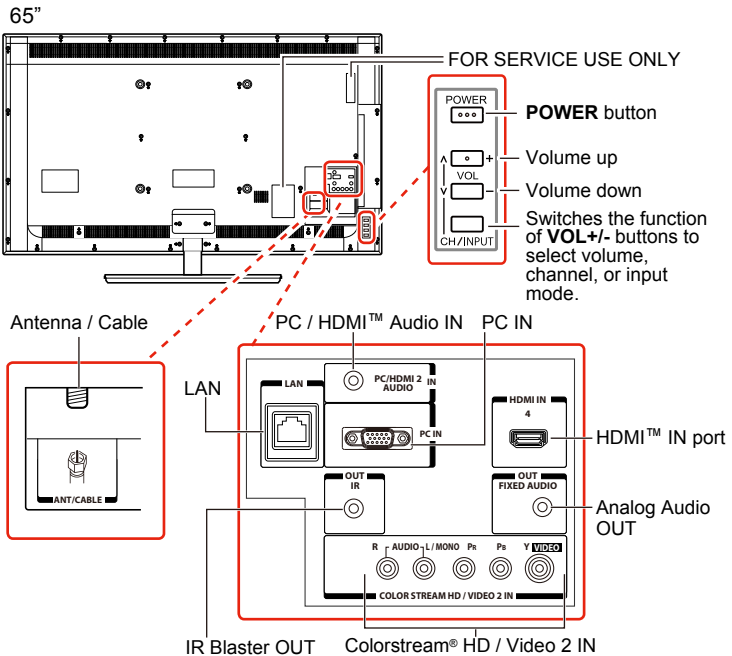
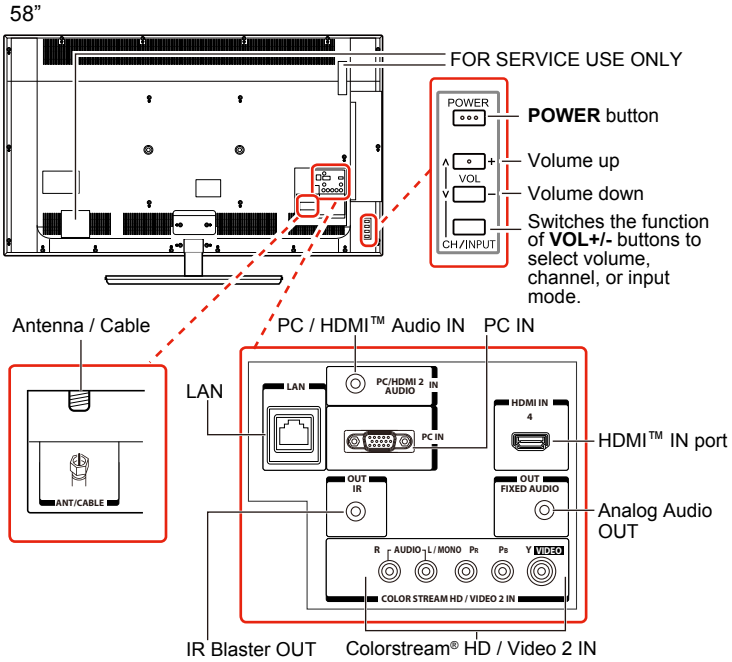

## TV back panel controls and connections

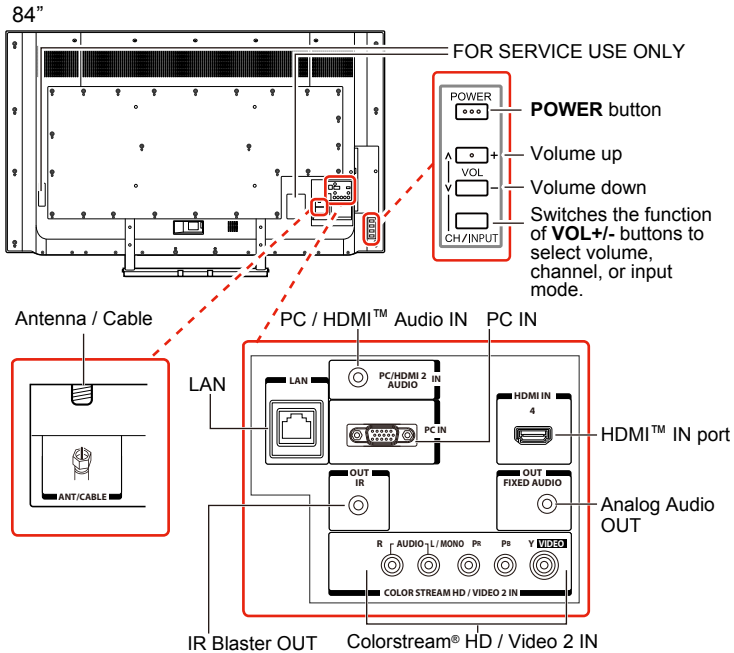

*(Sample Illustration) L9300U Series back panel controls and connections*

For explanations of cable types and connections, see “[Connecting Your TV](#)” on page 29.

## Back panel controls

- 1 **POWER**—Turns the TV On and Off.
- 2 **VOL +/-** —Adjust the volume level, change the channel, or change the input or source you are viewing, depending on the mode, which is selected by the **CH/INPUT** button.
- 3 **CH / INPUT**— Switches the function of the **VOL +/-** buttons to select the volume, channel, or input mode.
  - ❖ In Volume mode, the arrow buttons increase or decrease the volume.
  - ❖ In Channel mode, the arrow buttons change the channel up or down.
  - ❖ In Source mode, the arrow buttons toggle the input from one source to the next.

The mode of the **VOL +/-** buttons change in the following order each time the button is pressed:

→ **Channel** → **Input** → **Volume** →

## Back panel connections

- 4 **LAN IN**—Connects the TV to your home network.
- 5 **HDMI™ IN**—High-Definition Multimedia Interface input receives digital audio and uncompressed digital video from an HDMI™ device or uncompressed digital video from a DVI device. HDMI™ connection is necessary to receive 1080p and 4K signals.
- 6 **Analog Audio Port**—Analog audio outputs for connecting an audio amplifier.
- 7 **PC IN**—For use when connecting a personal computer.
- 8 **ANT/CABLE**—Antenna input that supports analog (NTSC) and digital (ATSC) off-air antenna signals and analog and digital Cable TV (QAM) signals.
- 9 **ColorStream® HD/ Video 2 IN**—These include standard A/V connections, see “[Connecting DVD to ColorStream® or VCR to composite video](#)” on page 34.
- 10 **PC/HDMI™ Audio IN**—PC audio input terminals are shared with HDMI™-2 analog audio input terminals, and their use can be configured in the Configuring shared inputs menu, see “[Configuring shared input](#)” on page 72.
- 11 **IR Blaster OUT**—Used to connect and control infrared remote-controlled devices.
- 12 **FOR SERVICE USE ONLY**—Connectors for service use only.

---

### NOTE

Component/Standard (composite) video cables carry only video information; separate audio cables are required.

---



# Chapter 2

## Connecting Your TV

---

### Overview of cable types

Before purchasing cables, know the connector types your devices require. You can purchase cables from most stores that sell audio/video devices.

### Coaxial cable (F-type)



*(Sample Illustration) Coaxial cable*

Coaxial (F-type) cable connects your antenna, cable TV service, and/or cable converter box to the ANT/CABLE input on your TV.

---

**NOTE** Please tighten this connection by hand. Using tools may damage the connection.

---

### Standard AV cables (red/white/yellow)

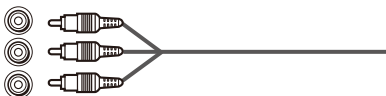

*(Sample Illustration) Standard A/V cables*

Standard A/V cables (composite video) usually come in sets of three, and connect to video devices with analog audio and composite video output. These cables (and the related inputs on your TV) are typically color-coded according to use: yellow for video, red for stereo right audio, and white for stereo left (or mono) audio.

### **Component video cables (red/green/blue)**

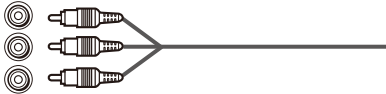

*(Sample Illustration) Component video cables*

Component video cables come in sets of three and are for use with video devices with component video output. (ColorStream<sup>®</sup> is Toshiba's brand of component video.) These cables are typically color-coded red, green, and blue. Separate audio cables are required for a complete connection.

---

**NOTE** Component video cables provide better picture quality than composite video cables.

---

### **HDMI™ cable (with HDMI Logo)**



*(Sample Illustration) HDMI™ cable*

HDMI™ (High-Definition Multimedia Interface) cable connects to devices that have an HDMI™ output. An HDMI™ cable delivers digital audio and video in its native format. Separate audio cables are not required, see “Connect a computer to the TV’s HDMI™ terminal” on page 44.

---

**NOTE** HDMI™ cables provide the best audio and picture quality.

---

### **Dual-wand IR blaster cable**

Connect the dual-wand IR blaster cable to the IR blaster terminal to control infrared remote controlled devices from the TV.

## Optical audio cable



*(Sample Illustration) Optical audio cable*

Optical audio cable connects receivers with Dolby<sup>®</sup> Digital or PCM (pulse-code modulation) optical audio input to the TV's Digital Audio Out terminal, see [“Connecting a digital audio system” on page 38.](#)

## Analog RGB (15-pin) computer cable

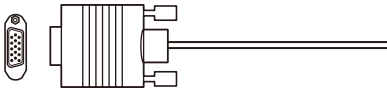

*(Sample Illustration) Analog RGB (15-pin) computer cable*

Analog RGB (15-pin) computer cable connects a computer to the TV's **PC IN** terminal, see [“Connecting a computer to the TV's PC IN terminal” on page 43.](#)

---

**NOTE** Separate audio cables are required.

---

## 3.5mm Stereo to RCA Y-cable



*(Sample Illustration) 3.5mm Stereo to RCA Y- cable*

3.5mm Stereo to RCA Y-cable connects an audio signal from DVI device to TV.

## LAN cable



### (Sample Illustration) LAN cable

Standard LAN cable connects the TV to your home network, see “Connecting the TV to a home network with an Internet connection - wired” on page 47.

Crossover LAN cable connects the TV directly to a computer, see “Connecting the TV directly to a computer without an Internet connection” on page 45.

## About the connection illustrations

You can connect different types and brands of devices to your TV in several different configurations. The connection illustrations in this manual are representative of typical device connections only. The input/output terminals on your devices may differ from those illustrated. For details on connecting and using your specific devices, refer to each device’s owner’s manual.

## Connecting an antenna, satellite receiver, and/or cable TV box

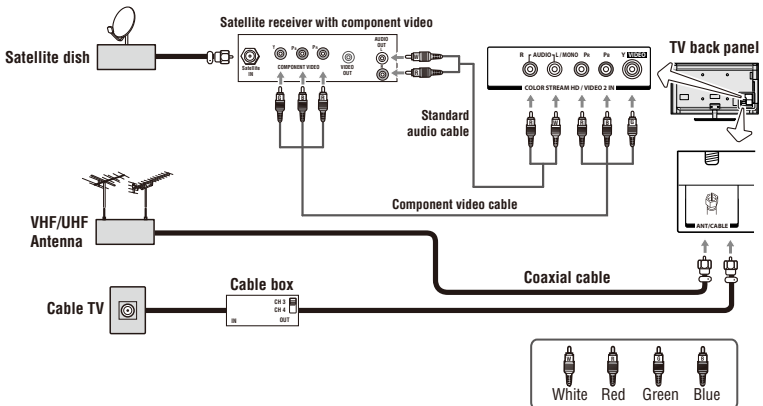

### (Sample Illustration) L9300U Series—Connecting to an antenna, satellite receiver, and/or cable TV box

**Items needed:**

- ❖ Coaxial cables
  - ❖ Standard AV cables
  - ❖ Component video cables (red/green/blue)
- 

**NOTE** When you use a cable box, you may not be able to use the remote control to program or access certain features on the TV.

---

**To view the antenna or cable signal:**

Select ANT/CABLE video input source on the TV.\*

**To view basic and premium cable channels:**

Select the ANT/CABLE video input source on the TV.\* Tune the TV to channel 3 or 4 (whichever channel the cable box output is set to). Use the cable box controls to change channels.

**To view the VCR or camcorder video:**

Turn On the VCR or camcorder video. Select VIDEO input source on the TV.\*

\*To select the video input source, press the **INPUT** button on the remote control, see [“Selecting the video input to view” on page 85](#).

---

**NOTE** The unauthorized recording, use, distribution, or revision of television programs, videotapes, DVDs, and other materials is prohibited under the Copyright Laws of the United States and other countries, and may subject you to civil and criminal liability.

---

## Connecting DVD to ColorStream® or VCR to composite video

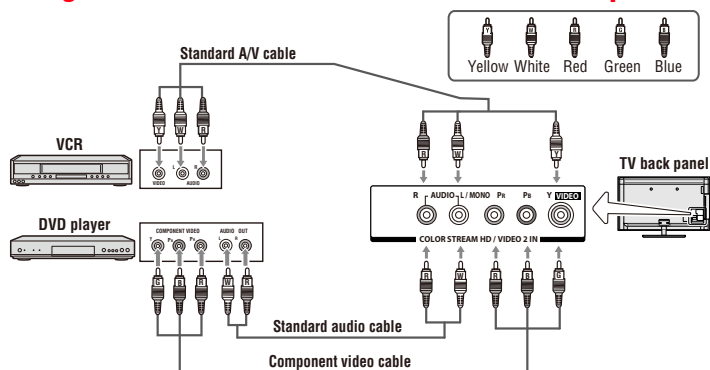

*(Sample Illustration) L9300U Series—Connecting a DVD with ColorStream® or a VCR with composite video*

### Items needed:

- ❖ Coaxial cables
- ❖ Standard AV cables
- ❖ Standard audio cables
- ❖ Composite or component video cables
- ❖ You can connect the component video cables (plus audio cables) from the DVD player or satellite receiver to the **COLOR STREAM HD** terminal in the TV. The **COLOR STREAM HD** terminal can be used to display Progressive (480p, 720p, 1080p) and Interlaced (480i, 1080i) scan systems. If your DVD player or satellite receiver does not have component video, connect a standard A/V cable to the **AUDIO/VIDEO** terminal. If your DVD player has HDMI™ video, see “Connecting an HDMI™ or DVI device to the HDMI™ input” on page 39.

### NOTE

When you use ColorStream® HD or Video, please switch to the appropriate AV mode.

**To view antenna or Cable channels:**

Select the ANT/CABLE video input source on the TV.\*

**To view the DVD player:**

Turn ON the DVD player. Select the ColorStream® HD video input source on the TV.\*

**To view satellite programs using the component video connections:**

Turn ON the satellite receiver. Select the ColorStream® HD video input source on the TV.\*

**To view the VCR or view and record antenna channels:**

Turn ON the VCR. Tune the VCR to the channel you want to watch. Select the VIDEO video input source on the TV.\*

**To record a TV program while watching a DVD:**

Turn ON the VCR. Tune the VCR to the channel to record. Select the ColorStream® HD video input source on the TV\* to view the DVD.

\*To select the video input source, press the **INPUT** button on the remote control, see [“Selecting the video input to view” on page 85](#).

**NOTE**

The unauthorized recording, use, distribution, or revision of television programs, videotapes, DVDs, and other materials is prohibited under the Copyright Laws of the United States and other countries, and may subject you to civil and criminal liability.

## Connecting remote IR devices

### Using the IR blaster OUT terminal

You can use the TV’s IR OUT terminal to remotely operate many infrared remote-controlled devices enclosed in an entertainment center or similar cabinet.

**Items needed:**

- ❖ Dual-wand IR blaster cable (see [“Dual-wand IR blaster cable” on page 30](#))
- ❖ Other cables as required to connect the device(s) to the TV (see [“Overview of cable types” on page 29](#))

See the remote IR blaster setup section (see page 61).

#### To connect the IR blaster cable:

- 1 Locate the infrared sensor on the front of your device. This sensor is marked on some devices. If you are having issues locating the device's infrared sensor, see [“If you cannot locate the device’s infrared sensor:”](#) on page 37.
- 2 Align one of the IR blaster cable’s wands approximately 1 inch away from the infrared sensor on the front of the device and attach it using double-sided mounting tape. If you have a second device, attach the second wand in a similar manner.

**NOTE** If you do not have a second device, coil the second wand with a rubber band and leave it behind the TV.

- 3 Plug the IR blaster cable’s plug into the TV’s IR Blaster Out terminal.

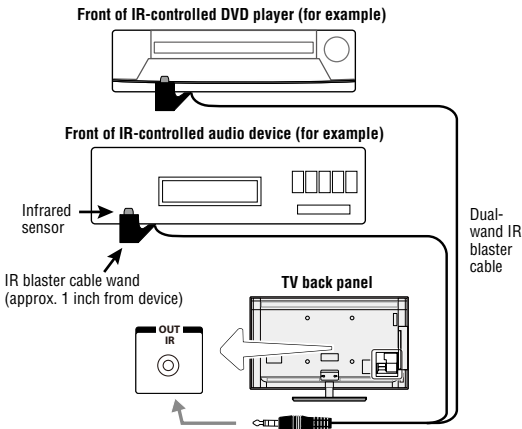

**(Sample Illustration) L9300U Series—Using the IR blaster OUT terminal**



**To control the device(s):**

Point the TV remote control toward the front of the TV and press the button for the desired function. The signal passes from the remote control through the TV to the device via the IR Blaster cable. For more information, see “Setting the IR Blaster” on page 61.

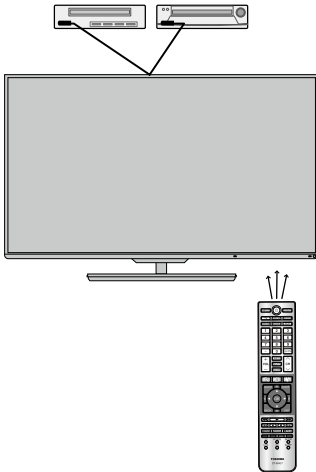

*(Sample Illustration) Controlling the device(s) - remote control*

**NOTE** The IR pass-through feature does not support all IR controlled devices. Satisfactory quality may not be attainable with certain devices.

**If you cannot locate the device’s infrared sensor:**

- 1 Turn off the device.
- 2 Starting at the device’s lower-left corner, place the end of the device’s remote control (with the infrared emitter) so it touches the front of the device. Press the **POWER** button.  
(Do not use the TV’s remote control for this step.)
- 3 If the device turns on, the sensor is located where the remote control touched the device.
- 4 If the device does not turn on, move the remote control slightly to the right and press the **POWER** button again.
- 5 Repeat the previous steps if necessary.

## Connecting a digital audio system

The TV's Digital Audio Out terminal outputs a Dolby® Digital or 2-channel down-mixed PCM (pulse-code modulation) signal for using with an external Dolby® Digital decoder or other external audio systems with optical audio input.

You will need an Optical audio cable (Use an optical audio cable that has the larger “TosLink” connector and not the smaller “mini-optical” connector.)

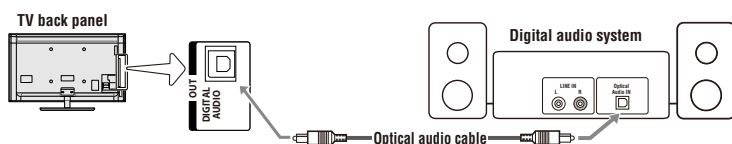

*(Sample Illustration) L9300U Series—Connecting a digital audio system*

Before controlling the audio, see [“Selecting the optical audio output format” on page 123.](#)

**NOTE** Some audio systems may not be compatible with Dolby® Digital bitstream signals. Older audio systems that are not compatible with standard optical out signals may not work properly, creating a high noise level that may damage speakers or headphones. THIS DAMAGE IS NOT COVERED BY YOUR WARRANTY. The DIGITAL AUDIO OUT terminal may not output some digital audio sources because of copy restrictions.

- ❖ The Dolby® Digital format is available in the following situations:
  - When tuned to a digital RF channel
  - When an HDMI™ input is used
  - When network devices are used

## Connecting an HDMI™ or DVI device to the HDMI™ input

The HDMI™ input on your TV receives digital audio and uncompressed digital video from an HDMI™ source device, or uncompressed digital video from a DVI (Digital Visual Interface) source device.

This input is designed to accept HDCP (High-Bandwidth Digital-Content Protection) program material in digital form from EIA/CEA-861-D-compliant[1] consumer electronic devices (such as a set-top box or DVD player with HDMI™ or DVI output).

The HDMI™ input can accept and display VGA, SVGA, XGA, WXGA, SXGA, 480i (60Hz), 480p (60Hz), 720p (60Hz), 1080i (60Hz), 1080p (24Hz/30Hz/60Hz), and 4K video signal formats. For detailed signal specifications, see “HDMI™ signal formats” on page 191 and “4K Video Support formats” on page 192.

The supported Audio formats are Linear PCM and Dolby® Digital, sampling rate 32/44.1/ 48 kHz.

---

**NOTE** To connect a PC to the HDMI™ input, see “Connect a computer to the TV’s HDMI™ terminal” on page 44.  
We cannot guarantee that all 4K video input through HDMI terminals will be displayed.

---

To connect an HDMI™ device, you will need one HDMI™ cable (type A connector) per HDMI™ device:

- ❖ For proper operation, it is recommended that you use an HDMI™ cable with the HDMI™ Logo (**HDMI**).
- ❖ To display an 1080p/60Hz and 4K signal format, you will need a High Speed HDMI™ cable. A conventional HDMI™/DVI cable may not work properly.
- ❖ HDMI™ cables transfer both video and audio. Separate analog audio cables are not required (see illustration).

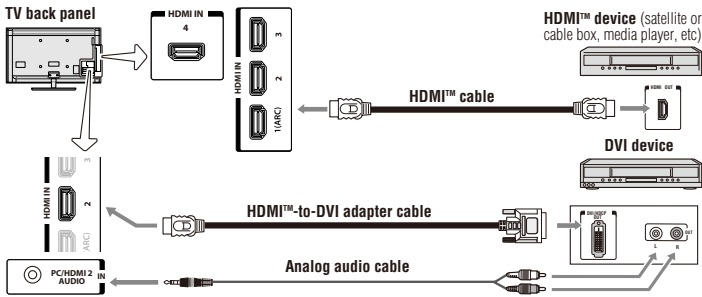

**(Sample Illustration) L9300U Series—Connecting an HDMI™ or DVI™ device to the HDMI™ Input**

**To view the HDMI™ device video:**

Select **HDMI 1**, **HDMI 2**, **HDMI 3** or **HDMI 4** video input source on the TV. (Press the **INPUT** button on the remote control. For more information, see “[Selecting the video input to view](#)” on page 85.

**To connect a DVI device, you will need:**

- ❖ HDMI™ to DVI adapter cable  
For proper operation, the length of an HDMI™ to DVI adapter cable should not exceed 9.8 ft (3m). The recommended length is 6.6 ft (2m).
- ❖ 3.5mm Stereo to RCA Y-cable  
An HDMI™ to DVI adapter cable transfers video only. Separate analog audio cables are required (see illustration).

**NOTE**

To ensure that the HDMI™ or DVI device is reset properly:

- ❖ When turning on your electronic components, turn on the TV first, and then the HDMI™ or DVI device.
- ❖ When turning off your electronic components, turn off the HDMI™ or DVI device first, and then the TV.

**NOTE**

[1] EIA/CEA-861-D compliance covers the transmission of uncompressed digital video with high-bandwidth digital content protection, which is being standardized for reception of high definition video signals. Because this is an evolving technology, it is possible that some devices may not operate properly with the TV.

## Using the TV remote and HDMI™ CEC Control to control other devices

To control the basic functions of connected audio/video devices using the TV's remote control, connect an HDMI™ CEC compatible audio system or playback device. The HDMI™ CEC Control feature uses CEC technology as regulated by the HDMI™ standard.

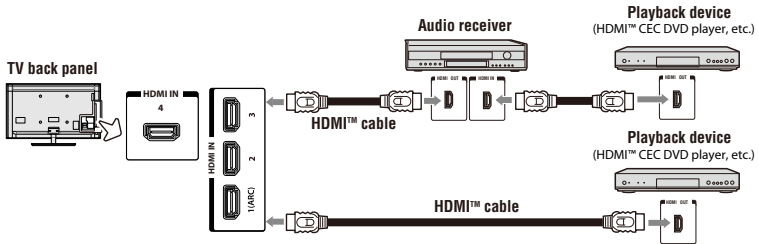

### *(Sample Illustration) L9300U Series—Connecting an HDMI™ CEC compatible audio system and playback device*

To connect an audio system and playback devices, you will need HDMI™ cables, see “[HDMI™ cable \(with HDMI Logo\)](#)” on page 30.

- NOTE**
- ❖ If several devices are connected, HDMI™ CEC Control feature may not operate properly, see “[HDMI™ CEC Control input source selection](#)” on page 97.  
For proper operation, it is recommended that you use HDMI™ cables with the HDMI™ Logo (**HDMI**).
  - ❖ HDMI™ CEC devices can be controlled by TV remote only when it is the TV mode.

Before controlling the devices:

- ❖ For an explanation of setup and operations, see “[Other HDMI™ CEC Control functions](#)” on page 98.
- ❖ Configure the connected devices. See each device’s operation manual.

- NOTE** This feature is limited to models incorporating Toshiba’s HDMI™ CEC Control feature. However, Toshiba is not liable for those operations. See the individual instruction manuals for compatibility information.

When using an external AV amplifier the picture and sound may not be properly synchronized. In this case, adjust the delay time of the sound on the AV amplifier.

**NOTE** The control range of the delay time differs according to the device you use.

## Connecting an HDMI™ audio system

If your HDMI™ audio system supports ARC, audio from the TV can be sent to the audio system via an existing HDMI™ cable.

You will need an HDMI™ cable.

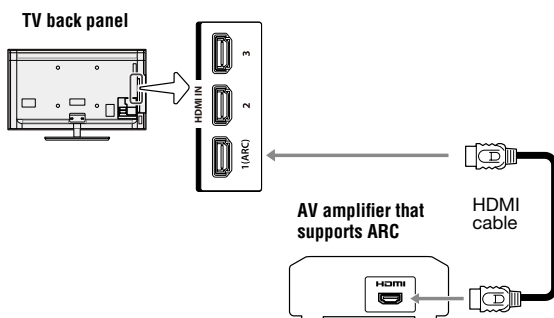

*(Sample Illustration) L9300U Series— Connecting to HDMI™ ARC*

### HDMI™ ARC (Audio Return Channel) feature

This feature enables the audio signal of the TV to be sent to an audio system via the HDMI™ cable. It will not be necessary to connect a cable from the audio output of the TV to the audio input of the audio system to reproduce the audio received from the tuner of the TV through the audio system.

## Connecting a computer

With either the PC IN or HDMI™ connection, you can view your computer's display on the TV and hear the sound from the TV's speakers.

### Connecting a computer to the TV's PC IN terminal

When connecting a computer to the PC IN terminal on the TV, use an analog RGB (15-pin) computer cable and a PC audio cable. For more information, see [“Overview of cable types” on page 29](#).

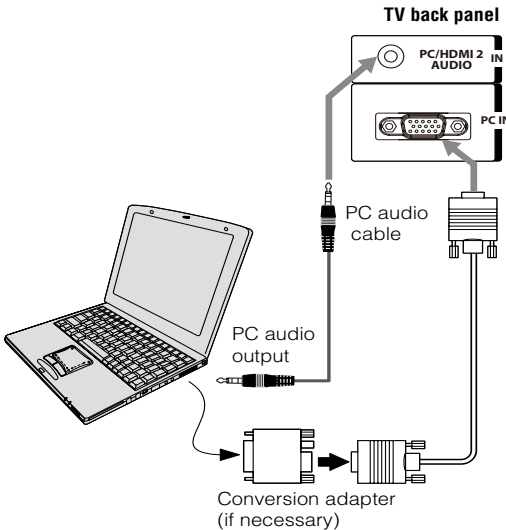

#### *(Sample Illustration) L9300U Series—Connecting to a computer through analog RGB cable*

To use a computer, set the monitor output resolution on the computer before connecting it to the TV. The supported signal formats are VGA, SVGA, XGA, WXGA and SXGA. For detailed signal specifications, see [“Acceptable signal formats for PC IN, and HDMI™, and 3D” on page 190](#).

Other formats or non-standard signals will not be displayed correctly.

To display the optimum picture, use the computer setting feature, see [“Using your computer with the TV” on page 99](#).

**NOTE** ❖ The PC audio input terminal on the TV is shared with the HDMI 2 terminal. For configuration information, see [“Setting the computer audio” on page 100](#).

- ❖ Some computer models cannot be connected to this TV.
- ❖ If the computer has a compatible mini D-sub15-pin terminal, an adapter is not required.
- ❖ Depending on the content's title and the computer's specifications, some scenes may be skipped or you may not be able to pause during multi-angle scenes.

Signal names for mini D-sub 15-pin connector:

Pin No.:	Signal Name:	Pin No.:	Signal Name:	Pin No.:	Signal Name:
1	R	6	Ground	11	NC
2	G	7	Ground	12	SDA
3	B	8	Ground	13	H-sync
4	NC*	9	5V	14	V-sync
5	Ground	10	Ground	15	SCL

\*NC=Not connected

### Connect a computer to the TV's HDMI™ terminal

When connecting a computer with a DVI port to the HDMI™ terminal on the TV, use an HDMI™ to DVI adapter cable and analog audio cables.

When connecting a computer with an HDMI™ port, use an HDMI™ cable (type A connector). Separate analog audio cables may not be necessary, depending on computer hardware and setup.

For more information, see [“Overview of cable types”](#) on page 29.

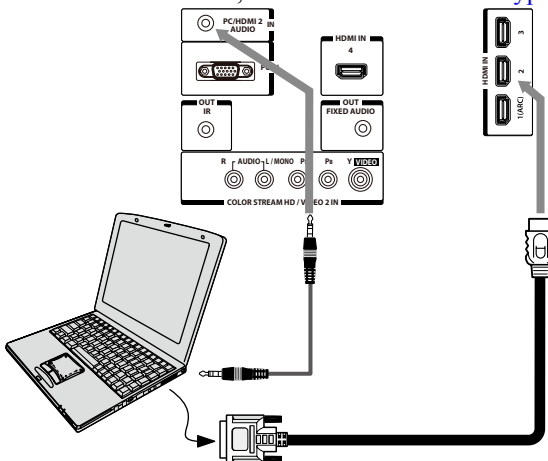

*(Sample Illustration) L9300U Series—Connecting to an HDMI™ terminal*



The supported signal formats are VGA, SVGA, XGA, WXGA, SXGA, 480i (60Hz), 480p (60Hz), 720p (60Hz), 1080i (60Hz), 1080p (24Hz/30Hz/60Hz) and 4K formats. For signal specifications, see “Acceptable signal formats for PC IN, and HDMI™, and 3D” on page 190.

- NOTE**
- ❖ The edges of the picture may be hidden.
  - ❖ If receiving a 480i (HDMI), 480p (HDMI), 720p, 1080i, or 1080p signal program, Native mode scales the video to display the entire picture within the borders of the screen (i.e. no overscanning).

## Connecting to a home network

The LAN port allows your Toshiba TV to connect to your home network. You can use this home network to access photos, movies, and music files that are stored on a connected media server and play them on your TV.

## Connecting the TV directly to a computer without an Internet connection

You will need a Crossover LAN cable.

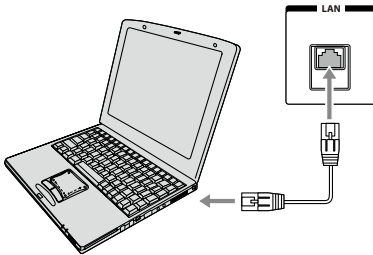

*(Sample Illustration) L9300U Series—Connecting a computer without Internet connection*

**Connecting the TV to a home network without an Internet connection****Items needed:**

- ❖ Standard LAN cables
- ❖ Router with a hub

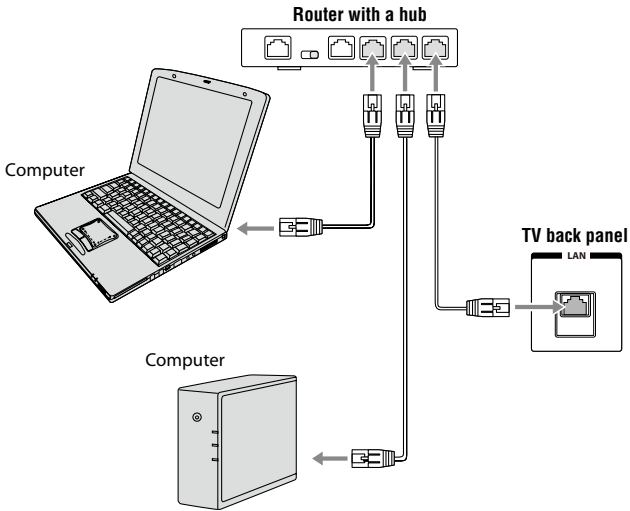

*(Sample Illustration) L9300U Series—Connecting a network without Internet connection*

## Connecting the TV to a home network with an Internet connection - wired

### Items needed:

- ❖ Coaxial or telephone cable (depending on your modem type)
- ❖ Standard LAN cables
- ❖ Router with Hub
- ❖ Modem (DSL or cable)

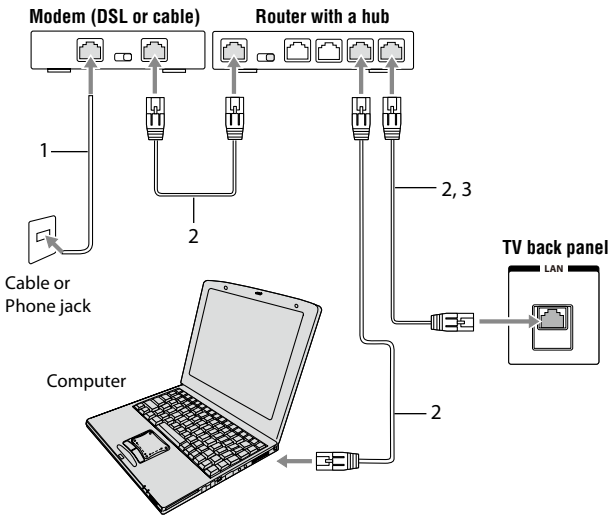

### (Sample Illustration) L9300U Series—Connecting with Internet connection - wired

Item:	Description:
1	Coaxial or telephone cable (depending on your modem type)
2	Standard LAN cable
3	Do NOT connect a phone jack directly to the TV's LAN port.

## Connecting the TV to a home network with an Internet connection - wireless

### Items needed:

- ❖ Coaxial or telephone cable (depending on your modem type)
- ❖ Standard LAN cables
- ❖ Wireless LAN access point or wireless router
- ❖ Modem (DSL or cable)

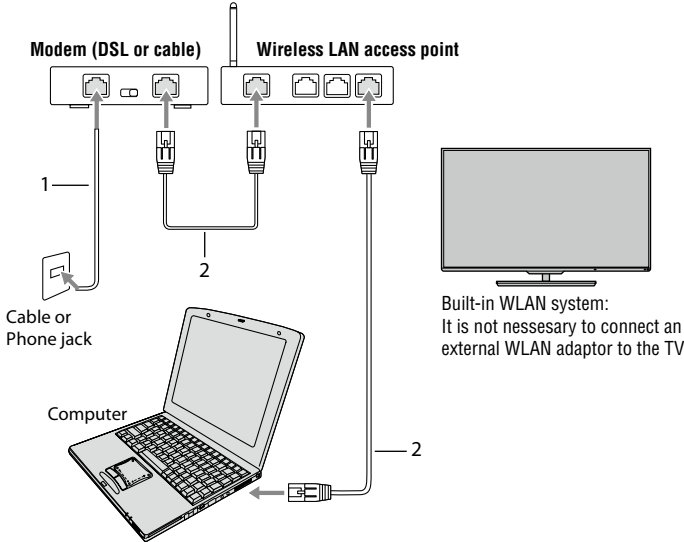

### *(Sample Illustration) L9300U Series—Connecting with Internet connection - wireless*

Item:	Description:
1	Coaxial or telephone cable (depending on your modem type)
2	Standard LAN cable

The transmission speed over the wireless LAN and the distance over which wireless LAN can reach may vary depending on surrounding electromagnetic environment, obstacles, access point design and configuration, and client design and software/hardware configurations. The actual transmission speed will be lower than the theoretical maximum speed.

**NOTE** The Built-in WLAN Adapter is based on the IEEE 802.11n specification and may not be fully compatible with, or support some features (e.g., security)

---

**Connecting the AC cord on your TV (for 84L9300 Series)**

---

of certain Wi-Fi equipment that are based on the draft version of IEEE 802.11n.

---

**Connecting the AC cord on your TV (for 84L9300U Series)**

- 1 Place the ferrite core attachment around the AC cord near the connection end.

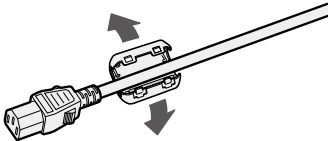

*(Sample Illustration) Ferrite core attachment*

- 2 Snap the ferrite core attachment closed, around the AC cord.

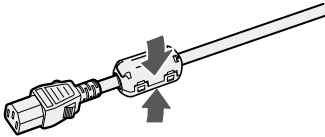

*(Sample Illustration) Ferrite core attachment - closed*

**⚠ WARNING**

Handling the cord on this product will expose you to lead, a chemical known to the State of California to cause cancer, and birth defects or other reproductive harm.

**Wash hands after handling.**

---

- 3 Make sure to connect the AC cord plug into the AC IN terminal firmly.

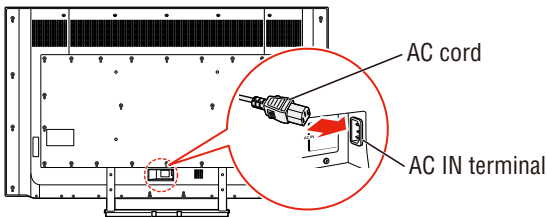

# Chapter 3

## Using the Remote Control

---

### Controlling other devices

The TV's remote control can operate other devices as described in [“Setting the IR Blaster”](#) on page 61.

### Installing batteries

**To install batteries:**

- 1 Slide back and pull up to open the cover.

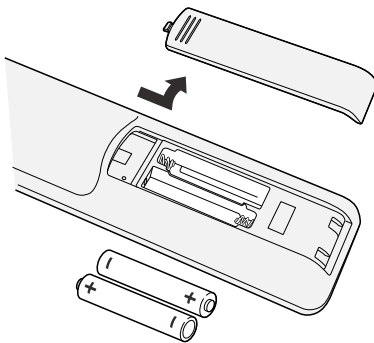

*(Sample Illustration) Removing the battery cover*

- 2 Install two AAA size batteries.

**NOTE** Use carbon zinc batteries or alkaline batteries.

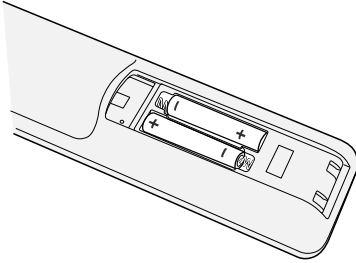

*(Sample Illustration) installing the batteries*

- 3 Slide on the cover.

**CAUTION** Do not expose batteries to excessive heat such as sunshine, fire, etc.

- NOTE**
- ❖ Dispose of batteries in a designated disposal area.
  - ❖ Always consider the environment when disposing of batteries.
  - ❖ Always follow applicable laws and regulations.
  - ❖ If the remote does not operate correctly, or if the operating range is reduced, replace the batteries.
  - ❖ Always replace both batteries with new ones. Never mix battery types or use new and used batteries together.
  - ❖ Always remove batteries from the remote if they are dead or if the remote control is not to be used for an extended period of time. This prevents battery acid from leaking into the battery compartment.

**Remote control effective range**

- 1 For optimum performance, aim the remote control directly at the TV and make sure there are no obstructions between the remote control and the TV.

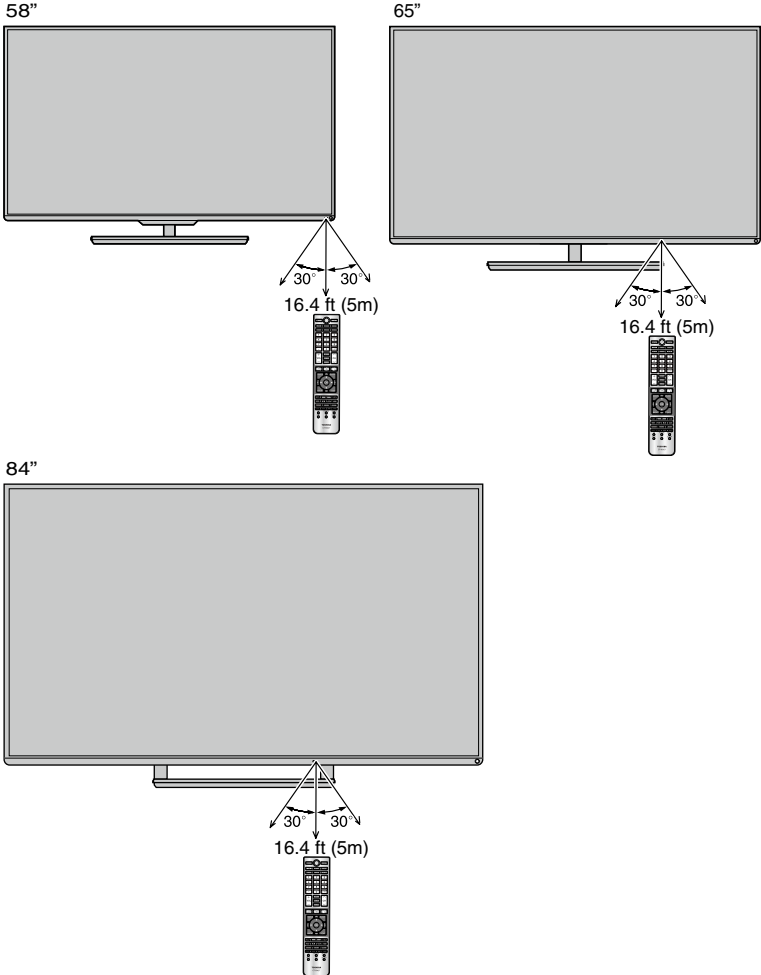

*(Sample Illustration) Remote control effective range*



## Learning about the remote control

Only the buttons used to operate the TV are described in this section.  
For the HDMI™ CEC Control functions, see “Using HDMI™ CEC Control” on page 95.

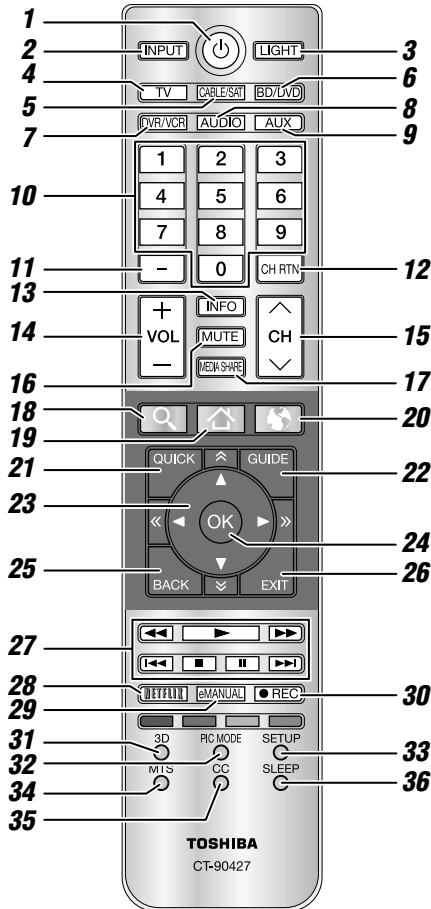

*(Sample Illustration) Remote control overview*

**NOTE** The error message “Not Available” may appear if you press a button for a function that is not available.

Item:	Description:	Function:	Item:	Description:	Function:
1	POWER button	Turns the TV On and Off. When the TV is on, the power LED indicator on the TV front glows green.	21	QUICK button	Launches the Quick menu.
2	INPUT button	Selects the video input source.	22	GUIDE button	Launches the MediaGuide application on-screen.
3	Light button	Illuminates the keypad for five seconds.	23	(▲/▼/◀/▶)	Selects or adjusts programming buttons menu when a menu is on-screen.
4	TV button			(⤴/⤵/◀◀/▶▶)	Scrolls the page up, down, left, and right.
5	Cable/Satellite button	Sets the remote control mode to control the device: <b>TV, CABLE/ SAT, BD/DVD, DVR/VCR, AUDIO, or AUX.</b>	24	OK button	Selects the highlighted items on the screen.
6	BD/DVD button		25	BACK button	Returns to the previous screen.
7	DVR/VCR button		26	EXIT button	Closes on-screen menus.
8	Audio button		27	(▶/◀◀▶▶/◀◀▶▶/▶▶/■/  )	▶ : PLAY button ◀◀ : REWIND button ▶▶ : FAST FORWARD button ◀◀◀ : SKIP-BACK button ▶▶▶ : SKIP-FORWARD button ■ : STOP button    : PAUSE button
9	Auxillary button		28	NETFLIX button	Launches the Netflix® application on-screen.
10	Channel Number buttons (0-9)	Directly tunes channels.	29	eMANUAL button	Launches the eManual application on-screen. Internet connection required.
11	(-) button	Enters 2-part channel numbers.	30	REC button	Used for TV, Cable/Sat, BD/ DVD, Aux devices
12	CH RTN button	Returns to the last viewed channel or source.	31	3D button	Accesses the 3D options.
13	INFO button	Displays TV status information as well as program details, when available.	32	PIC MODE button	Selects the picture mode.
14	VOL (+ / -) buttons	Adjusts the volume level.	33	SETUP button	Accesses the main TV menu system.
15	CH (▲/▼) buttons	Cycles through programmed channels.	34	MTS button	Accesses the MTS options.
16	MUTE button	Reduces or turns off the sound.	35	CC button	Accesses the closed-caption feature.
17	MEDIA SHARE button	Accesses the MediaShare Service.	36	SLEEP button	Accesses the sleep timer.
18	SEARCH button	Accesses the SearchAll function.			
19	HOME button	Accesses the Cloud TV Portal pages.			
20	INTERNET button	Launches the web browser on-screen.			

# Chapter 4

## Initial Setup and Menu

---

### Initial setup

When you first turn on or reset the TV, the **Menu Language** screen appears.

---

**NOTE**

- ❖ You can stop initial setup by pressing the **EXIT** button. However, if you do not finish **Channel Tuning** setting, the **Quick Setup** screen will appear every time you turn on your TV.
  - ❖ The **EXIT** button does not work until after you have set the **Store/Home Mode** setting.
-

## Performing the initial setup

### 1 Menu Language

Select a language and press the **OK** button.



*(Sample Illustration) Selecting Menu Language*

- ❖ Quick Setup screen will appear.

### About the Quick Setup screen

The Quick Setup screen is divided into the progress window and setup window.

- ❖ The progress window shows the **Quick Setup** items being set up. The finished items are dark, and the finish mark (✓) appears by them.
- ❖ The setup window shows the settings.

#### Progress window

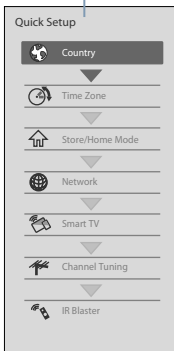

#### Setup window



**Next**

*(Sample Illustration) Quick Setup and Welcome window*

### Basic Operations in Quick Setup

- 1 Use the the ▲/▼ (arrow) buttons to select an item on the setup window, and press the **OK** button.
  - 2 Select **Next** and press the **OK** button.  
The next item will appear.
- ❖ Some items have sub menus, which appear when the **OK** button is pressed.  
Use the ▲/▼ (arrow) buttons to select an item on the sub menu, and press the **OK** button.

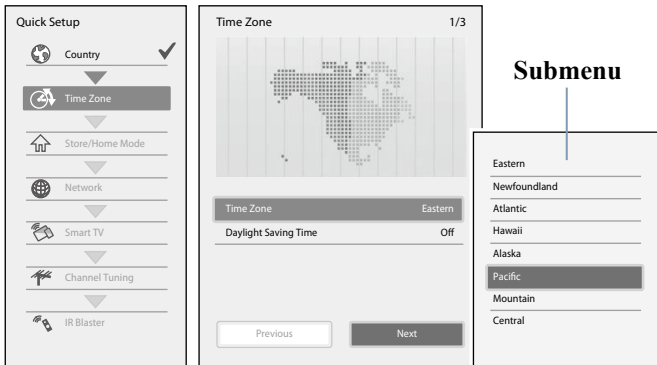

### *(Sample Illustration) Quick Setup and Welcome window*

- ❖ Alternatively, press the ► (arrow) button to show the submenu.
- ❖ When the ◀ (arrow) button is pressed on the setup window, the focus moves to the progress window. On the progress window, you can select a finished item using the the ▲/▼ (arrow) buttons.

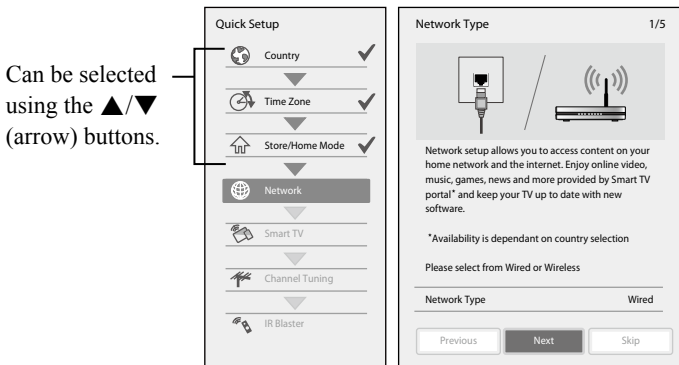

### *(Sample Illustration) Quick Setup and Welcome window*

Repeat the above procedure to continue setting up.

## Performing the Quick Setup

- 1 Country**  
Select a country then press the **OK** button.
- 2 Time Zone**  
Select **Time Zone**, and select a time zone from the submenu.  
Select **Daylight Saving Time**, and select **On** or **Off** from the submenu.  
Select **Next**.
- 3 Store / Home Mode**  
Select **Store / Home Mode**, and select **Home** or **Store** from the submenu.  
To use at home, select **Home**.  
Select **Next**.

---

**NOTE** Store Mode is only available if the TV is set to Store Mode at initial setup. This option is hidden in the Home Mode.

---

- 4 Network**
  - ❖ To make full use of the functions, it is recommended that you set up a network and connect to the Internet.

To start the Network Setup, select **Next** on the screen or to skip the setup, select **Skip**. If you skip this setup, you can setup the Network at any time through the **Network** menu.

### Network setup

- 1** Select **Network Type**, and select **Wired** or **Wireless** from the sub menu.  
Select **Next**.
  - ❖ If you select **Wired**, proceed to the Network Connection Test (Step 3). If you selected **Wireless**, please proceed to the following step.
- 2** Select **Wireless Setup**, and select **Easy Setup**, **Assisted Setup**, or **Manual Setup** from the sub menu.  
Select **Next**.

**NOTE**

- ❖ **Easy Setup.** If your Access Point (AP) supports WPS, this method can be used. WPS is a standard designed to simplify the connection of wireless LAN equipment and the setup of network security features.
- ❖ **Assisted Setup** (setup using the AP's notification information). The Network Name, Authentication, and Encryption are decided based on information from the AP. You need to manually set the Security Key for this method.
- ❖ **Manual Setup** (to input all settings manually).

- 3 Once your wired or wireless network has been configured, perform a **Network Connection Test**.  
A network connection test screen will appear while the test is being performed. If the test was successful, the successful connection screen will appear.  
If the network connection test failed, the connection failure screen will appear.  
For more information, see [“Setting up the Network” on page 129](#).
- 4 Press the **OK** button.  
When the network can be accessed, **Software Upgrade** availability check starts automatically. When **Software Upgrade** is completed, proceed to the next step.

**NOTE**

In order to secure your home network, it is strongly recommended that you use a wireless access point with encryption.

**5 Smart TV**

Select **TV Power On Control**, and select **Enabled** or **Disabled** from the sub menu.  
If you select **Enabled**, you can turn on or off the television from the companion devices such as Tablet or Smartphone.  
Select **Next**.

- ❖ When **Enabled** is selected, perform the following procedure:
  - 1 Select **Enable Control**, and select **On** or **Off** from the sub menu.  
When **On** is selected, you can control the TV power and off using companion devices such as a tablet or smartphone.

- 2 Select **Media Renderer**, and select **On** or **Off** from the sub menu.  
When **On** is selected, the Media Renderer function can be used.
- 3 Select **Next**.

## 6 Channel Tuning

Select **Antenna** or **Cable**, and select **Start Scan**.

Auto Tuning will start.

While scanning is in progress, the **Auto Tuning Progress** screen appears.

**NOTE** If you do not want to scan channels, you do not need to make a selection for **Channel Tuning**. Select **Skip** to skip this step.

**NOTE** If you want to stop scanning, pressing the **EXIT** button while scanning is in process.

While scanning is in progress, the **Auto Tuning Progress** screen appears.

After scanning is complete, the auto tuning results screen (such as the one below) will appear.

Auto Tuning (Antenna)		
Antenna Channels Found: 13		
Ch.	Type	RF Ch.
101 - 201		0
201	ATV	11
101 - 201	DTV	22
201	ATV	33
101 - 201	DTV	44
201	ATV	55
101 - 201	DTV	66
201	ATV	77

*(Sample Illustration) Auto Tuning Results screen*

Press the **OK** button.

**NOTE** The encrypted channels are not listed on the auto tuning result screen.



If some channels are not found after scanning:

- ❖ Check the antenna/cable connections, and scan again.
- ❖ Connect the TV to the antenna or cable box directly and scan again.
  - 1 Press the **SETUP** button. Select **Installation** > **Quick Setup** and press the **OK** button.

A confirmation message appears.
  - 2 Select **Yes** then press the **OK** button.
  - 3 Repeat setup to step **6** (Channel Tuning).
    - ❖ If you selected **Antenna** previously, selecting **Cable** might be effective.
    - ❖ If you selected **Cable** previously, selecting **Antenna** might be effective.
  - 4 Select **Start Scan**.
- 7 **IR Blaster**

Select **Next** or **Skip**.

  - ❖ To start the IR Blaster setup, select **Next** on the screen, or to skip the setup, select **Skip**. If you skip this setup, you can setup the IR Blaster at any time through the **Installation** > **IR Blaster Setup** menu.

## NOTE

The IR Blaster may not work with some devices, and it may not control certain features on your external devices.

## Setting the IR Blaster

### IR Blaster Setup

- 1 Select **Add** on the screen.

**Device Type** screen will appear.

### Device Type

- 1 Select **Device Type**, and use the ◀▶ (arrow) buttons to select a device type from the following:
  - ❖ Cable Box
  - ❖ Satellite Box
  - ❖ VCR
  - ❖ Blu-ray, DVD Player
  - ❖ Receiver, Misc Audio
  - ❖ Amplifier

- ❖ CD Player
  - ❖ Video Accessory
- 2 Press the ▼ button then press the **GREEN** button.  
The **Brand** screen will appear.
  - 3 Use the ▲/▼ (arrow) buttons to select the brand name then press the **OK** button.
    - ❖ Select a field and press the **OK** button to show the software keyboard. Enter the first few characters of the brand name and press the **Green** button. The brand name starting with the entered characters will appear on the **Brand** screen.
  - 4 Press the **OK** button.  
**Model Name** screen will appear.

**Model Name**

- 1 Press the **GREEN** button.  
The **Model Name** screen will appear.
- 2 Use the ▲/▼ (arrow) buttons to select the model name then press the **OK** button.
  - ❖ Select a field and press the **OK** button to show the software keyboard. Enter the first few characters of the model name and press the **GREEN** button. The model name starting with the entered characters will appear on the **Model Name** screen.
- 3 Press the ▼ (arrow) button to select **Code Set** then press the **OK** button.  
**Code Set** screen will appear.

**Code Set**

- 1 Use the ◀▶ (arrow) buttons to select the code.
  - ❖ After the code is selected, press the **RED** button to show the **Test** screen. The test will start automatically.

---

**NOTE**

If a model has more than one Code Set, a message will appear stating "This model has more than one Code Set. Please select and test your preferred Code Set." You will need to choose a code set using the ▲/▼ (arrow) buttons and perform the Test option to ensure the correct Code Set has been selected.

---

- 2 Press the **OK** button.  
**Input & Mode Key** screen will appear.

### Input & Mode Key

- 1 Use the ◀▶ (arrow) buttons to select the TV input to which the IR device is connected.
  - ❖ --- (Appears when **Device Type** is set to **Receiver, Misc Audio** or **Amplifier**)
  - ❖ ANT/CABLE
  - ❖ Video1
  - ❖ Video2
  - ❖ ColorStream HD
  - ❖ HDMI 1
  - ❖ HDMI 2
  - ❖ HDMI 3
  - ❖ HDMI 4
  - ❖ PC
- 2 Press the ▼ (arrow) button.
- 3 Use the ◀▶ (arrow) buttons to select device mode key.
  - ❖ CABLE/SAT
  - ❖ BD/DVD
  - ❖ DVR/VCR
  - ❖ AUDIO
  - ❖ AUX
- 4 Press the **OK** button.
  - ❖ When **Device Type** is set to **Receiver, Misc Audio** or **Amplifier**, the **Volume Control** screen will appear.
  - ❖ When **Device Type** is set to **Cable Box, Satellite Box, Blu-ray** or **DVD Player**, the Guide Preferences screen will appear.
  - ❖ When **Device Type** is set to **VCR, CD Player** or **Video Accessory**, press the **OK** button on the IR Blaster Setup complete screen.  
**Support Information** screen will appear.

**Volume Control**

- 1 Use the ◀/▶ (arrow) buttons to set up the Volume control to select:
  - ❖ **TV** (this is the default)
  - ❖ **External**  
The **Volume + or -** and **MUTE** buttons will control the External equipment through the IR blaster.
- 2 Press the **OK** button.  
Press the **OK** button on the IR Blaster Setup complete screen. **Support Information** screen will appear.

**Guide Preferences**

- 1 Use the ◀/▶ (arrow) buttons to set up the Guide preferences to select:
    - ❖ **TV MediaGuide**
    - ❖ **External Device Guide**
  - 2 Press the ▼ (arrow) button to select **Interval Time**.
    - ❖ 0.125 sec
    - ❖ 0.25 sec
    - ❖ 0.375 sec
    - ❖ 0.5 sec
    - ❖ 0.625 sec
    - ❖ 0.75 sec
    - ❖ 0.875 sec
    - ❖ 1 sec
  - ❖ After the interval time is selected, press the **RED** button to show the **Test** screen. The test will start automatically.
  - 3 Press the **OK** button.  
Press the **OK** button on the IR Blaster Setup complete screen. **Support Information** screen will appear.
- 8 Support Information**  
Read through the information, and press the **OK** button.
- ❖ The initial setup is completed.

---

**NOTE**

Refer to this information if there is a problem and you need to contact Customer Support. To find help, the following operation can be performed at any time. **SETUP** button > **Get Help** > **System Information** > **OK** button.

---

## Navigating the menu system

- ❖ To open the menu system, press the **SETUP** button on the remote control.

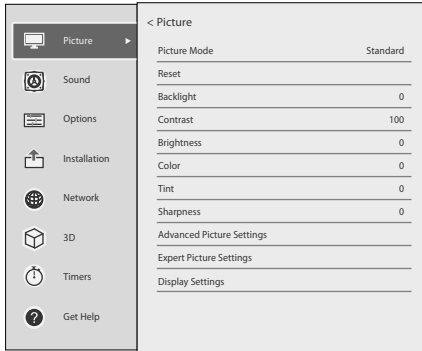

### *(Sample Illustration) Main menu*

- ❖ When a menu is open, press the ▲/▼/◀/▶ (arrow) buttons on the remote control to move in the corresponding direction. To show the setup items or sub menus, press the ► (arrow) button (or the **OK** button). To select a highlighted item or save your menu settings, press the **OK** button. (A highlighted menu item appears in a different color in the menu.)
- ❖ All menus close automatically if no selection is made within approximately 60 seconds.
- ❖ To close a menu instantly, press the **EXIT** button.

## Quick Menu

Quick menu helps you access some options more quickly.

Press the **QUICK** button to display the Quick menu and press the ▲/▼ (arrow) buttons to select an option.

---

**NOTE** Quick menu items differ depending on the current mode.

---

<i>Quick Menu</i>	<i>Item Page</i>
Intel® WiDi	<a href="#">page 140</a>
Picture Mode	<a href="#">page 112</a>
Picture Size	<a href="#">page 106</a>
3D Settings	<a href="#">page 78</a>
Sleep Timer	<a href="#">page 101</a>
HDMI CEC Device Control	<a href="#">page 96</a>
Speakers	<a href="#">page 123</a>
Device Information	<a href="#">page 160</a>
Wireless Information	<a href="#">page 133</a>
Interval Time	<a href="#">page 169</a>
Repeat	<a href="#">page 162</a>
Sound	<a href="#">page 122</a>
Picture	<a href="#">page 112</a>
Background Music	<a href="#">page 169</a>
Play List	<a href="#">page 162</a>

# Chapter 5

## Setting up your TV

---

### How to navigate the menu

- ❖ Press the **SETUP** button. Select **Installation**, Main menu, Submenu, and then press the **OK** or **EXIT** button.

### Changing initial settings

#### From Quick Setup:

- 1 Press the **SETUP** button.
- 2 Select **Installation** > **Quick Setup**, and press the **OK** button.  
A confirmation message appears.
- 3 Press the ◀/▶ (arrow) buttons to select **Yes**.
- 4 Press the **OK** button.  
To change settings, see “Initial setup” on page 55.

### Individual settings

#### Menu Language

You can choose from three different menu language settings (English, Français, and Español). The TV displays menus and messages in your preferred language.

- 1 Press the **SETUP** button.
- 2 Select **Installation** > **Menu Language** and press the **OK** button.
- 3 Press the ▲/▼ (arrow) buttons to select your preferred language.
- 4 Press the **OK** button.

## Country

You can select the country in which you reside.

- 1 Press the **SETUP** button.
- 2 Select **Installation** > **Country** and press the **OK** button.
- 3 Press the **▲/▼** (arrow) buttons to select the country.
- 4 Press the **OK** button.

## Time Zone

This setting allows you to specify the correct time zone for your region.

- 1 Press the **SETUP** button.
- 2 Select **Installation** > **Time Zone** and press the **OK** button.
- 3 Press the **▲/▼** (arrow) buttons to select your time zone.
- 4 Press the **OK** button.

## Daylight Saving Time

- 1 Press the **SETUP** button.
- 2 Select **Installation** > **Daylight Saving Time** and press the **OK** button.
- 3 Press the **▲/▼** (arrow) buttons to select **On** or **Off**.
- 4 Press the **OK** button.

## Store / Home Mode

You can select **Store** or **Home** to designate the TV location. Select **Home** for normal home use.

- 1 Press the **SETUP** button.
- 2 Select **Installation** > **Store / Home Mode** and press the **OK** button.
- 3 Press the **▲/▼** (arrow) buttons to select **Home** or **Store**.
- 4 Press the **OK** button.

---

**NOTE** Store Mode is only available if the TV is set to Store Mode at initial setup.

---

## ANT/CABLE In

This setting configures the antenna input source for the ANT/CABLE terminal.

- 1 Press the **SETUP** button.
- 2 Select **Installation** > **Channel Tuning** > **ANT/CABLE In** and press the **OK** button.



**Storing channels in memory (optional)**

- 3 Press the ▲/▼ (arrow) buttons to select **Antenna** or **Cable**.
- 4 Press the **OK** button.
- 5 Select **Start Scan**.  
After scanning is complete, the auto tuning results screen will appear.
- 6 Press the **OK** or **EXIT** button.

**Storing channels in memory (optional)**

To make sure your TV stops only on the channels you want when you press the **CH** ▲/▼ buttons on the remote control or the control panel, store those channels in the TV's memory.

**Auto Tuning**

**NOTE** You must set up the antenna/cable input source first. See "Initial setup" on page 55.

You can set up the TV to detect all active channels in your area and store them in its memory. Then you can manually store or skip individual channels from memory.

<b>Option:</b>	<b>Description:</b>
Cable	Note: If you select Cable, auto tuning deletes previously stored channels from memory. This setup requires some time, but you do not need to repeat the setup unless your cable TV service's lineup changes significantly.
Antenna	To skip an antenna source channel and remove it from memory, set the channel to be skipped. See "Skipping channels" on page 70.

**NOTE** To tune to channels not stored in memory, use buttons 0–9 and the **DASH** button on the remote control.

- 1 Press the **SETUP** button.
- 2 Select **Installation > Channel Tuning > Auto Tuning**, and then press the **OK** button.  
A confirmation screen appears.
- 3 Press the **OK** button to start Auto Tuning or press the **EXIT** button to abort.  
The TV cycles through the channels and stores all active channels in memory.
- 4 To view the programmed channels, press the **CH** ▲/▼ buttons.

### Manual Tuning

After storing channels in memory, you can manually enter channels if the channel number is known.

- 1 Press the **SETUP** button.
- 2 Select **Installation > Channel Tuning > Manual Tuning**, and then press the **OK** button.
- 3 Use buttons 0–9 on the remote control to enter the channel number (for example, 56).
- 4 Press the **OK** button.
- 5 Press the **OK** button again to begin Manual Tuning.  
The channels found are listed at the bottom of the screen.

<i>Option:</i>	<i>Description:</i>
ATV	Analog channel
DTV	Digital channel

### Skipping channels

To prevent a channel from being viewed, you can set it to be skipped.

- 1 Press the **SETUP** button.
- 2 Select **Options > Channel Options** and then press the **OK** button.  
The list of channels appears.

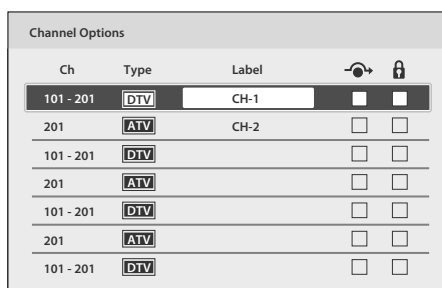

#### *(Sample Image) Channel options*

- 3 Press the / (arrow) buttons to select the Skip column () and press the / (arrow) buttons to select a channel to skip.
- 4 Press the **OK** button.  
The box is selected.
- 5 To clear the selection, press the **OK** button.

**NOTE** You cannot tune skipped channels using the **CH**  $\wedge$  or  $\vee$  buttons. Use buttons 0–9 and the **DASH** button on the remote control.

## Skipping video inputs

You can set video inputs to be skipped when selecting inputs in the Input selection screen.

### To turn on skip

- 1 Press the **SETUP** button.
- 2 Select **Options** > **Input Option** > **Input Labeling** and press the **OK** button.
- 3 Press the  $\blacktriangle$ / $\blacktriangledown$  (arrow) buttons to select the item you wish to skip. Then press the **RED** button to turn on **Skip**.

### To turn off skip

Press the **RED** button again to turn off **Skip**.

## Labeling analog TV channels

- 1 Press the **SETUP** button.
- 2 Select **Options** > **Channel Options**, and then press the **OK** button. The list of channels appears.

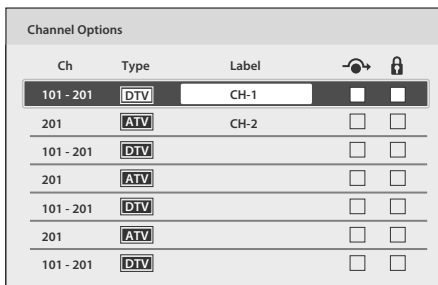

Ch	Type	Label	$\blacktriangle$ / $\blacktriangledown$	Lock
101 - 201	DTV	CH-1	<input checked="" type="checkbox"/>	<input type="checkbox"/>
201	ATV	CH-2	<input type="checkbox"/>	<input type="checkbox"/>
101 - 201	DTV		<input type="checkbox"/>	<input type="checkbox"/>
201	ATV		<input type="checkbox"/>	<input type="checkbox"/>
101 - 201	DTV		<input type="checkbox"/>	<input type="checkbox"/>
201	ATV		<input type="checkbox"/>	<input type="checkbox"/>
101 - 201	DTV		<input type="checkbox"/>	<input type="checkbox"/>

### *(Sample Image) Channel options*

- 3 Press the  $\blacktriangle$ / $\blacktriangledown$  (arrow) buttons to select a channel to label.
- 4 Press the **OK** button.  
The Software Keyboard window appears.
- 5 Input a name using the Software Keyboard, see [“Using the software keyboard” on page 137](#).
- 6 Press the **GREEN** button.

## Labeling video inputs

The input labels are shown in the input selector and banner displays. You can label video inputs according to the devices you have connected to the TV.

- 1 Press the **SETUP** button.
- 2 Select **Options** > **Input Option** > **Input Labeling** and press the **OK** button.
- 3 Press the **▲/▼** (arrow) buttons to select the item you wish to label. Press the **◀/▶** (arrow) buttons to select **Receiver**, **Cable**, **DVD**, **Game**, **PC**, **Recorder**, **Satellite**, **VCR** or **Blu-ray™**.
  - ❖ When entering arbitrary characters, press the **GREEN** button. The Software Keyboard window appears. Input a name using the Software Keyboard, see [“Using the software keyboard” on page 137](#).
- 4 Repeat Step 3 for other video inputs.

## Configuring shared input

### To set Shared PC Audio

- 1 Press the **SETUP** button.
- 2 Select **Options** > **Input Option** > **PC/HDMI 2 Audio** and press the **OK** button.
- 3 Press the **▲/▼** (arrow) buttons to select **PC** or **HDMI 2**.

---

**NOTE** To apply the setting, switch the input to PC or HDMI 2.

---

# Chapter 6

## Basic features

---

### Using 3D functions

Before using the 3D function, note the following:

In addition to compatible 3D glasses, viewing 3D programming requires the following (not included):

- ❖ Available 3D glasses :
  - For 58L9300U Series: Toshiba FPT-AG03 (supplied)
  - For 65L9300U/84L9300U Series: Toshiba FPT-P100 (supplied)
- ❖ Compatible 3D playback device or 3D source.
- ❖ 3D capable HDMI™ cable.

If you wish to obtain extra 3D glasses:

Toshiba provides 3D glasses for this television as an option.

To obtain them visit:

US: <http://ceaccessories.toshiba.com/>

---

**NOTE** Use the type of 3D glasses that are compatible with to your TV.

---

**▲ CAUTION** **Health precautions:**

- ❖ Due to the possible impact on vision development, viewers of 3D programming should be age 6 or above. Children may be more susceptible to health effects from viewing 3D images and should be closely supervised.
  - ❖ Some viewers may experience a seizure or blackout when exposed to certain flashing images or lights contained in certain 3D television pictures or video games. Anyone who has had a seizure, loss of awareness, or other symptoms linked to an epileptic condition, or has a family history of epilepsy, should contact a health care provider before using the 3D function.
- 

**CAUTION** **Handling the 3D glasses:**

- ❖ When cleaning the 3D glasses, gently wipe with a dry, soft cloth.
  - ❖ First, remove any dirt or dust from the 3D Glasses.
  - ❖ Harsh rubbing or use of a dirty or coarse cloth will scratch the 3D Glasses. Do not use benzene, paint thinner, alcohol, water, or abrasive cleaners, which may damage the 3D glasses.
  - ❖ When not using the 3D glasses, store them away from high temperatures and humidity.
  - ❖ Do not store the 3D glasses in areas of extreme heat or cold, as deformation can occur. If deformation occurs, replace the 3D glasses.
  - ❖ The lenses of the 3D glasses are different from those of ordinary glasses, and are very thin. Be very careful in handling the 3D glasses as the lens can pop out easily.
  - ❖ Do not put excessive force on the lenses.
  - ❖ Do not scratch the surface of the lenses with sharp objects.
  - ❖ Do not drop or bend the 3D glasses.
  - ❖ Do not use benzene, paint thinner, alcohol, water, or abrasive cleaners, which may damage the 3D glasses.
  - ❖ The 3D glasses are not subject to repair. If the glasses are broken or scratched, purchase a new pair of 3D glasses.
  - ❖ The 3D glasses are not subject to repair, but can be replaced if a problem occurs due to an initial fault with the glasses.
  - ❖ Be careful not to pinch your fingers in the hinge of the 3D glasses.
-

---

**NOTE** **Watching the TV:**

- ❖ Proper 3D effects or 3D-to-2D conversion results may not be obtained depending on the received 3D content.
- ❖ 3D effect and image quality may vary depending upon content quality and display device capability/ functionality/settings.
- ❖ Wear the 3D glasses properly, otherwise you may not see the correct 3D images.
- ❖ When not viewing 3D images, take off the 3D glasses; otherwise, it may be difficult to see the display on other products such as your computer, digital clock, or calculator, etc.
- ❖ Use the 3D glasses at the proper viewing angle and distance, see “[Safety Precautions for 3D glasses](#)” on page 7.

---

**NOTE** Use a high-speed HDMI™ cable when you connect a device such as a 3D compatible Blu-ray Disc™ player or computer to the TV. When you use a standard HDMI™ cable, 3D images may not display correctly. Some functions cannot be shown in 3D mode.

---

## Viewing 3D images

Incoming video signals can either be in 2D or 3D format. A 2D signal can be viewed in either 2D or 3D, and 3D can be viewed in either 2D or 3D. If the TV can detect the fact that a signal is 3D, it can change to 3D mode automatically – see “[Setting the auto start mode](#)” on page 81.

Otherwise you can change the viewing mode using the 3D button. Finally, the format of the 3D signal can be either Side by Side (SBS) or Top and Bottom (TAB). You may have to choose the correct format if the TV can not detect it automatically – see “[Switching display mode or selecting 3D format](#)”, below.

Moreover, you can change 2D images to 3D images by pressing the 3D button when viewing in 2D.

- 
- NOTE**
- ❖ In order to switch to 3D, the TV must be receiving a 3D signal.
  - ❖ If appropriate mode and format are not selected, 3D image will not be correctly displayed.
  - ❖ If the appropriate 3D mode and format are not selected, the 3D image will not display correctly.
  - ❖ There are individual differences in perception of 3D images.



- ❖ When viewing 3D images, wear the 3D glasses.
- ❖ The 2D to 3D conversion function is activated and controlled by you according to your personal preferences.
- ❖ The 2D to 3D conversion function is meant for enjoyment of 2D home video, and other 2D content you create, in 3D according to your personal preferences.
- ❖ It is not intended for unauthorized use of copyrighted works. To the extent that you need to obtain permission from a copyright holder to view copyrighted works, it is your responsibility to obtain such permission.
- ❖ The 2D to 3D conversion function is not intended for use with pre-recorded 2D copyrighted content owned by a third-party unless the copyright owner has given direct or indirect permission, or unless applicable law permits such use. To the extent you need to obtain permission from a copyright holder to view copyrighted works, it is your responsibility to obtain such permission.

## Switching display mode or selecting 3D format

There are four TV viewing modes:

<b>Mode:</b>	<b>Description:</b>
3D	Displays 3D images.
2D	Displays 2D images by changing 3D images to 2D.
2D to 3D	Displays 3D images by changing 2D images to 3D.
Native	Displays a received signal format as it is.

3D signals can be sent in one of three formats:

<b>3D Format:</b>	<b>Description:</b>
 Side by Side (SBS)	Images for the left and right eyes are positioned side-by-side.
 Top and Bottom (TAB)	Images for the left and right eyes are positioned at the top and bottom of the screen
 Frame Packing (FP)*	Images for the left and right eyes are positioned at the top and bottom of the screen.

\* This format cannot be selected manually.

- ❖ If the right and left images are the same in Native mode, select SBS.
- ❖ If the top and bottom images are the same in Native mode, select TAB.



## The 3D button operation

Depending on the input mode, the **3D** button function may be different when viewing Native mode.















<b><i>Input:</i></b>	<b><i>Function:</i></b>
Analog Broadcast	Changes the viewing mode to 2D to 3D mode.
Digital Broadcast	Displays the selection window.
Analog Inputs	Changes the viewing mode to 2D to 3D mode.
HDMI™	Displays the selection window.
HDMI™ with 3D Auto Detect Information	Changes the viewing mode to 3D mode.
VOD Services	Displays the selection window.
VOD Services with 3D Auto Detect Information	Changes the viewing mode to 3D mode.
MediaShare Photos	Changes the viewing mode to 3D mode.
MediaShare Videos	Displays the selection window.

### NOTE

- ❖ When viewing 3D mode or 2D to 3D mode, pressing the 3D button changes the viewing mode to Native mode.
- ❖ Operation may not be recognized depending on the status of the TV.
- ❖ When the TV is being used as a Media Renderer, operation is not recognized.
- ❖ The 3D function and 2D to 3D conversion function may not be supported depending on the VOD Service.
- ❖ The 3D function and 2D to 3D conversion function does not support all content depending on its input source format.
- ❖ 4K Video images cannot be displayed in 3D.

### Switching to 3D mode











- ❖ Set **3D Auto Start** to **3D**.
- ❖ Press the **3D** button and select **3D** while viewing 2D mode or Native mode.

<i>Input Signal/Switching Display Mode Trigger</i>		<i>Press 3D Button</i>			
Type	Additional Information	Format	Source Signal	Select 3D	Select 2D to 3D
3D Format Signal	With 3D Auto Detect Information	FP		*	
		SBS		*	
		TAB		*	
	Without 3D Auto Detect Information	SBS			
		TAB			
2D Format Signal					*
					

\* Correct 3D image.

### Selecting 3D format from the Quick menu in 3D mode











- 1 Press the **QUICK** button.
- 2 Select **3D Settings > 3D Format Select**.
- 3 Press the **OK** button.
- 4 Press the **◀/▶** (arrow) buttons to select **Side by Side** or **Top and Bottom**.

<i>Input Signal/Switching Display Mode Trigger</i>				<i>Quick menu/ 3D Format Select</i>	
Type	Additional Information	Format	Source Signal	SBS	TAB
3D Format Signal	With 3D Auto Detect Information	FP			
		SBS			
	Without 3D Auto Detect Information	SBS			
		TAB			
2D Format Signal					

\* Correct 3D image.

### Switching to 2D mode



















- ❖ Set **3D Auto Start** to **2D**.
- ❖ Press the **3D** button while viewing **3D** mode.

<i>Input Signal/Switching Display Mode Trigger</i>				<i>Press 3D Button</i>	
Type	Additional Information	Format	Source Signal	SBS	TAB
3D Format Signal	With 3D Auto Detect Information	FP			
		SBS			
	Without 3D Auto Detect Information	SBS			
		TAB			
2D Format Signal					

\* Correct 2D image.

## Selecting 2D format from the Quick menu in 2D mode

- 1 Press the **QUICK** button.
- 2 Select **3D Settings > 2D Format Select**.
- 3 Press the **OK** button.
- 4 Press the ◀/▶ (arrow) buttons to select **Side by Side** or **Top and Bottom**.

Input Signal/Switching Display Mode Trigger			Quick menu/ 2D Format Select			
Type	Additional Information	Format	Source Signal	SBS	TAB	Native
3D Format Signal	With 3D Auto Detect Information	FP				
		SBS		* 		
	TAB			* 		
	Without 3D Auto Detect Information	SBS		* 		
		TAB			* 	
2D Format Signal						* 

\* Correct 2D image.

**NOTE** Take off the 3D glasses in 2D mode

## Switching to Native mode

Press the **3D** button while viewing 3D mode.

Press the **3D** button while viewing 2D to 3D mode.

**NOTE** When 3D format signal with 3D Auto Detect Information is received, it is not possible to switch to Native.

### Quick menu in 2D mode

- 1 Press the **QUICK** button.
- 2 Select **3D Settings > 2D Format Select** and press the **OK** button.
- 3 Press **◀/▶** (arrow) buttons to select **Native**.

### To switch 2D to 3D mode

- ❖ Press the **3D** button and select 2D to 3D while viewing 2D or Native mode.

**NOTE** When using ATV, Video, ColorStream HD, VOD Services, MediaShare Photo or PC, the viewing mode can be changed to 2D to 3D mode by pressing 3D.

## Setting the auto start mode

This controls what the TV does when it detects a 3D format signal with 3D Auto Detect Information.

- 1 Press the **SETUP** button.
- 2 Select **3D > 3D Auto Start** and press the **OK** button.
- 3 Press the **▲/▼** (arrow) buttons to select **3D**, **2D**, or **Off**.

<i>Option:</i>	<i>Description:</i>
3D	Displays in 3D mode automatically when 3D format signal with 3D Auto Detect Information is received.
2D	Displays in 2D mode automatically when 3D format signal with 3D Auto Detect Information is received.
Off	Displays a screen that allows you to select 3D or 2D when 3D format signal with 3D Auto Detect Information is received.

## Setting the 3D PIN code

A 3D PIN code is necessary for using 3D Safety Settings.

### Enter a new PIN code

- 1 Press the **SETUP** button.
- 2 Select **3D > 3D PIN**.
- 3 Press the **OK** button.
- 4 Press the number buttons to enter a 4-digit number, and then confirm the code.

**NOTE** The PIN code cannot be set to "0000."

### Change or delete your PIN code

- 1 Press the **SETUP** button.
- 2 Select **3D > 3D PIN**.
- 3 Press the **OK** button.
- 4 Press the number buttons to enter your 4-digit PIN code.
- 5 Select **Change PIN** or **Delete PIN**, and then press the **OK** button.

---

**NOTE**

- ❖ The PIN code cannot be set to "0000."
  - ❖ If PIN is deleted, 3D Safety Settings are grayed out, and the settings are reset to the factory default.
- 

### Forgotten PIN codes

- 1 Press the **SETUP** button.
- 2 Select **3D > 3D PIN**.
- 3 Press the **OK** button.
- 4 Press the **INFO** button 4 times quickly.
- 5 Select **Change PIN** and press the **OK** button.
- 6 Enter a new PIN code.

### Setting the 3D start message

When this feature is set to On, a message displays on the screen when a 3D signal is received.

- 1 Press the **SETUP** button.
- 2 Select **3D > 3D Safety Settings**.
- 3 Press the **OK** button.
- 4 Enter your 4-digit 3D PIN code.
- 5 Press the **▲/▼** (arrow) buttons to select **3D Start Message** and press the **OK** button.
- 6 Press the **▲/▼** (arrow) buttons to select **On** or **Off**.

### Setting the 3D Lock

When this feature is set to On, you must enter your 3D PIN code to change the display mode to 3D mode or 2D to 3D mode.

- 1 Press the **SETUP** button.
- 2 Select **3D > 3D Safety Settings**.
- 3 Press the **OK** button.

- 4 Enter your 4-digit 3D PIN code.
- 5 Press the ▲/▼ (arrow) buttons to select **3D Lock** and press the **OK** button.
- 6 Press the ▲/▼ (arrow) buttons to select **On**.

### Setting the 3D Timer Lock

When the 3D Timer Lock feature is set to On, the PIN input window and the 3D start message will not appear while the 3D Enable timer is active, even if you switch to 3D Mode. This prevents it from asking for the 3D Lock PIN, and will not display the 3D start message every you switch to 3D.

- 1 Press the **SETUP** button.
- 2 Select **3D > 3D Safety Settings**.
- 3 Press the **OK** button.
- 4 Enter your 4-digit 3D PIN code.
- 5 Press the ▲/▼ (arrow) buttons to select **3D Timer Lock** and press the **OK** button.
- 6 Press the ▲/▼ (arrow) buttons to select **On**.

---

**NOTE** The PIN input window appears when “continue” is selected in the reminder dialogue box for Enable 3D Timer even if 3D Timer Lock is activated.

---

### Setting the Enable 3D Timer

This feature allows you to set a reminder to not watch a 3D video for an extended period of time. Once a set period of time has passed, a dialogue box appear asking if you wish to continue viewing.

- 1 Press the **SETUP** button.
- 2 Select **3D > 3D Safety Settings**.
- 3 Press the **OK** button.
- 4 Enter your 4-digit 3D PIN code.
- 5 Press the ▲/▼ (arrow) buttons to select **Enable 3D Timer** and press the **OK** button.
- 6 Press the ▲/▼ (arrow) buttons to select **30, 60, 90, or 120** minutes.
- 7 To cancel the timer, select **Off**.

## Displaying 3D Important Information

- 1 Press the **SETUP** button.
- 2 Select **3D > 3D Important Info.**  
Read through the information.
- 3 Press the ◀/▶ (arrow) buttons to select **Yes** or **No** and press the **OK** button.

## Adjusting 2D to 3D depth

With this feature, you can adjust the level of 3D depth.

### Within the Menu:

- 1 Press the **SETUP** button.
- 2 Select **3D > 2D to 3D Depth** and press the **OK** button.
- 3 Press the ◀/▶ (arrow) buttons to select either **1, 2, 3, 4, or 5**, and press the **OK** button.

### Within the Quick menu:

- 1 Press the **QUICK** button in 2D to 3D mode.
- 2 Select **3D Settings > 2D to 3D Depth**.
- 3 Press the ◀/▶ (arrow) buttons to select either **1, 2, 3, 4, or 5**, and then press the **OK** button.

## Switching left and right images

The left and right images of the glasses can be swapped. If 3D images look blurred, switch the left and right sides of the 3D image.

- 1 Press the **QUICK** button to open the Quick menu.
- 2 Select **3D Settings > Left and Right Image** and press the **OK** button.
- 3 Press the ▲/▼ (arrow) buttons to select **Swapped**.

## Adjusting your viewing position (for 65/84L9300U only)

If you experience a double image when viewing 3D content, adjust your viewing position.

- 1 Press the **SETUP** button.
- 2 Select **3D > 3D Test Pattern** and press **OK**.  
The **3D Test Pattern** is displayed.
- 3 Put on the 3D glasses (supplied).
- 4 Adjust your viewing position so that there is no double image effect.  
For the correct position for viewing 3D content, see page 8.



## Tuning Channels

### Tuning to the next programmed channel

Press the **CH ▲/▼** buttons on the remote control or TV control panel.

### Tuning to a specific channel (programmed or unprogrammed)

<i>Channel:</i>	<i>Description:</i>
Analog	Use the 0–9 buttons on the remote control. (For example, to select channel 125, press 1, 2, 5.), and then press the <b>OK</b> button.
Digital	Use the 0–9 buttons on the remote control to enter the major channel number. (and press the <b>DASH</b> button if needed, (For example, to select digital channel 125- 1, press 1, 2, 5, -, 1.)), and then press the <b>OK</b> button.

### Using Channel Return

You can switch between two channels without entering a channel number each time. This feature also works for external inputs.

- 1 Select the first channel you want to view.
- 2 Select a second channel using the Channel Number buttons (and press the **DASH** button if needed).
- 3 Each time you press the **CH RTN** button, the TV switches between the last two channels that were tuned.

### Selecting the video input to view

To select the video input to view:

- 1 Press the **INPUT** button.
- 2 Change the input:
  - ❖ Press 0–7.
  - ❖ Repeatedly press the **▲/▼** (arrow) buttons and then press the **OK** button.
  - ❖ Repeatedly press the **INPUT** button.

<i>Inputs</i>	
0	ANT/CABLE
1	Video 1
2	Video 2 / ColorStream HD
3	HDMI 1
4	HDMI 2
5	HDMI 3
6	HDMI 4
7	PC

- 
- NOTE**
- ❖ You can label the video input sources according to the specific devices you have connected to the TV, see [“Labeling video inputs” on page 72](#).
  - ❖ You can skip sources, see [“Skipping video inputs” on page 71](#).
  - ❖ Inputs that are set to be skipped will be skipped when selecting by repeatedly pressing the **INPUT** button or the ▲/▼ (arrow) buttons.
  - ❖ You can select inputs that are set to be skipped using the number buttons.
  - ❖ If one or more HDMI™ CEC devices are connected to an HDMI™ input, the icon appears in the input selector. In this case, the label, see [“Labeling video inputs” on page 72](#) will not appear in the input selector.
- 

**To select an HDMI™ CEC device:**

- 1 Press the ▲/▼ (arrow) buttons to select an HDMI™ input.
- 2 Press the ► (arrow) button. The list of HDMI™ CEC devices for that input appears.
- 3 If the input has multiple HDMI™ CEC devices, press the ▲/▼ (arrow) buttons to select a device.
- 4 Press the **OK** button.

## Using closed captions

**To turn on the closed caption mode:**

- 1 Press the **SETUP** button.
- 2 Select **Options > Closed Captions**.
- 3 Press the **OK** button.
- 4 Press the ▲/▼ (arrow) buttons to select **Closed Captions Display** and press the **OK** button.
- 5 Press the ▲/▼ (arrow) buttons to select **On** or **Off**.

- 
- NOTE** If **Closed Captions Display** is set to **Off**, **Analog CC Mode** and **Digital CC Settings** will be not available.
-

## Analog CC mode

The closed caption mode has two options:

<i>Mode:</i>	<i>Description:</i>
Captions	Displays the dialogue, narration, and sound effects of TV programs and videos that are closed captioned (usually marked "CC" in program guides).
Text	Displays information not related to the current program, such as weather or stock data (when provided by individual stations).

### To view captions or text:

- 1 Press the **SETUP** button.
- 2 Select **Options > Closed Captions**.
- 3 Press the **OK** button.
- 4 Press the **▲/▼** (arrow) buttons to select **Analog CC Mode** and press the **OK** button.

#### To view captions:

Press the **▲/▼** (arrow) buttons to highlight **CC1, CC2, CC3, or CC4**.



### *(Sample Illustration) Captions*

## NOTE

If the program or video you have selected is not closed captioned, no captions will be displayed.

#### To view text:

Press the **▲/▼** (arrow) buttons to highlight **T1, T2, T3, or T4**.

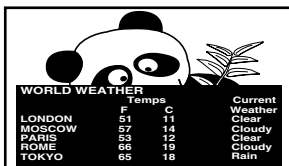

### *(Sample Illustration) Captions - text*

**NOTE** If text is not available in your area, a black rectangle may appear on the screen. You can remove this rectangle by setting Closed Captions Display to Off.

**NOTE** A closed caption signal may not be displayed when a videotape is dubbed, signal reception is weak, or signal reception is non-standard.

## Digital CC settings

You can customize the closed caption display characteristics.

**NOTE**

- ❖ These settings are available for digital channels only.
- ❖ You cannot set Caption Text and Background as the same color.

<i>Mode:</i>	<i>Description:</i>
Caption Size	Auto, Small, Standard, Large
Caption Text Type	Auto, Default, Mono (with Serif), Prop. (with Serif), Mono (without Serif), Prop. (without Serif), Casual, Cursive, Small Capitals
Caption Text Edge	Auto, None, Raised, Depressed, Uniform, Left Drop Shadow, Right Drop Shadow
Caption Text Color	Auto, Black, White, Red, Green, Blue, Yellow, Magenta, Cyan
Text Foreground Opacity	Auto, Transparent, Translucent, Flashing, Solid
Background Color	Auto, Black, White, Red, Green, Blue, Yellow, Magenta, Cyan
Text Background Opacity	Auto, Transparent, Translucent, Flashing, Solid
Caption Text Edge Color	Auto, Black, White, Red, Green, Blue, Yellow, Magenta, Cyan

### To customize the closed captions:

- 1 Press the **SETUP** button.
- 2 Select **Options > Closed Captions**.
- 3 Press the **OK** button.
- 4 Press the **▲/▼** (arrow) buttons to select **Digital CC Settings**.and then press the **OK** button.
- 5 Press the **▲/▼** (arrow) buttons to select a characteristic and then press the **OK** button.  
Press the **▲/▼** (arrow) buttons to select the format for that characteristic.

## Using the Closed Caption button

If you press the **CC** button when an analog channel is tuned or from an external input (480i signal from the video input):

- ❖ The CC bar will appear and will display the options, CC1-4, T1-4.

If you press the **CC** button when a digital channel is tuned:

- ❖ The CC bar will appear and will display the available caption options for that channel or service.

## Setting the PIN code

A PIN code is necessary for some menus.

---

**NOTE** The Parental Control and Locks menu is grayed out if no PIN has been set.

---

## Entering a new PIN code

- 1 Press the **SETUP** button.
- 2 Select **Options > Parental PIN Setup**.
- 3 Press the **OK** button.
- 4 Use the number buttons to enter a 4-digit number, and then confirm the code.

---

**NOTE** The PIN code cannot be set to "0000".

---

## Changing or deleting your PIN code

- 1 Press the **SETUP** button.
- 2 Select **Options > Parental PIN Setup**.
- 3 Press the **OK** button.
- 4 Use the number buttons to enter your 4-digit PIN code.
- 5 Select **Change PIN** or **Delete PIN**, and then press the **OK** button.

---

**NOTE**

- ❖ The PIN code cannot be set to "0000".
- ❖ If you delete the PIN code, the settings of Parental Controls and Locks are reset.

---

## Forgotten PIN code

- 1 Press the **SETUP** button.
- 2 Select **Options > Parental PIN Setup**.
- 3 Press the **OK** button.
- 4 Press the **INFO** button 4 times quickly.
- 5 Select **Change PIN** and press the **OK** button.
- 6 Enter a new PIN code.

## Using parental controls

### Blocking TV programs and movies by rating (V-Chip)

Some TV programs and movies include signals that classify the content of the program (as unsuitable for younger viewers). The V-Chip feature in this TV detects the signals and blocks the programs according to the ratings you select.

---

**NOTE** The V-Chip feature in this TV supports the U.S. V-Chip system only.

---

- 1 Press the **SETUP** button.
- 2 Select **Options > Parental Control and Locks**.
- 3 Press the **OK** button.
- 4 Enter your 4-digit PIN code.
- 5 Press the **▲/▼** (arrow) buttons to select **Enable Rating Blocking** and press the **OK** button.
- 6 Press the **▲/▼** (arrow) buttons to select **On**.
- 7 Press the **▲/▼** (arrow) buttons to select **Edit Rating Limits**, and then press the **OK** button.  
The **Edit Rating Limits** screen appears.
- 8 Press the **▲/▼/◀/▶** (arrow) buttons.
- 9 Press the **OK** button to select a level of blocking.  
A box with an “X” indicates a rating that will be blocked. As you highlight a rating, the rating’s definition appears at the bottom of the screen.
- 10 Select **Done** and then press the **OK** button.

---

**NOTE** This feature will not be available if no PIN code is set.

---

## Downloading an additional rating system

An additional rating system may be available for use in selectively blocking TV programs and movies.

**NOTE** The currently tuned station must be receiving a digital signal before an additional rating system can be downloaded.

- 1 Press the **SETUP** button.
- 2 Select **Options > Parental Control and Locks**.
- 3 Press the **OK** button.
- 4 Enter your 4-digit PIN code.  
The **Parental Control and Locks** screen appears.
- 5 Press the **▲/▼** (arrow) buttons to select **Enable Rating Blocking** and press the **OK** button.
- 6 Press the **▲/▼** (arrow) buttons to select **On**.
- 7 Press the **▲/▼** (arrow) buttons to select **Edit Rating Limits**, and then press the **OK** button.  
The **Edit Rating Limits** screen appears.
- 8 Select **Alt RS**, and then press the **OK** button.  
The **Edit Alternate Ratings** screen appears.

**NOTE**

- ❖ The **Alt RS** button is only available if an additional rating system is currently available.
- ❖ The download may take several minutes.
- ❖ The information displayed on the Alternate Ratings screen depends on the configuration of the additional rating system available at the time of download.

- 9 Press the **▲/▼/◀/▶** (arrow) buttons.
- 10 Press the **OK** button to select the desired level of blocking. A box with an “X” indicates the rating that will be blocked.

**NOTE**

- ❖ You can only download the additional rating system once. You cannot download updates if they become available.
- ❖ The additional rating system is not designed, transmitted, or controlled by the TV or Toshiba, nor is the availability of an additional rating system determined or controlled by Toshiba. Similarly, the rating of programs in an additional rating system is not determined, transmitted, or controlled by the TV or Toshiba.

- ❖ The additional rating system is an evolving technology; therefore, availability, content, and format may vary.

## Rating system

Independent rating system for broadcasters:

<b>Ratings:</b>	<b>Description and Content themes:</b>
TV-MA	Mature Audience Only (This program is specifically designed to be viewed by adults and therefore may be unsuitable for children under 17. L) Crude or indecent language S) Explicit sexual activity V) Graphic violence
TV-14	Parents Strongly Cautioned (This program contains some material that many parents would find unsuitable for children under 14 years of age.) D) Intensely suggestive dialogue L) Strong, coarse language S) Intense sexual situations V) Intense violence
TV-PG	Parental Guidance Suggested (This program contains material parents may find unsuitable for younger children.) D) Some suggestive dialogue L) Infrequent coarse language S) Some sexual situations V) Moderate violence
TV-G	General Audience (Most parents would find this program suitable for all ages.)
TV-Y7, TV-Y7FV	Directed to Older Children (This program is designed for children age 7 and above.  NOTE: Programs in which fantasy violence may be more intense or more combative than other programs in this category are designated TV-Y7FV.)
TV-Y	All Children (This program is designed to be appropriate for all children.)

Independent rating system for movies

<b>Ratings:</b>	<b>Description and Content themes:</b>
X	X-rated (For adults only)
NC-17	Not intended for anyone 17 and under
R	Restricted (Under 17 requires accompanying parent or adult)
PG-13	Parents Strongly Cautioned (Some material may be inappropriate for children under 13)
PG	Parents Strongly Cautioned (Some material may be inappropriate for children under 13)
G	General Audience (Appropriate for all ages)

Indication other than rating system

<b>Display:</b>	<b>Description:</b>
NONE	The program is rated None.
(No rating appears)	No rating information is provided.



**NOTE** If you place an “X” in the box next to “Rated “None””, programs rated “None” or “Not Rated” will be blocked; Programs that do not provide any rating information will not be blocked.

## Displaying ratings

To display the rating of the program you are watching, press the **INFO** button on the remote control.

## Unlocking programs

If you try to tune to a program that exceeds the rating limits you have set, the TV will enter program lock mode and a warning message will appear on screen. Follow the instructions to temporarily unlock the program.

## Locking specific channels

A channel that is configured as Locked cannot be viewed unless the PIN code is entered first, see “[Setting the PIN code](#)” on page 89.

- 1 Press the **SETUP** button.
- 2 Select **Options > Channel Options**.
- 3 Press the **OK** button.

The list of channels appears.

Channel Options				
Ch	Type	Label		
101 - 201	DTV	CH-1	<input checked="" type="checkbox"/>	<input checked="" type="checkbox"/>
201	ATV	CH-2	<input type="checkbox"/>	<input type="checkbox"/>
101 - 201	DTV		<input type="checkbox"/>	<input type="checkbox"/>
201	ATV		<input type="checkbox"/>	<input type="checkbox"/>
101 - 201	DTV		<input type="checkbox"/>	<input type="checkbox"/>
201	ATV		<input type="checkbox"/>	<input type="checkbox"/>
101 - 201	DTV		<input type="checkbox"/>	<input type="checkbox"/>

### *(Sample Illustration) Channel options*

- 4 Press the **▶** (arrow) button and then press the **▲/▼** (arrow) buttons to select a channel in the lock column, and then press the **OK** button.
- 5 You must enter your PIN code to lock channels.

**NOTE** If no PIN code has been set, a warning appears. See, “[Setting the PIN code](#)” on page 89.

- 6 The box is selected. To clear the selection, press the **OK** button.

## Locking video inputs

You can lock video inputs. You cannot view the input sources until you unlock the inputs by entering the PIN code.

- 1 Press the **SETUP** button.
- 2 Select **Options > Parental Control and Locks**.
- 3 Press the **OK** button.
- 4 Enter your 4-digit PIN code.
- 5 Press the **▲/▼** (arrow) buttons to select **Input Lock** and press the **OK** button.
- 6 Press the **▲/▼** (arrow) buttons to select **Video** or **Off**.

<b>Mode:</b>	<b>Description:</b>
Video	Locks Video 1, Video 2, ColorStream HD, HDMI 1, HDMI 2, HDMI 3, HDMI 4, and PC.
Off	Unlocks all video inputs.

## Setting a time limit for games

You can use the GameTimer<sup>®</sup> to set a time limit for playing a video game. When the time expires, the TV locks all external inputs.

- 1 Press the **SETUP** button.
- 2 Select **Timers > GameTimer**.
- 3 Press the **OK** button.
- 4 Enter your 4-digit PIN code.
- 5 Press the **▲/▼** (arrow) buttons to select **30**, **60**, **90**, or **120** minutes.
- 6 To cancel the timer, select **Off**.

**To deactivate the Input Lock once the GameTimer<sup>®</sup> has activated it:**

- ❖ Set the Input Lock to Off, see [“Locking video inputs” on page 94](#).

- 
- NOTE**
- ❖ A message appears when 10 minutes, 3 minutes, and 1 minute are remaining.
  - ❖ If the TV loses power with time remaining, the TV will enter Input Lock mode when power is restored (as if the GameTimer had been activated). You must deactivate the Input Lock, see [“Locking video inputs” on page 94](#).
- 

## Locking the control panel

You can lock the control panel to prevent your settings from being

changed accidentally (by children, for example). When Panel Lock is set to **On**, none of the controls on the control panel operate except **POWER**.

- 1 Press the **SETUP** button.
- 2 Select **Options > Panel Lock** and press the **OK** button.
- 3 Press the **▲/▼** (arrow) buttons to select **On**.

---

**NOTE** When **Panel Lock** is set to **On**, "Panel Lock" appears on screen when the buttons on the TV control panel are pressed. Unless the TV is in "Active Standby", then control panel **POWER** button can turn on the TV.

---

**To unlock the control panel:**

- ❖ Select **Off** in Step 3 above.

## Using HDMI™ CEC Control

This feature uses CEC technology and allows you to control Toshiba HDMI™ CEC compatible devices from the TV remote control via HDMI™ connection.

When Enable HDMI™ CEC Control in the HDMI™ CEC Control Setup menu is set to On, the following HDMI™ CEC Control functions are enabled.

### To set HDMI™ CEC Control Setup

- 1 Press the **SETUP** button.
- 2 Select **Options > HDMI CEC Control Setup** and press the **OK** button.
- 3 Press the **▲/▼** (arrow) buttons to select **Enable HDMI CEC Control** and press the **OK** button.
- 4 Press the **▲/▼** (arrow) buttons to select **On**.

---

**NOTE** If you set **Enable HDMI CEC Control** to **Off**, the other items under **HDMI CEC Control Setup** will be grayed out.











---

- 5 Press the **▲/▼** (arrow) buttons to select an item and press the **OK** button.  
Press the **▲/▼** (arrow) buttons to select **On** or the desired mode:
  - ❖ TV Auto Power: **On/Off**
  - ❖ Auto Standby: **On/Off**
  - ❖ Amplifier Control: **On/Off**
  - ❖ Initial Speaker Setting: **TV Speakers/Amplifier**

**NOTE** These functions depend on the connected devices.



## Controlling HDMI™ CEC playback devices

With your TV's remote control, you can control the connected HDMI™ CEC playback device (DVD player, etc.) you are watching.

<b>Button:</b>	<b>Description:</b>
	Begins playback
	Stops playback
	Pauses the picture during play or record mode
	Skips forward.
	Skips backward.
	Fast forward
	Rewind/reverse
	Menu navigation, etc.
<b>OK</b>	Enters content with a menu
RED, GREEN, YELLOW, BLUE	Controls various operation
0–9 buttons	Controls various operation, e.g. tuning to a specific channel for the tuner device
Channel  / 	Changes to the next available channel up or down in the sequence

**NOTE** These functions depend on the connected devices.

## HDMI™ CEC Player Control menu functions

- 1 Press the **QUICK** button to open the Quick menu.
- 2 Select **HDMI CEC Device Control**, and then press the **OK** button.
- 3 Press the / (arrow) buttons to select the item you want to control, and then press the **OK** button.

<b>Item:</b>	<b>Description:</b>
Power	Turns the selected device On and Off
Root Menu	Accesses the selected device's top menu
Contents Menu	Accesses the content list when the <b>OK</b> button is pressed
Setup Menu	Accesses the device's setup menu
Audio	Selects the device's sound
Eject	Ejects the device's media

- 
- NOTE** These functions depend on the connected devices. The HDMI™ CEC Device Control item is not available under the following conditions:
- ❖ A non-HDMI™ input is selected
  - ❖ The **Enable HDMI CEC Control** item is set to **Off**
  - ❖ The connected HDMI™ CEC device is not a playback, recording or tuner device
- 

### **HDMI™ CEC Control input source selection**

If an HDMI™ CEC device with HDMI™ switching capability (e.g. an amplifier) is connected to the HDMI™ input, you can select another HDMI™ CEC device that is connected to the master HDMI™ device.

Use the **INPUT** button on the remote control or the control panel, see “[Learning about the remote control](#)” on page 53.

### **Adjusting the amplifier’s audio**

Using the TV’s remote control, you can adjust or mute the sound volume of your audio system.

- ❖ The **VOL (+ -)** buttons adjust the volume level.
  - ❖ The **MUTE** button turns off the sound.
- 1 Press the **SETUP** button.
  - 2 Select **Options > HDMI CEC Control Setup** and press the **OK** button.
  - 3 Press the **▲/▼** (arrow) buttons to select **Initial Speaker Setting** and press the **OK** button.
  - 4 Press the **▲/▼** (arrow) buttons to select **Amplifier**.

- 
- NOTE** Confirm that a connected HDMI™ CEC device (such as DVD player, etc.) is selected for the Amplifier input source.
- 

- 
- NOTE**
- ❖ You can also use this function when the audio system is connected to the TV’s DIGITAL AUDIO OUT terminal (not HDMI™ connection). Select a digital audio input mode on the amplifier.
  - ❖ These functions depend on the device connected.
-

## Other HDMI™ CEC Control functions

When **Enable HDMI CEC Control** and all items in the HDMI™ CEC Control Setup menu are set to **On**, the following functions will be enabled:

<i>Item:</i>	<i>Description:</i>
TV Auto Power	If an HDMI™ CEC device is turned on, the TV turns on automatically.
Auto Standby	If the TV is turned off, it will send a message to turn off all of the HDMI™ CEC devices connected to the TV.
Amplifier Control	If <b>Amplifier Control</b> is set to <b>On</b> , you can adjust the sound volume or turn off the sound using the remote control.
Initial Speaker Setting	With this item, you can set your audio output preference to the TV Speakers or the Amplifier. When this item is set to Amplifier, the remote control can be used to adjust or mute the volume of the audio. This item will not be available and set to TV Speakers automatically unless an HDMI™ CEC compatible audio system is connected.

### NOTE

When you turn on the audio system, change its input source, or adjust the sound volume, the sound will be output from the audio system's speakers even if TV Speakers has been selected. Turn the TV off and on again to output the sound from the TV speakers.

## Viewing the HDMI™ signal information

- 1 Press the **SETUP** button.
- 2 Select **Options > HDMI Information Display** and press the **OK** button.
- 3 Press the **▲/▼** (arrow) buttons to select **On**.
- 4 Press the **INFO** button.  
HDMI™ Information is shown (Resolution, Scan Type, Frame Rate, Aspect, Bit Depth, Color Space, RGB/YUV, Chroma Format), and the normal banner and signal information banner appear.

### NOTE

- ❖ The signal information banner will appear when this feature is set to On and you watch an HDMI™ input and press the **INFO** button. The signal information will disappear after 60 seconds.
- ❖ If you press the **INFO** button when this feature is set to Off, only the normal banner will appear.

## Using your computer with the TV

### Adjusting the image

If the edges of the picture are hidden, readjust Horizontal Position and Vertical Position. If the picture is affected by interference, readjust Clock Phase and Sampling Clock.

- 1 Select **PC input mode**, see “Selecting the video input to view” on page 85.
- 2 Press the **SETUP** button.
- 3 Select **Picture > Display Settings** and press the **OK** button.
- 4 Press the **OK** button.
- 5 Press the **▲/▼** (arrow) buttons to select **PC Settings**, and then press the **OK** button.

---

**NOTE** If a computer is not connected or there is no PC input signal, this menu will not be available.

---

- 6 Press the **▲/▼** (arrow) buttons to select an item and press the **OK** button.
- 7 Press the **◀/▶** (arrow) buttons to make adjustments.

---

**NOTE** The screen is disrupted momentarily when adjusting the PC settings. This is not a sign of malfunction.

---

<i>Mode:</i>	<i>Description:</i>	<i>Adjustment Range</i>
Horizontal Position	Moves the picture left/right	Within $\pm 10$ from center*
Vertical Position	Moves the picture up/down	Within $\pm 10$ from center*
Clock Phase	Helps to reduce noise and sharpen the picture	Within $\pm 32$ from center*
Sampling Clocks	Helps to reduce noise and minimize periodic vertical stripes on the screen	Within $\pm 5$ from center*

\*The default settings and/or adjustment ranges vary depending on the input signal format.

### To reset the PC Settings:

Select **Reset**, and then press the **OK** button.

## Setting the computer audio

You can output sound from your computer when connecting it to your TV, using the AUDIO IN terminal and PC audio cable.

- 1 Press the **SETUP** button.
- 2 Select **Options > Input Options** and press the **OK** button.
- 3 Press the **▲/▼** (arrow) buttons to select **PC/HDMI 2 Audio** and press the **OK** button.
- 4 Press the **▲/▼** (arrow) buttons to select **PC**.

---

**NOTE** To apply the setting, switch the input to PC or HDMI 2.

---

## Setting the timer to turn on the TV

You can set the on timer to turn on the TV to a preset channel or input at a preset time.

### To activate the timer:

- 1 Press the **SETUP** button.
- 2 Select **Timers > On Timer**.
- 3 Press the **OK** button.
- 4 Press the **▲/▼** (arrow) buttons to select **Enable On Timer** and press the **OK** button.
- 5 Press the **◀/▶** (arrow) buttons to select **On**.

---

**NOTE** If the **Enable On Timer** is set to **Off**, other menus under **On Timer** cannot be changed.

It can take the TV approximately 60 seconds to turn on through the **On Timer** feature.

---

### To set the timer:

- 1 Press the **SETUP** button.
- 2 Select **Timers > On Timer**.
- 3 Press the **OK** button.
- 4 Set these options to your preference:



<i>Item:</i>	<i>Description:</i>
Input	Video input source
Channel	Channel to view
Volume	Volume level
Time until Power On	Desired length of time until the TV turns on: minimum=00:10, maximum=12:00 Press the ◀/▶ (arrow) buttons Use the number buttons

- 5 Select **Done**, and then press the **OK** button.

**NOTE** If you do not operate the TV for 1 hour after it is powered on by the On Timer feature, it turns off.

**To cancel the timer:**

- 1 Press the **SETUP** button.
- 2 Select **Timers > On Timer**.
- 3 Press the **OK** button.
- 4 Press the ▲/▼ (arrow) buttons to select **Enable On Timer** and press the **OK** button.
- 5 Press the ◀/▶ (arrow) buttons to select **Off**.

## Setting the sleep timer

You can set the TV to turn off after a specific amount of time (maximum = 12 hours).

**Using the remote control:**

- 1 Press the **SLEEP** button.
- 2 Set the amount of time until the TV turns off.
  - ❖ Repeatedly press the **SLEEP** button to increase the time.
  - ❖ Press the ▲/▼ (arrow) buttons to increase or decrease the time.

**Using the on-screen menus:**

- 1 Press the **SETUP** button.
- 2 Select **Timers > Sleep Timer**.
- 3 Press the **OK** button.
- 4 Select the amount of time until the TV turns off.
  - ❖ Use the number buttons.
  - ❖ Press the ▲/▼ (arrow) buttons to increase or decrease the time.

**NOTE** If a power failure occurs, the sleep timer setting may be cleared.

---

To display the time remaining until the TV turns off, press the **SLEEP** button.

To cancel the sleep timer, press the **SLEEP** button repeatedly or press the **▲/▼** (arrow) buttons until it is set to 0 minutes.

---

**NOTE** When the following features are set, the feature that is set for the nearest time will function.

- ❖ Sleep Timer
  - ❖ Auto shutdown after 1 hour of inactivity (after powering on by On Timer)
  - ❖ No signal auto power off (after approximately 15 minutes of no signal)
- 

## Setting No Signal Power Down

When an input's setting in this feature is set to On, The TV will automatically turn itself off after about 15 minutes if no signal is detected.

You can change each input's setting to Off: ANT/CABLE, Video 1, Video 2, ColorStream HD, HDMI 1, HDMI 2, HDMI 3, HDMI 4, or PC.

- 1 Press the **SETUP** button.
  - 2 Select **Options > Power Management > No Signal Power Down**, and then press the **OK** button.
  - 3 Press the **▲/▼** (arrow) buttons to select the item you want to change and press the **OK** button.
  - 4 Press the **▲/▼** (arrow) buttons to select **On** or **Off**.
  - 5 Press the **EXIT** button.
- 

**NOTE** ❖ Default setting for each input is On.  
❖ A warning message will appear 1 minute before turning off.

---

## Setting TV Power On Control

When the TV is connected to the home network via Wireless LAN with the **TV Power On Control** in **Enabled**, your TV can be turned on by control from Apps.

- 1 Press the **SETUP** button.
- 2 Select **Options > Power Management > TV Power On Control** and press the **OK** button.
- 3 Press the **▲/▼** (arrow) buttons to select **Enabled** (Active Standby).

---

### **NOTE**

- ❖ Depending on the device connected to the home network, it may take a while for the TV to turn on.
  - ❖ Depending on the device connected to the home network, this feature may not work.
  - ❖ If the unencrypted Wireless Setup is done, this feature can not be used.
  - ❖ The power consumption during Active Standby is more than it during Normal Standby.
  - ❖ After the change from Power On state to Active Standby, there may be a period of several seconds when the TV does not receive the operation from a remote control or external apparatus.
-

## Displaying TV status information

To display TV status information, press **INFO**.

The following information will be displayed (if applicable):

- ❖ Current input (**ANT/CABLE**, **Video**, etc.)
- ❖ Either “CABLE” (for cable TV) or “ANT” (for over-the-air broadcasts), if **ANT/CABLE** is the current input
- ❖ Channel number (if in **ANT/CABLE** mode)
- ❖ Input label (if set)
- ❖ Digital signal strength indicator (for ATSC/QAM signals only)
- ❖ Stereo, Mono, or SAP audio status (when in HDMI™ input mode, PCM)
- ❖ Video resolution
- ❖ Aspect ratio of incoming video signal (4:3 or 16:9)
- ❖ V-Chip rating status (if available)
- ❖ GameTimer (if set)
- ❖ Channel Label (if set or received)
- ❖ Current display mode (Side by Side, Top and Bottom, or Frame Packing)
- ❖ Current display format (3D, 2D to 3D, or 3D to 2D)
- ❖ Input video format (3D appears when video format is 3D)

To close the screen, press the **INFO** button again.

The following additional information (only available for **ANT/CABLE** input) will display for digital channels (if applicable):

- ❖ Title
- ❖ Duration
- ❖ Detailed description
- ❖ Next program’s information

## Viewing support information

- 1 Press the **SETUP** button.
- 2 Select **Get Help > System Information**.
- 3 Press the **OK** button to display support information containing Web/Customer service numbers for US, Canada, and Mexico.

## Resetting to Factory Defaults

You can reset all settings and channels to Factory Defaults.

- 1 Press the **SETUP** button.
- 2 Select **Installation > Reset TV**.
- 3 Enter your PIN code (if a PIN code has been set).  
A confirmation screen appears.
- 4 Select **Yes**, and then press the **OK** button.  
The TV will turn off automatically.

### To cancel the reset:

- ❖ Press the ◀/▶ (arrow) buttons to select **No**, and then press the **OK** button.

## Power failure

If power is lost while you are watching the TV, the Last Mode Memory feature automatically turns on the TV when power is restored.

# Chapter 7

## Picture and Sound Controls

---

### Selecting the picture size

You can view many program formats in several picture sizes— Native, 4:3, Full, TheaterWide 1, TheaterWide 2, TheaterWide 3, Normal, Quad FHD, 4K Native, 4K Normal, and 4K Full.

---

**NOTE**

- ❖ The picture size illustrations are examples only. The format of the image (in any of the picture sizes) depends on the format of the signal you are currently watching. Select the picture size that displays the current program in the way that looks best to you.
  - ❖ Using these functions to change the picture size (i.e., changing the height/width ratio) for any purpose other than your private viewing may be prohibited under the Copyright Laws of the United States and other countries, and may subject you to civil and criminal liability.
  - ❖ Some picture sizes may not be available depending on the format of the signal being received.
  - ❖ If you select a TheaterWide® picture size, the top and bottom edges of the picture (including subtitles or captions) may be hidden. To view these edges, adjust the Picture Position or try viewing the program in 4:3 or Full, see [“Scrolling the picture” on page 111](#).
-

You can save separate picture size preferences for each input on your TV.

**To select the picture size using the Quick menu:**

- 1 Press the **QUICK** button to open the Quick menu.
- 2 Select **Picture Size**, and then press the **OK** button.
- 3 Press the **▲/▼** (arrow) buttons to select the **Picture Size**, and then press the **OK** button.

**NOTE** When in 2D to 3D mode, 3D mode, or 2D mode, **Picture Size** does not appear in the Quick menu.

**Native Mode™**

This applies pixel-for-pixel image reproductions of Full HD content and eliminating overscanning; you see all of the original picture within the screen and eliminate scaling artifacts for a more accurate image. These settings are for viewing in 480i (HDMI™), 480p (HDMI™), 720p, 1080i, and 1080p signal programs.

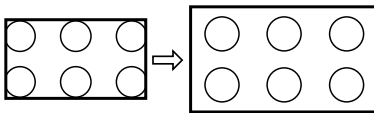

**(Sample Illustration) Picture size - Native Mode™**

- ❖ If receiving a 1080i, 1080p, 720p, 480i (HDMI™), or 480p (HDMI™) signal program, the video is scaled to display the entire picture within the borders of the screen (i.e. no overscanning).
- ❖ This is especially useful for external HD sources such as DVHS movies, video games, or computer graphics.
- ❖ None of the picture is hidden.

**NOTE**

- ❖ This mode is supported only for HDMI™ (1080i, 1080p, 720p, 480i, and 480p), ColorStream® (1080i and 720p), and ANT/CABLE (digital) inputs (1080i, 1080p, and 720p).
- ❖ Depending on the input signal, the picture's border may be hidden, displayed in black, or noisy.

### 4:3

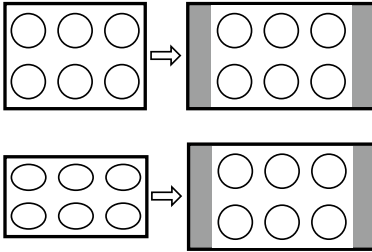

#### *(Sample Illustration) Picture size - 4:3*

Some program formats will display with sidebars and/or bars at the top and bottom.

### Full

This setting is for viewing in the 16:9 (480i, 480p) source programs only.

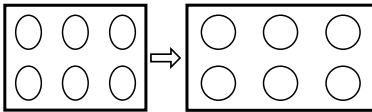

#### *(Sample Illustration) Picture size - Full 16:9*

If receiving a squeezed 4:3 format program, the picture is stretched horizontally to fill the width of the screen but not stretched vertically.

This setting is for viewing in the 1080i, 1080p, and 720p program source.

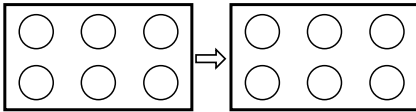

#### *(Sample Illustration) Picture size - Full*

The edges of the picture may be hidden.

### TheaterWide1

This setting is for viewing in 4:3 format programs.

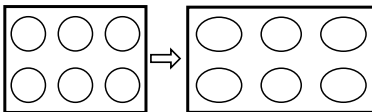

#### *(Sample Illustration) Picture size - TheaterWide1*

The center of the picture remains close to its original proportions, but the left and right edges are stretched horizontally to fill the screen.



### TheaterWide2

This setting is for viewing letter box programs.

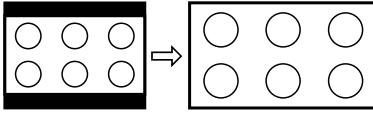

*(Sample Illustration) Picture size - TheaterWide2, letter box*

The picture's top and bottom edges may be hidden\*.

### TheaterWide3

This setting is for viewing letter box programs with subtitles.

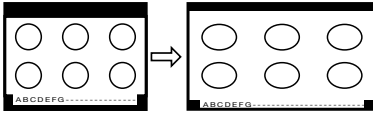

*(Sample Illustration) Picture size - TheaterWide 3, letter box with subtitles*

The picture's top and bottom edges are hidden\*.

### Normal

This setting is for viewing SVGA, XGA, WXGA, and SXGA sources.

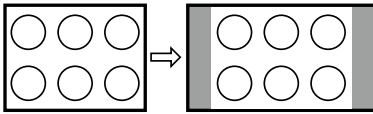

*(Sample Illustration) Picture size - Normal*

This size is a non-stretched display. Some input signal formats will display with sidebars and/or bars at the top and bottom.

### Quad FHD

This setting will show the input signal dot in four dots, two vertical and two horizontal

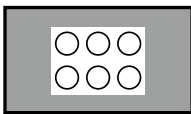

*(Sample Illustration) Picture size - Quad FHD*

“Quad FHD” is a non-scaling display. Depending on the input signal

format, the picture appears with sidebars and/or bars at the top and bottom, for example, SVGA input source.

\* To view the hidden areas (such as subtitles or captions), see “[Scrolling the picture](#)” on page 111.

### **4K Native**

This setting will show the picture (3840 pixel x 2160 pixel) without overscan, i.e. WYSIWYG.

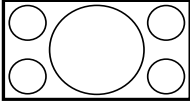

#### *(Sample Illustration) Picture size - 4K Native*

This option is only available when watching a 4K signal source via HDMI terminal.

### **4K Normal**

This setting will show whole picture (4096 pixel x 2160 pixel) with the same proportion as original image. The picture will be shown with 15/16 scaling.

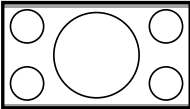

#### *(Sample Illustration) Picture size - 4K Normal*

This option is only available when watching a 4K signal source via HDMI™ terminal.

### **4K Full**

This setting will show the picture (4096 pixel x 2160 pixel) with the original size.

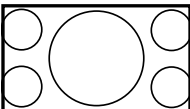

#### *(Sample Illustration) Picture size - 4K Full*

This option is only available when watching a 4K signal source via HDMI™ terminal.

---

**NOTE** In this picture size, the left and right sides are clipped by 128 pixels each, preventing any scaling.

---

## Scrolling the picture

If the edges of the picture are hidden, you can adjust the image's position.

- NOTE**
- ❖ You can adjust the picture position when the picture size is set to TheaterWide2 or TheaterWide3.
  - ❖ When viewing Cloud TV, MediaShare or Internet content this feature is not available.

- 1 Press the **SETUP** button.
- 2 Select **Picture > Display Settings > Picture Position** and press the **OK** button.
- 3 Press the **▲/▼** (arrow) buttons to select **Vertical Position** and press the **OK** button.
- 4 Press the **◀/▶** (arrow) buttons to make the appropriate adjustments. The adjustment range is from **-5** to **+10**.

## Using the Auto Aspect feature

When this feature is set to On, the TV will automatically select the picture size when one of the following input sources is received:

- ❖ 480i, 480p, 720p, 1080i digital signal from the ANT/CABLE input
- ❖ 480i, 480p, 720p, 1080i, 1080p, or VGA (60/72/75 Hz) signal from the HDMI™ 1/2/3/4 input

- NOTE** The auto aspect ratio feature is not applicable to the PC input.

- 1 Press the **SETUP** button.
- 2 Select **Picture > Display Settings > Auto Aspect** and press the **OK** button.
- 3 Press the **▲/▼** (arrow) buttons to select **On**.
- 4 Press the **EXIT** button.

## Using the 4:3 Stretch

When 4:3 Stretch is activated, the TV displays 4:3 programs as a full-screen picture.

- NOTE** This feature is available when Auto Aspect is set to On.

- 1 Press the **SETUP** button.

- 2 Select **Picture** > **Display Settings** > **4:3 Stretch** and press the **OK** button.
- 3 Press the ▲/▼ (arrow) buttons to select **On**.
- 4 Press the **EXIT** button.

## Adjusting the picture

### Selecting the picture mode

You can select your desired picture settings from the modes described below.

<b>Mode:</b>	<b>Description:</b>
AutoView®	Automatically adjusts multiple picture settings including Brightness, Contrast, Gamma, and Sharpness based on ambient room light conditions and incoming picture content to create the best possible picture settings without any manual adjustment.
Dynamic	Maximizes Contrast, Color Saturation, Sharpness, Gray Scale and Brightness to create more vivid and dynamic images
Standard	Standard picture settings
Movie	Lower contrast for a darkened room
Game	Optimized for playing video games by displaying the images in their purest form (4:4:4) without the loss of color information. The result is superior image quality and shorter signal to screen time for a faster gaming experience.
PC	Optimized for viewing your personal computer.

- NOTE**
- ❖ PC mode is available for HDMI™ and PC inputs only (not displayed for other input sources).
  - ❖ Game Mode is not available in ANT/CABLE input.

- 1 Press the **SETUP** button.
  - 2 Select **Picture** > **Picture Mode** and press the **OK** button.
  - 3 Press the ▲/▼ (arrow) buttons to select a mode.
  - 4 Press the **EXIT** button.
- ❖ The picture mode can also be changed by pressing the **PIC MODE** button on the remote control.

- NOTE** The picture mode you select affects the current input only. You can select a different picture mode for each input.

## Adjusting the picture quality

The adjustments you make to picture quality under a picture mode are saved to that picture mode.

<i>Selection</i>	<i>Press (◀)</i>	<i>Press (▶)</i>
Backlight*	Darker	Lighter
Contrast	Lower	Higher
Brightness	Darker	Lighter
Color	Paler	Deeper
Tint	Reddish	Greenish
Sharpness	Softer	Sharper

\*Backlight: Adjusts the brightness of the entire screen. When in video mode and no signal is input, this selection is set to 0. (Settings are stored in memory.)

**NOTE** Some settings cannot be adjusted when the picture mode is set to AutoView.

### To adjust the picture quality:

- 1 Press the **SETUP** button.
- 2 Select **Picture** and press the **OK** button.
- 3 Press the ▲/▼ (arrow) buttons to select the setting you would like to adjust (**Backlight**, **Contrast**, **Brightness**, **Color**, **Tint**, or **Sharpness**).
- 4 Press the ▶ (arrow) button.
- 5 Press the ◀/▶ (arrow) buttons to adjust the setting.
- 6 Press the **EXIT** button.

**NOTE**

- ❖ Any picture settings that you adjust affect the current input only. You can adjust the picture quality separately for each input.
- ❖ Depending on a Sharpness value, the Resolution+ effect may be reduced.

### To reset to the factory defaults:

- 1 Press the **SETUP** button.
- 2 Select **Picture > Reset**.
- 3 Press the **OK** button.  
A confirmation screen appears.
- 4 Press the ◀/▶ (arrow) buttons to select **Yes**, and then press **OK**.

## Using the advanced picture settings features

**NOTE** Some of the Advanced Picture Settings features will not be available for adjustment when the picture mode is set to AutoView.

### Resolution+

If the **Resolution+** set to **On** (this is the default), the clarity levels can be adjusted automatically.

- 1 Press the **SETUP** button.
- 2 Select **Picture > Advanced Picture Settings > Resolution+** and press the **OK** button.
- 3 Press the **▲/▼** (arrow) buttons to select **On**.
- 4 Press the **EXIT** button.

**NOTE**

- ❖ If the picture mode is set to **AutoView**, **Resolution+** is not available.
- ❖ This feature may not work properly depending on the content.
- ❖ Noise may appear on the image depending on the device connected to the TV (e.g. a device with a specific enhancer function).

### Dynamic Contrast

Dynamic Contrast detects changes in picture quality that affect the appearance of your contrast settings and then automatically adjusts the video.

- 1 Press the **SETUP** button.
- 2 Select **Picture > Advanced Picture Settings > Dynamic Contrast** and press the **OK** button.
- 3 Press the **▲/▼** (arrow) buttons to select **High, Middle, Low, or Off**.
- 4 Press the **EXIT** button.

### DynaLight®

The DynaLight® dynamic backlight control monitors the brightness of each video frame and automatically adjusts backlight intensity based on the content to create higher dynamic contrast, for deeper blacks and increased depth.

- 1 Press the **SETUP** button.
- 2 Select **Picture > Advanced Picture Settings > DynaLight** and

press the **OK** button.

- 3 Press the **▲/▼** (arrow) buttons to select **On** or **Off**.
- 4 Press the **EXIT** button.

## ClearScan®

ClearScan® 240Hz uses both frame interpolation technology and advanced backlight control with image synchronization to quadruple the TV refresh rate for an even clearer fast motion video.

- 1 Press the **SETUP** button.
- 2 Select **Picture > Advanced Picture Settings > ClearScan** and press the **OK** button.
- 3 Press the **▲/▼** (arrow) buttons to select **Cinema, Smooth, Standard, or Off**.
- 4 Press the **EXIT** button.

---

**NOTE** If the picture mode is set to **Game** or **PC** mode, this feature is automatically not available.

---

## MPEG NR

The MPEG noise reduction feature allows you to reduce visible interference caused by MPEG compression.

- 1 Press the **SETUP** button.
- 2 Select **Picture > Advanced Picture Settings > Noise Reduction** and press the **OK** button.
- 3 Press the **▲/▼** (arrow) buttons to select **MPEG NR** and press the **OK** button.
- 4 Press the **▲/▼** (arrow) buttons to select **Low, Middle, High, or Off**.
- 5 Press the **EXIT** button.

---

**NOTE** If the picture mode is set to **Game** or **PC**, this feature is not available.

---

## DNR

DNR is a Dynamic Noise Reduction technology that filters out video noise without decreasing picture sharpness for clean, crystal-clear images.

- 1 Press the **SETUP** button.
- 2 Select **Picture > Advanced Picture Settings > Noise Reduction**

and press the **OK** button.

- 3 Press the ▲/▼ (arrow) buttons to select **DNR** and press the **OK** button.
  - 4 Press the ▲/▼ (arrow) buttons to select **Low**, **Middle**, **High**, **Auto**, or **Off**.
  - 5 Press the **EXIT** button.
- 

**NOTE**

The differences may not always be noticeable. For the best results, use lower settings, as picture quality may be greatly reduced if the setting is too high.

If the picture mode is set to **Game** or **PC**, this feature is not available.

---

### Ambient Light Sensor

When the ambient light function of **Auto Brightness Sensor** is set to **On**, the TV optimizes the backlighting levels to suit ambient light conditions.

- 1 Press the **SETUP** button.
  - 2 Select **Picture** > **Advanced Picture Settings** > **Auto Brightness Sensor Settings** and press the **OK** button.
  - 3 Press the ▲/▼ (arrow) buttons to select **On** or **Off**.
  - 4 Press the **EXIT** button.
- 

**NOTE**

When the picture mode is set to **AutoView**<sup>®</sup>, this feature is automatically set to **On**.

---

### ColorMaster™

The ColorMaster™ feature allows you to adjust standard colors.

- 1 Press the **SETUP** button.
- 2 Select **Picture** > **Advanced Picture Settings** > **ColorMaster** and press the **OK** button.
- 3 Press the ▲/▼ (arrow) buttons to select **On** or **Off**.
- 4 Press the **EXIT** button.



## Base Color Adjustment

When ColorMaster™ is set to **On**, the list of base colors appears.

You can select a base color to adjust.

- 1 Press the **SETUP** button.
- 2 Select **Picture > Advanced Picture Settings > Base Color Adjustment**.
- 3 Press the **OK** button.  
The **Base Color Adjustment** screen appears.
- 4 Press the ▲/▼ (arrow) buttons to select a color. Press the ► (arrow) button.
- 5 Press the ◀/▶ (arrow) buttons to select **Hue**, **Saturation**, or **Brightness**.
- 6 Press the ▲/▼ (arrow) buttons to adjust the setting.
- 7 Repeat Steps 4 through 6 to adjust other colors. To reset the adjustments to the factory defaults, select **Reset** on the screen, and then press the **OK** button. (A confirmation screen appears. Press the ◀/▶ (arrow) buttons to select **Yes**, and then press the **OK** button.)

## Color temperature

- 1 Press the **SETUP** button.
- 2 Select **Picture > Advanced Picture Settings > Color Temperature** and press the **OK** button.
- 3 Select **Color Temperature** and press the **OK** button. Press the ▲/▼ (arrow) buttons to select **Cool**, **Medium**, or **Warm**.
- 4 Press the **OK** button.
- 5 Select **Color Temperature** and press the **OK** button. Press the ▲/▼ (arrow) buttons to select the **Red Level**, **Green Level**, or **Blue Level**.
- 6 Press the ► (arrow) button.
- 7 Press the ◀/▶ (arrow) buttons to adjust the level. The adjustment range is -10 (less of selected color) to +10 (more of selected color).
- 8 Press the **EXIT** button.

---

**NOTE** This feature is not available in Standard and Movie mode.

---

### Fine Texture Restoration

This feature allows you to adjust fine texture of the picture.

- 1 Press the **SETUP** button.
  - 2 Select **Picture > Advanced Picture Settings > Fine Texture Restoration**.
  - 3 Press the **OK** button. **Fine Texture Restoration** screen appears.
  - 4 Press the **▲/▼** (arrow) buttons to select **Auto** or the picture texture level (1 to 10).
  - 5 Press the **EXIT** button.
- 

**NOTE** This feature should normally be set to Auto.

---

### Brilliance Restoration

This feature allows you to adjust the picture brilliance.

- 1 Press the **SETUP** button.
  - 2 Select **Picture > Advanced Picture Settings > Brilliance Restoration**.
  - 3 Press the **OK** button. **Brilliance Restoration** screen appears.
  - 4 Press the **▲/▼** (arrow) buttons to select **Auto** or the picture brilliance level (1 to 10).
  - 5 Press the **EXIT** button.
- 

**NOTE** This feature should normally be set to Auto.

---

### 3D Judder Cancellation

This feature will reduce 3D images blur without adding flicker.

- 1 Press the **SETUP** button.
  - 2 Select **Picture > Advanced Picture Settings > 3D Judder Cancellation**.
  - 3 Press the **OK** button. **3D Judder Cancellation** screen appears.
  - 4 Press the **▲/▼** (arrow) buttons to select **Auto** or **Off**.
  - 5 Press the **EXIT** button.
- 

**NOTE** When Picture Mode is set to Game, this feature will be grayed out and automatically set to Off.

---

**Resetting to the factory default**

- 1** Press the **SETUP** button.
- 2** Select **Picture > Advanced Picture Settings > Reset**.
- 3** Press the **OK** button.  
A confirmation screen appears.
- 4** Select **Yes**, and then press the **OK** button.

## Setting the expert picture settings

**NOTE** This feature is only available in Standard and Movie mode.

### Test Pattern

When the test pattern is on screen, you can navigate the Picture submenus without removing the image. When you move to a non-Picture menu, or close the menus, regular video will be restored.

- 1 Press the **SETUP** button.
- 2 Select **Picture > Expert Picture Settings > Test Pattern** and press the **OK** button.
- 3 Press the **▲/▼** (arrow) buttons to select **On**.
- 4 Adjust picture settings.

**NOTE** When the TV is in 2D to 3D mode or 3D mode, this feature is not available.

### RGB Filter

This feature individually enables or disables the red, green, and blue components of the picture to allow for more accurate adjustment of each color.

- 1 Press the **SETUP** button.
- 2 Select **Picture > Expert Picture Settings > RGB Filter** and press the **OK** button.
- 3 Press the **▲/▼** (arrow) buttons to select **Red, Green, or Blue** to adjust.
- 4 Press the **▶** (arrow) button.
- 5 Press the **▲/▼** (arrow) buttons to select **On**, and then press the **OK** button.
- 6 Press the **▼** (arrow) button to select **Color** or **Tint**, press the **◀/▶** (arrow) buttons to adjust.
- 7 Press the **EXIT** button.

**NOTE** It is not possible to turn off all three colors simultaneously.

## White Balance

### Window Display

This feature displays the Window Pattern to adjust the white balance.

- 1 Press the **SETUP** button.
- 2 Select **Picture > Expert Picture Settings > White Balance** and press the **OK** button.
- 3 Press the **▲/▼** (arrow) buttons to select **Window Display** and press the **OK** button.
- 4 Press the **▲/▼** (arrow) buttons to select **On**.
- 5 Adjust the picture settings.

### Setting Type

You can adjust the white balance setting.

#### 2P White Balance:

- 1 Press the **SETUP** button.
- 2 Select **Picture > Expert Picture Settings > White Balance > Setting Type** and press the **OK** button.
- 3 Press the **▲/▼** (arrow) buttons to select **2P** and then press the **OK** button.
- 4 Press the **▲/▼** (arrow) buttons to select **2P White Balance** and press the **OK** button.
- 5 Press the **▲/▼** (arrow) buttons to select **Red-Offset, Green-Offset, Blue-Offset, Red-Gain, Green-Gain, or Blue-Gain**.
- 6 Press the **▶** (arrow) button.
- 7 Press the **◀/▶** (arrow) buttons to adjust.

#### 10P White Balance:

- 1 Press the **SETUP** button.
- 2 Select **Picture > Expert Picture Settings > White Balance > Setting Type** and press the **OK** button.
- 3 Press the **▲/▼** (arrow) buttons to select **10P** and then press the **OK** button.
- 4 Press the **▲/▼** (arrow) buttons to select **10P White Balance** and press the **OK** button.
- 5 Press the **▲/▼** (arrow) buttons to select **IRE, Red, Green, or Blue**.
- 6 Press the **▶** (arrow) button.
- 7 Press the **◀/▶** (arrow) buttons to adjust.

## Adjusting the audio

### Muting the sound

Press the **MUTE** button to partially reduce (1/2 Mute) or turn off (Mute) the sound. Each time you press the **MUTE** button, the mute mode changes in the following order: 1/2 Mute, Mute, Volume, 1/2 Mute, etc.

**NOTE** If you modify items in the **Sound** menu while Mute is active, Mute is cancelled.

### Selecting stereo/SAP broadcasts

The MTS (multi-channel TV sound) feature is only available for analog signals on the ANT/CABLE input. When the TV receives a stereo or **SAP** (second audio program) broadcast, the icon **STEREO** or **SAP** appears on screen when the **INFO** button is pressed.

#### To listen in stereo sound:

- 1 Press the **SETUP** button.
- 2 Select **Sound** > **MTS** and press the **OK** button.
- 3 Press the **▲/▼** (arrow) buttons to select **Stereo**.
- 4 Press the **EXIT** button.

**NOTE**

- ❖ You can typically leave the TV in Stereo mode because it outputs the type of sound being broadcast (stereo or monaural).
- ❖ If the sound is noisy, select **Mono**.
- ❖ If there is no sound in **SAP** mode, select **Stereo**.

### Adjusting the audio balance

You can adjust the audio balance.

- 1 Press the **SETUP** button.
- 2 Select **Sound** > **Balance** and press the **OK** button.
- 3 Press the **◀/▶** (arrow) buttons to adjust the balance.
- 4 Press the **EXIT** button.

### Adjusting the range

You can adjust bass and treble.

- 1 Press the **SETUP** button.
- 2 Select **Sound** > **Bass** or **Treble**.

- 3 Press the **OK** button.
- 4 Press the ◀/▶ (arrow) buttons to adjust the range.
- 5 Press the **EXIT** button.

## TV Speakers On/Off

This feature allows you to turn the TV speakers off when connecting the audio system.

- 1 Press the **SETUP** button.
- 2 Select **Sound > TV Speakers** and press the **OK** button.
- 3 Press the ▲/▼ (arrow) buttons to select **On** or **Off**.

**To turn on the built-in speakers:**

- 1 Choose **On** in step 3 above.

## Setting the Primary Audio Language

You can set the Primary Audio Language of the digital broadcast.

- 1 Press the **SETUP** button.
- 2 Select **Sound > Primary Audio Language** and press the **OK** button.
- 3 Press the ▲/▼ (arrow) buttons to select **English**, **Français**, or **Español**.
- 4 Press the **EXIT** button.

## Selecting the optical audio output format

You can select the optical audio output format when you connect a Dolby® Digital decoder or other digital audio systems to the TV's DIGITAL AUDIO OUT terminal.

### Audio Format

- 1 Press the **SETUP** button.
- 2 Select **Sound > Digital Audio Output > Audio Format** and press the **OK** button.
- 3 Press the ▲/▼ (arrow) buttons to select **Auto** or **PCM**.
- 4 Press the **EXIT** button.

### Audio Delay

- 1 Press the **SETUP** button.
- 2 Select **Sound > Digital Audio Output > Audio Delay** and press the **OK** button.

- 3 Press the ▲/▼ (arrow) buttons to select **Auto** or **Manual**.
 

**Auto:** This mode automatically adjusts the audio timing to meet the video timing.  
The time lag might be large between the image and sound depending on the connected equipment (amplifier etc.). In that case, select Manual.

**Manual:** You can manually adjust the audio signal timing to meet the video signal timing.
- 4 Press the **EXIT** button.

### Delay Adjustment

- 1 Press the **SETUP** button.
- 2 Select **Sound > Digital Audio Output > Delay Adjustment** and press the **OK** button.
- 3 Press the ◀/▶ (arrow) buttons to adjust the audio signal timing (0 – 250ms) to meet the video signal timing.
- 4 Press the **EXIT** button.

### NOTE

- ❖ This feature is grayed out when **Audio Delay** is in **Auto**.
- ❖ A time lag will occur when the video signal or audio signal is changed. Adjust the timing accordingly.
- ❖ When adjusting the timing, turn down the volume of the AV equipment used as far as possible.  
Depending on the equipment, noise etc. may occur when the signal is changed.
- ❖ Depending on the connected equipment (amplifier, etc.), adjustment may not be possible.
- ❖ When the optical audio output setting (**Auto** ↔ **PCM**) is changed, it may be necessary to adjust the timing again.
- ❖ Do not use other than for audio output from the AV amplifier, etc. (Malfunction may occur)

### Using the Dolby® Digital Dynamic Range Control feature

You can further compress Dolby® Digital and Dolby® Digital Plus dynamic range so you can switch from digital to analog broadcasts at the same dynamic range.

- 1 Press the **SETUP** button.
- 2 Select **Sound > Dynamic Range Control** and press the **OK** button.
- 3 Press the ▲/▼ (arrow) buttons to select **On**.



**NOTE** This feature is available when Dolby® Digital or Dolby® Digital Plus is input to the TV in the following situations:

- ❖ When tuned to a digital RF channel
- ❖ When an HDMI™ input is used

This feature is automatically set to **Off** when **Dynamic Volume** (Audyssey Dynamic Volume®) is set to **Day** or **Night**.

This feature will also affect **Digital Audio Output** when the optical audio output format is set to **PCM**.

## Audyssey Premium Television™

These televisions use a suite of technologies for better sound including:

- ❖ Audyssey EQ®—provides clear, accurate and natural sound right out of the box. This technology ensures you enjoy your audio experience as much as your video.
- ❖ Audyssey ABX™—technology uses sophisticated driver analysis and low frequency monitoring to extend the range and bass of small speakers. This enables the system to produce lower frequencies than would be possible with a traditional system of the same size.
- ❖ Audyssey Dynamic Volume®—automatically adjusts volume to provide a consistent sound level between television programs, commercials, and between the loud and soft passages of movies.
- ❖ Audyssey Volume Extension®—doubles the volume capability in small speakers while blocking distortion so your TV gets loud and still sounds great.
- ❖ Day/Night Modes—automatically keeps the volume of the TV at the perfect level for day or night.
- ❖ Wall/Table Modes—automatically keeps the volume at the perfect level for television mounted on a wall or located on a table-top.

## Using Audyssey EQ® for Wall Mounted or Table-top TVs

This feature automatically keeps the volume at the perfect level for television mounted on a wall or located on a table-top.

- 1 Press the **SETUP** button.
- 2 Select **Sound > Audyssey Premium Television > TV Mounting** and press the **OK** button.
- 3 Press the **▲/▼** (arrow) buttons to select **Wall** or **Table**.

## Using Audyssey Dynamic Volume®

This feature provides a consistent sound volume between television programs, commercials, and between the loud and soft passages of movies.

- 1 Press the **SETUP** button.
- 2 Select **Sound > Audyssey Premium Television > Dynamic Volume** and press the **OK** button.
- 3 Press the **▲/▼** (arrow) buttons to select **Night, Day, or Off**.

### NOTE

- ❖ If **Dynamic Range Control** is set to **On**, this feature is automatically set to **Off**.
- ❖ This feature does not affect the audio signal output from the DIGITAL AUDIO OUT terminal.

## Audyssey ABX™

Audyssey ABX™ technology uses sophisticated driver analysis and low frequency monitoring to extend the range and bass of small speakers.

### To turn on Audyssey ABX™:

- 1 Press the **SETUP** button.
- 2 Select **Sound > Audyssey Premium Television > Audyssey ABX** and press the **OK** button.
- 3 Press the **▲/▼** (arrow) buttons to select **Off, Low, or High**.

Audyssey EQ® and Audyssey Volume Extension® are default settings that are set to **On**.

## Using the surround sound feature

Surround settings help to create a thrilling surround sound experience with deep, rich bass from stereo sound sources. Your TV's audio will sound fuller, richer, and wider.

- ❖ Press the **SETUP** button. Select **Sound > Surround**, and then select **On** or **Off**.

# Chapter 8

## Advanced features

---

### Using your home network

- ❖ This TV can share videos, music, and photos across your home network and other connected products through the MediaShare feature. In order to do this, you will have to configure the network settings on your TV, see [“MediaShare \(Videos, Music, and Photos\)” on page 157](#).
- ❖ If you want to use your home network with an Internet connection, you will have to configure the network settings on your TV. If necessary, change the network settings, see [“Setting up the Network” on page 129](#).

If you use Internet services, see the following note before use.

---

**NOTE** Third party Internet services are not provided by Toshiba, may change or be discontinued at any time, and may be subject to third party restrictions. Toshiba makes no warranties, representations, or assurances about the content, availability, or functionality of third party content or services. Third party Internet services may require the creation of a separate account through a computer with Internet access, and payment of one-time and/or recurring charges.

---

Certain features currently not available in Mexico.

## **When using a Wireless network connection**

### **Wireless LAN and your Health:**

Wireless LAN products, like other radio devices, emit radio frequency electromagnetic energy. However, the level of energy emitted by Wireless LAN devices is much less than the electromagnetic energy emitted by wireless devices like mobile phones.

Because Wireless LAN products operate within the guidelines found in radio frequency safety standards and recommendations, Toshiba believes Wireless LAN is safe for use by consumers. These standards and recommendations reflect the consensus of the scientific community and result from deliberations of panels and committees of scientists who continually review and interpret the extensive research literature.

In some situations or environments, the use of Wireless LAN may be restricted by the proprietor of the building or responsible representatives of the organization. Such restrictions may apply in environments where the risk of interference to other devices or services is perceived or identified as harmful.

If you are uncertain of the policy that applies to the use of wireless devices in a specific organization or environment, you are encouraged to ask for authorization to use the Wireless LAN device prior to turning on the equipment.

### **Using the TV in a wireless LAN environment:**

- ❖ It is recommended to use IEEE 802.11a or IEEE 802.11n on 5 GHz for audio and SD video streaming.
- ❖ It is recommended to use IEEE 802.11n on 5 GHz for HD video streaming.
- ❖ It is recommended that the encoding rate of video content be 20 Mbps or less.
- ❖ It is not recommended to use 2.4 GHz for audio and video streaming.
- ❖ Content playback may be interrupted by surrounding interference.

## Setting up the Network

You can select the Network Type.

- 1 Press the **SETUP** button.
- 2 Select **Network > Network Setup > Connection Type** and press the **OK** button.
- 3 Press the **▲/▼** (arrow) buttons to select **Wired** or **Wireless**.
- 4 Press the **OK** button.
  - ❖ If you select **Wired**, see “[Advanced Network Setup](#)” on page 134.
  - If you select **Wireless**, see the next section.

## Wireless Setup

---

**NOTE** Continued AP (Access Point) connection is not guaranteed. Connection may be lost while watching TV.

---

There are three methods for wireless setup:

- ❖ Easy Setup (WPS or PIN)  
If AP supports WPS, this can be used.
  - ❖ WPS is a standard designed to simplify the connection of wireless LAN equipment and the setup of network security features.
- ❖ Assisted Setup (setup using the AP's notification information)  
Network Name, Authentication, and Encryption are decided based on information from the AP. You need to manually set the Security Key.
- ❖ Manual Setup  
Requires manually entering all settings.

---

**NOTE**

- ❖ In order to secure your home network, it is strongly recommended that you use a wireless access point with encryption.
- ❖ When Encryption is set to “None”, data transmitted over a wireless LAN is not securely protected. Unauthorized users may access your data and network without appropriate security measures. Selecting an encryption setting from your Toshiba TV and using a secure network for wireless LAN transmissions may help avoid unauthorized access to your important data and/or TV. Toshiba disclaims any and all responsibility or liability resulting from any wireless transmissions over the Internet through your Toshiba TV.

---

### Easy Setup using PBC (Push button configuration)

- 1 Press the **SETUP** button.
- 2 Select **Network > Network Setup > Wireless Setup** and press the **OK** button
- 3 Press the **▲/▼** (arrow) buttons to select **Easy Setup** and press the **OK** button.
- 4 Press the **▲/▼** (arrow) buttons to select **PBC**.
- 5 Press the **▼** (arrow) button to select **Start Scan**, and then press the **OK** button.
- 6 Following the on-screen instructions, push the appropriate button on your AP.
- 7 When a screen reporting that “the setup has succeeded” appears, press the **OK** button.

#### To cancel searching for the AP:

- ❖ Press the **BACK** button while searching for the AP. A message appears. Press the **◀/▶** (arrow) buttons to select **Yes**, and then press the **OK** button.

### Easy Setup using PIN (Personal Identification Number)

- 1 Press the **SETUP** button.
- 2 Select **Network > Network Setup > Wireless Setup** and press the **OK** button.
- 3 Press the **▲/▼** (arrow) buttons to select **Easy Setup** and press the **OK** button.
- 4 Press the **▲/▼** (arrow) buttons to select **PIN**.
- 5 Press the **▼** (arrow) button to select **Start Scan**, and then press the **OK** button.  
The Scan screen appears.
- 6 Enter the PIN displayed on this screen into your computer or AP.
- 7 Press the **▲/▼** (arrow) buttons to select the desired AP, and then press the **OK** button.

---

**NOTE** Check the MAC address on the label or in the manual of the AP and select an AP.

---

- 8 When a screen reporting that “the setup succeeded” appears, press the **OK** button.

**To cancel searching for the AP:**

- ❖ Press the **BACK** button while searching for the AP. A message appears. Press the ◀/▶ (arrow) buttons to select **Yes**, and then press the **OK** button.

**Assisted Setup**

- 1 Press the **SETUP** button.
- 2 Select **Network > Network Setup > Wireless Setup** and press the **OK** button.
- 3 Press the ▲/▼ (arrow) buttons to select **Assisted Setup** and press the **OK** button.
- 4 Press the ▲/▼ (arrow) buttons to select the desired AP, and then press the **OK** button.

---

**NOTE** Check the MAC address on the label or in the manual of the AP and select an AP.

---

- 5 Select **Security Key**, and then press the **OK** button. The Software Keyboard appears.
- 6 Input the Security Key using the Software Keyboard. For more information, see “Using the software keyboard” on page 137.
- 7 To save your settings, press the **GREEN** button.

---

**NOTE** The Security Key must adhere to the following conditions:

- ❖ TKIP/AES: 8-63 ASCII or 64 Hex characters
- ❖ WEP: 5 or 13 ASCII or 10 or 26 Hex characters

---

- 8 Select **Done**, and then press the **OK** button.

---

**NOTE** Settings are not saved if the **BACK** button is pressed before Done is selected.

---

**Manual Setup**

- 1 Press the **SETUP** button.
- 2 Select **Network > Network Setup > Wireless Setup** and press the **OK** button.
- 3 Press the ▲/▼ (arrow) buttons to select **Manual Setup**, and then press the **OK** button.

- 4 Press the ▲/▼ (arrow) buttons to select **Network Name**, and then press the **OK** button.  
The Software Keyboard window appears.
- 5 Input the Network Name using the Software Keyboard. For more information, see [“Using the software keyboard” on page 137](#).
- 6 To save your settings, press the **GREEN** button.
- 7 Press the ▲/▼ (arrow) buttons to select **Authentication** and press the **OK** button.  
Press the ▲/▼ (arrow) buttons to select **Open System, Shared Key, WPA-PSK, or WPA2-PSK**.
- 8 Press the ▲/▼ (arrow) buttons to select **Encryption** and press the **OK** button.  
Press the ◀/▶ (arrow) buttons to select **None, WEP, TKIP, or AES**.

---

**NOTE** Certain encryption types are only compatible with specific authentication types.

- ❖ When Authentication is Open System and Shared Key, only WEP or None are compatible.
- ❖ When Authentication is WPA-PSK or WPA2-PSK, only TKIP or AES are compatible.

When incompatible Authentication/Encryption pairings are attempted, a warning message will be displayed, and no connection attempt will be made until the incompatibility is resolved.

---

- 9 Press the ▲/▼ (arrow) buttons to select **Security Key**, and then press the **OK** button.  
The Software Keyboard window appears.
- 10 Input the Security Key using the Software Keyboard. For more information, see [“Using the software keyboard” on page 137](#).
- 11 To save your settings, press the **GREEN** button.

---

**NOTE** This item is grayed out when Encryption is set to None.

---

- 12 Select **Done**, and then press the **OK** button.  
When Encryption is set to **None**, a message appears.
- 13 Press the ◀/▶ (arrow) buttons to select **Yes**, and then press the **OK** button.



**NOTE** Settings are not saved if the **BACK** button is pressed before Done is selected.

## Wireless Information

The settings configured in Wireless Setup can be confirmed.

- 1 Press the **QUICK** button.
- 2 Select **Wireless Information**, and then press the **OK** button.
- 3 Press the **RED** button to check the availability of surrounding APs. A Wireless Information screen appears when a connection is successfully made.

<i>Item:</i>	<i>Description:</i>
Status	The message, "Connected" appears when the TV is connected to the AP The message, "Disconnected" appears when the TV is disconnected from the AP
Signal	Connection signal strength with the AP (STRONG/MEDIUM/WEAK)
Speed	The link speed with the AP
Mode	Working mode (11a, 11b, 11g, 11n)
Channel	The channel in use (1-165)
Network name	SSID set
Authentication	Authentication set
Encryption	Encryption set
Security key	Security Key set
AP MAC address	The AP's MAC address appears when the TV is connected to the AP
TV MAC address	The TV's MAC address
DHCP	The message, "Enabled" appears when you use DHCP. The message, "Disabled" appears when you do not use DHCP.
IP address	The TV's IP address
Subnet Mask	Value of the Subnet Mask
Default Gateway	Default GATEWAY's address
DNS	DNS's address

**NOTE** Even if an AP for IEEE 802.11n is used when Encryption is set to WEP or TKIP, the Speed value might be low. We recommend that the Encryption setting are changed to AES (Under manual setup).

---

## Advanced Network Setup

---

**NOTE** When manually setting the IP Address, set **Auto Setup** to **Off**.

---

### IP Address Setup

---

**NOTE** The settings in Auto Setup are linked to those selected in the DNS Setup menu. If Auto Setup is set to On, then Auto Setup in the DNS Setup menu will also be set to On.

---

#### Auto Setup:

- 1 Press the **SETUP** button.
  - 2 Select **Network > Network Setup > Advanced Network Setup** and press the **OK** button.
  - 3 Press the **▲/▼** (arrow) buttons to select **IP Address Setup**, and then press the **OK** button.
  - 4 Press the **▲/▼** (arrow) buttons to select **Auto Setup** and press the **OK** button.
  - 5 Press the **▲/▼** (arrow) buttons to select **On**.
- 

**NOTE** Other items are grayed out when **Auto Setup** is set to **On**.

---

#### Manual Setup:

- 1 Press the **SETUP** button.
- 2 Select **Network > Network Setup > Advanced Network Setup** and press the **OK** button.
- 3 Press the **▲/▼** (arrow) buttons to select **IP Address Setup**, and then press the **OK** button.
- 4 Press the **▲/▼** (arrow) buttons to select **Auto Setup** and press the **OK** button.
- 5 Press the **▲/▼** (arrow) buttons to select **Off**.
- 6 Press the **▲/▼** (arrow) buttons to select **IP Address**.
- 7 Press the **◀/▶** (arrow) buttons to select the **IP Address** field and use the 0-9 buttons to enter in a digit. Press the **▶** (arrow) button to select the subsequent fields. To save the setting, press the **OK** button.

---

**NOTE** IP address field numbers must be between 0 and 255. If you input an incompatible number and press the **OK** button, the field number will be reset to the previous value.

---

- 8 Press the ▲/▼ (arrow) buttons to highlight **Subnet Mask**, and edit in the same way as IP Address.
  - 9 Press the ▲/▼ (arrow) buttons to highlight **Default Gateway**, and edit in the same way as IP Address.
- 

**NOTE** If you manually set the IP address, you must not use the same IP address with any other device. The IP address you use should be a private address. If you do not know the correct values to use, contact your network administrator or internet service provider.

---

## DNS Setup

---

- NOTE**
- ❖ When the DHCP function of the router connected to this TV is Off, set Auto Setup to Off, and manually set the DNS address(es). Your Internet Service Provider should have provided these to you.
  - ❖ The settings in **Auto Setup** are linked to those selected in the **IP Address Setup** menu. If **Auto Setup** is set to **On**, then **Auto Setup** in the **IP Address Setup** menu will also be set to **On**.
- 

### Auto setup:

- 1 Press the **SETUP** button.
  - 2 Select **Network > Network Setup > Advanced Network Setup** and press the **OK** button.
  - 3 Press the ▲/▼ (arrow) buttons to select **DNS Setup**, and then press the **OK** button.
  - 4 Press the ▲/▼ (arrow) buttons to select **Auto Setup** and press the **OK** button.
  - 5 Press the ▲/▼ (arrow) buttons to select **On**.
- 

**NOTE** Other items are grayed out when **Auto Setup** is set to **On**.

---

### Manual setup:

- 1 Press the **SETUP** button.
- 2 Select **Network > Network Setup > Advanced Network Setup** and press the **OK** button.

- 3 Press the ▲/▼ (arrow) buttons to select **DNS Setup**, and then press the **OK** button.
  - 4 Press the ▲/▼ (arrow) buttons to select **Auto Setup** and press the **OK** button.
  - 5 Press the ▲/▼ (arrow) buttons to select **Off**.
  - 6 Press the ▲/▼ (arrow) buttons to select **Primary DNS Address**.
  - 7 Press the ◀/▶ (arrow) buttons to select the field you want to change, and then use the number buttons to input the Primary DNS Address. To save the setting, press the **OK** button.
- 

**NOTE** DNS address field numbers must be between 0 and 255. If you input an incompatible number and press the **OK** button, the field number will be reset to the previous value.

---

- 8 Press the ▲/▼ (arrow) buttons to select **Secondary DNS Address**, and edit in the same way as Primary DNS Address.

### **MAC Address**

You can view the fixed MAC address for the TV.

- 1 Press the **SETUP** button.
- 2 Select **Network > Network Setup > Advanced Network Setup** and press the **OK** button.
- 3 Press the ▲/▼ (arrow) buttons to select **MAC Address**, and then press the **OK** button.

### **Network Connection Test**

This function checks Internet connectivity.

- 1 Press the **SETUP** button.
  - 2 Select **Network > Network Setup > Network Connection Test**, and then press the **OK** button.  
A message appears to indicate whether the connection was successful or not.
- 

**NOTE** Favorable Network Connection Test results do not guarantee an Internet Connection. Depending on the situation, some Internet features may not be available.

---

To cancel Network Connection Test, press the **EXIT** button while searching for the Internet connection.

## Using the software keyboard

You can enter text using the Software Keyboard.

The Software Keyboard window will appear when you press the **OK** button on a field that accepts character input.

**NOTE** When using the SmartTV features, software keyboard availability depends on the Internet service being accessed.

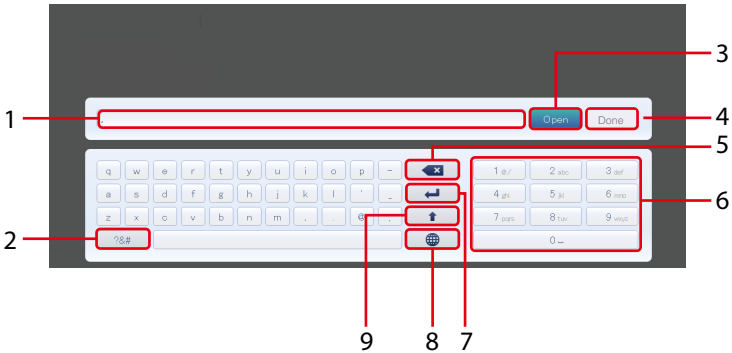

*(Sample Illustration) Software keyboard*

<i>Item:</i>	<i>Description:</i>
1 Text entry field	Press the <b>OK</b> button on this field, caret moving.
2 Symbol	Switches to Symbol characters
3 Open	Displays the Multi Line Input field. If it does not work, the button will be grayed out.
4 Done	Saves whatever text was entered, exits the software keyboard and enters that text into the appropriate text field on the previous screen.
5 Delete	Deletes one character to the left of the cursor
6 Number pad	Inputs numbers. In keypad, these keys are used to select a character for entry.
7 Line Break	Enters the Line Break.
8 Switch Language	Displays the Switch Keyboard Language Popup.
9 Shift	Switches the keyboard layout to capital letters and other symbols.

**Enter text using the software keyboard**

- 1 Highlight the desired character on the on-screen software keyboard.
- 2 Press the **OK** button.
- 3 Repeat Step 1 and 2 until you have entered all desired text.
- 4 Select **Done** or press the **GREEN** button to save your settings and return to the previous screen.

**NOTE** If the **BACK** button is pressed, changes are not saved and the software keyboard window is closed.

Input operation on the remote control:

<b>Item:</b>	<b>Description:</b>
OK	Inputs the selected character
0-9	These keys are used to select a character for entry.
▲/▼/◀/▶	Moves the character highlight
RED	Deletes one character to the left of the cursor
GREEN	Done
YELLOW	Shortcut key for Shift
BLUE	To display the help
BACK	Closes the Software Keyboard window without saving changes

## Performing a Software Upgrade

TOSHIBA may offer upgrades for the TV's software in the future.  
The TV's software is upgraded via the Network.

---

**NOTE** An Internet connection is required.

---

### Before downloading software:

- 1 Configure your TV to connect to the Internet.

---

**NOTE**

- ❖ You will not be able to use the TV set while performing the upgrade.
- ❖ Do not turn off the TV during the upgrade.
- ❖ By upgrading, the factory default values may be changed.

---

- 2 Press the **SETUP** button.
- 3 Select **Get Help > Software Upgrade**.
- 4 Press the **OK** button.  
The Network Upgrade screen appears.
- 5 Press the **OK** button.

---

**NOTE** If the network is not available, a warning message appears.

---

- 6 After a successful download, the TV software upgrade will start automatically.

## Viewing the Software Licenses

The Licenses for the software used in this TV are available for viewing.

- 1 Press the **SETUP** button.
- 2 Select **Get Help > Software Licenses**.
- 3 Press the **OK** button.  
A screen appears displaying all the licensing information required for the television's software.

## Using Intel® WiDi

Intel® Wireless Display (Intel® WiDi) is supported on this TV. Toshiba has also included peer-to-peer wireless technologies to allow direct wireless connection between the TV and Intel® WiDi equipped PC or mobile device. If your PC or mobile device has Intel® WiDi, the Toshiba Cloud TV will allow you to display the small screen content on the big screen quickly and easily.

- 1 Press the **QUICK** button to open the **Quick Menu**.
- 2 Press the **▲/▼** (arrow) buttons to select **Intel® WiDi** and then press the **OK** button.  
A prompt will appear on the screen when **Connection Type** is set to **Wireless**. Select **Yes**.
- 3 Launch the Intel® WiDi software on your device and select “scan for available adaptors”.

Intel® WiDi device name and ID list will then be displayed on the device screen.

Select the TV which you wish to connect to.

“Connecting” will be shown on the TV.

- 4 **Connecting your PC to the TV the first time**  
When selecting the Toshiba TV for the first time, a 4-digit or 8-digit code will appear on your TV screen. This code needs to be inputted into your computer to authenticate the connection.

### **If authentication has already taken place**

“Please Wait” will appear on screen.

- 5 After the Intel® WiDi connection is complete, the TV screen will mirror the content shown on the device screen.

---

### **NOTE**

- ❖ When connecting Intel® WiDi, device must have power turned on.
- ❖ When the TV Network Settings are set to Wireless and Intel® WiDi software is starting up, other TV applications cannot be used.
- ❖ Intel® WiDi device name of the TV can be changed from the Intel® WiDi software.

---

### **To exit Intel® WiDi:**

Exit Intel® Wireless Display by pushing the disconnect button on Intel® WiDi software on the device or by pressing the **EXIT** button on the TV remote control.



---

**NOTE** If the device has been inactive for some time, the Intel® WiDi connection will be disconnected automatically.

---

## Changing the Intel® WiDi Device Name

The TV's Intel® WiDi device name can be changed.

- 1 Press the **SETUP** button.
- 2 Select **Network > Network Device Setup > Intel® WiDi Setup** and press the **OK** button.
- 3 Press the **▲/▼** (arrow) buttons to select **Intel® WiDi Device Name** and press the **OK** button.
- 4 Select the **Intel® WiDi Device Name** and press the **OK** button. The Software Keyboard window will appear.
- 5 Input the Intel® WiDi device name by using the software keyboard. Press the **GREEN** button.
- 6 Select **Done** and press the **OK** button to save your setting.

## Device List

Device List displays a list of MAC addresses for previously connected device that have been connected before. The maximum number that can be stored is 20.

If the list run out of space, the least-recently-used MAC address will be deleted and the new MAC address added automatically.

- 1 Press the **SETUP** button.
- 2 Select **Network > Network Device Setup > Intel® WiDi Setup** and press the **OK** button.
- 3 Press the **▲/▼** (arrow) buttons to select **Device List** and press the **OK** button. Device List will appear.

The registered device can be deleted one by one by pressing the **Red** button in the List.





When doing so the following text can be seen “**Do you want to unregister this device? Yes/No**” (default cursor is “No”).

## Using the Cloud Service

Toshiba's universal portal for Internet content and services. (Services are dependent on country).

**NOTE** You need to connect to the Internet before using this feature, see “Setting up the Network” on page 129.

---

- 1 Press the  button.  
The menu screen of the Cloud TV service is displayed.
- 2 Press the /// to select a Cloud TV service, and press the **OK** button.

## Using the Cloud TV Service features

---

- NOTE**
- ❖ You need to connect to the Internet before using this feature, see “Setting up the Network” on page 129.
  - ❖ Certain services may not be currently available in your area.
  - ❖ User registration or login may be required to use some services.
  - ❖ Third party Internet services are not provided by Toshiba, may change or be discontinued at any time and may be subject to Internet service provider restrictions. Toshiba makes no warranties, representations, or assurances about the content, availability or functionality of third-party content or services. Use of third party Internet services may require the creation of a separate account through a computer with Internet access and/or payment of one-time and/or recurring charges and membership. Not all third party services may be available on or compatible with this product. In order to experience the full suggested capabilities of this product, fully-compatible devices may be required.
- 

- NOTE**
- ❖ If the display of the date and time is wrong, try to turn off the TV, and turn it on again.
  - ❖ The menu items for features like the Apps may change in the upgrade process.
- 

## eMANUAL

The eMANUAL provides on-screen, context-sensitive, instructions that describe the TV features.

To access the eManual, press the **eMANUAL** button on the remote control and select “**eManual**”. Or you can access the eManual through the icon on the Cloud TV Portal pages.

---

**NOTE** An active Internet connection is required to use the eMANUAL feature.

---

## Feature apps

With easier content discovery, Cloud TV puts you closer than ever to the things you love— like Netflix® and Hulu Plus®, along with video on demand, broadcast programming, the Web, even music, photos and videos on your home network.

---

**NOTE** Apps will vary by country and availability may change in the future with respect to current apps.

---

## Netflix®

### Watching movies with Netflix®

- 1 Press the **NETFLIX** on the remote control and select the Netflix® icon.
- 2 Follow the on-screen instructions.

After having activated Netflix® player and prepared an Instant Queue, movies and TV episodes in your Instant Queue will appear on the TV screen. Select the desired content using the remote control.

---

**NOTE**

- ❖ The resolution of video content streamed from Netflix® varies depending on the communication speed and bit-rate and is controlled by Netflix®.
- ❖ Future upgrades can change the screens and messages displayed in the Netflix® feature.
- ❖ Netflix® is supported in the U.S. and Canada, and may not be available in other countries or regions.

---

To close Netflix®, press the **EXIT** button.

### To confirm the Netflix ESN (Electronic Serial Number):

- 1 Press the **SETUP** button.
- 2 Select **Network > Smart Apps Setup > Netflix Setup** and press the **OK** button.
- 3 Press the **▲/▼** (arrow) buttons to select **ESN**, and then press the **OK** button.  
The Netflix ESN screen appears.

### To deactivate your device:

- 1 Press the **SETUP** button.
- 2 Select **Network > Smart Apps Setup > Netflix Setup** and press the **OK** button.

- 3 Press the ▲/▼ (arrow) buttons to select **Deactivation**, and then press the **OK** button.
- 4 Press the ◀/▶ (arrow) buttons to select **Yes**, and then press the **OK** button.

## **VUDU™ HD Movies and VUDU™ Apps**

VUDU™ HD Movies and VUDU™ Apps offer on-demand service that offers high definition movies on the Web and much more.

- 1 Press the ⏪ button  
The menu screen of the Cloud TV service is displayed.
- 2 Press the ◀/▶ (arrow) buttons to select VUDU, and then press the **OK** button.

---

### **NOTE**

- ❖ Use of VUDU™ requires a working broadband Internet connection (1 to 2 Mbps for SD video, 2.25 to 4.5 Mbps for HD video, and 4.5 to 9 Mbps for HDX video).
  - ❖ The message "Buffering..." will display if the speed of your Internet connection can not keep up with the speed of the streaming content from VUDU™.
- 

To close **VUDU**, press the **EXIT** button.

#### **To deactivate your device:**

- 1 Press the **SETUP** button.
- 2 Select **Network > Smart Apps Setup > VUDU Deactivation**.
- 3 Press the **OK** button.
- 4 Press the ◀/▶ (arrow) buttons to select **Yes**, and then press the **OK** button.

## **Internet**

### **Open Web Browser**

The open/web browser with HTML5 video and audio codecs which allow you to explore the web the way you want. Search for, bookmark, and browse your favorite sites to enjoy the content you want, with simple, intuitive navigation.

The web browser on this device:

- ❖ does not support platform-dependent technologies such as ActiveX®.
- ❖ only supports preinstalled plug-ins.
- ❖ may not support media formats other than the following: JPEG / PNG / GIF.

- ❖ uses a single built-in font. Some text may not be displayed as intended.
- ❖ does not support downloading of files or fonts.
- ❖ is a TV browser. It may work differently than PC browsers.
- ❖ does not support parental control or locks in the content, and it is the responsibility of the user to monitor browser usage by minors.

---

**NOTE** Some pages may not be displayed correctly or may display differently on different devices.

---

### Using the web browser

- 1 Connect to the network.
- 2 Press the  button on the remote control to access the web browser page.
- 3 Use the ▲/▼/◀/▶ (arrow) buttons to select to the URL Address Bar and press the **OK** button.
- 4 Enter the desired URL address by using the software keyboard, see “Using the software keyboard” on page 137. Press the **GREEN** button when finished.
- 5 You can now browse websites on your TV using the ▲/▼/◀/▶ (arrow) buttons on the remote control

---

**NOTE**

- ❖ When you press the **GREEN** button while browsing web content, you can use the ▲/▼/◀/▶ (arrow) buttons on the remote control in mouse control mode.
- ❖ You can use the Wireless QWERTY keyboard in addition to the software keyboard.

---

### Browsing favorite websites

- 1 Connect to the network.
- 2 Press the  button on the remote control to access the web browser page.
- 3 Use the ▲/▼/◀/▶ (arrow) buttons to select the Favorites **STAR** icon on the browser menu bar and press the **OK** button.

---

**NOTE** By adding frequently visited websites to Favorites, you can browse them easily.  
You can view the addresses of the websites you visited previously.

---

- 4 Select the item or folders to move to the desired URL address and press the **OK** button.
- 

**NOTE** You can press the **GREEN** button on the remote for thumbnail view of all your favorites.

---

- 5 You can now browse websites on your TV using the ▲/▼/◀/▶ (arrow) buttons on the remote control.
- 

**NOTE** When you press the **GREEN** button while browsing web content, you can use the ▲/▼/◀/▶ (arrow) buttons on the remote control in mouse control mode.

---

### Adding favorite websites

- 1 Connect to the network.
  - 2 Press the  button on the remote control to access the web browser page.
  - 3 Follow “Using the web browser” on page 145 to display your desired website.
  - 4 Press the Navigation buttons to scroll to Favorites STAR on the Browser Menu Bar and press the **OK** button.
- 

**NOTE** By adding frequently visited websites to Favorites, you can browse them easily.  
You can view the addresses of the websites you visited previously.

---

- 5 Press the **OK** button to save the desired website to your favorites.
- 

**NOTE** The desired website is highlighted and displayed on the top row with the + (Add) icon.  
The + (Add) icon will change to a page icon after the website has been saved to favorites.

---

- 6 Press the **BACK** button on the remote to return to browsing your website.

## PIP (Picture-in-picture) function

When viewing the web browser page, currently airing programs or images from external inputs can be displayed in a PIP window (sub-screen).

- 1 Press the **RED** button while viewing the web browser page.  
The currently airing program or images from external inputs are displayed in a PIP window.
  - ❖ The position of the PIP window, and whether it is displayed or not can be set in the web browser Settings.

---

**NOTE** 4k content cannot be displayed in the PIP window.

---

### To stop displaying the PIP window:

Press the **RED** button when the PIP window is displayed.

- 
- NOTE**
- ❖ The **CH ▲/▼** buttons cannot be used when the PIP window is displayed.
  - ❖ Images in the PIP window cannot be displayed in 3D.
  - ❖ Images from 3D signals will not be displayed in the PIP window.
- 

## Using Skype™

Skype™-ready Toshiba TVs bring your family and friends closer to your home. Skype™ on your Toshiba TV allows you to share special moments no matter the distance.

### Before using Skype™ - Preparation

- ❖ Connect the FREETALK HD Camera: TALK-7291 to the TV's USB port. Do not use a USB hub. For a Skype™-ready Toshiba TV compatible camera, please visit the following website: <http://shop.skype.com>
- ❖ Arrange the HD camera on top of the TV, ensuring it's in the center.
- ❖ Connect to the network.

- 
- NOTE**
- ❖ The HD camera is sold separately.
  - ❖ Do not connect a camera other than the recommended HD camera.
  - ❖ Using a wireless network may result in degraded call quality.
  - ❖ Some of the features available on other versions of Skype™ are not available on the television.
  - ❖ When using Skype™, some functions of the TV will not be available.

- ❖ The sound settings are switched to Skype™ mode.
  - ❖ If you cannot hear the person you're speaking with, check your TV volume.
  - ❖ When Optical Digital output or Analog output is used and you are signed in, the ring tone may not sound.
  - ❖ The volume level on Skype™ may differ from other features on your TV.
  - ❖ When the Reset TV feature is used from the TV Menu, Skype™ information is reset to factory default settings.
  - ❖ Screenshots used in this manual may differ from the TV Menu, Skype™ will be reset to its factory default settings.
- 

**⚠ WARNING****No emergency calls with Skype™**

Skype™ cannot be used for emergency calls.

---

## Attaching the HD camera on your TV (for 65L9300U/84L9300U Series only)

When attaching the camera to the TV, use the two sponges (supplied).

---

**NOTE**

Peel off the stickers from the adhesive surfaces of the sponges, and then attach them to the TV.

---

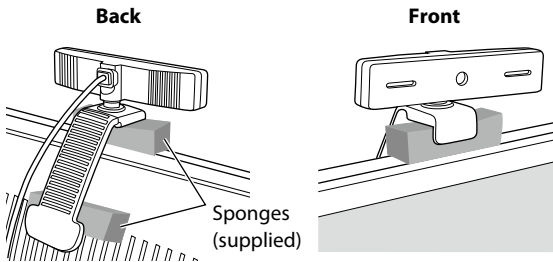

## Getting started

- 1 Press the  button on the remote control.
- 2 Select **Skype** and press the **OK** button.  
“Welcome to Skype” screen appears.





*(Sample Image) Welcome Skype screen*

- 3 Select **Sign in** or **Create Account**.

### To create a new account:

If you do not already have a Skype™ account, you can create a new one from your TV.

- 1 Select **Create Account** in the **Welcome to Skype** screen and press the **OK** button.

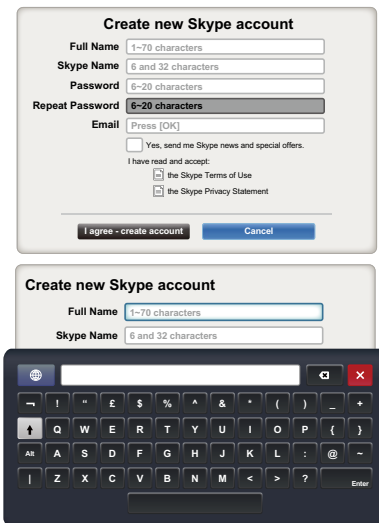

*(Sample Image) Create Account screen*

- 2 Enter your **Full Name**, **Skype Name**, **Password**, **Repeat password**, and **Email**.
  - ❖ If you want to receive Skype™ news and special offers, check the selection box. Skype™ will inform users about new products, features and special offers by email.
- 3 Select **“I agree - create an account”** and press the **OK** button.
- 4 You'll now be signed into your new account.

**NOTE**

- ❖ Please ensure that you have entered your email address correctly. It is required in case you lose or forget your password.
- ❖ If you forget your password, visit [skype.com](http://skype.com) to retrieve it.
- ❖ If a message appears informing you that the entered Skype™ name is already registered, please choose a different name.

## To Sign into Skype™:

If you have a Skype™ account, sign into Skype™ in the **Welcome to Skype** screen.

- 1 Enter your **Skype Name** and **Password**.
- 2 Select **Sign in** and press the **OK** button.
  - ❖ If “Sign in when Skype starts” is checked, your account will sign in automatically when you launch Skype™ from the menu.
  - ❖ If “Start Skype when TV starts” is checked, your account will sign in automatically when you turn on the TV.

## Basic Operation

Press the ▲/▼ (arrow) buttons to select a tab (**Contacts/People**, **Recent**, **Dialer**, or **Settings**). Press the ►/▲/▼ (arrow) buttons to select a contact from the list.

Your contact list will contain the following information:

Contact name / Current online status / Profile picture / Mood message

Your profile picture, status, Skype Name, mood message and available Skype Credit.

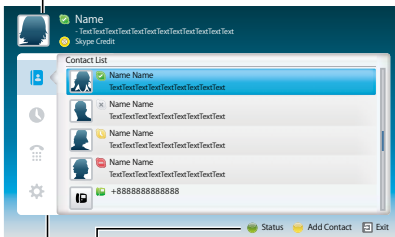

- 🟢 Status: Change your availability status
- 👤 Add Contact: Add a Skype account or phone number
- EXIT:** Return to previous screen. When at contact list, the **EXIT** button will close Skype application without sign out.

The current status for each of your contacts are explained below:

- 🟢 : Online
- ⚪ : Offline
- 🚫 : Do not disturb
- 🟡 : Away
- 📞 : Phone number
- 📞 : Offline with voice messaging or call forwarding enabled

*(Sample Image) Skype™ contact list menu*

## Contacts/People

Press the ▲/▼ (arrow) buttons to select **Contacts** tab. Press the ►/▲/▼ (arrow) buttons to select a contact.

After pressing the **OK** button on each contact, the following functions will be displayed:



### Initiate Video Call

- View Profile - View contact profile (including Skype name, full name, birth date, gender, location, mobile number and email).
- Send Voice Message - Send Voice Message to contact
- Block - Block / unblock contact
- Remove - Remove contact from list

*(Sample Image) Skype™ contact list - select menu*

## Video or Voice call

Press the ▲/▼/◀/▶ (arrow) buttons to select **Video call** or **Voice call**, your screen will now display your call as shown below.

### Video call

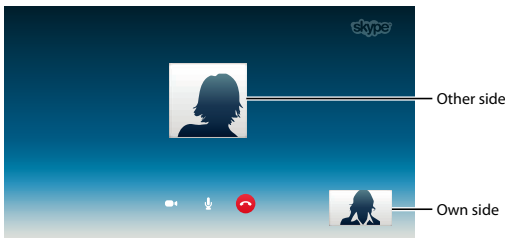



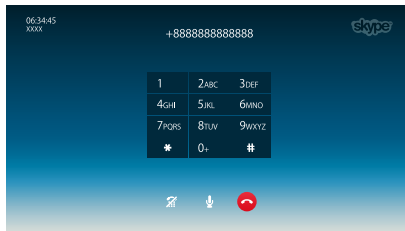





### Voice call



*(Sample Image) Skype™ video/voice call screen*

Below is all icon pictures in conversation window.

-  Start video
-  Stop video
-  Resume the call
-  Unmute the webcam mic
-  Mute the webcam mic
-  Normal size video
-  Full screen video
-  Open dial pad
-  End call ( Hang up the call )

## Group calls

Using your Toshiba TV, you can join Skype™ group voice and video calls. However, you can only send and receive audio while on these calls.

**NOTE** You must be invited on to a group call, you cannot initiate it from the TV.

## Incoming call

Incoming calls on Skype™ will be displayed on the bottom right hand corner of your TV screen. You'll also hear a ring tone which can be adjusted using the **Volume** buttons on your remote control.

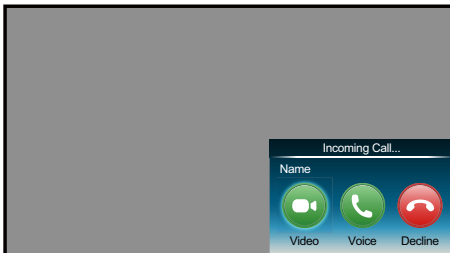

*(Sample Image) Skype™ incoming call menu*

You are given three options when an incoming call arrives:

- ❖ **Video** : Answer by video call.
- ❖ **Voice** : Answer by voice call.
- ❖ **Decline** : Decline the incoming call.

**NOTE** If other applications are active or recording, you'll only get an "Incoming call notification" until the application or recording has stopped.

## Status

When pressing the **GREEN** button, the change status window is displayed as below. You can change your status by pressing the ▲/▼ (arrow) buttons and then pressing the **OK** button. Exit by pressing the **BACK** button.

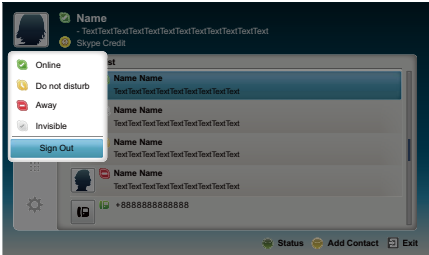

*(Sample Image) Skype™ status menu*

## Add Contact

You can add contacts to your contact list.

When you press the **YELLOW** button on the remote control, the **Add Contact Type** menu window will appear on the screen.

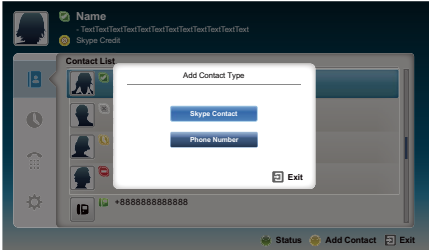

*Skype™ Add Contact Type menu*

Two sub-functions are supported.

Press the ▲/▼ (arrow) buttons to select **Skype Contact** or **Phone Number** and press the **OK** button.

- ❖ **Skype Contact**

Enter the Skype™ Name of the person you're looking for. The search result will show up after get response from Skype™ server.

- ❖ **Phone Number**

You can also enter a phone number in the search window.

#### Contact Search Results

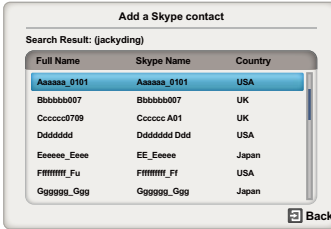

*(Sample Image) Skype™ contact search results screen*

You can send a contact request to a person displayed in the search results. Press the ▲/▼ (arrow) buttons to select a person and press the **OK** button.

#### Notification of authorization request

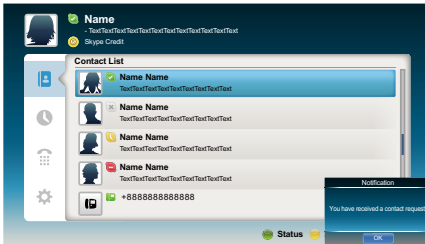

*Skype™ notification of authorization request screen*

When you receive a contact request, a pop-up menu will appear where you can choose to **Accept**, **Block** or **Decline** the request.

Press the ▲/▼ (arrow) buttons to select and press the **OK** button.

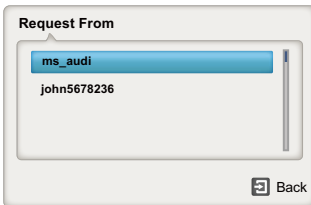

*(Sample Image) Skype™ request form screen*

Press the ◀/▶ (arrow) to select and press the **OK** button.



*(Sample Image) Skype™ request form screen*

## Recent

You can see a list of past events in “Recent”.



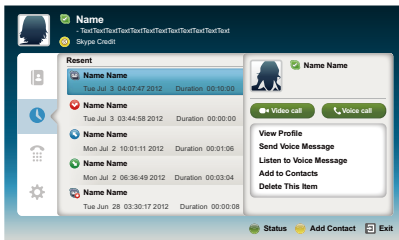

Press the ▲/▼ (arrow) buttons to select the **Recent** tab. Press the ►/▲/▼ (arrow) buttons to select an item and press the **OK** button.



*(Sample Image) Skype™ history screen*

Press the ◀/▶ (arrow) buttons to select **Video call** or **Voice call**.

Each call has an icon with it. The meaning of each icon is as follows:

<i>Icons</i>	<i>Description</i>
	Incoming call
	Outgoing call
	Missed call
	Unread voice message
	Voice Message

## Dialer

You can call mobiles and landlines from this screen.

Press the ▲/▼ (arrow) buttons to select the **Dialer** tab. Press the ►/▲/▼ (arrow) buttons to navigate this screen.

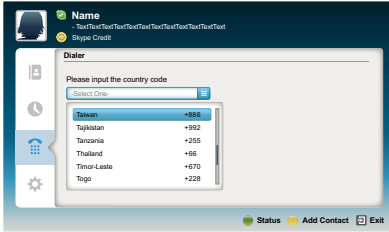

*(Sample Image) Skype™ dialer screen*

Select the country or region first, and then enter the phone number with area code. You'll need a little Skype™ Credit in your account to call mobiles or landlines using Skype™.

Emergency calls over Skype™ are not supported.

**▲ WARNING** Emergency calls over Skype™ are not supported.

## Settings

Press the ▲/▼ to select the **Settings** tab and press the **OK** button.

The Settings page will appear.

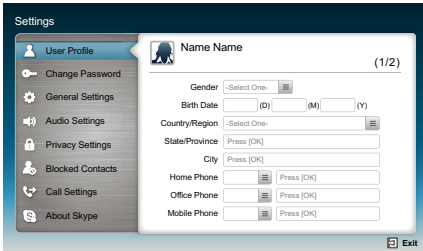

*(Sample Image) Skype™ options screen.*

You can change the following settings:

- ❖ **User Profile**  
Add or change your personal information e.g. birth date, country/region or phone number.
- ❖ **Change Password**  
You can change your password by entering your existing password and new password twice.
- ❖ **General Settings**  
Select whether Skype™ should automatically start when turning on the TV.
- ❖ **Audio Settings**  
Adjust the speaker / ringtone volume manually.



The volume of your speakers will be different on Skype™ compared to your normal TV volume level. The speaker volume range is 0 - 100% by 1 steps, and ringtone volume is 0 - 100% by 25 steps.

- ❖ Privacy Settings  
Set who you allow calls from, whether it's Anyone or People in my Contact list only.
- ❖ Blocked Contacts  
If you do not want someone to reach you, simply block them by entering their Skype™ Name or phone number from this menu. Successfully blocked contacts are displayed in this window.
- ❖ Call Settings  
If you're not signed into Skype™, you can forward incoming calls to another phone number, Skype™ name or choose to accept voice messages. However you'll need to have Skype™ Credit to turn this feature on.
- ❖ About Skype  
Displays information about Skype™.

## MediaShare (Videos, Music, and Photos)

MediaShare provides a simple graphic interface to quickly access and share videos, music, and image files across your home network and the other connected devices.

To access the MediaShare Service, press the **MEDIA SHARE** button on the remote or select the MediaShare tab from the Cloud TV Portal pages.

- NOTE**
- ❖ To use MediaShare please configure the network settings on your TV. For more information, see ["Connecting to a home network" on page 45](#).
  - ❖ Do not insert/remove USB device or SD card while in use.
  - ❖ The **SETUP** button is not available while using the MediaShare feature.

## MediaShare specifications

Devices:

- ❖ USB device: USB Mass Storage Class devices (MSC)
- ❖ SD, SDHC and SDXC memory card
- ❖ Connected Media Server:  
Your computer (for example)  
SD slot/card reader

**NOTE**

- ❖ Connectivity is not guaranteed for all devices.
  - ❖ Some functionality may be lost with a USB HUB connection.
- 

Supported file system:

- ❖ FAT16 and FAT32 (USB device, SD and SDHC memory card)
  - ❖ FAT16, FAT32 and exFAT (SDXC memory card)
- 

**NOTE**

You must obtain any required permission from copyright owners to download or use copyrighted content. Toshiba cannot and does not grant such permission.

---

## Basic operation

### Using MediaShare with a USB device or SD card

When Auto Start is enabled, you will be asked if you want to start the MediaShare whenever a USB device or SD card is inserted. If Auto Start is disabled (or if you want to connect to a media server on the network), you must manually start the MediaShare from the Cloud TV Portal pages or press the **MEDIA SHARE** button on the remote control.

### To change the Auto Start setting

- 1 Press the **SETUP** button.
- 2 Select **Options > MediaShare Setup > USB/SD Card Auto Start** and press the **OK** button.
- 3 Press the **▲/▼** (arrow) buttons to select **On** or **Off**.

### Auto Start

- 1 Insert a USB device into the USB port, or insert an SD card into the SD card slot. A prompt appears.
- 2 Press the **◀/▶** (arrow) buttons to select **Yes**, and then press the **OK** button.
- 3 Press the **▲/▼** (arrow) buttons to select **Videos**, **Music**, or **Photos**, and then press the **OK** button.
- 4 To change the device, press the **▲/▼/◀/▶** (arrow) buttons to select the devices on the screen, and then press the **OK** button.
- 5 Press the **▲/▼** (arrow) buttons to select the device and then press the **OK** button.
- 6 Press the **▲/▼** (arrow) buttons to select **OK** and then press the **OK** button.

---

**NOTE** If Auto Start is set to Off, you can start the MediaShare (Media Player) manually.

---

### Manual Start

- 1 Insert a USB device into the USB port, or insert an SD card into the SD card slot.
- 2 Press the **MEDIA SHARE** button.
- 3 To change the device, press the ▲/▼/◀/▶ (arrow) buttons to select the devices on the screen, and then press the **OK** button.
- 4 Press the ▲/▼ (arrow) buttons to select the device and then press the **OK** button.
- 5 Press the ▲/▼ (arrow) buttons to select **OK** and then press the **OK** button.

### To select a file in the list of contents

- 1 Press the ▲/▼/◀/▶ (arrow) buttons to select a file or folder.  
**File:**  
Press the **OK** button to play or view.  
**Folder:**  
Press the **OK** button to move to the next layer, or press the **BACK** button to return to the previous layer.

### Sort

- 1 Select the **Sort** and press the **OK** button.
- 2 Press the ▲/▼ (arrow) buttons to select the sorting rule (**File Name**, **New** or **Old**) and press the **OK** button.
- 3 Select **OK** and press the **OK** button.

---

**NOTE** Sorting may take a little time.

---

### To close the MediaShare

- 1 Press the **EXIT** button.
- 2 Press the ◀/▶ (arrow) buttons to select **Yes** and then press the **OK** button.  
The TV will return to the last-viewed channel or video input.

## Using MediaShare with a Media Server

You need to configure a home network before using this feature, see “Setting up the Network” on page 129.

- 1 Press the **MEDIA SHARE** button.
- 2 To change the device press the ▲/▼/◀/▶ (arrow) buttons to select the **Device Name** button on the screen, and then press the **OK** button.
- 3 Press the ▲/▼ (arrow) buttons to select the device and then press the **OK** button.
- 4 Press the ▲/▼ (arrow) buttons to select **OK** and then press the **OK** button.

## To select a file in the list of contents

- 1 Press the ▲/▼/◀/▶ (arrow) buttons to select a file or folder.  
**File:**  
Press the **OK** button to play or view.  
**Folder:**  
Press the **OK** button to move to the next layer, or press the **BACK** button to return to the previous layer.

## Sort

- 1 Select the **Sort** and press the **OK** button.
- 2 Press the ▲/▼ (arrow) buttons to select the sorting rule (**Title**, **New** or **Old**) and press the **OK** button.
- 3 Select **OK** and press the **OK** button.

---

### NOTE

- ❖ Sorting may take a little time.
  - ❖ Depending on the Media server, this function may not be usable.
- 

## To close the MediaShare

- 1 Press the **EXIT** button.
- 2 Press the ◀/▶ (arrow) buttons to select **Yes** and then press the **OK** button.  
The TV will return to the last-viewed channel or video input.

## To display the device information

- 1 Press the **QUICK** button to open the Quick menu in list mode or Multi View mode.
- 2 Press the ▲/▼ (arrow) buttons to select **Device Information**.

## Viewing movie files

### Basic Playback

- 1 Select a file, see “To select a file in the list of contents” on page 159.
- 2 Press the **OK** button or **PLAY** button to begin playback.

- NOTE**
- ❖ Depending on the file size, it may take some time to start playback.
  - ❖ Depending on the images, the 3D function may turn on when the 3D button is pressed. Refer to “Using 3D functions” on page 73 for information about operation and settings.

- 3 Press the **STOP** button to stop playback.  
The screen returns to the list.  
If playback finishes before the **STOP** button is pressed, the screen returns to the list.

- NOTE** When the repeat mode is set to All, the next file will start playing automatically.

### Resume Playback

You can resume playback from where it was last stopped.

- ❖ Press the **STOP** button while playing the movie to memorize the stopped position.  
If the same file is selected and played, playback will resume from the last stopped position.

- NOTE**
- ❖ If you play different content or exit MediaShare, the memorized stopped position will be deleted.
  - ❖ This function may not be available depending on the content.

### To pause playback

- ❖ Press the **PAUSE** button during playback.
- ❖ To resume normal playback, press the **PLAY** button.

- NOTE** The **PAUSE** button or operations during Pause may not be functional depending on content or media server.

### To locate a specific file

- ❖ Press the **Skip Reverse** or **Skip Forward** button repeatedly to access the desired file.
- ❖ (⏮): Playback starts from the beginning of the current file or previous file.
- ❖ (⏭): To locate subsequent files.

### To play in fast reverse or fast forward directions

- ❖ Press the ⏮ or ⏭ button during playback. Each time you press the ⏮ or ⏭ button, the playback speed will change.

---

**NOTE** These features may not be operable depending on the content or media server.

---

### To set the repeat mode

- 1 Press the **QUICK** button.
- 2 Press the ▲/▼ (arrow) buttons to select **Repeat**.  
The current repeat setting appears.
- 3 Press the ◀/▶ (arrow) buttons to select **Off**, **All**, or **1**.
- 4 Press the **BACK** button.  
The setting is effective until the TV is turned off.

<i>Mode:</i>	<i>Description:</i>
Off	The content is played back only once
All	All contents in the same folder are repeatedly played back
1	The same content is repeatedly played back

### To select a movie from Play List (except for Media Renderer function)

While playing a movie, you can select a different movie from the Play List.

- 1 Press the **QUICK** button to open the Quick Menu.
- 2 Press the ▲/▼ (arrow) buttons to select **Play List** and press the **OK** button.  
The Movie List will appear.
- 3 Press the ▲/▼ (arrow) buttons to select a file name.

### To display the file status information

- 1 Press the **INFO** button during playback.

The information will be displayed at the bottom of the screen.

- 2 Press the **INFO** button again to hide the information.

---

**NOTE** The information may not correctly display depending on the content or media server.

---

### To register your TV to a DivX® account:

This TV allows you to play back files purchased or rented from DivX® Video-On Demand (VOD) services. When you purchase or rent DivX® VOD files on the internet, you will be asked to enter a registration code.

- 1 Press the **SETUP** button.
- 2 Select **Options > MediaShare Setup > DivX® VOD** and press the **OK** button.
- 3 Press the **▲/▼** (arrow) buttons to select **DivX® VOD Registration**, and then press the **OK** button.
- 4 The **DivX® VOD** window will appear and you will see the registration code. For details on registration, please visit the DivX® website at <http://vod.divx.com>
- 5 Copy the activation file to a memory device and play it on the TV.

### To unregister your device:

- 1 Press the **SETUP** button.
- 2 Select **Options > MediaShare Setup > DivX® VOD** and press the **OK** button.
- 3 Press the **▲/▼** (arrow) buttons to select **DivX® VOD Deregistration**, and then press the **OK** button.
- 4 A confirmation message will appear. Select **Yes** and press the **OK** button.
- 5 The **DivX® VOD** window will appear and you will see the deregistration code. For details on registration, please visit the DivX® website at <http://vod.divx.com>

ABOUT DIVX VIDEO: DivX® is a digital video format created by DivX, LLC, a subsidiary of Rovi Corporation. This is an official DivX Certified® device that plays DivX video. Visit [divx.com](http://divx.com) for more information and software tools to convert your files into DivX videos.

**ABOUT DIVX VIDEO-ON-DEMAND:** This DivX Certified® device must be registered in order to play purchased DivX Video-on-Demand (VOD) movies. To obtain your registration code, locate the DivX VOD section in your device setup menu. Go to [vod.divx.com](http://vod.divx.com) for more information on how to complete your registration.

DivX Certified® to play DivX® and DivX Plus® HD (H.264/MKV) video up to 1080p HD including premium content.

### **To playback DivX Plus® HD content:**

- ❖ To play in fast reverse or fast forward directions, press the ◀◀ or ▶▶ button during playback. Each time you press the ◀◀ or ▶▶ button, the playback speed will change.
- ❖ If the content contains no chapter, this TV generates original chapter point in 10% increments for 10 chapters in total, that are accessible by using the Number buttons on the remote control.

During playback, press the ▶▶ button to skip to the beginning of the next chapter. When the ▶▶ button is pressed twice in succession, it will repeat two times of above. If the ▶▶ button is pressed at the last chapter, the confirmation message will appear. If **Yes** is selected, playback will skip to the beginning of the next content.

Press the ◀◀ button to skip to the beginning of the current chapter.

When the ◀◀ button is pressed twice in succession, it will skip to the beginning of the previous chapter. If the ◀◀ button is pressed twice continuously at the first chapter, playback of the current content will stop and the confirmation message will appear. If **Yes** is selected, playback will skip to the beginning of the previous content.

- ❖ Press the ▲ (arrow) button to skip to the beginning of the previous content.  
Press the ▼ (arrow) button to skip to the beginning of the next content.

The Number button is used for direct jump.

For example: If you press the 3 button and then press the **OK** button, playback will jump to the beginning of 3rd chapter.

---

### **NOTE**

- ❖ Depending on the content data will not be operated.
  - ❖ The playback speed (◀◀/▶▶) may not change depending on the stream.
-



## Using Multi Title and Alternative Timelines Multi Title

DivX Plus<sup>®</sup> HD files may contain up to 100 titles.

You can change the title (It contains same video file) by pressing the **RED** button.

When the **RED** button is pressed, it will display the title change window at the bottom on the screen (same as Subtitle or Audio change window).

The title is changed cyclically each time the **RED** button is pressed.

Playback starts from the beginning of the title, which is selected by the **▲** or **▼** (arrow) buttons.

- ❖ Pressing the **◀/▶** (arrow) buttons also changes the multi title.

---

**NOTE** Depending on the content data will not be operated.

---

## File specifications:

USB/SD card use:

- ❖ **File format:** MPEG2 PS, MPEG2 TS, MPEG-2 VOB, AVI, MOV, MP4, ASF, DivX, Xvid, MKV, Flash Video (FLV1), 3GPP, Motion JPEG
- ❖ **Video:** MPEG2, H.264, MPEG-4 part2, DivX, Xvid, VC-1(WMV9), RealVideo 8,9,10, Sorenson H.263(FLV1), JPEG
- ❖ **Audio:** MPEG1-Layer2/MPEG1-Layer3/Dolby<sup>®</sup> Digital (AC3)/LPCM, AAC, WMA7/8/9, ADPCM
- ❖ **Maximum number of files:** 1000 per folder
- ❖ **Maximum video resolution:** 640x480(Motion JPEG), 1920 x 1080(other)
- ❖ **Include SD card:** SD, SDHC and SDXC are supported.  
**SD:** 128MB-2GB / **SDHC:** 4GB-32GB / **SDXC:** 32GB-2TB  
**Speed/Class:** 2,4,6,10  
**File system:** FAT 12, FAT16, FAT32, NTFS and exFAT

Content on a connected Media Server:

- ❖ **File format:** MPEG2 PS, MPEG2 TS, MP4(Low resolution)
- ❖ **Video:** MPEG2(PS), H.264
- ❖ **Audio:** LPCM/MPEG1-Layer2/MPEG2-Layer2/Dolby Digital (AC3)/AAC
- ❖ **Maximum number of files:** 1000 per folder
- ❖ **Maximum video resolution:** 1920 x 1080

**NOTE** It may not be possible to use certain playback or display some files. In some cases certain files and servers may not support playback features, such as pause.

---

## Playing music files

### Basic Playback

- 1 Select a file, see “[To select a file in the list of contents](#)” on page 159. Press the **OK** button or **PLAY** button to begin playback.
- 

**NOTE** Depending on the file size, it may take some time to start playback.

---

- 2 Press the **STOP** button to stop playback.  
The screen returns to the list.  
If playback finishes before the **STOP** button is pressed, the screen returns to the list.

### To pause playback

- 1 Press the **PAUSE** button during playback.
  - 2 To resume normal playback, press the **PLAY** button.
- 

**NOTE** The **PAUSE** button or operations during Pause may not be functional depending on content or media server. Certain processes may take some time to complete.

---

### To locate a specific file

- ❖ Press the **SKIP REVERSE** or **SKIP FORWARD** button repeatedly to access the desired file.
- ❖ **(⏮)**: Playback starts from the beginning of the current file or previous file.
- ❖ **(⏭)**: To locate subsequent files.

### To play in fast reverse or fast forward directions

- ❖ Press the **⏮** or **⏭** button during playback. Each time you press the **⏮** or **⏭** button, the playback speed will change.
- 

**NOTE** These features may not be operable depending on the content or media server.

---

### To set the repeat mode

- 1 Press the **QUICK** button.
- 2 Press the **▲/▼** (arrow) buttons to select the **Repeat**.  
The current repeat setting appears.
- 3 Press the **◀/▶** (arrow) buttons to select **Off**, **All**, or **1**.
- 4 Press the **BACK** button.  
The setting is effective until the TV is turned off.

<i>Mode:</i>	<i>Description:</i>
Off	The content is played back only once
All	All contents in the same folder are repeatedly played back
1	The same content is repeatedly played back

### To select a music from Play List (except for Media Renderer function)

While playing a music file, you can select a different music file from the Play List.

- 1 Press the **QUICK** button to open the Quick Menu.
- 2 Press the **▲/▼** (arrow) buttons to select **Play List** and press the **OK** button.  
The Music List will appear.
- 3 Press the **▲/▼** (arrow) buttons to select a file name.

### To display the file status information:

- 1 Press the **INFO** button during playback.  
The information appears at the bottom of the screen.
- 2 Press the **INFO** button again to hide the information.

**NOTE** The information may not correctly display depending on the content or media server.

### File specifications:

USB/SD card use:

- ❖ **File format:** MP3, MP4 (AAC), WMA7/8/9, WAV(LPCM)
- ❖ **Sampling frequency:** 32 kHz, 44.1 kHz, 48 kHz
- ❖ **Bit rate:** From 32 to 320 kbps
- ❖ **Maximum number of files:** 1000 per folder

Content on a connected Media Server:

- ❖ **File format:** MP3, MP4 (AAC), WMA9 std, LPCM
  - ❖ **Sampling frequency:** 32 kHz, 44.1 kHz, 48 kHz
  - ❖ **Bit rate:** From 32 to 320 kbps
  - ❖ **Maximum number of files:** 1000 per folder
- 

**NOTE** It may not be possible to use certain playback features or display some files. In some cases certain files and servers may not support playback features, such as fast-forward.

---

## Viewing photo files

### Multi View mode

This view mode allows you to search for photos in a grid format.

These pictures are displayed using thumbnail data in each image file.

- 1 Press the ▲/▼/◀/▶ (arrow) buttons to move the highlight by one window.

If all of the photos will not fit in one screen, when pressing the ▲ (arrow) button at the top thumbnail, the screen will scroll up one by one. Similarly, when pressing the ▼ (arrow) button at the bottom thumbnail, the screen will scroll down one by one.

- 2 When you select a folder, press the **OK** button to move to the next layer.

Press the **BACK** button to move back to the previous layer.

- 3 Press the **OK** button to view the selected photo in Single View mode.

---

**NOTE**

- ❖ Displaying thumbnail data may take time.
- ❖ In order to use the ▲/▼ (arrow) buttons to scroll the screen, there must be enough content to take up two screens.

---

### Single View mode

In this view mode, only files located in the selected directory are displayed. When moving from Multi View mode to Single View mode, the currently selected photo appears.

- 1 On Multi view mode, press the ▲/▼/◀/▶ (arrow) buttons to select a file, and then press the **OK** button.
- 2 Press the ◀/▶ (arrow) buttons to view the next or previous file.

---

**NOTE** Single view mode is changed to Multi View mode when the **BACK** button is pressed.

---

### Slide Show mode

This view allows you to watch a slide show of the photos. In this mode, only files located in the selected directory appear.

- 1 To switch to Slide Show mode, press the **OK** button while in Single View mode.  
To return to Single View mode, press the **OK** button again.
- 2 Press the ◀/▶ (arrow) buttons to view the next or previous file.

### Mode settings

- 1 Press the **QUICK** button to open the Quick menu while in Single View mode or Slide Show mode.
- 2 Press the ▲/▼ (arrow) buttons to select the item (**Interval Time** or **Repeat**).
- 3 Press the ◀/▶ (arrow) buttons to adjust the setting.
- 4 Press the **BACK** button to return to Single View mode or Slide Show mode.

---

<i>Mode:</i>	<i>Description:</i>
Interval Time	Sets a time interval at which to view photos
Repeat	Displays photos in the same directory repeatedly (On/Off)

---

### To set Background Music

- 1 Press the **QUICK** button to open the Quick Menu while in the Slide Show mode or Single View mode.
- 2 Select **Background Music** and press the **OK** button.
- 3 Press the ▲/▼ (arrow) buttons to select **On**.  
The music file in the same folder as the displayed photo will start playing.

---

**NOTE**

- ❖ When the music file repeat mode is set to **All**, all the music files in the same folder as the photo will be played repeatedly.
- ❖ To stop music file playback, select **Off** in **Background Music**

---

## Rotate the image

While viewing the image in Single View mode or Slide Show mode, press the ▲/▼ (arrow) buttons to rotate the image 90 degrees.

## To select a photo from Play List (except for Media Renderer function)

While in the Single View mode or Slide Show mode, you can select a different photo from the Play List.

- 1 Press the **QUICK** button to open the Quick Menu from Single View mode or Slide Show mode.
- 2 Press the ▲/▼ (arrow) buttons to select **Play List** and press the **OK** button.  
The Photo List will appear.
- 3 Press the ▲/▼ (arrow) buttons to select a file name.

## Display file status information

- 1 Press the **INFO** button.  
The information appears at the bottom of the screen.
- 2 Press the **INFO** button again to hide the information.

---

**NOTE** The information may not correctly display depending on the content or media server. Certain processes may take some time to complete.

---

## File specifications:

USB/SD card use:

- ❖ **Data compatibility:** JPEG Exif ver 2.2
- ❖ **File format:** JPEG
- ❖ **Maximum viewable resolution:** 12000 × 9000 (JPEG:Base-line), 1024 × 768 (JPEG:Progressive)
- ❖ **Maximum number of files:** 1000 per folder

Content on a connected Media:

- ❖ **Data compatibility:** JPEG Exif ver 2.2
- ❖ **File format:** JPEG
- ❖ **Maximum photo resolution:** 4096 x 4096
- ❖ **Maximum number of files:** 1000 per folder.

## Search

To search for content,

- 1 Select the search.
- 2 Enter in keyword and the search will search for:
  - ❖ **Media Server**  
**Videos**; Title name  
**Music**; Title name/Artist name/ Album name  
**Photos**; Title name
  - ❖ **USB/SD card**  
**Videos/Music/Photos**; File name

---

**NOTE** Folders are not subject to the search function.

---

- 3 The retrieval result is displayed.
- 4 Select one of the search results.
- 5 The selected content will play.

---

**NOTE** The search retrieval stops when content is being played.

---

- ❖ The results screen shows different categories of media; **Videos**, **Music** and **Photos**. Select the ▼ below a category and press the **OK** button to display results only for that category of media on the screen.

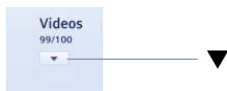

- ❖ To return to the previous display, select ▲ and press the **OK** button.

## Network Device Setup

In order to set the access the **External Control Setup**, **Media Renderer Setup**, or **Device Name Setup**, you must use the **Network Device Setup** menu.

### External Control Setup

- 1 Press the **SETUP** button.
- 2 Select **Network > Network Device Setup > External Control Setup** and press the **OK** button.
- 3 Use the **▲/▼** (arrow) buttons to select and set **Enable Control** to **On** or **Off**.

#### To access the Home Control Profile:

- 1 Press the **SETUP** button.
  - 2 Select **Network > Network Device Setup > External Control Setup** and press the **OK** button.
  - 3 Use the **▲/▼** (arrow) buttons to select and set **Enable Control** to **On** or **Off**.
  - 4 Use the **▲/▼** (arrow) buttons to select **Home Control Profile** and press the **OK** button.  
The Home Control Profile window will appear.
  - 5 Use the **▲/▼/◀/▶** (arrow) buttons to navigate to the **User Name** or **Password** field. Input the user name and password using the Software Keyboard or Wireless QWERTY keyboard.
- ❖ For more information, see [“Using the software keyboard” on page 137](#).

---

**NOTE**

Only the 0-9 and capital/lowercase A-Z characters may be used for the user name and password.

---

### Setting up the Media Renderer feature

The TV can be configured as a Media Renderer. When operating as a Media Renderer, the TV displays content provided by mobile devices or PCs. The selection of the media is done by the media controller.

The TV can play photo, movie, or audio files when operating as a Media Renderer.

- 1 Press the **SETUP** button.
- 2 Select **Network > Network Device Setup > Media Renderer** and press the **OK** button.



- 
- 3 Press the ▲/▼ (arrow) buttons to select **On** or **Off**, and then press the **OK** button.

### Device Name setup

The device name as a Media Renderer can be changed.

- 1 Press the **SETUP** button.
- 2 Select **Network** > **Network Device Setup** > **Device Name Setup** and press the **OK** button.
- 3 Select the **Device Name** field. Press the **OK** button.  
The Software Keyboard screen appears.
- 4 Input the device name by using the Software Keyboard. To save your setting, press the **GREEN** button.
- 5 Select **Done**. Press the **OK** button.

---

#### NOTE

The maximum number of characters allowed for the device name is 15. Only 0-9, A - Z (upper case only), "-" can be used in the device name.

---

# Chapter 9

## Cloud TV Companion Apps

---

### Using Apps on a Tablet or Smart phone

Toshiba provides apps for tablets and smart phones. The apps will vary by country and availability may change in the future with respect to current apps.

---

**NOTE** Apps will vary by country and availability may change in the future on current apps.

---

These apps are available for compatible Toshiba equipment using compatible tablets and smart phones powered by Android™ or iOS. You can download these apps through the Google Play™ or the iTunes Store.

In order to use these apps, you must configure the settings through the Apps Control Profile.

---

**NOTE** ❖ Third party Internet services are not provided by Toshiba, may change or be discontinued at any time, and may be subject to Internet service provider restrictions. Toshiba makes no warranties, representations, or assurances about the content, availability, or functionality of third-party content or services. Use of third-party Internet services may require the creation of a separate account through a computer with Internet access and/or payment of one-time and/or recurring charges and membership. Not all third-party services may be available on or compatible with this product. In order to experience the full suggested capabilities of this product, fully-compatible devices may be required.

- ❖ Apps can only be used when your TV and your tablet or smart phone are connected to the Internet.
- ❖ Some app features may require the TV and smart phone/tablet to be on the same home network connection.
- ❖ Starting and operation of this service may take several minutes.
- ❖ Software updates may be needed in order to use this service.
- ❖ In order to experience the full suggested capabilities of this product, fully-compatible devices may be required.
- ❖ Certain features may not be available in all countries.
- ❖ Companion Apps available through the Cloud may be changed or removed at any time. Not all operating system Apps may be compatible with the Cloud. Services depicted in this document and provided through the Cloud may not be available in your region and may not be available to you. Please check your individual device for app compatibility.
- ❖ As soon as the application is deployed, this feature can be used.

---

## **Apps Control Profile**

### **To select the Apps Control Profile**

- 1** Press the **SETUP** button.
- 2** Select **Network > Network Device Setup > External Control Setup** and press the **OK** button.
- 3** Press the **▲/▼** (arrow) buttons to select and set **Apps Control Profile** and press the **OK** button.  
The Apps Control Profile window will appear.
- 4** Press the **▲/▼** (arrow) buttons to select **Device Registration Setup** and press the **OK** button.  
The Device Registration Setup window will appear.
- 5** Use the **▲/▼** (arrow) buttons to select the **Companion Device ID**.
- 6** Select the **Cancel, All, or Delete** buttons.

---

### **NOTE**

- ❖ If the maximum number of registered devices (20) is exceeded, no additional devices can be registered. Delete unnecessary devices before registering a new device.
  - ❖ When re-registering a device which has been deleted from the list, pairing must be carried out again.
-

**To enable the New Device Detection:**

- 1 Press the **SETUP** button.
- 2 Select **Network > Network Device Setup > External Control Setup** and press the **OK** button.
- 3 Press the **▲/▼** (arrow) buttons to select and set **Apps Control Profile** and press the **OK** button.  
The Apps Control Profile window will appear.
- 4 Press the **▲/▼** (arrow) buttons to select **New Device Detection** and press the **OK** button.
- 5 Use the **◀/▶** (arrow) buttons to select **Enable** or **Disable**.
- 6 Press the **OK** button to submit.

## Pairing

To use Apps, it is necessary to connect a compatible tablet or smart phone and this TV to your home network, and carry out pairing (using a 4 or 8 digit password to authenticate the device).

Refer to the Apps manual for more details about pairing.

---

**NOTE**

- ❖ Pairing with external devices cannot be carried out when the TV is connected to an unencrypted wireless LAN access point. Activate the encryption settings for the wireless LAN access point before carrying out Pairing.
  - ❖ When the **Enable Control** is not set to **ON** in **External Control Setup**, Apps functions including Pairing cannot be used.
-

# Chapter 10

## Troubleshooting

---

### General troubleshooting

Before calling a service technician, review this chapter or visit the Toshiba Technical Support Website at "support.toshiba.com" for possible causes/solutions for the problem you are experiencing.

Before you begin to troubleshoot any problem, first unplug the TV from the AC wall outlet, wait approximately one minute, and then plug the TV back into the AC wall outlet. If the problem still exists attempt to troubleshoot the problem.

#### **Black box on screen.**

The closed caption feature is set to one of the Text modes (**T1**, **T2**, **T3**, or **T4**). Set the closed caption feature to Off, see [“Using closed captions” on page 86](#).

#### **TV stops responding to controls.**

If the TV stops responding to the buttons on the remote control or TV control panel and you cannot turn off the TV, unplug the TV from the AC wall outlet and plug it back in.

If you cause a static discharge when touching the TV and the TV fails to function, simply unplug the TV from the AC outlet and plug it back in. The TV should return to normal operation.

**Other problems.**

If your TV's problem is not addressed in this Troubleshooting chapter or the recommended solution has not worked, use the Reset Factory Defaults procedure, see [“Resetting to Factory Defaults” on page 105](#).

**TV will not turn on.**

Check the AC wall outlet by trying another device in the AC wall outlet. Ensure the power cord is plugged in properly, and then press the **POWER** button.

Replace the batteries in the remote control, see [“Installing batteries” on page 50](#).

Try the control panel buttons on the TV.

**3D problems.**

Watch the TV at a proper viewing angle and distance, see [“Safety Precautions for 3D glasses” on page 7](#).

If 3D images are not correct, the 3D format may be different.

Change the 3D format in the Quick menu, see [“Selecting 3D format from the Quick menu in 3D mode” on page 78](#).

The left and right sides of 3D images may be reversed. Switch the left and right, see [“Switching left and right images” on page 84](#).

If 2D images are not correct, the 2D format may be different.

Change the 2D format in the Quick menu, see [“Selecting 2D format from the Quick menu in 2D mode” on page 80](#).

**Picture problems****General picture problems.**

Check the antenna/cable connections, see [“Connecting Your TV” on page 29](#).

Press **INPUT** on the remote control or on the TV and select a valid video input source, see [“Selecting the video input to view” on page 85](#). If you have no picture after selecting a Input source, check the device connected to that input for proper operation. For device connection details, see [“Connecting Your TV” on page 29](#).

Antenna reception may be poor. Use a highly directional outdoor antenna (if applicable).

The station may be having broadcast difficulties. Try another channel.

Adjust the picture quality, see [“Using the advanced picture settings features” on page 114](#).

If Resolution+ does not achieve a sharper picture, change the Sharpness value to increase the sharpness level, see [“Resolution+” on page 114](#).

### **Video Input Selection problems.**

If the Input Selection window does not appear when you press **INPUT** on the remote control or the TV control panel, press **INPUT** a second time. The TV displays the next video input source and the Input Selection screen.

### **Cannot view external signals.**

If you cannot view signals from external devices connected to VIDEO 1, VIDEO 2, ColorStream HD, HDMI 1, HDMI 2, HDMI 3, HDMI 4 or PC, ensure that the Input Lock is set to Off, see [“Locking video inputs” on page 94](#).

### **Poor display color or no color.**

Check for proper hookup connections between your devices.

The station may be having broadcast difficulties. Try another channel.

Adjust the Tint and/or Color, see [“ColorMaster™” on page 116](#).

### **Poor composite picture.**

If the TV is connected to an external A/V device (e.g. DVD player, video game system, set-top box, etc.) try using a ColorStream or HDMI™ video connection instead.

### **Picture and sound are out of sync.**

As with all products that contain a digital display, this may occur in rare instances, when viewing certain content (e.g. television broadcasts, video games, DVDs). The cause may include, without limitation, video processing within the TV, video processing in an attached gaming system, and video processing or different compression rates used by broadcasters in their programming.

Try the following:

- ❖ If the TV is connected to an A/V receiver that has a programmable audio delay feature, use this feature to help synchronize the sound to the picture.
- ❖ If the problem occurs only on certain TV channels, inform your local broadcast, cable, or satellite provider.
- ❖ The settings of PC/HDMI 2 Audio may be not correct. Check the connections, see [“Connecting a computer” on page 43](#).
- ❖ Turn off and unplug the TV from the AC wall outlet for a few seconds and plug it back in.

## Sound problems

Check the antenna/cable connections, see [“Connecting a digital audio system” on page 38](#).

The station may be having broadcast difficulties. Try another channel.

The sound may be muted. Press the **VOL (+ -)** buttons or **MUTE** button.

If you are connected to a computer using either the PC IN terminal or an HDMI™ terminal, make sure that the Rear Shared Audio setting is properly set, see [“Connecting a digital audio system” on page 38](#).

## Remote control problems

Remove all obstructions between the remote control and the TV.

Replace the remote control’s batteries, see [“Installing batteries” on page 50](#).

Your TV’s remote control may not operate certain features on your external device. Refer to the owner’s manual for your other device to determine its available features. If your TV remote control does not operate a specific feature on another device, use the remote control that came with the device, see [“Learning about the remote control” on page 53](#).

If the TV still does not act as expected, perform the Reset Factory Defaults procedure, see [“Resetting to Factory Defaults” on page 105](#).

## Channel tuning problems

Ensure that the remote control is set to the correct device mode, see [“Learning about the remote control” on page 53](#).

The Auto Tuning feature may have erased the channel from memory. To add the channel to the channel memory, see [“Manual Tuning” on page 70](#).

The Lock feature may have blocked the channel. To unblock the channel, see [“Unlocking programs” on page 93](#).

If you cannot tune digital channels, check the antenna configuration, see [“Initial setup” on page 55](#). If the problem persists, clear all channels from the channel list and reprogram channels into memory, see [“Storing channels in memory \(optional\)” on page 69](#). For additional information, see [“TV stops responding to controls.” on page 177](#). If the problem persists, use the Reset Factory Defaults procedure, see [“Resetting to Factory Defaults” on page 105](#).



## Closed caption problems

If the program or video you have selected is not closed captioned, no captions appear on the screen.

If text is not available, a black rectangle may appear. If this happens, turn off the closed caption feature, see [“Using closed captions” on page 86](#).

A closed caption signal may not display correctly under the following circumstances:

- ❖ The recording is dubbed
- ❖ The signal reception is weak
- ❖ The signal reception is nonstandard

For additional information, see [“Using closed captions” on page 86](#).

## Rating blocking (V-Chip) problems

### Forgotten PIN code.

When the PIN code screen appears, press the **INFO** button 4 times within approximately 5 seconds. The old PIN code is cleared, see [“Forgotten PIN code” on page 90](#).

The V-Chip feature is available for U.S. V-Chip systems only, see [“Using parental controls” on page 90](#).

## HDMI™ CEC Control operation

HDMI™ CEC Control feature is available for Toshiba HDMI™ CEC compatible devices.

### HDMI™ cables.

Ensure that HDMI™ cables with the (**HDMI**) Logo are used.

### The HDMI™ CEC operation is not working correctly.

When the connected HDMI™ CEC device does not work correctly after you have changed the device's settings, turn off the TV and unplug the power cord. After approximately one minute, plug the power cord in and turn on the TV. You may also try using a different HDMI™ cable.

If several devices are connected, the HDMI™ CEC Control feature may not operate properly. Make sure the CEC function is set to **On** in the TV settings and that the controlling device(s) you support CEC.

Read the instruction manual of the connected HDMI™ CEC device.

## HDMI™ problems

### HDMI™ cables.

Ensure that HDMI™ cables with the **(HDMI)** Logo are used, see [“Connecting an HDMI™ or DVI device to the HDMI™ input”](#) on page 39.

## Network problems

### Cannot connect to the Internet.

Check the modem and its incoming cable/telephone connections, see [“Connecting to a home network”](#) on page 45.

Confirm your modem’s operation.

Ensure that your IP address is set up correctly, see [“IP Address Setup”](#) on page 134.

### No network connection.

If using a wired network connection, check to ensure that the LAN cables are connected properly, see [“Connecting the TV to a home network with an Internet connection - wired”](#) on page 47.

Ensure that the modem and router power cords are plugged in and the devices are operating properly.

Ensure that your IP address is set up correctly, see [“IP Address Setup”](#) on page 134.

Check to ensure proper operation of other network connected devices.

### Network Setup fails (Auto).

Check to ensure that the LAN cables are connected properly, see [“Connecting the TV to a home network with an Internet connection - wired”](#) on page 47.

DHCP is not enabled on the router, or no router is present. Refer to your router’s documentation for instructions on enabling DHCP. If your router does not support DHCP, you must manually set up the IP address.

Internet service is not available. Check your cable/DSL modem or contact your ISP for Internet service issues.

### Network Setup fails (Manual).

Ensure that the TV IP address is not the same as any other device on the network.

- ❖ Example: IP address 192.168.0.100 and IP address 192.168.0.101 are different addresses on the same network.

Make sure the TV IP address is on the same subnet as the networked computer.

- ❖ Example of proper setup: The computer has the IP address 192.168.0.100 with the Subnet mask 255.255.255.0, the TV has the IP address 192.168.0.101 with the Subnet mask 255.255.255.0; both are on the same subnet.
- ❖ Example of improper setup: The computer has the IP address 192.168.1.100 with the Subnet mask 255.255.255.0, the TV has the IP address 192.168.0.101 with the Subnet mask 255.255.253.0; they are on different subnets.

### **Unstable network connection.**

When using a wired home network connection, unplug the LAN cables, and then reconnect them.

When using a wireless home network connection:

- ❖ Reboot the router:
  - 1 Remove AC power from the router and the television for approximately one minute.
  - 2 Reconnect AC power to the router.
  - 3 Reconnect AC power to the television and turn it On.
  - 4 After approximately two minutes, check connection stability.
- ❖ Connect with LAN cables, if possible, and check connection stability.
- ❖ Repeat the wireless network setup procedure and check connection stability.

### **The media server name is not displayed.**

The LAN cables, if used, are not connected properly, see [“Connecting the TV to a home network with an Internet connection - wired”](#) on page 47.

The WLAN, if used, is not configured properly.

The network setup on the Server is incorrect. Make sure both the media server and TV are using the same network type (DHCP/manual) and have compatible network settings.

Too many devices are connected. You cannot connect more than 32 sharing devices at one time.

The media server is not turned On.

The “server” is not a media server device.

Check the firewall and streaming settings on the media server.

## Wireless network problems

Check that the router/AP (Access point) power is On.

After starting wireless network setup, confirm that the network is configured properly by performing the network connection test, see [“Network Connection Test” on page 136](#).

Check the router/AP’s connection status.

If the router/AP does not support PBC or WPS, Easy Setup (PBC) will not work even if the push-button is pressed, see [“Wireless Setup” on page 129](#).

If the available router/AP list is not displayed in Easy Setup (PBC) or Assisted Setup, the power of the router/AP may be Off. Check that it is On, and then try restarting the scan for available routers/APs, see [“Easy Setup using PBC \(Push button configuration\)” on page 130](#).

Refer to the router/AP’s instruction manual.

## MediaShare problems

Ensure that the devices (TV and Server) are connected correctly.

Incorrect functionality may occur when using a USB HUB connection.

Photo files that were processed and edited using the computer’s application software may not be viewable.

When viewing content that supports two or more formats the TV may select one format automatically.

Copyright protected content stored on the media server may not be playable on the TV.

Content playback stability may be affected by heavy network traffic.

Content originally recorded on a computer may not play correctly.

Set the media sharing of the media server to the correct settings, according to the media server instruction manual.

Confirm that the contents of either the media server, the USB storage device, or the SD card are in formats that are supported by this TV, see [“MediaShare specifications” on page 157](#).

Depending on the media server, access may be limited by the MAC address. Set the server according to the media server’s instruction manual. This TV’s MAC Address can be confirmed in the Network Setup portion of the User Menu, see [“MAC Address” on page 136](#).

## For Connected MediaShare

Depending on the media server, it may take time to display the list.

## Media Renderer

Depending on the state of this TV, the Media Controller may not be able to control a Media Renderer playback.

If Media Renderer playback starts regardless of the user's intention, set Media Renderer to Off.

## Cloud TV

### Cloud TV Freezes on the TV screen.

Power off or unplug the Television to reset the TV and turn the TV back on. Then try the Cloud TV again

### Pause or delay while navigating Cloud TV features and apps.

Check the Internet connection to the Cloud TV for speed and stability

### Cloud TV wireless keyboard becomes unresponsive

Check wireless keyboard batteries

Ensure the power switch on the keyboard is turned ON

## Light Indicator

The Power light on the front of the TV indicates the TV's status, as described below.

## Power On/Standby light

Green:

- ❖ The TV is On and operating properly.

Red:

- ❖ The power is Off or in Standby.

## If the problem persists after trying the solutions

In the U.S., visit Toshiba Customer Support Center on the web at "support.toshiba.com".

# Appendix A

## Specifications

### NOTE

- ❖ This model complies with the specifications listed below.
- ❖ Designs and specifications are subject to change without notice.
- ❖ This model may not be compatible with features and/or specifications that may be added in the future.

### Television system

NTSC standard	
ATSC standard	8VSB
Digital Cable	64 QAM, 256 QAM; in-the-clear, unencrypted

### Channel coverage

VHF	2 through 13
UHF	14 through 69
Cable TV	Mid band (A-8 through A-1, A through I)
	Super band (J through W)
	Hyper band (AA through ZZ, AAA, BBB)
	Ultra band (65 through 94, 100 through 135)

### Power source

120 V AC, 60 Hz

## Power consumption

58L9300U	2.1 A (maximum current)
	0.2 W in Standby mode
65L9300U	3.2 A (maximum current)
	0.2 W in Standby mode
84L9300U	5.3 A (maximum current)
	0.2 W in Standby mode

## Audio power

58L9300U	10 W + 10 W
65L9300U	10 W x 2 + 10 W x 2
84L9300U	10 W x 2 + 10 W x 2

## Speaker type

58L9300U	3.5cm(1 2/5 inch) x 7.5cm(2 19/20 inch) x 2pcs
65L9300U	3.5cm(1 2/5 inch) x 7.5cm(2 19/20 inch) x 4pcs
84L9300U	3.5cm(1 2/5 inch) x 7.5cm(2 19/20 inch) x 4pcs

## Video/audio terminals

### Video/audio input

Video	1 V (p-p), 75 ohm, negative sync, NTSC.
Audio	200 mV (rms) (-20dBFS)

### ColorStream<sup>®</sup> (component video) HD input

Video	Y: 1V (p-p), 75 ohm
	PR: 0.7V (p-p), 75 ohm
	PB: 0.7V (p-p), 75 ohm
	Suggested formats: 1080p (60Hz), 1080i (60Hz), 720p (60Hz), 480p, 480i
Audio	200 mV (rms) 22 k ohm or greater

### HDMI<sup>™</sup> input

HDMI <sup>™</sup> compliant	
HDCP compliant	
Suggested formats	See table on page 191
HDMI <sup>™</sup> Audio	Dolby <sup>®</sup> Digital and 2-channel Linear-PCM; 32/44.1/48 kHz sampling frequency; 16/20/24 bits per sample

**Digital audio output**

Optical type

**PC input**

15-Pin D-sub Analog RGB

**Wireless connection**

Standard	IEEE 802.11a/b/g/n/
Frequency Range	5.15-5.35 GHz, 5.47-5.725 GHz, 5.725-5.850 GHz, 2.400–2.473 GHz
Security	WEP 64/128, TKIP, AES, WPA/WPA2-PSK, WPS, None

**Ethernet**

IEEE 802.3.

**USB**

Universal Serial Bus Specification, Revision 1.1.

Universal Serial Bus Specification, Revision 2.0.

**SD card**

SD, SDHC and SDXC memory card

**Dimensions with table stand**

58L9300U	Width 51.4" (1306 mm)
	Height 33.7" (857 mm)
	Depth 14.7" (374 mm)
65L9300U	Width 57.6" (1463 mm)
	Height 37.0" (940 mm)
	Depth 14.7" (374 mm)
84L9300U	Width 75.4" (1916 mm)
	Height 47.0" (1195 mm)
	Depth 17.7" (450 mm)



## Weight (mass) with stand

58L9300U	78.3 lbs (35.5 kg)
65L9300U	108.0 lbs (49.0 kg)
84L9300U	169.7 lbs (77.0 kg)

## Operating conditions

Temperature	32° - 95° F (0° - 35° C)
Humidity	20 - 80% (no moisture condensation)

## Supplied accessories

- ❖ Universal remote control (2x AAA batteries)
  - ❖ CT-90427
- ❖ Resource Guide
- ❖ Pedestal and hardware
- ❖ Pedestal Stand Assembly instructions
- ❖ Warranty information
- ❖ Wireless QWERTY keyboard with touchpad (2x AA batteries)
- ❖ IR blaster cable
- ❖ Toshiba 3D glasses
  - ❖ For 58L9300U: FPT-AG03 (1x CR2032 battery) x 2
  - ❖ For 65L9300U/84L9300U: FPT-P100 x 4
- ❖ For 84L9300U:
  - ❖ AC power cord
  - ❖ Ferrite core attachment
  - ❖ Ferrite Core Attachment document

### NOTE

The Wireless QWERTY keyboard supplied with this TV is a standard U.S. layout keyboard. The accented characters for French and Spanish may not be available in certain cases.

## Acceptable signal formats for PC IN, and HDMI™, and 3D

### PC IN signal formats

#### NOTE

- ❖ The PC IN on this TV only accepts signal formats which are compliant with VESA-DMT as in the table below. Since some PCs input signals are different from the resolution and frequency described in the table below, the following problems may occur: incorrect display, false format detection, picture position failure, blur, or judder. In these cases, set the monitor output format on your computer to conform to any of the signals in the table below.
- ❖ The signals whose vertical frequency is 56 Hz, 70 Hz, 72 Hz, or 75 Hz are converted to a 60 Hz signal.
- ❖ When you connect a computer to this TV, it is recommended that you set the refresh rate of your computer to 60 Hz.
- ❖ The PC IN on this TV does not accept the Sync on Green, Composite Sync, and Interlace signals.

<i>Format</i>	<i>Resolution</i>	<i>V. Frequency</i>	<i>H. Frequency</i>	<i>Pixel Clock Frequency</i>	<i>VESA Standard (DMT)</i>
VGA	640 x 480	59.940/60 Hz	31.469/31.500 kHz	25.175/25.200 MHz	•
		72.809 Hz	37.861 kHz	31.500 MHz	•
		75.000 Hz	37.500 kHz	31.500 MHz	•
SVGA	800 x 600	56.250 Hz	35.156 kHz	36.000 MHz	•
		60.317 Hz	37.879 kHz	40.000 MHz	•
		72.188 Hz	48.077 kHz	50.000 MHz	•
		75.000 Hz	46.875 kHz	49.500 MHz	•
XGA	1024 x 768	60.004 Hz	48.363 kHz	65.000 MHz	•
		70.069 Hz	56.476 kHz	75.000 MHz	•
		75.029 Hz	60.023 kHz	78.750 MHz	•
WXGA	1280 x 768	59.995 Hz	47.396 kHz	68.250 MHz	•
		59.870 Hz	47.776 kHz	79.500 MHz	•
		74.893 Hz	60.289 kHz	102.250 MHz	•
	1360 x 768	60.015 Hz	47.712 kHz	85.500 MHz	•
SXGA	1280 x 1024	60.020 Hz	63.981 kHz	108.000 MHz	•
		75.025 Hz	79.976 kHz	135.000 MHz	•
WXGA1280	1280x800	59.810 Hz	49.702 kHz	83.500 MHz	•
		74.934 Hz	62.795 kHz	106.500 MHz	•
WXGA+	1440x900	59.887 Hz	55.935 kHz	106.500 MHz	•

## HDMI™ signal formats

**NOTE**

- ❖ The HDMI™ inputs on this TV only accept VGA, SVGA, XGA, WXGA, and SXGA signal formats which are compliant with VESA-DMT as in the table below. Since some computer, HDMI™, or DVI device input signals are different from the resolution and frequency described in the table below, the following problems may occur: incorrect display, false format detection, picture position failure, blur, or judder. In these cases, set the monitor output format on your computer, HDMI™, or DVI device to conform to any of the signals in the table below.
- ❖ The signals whose vertical frequency is 24 Hz, 56 Hz, 70 Hz, 72 Hz, or 75 Hz are converted to a 60 Hz signal.
- ❖ When you connect a computer to this TV, it is recommended that you set the refresh rate of your computer to 60 Hz.

<i>Format</i>	<i>Resolution</i>	<i>V. Frequency</i>	<i>H. Frequency</i>	<i>Pixel Clock Frequency</i>	<i>VESA Standard (DMT)</i>
VGA	640 x 480	59.940 Hz	31.469 kHz	25.175 MHz	•
		72.809 Hz	37.861 kHz	31.500 MHz	•
		75.000 Hz	37.500 kHz	31.500 MHz	•
SVGA	800 x 600	56.250 Hz	35.156 kHz	36.000 MHz	•
		60.317 Hz	37.879 kHz	40.000 MHz	•
		72.188 Hz	48.077 kHz	50.000 MHz	•
XGA	1024 x 768	75.000 Hz	46.875 kHz	49.500 MHz	•
		60.004 Hz	48.363 kHz	65.000 MHz	•
		70.069 Hz	56.476 kHz	75.000 MHz	•
WXGA	1280 x 768	75.029 Hz	60.023 kHz	78.750 MHz	•
		59.995 Hz	47.396 kHz	68.250 MHz	•
		59.870 Hz	47.776 kHz	79.500 MHz	•
SXGA	1280 x 1024	74.893 Hz	60.289 kHz	102.250 MHz	•
		60.015 Hz	47.712 kHz	85.500 MHz	•
		60.020 Hz	63.981 kHz	108.000 MHz	•
480i	720 x 480i	75.000 Hz	79.976 kHz	135.000 MHz	•
		59.940/60 Hz	15.734/15.750 kHz	27.000/27.027 MHz	
480p	720 x 480p	59.940/60 Hz	31.469/31.500 kHz	27.000/27.027 MHz	
720p	1280 x 720p	59.940/60 Hz	44.955/45.000 kHz	74.176/74.250 MHz	
1080i	1920 x 1080i	59.940/60 Hz	33.716/33.750 kHz	74.176/74.250 MHz	
1080p	1920 x 1080p	23.976/24 Hz	26.973/27.000 kHz	74.176/74.250 MHz	
		29.970/30 Hz	33.720/33.750 kHz	74.176/74.250 MHz	
		59.940/60 Hz	67.433/67.500 kHz	148.352/148.500 MHz	

### 3D Signal formats\*

<i>Resolution</i>	<i>Aspect ratio</i>	<i>V. Frequency</i>	<i>H. Frequency</i>	<i>Pixel Clock Frequency</i>	<i>3D Structure</i>
720 x 480p	16:9	59.940/60 Hz	31.469/31.500 kHz	54.000/54.054 MHz	Side by Side (full)
				27.000/27.027 MHz	Side by Side (half) Top and Bottom
1280 x 720p	16:9	59.940/60 Hz	90.0/89.91 kHz	148.352/148.500 MHz	Frame Packing
			44.955/45.000 kHz	74.176/74.250 MHz	Side by Side (half) Top and Bottom
1920 x 1080i	16:9	59.940/60 Hz	33.716/33.750 kHz	74.176/74.250 MHz	Side by Side (half) Top and Bottom
1920 x 1080p	16:9	23.976/24 Hz	54/53.94 kHz	148.352/148.500 MHz	Frame Packing
			26.973 kHz	74.176/74.250 MHz	Side by Side (half) Top and Bottom
		29.97/30 Hz	67.5/67.43 kHz	148.352/148.500 MHz	Frame Packing
		33.716/33.75 kHz	74.176/74.250 MHz	Side by Side (half) Top and Bottom	
		59.940/60 Hz	67.433/67.500 kHz	148.352/148.500 MHz	Side by Side (half) Top and Bottom

\*Some content may not be supported depending on the input source format.

\*In the 2D to 3D mode, the PC format resolution is only available at 60Hz.

\*The 3D function and 2D to 3D conversion function does not support all content depending on its input source format.

### 4K Video Support formats

<i>Resolution</i>	<i>Format</i>	<i>Compatible HDMI</i>
3840 x 2160	24/30Hz (4:4/4:2:2)	HDMI1.4
4096 x 2160	24Hz (4:4/4:2:2)	HDMI1.4

Because “4K” is a new format that makes use of new technologies, certain compatibility and/or performance issues are possible. Currently, no “4K” video content or standards, including, but not limited to, broadcasting or streaming, exists for “4K” televisions in general. This TV may not be compatible with such content and/or standards, if and when developed. Certain HDMI formats or still images exceeding “4K” resolution may not be supported. May require purchase of additional external hardware, software and/or services. Toshiba makes no representation or warranties about any future “4K” content, standards or services.

**Operating the TV with combination buttons**

You can directly operate the TV power, input, picture size, and picture mode by pressing a combination button while holding down a color button.

<b>Button Color</b>	<b>Combination Button</b>	<b>Behavior/Mode</b>
RED	INPUT	Power Off
	POWER	Power On
	1	Input 1
	2	Input 2
	3	Input 3
	4	Input 4
	5	Input 5
	6	Input 6
	7	Input 7
	8	Input 8
	0	ANT/CABLE
GREEN	MUTE	Mute On
	1	Native (picture size)
	2	4:3 (picture size)
	3	TheaterWide 1 (picture size)
	4	TheaterWide 2 (picture size)
	5	TheaterWide 3 (picture size)
	6	Full (picture size)
	7	Normal (picture size)
	8	Quad FHD (picture size)
YELLOW	MUTE	1/2 Mute On
	1	AutoView (picture mode)
	2	Dynamic (picture mode)
	3	Standard (picture mode)
	4	Movie (picture mode)
	5	- (picture mode)
	6	Store (picture mode)
	7	Game (picture mode)
	8	PC (picture mode)
	MUTE	Mute Off

# Appendix B

## Wireless QWERTY keyboard with touchpad

---

- ❖ How to enter French or Spanish characters using the Wireless QWERTY keyboard with touchpad
- ❖ For how to use the Wireless QWERTY keyboard with touchpad, refer to the User's Guide that comes with the keyboard.

### Setting the keyboard layout

Before entering French or Spanish characters, configure the following setting on the TV:

- 1 Press the **SETUP** button.
- 2 Select **Options > USB Keyboard Layout**.
- 3 Press the **OK** button.
- 4 Press the **▲/▼** (arrow) buttons to select **U.S. International Layout** and press the **OK** button.

For how to enter characters, refer to the table below:

---

**NOTE** The input characters may be different from the table below depending on the situation you are entering characters.

---

Printing Simultaneous Key	normal	Shift	Right Alt(Alt Gr)	Shift + Right Alt
a and A	a or A *1		á or Á *1	
b and B	b or B *1			
c and C	c or C *1		©	ç
d and D	d or D *1		Ð	ð
e and E	e or E *1		é or É *1	
f and F	f or F *1			
g and G	g or G *1			
h and H	h or H *1			
i and I	i or I *1		í or Í *1	
j and J	j or J *1			
k and K	k or K *1		œ or Œ *1	
l and L	l or L *1		ø or Ø *1	
m and M	m or M *1		μ	
n and N	n or N *1		ñ or Ñ *1	
o and O	o or O *1		ó or Ó *1	
p and P	p or P *1		ö or Ö *1	
q and Q	q or Q *1		ã or Ã *1	
r and R	r or R *1		®	
s and S	s or S *1		ß	§
t and T	t or T *1		þ or Þ *1	
u and U	u or U *1		ú or Ú *1	
v and V	v or V *1			
w and W	w or W *1		å or Å *1	
x and X	x or X *1			
y and Y	y or Y *1		ÿ or Ÿ *1	
z and Z	z or Z *1		æ or Æ *1	
1 and !	1	!	¡	
2 and @	2	@	²	
3 and #	3	#	³	
4 and \$	4	\$	¤	£
5 and %	5	%	€	
6 and ^	6		¼	
7 and &	7	&	½	
8 and *	8	*	¾	
9 and (	9	(	‘	
0 and )	0	)	’	
Spacebar	Space	Space		
- and _ (underscore)	-	_ (underscore)	¥	
= and +	=	+	×	÷
[ and {	[	{	«	“

Printing Simultaneous Key	normal	Shift	Right Alt(Alt Gr)	Shift + Right Alt
] and }	]	}	»	”
\backslash and	\		¬	
; and :	;	:	¶	°
‘ and “			´	¨
Grave Accent(`) and Tilde(~)				
, and <	,	<	ç or Ç *1	
. and >	.	>		
/ and ?	/	?	¿	
Keypad /	/	/		
Keypad *	*	*		
Keypad -	-	-		
Keypad +	+	+		
Keypad 1	1			
Keypad 2	2			
Keypad 3	3			
Keypad 4	4			
Keypad 5	5			
Keypad 6	6			
Keypad 7	7			
Keypad 8	8			
Keypad 9	9			
Keypad 0	0			
Keypad .	.			

\*1: Character is Depends on CapsLock On/Off



**International Key table**

To enter special characters, follow the table below:

Diacritic	press first (Dead key)	press second																
		Space	Ě	ě	Á	á	Ó	ó	Ú	ú	Ÿ	ý	Ī	ī	Ž	ž	Ř	ř
Acute	' or ´	'	Ě	ě	Á	á	Ó	ó	Ú	ú	Ÿ	ý	Ī	ī	Ž	ž	Ř	ř
Grave	`	`	Ě	ě	Á	á	Ó	ó	Ú	ú	Ÿ	ý	Ī	ī				
Umlaut	Shift + ' (")	"	Ě	ě	Á	á	Ó	ó	Ú	ú	Ÿ	ý	Ī	ī				
Tilde	Shift + ` (~)	~	Ě	ě	Á	á	Ó	ó	Ú	ú	Ÿ	ý	Ī	ī				
Circumflex	Shift + 6 (^)	^	Ě	ě	Á	á	Ó	ó	Ú	ú	Ÿ	ý	Ī	ī	Ž	ž		
Breve	Alt Gr + Shift + 9	˘	Ě	ě	Á	á	Ó	ó	Ú	ú			Ī	ī				
Háček	Alt Gr + Shift + . (>)	ˇ	Ě	ě	Á	á	Ó	ó	Ú	ú			Ī	ī	Ž	ž	Ř	ř
Double acute	Alt Gr + Shift + 2	˝					Ó	ó	Ú	ú								
Ogonek	Alt Gr + Shift + 8	˛	Ę	ę	Ą	ą	Q	q	U	u			Į	į				
Macron	Alt Gr + Shift + 3	ˉ	Ě	ě	Á	á	Ó	ó	Ú	ú	Ÿ	ý	Ī	ī				
Overdot	Alt Gr + .	˙	Ě	ě	Á	á	Ó	ó			Ÿ	ý	Ī	ī	Ž	ž	Ř	ř
Underdot	Alt Gr + Shift + -	˘	Ę	ę	Ą	ą	Q	q	U	u	Ÿ	ý	Ī	ī	Ž	ž	Ř	ř
Ring	Alt Gr + Shift + 0	0			Á	á			Ú	ú	Ÿ	ý						

Diacritic	press first (Dead key)	press second																		
		Space	M	m	N	n	P	p	W	w	S	s	G	g	K	k	L	l	C	c
Acute	' or ´	'	Ĺ	ĺ	Ń	ń	Ŕ	ř	Ŧ	ť	Š	š	Ğ	ğ	Ķ	ķ	Ļ	ļ	Č	č
Grave	`	`			Ń	ń			Ŧ	ť										
Umlaut	Shift + ' (")	"							Ŧ	ť										
Tilde	Shift + ` (~)	~			Ń	ń														
Circumflex	Shift + 6 (^)	^							Ŧ	ť	Š	š	Ğ	ğ					Č	č
Breve	Alt Gr + Shift + 9	˘											Ğ	ğ						
Háček	Alt Gr + Shift + . (>)	ˇ			Ń	ń				Š	š	Ğ	ğ	Ķ	ķ	Ļ	ļ	Č	č	
Double acute	Alt Gr + Shift + 2	˝																		
Ogonek	Alt Gr + Shift + 8	˛																		
Macron	Alt Gr + Shift + 3	ˉ																		
Overdot	Alt Gr + .	˙	Ĺ	ĺ	Ń	ń	Ŕ	ř	Ŧ	ť	Š	š	Ğ	ğ					Č	č
Underdot	Alt Gr + Shift + -	˘	Ĺ	ĺ	Ń	ń			Ŧ	ť	Š	š			Ķ	ķ	Ļ	ļ		
Ring	Alt Gr + Shift + 0	0							Ŧ	ť										

# Index

---

## Numerics

### 3D

- 2D from Quick menu 80
- 3D from Quick menu 78
- 3D lock 82
- 3D timer lock 83
- adjusting 2D to 3D depth 84
- auto start mode 81
- button operation 77
- change pin code 82
- delete pin code 82
- enable 3D timer 83
- enter new pin code 81
- forgotten pin code 82
- functions 73
- Native mode 80
- selecting format 76
- setting 3D pin code 81
- start message 82
- switch left right images 84
- switching display mode 76
- switching to 2D mode 79
- switching to 3D mode 78
- viewing images 75

### 4/3 stretch

- using 111

198

## A

### advanced picture settings

- 3D Judder Cancellation 118
- Ambient Light Sensor 116
- Base Color Adjustment 116
- ClearScan® 115
- Color temperature 117
- ColorMaster™ 116
- DNR 115
- DynaLight® 114
- Dynamic Contrast 114
- Fine Texture Restoration 118
- MPEG NR 115
- resetting to factory default 119
- Resolution+ 114
- using 114

### audio

- adjusting balance 122
- adjusting range 122
- Audyssey Dynamic Volume®  
126
- bass/treble 126
- Dolby® Digital Dynamic Range  
Control 124
- muting sound 122
- optical audio output format 123

Auto Aspect  
using 111

## C

### cables

- 3.5mm to RCA Y-cable 31
- analog RGB (15-pin) 31
- coaxial (F-type) 29
- component video (red/green/blue)  
30
- Dual-wand IR blaster cable 30
- HDMI™ 30
- LAN 32
- optical audio 31
- overview of cables 29
- standard A/V (red/white/yellow)  
29

channel return 85

### channels

- auto tuning 69
- labeling analog TV channels  
71
- labeling video inputs 72
- locking specific channels 93
- manual tuning 70
- next programmed channel 85
- skipping 70
- skipping video inputs 71
- specific channel 85
- storing in memory 69

### closed captions

- Analog CC mode 86
- button 89
- Digital CC settings 88
- using 86

### computer

- adjusting image 99
- setting the audio 100
- to the TV's HDMI™ 44
- using with the TV 99

### connecting

- a computer 43
- audio system 38
- cable TV 32
- camcorder 32
- computer to TV's PC IN 43
- DVD player with ColorStream®  
34
- DVI device to HDMI™ input  
39
- HDMI™ audio system 42
- HDMI™ device to HDMI™ input  
39
- IR devices 35
- satellite receiver 32
- to a computer (no Internet  
connection) 45
- to a home network 45
- to a home network (no Internet  
connection) 46
- to a home network (wired Internet  
connection) 47
- to a home network (wireless  
Internet connection) 48
- TV's HDMI™ 44
- VCR 34
- VCR and antenna 32

### control other devices

- HDMI™ -CEC Control 40

### control panel

- lock 94

### controlling other devices

- TV remote 40

## E

### expert picture settings

- RGB Filter 120
- setting 120
- Test Pattern 120
- White Balance 120

External Control Setup 172

**F**

Factory Defaults

reset 105

favorites

adding 146

browsing 145

features 21

**H**

HDMI™

viewing signal information 98

HDMI™ CEC

adjusting amplifier's audio 97

controlling playback devices

96

input source selection 97

other functions 97

HDMI™ CEC Control

using 95

HDMI™ settings feature

using 97

home network

using 127

**I**

icon

safety 20

IR Blaster Out terminal

using 35

IR Blaster setup 61

**M**

Media Renderer

device name setup 173

setup 172

MediaShare (Media Player)

basic operation 158

playing music files 166

specifications 157

viewing movie files 161

viewing photo files 168

**N**

network

advanced setup 134

connection test 136

DNS setup 135

quick setup 58

setup 129

wireless setup 129

Network Device Setup 171

no signal power down

set 102

**O**

overview

installation 22

setup 22

use 20

**P**

parental controls

blocking programs/movies by

rating (V-Chip) 90

using 90

picture

adjusting 112

adjusting quality 113

picture mode

selecting 112

picture size

4/3 108

4K Full 110

4K Native 110

4K Normal 110

Full 108

Native 107

Normal 109

Quad FHD 109

selecting 106

TheaterWide 1 108

TheaterWide 2 109

TheaterWide 3 109

- pin code
  - changing 82
  - deleting 82
  - entering new pin code 81
  - forgotten 82
  - setting pin code 81
- power failure 105
- program ratings
  - displaying 93
  - unlocking programs 93
- Q**
- quick setup
  - channel tuning 60
  - country 58
  - IR Blaster 61
  - network 58
  - smart TV 59
  - store / home mode 58
  - time zone 58
- R**
- rating system 92
  - downloading additional 91
- S**
- safety
  - icons 20
- scrolling the picture 111
- shared inputs
  - configuring 72
- SmartTV
  - using 142
- SmartTV™
  - Netflix® 143
  - VUDU™ 144
- software keyboard
  - using 137
- software licenses
  - show 139
- software upgrade
  - performing 139
- specifications
  - 3D Signal formats 192
  - acceptable signal formats 190
  - audio power 187
  - channel coverage 186
  - ColorStream® HD input 187
  - Digital audio output 188
  - ethernet 188
  - HDMI™ input 187
  - HDMI™ signal formats 191
  - mass (weight) 189
  - operating conditions 189
  - PC IN signal formats 190
  - PC input 188
  - power consumption 187
  - power source 186
  - remote, combination buttons 193
  - speaker type 187
  - supplied accessories 189
  - TV system 186
  - USB 188
  - video/audio terminals 187
  - wireless connection 188
- support information
  - show 104
- T**
- time limit
  - set for games 94
- timer
  - sleep timer 101
  - turn on TV 100
- troubleshooting 177
  - channel tuning problems 180
  - closed caption problems 181
  - contact Toshiba 185
  - HDMI™ 182
  - HDMI™ CEC Control problems 181
  - light indicator 185
  - light indicator functions 185

- MediaShare (Media Player)
  - problems 184
  - network problems 182
  - picture problems 178
  - Rating blocking problems 181
  - remote control problems 180
  - sound problems 180
  - wireless network problems 184

**TV connections**

- front 24
- side 24

**TV panel connections**

- back 25

**TV panel controls**

- front 24
- left side 24
- side 24

**TV remote**

- control other devices 50
- effective range 52
- functionality 52
- install batteries 50

**TV status information**

- show 103

**V****Video****video input**

- locking 94
- selecting 85

**W****web browser 144**

- access web page 145
- adding favorites 146
- browsing favorites 145

## Free Manuals Download Website

<http://myh66.com>

<http://usermanuals.us>

<http://www.somanuals.com>

<http://www.4manuals.cc>

<http://www.manual-lib.com>

<http://www.404manual.com>

<http://www.luxmanual.com>

<http://aubethermostatmanual.com>

Golf course search by state

<http://golfingnear.com>

Email search by domain

<http://emailbydomain.com>

Auto manuals search

<http://auto.somanuals.com>

TV manuals search

<http://tv.somanuals.com>