



# TOSHIBA



## COMBINATION FLAT COLOR TELEVISION AND VIDEO CASSETTE RECORDER / DVD VIDEO PLAYER

# MW24FPX MW27FPX

### OWNER'S MANUAL

Introduction 2

Connections 13

Basic setup 18

TV operation 23

Playback (VCR) 33

Recording (VCR) 38

Other functions (VCR) 42

Basic playback (DVD) 44

Advanced playback (DVD) 47

Function setup (DVD) 57

Others 61

VHS Hi-Fi

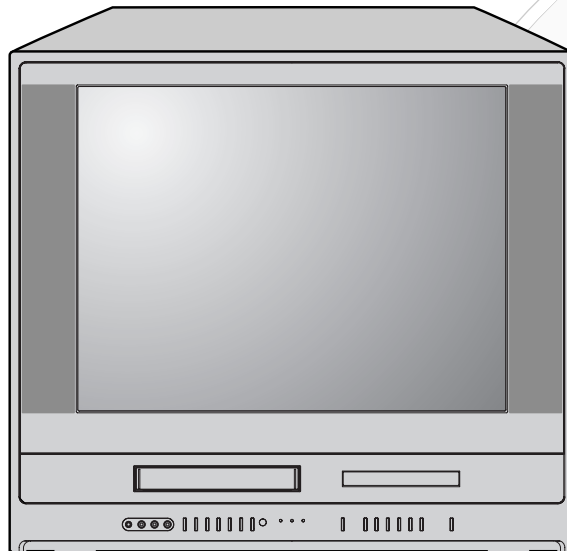

Illustration of MW24FPX

©2004 Toshiba Corporation  
This device does not tape-record copy protected DVD video discs.

# IMPORTANT SAFEGUARDS



**CAUTION**  
RISK OF ELECTRIC SHOCK  
DO NOT OPEN

**CAUTION:** TO REDUCE THE RISK OF ELECTRIC SHOCK, DO NOT REMOVE COVER (OR BACK). NO USER-SERVICEABLE PARTS INSIDE. REFER SERVICING TO QUALIFIED SERVICE PERSONNEL.



The lightning flash with arrowhead symbol, within an equilateral triangle is intended to alert the user to the presence of uninsulated dangerous voltage within the product's enclosure that may be of sufficient magnitude to constitute a risk of electric shock.



The exclamation point within an equilateral triangle is intended to alert the user to the presence of important operating and maintenance (servicing) instructions in the literature accompanying the appliance.

**WARNING:** TO PREVENT FIRE OR SHOCK HAZARD, DO NOT EXPOSE THIS APPLIANCE TO RAIN OR MOISTURE.

**WARNING:** This equipment has been tested and found to comply with the limits for a Class B digital device, pursuant to Part 15 of the FCC Rules. These limits are designed to provide reasonable protection against harmful interference in a residential installation. This equipment generates, uses and can radiate radio frequency energy and, if not installed and used in accordance with the instructions, may cause harmful interference to radio communications. However, there is no guarantee that interference will not occur in a particular installation. If this equipment does cause harmful interference to radio or television reception, which can be determined by turning the equipment off and on, the user is encouraged to try to correct the interference by one or more of the following measures:

- Reorient or relocate the receiving antenna.
- Increase the distance between the equipment and receiver.
- Connect the equipment into an outlet on a circuit different from that to which the receiver is connected.
- Consult the dealer or an experienced radio/TV technician for help.

**CAUTION:** Changes or modifications not expressly approved by the party responsible for compliance with the FCC (Federal Communications Commission) Rules could void the user's authority to operate this equipment.

**COPYRIGHT:** It is permissible to record television programs, films, video tapes and other material only in the event that third party copyrights and other rights are not violated.

**CAUTION:**  
THIS DIGITAL VIDEO PLAYER EMPLOYS A LASER SYSTEM.

TO ENSURE PROPER USE OF THIS PRODUCT, PLEASE READ THIS OWNER'S MANUAL CAREFULLY AND RETAIN FOR FUTURE REFERENCE. SHOULD THE UNIT REQUIRE MAINTENANCE, CONTACT AN AUTHORIZED SERVICE LOCATION-SEE SERVICE PROCEDURE.

USE OF CONTROLS, ADJUSTMENTS OR THE PERFORMANCE OF PROCEDURES OTHER THAN THOSE SPECIFIED HEREIN MAY RESULT IN HAZARDOUS RADIATION EXPOSURE.

TO PREVENT DIRECT EXPOSURE TO LASER BEAM, DO NOT TRY TO OPEN THE ENCLOSURE. VISIBLE LASER RADIATION MAY BE PRESENT WHEN THE ENCLOSURE IS OPENED. DO NOT STARE INTO BEAM.

### Location of the required Marking

The rating sheet and the safety caution are on the rear of the unit.

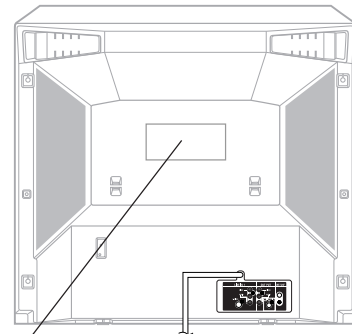

CERTIFICATION: COMPLIES WITH  
FDA RADIATION PERFORMANCE  
STANDARDS, 21 CFR SUBCHAPTER J.

**1. READ INSTRUCTIONS**

All the safety and operating instructions should be read before the unit is operated.

**2. RETAIN INSTRUCTIONS**

The safety and operating instructions should be retained for future reference.

**3. HEED WARNINGS**

All warnings on the unit and in the operating instructions should be adhered to.

**4. FOLLOW INSTRUCTIONS**

All operating and use instructions should be followed.

**5. CLEANING**

Unplug this unit from the wall outlet before cleaning. Do not use liquid cleaners or aerosol cleaners.

Use a damp cloth for cleaning the exterior cabinet only.

**6. ATTACHMENTS**

The manufacturer of this unit does not make any recommendations for attachments, as they may cause hazards.

**7. WATER AND MOISTURE**

Do not use this unit near water. For example, near a bathtub, washbowl, kitchen sink, laundry tub, in a wet basement, or near a swimming pool.

**8. ACCESSORIES**

Do not place this unit on an unstable cart, stand, tripod, bracket, or table.

The unit may fall, causing serious injury, and serious damage to the unit.

- 8A.** An appliance and cart combination should be moved with care. Quick stops, excessive force, and uneven surfaces may cause the appliance and cart combination to overturn.

**9. VENTILATION**

Slots and openings in the cabinet back or bottom are provided for ventilation, and to ensure reliable operation of the unit, and to protect it from overheating.

These openings must not be blocked or covered. The openings should never be blocked by placing the unit on a bed, sofa, rug, or other similar surface. This unit should never be placed near or over a radiator or heat source. This unit should not be placed in a built-in installation such as a bookcase or rack unless proper ventilation is provided or the manufacturer's instructions have been adhered to.

**10. POWER SOURCE**

This unit should be operated only from the type of power source indicated on the rating plate. If you are not sure of the type of power supply to your home, consult your appliance dealer or local power company. For units intended to operate from battery power, or other sources, refer to the respective pages on this Owner's Manual for their operating instructions.

**11. GROUNDING OR POLARIZATION**

This unit is equipped with a polarized alternating-current line plug (a plug having one blade wider than the other). This plug will fit into the power outlet only one way. This is a safety feature. If you are unable to insert the plug fully into the outlet, try reversing the plug. If the plug should still fail to fit, contact your electrician to replace your obsolete outlet. Instead of the polarized alternating-current line plug, your unit may be equipped with a 3-wire grounding-type plug (a plug having a third (grounding) pin). This plug will only fit into a grounding-type power outlet. This too, is a safety feature. If you are unable to insert the plug into the outlet, contact your electrician to replace your obsolete outlet.

Do not defeat the safety purpose of the grounding-type plug.

**12. POWER-CORD PROTECTION**

Power-supply cords should be routed so that they are not likely to be walked on or pinched by items placed upon or against them, paying particular attention to cords at plugs, convenience receptacles, and the point where they exit from the appliance.

PORTABLE CART WARNING  
(symbol provided by RETAC)



S3126A

# IMPORTANT SAFEGUARDS

(Continued)

## 13. LIGHTNING

To protect your unit from a lightning storm, or when it is left unattended and unused for long periods of time, unplug it from the wall outlet and disconnect the antenna or cable system. This will prevent damage to the unit due to lightning and power line surges.

## 14. POWER LINES

An outside antenna system should not be located in the vicinity of overhead power lines or other electric light or power circuits, or where it can fall onto or against such power lines or circuits. When installing an outside antenna system, extreme care should be taken to keep from touching such power lines or circuits, as contact with them might be fatal.

## 15. OVERLOADING

Do not overload wall outlets and extension cords, as this can result in a risk of fire or electric shock.

## 16. OBJECT AND LIQUID ENTRY

Do not push objects through any openings in this unit, as they may touch dangerous voltage points or short out parts that could result in fire or electric shock. Never spill or spray any type of liquid into the unit.

## 17. OUTDOOR ANTENNA GROUNDING

If an outside antenna or cable system is connected to the unit, be sure the antenna or cable system is grounded to provide some protection against voltage surges and built-up static charges, Section 810 of the National Electrical Code (NEC), ANSI/NFPA 70, provides information with respect to proper grounding of the mast and supporting structure, grounding of the lead-in wire to an antenna discharge unit, size of grounding conductors, location of antenna discharge unit, connection to grounding electrodes, and requirements for the grounding electrode.

## 18. SERVICING

Do not attempt to service this unit yourself as opening or removing covers may expose you to dangerous voltage or other hazards. Refer all servicing to qualified service personnel.

For example:

- a. When the power-supply cord or plug is damaged.
- b. If liquid has been spilled, or objects have fallen into the unit.
- c. If the unit has been exposed to rain or water.
- d. If the unit does not operate normally by following the operating instructions. Adjust only those controls that are covered by the operating instructions, as an improper adjustment of other controls may result in damage and will often require extensive work by a qualified technician to restore the unit to its normal operation.
- e. If the unit has been dropped or the cabinet has been damaged.
- f. When the unit exhibits a distinct change in performance, this indicates a need for service.

## 19. REPLACEMENT PARTS

When replacement parts are required, be sure the service technician uses replacement parts specified by the manufacturer or those that have the same characteristics as the original part. Unauthorized substitutions may result in fire, electric shock or other hazards.

## 20. SAFETY CHECK

Upon completion of any service or repairs to this unit, ask the service technician to perform safety checks to determine that the unit is in proper operating condition.

## 21. HEAT

The product should be situated away from heat sources such as radiators, heat registers, stoves, or other products (including amplifiers) that produce heat.

## 22. DISC TRAY

Keep your fingers well clear of the disc tray as it is closing. It may cause serious personal injury.

## 23. CONNECTING

When you connect the product to other equipment, turn off the power and unplug all of the equipment from the wall outlet. Failure to do so may cause an electric shock and serious personal injury. Read the owner's manual of the other equipment carefully and follow the instructions when making any connections.

## 24. SOUND VOLUME

Reduce the volume to the minimum level before you turn on the product. Otherwise, sudden high volume sound may cause hearing or speaker damage.

## 25. SOUND DISTORTION

Do not allow the product output distorted sound for a longtime. It may cause speaker overheating and fire.

## 26. HEADPHONES

When you use the headphones, keep the volume at a moderate level. If you use the headphones continuously with high volume sound, it may cause hearing damage.

**27. LASER BEAM**

Do not look into the opening of the disc tray or ventilation opening of the product to see the source of the laser beam. It may cause sight damage.

**28. DISC**

Do not use a cracked, deformed, or repaired disc. These discs are easily broken and may cause serious personal injury and product malfunction.

**29. NOTE TO CABLE TV SYSTEM INSTALLER**

This reminder is provided to call the Cable TV system installer's attention to Article 820-40 of the NEC that provides guidelines for proper grounding and, in particular, specifies that the cable ground shall be connected to the grounding system of the building, as close to the point of cable entry as practical.

EXAMPLE OF ANTENNA GROUNDING AS PER THE  
NATIONAL ELECTRICAL CODE

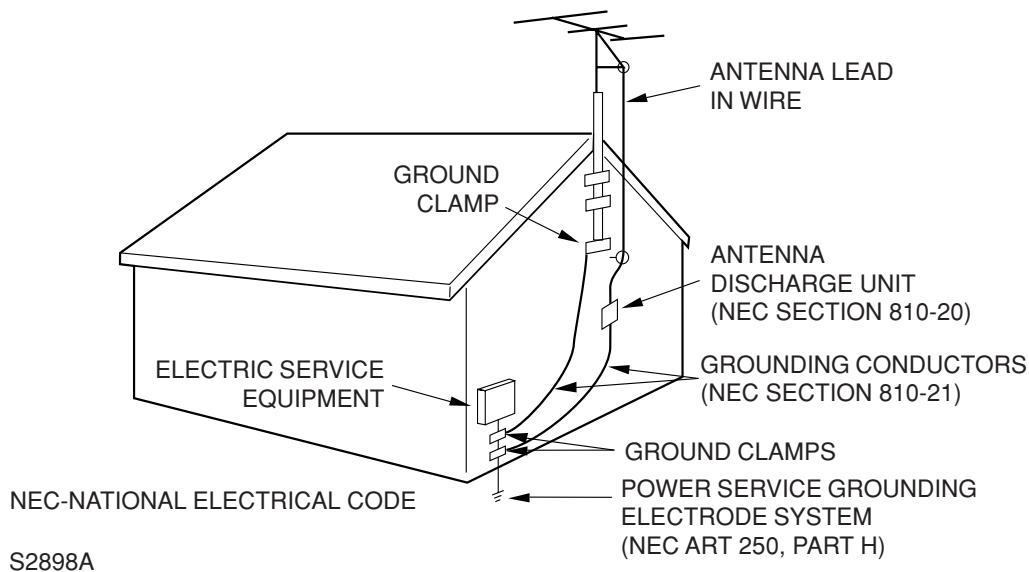

## IMPORTANT RECYCLING INFORMATION

This product uses both Cathode Ray Tube (CRT) and other components that contain lead. In your community there might be regulations that require you to dispose these materials properly under environmental considerations. Please contact your local authorities, or the Electronic Industries Alliance (<http://www.eiae.org>) for disposal or recycling information.

### Power source

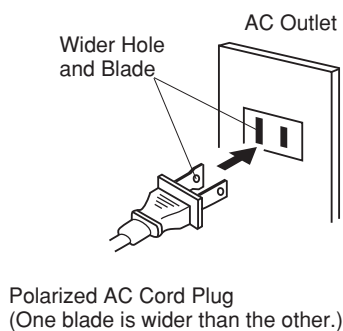

#### TO USE AC POWER SOURCE

Use the AC polarized line cord provided for operation on AC. Insert the AC cord plug into a standard 120V 60Hz polarized AC outlet.

#### Notes:

- Never connect the AC line cord plug to other than the specified voltage (120V 60Hz). Use the attached power cord only.
- If the polarized AC cord does not fit into a non-polarized AC outlet, do not attempt to file or cut the blade. It is the user's responsibility to have an electrician replace the obsolete outlet.
- If you cause a static discharge when touching the unit and the unit fails to function, simply unplug the unit from the AC outlet and plug it back in. The unit should return to normal operation.
- If the AC cord plug is plugged in for the first time, wait for approx. 5 seconds before pressing the POWER button.

## Precautions

### Notes on handling

- When shipping the unit, the original shipping carton and packing materials come in handy. For maximum protection, repack the unit as it was originally packed at the factory.
- Do not use volatile liquids, such as insect spray, near the unit. Do not leave rubber or plastic products in contact with the unit for a long time. They will leave marks on the finish.
- The top and rear panels of the unit may become warm after a long period of use. This is not a malfunction.
- When the unit is not in use, be sure to remove the disc and the video cassette turn off the power.
- If you do not use the unit for a long period, the unit may not function properly in the future. Turn on and use the unit occasionally.

### Notes on locating

- Place the unit on a level surface. Do not use it on a shaky or unstable surface such as a wobbling table or inclined stand. The loaded disc or the video tape may come off the proper position and cause damage to the unit.
- When you place this unit near a TV, radio, or VCR, the playback picture may become poor and the sound may be distorted. In this case, place the unit away from the TV, radio, or VCR.

### Notes on cleaning

Use a soft, dry cloth for cleaning.

- For stubborn dirt, soak the cloth in a weak detergent solution, wring well and wipe. Use a dry cloth to wipe it dry.  
Do not use any type of solvent, such as thinner and benzene, as they may damage the surface of the unit.
- If you use a chemical saturated cloth to clean the unit, follow that product's instructions.

### To obtain a clear picture

The unit is a high technology, precision device. If the video head, the head drum, the optical pick-up lens and disc drive parts are dirty or worn down, the picture quality becomes poor. To obtain a clear picture, we recommend regular inspection and maintenance (cleaning or parts replacement) every 1,000 hours of use depending on the operating environment. For details, contact your nearest dealer.

### Notes on moisture condensation

**Moisture condensation damages the unit. Please read the following carefully.**

Moisture condensation occurs, for example, when you pour a cold drink into a glass on a warm day. Drops of water form on the outside of the glass. In the same way, moisture may condense on the head drum or the optical pick-up lens inside this unit, one of the most crucial internal parts of the unit.

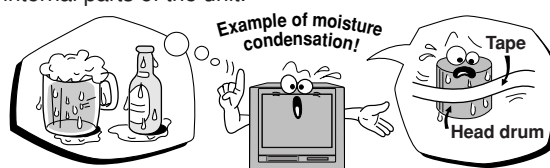

**Moisture condensation occurs during the following cases.**

- When you bring the unit directly from a cold place to a warm place.
- When you use the unit in a room where you just turned on the heater, or a place where the cold wind from the air conditioner directly hits the unit.
- In summer, when you use the unit in a hot and humid place just after you move the unit from an air conditioned room.
- When you use the unit in a humid place.

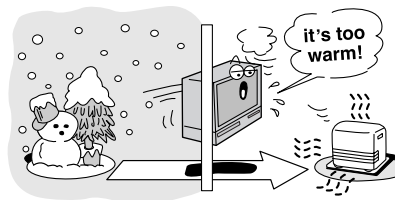

**Do not use the unit when moisture condensation may occur.**

If you use the unit in such a situation, it may damage discs and internal parts. Remove the disc or the video tape, connect the power cord of the unit to the wall outlet, turn on the unit, and leave it for two or three hours. After two or three hours, the unit will have warmed up and evaporated any moisture. Keep the unit connected to the wall outlet and moisture condensation will seldom occur.

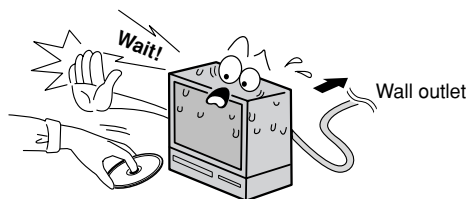

# Notes on discs

## On handling discs

- Do not touch the playback side of the disc.

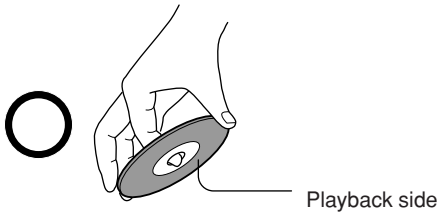

- Do not attach paper or tape to discs.



## On cleaning discs

- Fingerprints and dust on the disc cause picture and sound deterioration. Wipe the disc from the center outwards with a soft cloth. Always keep the disc clean.

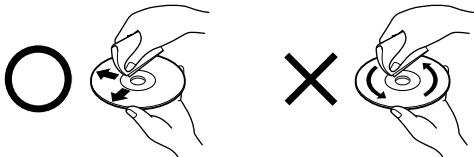

- If you cannot wipe off the dust with a soft cloth, wipe the disc lightly with a slightly moistened soft cloth and finish with a dry cloth.
- Do not use any type of solvent such as thinner, benzine, commercially available cleaners or antistatic spray for vinyl LPs. It may damage the disc.

## On storing discs

- Do not store discs in a place subject to direct sunlight or near heat sources.
- Do not store discs in places subject to moisture and dust such as a bathroom or near a humidifier.
- Store discs vertically in a case. Stacking or placing objects on discs outside of their case may cause warping.

## Structure of disc contents

Normally, DVD video discs are divided into titles, and the titles are sub-divided into chapters. Video CDs and Audio CDs are divided into tracks.

DVD video disc

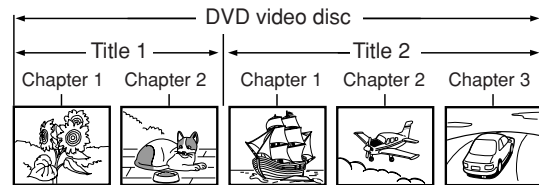

Video CD/Audio CD

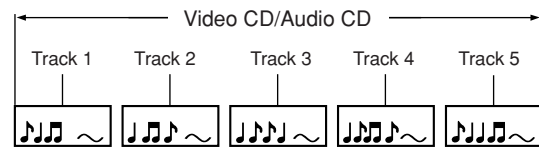

Each title, chapter or track is assigned a number, which is called "title number", "chapter number" or "track number" respectively.

There may be discs that do not have these numbers.

## Notes on copyright

It is forbidden by law to copy, broadcast, show, broadcast on cable, play in public, and rent copyrighted material without permission.

This device does not tape-record copy protected DVD Video Discs.

The device is not to be used for copying copyrighted content without the express written permission of the copyright owner.





Obtaining such permission is the sole responsibility of the user.

This product incorporates copyright protection technology that is protected by method claims of certain U.S. patents and other intellectual property rights owned by Macrovision Corporation and other rights owners. Use of this copyright protection technology must be authorized by Macrovision Corporation, and is intended for home and other limited viewing uses only unless otherwise authorized by Macrovision Corporation. Reverse engineering or disassembly is prohibited.



## Notes on discs (Continued)

### About this owner's manual

This owner's manual explains the basic instructions of this unit. Some DVD video discs are produced in a manner that allows specific or limited operation during playback. As such, the unit may not respond to all operating commands. This is not a defect in the unit. Refer to instruction notes of discs.

“” may appear on the TV screen during operation. A “” means that the operation is not permitted by the unit or the disc. For example, sometimes it is unable to stop the playback of copyright message of the disc when the STOP () button is pressed. Alternatively, the “” may also indicate that the feature is not available for the disc.

### Notes on region numbers

The region number of this unit is 1. If region numbers, which stand for their playable area, are printed on your DVD video disc and you do not find  or , disc playback will not be allowed by the player. (In this case, the unit will display a message on-screen.)

### On Video CDs

This DVD supports Video CDs equipped with the PBC (Version 2.0) function. (PBC is the abbreviation of Playback Control.) You can enjoy two playback variations depending on types of discs.

- **Video CD not equipped with PBC function (Version 1.1)**  
Sound and movie can be played on this DVD in the same way as an audio CD.
- **Video CD equipped with PBC function (Version 2.0)**  
In addition to operation of a Video CD not equipped with the PBC function, you can enjoy playback of interactive software with search function by using the menu displayed on the TV screen (Menu Playback). Some of the functions described in this owner's manual may not work with some discs.

### Playable discs

This unit can play the following discs.

	Disc Mark	Contents	Disc Size	Maximum playback time
DVD video discs		Audio + Video (moving pictures)	12 cm	Approx. 4 hours (single sided disc) Approx. 8 hours (double sided disc)
			8 cm	Approx. 80 minutes (single sided disc) Approx. 160 minutes (double sided disc)
Video CDs		Audio + Video (moving pictures)	12 cm	Approx. 74 minutes
			8 cm	Approx. 20 minutes
Audio CDs		Audio	12 cm	Approx. 74 minutes
			8 cm (CD single)	Approx. 20 minutes

The following discs are also available.

- DVD-R/RW discs of Video format
- CD-R/CD-RW discs of CD-DA, Video CD, MP3, WMA or JPEG format
- Kodak Picture CD and FUJICOLOR CD format

Some of these discs may be incompatible.

- You cannot play discs other than those listed above.
- You cannot play discs of DVD-RAM, DVD-ROM, Photo CD, etc., or non standardized discs even if they may be labeled as above.
- Some CD-R/RWs can not be played back depending on the recording conditions.
- This unit uses the NTSC color system, and cannot play DVD video discs recorded in any other color system (PAL, SECAM, etc.).





# Contents

## Introduction

IMPORTANT SAFEGUARDS .....	2
Precautions .....	6
Notes on discs .....	7
Contents .....	9
Identification of controls .....	10

## Connections

Antenna connections .....	13
Cable TV connections .....	14
Connecting to optional equipment .....	15

## Basic setup

Starting setup .....	18
Clock setting .....	19
Setting the language .....	22
TV/VCR operation status .....	22

## TV operation

TV operation .....	23
Closed captions .....	25
To memorize channels .....	26
Setting the V-Chip .....	27
To set the on timer .....	29
To set the off timer .....	30
Picture control adjustment .....	31
Adjusting the picture preference .....	31
Sound control adjustment .....	32
Stereo and Second Audio Program (SAP) .....	32

## Playback (VCR)

Loading and unloading a cassette tape .....	33
Cassette tape playback .....	34
Special playback .....	35
Convenient function .....	36

## Recording (VCR)

Recording a TV program .....	38
One-touch Timer Recording (OTR) .....	39
Timer recording .....	40

## Other functions (VCR)

Duplicating a video tape .....	42
Recording a DVD/CD disc .....	43

## Basic playback (DVD)

Playing a disc .....	44
----------------------	----

## Advanced playback (DVD)

Zooming .....	47
Locating desired scene .....	47
Repeat playback .....	48
A-B Repeat playback .....	48
Program playback .....	49
Random playback .....	49
Changing angles .....	50
Title selection .....	50
DVD menu .....	50
Changing soundtrack language .....	51
Subtitles .....	51
Karaoke playback .....	52
Disc status .....	52
To turn off the PBC .....	52
MP3/WMA/JPEG CD operation .....	53
Selecting PROGRESSIVE scan .....	56

## Function setup (DVD)

Customizing the function settings .....	57
Temporary disabling of rating level by DVD disc .....	60

## Others

Language code list .....	61
Troubleshooting .....	62
Reception disturbances .....	64
Specifications .....	65
Limited warranty .....	66

Introduction

# Identification of controls

See the page in □ for details.

This owner's manual uses the illustrations of MW24FPX. MW27FPX model has some differences in appearance from the illustrations. Example: Model MW27FPX has a door on the front panel.

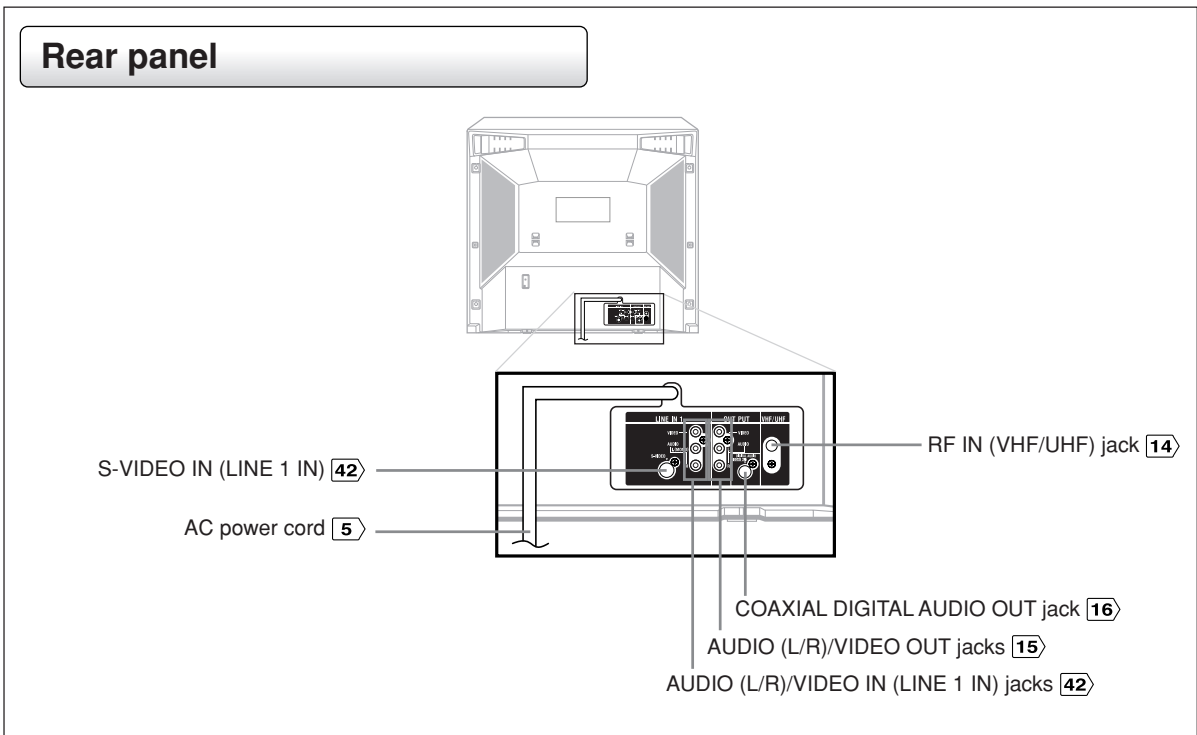
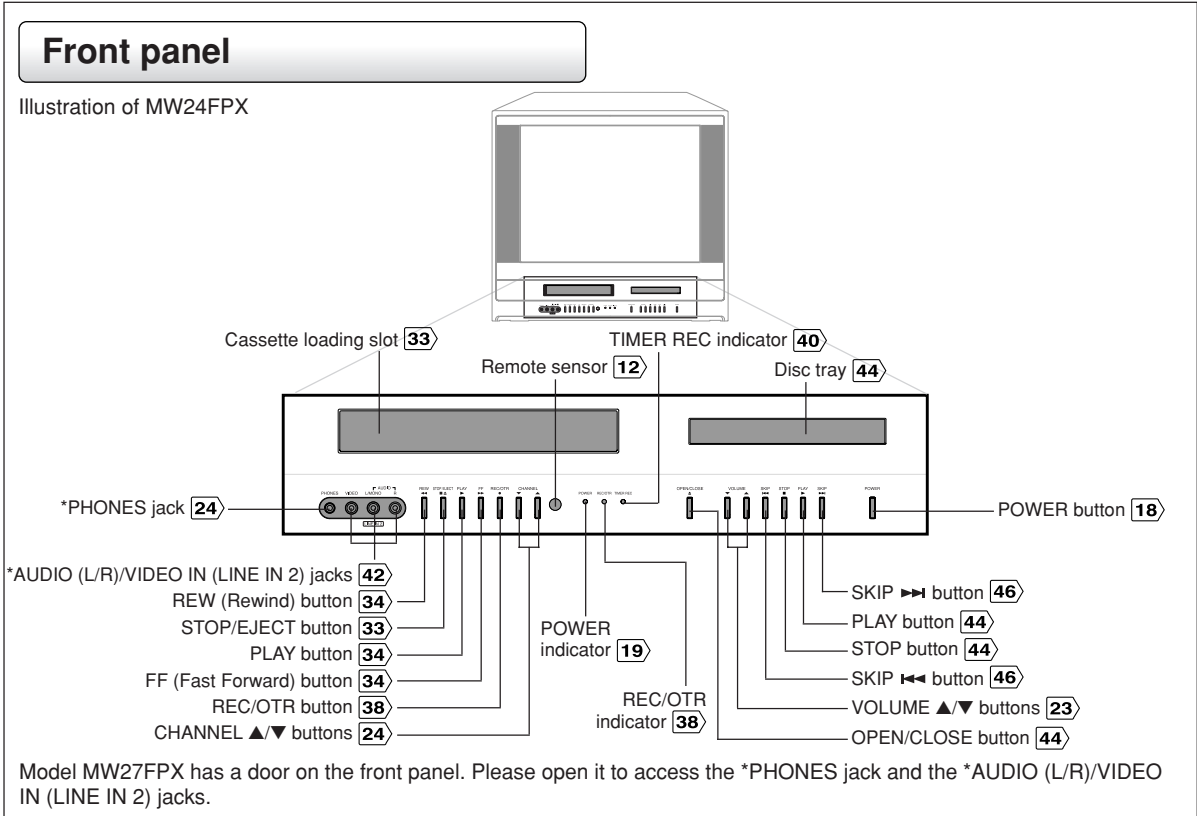



## Remote control

The instructions in this manual describe the functions on the remote control. See the page in for details.

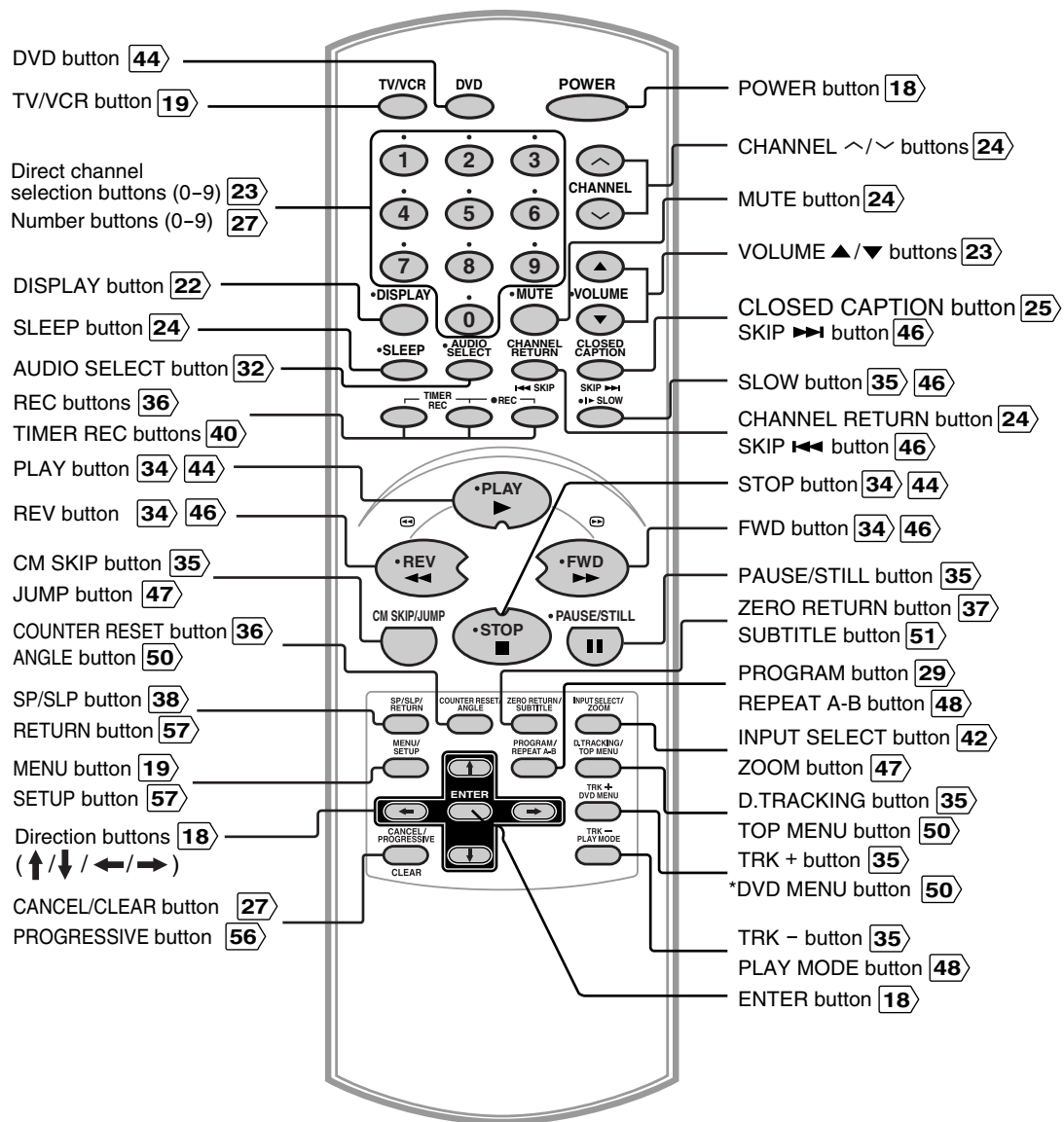

### \* DVD MENU button

Use the DVD MENU button to display the menu included on many DVD video discs. To operate a menu, follow the instructions in "DVD menu". **50**

## Identification of controls (continued)

### Inserting batteries

- 1** Slide the battery compartment cover in the direction of the arrow.

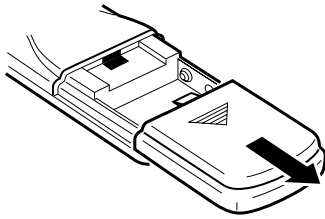

- 2** Install two "R03/AAA" batteries (supplied), paying attention to the polarity diagram in the battery compartment.

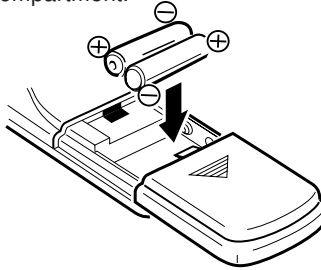

- 3** Replace the compartment cover.

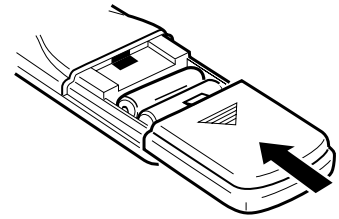

#### Battery precautions:

The precautions below should be followed when using batteries in this device:

1. Use only the size and type of batteries specified.
2. Be sure to follow the correct polarity when installing the batteries as indicated in the battery compartment. Reversed batteries may cause damage to the device. To avoid a potential short circuit, insert the "-" end first.
3. Do not mix different types of batteries together (e.g. Alkaline and Carbon-zinc) or old batteries with fresh ones.
4. If the device is not to be used for a long period of time, remove the batteries to prevent damage or injury from possible battery leakage.
5. Do not try to recharge batteries not intended to be recharged; they can overheat and rupture. (Follow battery manufacturer's directions.)

### Remote control basics

- Press **POWER** to turn the unit on or off.
- Select your desired operating mode (TV/VCR or DVD) using **TV/VCR** or **DVD**.
- Tap **CHANNEL**  $\wedge$  or  $\vee$  to move through the channels one channel at a time.
- The **Direction** buttons ( $\uparrow/\downarrow/\leftarrow/\rightarrow$ ) are also used to navigate on-screen menu system.
- You can directly access specific channels using **Direct channel selection** buttons.

#### Operation:

- Aim the remote control at the remote sensor and press control buttons to operate.
- Operate the remote control within 30° angle on either side of the remote sensor, up to a distance of approx. 5 meters.

Illustration of MW24FPX

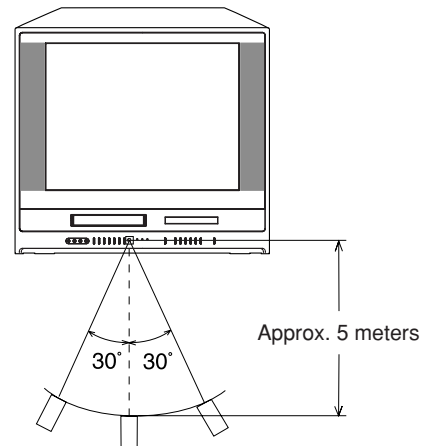

## Antenna connections

If you are using an indoor or outdoor antenna, follow the instructions below that correspond to your antenna system. If you are using a cable TV service (CABLE), see page 14 for Cable TV connections.

### Combination VHF/UHF antenna (Single 75 ohm cable or 300 ohm twin-lead wire)

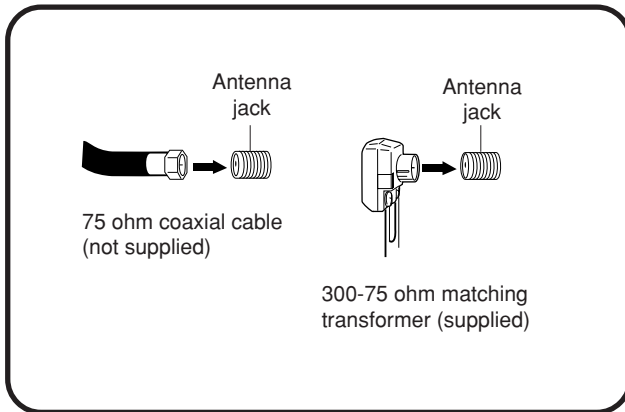

Connect the 75 ohm cable from the combination VHF/UHF antenna to the antenna jack.

If your combination VHF/UHF antenna has a 300 ohm twin-lead wire, the use of the 300-75 ohm matching transformer may be necessary.

Connections

### Combination VHF/UHF antenna (Separate VHF and UHF 300 ohm twin-lead wires)

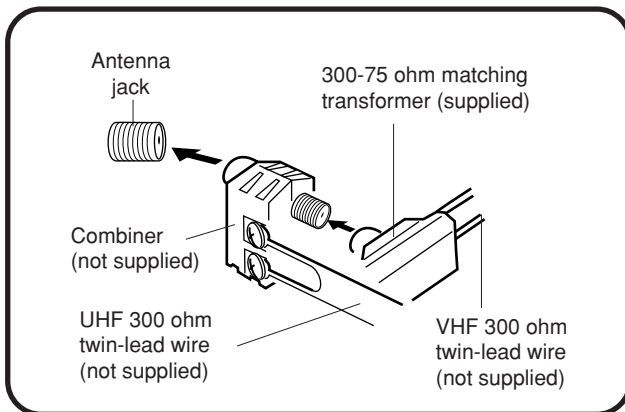

Connect the UHF 300 ohm twin-lead wire to the combiner (not supplied). Connect the VHF 300 ohm twin-lead wire to the 300-75 ohm matching transformer. Attach the transformer to the combiner, then attach the combiner to the antenna jack.

### Separate VHF/UHF antennas (75 ohm VHF cable and 300 ohm UHF twin-lead wires)

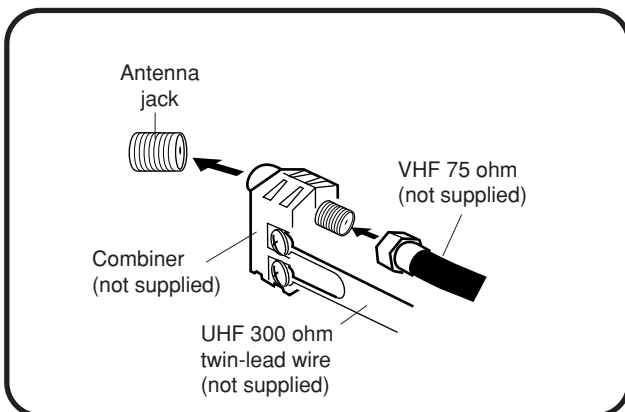

Connect the VHF 75 ohm cable and UHF 300 ohm twin-lead wire to the combiner (not supplied). Attach the combiner to the antenna jack.

## Cable TV connections

This unit has an extended tuning range and can tune most cable channels without using a Cable TV converter box. Some cable companies offer "premium pay channels" in which the signal is scrambled. Descrambling these signals for normal viewing requires the use of a descrambler device which is generally provided by the cable company.

### For subscribers to basic cable TV service

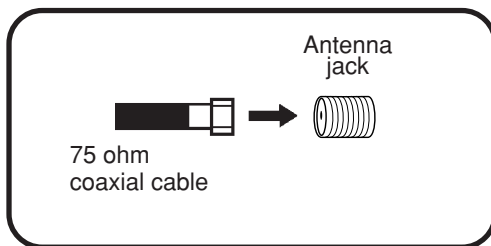

For basic cable service not requiring a converter/descrambler box, connect the Cable TV 75 ohm coaxial cable directly to the Antenna jack on the back of the unit.

### For subscribers to scrambled cable TV service

If you subscribe to a cable TV service which requires the use of a converter/descrambler box, connect the incoming 75 ohm coaxial cable to the converter/descrambler box. Using another 75 ohm coaxial cable, connect the output jack of the converter/descrambler box to the antenna jack on the unit. Follow the connections shown below. Set the unit to the output channel of the converter/descrambler box (usually channel 3 or 4) and use the converter/descrambler box to select channels.

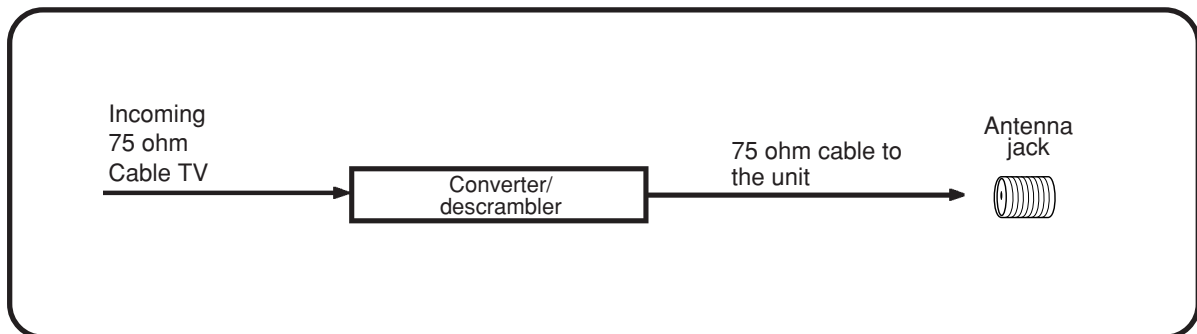

### For subscribers to unscrambled basic cable TV service with scrambled premium channels

If you subscribe to a cable TV service in which basic channels are unscrambled and premium channels require the use of a converter/descrambler box, you may wish to use a signal splitter and an A/B Switch box (available from the cable company or an electronics supply store). Follow the connections shown below. With the switch in the "B" position, you can directly tune any unscrambled channels on your unit. With the switch in the "A" position, tune your unit to the output of the converter/descrambler box (usually channel 3 or 4) and use the converter/descrambler box to tune scrambled channels.

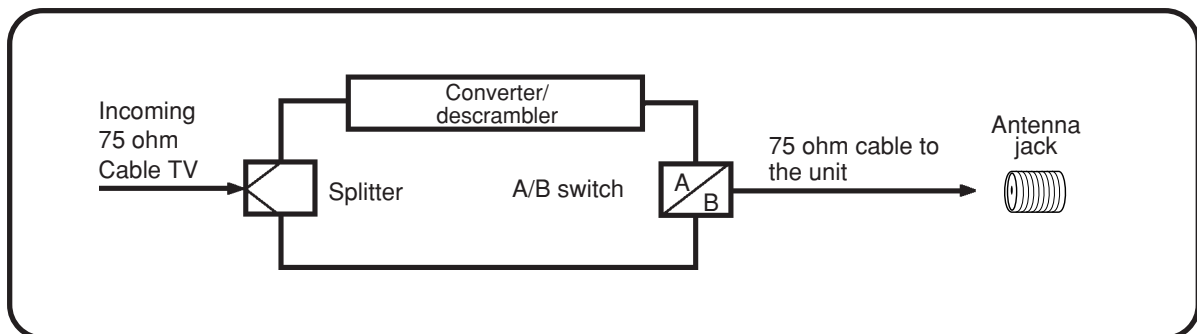



## Connecting to optional equipment

Before connecting the unit to other equipment, be sure to turn off the power and unplug all of the equipment from the wall outlet before making any connections. You can enjoy the TV game, camcorder or high quality dynamic sounds of DVD video discs or audio CDs by connecting the unit to optional audio equipment.

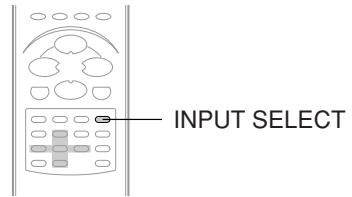

### Using the audio/video inputs

Press **INPUT SELECT** repeatedly to select the desired mode. "LINE1", "LINE2" or TV channel will display on the screen for 4 seconds.

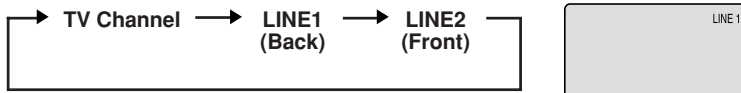

**Note:** In the DVD mode this key will not operate.

### Connecting a camcorder or a TV game

To playback from the camcorder or playing a TV Game, connect the camcorder to the unit as shown.

➔ Signal flow

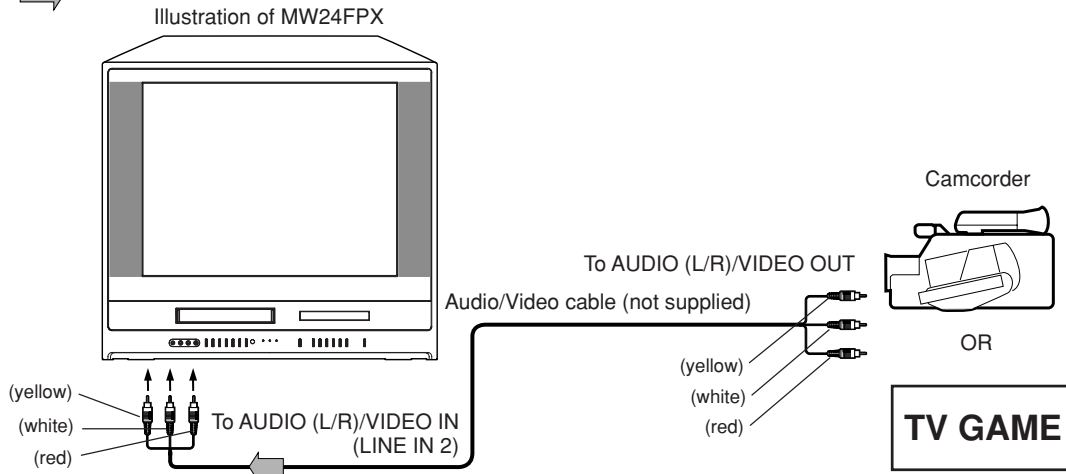

**Note:** Model MW27FPX has a door on the front panel. Please open it to access the AUDIO (L/R)/VIDEO IN (LINE IN 2) jacks.

### Connecting to an audio system

Connect the unit to your audio system.

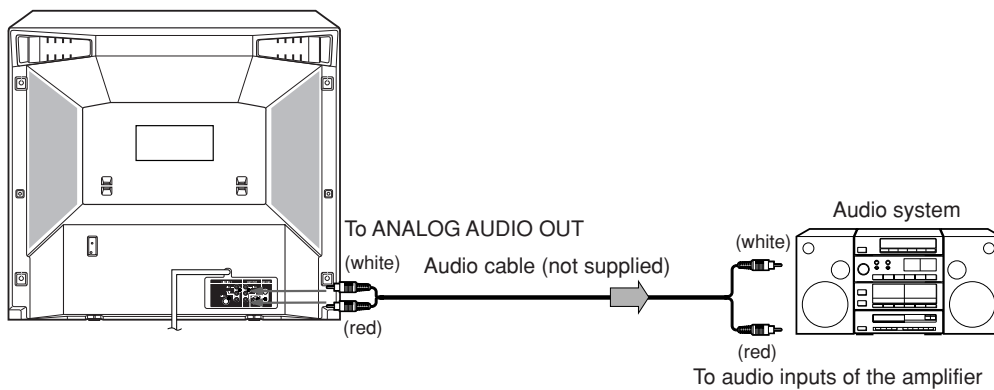

## Connecting to optional equipment

You can enjoy high quality dynamic sounds by connecting the unit to optional audio equipment.

\* This section uses the following reference mark.

■ : Front speaker	□ : Center speaker
■ : Rear speaker	⇒ : Signal flow
■ : Sub woofer	

### Connecting to an amplifier equipped with a Dolby Digital decoder

#### Dolby Digital

Dolby Digital is the surround sound technology used in theaters showing the latest movies, and is now available to reproduce this realistic effect in the home. You can enjoy motion picture and live concert DVD video discs with this dynamic realistic sound by connecting the DVD video player to a 6 channel amplifier equipped with a Dolby Digital decoder or Dolby Digital processor. If you have a Dolby Surround Pro Logic decoder, you will obtain the full benefit of Pro Logic from the same DVD movies that provide full 5.1-channel Dolby Digital soundtracks, as well as from titles with the Dolby Surround mark.

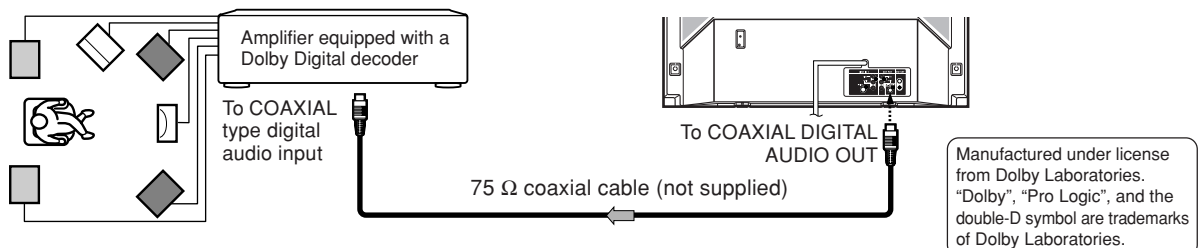

### Connecting to an amplifier equipped with Dolby Surround Pro Logic

#### Dolby Surround Pro Logic

You can enjoy the dynamic realistic sound of Dolby Surround Pro Logic by connecting an amplifier and speaker system (right and left front speakers, a center speaker, and one or two rear speakers).

- With an amplifier equipped with Dolby Digital  
Connect the equipment the same way as described in "Connecting to an amplifier equipped with a Dolby Digital decoder." Refer to that amplifier's owner's manual and set the amplifier so you can enjoy Dolby Surround Pro Logic sound.
- With an amplifier not equipped with Dolby Digital  
Connect the equipment as follows.
  - This connection is only suitable for Video CDs and Audio CDs.

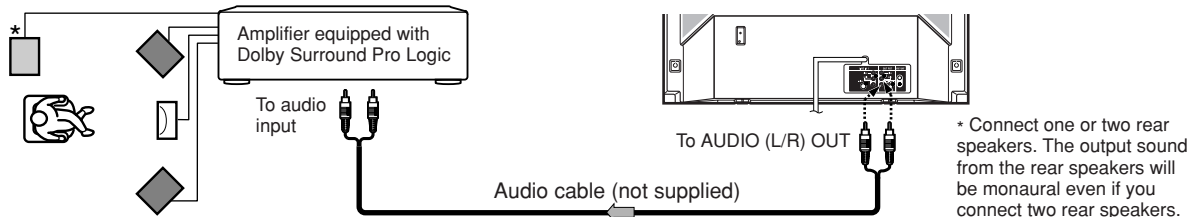

### Connecting to an amplifier equipped with a DTS decoder

#### Digital Theater Systems (DTS)

DTS is a high quality surround technology used in theaters and now available for home use, on DVD video discs or audio CDs. If you have a DTS decoder or processor, you can obtain the full benefit of 5.1 channel DTS encoded sound tracks on DVD video discs or audio CDs.

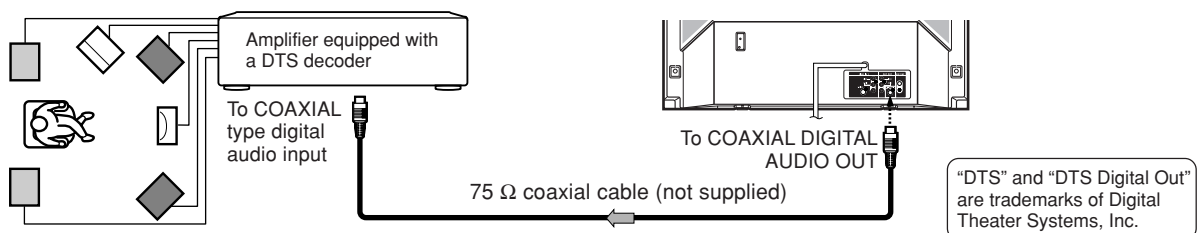





## Connecting to an amplifier equipped with a MPEG audio decoder

### MPEG2 sound

You can enjoy motion picture and live concert DVD video discs with dynamic realistic sound by connecting an amplifier equipped with an MPEG2 audio decoder or MPEG2 audio processor.

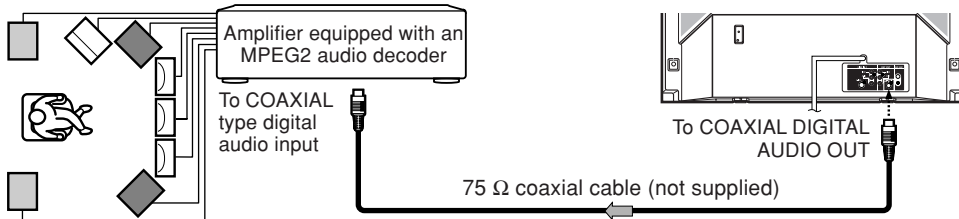

## Connecting to an amplifier equipped with a digital audio input

### 2 channel digital stereo

You can enjoy the dynamic sound of 2 channel digital stereo by connecting an amplifier equipped with a digital audio input and speaker system (right and left front speakers).

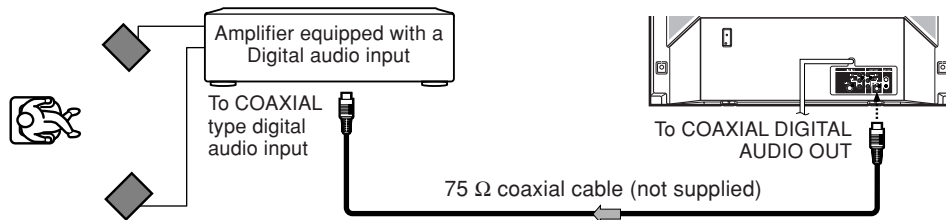

### Notes:

- DO NOT connect the COAXIAL DIGITAL AUDIO OUT jack of the unit to the AC-3 RF input of a Dolby Digital Receiver. This input on your A/V Receiver is reserved for Laserdisc use only and is incompatible with the COAXIAL DIGITAL AUDIO OUT jack of the unit.
- Connect the COAXIAL DIGITAL AUDIO OUT jack of the unit to the "COAXIAL" input of a Receiver or Processor.
- Refer to the owner's manual of the connected equipment as well.
- When you connect the unit to other equipment, be sure to turn off the power and unplug all of the equipment from the wall outlet before making any connections.
- The output sound of the unit has a wide dynamic range. Be sure to adjust the receiver's volume to a moderate listening level. Otherwise, the speakers may be damaged by a sudden high volume sound.
- Turn off the amplifier before you connect or disconnect the unit's power cord. If you leave the amplifier power on, the speakers may be damaged.

## Starting setup

The STARTING SETUP function makes installing your unit easily. It leads you the Language selection, TV/CABLE selection and auto channel memory automatically.

**IMPORTANT:** Make sure that the antenna or cable TV system connection is made!

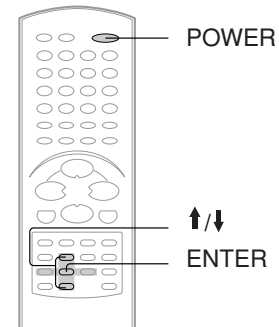

### Starting setup

- 1** Press **POWER**.  
The starting setup function begins and the Language setup menu appears on the screen. Press **↑** or **↓** to select your desired language, then press **ENTER**.

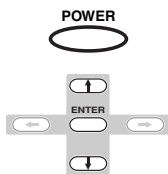

- 2** Press **↑** or **↓** to select "TV" or "CABLE", then press **ENTER**.

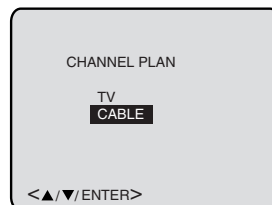
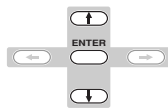

- 3** Press **↑** or **↓** to select "START", then press **ENTER**.  
If you select "CANCEL" and press **ENTER**, the STARTING SETUP stops and changes to the TV screen.

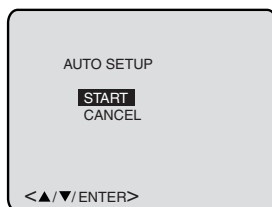
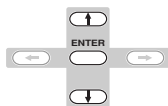

- 4** Now the "AUTO CH MEMORY" and "AUTO CLOCK" starts.  
After the starting setup is completed, the TV channel appears on the screen.



#### Notes:

- The starting setup function will work only when you press the POWER button for the first time.
- In "AUTO CLOCK" setting, it may take more than 10 minutes to read the EDS signal for one channel, which has only "Time of day" or "Local time zone".

# Clock setting

The auto clock function will automatically set the built-in clock (Month, Day, Year and Time) when the unit is connected to an antenna or cable system and it is turned off. As the unit searches for a receivable station in your area and it receives a broadcast signal for auto clock, the auto clock needs several minutes to set itself.

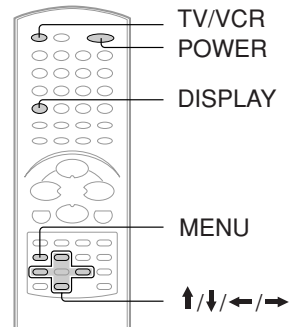

## Auto clock setting

### Preparation:

- Connect the antenna or cable system.
- If you use a cable box, turn it on.
- Plug the AC power cord to the AC outlet.

### 1 Make sure the unit is turned off.

- If you press **POWER**, the Auto Clock set is not effective.

### 2 Wait at least three minutes and press **POWER**. Then press **TV/VCR** to select TV/VCR mode.

The **POWER** indicator will light.

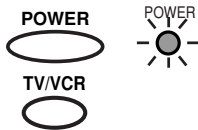

### 3 Press **DISPLAY** to check the clock on the screen.

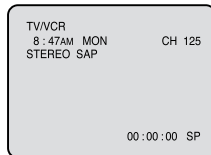

### 4 If the clock is not set, check the antenna condition. The Auto clock may not function properly if the reception condition is not good.

## Auto clock adjustment

The Auto clock adjustment will be performed at **12:00 PM everyday if you turn off the unit.**

- If you use a cable box and you want Auto Clock adjustment to be performed, the cable box must be left on.
- The Auto Clock adjustment is not effective when there is a difference of more than 5 minutes exists between the built-in clock time and the actual time.

## To set auto clock to OFF

When shipped from factory the **AUTO CLOCK** is set to "ON". But if you do not want auto clock set (Adjustment):

### 1 Press **MENU**, then press **←** or **→** to select option.

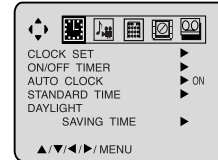
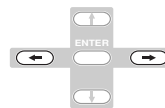

### 2 Press **↑** or **↓** to select "AUTO CLOCK".

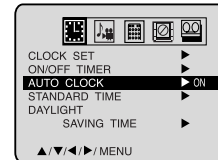
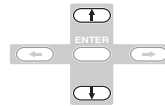

### 3 Press **←** or **→** to select "OFF".

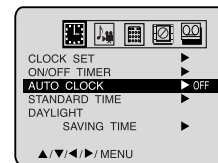
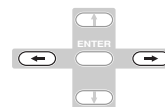

### 4 Press **MENU** repeatedly until the menu screen is cleared.



- When the **AUTO CLOCK** is set to "OFF", the Auto Clock adjustment does not function.
- Set the clock manually [21].

### Notes:

- If the unit does not operate properly, or No key operation (by the unit and/or the remote control): Static electricity, etc., may affect the player's operation. Disconnect the AC power cord once, then connect it again.
- The TV section has its own menu and also DVD section has its own menu [57].
- If no buttons are pressed for more than 60 seconds, the TV/VCR menu screen will return to normal TV operation automatically.



## Clock setting (continued)



### To set standard time

In the rare event that you live within broadcast range of two stations in two different time zones, the unit may recognize the wrong station for the auto clock set.

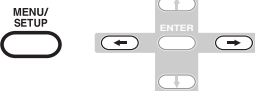
To correct the situation:

- 1 Press MENU, then press ← or → to select option.**

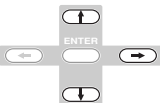

- 2 Press ↑ or ↓ to select "STANDARD TIME", then press →.**

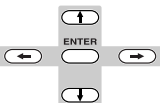

- 3 Press ↑/↓/←/→ to select your time zone, then press ENTER.**

ATLANTIC	: GMT-4hours
EASTERN	: GMT-5hours
CENTRAL	: GMT-6hours
MOUNTAIN	: GMT-7hours
PACIFIC	: GMT-8hours
ALASKA	: GMT-9hours
HAWAII	: GMT-10hours
AUTO	: AUTO SET
	(GMT: Greenwich Mean Time)

- 4 Press MENU repeatedly until the menu screen is cleared.**





**Note:**



To be able to select the standard time, the clock must first be set by "AUTO CLOCK" once.

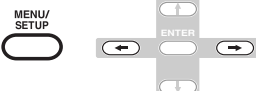

### To set daylight saving time

You can set the Daylight saving time automatically or manually.

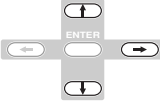
- 1 Press MENU, then press ← or → to select option.**

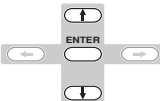

- 2 Press ↑ or ↓ to select "DAYLIGHT SAVING TIME", then press →.**



- 3 Press ↑ or ↓ to select one of the options, then press ENTER.**

**ON:** for manual setting (forward one hour)  
**OFF:** for manual setting (back one hour)  
**AUTO:** for automatic setting (read EDS in the signal)

When you want to set the Daylight Saving Time manually, on the first Sunday in April you set to "ON", and on the last Sunday in October you set to "OFF".
- 4 Press MENU repeatedly until the menu screen is cleared.**



**Notes:**

- When shipped from factory, the DAYLIGHT SAVING TIME is set to "AUTO" position.
- When the clock is not set, Daylight Saving Time setting is not available.
- When there is no Daylight Saving Time in your area, always select "OFF" position in step 3.



## Manual clock setting

You must set the date and time manually for timer recordings, ON/OFF timer and daylight saving time if the auto clock process did not set them correctly.

**EXAMPLE:** Setting the clock to "8:30 AM", 30th. (SAT) October, 2004.

**1** Press MENU, then press ← or → to select option.

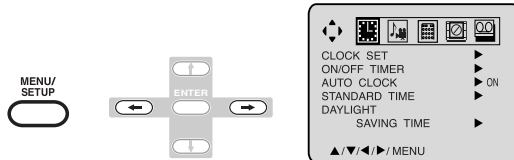

**2** Press ↑ or ↓ to select "CLOCK SET", then press →.



**3** Press ← or → to set the month, then press ↓.



**4** Set the day, year and time as in step 3, then press ENTER.



**5** After setting the clock, date and time starts functioning automatically.



### ■ To make corrections any time during the process

Press ↑ or ↓ repeatedly until the item you want to change blinks, then set the item again.

### Notes:

- After a power failure or disconnection of the power, the timer settings will be lost. In this case, reset the present time.
- When you set the minute, you can change in 10-minutes step by holding down ← or →.

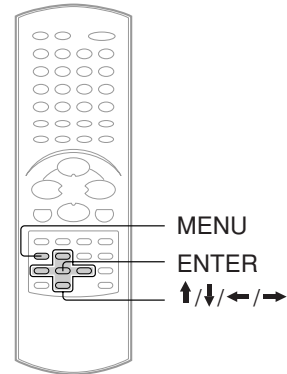

Basic setup

# Setting the language/ TV/VCR operation status

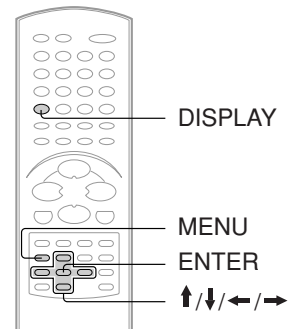

## Setting the language

This unit can display the on screen language in English, Spanish or French.

**1** Press **MENU**, then press **←** or **→** to select option.

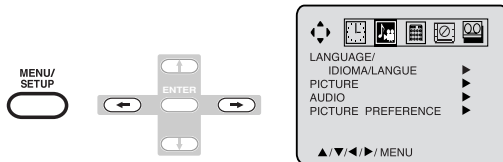

**2** Press **↑** or **↓** to select "LANGUAGE/IDIOMA/LANGUE", then press **→**.



**3** Press **↑** or **↓** to select the desired language: English (ENGLISH), Spanish (ESPAÑOL) or French (FRANCAIS), then press **ENTER**.



**4** Press **MENU** repeatedly until the menu screen is cleared.



## TV/VCR operation status

Press **DISPLAY** to display the information on the screen. To cancel the display, press **DISPLAY** again.

### While watching TV

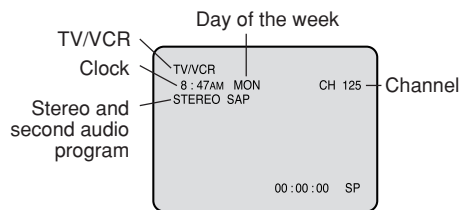

### While operating a tape

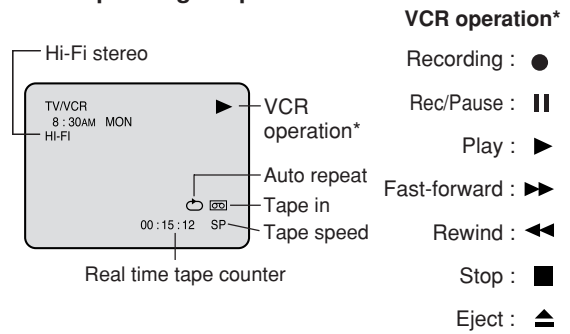

# TV operation

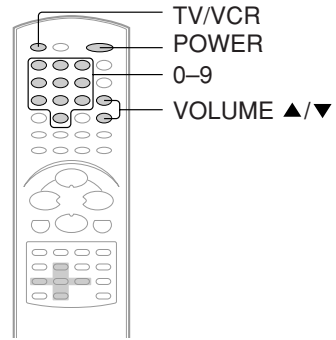

## TV operation

**1 To turn on the unit, press POWER.**  
 The Power indicator will light.  
 • Every time you turn on the TV, the unit starts from TV/VCR mode. When you use TV/VCR after DVD operation, press TV/VCR.



**2 Adjust the volume level by pressing VOLUME ▲ or ▼.**  
 The volume level will be indicated on the screen by green bars. As the volume level increases, so do the number of bars. If the volume decreases, the number of green bars also decreases.

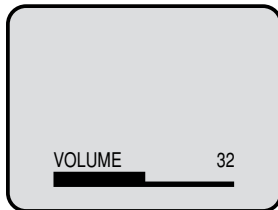

**3 Set the TV/CABLE selection to the appropriate position [26].**

TV - VHF/UHF channels  
 CABLE - Cable TV channels

**4 Press direct channel selection (0-9) to select the channel.**

**TV mode direct channel selection**

When the TV/CABLE selection is in the TV position, all channels can be instantly selected by using two buttons. (for example, to select channel 2, press "0", then "2". If you press only "2", channel selection will be delayed for a few seconds.) For channels 10 and above, press the 2 digits in order.

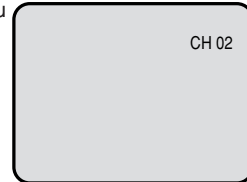

**CABLE mode direct channel selection**

When the TV/CABLE selection is in the CABLE position, channels can be selected as follows:  
 TO SELECT CABLE TV CHANNELS:

- 1-9: Press "0" twice, then 1-9 as needed.  
 Example, to select channel 2, press "002".
- 10-12: Press "0", then the remaining 2 digits.  
 Example, to select channel 12, press "012".
- 13-99: Press the 2 digits in order. Example, to select channel 36, press "36".
- 100-125: Press the 3 digits in order. Example, to select channel 120, press "120".

**NOTE FOR CHANNELS 1-12:**

If only 1 or 2 buttons are pressed, the corresponding channel will be selected in 2 seconds.

TV	CATV
VHF	VHF
2-13	2-13
UHF	STD/HRC/IRC
14-69	14-36
	(A) (W)
	37-59
	(AA) (WW)
	60-85
	(AAA) (ZZZ)
	86-94
	(86) (94)
	95-99
	(A-5) (A-1)
	100-125
	(100) (125)
	01
	(5A)

**Notes:**

- If a channel with no broadcast is selected, the sound will automatically be muted.
- If a station being viewed stops broadcasting, the TV will automatically shut itself off after 15 minutes.

TV operation

## TV operation (continued)

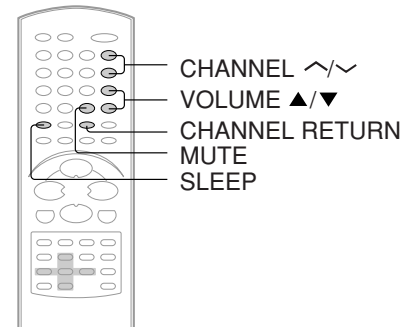

### TV operation

#### ■ CHANNEL UP/DOWN

Press and release **CHANNEL**  $\wedge$  or  $\vee$ . The channel automatically stops at the next channel set into memory. For proper operation, before selecting channels, they should be set into the memory. See page 26 "To memorize channels".

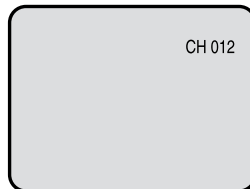

#### ■ CHANNEL RETURN

This button allows you to go back to the last channel selected by pressing **CHANNEL RETURN**. Press **CHANNEL RETURN** again to return to the last channel you were watching.

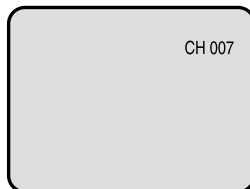

#### ■ MUTE

Press **MUTE** to switch off the sound. The unit's sound will be silenced and "MUTE" will briefly appear on the screen. The sound can be switched back on by pressing this button again or one of **VOLUME**  $\blacktriangle/\blacktriangledown$ .

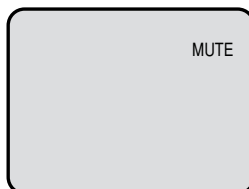
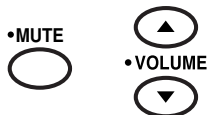

#### ■ SLEEP

To set the unit to turn off after a preset amount of time, press **SLEEP** on the remote control. The clock will count down 10 minutes for each press of **SLEEP** (120, 110, ...10, 0). After the sleep time is programmed, the display will appear briefly every ten minutes to remind you that the sleep timer is operating. To confirm the sleep timer setting, press **SLEEP** and the remaining time will be displayed for a few seconds. To cancel the sleep timer, press **SLEEP** repeatedly until the display turns to 0.

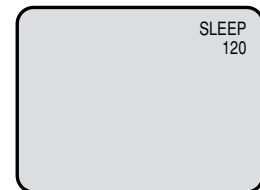

#### ■ HEADPHONES

Insert a stereo headphones (not supplied) with a 1/8" mini plug into the PHONES jack on the front panel. If you connect headphones, the sound from TV speakers is muted.

- Model MW27FPX has a door on the front panel. Please open it to access the PHONES jack.

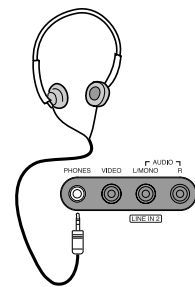





## Closed captions

### WHAT IS CLOSED CAPTIONING?

This television has the capability to decode and display closed captioned television programs. Closed captioning will display text on the screen for hearing impaired viewers or it will translate and display text in another language.

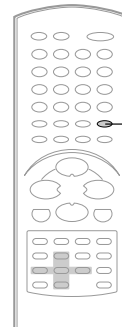

CLOSED CAPTION

## Closed captions

**Captions:** This closed caption mode will display text on the screen in English or another language (depending on the setting of the closed captions CH 1/2).

Generally, closed captions in English are transmitted on captions channel 1 and closed captions in other languages are transmitted on captions channel 2.

**Text:** The text closed caption mode will usually fill 1/2 of the screen with a programming schedule or other information. After selecting a closed caption mode, it will stay in effect until it is changed, even if the channel is changed. If the captions signal is lost due to a commercial or a break in the signal, the captions will reappear when the signal is received again. If the channels are changed, the captions will be delayed approximately 10 seconds. The captions will appear in places on the screen where they will least interfere with the picture, usually on the bottom of the screen. News programs will usually show three-line closed captions which scroll onto the screen. Most other shows provide two or three lined captions placed near the character who is speaking so the viewer can follow the dialogue. Words in italics or underlined describe titles, words in foreign languages or words requiring emphasis. Words that are sung usually appear enclosed by musical notes.

For television programs broadcasting with closed captions, look in your TV guide for the closed captions symbol (CC).

### TO VIEW CLOSED CAPTIONS

Press **CLOSED CAPTION** to switch between normal TV and the two closed caption modes (captions and full screen text). Closed captioning will display text on the screen for hearing impaired viewers.

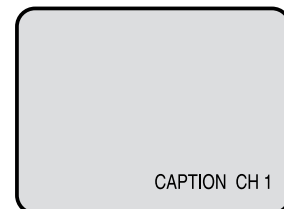

### Notes:

- When selecting closed captions, the captioning will be delayed approximately 10 seconds.
- If no caption signal is received, no captions will appear, but the television will remain in the caption mode.
- Misspellings or unusual characters may occasionally appear during closed captioning. This is normal with closed captioning, especially with live programs. This is because during live programs, captions are also entered live. These transmissions do not allow time for editing.
- When captions are being displayed, on-screen displays, such as volume and mute may not be seen or may interfere with closed captions.
- Some cable systems and copy protection systems may interfere with the closed captioned signal.
- If using an indoor antenna or if TV reception is very poor, the closed caption decoder may not appear or may appear with strange characters or misspelled words. In this case, adjust the antenna for better reception or use an outdoor antenna.

TV operation

## To memorize channels

This unit is equipped with a channel memory feature which allows channels to skip up or down to the next channel set into memory, skipping over unwanted channels. Before selecting channels, they must be programmed into the unit's memory. In addition to normal VHF and UHF channels, this unit can receive up to 113 cable TV channels. To use this unit with an antenna, set the TV/CABLE selection to the TV position. When shipped from the factory, this selection is in the CABLE position.

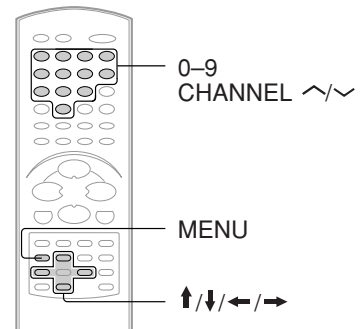

### TV/CABLE selection

**1** Press MENU in the TV mode, then press ← or → to select option.

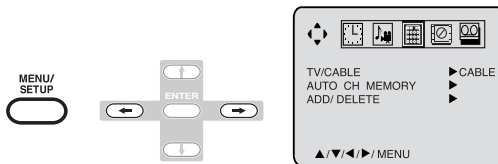

**2** Press ↑ or ↓ to select "TV/CABLE".



**3** Press ← or → to select "TV" or "CABLE".

TV - VHF/UHF channels  
CABLE - Cable TV channels

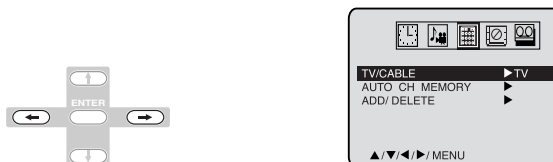

**4** Press MENU repeatedly until the menu screen is cleared.



### Cable TV chart

The chart below is typical of many cable system channel allocations.

Number on this TV	14	15	16	17	18	19	20	21	22
Corresponding Cable TV channel	A	B	C	D	E	F	G	H	T
23	24	25	26	27	28	29	30	31	32
J	K	L	M	N	O	P	Q	R	S
41	42	43	44	45	46	47	48	49	50
EE	FF	GG	HH	II	JJ	KK	LL	MM	NN
59	60	61	62	63	64	65	66	67	68
WW	AA	BBB	CCC	DDD	EEE	FFF	GGG	HHH	III
77	78	79	80	81	82	83	84	85	86
RRR	SSS	TTT	UUU	VVV	WWW	XXX	YYY	ZZZ	86
86	87	88	89	90	91	92	93	94	87
88	89	90	91	92	93	94	100	101	102
A-5	A-4	A-3	A-2	A-1	100	101	102	103	104
104	105	106	107	108	109	110	111	112	105
106	107	108	109	110	111	112	113	114	107
108	109	110	111	112	113	114	115	116	109
110	111	112	113	114	115	116	117	118	111
112	113	114	115	116	117	118	119	120	113
113	114	115	116	117	118	119	120	121	115
114	115	116	117	118	119	120	121	122	117
115	116	117	118	119	120	121	122	123	119
116	117	118	119	120	121	122	123	124	121
117	118	119	120	121	122	123	124	125	123
118	119	120	121	122	123	124	125	5A	125

### Automatic memory tuning

Press ↑ or ↓ to select the "AUTO CH MEMORY", then press →.

The TV will begin memorizing all the channels available in your area.



### To ADD/DELETE channels

**1** Press ↑ or ↓ to select "ADD/DELETE", then press →.



**2** Select the desired channel to be added or deleted using Direct channel selection (0-9), ↑/↓ or CHANNEL ^/~/.

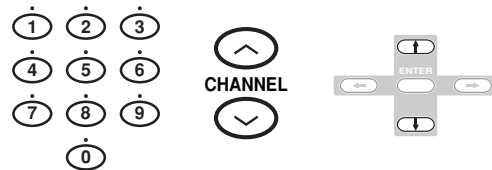

**3** Press ← or → to select "ADD" or "DELETE", whichever function you want to perform.



### Note:

You can not select option if you set the channel to "LINE1" or "LINE2".



# Setting the V-Chip

An age limitation can be set to forbid children to watch programs according to "TV RATING" and "MOVIE RATING" level set. To use the V-Chip function, you must register a password.

### Notes:

- If you forget the password, you cannot set the V-Chip.
- To avoid forgetting the password, write it down and keep in the safe place.

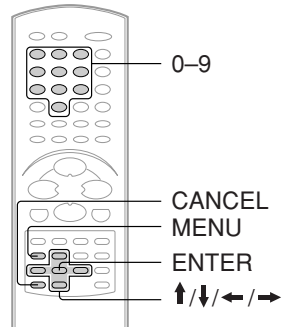

## To register password

**1** Press MENU, then press ← or → to select option.

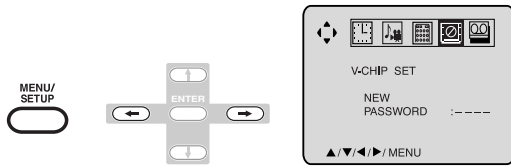

**2** Press ↑ or ↓ to select "PASSWORD".



**3** Enter the password (4 digits) using Number buttons (0-9), then press ENTER.

- If you put a wrong number, press CANCEL.

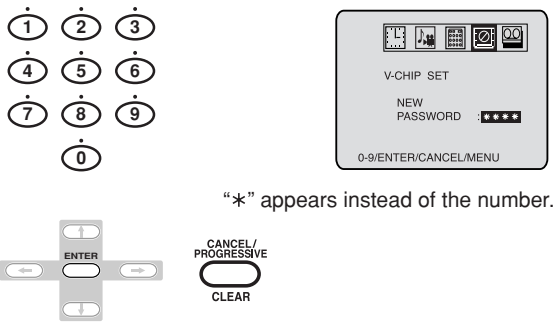

**4** Enter the same password again for the safety, then press ENTER.

Now the password was registered and V-Chip setting menu will appear on the display.



## To change password

**1** In the V-CHIP menu, press ↑ or ↓ to select "CHANGE PASSWORD", then press →.

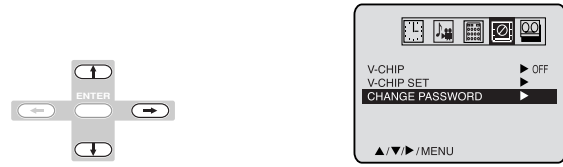

**2** Enter the new password using Number buttons (0-9), then press ENTER.

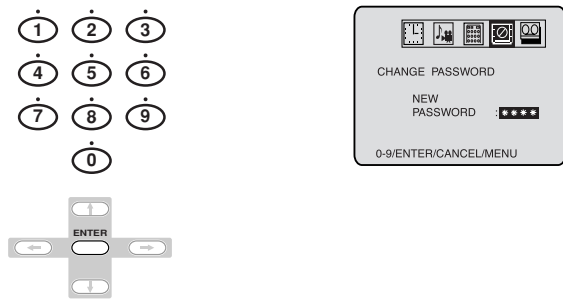

**3** Enter the same password again using Number buttons (0-9) for safety, then press ENTER.

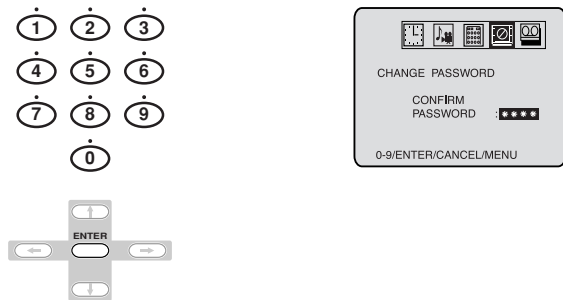

**4** Press MENU repeatedly until the menu screen is cleared.



TV operation

## Setting the V-Chip (continued)

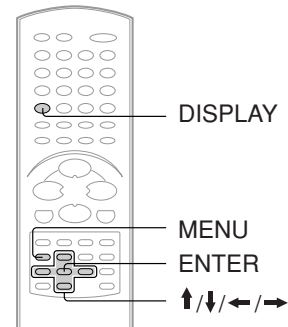

### To set the V-Chip

- 1** In the V-CHIP menu, press **↑** or **↓** to select “V-CHIP SET”, then press **→**.



- 2** Press **↑** or **↓** to select “TV RATING”, then press **←** or **→** to display the desired setting. After setting, press **ENTER**.

**OFF** : TV RATING is not set  
**TV-Y** : All children  
**TV-Y7** : 7 years old and above  
**TV-G** : General audience  
**TV-PG** : Parental guidance  
**TV-14** : 14 years old and above  
**TV-MA** : 17 years old and above



When you select TV- Y7, TV-PG, TV-14 or TV-MA, press **DISPLAY** to show the contained rating. Press **↑** / **↓** / **←** / **→** to select the desired item you want.

•**DISPLAY**



- 3** Press **↑** or **↓** to select “MOVIE RATING”.



- 4** Press **←** or **→** to select desired rating. After setting, press **ENTER**.



**OFF** : MOVIE RATING is not set  
**G** : All ages  
**PG** : Parental guidance  
**PG-13** : Parental guidance less than 13 years old  
**R** : Under 17 years old  
**NC-17** : 17 years old and above  
**X** : Adult only

- 5** Press **↑** or **↓** to select “V-CHIP”.



- 6** Press **←** or **→** to display “ON”. Now your settings were set into the memory.

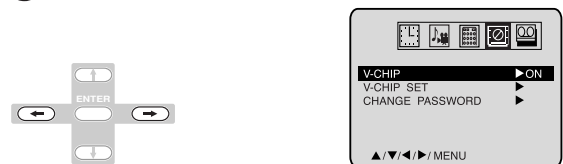

- 7** Press **MENU** repeatedly until the menu screen is cleared.



#### To use after the TV is protected

When the program applied to the V-Chip setting is received, enter the password, then press **ENTER**. Protection can be canceled.

#### Note:

The V-Chip function is activated only on programs that have the rating signal.



## To set the on timer

This feature allows you to have the unit automatically turn on at a predetermined time. If you program the ON TIMER once, the unit will turn on the programmed day (daily/weekly) at the same time to the same channel.

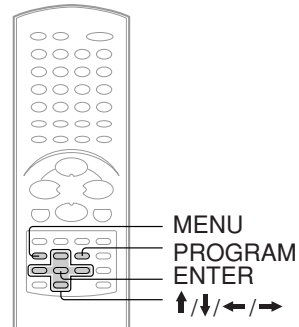

### To set the on timer

**EXAMPLE:** Turning on the TV to channel 12 at 7:00 AM, MONDAY-FRIDAY.

- 1** Press MENU. Press ← or → to select option. You can also select ON/OFF TIMER by pressing PROGRAM twice.

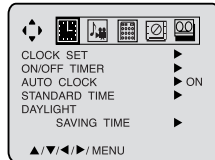
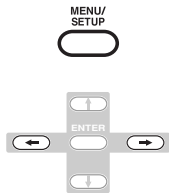

- 2** Press ↑ or ↓ to select "ON/OFF TIMER", then press →.

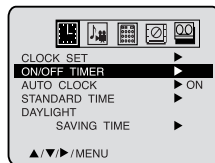
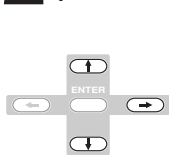

- 3** Press ↑ or ↓ to select "ON TIMER", then press →.

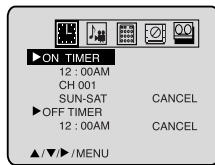
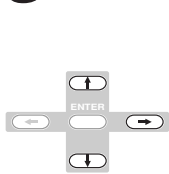

- 4** Press ← or → to set the desired hour, then press ↓.

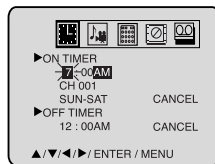
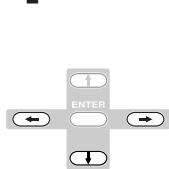

- 5** Set the desired minute, channel and daily or weekly timer date as in step 4.

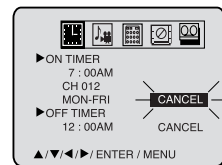
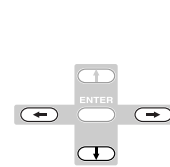

- 6** Press ← or → to select "SET", then press ENTER.

Now the ON TIMER is set.

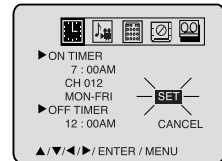
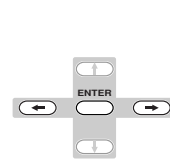

- 7** Press MENU repeatedly until the menu screen is cleared.



#### Notes:

- The unit will automatically turn off approximately 1 hour later after the ON TIMER turns on. To continue watching the TV, press any button to cancel the one hour automatic shut off.
- To cancel ON TIMER, follow above steps 1~5, then press ← or → to select "CANCEL". Press the MENU button repeatedly until the menu screen is cleared.
- After setting the ON TIMER, "▶ OFF TIMER" will be highlighted. If you wish to set the OFF TIMER, press → then follow the steps 4~6 on page 30.
- If you want to correct the digits while setting, press ↑ or ↓ until the item you want to correct, then press ← or → to correct the desired setting.

TV operation

## To set the off timer

This feature allows you to have the unit turn off automatically at a predetermined time. If you program the OFF TIMER once, the unit will automatically turn off at the same time everyday.

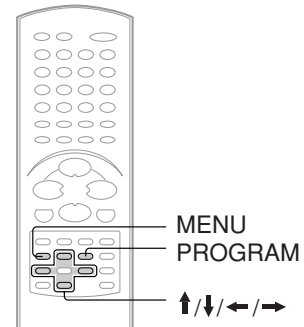

### To set the off timer

**EXAMPLE:** Turning off the TV at 11:30 PM.

**1** Press MENU. Press ← or → to select option.

You can also select ON/OFF TIMER by pressing PROGRAM twice.

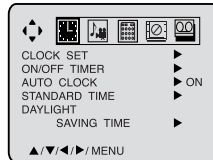
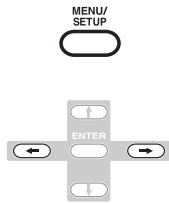

**2** Press ↑ or ↓ to select "ON/OFF TIMER", then press →.

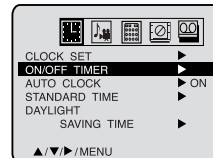
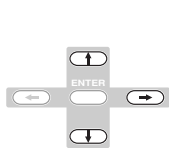

**3** Press ↑ or ↓ to select "OFF TIMER", then press →.

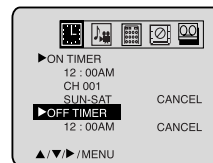
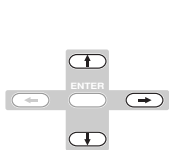

**4** Press ← or → to set the desired hour, then press ↓.

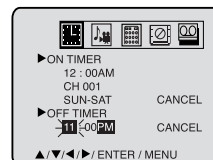
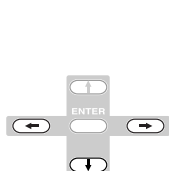

**5** Press ← or → to set the desired minute, then press ↓.

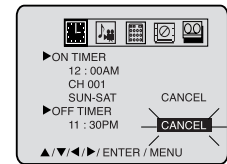
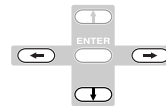

**6** Press ← or → to select "SET".  
Now the OFF TIMER is set.

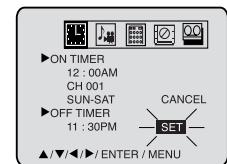
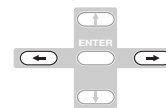

**7** Press MENU repeatedly until the menu screen is cleared.



#### Notes:

- **To cancel the OFF TIMER function:**  
To cancel OFF TIMER, follow above steps 1~5, then press ← or → button to select "CANCEL". Press the MENU button repeatedly until the menu screen is cleared.
- **To confirm the ON/OFF TIMER:**  
Press the PROGRAM button twice to indicate the programs on the screen.



## Picture control adjustment

### Adjusting the picture preference

Picture controls are factory preset but you can adjust them individually as follows:  
And also you can select four picture modes—Standard, Sports, Movie, and Memory—as described in the following table:

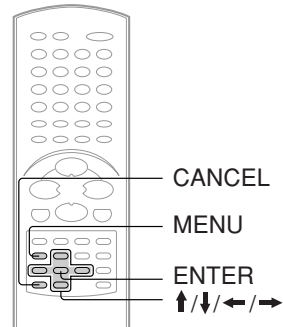

#### Picture control adjustment

- 1** Press MENU, then press ← or → to select option.

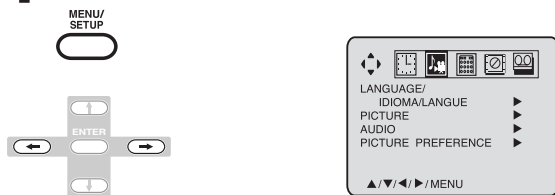

- 2** Press ↑ or ↓ to select “PICTURE”, then press →.



- 3** Press ↑ or ↓ to select the item you want to adjust, then press ← or → to adjust the setting.



Selection	← Pressing →	
BRIGHTNESS	darker	lighter
CONTRAST	lower	higher
COLOR	paler	deeper
TINT	reddish	greenish
SHARPNESS	softer	sharper

**Note:**  
The CONTRAST default setting is set to maximum (+32) at the factory.

- 4** After your desired setting press MENU repeatedly until the menu screen is cleared.



#### Adjusting the picture preference

- 1** Press MENU, then press ← or → to select option.



- 2** Press ↑ or ↓ to select “PICTURE PREFERENCE”, then press →.



- 3** Press ↑ or ↓ to select the desired picture mode, then press ENTER.



Mode	Picture quality
STANDARD	Standard picture quality (factory-set)
SPORTS	Bright and dynamic picture (factory-set)
MOVIE	Movie-like picture setting (factory-set)
MEMORY	Your personal preferences (set by you; see “Picture control adjustment” as left)

- 4** After your desired setting press MENU repeatedly until the menu screen is cleared.



TV operation

■ To return all adjustments to the factory preset levels  
Press CANCEL while making picture adjustments.

# Sound control adjustment/ Stereo and Second Audio Program (SAP)

Sound controls are factory preset but you can adjust them individually as follows: The unit is equipped with a feature known as multi-channel TV sound or MTS. MTS broadcasts greatly enhance TV viewing by bringing you programs with high fidelity stereo sound. MTS also provides an extra channel called the Second Audio Program or SAP which broadcasters can use to transmit a second language for bilingual transmission or for other purposes.

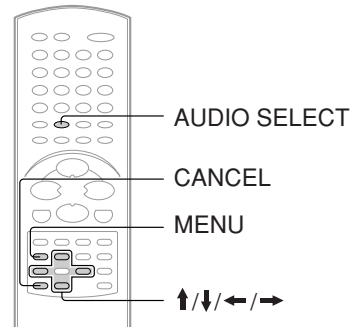

## Sound control adjustment

- 1** Press **MENU**, then press **←** or **→** to select option.
- 2** Press **↑** or **↓** to select "AUDIO", then press **→**.
- 3** Press **↑** or **↓** to select the item you want to adjust, then press **←** or **→** to adjust the setting.
 

**BASS:** Press **←** or **→** to adjust the bass sound.

**TREBLE:** Press **←** or **→** to adjust the treble sound.

**BALANCE:** Press **←** or **→** to obtain an equal sound level from both speakers.

**SURROUND:** Press **←** or **→** to select "ON" or "OFF".  
**ON:** The dynamic presence and sound created offers a thoroughly enjoyable listening experience.  
**OFF:** Normal sound.

**STABLE SOUND:** Press **←** or **→** to select "ON" or "OFF".  
**ON:** The Stable Sound feature limits the highest volume level to prevent extreme changes in volume when the signal source is changed.  
**OFF:** Normal sound.

**SAP:** Press **←** or **→** to select "ON" or "OFF".  
**ON:** SAP is available.  
**OFF:** SAP is not available.
- 4** After your desired setting press **MENU** repeatedly until the menu screen is cleared.

■ To return BASS/TREBLE/BALANCE control adjustments to the factory preset levels Press **CANCEL** while making sound adjustments.

## Listening to stereo sound

When the TV is turned on or a channel selection is made, make certain the "STEREO" appears on the screen. This means that Stereo broadcasting is available. You can enjoy stereo sound from the left and right speakers.

- When mono broadcasting is received, no indication is displayed.
- If the broadcast signal is not strong enough or clear stereo sound is not available, press **AUDIO SELECT** to change to mono sound. The noise should be eliminated. Press it again to return to the stereo sound.

STEREO CH 013

## Listening to SAP (Second Audio Program)

When the TV is turned on or a channel selection is made, make certain the SAP appears on the screen. This means that the Second Audio Program broadcasting is available.

STEREO SAP CH 013

## To select desired sound

Press **AUDIO SELECT** to select the desired sound.

STEREO

Broadcast	SAP setting	Audio display
MONO	OFF	MONO
	ON	MONO
STEREO	OFF	STEREO ↔ MONO
	ON	STEREO ↔ MONO
MONO+SAP	OFF	MONO
	ON	SAP
STEREO+SAP	OFF	STEREO ↔ MONO
	ON	SAP



## Loading and unloading a cassette tape

Use only video cassette tapes marked **VHS**.

### Loading

Push the center of the tape until it is automatically inserted.



Insert the cassette tape with its labeled side facing up and the erase prevention tab positioned at your left. An inverted cassette tape cannot be inserted.

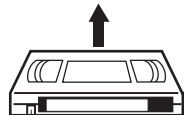

Erase prevention tab

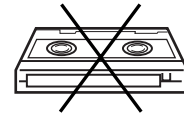

#### Automatic power ON

When you insert a cassette tape the unit power will turn ON automatically.

#### Automatic playback

When loading a cassette tape without an erase prevention tab, playback will start automatically.

### Unloading

**1** Press **STOP/EJECT** on the front panel.

STOP/EJECT

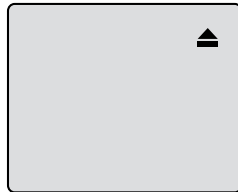

**2** Remove the cassette tape.

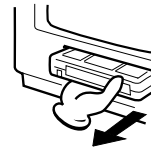

#### Automatic tape eject

This unit will automatically rewind the tape when the tape has ended. And when the tape is rewinded to its beginning, the cassette tape will be ejected automatically.

#### Notes:

- Always eject the tape when not in use.
- The cassette tape can be ejected even if the POWER is "OFF".

### To prevent accidental erasure

#### To prevent accidental erasure

Remove the erase prevention tab with a screwdriver.

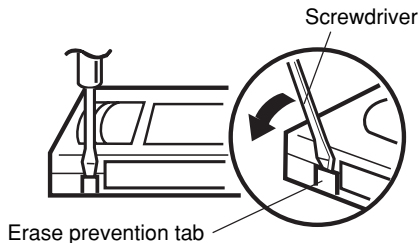

#### To record again

Cover the hole with a piece of adhesive tape.

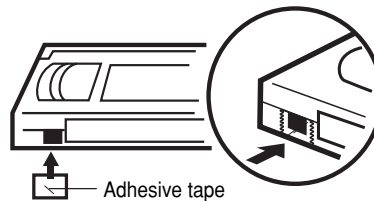

### Tape speed and maximum recording time

Tape Speed	Video cassette tape				
	T-160	T-120	T-90	T-60	T-30
SP (Standard Play)	2-2/3 hours	2 hours	1-1/2 hours	1 hour	30 minutes
SLP (Super Long Play)	8 hours	6 hours	4-1/2 hours	3 hours	1-1/2 hours

## Cassette tape playback

To play a prerecorded tape.

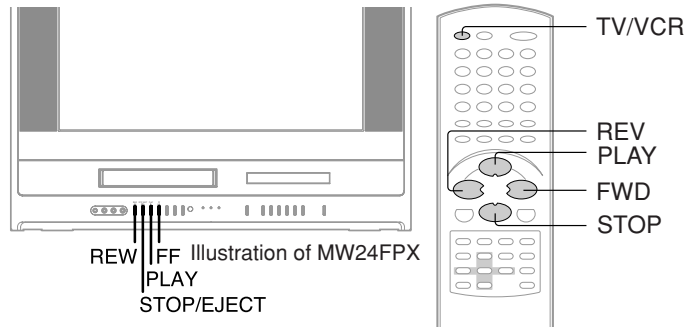

### Playback

#### 1 Load a prerecorded tape:

(When loading a cassette tape without the erase prevention tab, playback will start automatically).

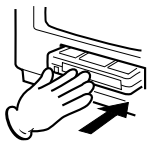

#### 2 To start playback:

Press **PLAY** on the front panel or on the remote. Playback will start. "▶" will appear on the screen for about 4 seconds.

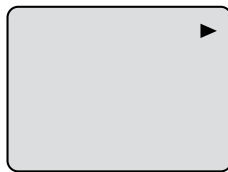

#### To stop playback:

Press **STOP/EJECT** once on the front panel or press **STOP** on the remote. The tape will stop but remain fully loaded and ready to play. "■" will appear on the screen for about 4 seconds.

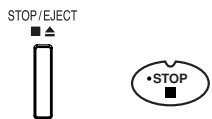

#### Notes:

- If you play a prerecorded tape after the DVD playback, you must set the unit to TV/VCR mode using the TV/VCR button.
- This unit selects the playback tape speed SP or SLP automatically.
- When you select the TV/VCR mode during DVD playback, DVD playback will change to the still mode, and after 5 minutes it will change to the resuming stop mode automatically.

### Rewind or forward the tape

Stop the playback or recording with **STOP**.

#### To rewind the tape:

Press **REW** on the front panel or press **REV** on the remote.



#### To forward the tape:

Press **FF** on the front panel or press **FWD** on the remote.



To stop the tape-winding, press **STOP**. To switch to playback directly (without **STOP**), press **PLAY**.

#### ■ Forward/Reverse picture search mode

When the tape is being wound, you can switch to picture search mode (see next page). To do this, press **REV** or **FWD** again and hold it down. The unit will resume the tape winding as soon as the button is released.



## Special playback

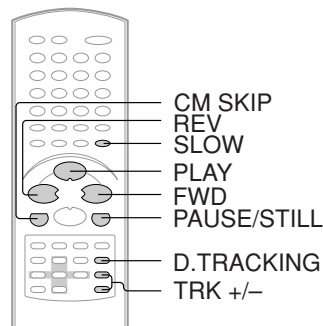

### Picture search

#### Reverse picture search function

Press **REV** once or twice during the playback.

#### Forward picture search function

Press **FWD** once or twice during the playback.

To return to playback, press **PLAY**.

#### SPEED SEARCH TIMES

TAPE SPEED	PICTURE SEARCH SPEED	
	PRESS ONCE	PRESS TWICE
SP (Standard Play)	3 X	5 X
SLP (Super Long Play)	9 X	15 X

### Still picture

Press **PAUSE/STILL** during playback.

To resume normal playback, press **PLAY** or **PAUSE/STILL**.

If the still picture jitters excessively, press **TRK + / -** to stabilize the still picture.

### Slow motion

During playback press **SLOW**.

To return to playback, press **PLAY** or **SLOW**.

#### ■ Slow tracking and vertical lock adjustment

If noise bars appear in the picture during slow motion, press the **TRK + / -** to reduce the noise bars.

### Frame by frame picture

Press **PAUSE/STILL** during playback.

Press **SLOW** one by one: The picture advances frame by frame.

To return to playback, press **PLAY** or **PAUSE/STILL**.

### CM skip

Press **CM SKIP** during playback. The unit will search forward through approximately 30 seconds of the tape (e.g. unwanted commercial time) for each press of **CM SKIP** (maximum six presses) and then resume normal playback.

For example : 1 press: 30 seconds of tape

2 press: 60 seconds of tape

3 press: 90 seconds of tape

### Digital tracking controls

When a tape is played, the Digital Auto Tracking system automatically adjusts the tracking to obtain the best possible picture. If noise bars appear during playback, adjust the tracking manually as follows:

- Press **TRK + / -** to obtain the best possible picture. "MANUAL TRACK" will appear for 4 seconds on the screen. To resume automatic tracking, press **D.TRACKING**. "DIGITAL TRACK" will appear for 4 seconds on the screen.

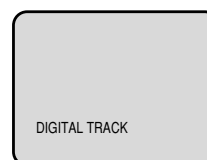
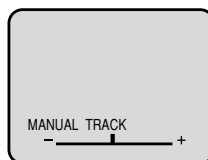

Playback (VCR)

#### Notes:

- "SP" is more appropriate as less noise appeared during search and still playback for tape recorded in SP.
- The audio output is muted during SPEED SEARCH, STILL, FRAME ADVANCE and SLOW MOTION.
- During picture search mode there will be noise bars which are caused by the system.
- The Special Playback will automatically change to playback after approx. 5 minutes to protect the video tape against excessive wear.

## Convenient function

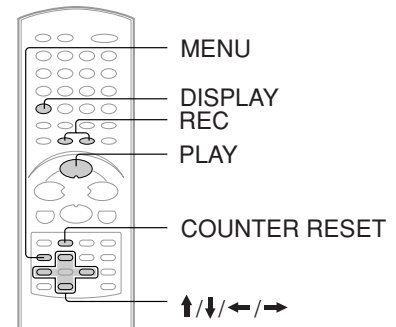

### Repeat playback

The entire video tape will be played until its end. The tape will automatically rewind to the beginning and the playback will be repeated.

#### 1 Press MENU, then press ← or → to select

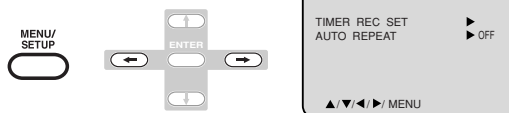

#### 2 Press ↑ or ↓ to select "AUTO REPEAT".



#### 3 Press ← or → to select "ON" or "OFF".

If "ON" is selected, the playback will be repeated endlessly.



#### 4 Press MENU repeatedly until the menu screen is cleared.

If you press DISPLAY, "⏻" will appear on the screen .

#### 5 To start the playback, press PLAY.

The playback will be repeated endlessly.



### Using the real time tape counter

The on-screen real time tape counter shows the tape running time in hours, minutes and seconds. You can easily determine how long the tape has been running or how much time is left on the tape.

#### 1 Press DISPLAY.

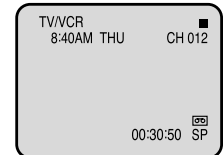

#### 2 Press COUNTER RESET to set the counter to "00:00:00".

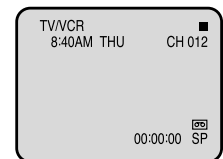

#### 3 Begin Playback or Recording to start the tape, the counter will display the elapsed time.



#### 4 When you wish to make the counter disappear, press DISPLAY once again.



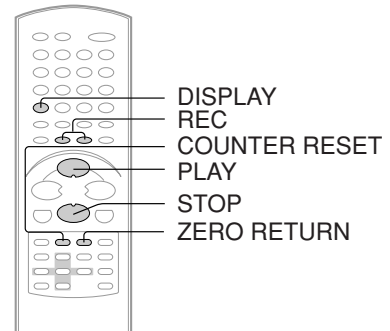

## Zero return function

The zero return function provides a convenient method of rapidly returning to the starting point of recording or playback. The starting point can be indexed for any location on the tape by pressing COUNTER RESET and ZERO RETURN.

### 1 Press DISPLAY.

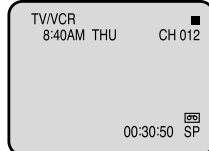

### 2 Before playback or recording, press COUNTER RESET to set the counter to "00:00:00".

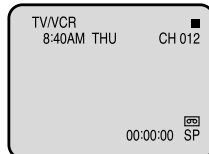

### 3 Begin playback or recording.



### 4 Press STOP.

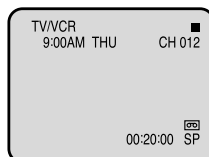

### 5 Press ZERO RETURN. The tape will rewind and automatically stop at the "00:00:00" position.

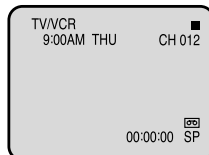

## Video head cleaning

### Video head clogging

The video heads are the means by which the unit reads the picture from the tape during playback. In the unlikely event that the heads become dirty enough to be clogged, no picture will be played back. This can easily be determined if, during playback of a known good tape, there is good sound, but no picture (picture is extremely snowy). If this is the case, have the unit checked by qualified service personnel.



Good Picture



Snowy Picture

Playback (VCR)

### Video head cleaning

Video head cleaning is needed when the playback picture becomes unclear. This signifies that the heads are getting dirty and can occur when playing poor quality or damaged tapes. If the heads require cleaning, use an equivalent high quality chemical non-abrasive (wet) head cleaning tape or have them cleaned professionally. If playing a head cleaning tape in the unit once does not improve the picture, play it several times before requesting service.

#### Notes:

- DO NOT ATTEMPT TO CLEAN THE VIDEO HEADS OR SERVICE THE UNIT BY REMOVING THE REAR COVER.
- Video heads may eventually wear out and should be replaced when they fail to produce clear pictures.
- To help prevent video head clogging, use only good quality VHS tapes. Discard worn out tapes.

## Recording a TV program

Recording and viewing the same TV program.

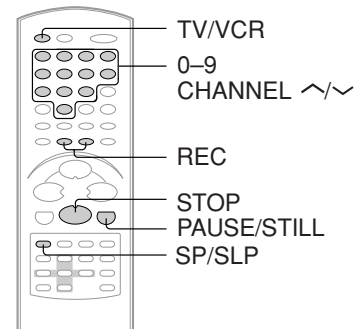

### Recording a TV program

#### 1 Load a cassette tape with the erase prevention tab intact.

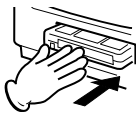

The unit will automatically turn on.

#### 2 Press SP/SLP to select the desired tape speed SP or SLP.



The tape counter and SP or SLP will appear on the screen for about 4 seconds.

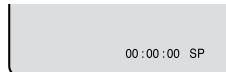

#### 3 Select "TV" or "CABLE" to the appropriate position .

TV - VHF/UHF channels  
CABLE - Cable TV channels

#### 4 Press Direct channel selection (0-9) or CHANNEL ^/v to select the channel to be recorded.

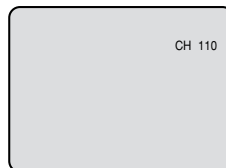
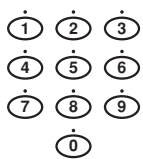

#### 5 Press both REC at the same time.

"●" will appear on the screen for about 4 seconds and the REC/OTR indicator on the front panel will light.



#### Notes:

- If power is switched off during recording, the TV and the DVD sections go off and the VCR continues to record. Press the STOP button to halt the recording and turn off the VCR.
- The unit channel cannot be changed during recording.
- If you record the TV program after the DVD playback, you must set the unit to TV/VCR mode using the TV/VCR button.

### To stop recording

Press STOP to stop recording.

"■" will appear on screen for about 4 seconds.



### To stop recording temporarily

Press PAUSE/STILL to avoid recording unwanted material.

"||" will appear on the screen and the REC/OTR indicator will blink on and off. Press PAUSE/STILL or both REC at the same time to continue the recording.

PAUSE/STILL



REC/OTR



#### Note:

The pause function will be released after 5 minutes to prevent damage to the tape or the unit. The unit will change to the STOP mode.

#### Auto Rewind feature

This VCR will automatically rewind the tape when the tape has ended (except during OTR and timer recording). It will also eject the tape.

#### Note:

If the erase prevention tab is removed, the tape will eject when both the REC buttons are pressed for recording.

# One-touch Timer Recording (OTR)

The One-touch timer recording feature provides a simple and convenient way to make a timed recording.

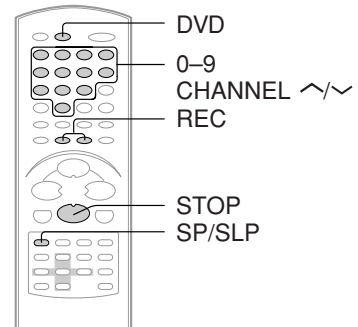

## One-touch timer recording (OTR)

**Example:** One-touch timer recording for 30 minutes.

- 1** Load a cassette tape with the erase prevention tab intact.

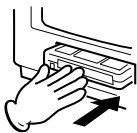

The unit will automatically turn on.

- 2** Press SP/SLP to select the desired tape speed SP or SLP.

The tape counter and SP or SLP will appear on the screen for about 4 seconds.

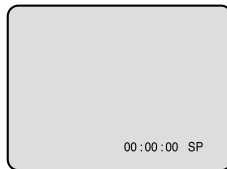

- 3** Set "TV" or "CABLE" option to the appropriate position [26].

TV - VHF/UHF channels  
CABLE - Cable TV channels

- 4** Press Direct channel selection (0-9) or CHANNEL ^/∇ to select the channel to be recorded.

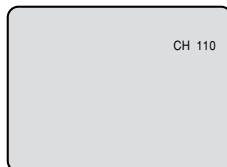
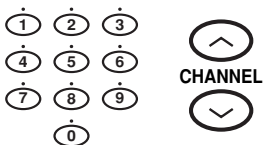

- 5** Press both REC at the same time to begin recording. Press the buttons again to stop recording after 30 minutes. Each additional press of REC will increase recording time as shown below, up to a maximum of 6 hours. "OTR" will appear on the screen.

Press	Recording time	Press	Recording time
once	NORMAL REC	6 times	3:00
twice	0:30	7 times	4:00
3 times	1:00	8 times	5:00
4 times	1:30	9 times	6:00
5 times	2:00	10 times	NORMAL REC

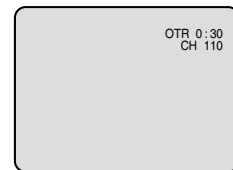

## To cancel OTR

Press STOP.

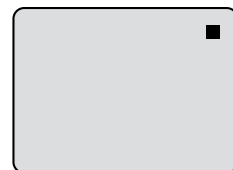

"■" will appear on screen for about 4 seconds.

### Notes:

- If you wish to watch the DVD playback during the recording or the OTR, press the DVD button to change to DVD mode and perform the DVD playback [44].
- The channel cannot be changed during recording.

Recording (VCR)

## Timer recording

Timer recording can be programmed on-screen with the remote control. The built-in timer allows automatic unattended recording of up to 8 programs within 1 month.

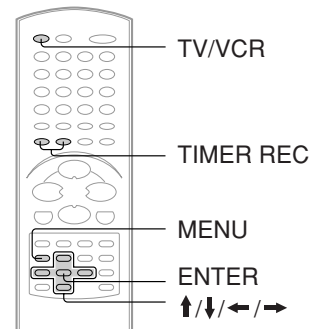

### Timer recording

#### Preparation:

- Press **TV/VCR** to select the TV/VCR mode.
- Load a cassette tape with the erase prevention tab intact.
- Check the time and date are correct [21].

#### Example:

Program a timer recording for 23rd day, channel 125 (Cable TV), 7:00 - 9:30 PM (Tape speed : SLP).

**1** Press **MENU**, then press **←** or **→** to select **00** option.

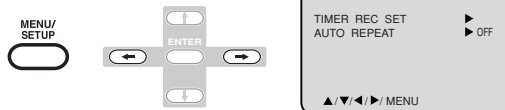

**2** Press **↑** or **↓** to select "TIMER REC SET", then press **→**.



**3** Press **↑** or **↓** to select one of the program line, then press **ENTER**.



**4** Press **←** or **→** to select the date, then press **↓**.



**5** Set the start time, end time, channel and tape speed as in step 4. Then press **ENTER**.

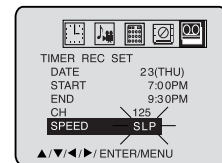
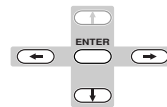

#### Notes:

- Press **↑** to move cursor backward for correction.
- To record from external source set the channel to "L1" or "L2".

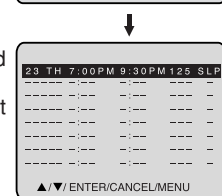

**6** To set the timer for another program, repeat steps 3 to 5 to set another program.

**7** Press both **TIMER REC** at the same time. The **TIMER REC** indicator will light. The Timer is programmed, when the programmed time is reached, the recording is automatically started.



To cancel timer recording, press both the buttons again and **TIMER REC** indicator will go out.

#### Notes:

- The VCR section cannot be used while the **TIMER REC** indicator is lit. If you want to use the VCR operation, press both **TIMER REC** buttons at the same time to deactivate the timer.
- When the clock is not set, you cannot select "TIMER REC". In this case, set the clock (see pages 19~21).
- After a power failure or disconnection of the power plug, all programmed recording setting and time display will be lost upon resumption of power. In this case, reset the clock (see pages 19~21) and reprogram any timer recordings.
- If you want to correct the digits while setting, press **↑** or **↓** until the item you want to correct, then press **←** or **→** to correct the desired setting.
- If programming is performed without a tape in the unit, or with a tape without an erase prevention tab, the Timer Recording is not possible. If a tape without an erase prevention tab is in the unit, the tape will be ejected.



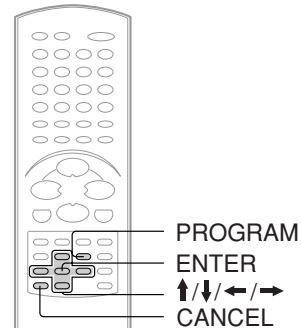

### To set daily/weekly timer

**Weekly (e.g. WKL-TUE: each Tuesday) or daily (e.g. MON-SAT: Monday to Saturday) Timer recording**

Follow the procedure of timer recording on the previous page. At picture 4 press ← or → repeatedly until the desired setting appears. Then press ENTER.

When you press ← repeatedly, the indicator at DATE will change as follows, in this case the day is Friday.

The current day (Friday) → SUN-SAT (Sunday to Saturday)

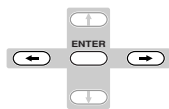
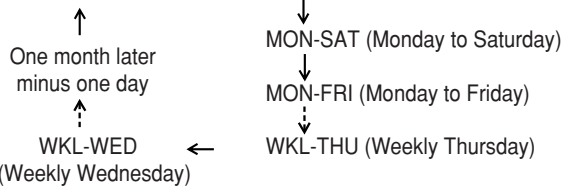

### If the programs overlap another

Do not overlap timer programs as portions of the conflicting programs will be lost. The first recording time has priority over the next recording time as shown in the diagram below.

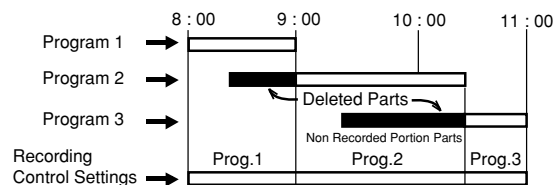

#### Notes:

- The daily/weekly recording can be made continuously until the recording is canceled or the tape reaches the end.
- During timer recording the automatic rewinding mechanism does not function.
- You can correct or cancel the programmed setting in program confirm mode.

### To confirm the settings

Press PROGRAM once. The TV screen displays the timer program list. Press PROGRAM again. The TV screen displays the ON/OFF timer setting.



Press PROGRAM 3 times. The menu screen is cleared.

(once)

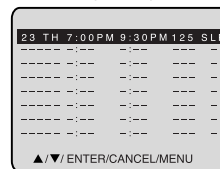

(twice)

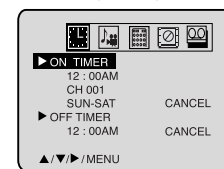

### To cancel a program

Press PROGRAM once. The TV screen displays the timer program list.

Press ↑ or ↓ to select the unnecessary program, and press CANCEL to cancel the program.



CLEAR

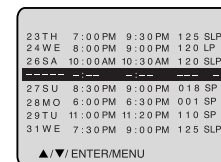
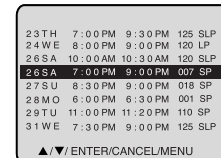

Recording (VCR)

## Duplicating a video tape

If you connect the unit to another VCR or Camcorder, you can duplicate a previously recorded tape. Make all connections before turning on the power.

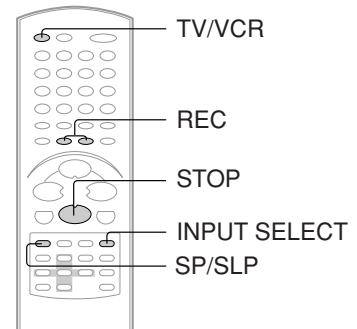

### Duplicating a video tape

#### Preparation:

- Press **TV/VCR** to select the TV/VCR mode.
- Load a cassette tape with the erase prevention tab intact.
- Load a previously recorded tape into the playback VCR or Camcorder.

#### 1 Press **SP/SLP** to select the desired tape speed **SP** or **SLP**.



It is recommended that you set the Speed to the SP mode on the recording VCR for best results.

#### 2 Press **INPUT SELECT** once or twice to select **AUDIO/VIDEO** input position.



"LINE1" or "LINE2" will appear on the screen.

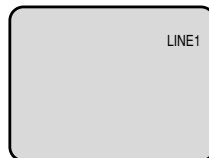

LINE1: on the rear panel  
LINE2: on the front panel

#### 3 Press both **REC** at the same time.



#### 4 Press **PLAY** on the playback VCR or camcorder.

#### 5 Press **STOP** after duplicating a video tape.



#### Note:

Unauthorized recording of copyrighted television programs, films, video cassettes and other materials may infringe the rights of copyright owners and be contrary to copyright laws.

#### Connection with second video recorder

- Select "LINE1" on step 2.

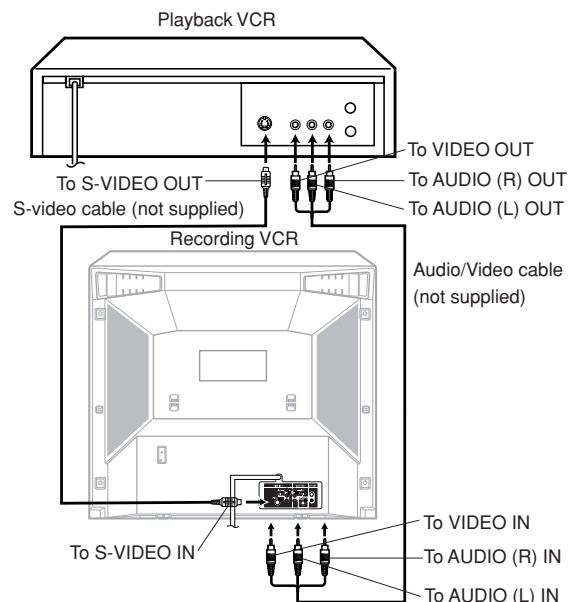

#### Note:

An S-video connection is superior to Video (Yellow) input.

#### Connection with Camcorder

- Select "LINE2" on step 2.

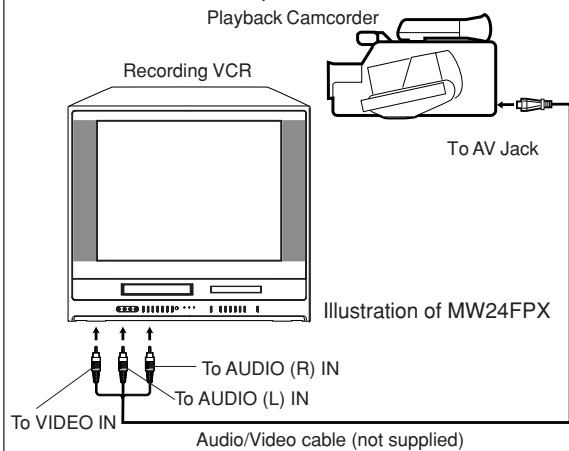

For duplicating a previously recorded tape from a camcorder, follow the camcorder manufacturer's instructions. A typical camcorder dubbing hookup is shown above.



## Recording a DVD/CD disc

You can record disc material in DVD, Audio CD, etc. onto a video tape with this unit.

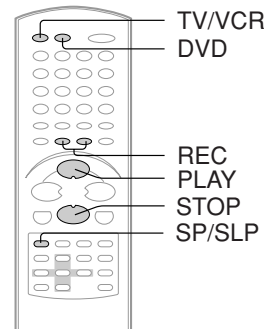

### Duplicating a DVD or CD disc

#### Preparation:

- Press **TV/VCR** to select the TV/VCR mode.
- Load a cassette tape with the erase prevention tab intact.
- Load a DVD/CD disc.

#### 1 Press **SP/SLP** to select the desired tape speed **SP** or **SLP**.



#### 2 Press **DVD** to select the DVD mode.



#### 3 Press **PLAY** to start playback.



#### 4 Press both **REC** to start recording.



The unit will change to the VCR mode automatically and the playback picture or sound will be duplicated on the video cassette tape.

#### 5 Press **STOP** if you finish recording.



If you wish to stop a DVD/CD disc, press **DVD** to change the DVD mode, then press **STOP**.

#### Notes:

- You may not record the beginning of the disc, so start to playback the disc, then start to record.
- You cannot record the disc with copy guard function. "DISC IS COPY PROTECTED" will show up on the TV screen for approx. 4 seconds.
- When the scanning mode is set to the progressive mode, you cannot duplicate a disc material onto a video tape. When both REC buttons are pressed, "Please Set **▶** Off" will appear on the screen and the recording will not start. To start duplicating, set the scanning mode to the interlace mode (see [56](#)), then press the PLAY button and press both REC buttons.

Other functions (VCR)

# Playing a disc

This section shows you the basics on how to play a disc.

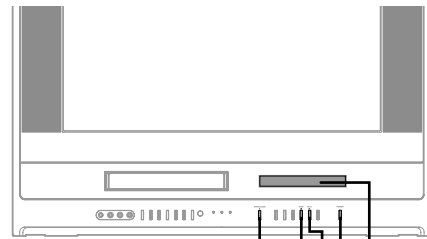

Illustration of MW24FPX 3,5 6 5 1 4

**CAUTION**

Keep your fingers well clear of the disc tray as it is closing. Neglecting to do so may cause serious personal injury.

**DVD VCD CD Basic playback**

**Preparations:**

- Insert the AC cord plug into a standard 120V 60Hz polarized AC outlet. If the AC cord plug is plugged in for the first time, you need to set "Starting setup" (18).
- When connecting to other equipment, turn the power off.

**1 Press POWER on the unit or on the remote control to turn on the unit.**

The Power indicator will light.

- Every time you press **POWER**, the unit starts from TV/VCR mode.
- When using an amplifier, switch on the amplifier.

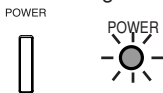

**2 Press DVD to select DVD mode.**

The DVD startup screen will appear on the screen. "Reading" display will change to "No Disc". (If DVD disc has already loaded, playback will start automatically.)



**3 Press OPEN/CLOSE.**

The disc tray opens.



**4 Place the disc on the disc tray.**

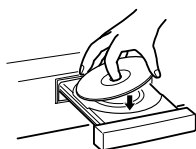

With the playback side down

- There are two different disc sizes. Place the disc in the correct guide on the disc tray. If the disc is out of the guide, it may damage the disc and cause the unit to malfunction.
- Do not place a disc which is unplayable on the disc tray.

**5 Press OPEN/CLOSE or PLAY.**

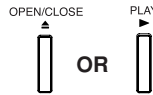

The disc tray closes automatically. On the TV-screen, "▲" changes to "Reading" and then playback commences.



- A menu screen will appear on the TV screen, if the disc has a menu feature. Press **ENTER**. Press **↑/↓/←/→** to select title, then press **ENTER**. Title is selected and play commences.

**6 Press STOP to end playback.**

**Resuming facility**

- The unit records the stopped point, depending on the disc. "■" appears on the screen. Press **PLAY** to resume playback (from the scene point).
- If you press **STOP** again or unload the disc ("■" appears on the screen.), the unit will clear the stopped point.



**To start playback in the stop mode**

Press **PLAY**.



**Notes:**



- **If the unit does not operate properly:** Static electricity, etc., may affect the player's operation. Dis connect the AC power cord once, then connect it again.
- When you select the TV/VCR mode during DVD playback, DVD playback will change to the still mode, and after 5 minutes it will change to the resuming stop mode automatically.



### ■ To obtain a higher quality picture

Occasionally, some picture noise not usually visible during a normal broadcast may appear on the TV screen while playing a DVD video disc because the high resolution pictures on these discs include a lot of information. While the amount of noise depends on the TV you use with this unit, you should generally reduce the sharpness adjustment on your TV when viewing DVD video discs.

### ■ About

The    icons on the heading bar show the playable discs for the function described under that heading.

 : You can use this function with DVD video discs.

 : You can use this function with Video CDs.

 : You can use this function with Audio CDs and CD-R/RW CDs.

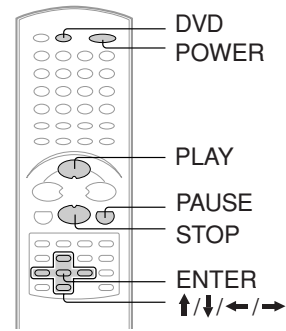

### ■ To pause playback (still mode)

Press **PAUSE** during playback.



To resume normal playback, press **PLAY**.

- The sound is muted during still mode.

### ■ To stop playback

Press **STOP**.



### ■ To remove the disc

Press **OPEN/CLOSE**.

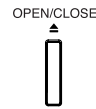

Remove the disc after the disc tray opens completely.

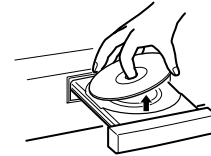

Be sure to press **OPEN/CLOSE** to close the disc tray after you remove the disc.

### Notes:

- If a non-compatible disc is loaded, "Incorrect Disc", "Region Code Error" or "Parental Error" will appear on the TV screen according to the type of loaded disc. In this case, check your disc again (see pages 8 and 59).
- Some discs may take a minute or so to start playback.
- When you set a single-faced disc label downwards (ie. the wrong way up) and press the OPEN/CLOSE button or the PLAY button on the unit, "Reading" will appear on the display for 30 seconds and then "Incorrect Disc" will continue to be displayed.
- Some discs may not work the resuming facility.
- Resuming cannot function when you play a PBC-featured Video CD while the PBC is on. To turn off the PBC, see page 52.
- Some playback operations of DVDs may be intentionally fixed by software producers. Since this unit plays DVDs according to the disc contents the software producers designed, some playback features may not be available. Also refer to the instructions supplied with the DVDs.
- Do not move the unit during playback. Doing so may damage the disc.
- Use the OPEN/CLOSE button to open and close the disc tray. Do not push the disc tray while it is moving. Doing so may cause the unit to malfunction.
- Do not push up on the disc tray or put any objects other than discs on the disc tray. Doing so may cause the unit to malfunction.
- In many instances, a menu screen will appear after playback of a movie is completed. Prolonged display of an on-screen menu may damage your television set, permanently etching that image onto its screen. To avoid this, be sure to press the POWER button on your remote control once the movie is completed.
- There may be a slight delay between you pressing the button and the function activating.



## Playing a disc (continued)

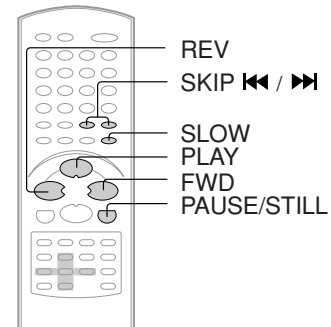

### DVD VCD CD Playing in fast reverse or fast forward directions

Press **REV** or **FWD** during playback.



**REV:** Fast reverse playback  
**FWD:** Fast forward playback

Each time you press **REV** or **FWD** button, the playback speed changes.

#### ■ To resume normal playback

Press **PLAY**.



#### Notes:

- The unit mutes sound and subtitles during reverse and forward scan of DVD video discs. However, the unit plays sound during fast forward or fast reverse play of audio CDs.
- The playback speed may differ depending on the disc.

### DVD VCD Playing frame by frame

Press **PAUSE/STILL** during still playback.



Each time you press **PAUSE/STILL**, the picture advances one frame.

#### ■ To resume normal playback

Press **PLAY**.



#### Note:

- The sound is muted during frame by frame playback.

### DVD VCD Playing in slow-motion

Press **SLOW** during playback.



Each time you press the button, the slow-motion speed changes.

#### ■ To resume normal playback

Press **PLAY**.



#### Note:

- The sound is muted during slow-motion playback.

### DVD VCD CD Locating a chapter or track

Press **SKIP** ◀◀ or ▶▶ repeatedly to display the chapter or track number you want.

Playback starts from the selected chapter or track.



To locate succeeding chapters or tracks.



Playback starts from the beginning of the current chapter or track. When you press twice in quick successions, playback starts from the beginning of the preceding chapter or track.

#### Notes:

- A "Prohibition" symbol 🚫 may appear at the upper left of the screen. This symbol means either the feature you tried is not available on the disc, or the unit can not access the feature at this time. This does not indicate a problem with the unit.
- The unit is capable of holding a still video image or On screen display image on your television screen indefinitely. If you leave the still video image or On screen display image displayed on your TV for an extended period of time, you risk permanent damage to your television screen. Projection televisions are very susceptible.

## Zooming/Locating desired scene

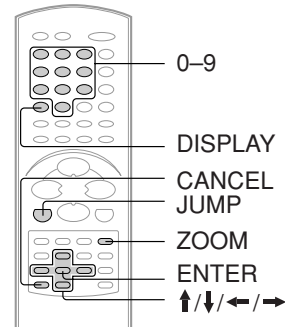

### DVD VCD Zooming

This unit will allow you to zoom in on the frame image. You can then make selections by switching the position of the frame.

**1 Press ZOOM during playback.**

The center part of the image will be zoomed in. Each press of **ZOOM** will change the ZOOM Q1 (x 1.3), Q2 (x 1.5) and Q3 (x 2.0).

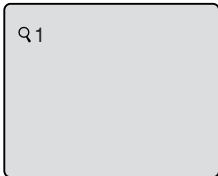

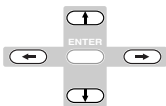

**2 Press ↑/↓/←/→ to view a different part of the frame.**

You may move the frame from the center position to UP, DOWN, LEFT or RIGHT direction.



**3 In the zoom mode press ZOOM repeatedly to return to a 1:1 view (Q Off).**



**Notes:**

- You can select the Pause, Slow or Search playback in the zoom mode.
- Some discs may not respond to zoom feature.

### DVD VCD CD Locating desired scene

Use the title, chapter and time recorded on the disc to locate the desired point to play back. To check the title, chapter and time, press **DISPLAY**.

**1 Press JUMP during playback or stop mode.**



Jump	Time	: ---:--
Title	:	---
Chapter	:	---
▲▼/Enter/0-9/Cancel/Jump		

**2 Press ↑ or ↓ to select the "Time", "Title" or "Chapter".**

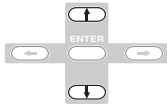

Jump	Time	: ---:--
Title	:	---
Chapter	:	---
▲▼/Enter/0-9/Cancel/Jump		

**3 Press Number buttons (0-9) to change the number.**

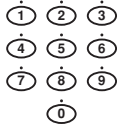

Jump	Time	: ---:--
Title	:	---
Chapter	:	12-
▲▼/Enter/0-9/Cancel/Jump		

- If you input a wrong number, press **CANCEL**.
- Refer to the package supplied with the disc to check the numbers.

**4 Press ENTER. Playback starts.**

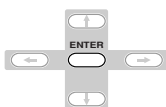

- When you change the title, playback starts from Chapter 1 of the selected title.
- Some discs may not work in the above operation.

**Note:**

In case of the Video-CD playback with PBC, the JUMP does not work. To turn off PBC, see page 52.

Advanced playback (DVD)

# Repeat playback/A-B Repeat playback

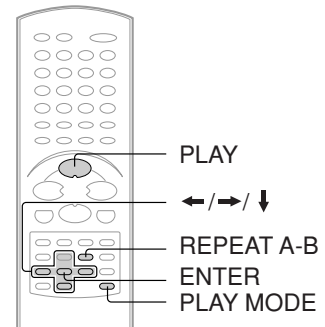

## DVD VCD CD Repeat playback

**1** Press **PLAY MODE** during playback or stop mode.



**2** [DVD] Press **←/→** or **ENTER** once or twice to select "Chapter" or "Title".

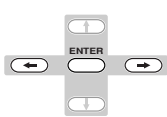

The unit automatically starts repeat playback after finishing the current title or chapter.

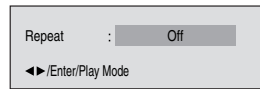

[Audio CD, Video CD]

Press **↓** to select "Repeat".

Press **←/→** or **ENTER** once or twice to select "Track" or "All".

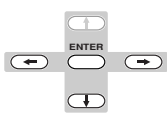

The unit automatically starts repeat playback after finishing the current track.

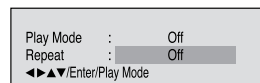

- If you set the repeat mode during stop mode, press **PLAY** to start Repeat playback.

**3** Press **PLAY MODE** again to make the screen disappear.

### ■ To resume normal playback

Select Repeat : "Off" in step 2.

#### Notes:

- Some discs may not work with the repeat operation.
- In case of Video CD with PBC, repeat functions are prohibited during playback.

## DVD VCD CD A-B Repeat playback

A-B repeat playback allows you to repeat material between two selected points.

**1** Press **REPEAT A-B** during playback.

The start point is selected.

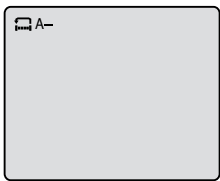
**2** Press **REPEAT A-B** again.

The end point is selected. Playback starts at the point that you selected. Playback stops at the end point, returns to Point A automatically, then starts again.

### ■ To resume normal playback

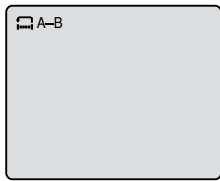
Press **REPEAT A-B** again.



"Off" appears on the screen.

#### Notes:

- In A-B Repeat mode, subtitles near the A or B locations may not be displayed.
- You can not set the A-B Repeat for the scenes that include multiple angles.
- A-B Repeat playback does not work when Repeat playback is activated.
- You may not be able to set A-B Repeat, during certain scenes of the DVD.
- A-B Repeat does not work with an interactive DVD, MP3/WMA/JPEG CD.
- A-B Repeat is prohibited when PBC is on.





## Program playback/Random playback

You can arrange the playback order of tracks or files on the disc. And also the unit selects tracks or files at random and playback them. These feature works for Audio CD, Video CD and MP3/WMA/JPEG CD.

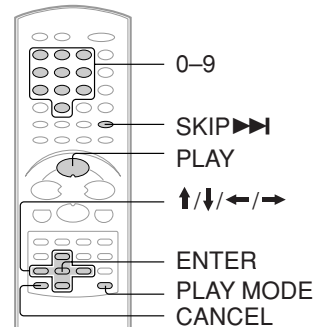

### VCD CD Program playback

#### 1 Press PLAY MODE in the stop mode.



Play Mode	: Off
Repeat	: Off
◀▶▲▼/Enter/Play Mode	

#### 2 Press ↑/↓ to select Play Mode, then press ←/→ or ENTER to select "Program".

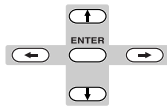

Play Mode	: Program
Repeat	: Off
1 ---	4 --- 7 --- 10 ---
2 ---	5 --- 8 --- 11 ---
3 ---	6 --- 9 --- 12 ---
[Clear] [Program Playback]	
◀▶▲▼/Enter/0-9/Cancel/Play Mode	

#### 3 Press ↑/↓ or ←/→ to select the programming position. Use Number buttons (0-9) to input the Track or file numbers.

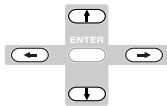

- To program others, repeat step 3.
- If you input a wrong number, press CANCEL.

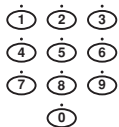

Play Mode	: Program
Repeat	: Off
1 9--	4 --- 7 --- 10 ---
2 3--	5 --- 8 --- 11 ---
3 11-	6 --- 9 --- 12 ---
[Clear] [Program Playback]	
◀▶▲▼/Enter/0-9/Cancel/Play Mode	

#### 4 Press ↑/↓/←/→ to select "Program Playback" and press ENTER.

The programs you selected will start to playback in the order.

- In case of JPEG file, press SKIP ►► to continue the program playback.
- To resume normal playback, select Play Mode: "Off" in step 2.

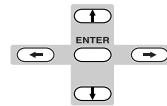

Play Mode	: Program
Repeat	: Off
1 9--	4 --- 7 --- 10 ---
2 3--	5 --- 8 --- 11 ---
3 11-	6 --- 9 --- 12 ---
[Clear] [Program Playback]	
◀▶▲▼/Enter/0-9/Cancel/Play Mode	

#### ■ To change the program

1. In the program mode, press ↑/↓/←/→ to select the track number.
2. Press **Number buttons (0-9)** to select the track number to be replaced.

#### ■ To clear the program one by one

In the program mode, press ↑/↓/←/→ to select the track number. Then press CANCEL.

#### ■ To clear all the programs

In the program mode, press ↑/↓/←/→ to select "Clear". Then press ENTER.

#### Notes:

- In playing back the Video CD with PBC, you can not set Program playback.
- The program is cancelled when you open the disc tray or turn the power off.

### VCD CD Random playback

#### 1 Press PLAY MODE during playback or stop mode.



#### 2 Press ↑/↓ to select Play Mode, then press ←/→ or ENTER to select "Random".

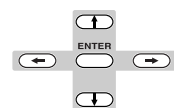

Play Mode	: Random
Repeat	: Off
◀▶▲▼/Enter/Play Mode	

#### 3 Press PLAY during stop mode.



The Random Playback will start.

- If you set "Random" during playback mode, Random playback will begin after the track that is currently being played has ended.
- To resume normal playback, select Play Mode: "Off" in step 2.

#### Note:

In playing back the Video CD with PBC, you can not set Random playback.

# Changing angles/Title selection/DVD menu

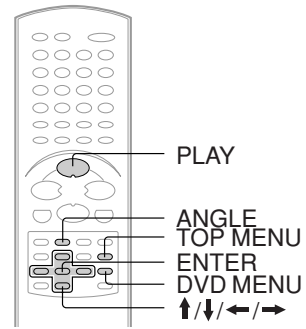

## DVD Changing angles

When playing back a disc recorded with multi-angle facility, you can change the angle that you are viewing the scene from.

**1 Press ANGLE during playback.**  
The current angle will appear.

**2 Press ANGLE repeatedly until the desired angle is selected.**

**Note:**  
Depending on the DVD, you may not be able to change the angles even if multi-angles are recorded on the DVD.

## DVD Title selection

Two or more titles are recorded on some discs. If the title menu is recorded on the disc, you can select the desired title.

**1 Press TOP MENU during playback.**  
Title menu appears on the screen.

**2 Press ↑/↓/←/→ to select the desired title.**

**3 Press ENTER or PLAY.**  
The playback of the selected title will start.

**Note:**  
Depending on the DVD, you may not be able to select the title. Depending on the DVD, a "title menu" may simply be called a "menu" or "title" in the instructions supplied with the disc.

## DVD menu

Some DVDs allow you to select the disc contents using the menu. When you play back these DVDs, you can select the subtitle language and sound-track language, etc. using the menu.

**1 Press DVD MENU during playback.**  
The DVD menu appears on the screen.  
• Press **DVD MENU** again to resume playback at the scene when you pressed **DVD MENU**.

**2 Press ↑/↓/←/→ to select the desired item.**

**3 Press ENTER.**  
The menu continues to another screen. Repeat steps 2 and 3 to set the item completely.

**Note:**  
Depending on the DVD, you may not be able to resume playback from the scene point when you pressed the DVD MENU button.



## Changing soundtrack language/ Subtitles

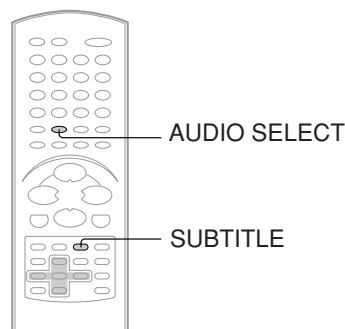

### Changing soundtrack language

You can select the language when you play a multilingual disc.

**1** Press **AUDIO SELECT** during playback.  
The current soundtrack language will appear.



2/8 Fra Dolby Digital

**2** Press **AUDIO SELECT** repeatedly until the desired language is selected.



1/8 Eng Dolby Digital

- The on screen display will disappear after a few seconds.

#### ■ In case of Video CD playback

Audio type changes as follows each time you press **AUDIO SELECT**.

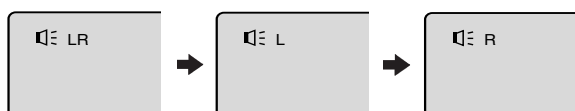

#### Notes:

- If the desired language is not heard after pressing the button several times, the language is not recorded on the disc.
- Changing soundtrack language is cancelled when you open the disc tray. The initial default language or available language will be heard if the disc is played back again.
- If you select DTS in playing DTS-encoded disc, no sound will be heard from the unit's speakers.

### Subtitles

When playing back a disc recorded with subtitles, you can select the subtitle language or turn the subtitle off.

**1** Press **SUBTITLE** repeatedly during playback until your desired language appears.



1/8 Eng

**2** To turn off the subtitle, press **SUBTITLE** until "Off" appears.



Off

- The on screen display will disappear after a few seconds.

#### Notes:

- Depending on the DVD, you may not be able to change subtitles, or to turn subtitles on or off.
- While playing a DVD, the subtitle may change when you open or close the disc tray.
- In some cases, a selected subtitle language may not be changed immediately.

Advanced playback (DVD)

# Karaoke playback/Disc status/ To turn off the PBC

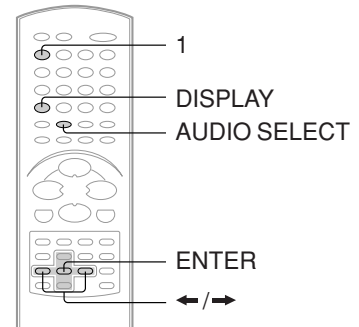

## DVD Karaoke playback

You can turn the vocal on or off recorded on the DVD KARAOKE.

**1** During DVD KARAOKE disc playback, press **AUDIO SELECT**.

The KARAOKE symbol (🎤) appears.

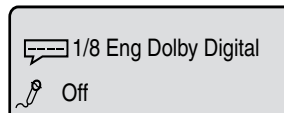

- If you play non-Karaoke disc, the KARAOKE symbol (🎤) does not appear.
- Some Karaoke discs may not have the vocal on/off function. In this case, the KARAOKE symbol (🎤) does not appear.

**2** Press **←** or **→** to select "On" or "Off".

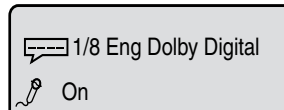
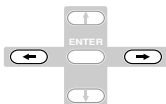

**On** : The primary vocal is output when it is recorded on the disc.  
**Off** : The primary vocal is not output.

- The on screen display will disappear after a few seconds.

**Notes:**

- The vocal output feature is used during playback of Dolby Digital (multi-channel) recorded DVD KARAOKE discs. This feature allows you to turn off vocal audio tracks, or restore them for background accompaniment.
- When playing Karaoke, connect appropriate audio equipment such as an amplifier to the unit.

## DVD VCD CD Disc status

With each press of **DISPLAY**, the status of the disc will appear on the screen and change as follows.

•**DISPLAY**



**DVD**

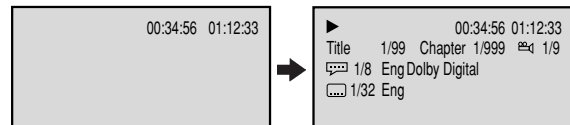

To make status display disappear, press **DISPLAY** again.

**Video CD**

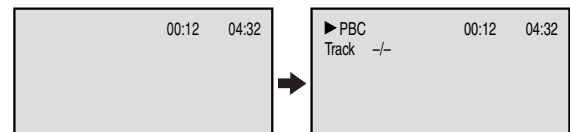

To make status display disappear, press **DISPLAY** again.

**Audio CD**

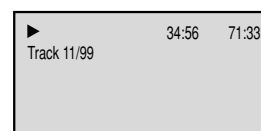

When you playback the CD disc, the status display will appear on the screen and continue displaying.

## VCD To turn off the PBC

Press number button **1** in the stop mode, then press **ENTER**.





## MP3/WMA/JPEG CD operation

This unit can play back the MP3/WMA/JPEG-data which has been recorded on CD-R or CD-RW. To produce the MP3/WMA/JPEG-data, you need a Windows-PC with CD-R/RW drive and a MP3/WMA/JPEG-encoding Software (not supplied). The Apple-HFS-System can not be played.

### CD MP3/WMA/JPEG CD information

#### Limitations on MP3/WMA/JPEG CD playback

- MP3/WMA/JPEG CD is the disc that is standardized by ISO9660, its file name must include 3-digits extension letters, "mp3", "wma", "jpg".
- MP3/WMA/JPEG CD must be correspond to the ISO standardized files.
- This unit can read 200 files per disc. If one directory has more than 200 files, it reads up to 200 files, the remaining files will be omitted.
- The unit is able to recognize up to a maximum of 50 directories per disc.
- MP3/WMA/JPEG CDs cannot be used for the purpose of recording.
- If the CD has both audio tracks and MP3/WMA/JPEG files, only audio tracks are played.
- It may take more than one minute for this unit to read MP3/WMA/JPEG files depending on its structure.
- Music recorded by "Joliet Recording Specification" can be played back, the file name is displayed (within 16 letters) on the screen. Long file names will be condensed.
- The music files recorded by "Hierarchical File System" (HFS) cannot be played.

#### Limitations on display

- The maximum number for display is 16 letters.  
Available letters for display are the following:  
capital or small alphabets of A through Z, numbers of 0 through 9, and \_ (under score).
- Other letters than those above are replaced in hyphen.

#### Notes on MP3/WMA/JPEG files

To play back MP3/WMA/JPEG CD in the recorded order,

1. Use MP3/WMA/JPEG software that records data alphabetically or numerically.
2. Name each file including two-digit or three-digit number (ex. "01" "02" or "001" "002").
3. Refrain from making too many sub-folders.

#### CAUTION:

- Some MP3/WMA/JPEG CDs can not be played back depending on the recording conditions.
- The CD-R/RW that has no music data or non MP3/WMA/JPEG files can not be played back.

#### Standard, sampling frequency, and the bit rate:

##### MP3 CD

MPEG-1 Audio

32kHz, 44.1kHz, 48kHz

32kbps ~ 320kbps (constant bit rate or variable bit rate)

The recommend recording setting for a high-quality sound is 44.1kHz of sampling frequency and 128kbps of constant bit rate.

##### WMA CD

WMA version 7, and 8

32kHz, 48kbps

44.1kHz, 48kbps ~ 192kbps

48kHz, 128kbps ~ 192kbps

The file recorded by mono, 48kHz, 48 kbps is not available to this unit.

Advanced playback (DVD)

# MP3/WMA/JPEG CD operation (continued)

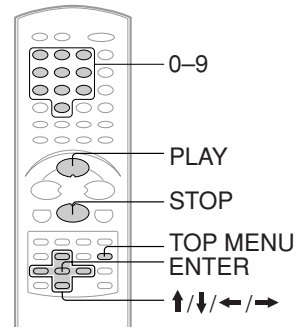

## MP3/WMA CD playback

**1** Place a disc on which MP3 or WMA files have been recorded onto the disc tray.

**2** A file menu screen will appear on the screen. Press **←/→** or **ENTER** to select folder.

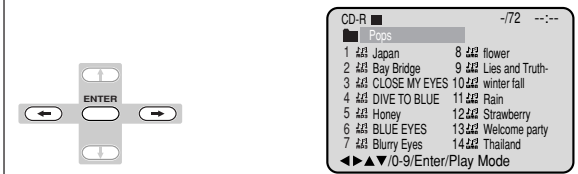

**3** Press **↑/↓/←/→** or **Number buttons (0-9)** to select the desired file.

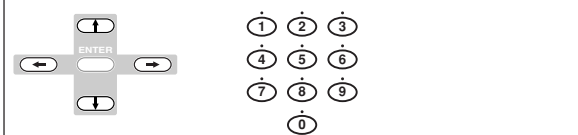

In case the folder includes more than 15 files, press **←** or **→** to display next file list.

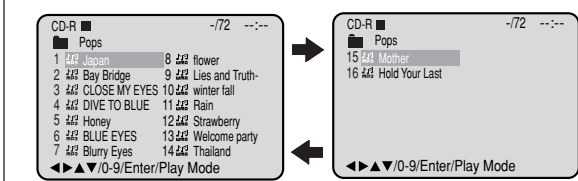

When **PLAY** has been pressed after displaying the file menu, or when the disc tray has been closed using **PLAY**, playback begins automatically starting from the first file. In this case, if the first file is an MP3/WMA file, only MP3/WMA files are played back in order. If the first file is a JPEG file, the first JPEG file is played back.

**4** Press **ENTER**. The selected file starts playing back.

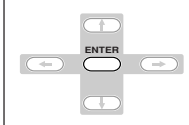

**5** Press **STOP** to end playback.

- The unit records the stopped point. "■" appears on the screen. Press **PLAY** to resume playback (from the scene point).
- If you press **STOP** again or unload the disc, the unit will clear the stopped point.

### About file menu

Media type	File number	Operation	Elapsed time
Folder	1/94		02:36
CD-R	■ Pops		
MP3	1 Japan	8 flower	
MP3	2 Bay Bridge	9 Lies and Truth-	
MP3	3 CLOSE MY EYES	10 Pic-1	
MP3	4 DIVE TO BLUE	11 Pic-2	
MP3	5 Honey	12 Pic-3	
MP3	6 BLUE EYES	13 Pic-4	
MP3	7 Blurry Eyes	14 Pic-5	
◀▶▲▼/0-9/Enter/Play Mode/DVD Menu			

: Indicates MP3-file  
 : Indicates WMA-file  
 : Indicates JPEG-file

- Notes:**
- The picture menu is displayed when the FUJICOLOR CD or the Kodak Picture CD are played. To display the file menu, press **TOP MENU**.
  - In the case of a CD containing a mixture of MP3, WMA and JPEG files, the files are played back by selecting them from the file menu.
  - MP3 or WMA file on the Kodak Picture CD is not recognized on this unit.

- Notes:**
- During MP3/WMA/JPEG-Playback, you can not use JUMP, A-B Repeat functions.
  - You can use Repeat (Track or All), Random functions and Program playback for MP3/WMA/JPEG CD playback (see pages 48 and 49).
  - In the case of a CD containing a mixture of MP3, WMA and JPEG files, the files are played back by selecting them from the file menu.



You can select your desired JPEG file on the file menu and picture menu. The selected JPEG file is automatically adjusted to the TV screen. (When the aspect ratio of the JPEG file is different to your TV screen, the black bar will appear at the top and bottom, or the both sides of the TV screen.)

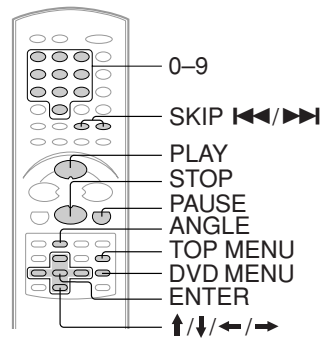

### CD JPEG CD playback

**1** Place a disc on which JPEG files have been recorded onto the tray.

**2** A file menu screen will appear on the screen. Press **←/→** to select folder.

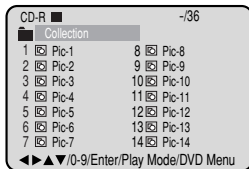
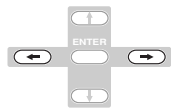

**3** Press **↑/↓/←/→** or Number buttons (0-9) to select the desired file.

To display a picture menu, press **DVD MENU**. (To return to a file menu, press **TOP MENU**.) Press **←/→** or **↑/↓** to select the desired file.

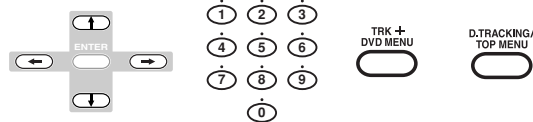

- To display next list, press **SKIP** **◀▶**.
- When **PLAY** has been pressed after displaying the file menu, or when the disc tray has been closed after pressing **PLAY**, playback begins automatically starting from the first file. In this case, if the first file is a JPEG file, the first JPEG file is played back. If the first file is an MP3/WMA file, only MP3/WMA files are played back in order.

**4** Press **ENTER**. The selected picture appears on the screen.

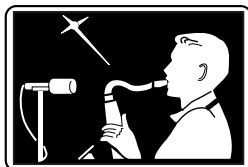
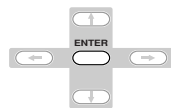

#### Rotating an image

You can rotate an image by 90 degrees by pressing **ANGLE** during playback of the image.

"**▶▶▶▶**", "**▶▶▶▶**", "**▶▶▶▶**" or "**▶▶▶▶**" appears briefly on the screen.

**5** Press **STOP** to end playback. The file menu appears on the screen.

If you want to watch the other file, repeat steps 3 ~ 4.



### CD Slide show playback

The slide show enables you to view pictures (files) one after another automatically.

#### Preparation:

- Set "JPEG Interval" setting to "5 Seconds", "10 Seconds" or "15 Seconds" (58).

**1** Select your desired starting file for the slide show in the step 3 as left.

**2** Press **ENTER** to start slide show from the selected file.

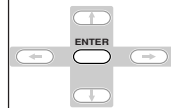

- If you press **PAUSE** during the slide show, the slide show stops temporary. "**||**" appears briefly on the picture. If the picture appears upside down or sideways, press **ANGLE** repeatedly until it's right side up. "**▶▶▶▶**", "**▶▶▶▶**", "**▶▶▶▶**" or "**▶▶▶▶**" appears briefly on the screen. Press **PLAY** or **SKIP** **▶▶** again to resume the slide show.
- When the slide show playback finished the file list appears.
- To stop the slide show, press **STOP**. The file list appears.

Advanced playback (DVD)

## Selecting *PROGRESSIVE* scan

The progressive scan capability provides the highest resolution pictures with less flicker and line structure.

**Note:**

When you connect the unit to another TV or a monitor using the Audio/Video output jacks, do not select Progressive scan On. If you do it the video output does not feed the correct signals and you can not see any picture (only seen black screen), but only the sounds will be heard.

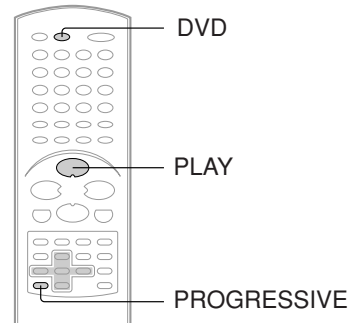

### DVD VCD CD Selecting *PROGRESSIVE* scan

**Preparation:**

- Press **DVD** to select the DVD mode.
- Load a disc.

#### 1 Press and hold **PROGRESSIVE** for one second in the stop mode to select the Progressive mode On.

The interlaced startup screen will change to the progressively scanned one, then the “**P On**” (Progressive On) display will appear for approx. 2 seconds on the screen.



There are two types of source content in pictures recorded in DVD video discs: film content (pictures recorded from films at 24 frames per second) and video content (video signals recorded at 30 frames per second).  
  
When the unit plays back a film source material, uninterlaced progressive output signals are created using the original information. When a video content is played back, the unit interleaves lines between the interlaced lines on each to create the interpolated picture and outputs as the progressive signal.

#### 2 Press **PLAY** to start playback.



- The unit recognizes the picture source (film or video) of the current disc according to the disc information.

#### ■ To select **PROGRESSIVE scan Off (Interlace)**

Press and hold **PROGRESSIVE** for one second in the stop mode.

The progressively scanned startup screen will change to the interlaced one, then the “**P Off**” (Progressive Off : Interlace) display will appear for 2 seconds on the screen.



**Notes:**

- Some discs may not be played back with the progressive scanning mode correctly because of the disc characteristics or recording condition.
- You cannot make the progressive scanning mode active in following cases.
  - The unit is in the TV/VCR mode.
  - The disc is played back in the DVD mode.



# Customizing the function settings

You can change the default settings to customize performance to your preference.

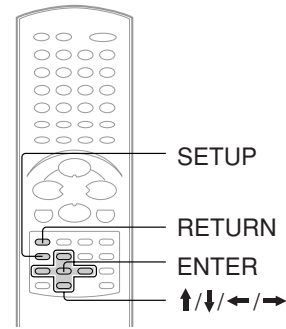

## Setting procedure

**1** Press **SETUP** during stop mode.

 The following on-screen display appears.

Language Picture Sound Parental Other

◀▶▶/Enter/Setup/Return

**2** Press **←** or **→** to select the desired section, then press **↓** or **ENTER**.

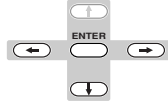

**3** Press **↑** or **↓** to select the desired option.

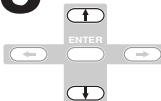

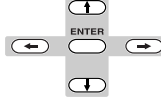

**4** Change the selection using **↑/↓/←/→** or **ENTER**, by referring to the corresponding pages 58 and 59.



- Repeat step 3 and 4 to change other settings.
- Press **↑** to select another operation, go back to step 2.

**5** To make **SETUP** screen disappear, press **SETUP** or **RETURN**.

Section	Option	Details	Page
Language	Menu	To select the language of "Menu", "Subtitle" and "Audio" if their languages are recorded onto the disc more than one language.	58
	Subtitle		
	Audio		
Picture	Tv Screen	To select a picture size according to the aspect ratio of your TV.	58
	Display	To turn on or de-activate the operational status display on the screen.	58
	JPEG Interval	To select a preferred setting for the slide show playback.	58
	Select Files	To select your desired file type for playing back a containing a mixture of MP3, WMA, JPEG files.	58
Sound	DRC	To select On or Off for DRC (Dynamic Range Control).	59
Parental	Password	Input 4-digit password to set the parental level.	59
	Parental	To select a preferred parental level for the parental setting.	
Other	OSD Language	To select a preferred language for on screen display.	59

Function setup (DVD)

## Customizing the Function Settings (continued)

### Setting details

#### Language

	Language	Picture	Sound	Parental	Other
Menu	English	English			
Subtitle	Automatic	Francais			
Audio	English	Espanol			Other

◀▶▲▼/Enter/Setup/Return

#### ■ Menu, Subtitle, Audio

You can select the language of "Menu", "Subtitle" and "Audio" if more than one languages are recorded onto the disc.

#### English, Francais, Espanol:

The selected language will be heard or seen.

#### Other:

Other language can be selected (see the "Language code list" on page 61).

#### Original: (Audio)

The unit will select the first priority language of each disc.

#### Automatic: (Subtitle)

- The unit will automatically select the same language in the AUDIO setting.
- When the unit selects the same language as the AUDIO, the subtitles will not appear during playback.
- When you do not use the same language as the AUDIO, the subtitles will appear during playback.

#### Off: (Subtitle)

Subtitles do not appear.

#### Note:

If the selected language is not recorded on the disc, the first-priority language is selected.

#### Picture

	Language	Picture	Sound	Parental	Other
Tv Screen	4:3	4:3			
Display	On	4:3			
JPEG Interval	Off				
Select Files	All				

◀▶▲▼/Enter/Setup/Return

#### ■ Tv Screen

You have the following screen sizes to choose from:

#### 4:3 Letter box:

Select this mode when connecting to a conventional TV. When playing back a wide screen-DVD disc, it displays the wide picture with black bands at the top and bottom of screen.

#### 4:3 Pan scan:

It displays the wide picture on the whole screen with left and right edges automatically cut off.

#### Note:

If the DVD disc is not formatted in the pan & scan style, it displays 4:3 style.

#### ■ Display

On screen display can be switched on or off when you press the buttons.

**On:** On screen displays appear when you press the buttons (factory setting).

**Off:** On screen displays do not appear when you press any buttons.

#### ■ JPEG Interval

You can continuously play back all JPEG files automatically. After the setting below, start playing the disc on which JPEG files have been recorded.

#### Off:

Plays back one file at a time.

#### 5 Seconds:

Plays back images in the form of a slide show at 5 second intervals.

#### 10 Seconds:

Plays back images in the form of a slide show at 10 second intervals.

#### 15 Seconds:

Plays back images in the form of a slide show in 15 second intervals.

#### ■ Select Files

When playing back a CD containing a mixture of MP3, WMA and JPEG files, only MP3/WMA or JPEG files can be displayed on the file menu.

#### All:

Displays all files.

#### Music Only:

Displays only MP3/WMA files.

#### Pictures Only:

Displays only JPEG files.



## Sound

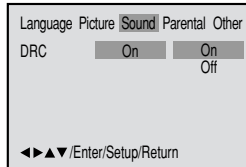

### ■ DRC

DRC (Dynamic Range Control) enables you to control the dynamic range so as to achieve a suitable sound for your equipment.

- On:** Loud sound such as explosion or similar is toned down slightly when played back. This makes it suitable for when it is connected to a stereo.
- Off:** It plays back at the recording level on the disc.

#### Notes:

- This function works only during playback of Dolby Digital recorded discs.
- The level of Dynamic Range Reduction may differ depending on DVD video disc.

## Parental

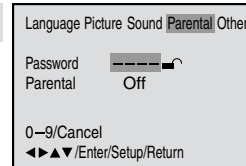

### Parental control setting

Some discs are specified not suitable for children. Such discs can be limited not to play back with the unit.

- Press **↑** or **↓** to select "Parental", then press **←** or **→** until the level you require appears.
  - Level Off: The parental control setting does not function.
  - Level 8: All DVD software can be played back.
  - Level 1: DVD software for adults cannot be played back.

Select from the level 1 to level 8. The limitation will be more severe as the level number is lower.

- Press **↑** or **↓** to select "Password". Press **Number buttons (0–9)** to input a 4-digit password. Be sure to remember this number!
  - If you input a wrong number, press **CANCEL**.
- Press **ENTER** to store the password.
 

Note: Now the rating is locked and the setting can not be changed unless you enter the correct password.

#### Notes:

- Depending on the discs, the unit cannot limit playback.
- Some discs may not be encoded with specific rating level information though its disc jacket says "adult." For those discs, the age restriction will not work.

### To change the parental level

- Press **↑** or **↓** to select "Password".
- Press **Number buttons (0–9)** to enter the password you have stored.
- Press **ENTER**.
  - The rating is now unlocked.
- Press **↑** or **↓** to select "Parental", then press **←** or **→** to change the parental level.
- Press **↑** or **↓** to select "Password", then press **Number buttons (0–9)** to enter the password.
 

Note: You can change the password if you want.
- Press **ENTER**.
 

Now the parental level is changed and locked.

### If you forget the password...

- Press **OPEN/CLOSE** to open the disc tray.
- Remove the disc.
- Press **OPEN/CLOSE** again to close the disc tray. "No Disc" appears on the screen.
- While holding **STOP** down on the front panel, press **7** on the remote control. "PASSWORD CLEAR" appears on the screen.
- Enter a new password again.

#### Notes:

- Depending on the discs, the unit may not be able to limit playback.
- Some discs may not be encoded with specific rating level information though its disc jacket says "adult." For those discs, the parental control feature will not work.

## Other

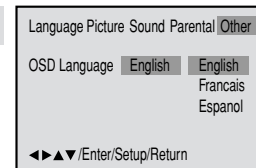

### ■ OSD Language

The setup language can be selected.

- English:** To display OSD language is English.
- Francais:** To display OSD language is Francais.
- Espanol:** To display OSD language is Espanol.

#### Note:

If each setup (pages 58 and 59) has been completed, the unit can always be worked under the same conditions (especially with DVD discs).

Each setup will be retained in the memory even if you turn the power off.

## Temporary disabling of rating level by DVD disc

Depending on the DVD disc, the disc may try to temporarily cancel the rating level that you have set. It is up to you to decide whether to cancel the rating level or not.

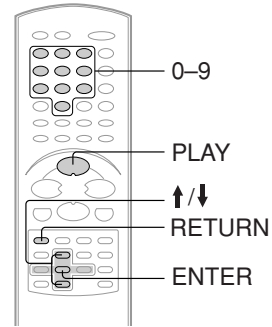

- 1** Load a DVD disc and press **PLAY** or **OPEN/CLOSE** on the unit (see page 44).

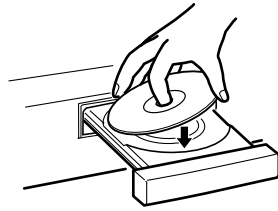
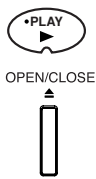

- 2** If the DVD disc has been designed to temporarily cancel the Rating level, the screen which follows the "Reading" screen will change, depending on which disc is played. If you select "YES" with the **ENTER** key, "Your disc exceeds the parental control level#." screen will then appear.

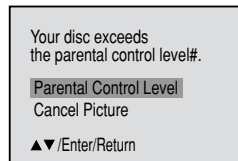

- 3** If you wish to cancel the set rating level temporarily, select "Parental Control Level" with **↑** or **↓**, then press **ENTER**. If the 4-digit password at step 2 on page 59 has been set, the password entering screen will appear as shown in step 4.

Alternatively, if the password has not been set, playback will commence. If you don't know (or have forgotten) the password, select "Cancel Picture".

The setting screen will disappear. Press **OPEN/CLOSE** to remove the disc.

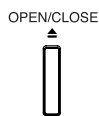
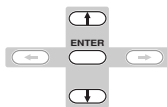

- 4** Enter the password with **Number** buttons (0-9). Then press **ENTER**.

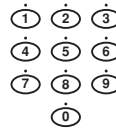

If you interrupt the entering, press **RETURN**.

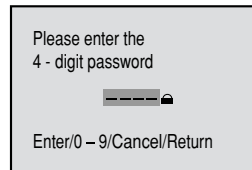
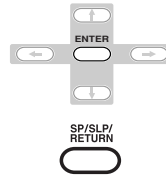

- 5** Playback will commence if the entered password was correct.

**Note:**

This temporary cancellation of rating level will be kept until the disc is ejected. When the disc is ejected, the original rating level will be set again automatically.

## Language code list

Enter the appropriate code number for the initial settings "Menu", "Subtitle" and/or "Audio" (58).

Language Name	Code	Language Name	Code	Language Name	Code	Language Name	Code
Abkhazian	1112	Fiji	1620	Lingala	2224	Singhalese	2919
Afar	1111	Finnish	1619	Lithuanian	2230	Slovak	2921
Afrikaans	1116	French	1628	Macedonian	2321	Slovenian	2922
Albanian	2927	Frisian	1635	Malagasy	2317	Somali	2925
Amharic	1123	Galician	1722	Malay	2329	Spanish	1529
Arabic	1128	Georgian	2111	Malayalam	2322	Sundanese	2931
Armenian	1835	German	1415	Maltese	2330	Swahili	2933
Assamese	1129	Greek	1522	Maori	2319	Swedish	2932
Aymara	1135	Greenlandic	2122	Marathi	2328	Tagalog	3022
Azerbaijani	1136	Guarani	1724	Moldavian	2325	Tajik	3017
Bashkir	1211	Gujarati	1731	Mongolian	2324	Tamil	3011
Basque	1531	Hausa	1811	Nauru	2411	Tatar	3030
Bengali; Bangla	1224	Hebrew	1933	Nepali	2415	Telugu	3015
Bhutani	1436	Hindi	1819	Norwegian	2425	Thai	3018
Bihari	1218	Hungarian	1831	Oriya	2528	Tibetan	1225
Breton	1228	Icelandic	1929	Panjabi	2611	Tigrinya	3019
Bulgarian	1217	Indonesian	1924	Pashto, Pushto	2629	Tonga	3025
Burmese	2335	Interlingua	1911	Persian	1611	Turkish	3028
Byelorussian	1215	Irish	1711	Polish	2622	Turkmen	3021
Cambodian	2123	Italian	1930	Portuguese	2630	Twi	3033
Catalan	1311	Japanese	2011	Quechua	2731	Ukrainian	3121
Chinese	3618	Javanese	2033	Rhaeto-Romance	2823	Urdu	3128
Corsican	1325	Kannada	2124	Romanian	2825	Uzbek	3136
Croatian	1828	Kashmiri	2129	Russian	2831	Vietnamese	3219
Czech	1329	Kazakh	2121	Samoan	2923	Volapük	3225
Danish	1411	Kirghiz	2135	Sanskrit	2911	Welsh	1335
Dutch	2422	Korean	2125	Scots Gaelic	1714	Wolof	3325
English	1524	Kurdish	2131	Serbian	2928	Xhosa	3418
Esperanto	1525	Laothian	2225	Serbo-Croatian	2918	Yiddish	2019
Estonian	1530	Latin	2211	Shona	2924	Yoruba	3525
Faroese	1625	Latvian, Lettish	2232	Sindhi	2914	Zulu	3631

## Troubleshooting

Check the following guide for the possible cause of a problem before contacting service.

SYMPTOMS	CAUSE	POSSIBLE SOLUTIONS	PAGE
<b>POWER</b>			
No power.	The AC power cord is not connected.	Connect the AC power cord to the AC outlet.	5
Although the power is on, the unit does not operate.	Cassette or disc is not inserted.	Insert a video cassette or disc.	33, 44
	The TIMER REC buttons are depressed.	Press the TIMER REC buttons.	40
<b>TV BROADCAST RECEPTION</b>			
Poor or no picture.	TV station experiencing problems.	Try another channel.	23
	Picture control is not adjusted.	Check picture control adjustments.	31
	Possible local interference.	Check for source of reception disturbance.	64
	Antenna (CABLE) connector is not connected or possible local interference.	Check CABLE connection or VHF/UHF antenna, reposition or rotate antenna.	14, 15
Poor or no color.	TV station experiencing problems.	Try another channel.	23
	Picture control is not adjusted.	Check picture control adjustments.	31
	Possible local interference.	Check for source of reception disturbance.	64
	Antenna (CABLE) connector is not connected or possible local interference.	Check CABLE connection or VHF/UHF antenna, reposition or rotate antenna.	14, 15
Picture wobbles or drifts.	TV station experiencing problems.	Try another channel.	23
	Antenna (CABLE) connector is not connected or possible local interference.	Check CABLE connection or VHF/UHF antenna, reposition or rotate antenna.	14, 15
	Cable TV channel is scrambled.	Try another channel.	23
No CATV reception.	CABLE connector is not connected.	Check all CABLE connections.	14
	TV/CABLE selection is set to the TV position.	Set the selection to the CABLE position.	26
	Cable TV service interrupted.	Contact your Cable TV company.	14
No reception above channel 13.	TV/CABLE selection is not set to the appropriate position.	Make sure selection is in the appropriate position.	26
	UHF antenna is not connected.	Check UHF antenna.	14
Poor or no sound.	TV station experiencing problems.	Try another channel.	23
	Antenna (CABLE) connector is not connected or possible local interference.	Check CABLE connection or VHF/UHF antenna, reposition or rotate antenna.	14, 15
	Possible local interference.	Check for source of reception disturbance.	64
	The MUTE button is depressed.	Check the MUTE button has not been pressed.	24
TV shuts off.	TV station stopped broadcasting.	Tune new channel.	23
	Sleep timer is set.	Set Sleep Timer to "0".	24
Closed caption is not activated.	TV station experiencing problems or program tuned is not closed captions.	Try another channel.	23
	TV signal is weak.	Check CABLE connection of VHF/UHF antenna, reposition or rotate antenna.	14, 15
	The CLOSED CAPTION button is not depressed.	Press the CLOSED CAPTION button to turn on the closed caption.	25



SYMPTOMS	CAUSE	POSSIBLE SOLUTIONS	PAGE
<b>VCR</b>			
TV recording does not work.	The video cassette's erase prevention tab is broken off.	Place a piece of adhesive tape over the hole.	33
Timer recording does not work.	The time is not set correctly.	Reset the present time.	20, 21
	The recording start/end time is not set correctly.	Reset the start/end time.	40
	The TIMER REC buttons have not been pressed at the same time (the TIMER REC indicator is not lit).	Press the TIMER REC buttons at the same time (the TIMER REC indicator is lit).	40
Noise bars appear on the screen.	Tape is old or worn.	Replace the tape.	–
	Tracking adjustment is beyond range of automatic tracking circuit.	Adjust tracking manually using the TRK +/- buttons on the remote control.	35
	Video heads are dirty.	Clean the video heads.	37
<b>DVD</b>			
The playback picture has occasional distortion.	The disc is dirty.	Eject the disc and clean it.	7
	It is in fast forward or fast reverse playback.	Some times a small amount of picture distortion may appear. This is not a malfunction.	–
The unit does not start playback.	No disc is inserted.	Insert a disc.	44
	An unplayable disc is inserted.	Insert a playable disc (Check the disc type and color system).	8
	The disc is placed upside down.	Place the disc with the playback side down.	44
	The disc is not placed within the guide.	Place the disc correctly inside the guide on the disc tray.	44
	The disc is dirty.	Clean the disc.	7
	The parental lock function is set.	Cancel the parental lock function or change the parental lock level.	59, 60
Playback does not follow the course of the disc's program.	It is in the mode of repeat playback, memory playback, etc.	These operations may prevent a proper progress of the contents.	–
⚡ appears on the screen.	The function is prohibited with the unit or the disc.	–	8
<b>REMOTE CONTROL</b>			
Remote control does not operate.	The remote control is not aimed at the sensor.	Aim the remote control at the remote sensor.	12
	Distance is too far or too much light in the room.	Operate within 5 m or reduce the light of the room.	12
	There is an obstacle in the path of the beam.	Clear the path of the beam.	12
	The batteries are weak.	Replace the batteries.	12
	The batteries are not inserted correctly.	Insert correctly.	12

Others



## Reception disturbances

Most types of television interference can be remedied by adjusting the height and position of the VHF/UHF antenna. Outdoor antennas are recommended for best results. The most common types of television interference are shown below. If one of these symptoms appear when the unit is connected to a Cable TV system, the disturbance may be caused by the local Cable TV company broadcast.

### IGNITION

Black spots or horizontal streaks may appear, the picture may flutter or drift. Usually caused by interference from automobile ignition systems, neon lamps or AC powered tools and appliances such as drills or hair dryers.



### GHOSTS

Ghosts are caused by the television signal following two paths. One is the direct path and the other is reflected by tall buildings, hills or other large objects. Changing the direction or position of the antenna may improve the reception.



### SNOW

If the unit is located far from the TV station, in a fringe reception area where the signal is weak, small dots may appear in the picture. If the signal is extremely weak, the installation of a larger external antenna may be necessary.



### RADIO FREQUENCY INTERFERENCE (RFI)

Caused by two-way radios, this type of interference produces moving ripples or diagonal streaks in the picture. Some cases may cause a loss of contrast in the picture. Changing the direction and position of the antenna or installing an RFI filter may improve the picture.



### PICTURE SIZE VARIATION

A slight picture size variation is normal when you adjust the CONTRAST or BRIGHTNESS settings.



## CARE AND MAINTENANCE

To prevent fire or shock hazard, disconnect the unit from the power source before cleaning.

The finish on the cabinet may be cleaned with mild soap and a soft, damp cloth and cared for as other furniture. Use caution when cleaning or wiping the plastic parts.





# Specifications

	MW24FPX	MW27FPX
<b>General</b>		
Power supply	AC 120 V 60 Hz	
Power consumption		
Operation:	165 W	175 W
Stand by:	4 W	
Picture tube	Type 24 (600 mm diagonal)	Type 27 (676.6 mm diagonal)
Speaker	1-13/16 x 3-7/8 inches (46 x 99 mm), 8 Ω x 2	
Audio output power	1.5 W + 1.5 W	2.5 W +2.5 W
Weight	81.6 lbs (37 kg)	99.2 lbs (45 kg)
Dimensions		
Width:	25-13/16 inches (655 mm)	29-1/8 inches (740 mm)
Height:	22-13/16 inches (580 mm)	25-3/8 inches (645 mm)
Depth:	18-5/8 inches (472.5 mm)	19-7/16 inches (493 mm)
Tuner	181 channel freq. synthesized VHF 2-13 UHF 14-69 CATV 125 Channels	
Antenna input	UHF/VHF: 75 Ω coaxial	
Color system	NTSC	
Video head	4 Rotary heads	
Audio track	Hi-Fi sound - 2 Tracks / MONO sound - 1 Track	
Hi-Fi frequency response	20 Hz to 20,000 Hz	
Hi-Fi dynamic range	More than 90 dB	
F.FWD/REW time at 25°C (77°F)	Approx. 1 minute and 48 seconds (with T-120 cassette tape)	
Applicable disc	DVD (12 cm, 8 cm), CD (12 cm, 8 cm)	
Frequency range	DVD: 4 Hz-22 kHz, CD: 4 Hz-20 kHz	
Operating conditions	Temperature: 5°C-40°C (41°F-104°F), Operating status: Horizontal	
<b>Input/Output</b>		
Video input	1.0 V (p-p), 75 Ω, negative sync., pin jack x 2	
S-Video input	(Y)1.0V(p-p), 75Ω negative sync., Mini DIN 4-pin x 1 (C)0.286V(p-p), 75Ω	
Video output	1.0 V (p-p), 75 Ω, negative sync., pin jack x 1	
Audio input	-8 dBm, 50 kΩ, negative sync., pin jack (L/R) x 2	
Audio output	-8 dBm, 1 kΩ, negative sync., pin jack (L/R) x 1	
Audio output (DIGITAL COAXIAL)	0.5 V (p-p), 75 Ω, pin jack x 1	
<b>Supplied accessories</b>		
Remote control (WC-FPN2) .....	1	
Batteries (R03/AAA) .....	2	
300-75 Ω matching transformer .....	1	



Others

• Designs and specifications are subject to change without notice.





## **Limited warranty**

Toshiba America Consumer Products, L.L.C. ("TACP") makes the following limited warranties. These limited warranties extend to the original consumer purchaser or any person receiving this set as a gift from the original consumer purchaser and to no other purchaser or transferee .

### **Limited Ninety (90) Day Warranty**

TACP warrants this product and its parts against defects in materials or workmanship for a period of ninety (90) days after the date of original retail purchase. During this period, TACP will repair a defective product or part, without charge to you. You must deliver the entire set to an Authorized TACP Service Station. You pay for all transportation and insurance charges for the set to and from the Service Station.

### **Limited One (1) Year Warranty**

TACP further warrants the parts in this product against defects in materials or workmanship for a period of one year after the date of original retail purchase. During this period TACP will replace a defective part without charge to you, except that if a defective part is replaced after ninety (90) days from the date of original retail purchase you pay labor charges involved in the replacement. You must also deliver the entire product to a TACP Authorized Service Station. You are responsible for all transportation for the set to and from the Service Station.

### **Limited Two (2) Year Warranty of Picture Tube**

TACP further warrants the picture tube in this product against defects in materials or workmanship for a period of two (2) years after the date of original retail purchase. During this period, TACP will replace a defective picture tube without charge to you except that if a defective picture tube is replaced after ninety (90) days from the date of the original retail purchase, you pay labor charges involved in the replacement. You are responsible for all charges involved in the replacement. You are responsible for all transportation and insurance charges for the set to and from the Service Station.

### **Rental Units**

The warranty for rental units begins with the first rental or thirty (30) days from the date of shipment to the rental firm, whichever comes first.

### **Commercial Units**

Products sold and used for commercial use have a limited ninety (90) day warranty for all parts, labor and picture tube.

### **Owner's Manual and Demographic Card**

You should read this owner's manual thoroughly before operating this product. You should complete and mail the enclosed Demographic card within ten days after you, or the person who has given you this product as a gift, purchased this product. This is one way to enable TACP to provide you with better customer service and improved products. Failure to return the Demographic card will not affect your rights under this warranty.

### **Your Responsibility**

The above warranties are subject to the following conditions:

- ( 1 ) You must retain your bill of sale or provide other proof of purchase.
- ( 2 ) All warranty servicing of this product must be made by an Authorized TACP Service Station.
- ( 3 ) These warranties are effective only if the product is purchased and operated in the U.S.A. or Puerto Rico.
- ( 4 ) Labor service charges for set installation, set up, adjustment of customer controls and installation or repair of antenna systems are not covered by this warranty. Reception problems caused by inadequate antenna systems are your responsibility.
- ( 5 ) Warranties extend only to defects in materials or workmanship as limited above and do not extend to any product or parts which have been lost or discarded by you or to damage to products or parts caused by misuse, accident, damage caused by Acts of God, such as lightning or fluctuations in electric power, improper installation, improper maintenance or use in violation of instructions furnished by us; or to units which have been altered or modified without authorization of TACP.



## Limited warranty (continued)

### How to Obtain Warranty Service

If after following all of the operating instructions in this manual and checking the section "Troubleshooting" and you still find that service is needed;

- ( 1 ) Call the TACP toll free number 1-800-631-3811 after you find a defective product or part to find the nearest Toshiba Authorized Service Station.
- ( 2 ) Please present your bill of sale or other proof to the Authorized Service Station.

"TACP Authorized Service Station personnel will come to your home when warranty service is required. Depending on the type of repair required, the service will either be performed in your home or the set will be taken to the TACP Authorized Service Station for repair and returned to your home at no cost to you".

**In the Continental United States contact:**



All warranties implied by state law, including the implied warranties of merchantability and fitness for a particular purpose, are expressly limited to the duration of the limited warranties set forth above. With the exception of any warranties implied by state law as hereby limited, the foregoing warranty is exclusive and in lieu of all other warranties, guarantees, agreements and similar obligations of manufacturer or seller with respect to the repair or replacement of any parts. In no event shall TACP be liable for consequential or incidental damages.

No person, agent, distributor, dealer or company is authorized to change, modify or extend the terms of these warranties in any manner whatsoever. The time within which action must be commenced to enforce any obligation of TACP arising under this warranty or under any statute, or law of the United States or any state thereof, is hereby limited to 90 days from the date you discover or should have discovered, the defect. This limitation does not apply to implied warranties arising under state law.

This warranty gives you specific legal rights and you may also have other rights which may vary from state to state. Some states do not allow limitation on how long an implied warranty lasts, when an action may be brought, or the exclusion or limitation of incidental or consequential damages, so the above provisions may not apply to you.

Others



# TOSHIBA

**TOSHIBA AMERICA CONSUMER PRODUCTS, L.L.C.**



04/04  \*J5Q10501A\*

Printed in Thailand

## Free Manuals Download Website

<http://myh66.com>

<http://usermanuals.us>

<http://www.somanuals.com>

<http://www.4manuals.cc>

<http://www.manual-lib.com>

<http://www.404manual.com>

<http://www.luxmanual.com>

<http://aubethermostatmanual.com>

Golf course search by state

<http://golfingnear.com>

Email search by domain

<http://emailbydomain.com>

Auto manuals search

<http://auto.somanuals.com>

TV manuals search

<http://tv.somanuals.com>