

TOSHIBA

OWNER'S MANUAL

Projection Television

COLORSTREAM™

TZ50V61
TZ55V61
TZ61V61

Owner's Record

The model number and serial number are on the back of your TV. Record these numbers in the spaces below. Refer to these numbers whenever you communicate with your Toshiba dealer about this TV.

Model number:

Serial number:

Introduction

Connecting
your TV

Using the
Remote Control

Setting up
your TV

Using the TV's
Features

Appendix

Index

Important Information

WARNING

TO REDUCE THE RISK OF FIRE OR ELECTRIC SHOCK, DO NOT EXPOSE THIS APPLIANCE TO RAIN OR MOISTURE.

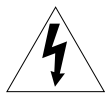
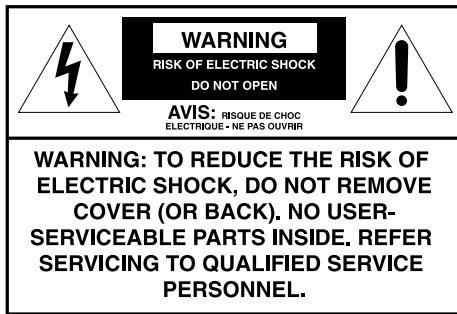

The lightning symbol in the triangle tells you that the voltage inside this product may be strong enough to cause an electric shock. **DO NOT TRY TO SERVICE THIS PRODUCT YOURSELF.**



The exclamation mark in the triangle tells you that important operating and maintenance instructions follow this symbol.

CAUTION

TO PREVENT ELECTRIC SHOCK, DO NOT USE THIS POLARIZED PLUG WITH AN EXTENSION CORD RECEPTACLE OR OTHER OUTLET UNLESS THE PRONGS CAN BE FULLY INSERTED INTO THE OUTLET TO PREVENT ANY EXPOSURE OF THE PRONGS ON THE POLARIZED PLUG.

ATTENTION

POUR PRÉVENIR LES CHOCES ÉLECTRIQUES NE PAS UTILISER CETTE FICHE POLARISÉE AVEC UN PROLONGATEUR, UNE PRISE DE COURANT OU UNE AUTRE SORTIE DE COURANT, SAUF SI LES LAMES PEUVENT ÊTRE INSÉRÉS À FOND SANS EN LAISSER AUCUNE PARTIE À DÉCOUVERT.

CAUTION

The plug has one prong wider than the other and will fit only one way into a standard electrical outlet (120 volt AC, 60 Hz). If the plug does not fit into the outlet, try turning it around. If the plug still does not fit, the outlet is probably non-standard and must be replaced by a qualified electrician. Do not tamper with the plug or try to force it into a non-standard outlet.

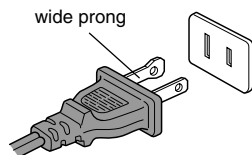

Note to CATV system installers in the USA

This reminder is provided to call the CATV system installer's attention to Article 820-40 of the NEC, which provides guidelines for proper grounding, and, in particular, specifies that the cable ground shall be connected to the grounding system of the building, as close to the point of cable entry as practical.

Precautions

Installing your TV

- Place the TV on the floor or on a sturdy platform. The mounting surface should be flat and steady. If you install the TV on a soft floor, make sure that the floor is not damaged by the weight of the TV.
- Place the TV far enough away from the walls to allow proper ventilation. This will prevent the TV from overheating and avoid possible damage to the TV. Avoid dusty places too.
- Damage may occur if you leave the TV in direct sunlight or near a heater. Avoid places subject to extremely high temperatures or humidity, and temperatures of 41°F(5°C) or lower.

Using your TV

- Do not stand or climb on the TV.
- Do not put any heavy object on top of the TV.
- Do not place containers with liquids such as drinks or cosmetics on the TV. If any foreign material or water leaks into the TV, unplug the AC cord and contact your dealer.
- If the room temperature suddenly rises, condensation may occur on the lenses resulting in picture distortion or color fading. In such a case, simply wait a while (with the power on) and the condensation will evaporate.
- Avoid displaying stationary images on your TV screen for extended periods of time. Stationary patterns generated by a picture-in-picture (PIP) display, Multi-Window display, computer displays, video games, stock market reports, etc., can become permanently engrained on the picture tube. This damage is not protected by your warranty because it is the result of misuse. If you wish to use your TV to display still images, reduce brightness and contrast settings. Never leave a PIP, Multi-Window, computer, or video game display unattended.
- Sit approximately 10-25 feet away from the TV. Sitting too far to the left or right of the screen will cause the picture to appear dull as will direct sunlight and room lights. Turn the TV off to check for reflections on the screen. Then remove the source of any reflections while viewing.

Cleaning your TV

- Clean the TV with a soft dry cloth. Never use strong solvents such as thinner or benzine which might damage the finish of the cabinet. If the cabinet is very dirty. Use a damp cloth to wipe the cabinet clean, then finish with or dry cloth.

Introduction	4	Using the preview function	26
Welcome to Toshiba	4	Using the favorite function	26
Exploring your new TV	4	Using the strobe function	26
Connecting your TV	5	Using V-CHIP control	27
Connecting a VCR	5	Selecting the V-CHIP menu	27
Connecting a cable converter box	6	Adjusting the V-CHIP menu	28
Connecting a cable converter box and a VCR	6	ENABLE BLOCKING	28
Connecting a DVD/satellite receiver and a VCR	7	SET RATING (Setting the movie or TV ratings for your choice)	28
Connecting a DVD with ColorStream™ and a VCR	7	About Rating	28
Connecting two VCRs	8	BLOCKING OPTION	29
Connecting a camcorder	9	NEW PIN CODE	29
Connecting an audio system	9	Unblocking programs temporarily	30
Connecting an A/V receiver	10	Blocking Channels	30
Using the remote control	11	Adjusting the picture	32
Preparing the remote control for use	11	Adjusting the picture quality	32
Installing the remote control batteries	11	Selecting the color temperature	32
Using the remote control with a VCR or a cable TV converter	11	Adjusting the picture preferences	33
Programming the remote control for use with a VCR or a cable TV converter	12	Using the flesh tone feature	33
VCR code table	13	Using the noise reduction feature	33
Cable TV converter code table	14	Resetting your adjustments to the factory settings ...	34
Learning about the remote control	15	Watching video input	34
Setting up your TV	16	Displaying on-screen information	34
Changing the on-screen display language	17	Auto power off	35
Selecting the antenna input	17	Displaying XDS information	35
Using the ANT/ VIDEO button	17	Using the closed caption feature	36
Adding channels to the TV's memory	18	Setting the off-timer	37
Programming channels automatically	18	Setting the clock	37
Adding and erasing channels manually	19	Adjusting the sound	38
Changing channels	19	Muting the sound	38
Adjusting the color convergence	19	Selecting stereo/SAP broadcasts	38
Using the TV's features	21	Adjusting the sound quality	39
Adjusting the channel settings	21	Using the surround sound feature	39
Switching between two channels	21	Using the Sub-Bass System (SBS)	40
Programming your favorite channels	21	Turning off the built-in speakers	40
Labeling channels	22	Viewing the demonstration mode	41
Watching picture-in-picture (PIP)	24	Understanding the last mode memory feature	41
Switching the main and small pictures	25	Appendix	42
Changing the position of the small picture	25	Specifications	42
Freezing the small picture	25	Troubleshooting	43
Using Multi-Window feature	25	Limited United States Warranty	44
		Index	45

Introduction

Welcome to Toshiba

Congratulations! You have purchased one of the finest projection TV's on the market. The goal of this manual is to guide you through setting up and operating your Toshiba TV as quickly as possible.

This manual applies to models TZ50V61, TZ55V61 and TZ61V61. Before you start reading, check your model number by looking at the rear of the TV.

The TZ50V61 is the model used for illustration purposes. Instructions in this manual are based on using the remote control. You can also use the controls on the TV if they have the same name as those on the remote control.

Please read all the safety and operating instructions carefully, and keep the manual for future reference.

Exploring your new TV

You can operate your TV by using the buttons on the front panel or the remote control. The back panel and front panel (behind the door) provide all the terminal connections you will need to connect other equipment to your TV.

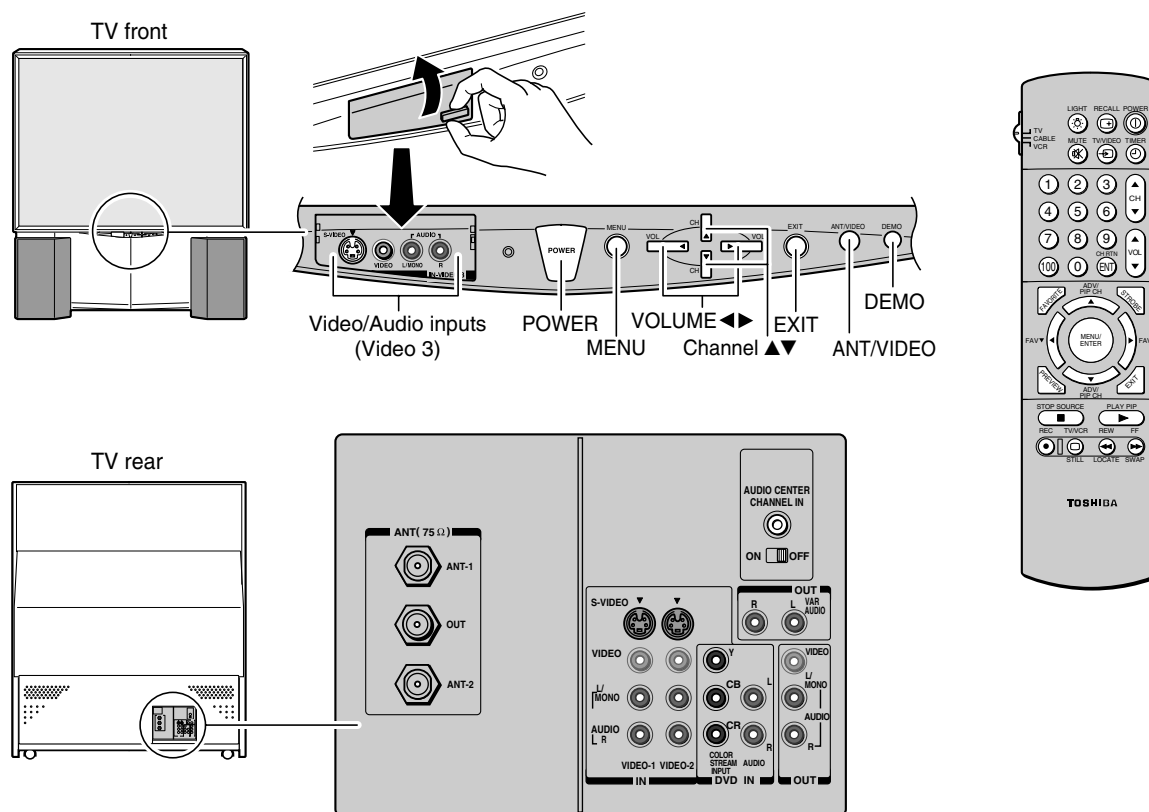

Connecting your TV

If you haven't connected electronic equipment before, or you have been frustrated in the past, you may wish to read this section. (Cables are not supplied.)

- A coaxial cable is the standard cable that comes in from your antenna or cable converter box. Coaxial cables use "F" connectors.
- Audio and video cables are usually color coded according to use: yellow for video and red and white for audio. The red audio cable is for the stereo right channel, and the white audio cable is for the stereo (or mono) left channel. If you look at the rear panel of the TV, you will see that the terminals are color coded in the same manner as the cables.
- S-video cables provide better picture performance. S-video cables can only be used with S-video compatible components.
- ColorStream™ cables come in sets of three and provide the best picture performance. ColorStream cables can only be used with ColorStream compatible components.

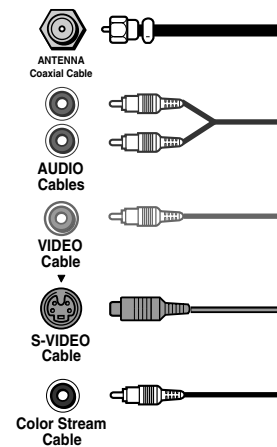

Caution:

Do not plug the TV in until you have finished connecting all of your equipment.

Connecting a VCR

This connection allows you to watch local channels and video programs, play or record on the VCR while watching TV, and to record from one channel while watching another channel.

You will need:

- one coaxial cable
- one pair of audio cables (only one cable for a mono VCR)
- one video cable

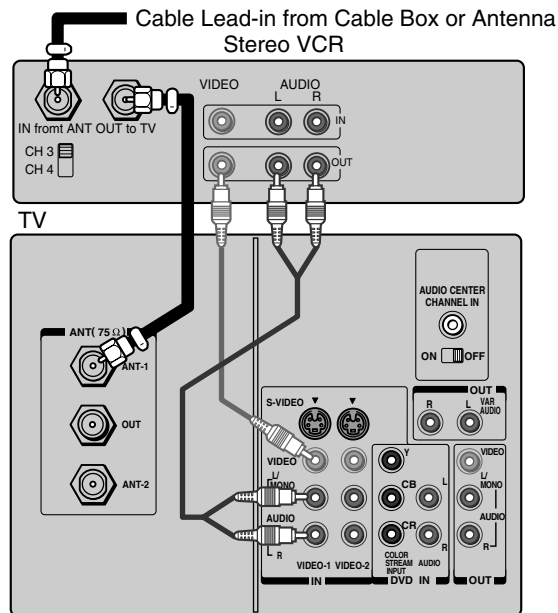

Caution:

If using a mono VCR, connect L/Mono to VCR Audio OUT using only one audio cable.

If you have a S-VHS VCR, use the S-video connections and remove the video cable.

Do not connect the video cable and the S-video cable to Video-1 simultaneously.

Connecting a cable converter box

This connection allows you to watch cable and premium channels. You should keep your TV selected to ANT-1 so that you can use the TV features. When viewing premium channels, select ANT-2 and tune the TV to channel 3 or 4 (whichever channel is vacant in your area), then use the converter box to change channels. You will need two coaxial cables.

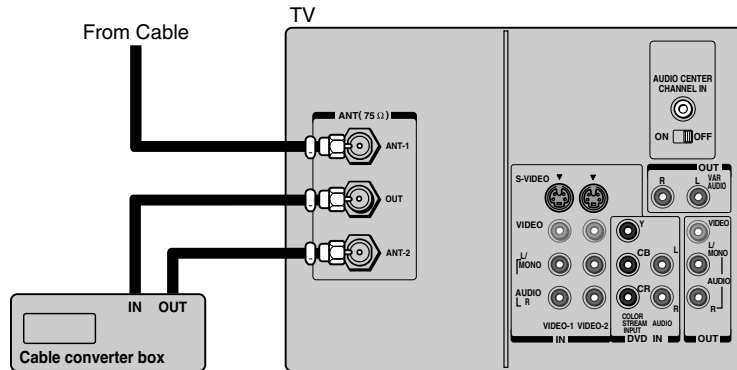

Note:

When you use a converter box with your TV, there may be features that you can not program using the remote control, such as programming your favorite channels, labeling channels, and blocking channels.

Connecting a cable converter box and a VCR

This connection allows you to watch and record basic and premium cable channels, as well as watch videotapes. You should keep your TV selected to ANT-1 so that you can use the TV's features. When viewing premium channels or recording with the VCR, select ANT-2 and change the TV channel to 3 or 4 (whichever channel is vacant in your area), then use the converter box to change channels. You will need:

- three coaxial cables
- one pair of audio cables (only one cable for a mono VCR)
- one video cable

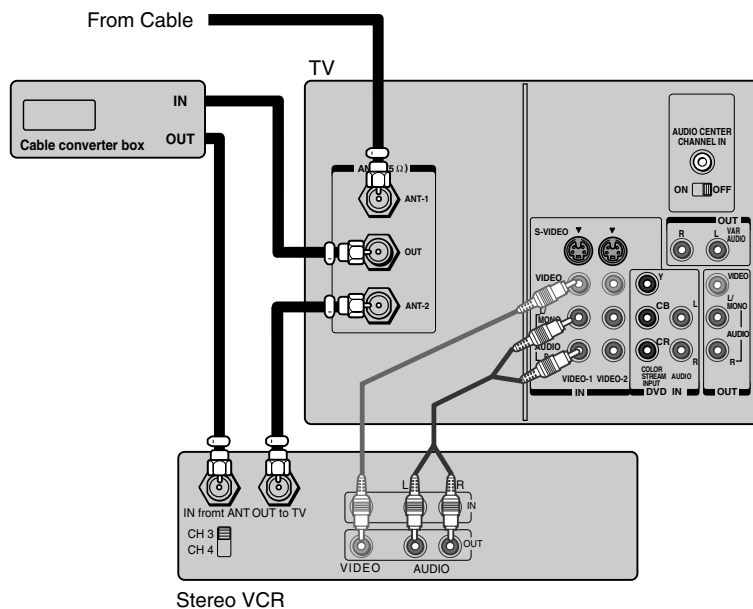

Caution:

If you want to record one channel while watching another channel, a splitter (not included) must be added between the cable and ANT-1. One output of the splitter goes to ANT-1 and the second output is connected to IN on the cable converter box.

If you have a mono VCR, connect L/Mono to VCR Audio OUT using only one audio cable.

If you have a S-VHS VCR, use the S-video connections and remove the video cable. Do not connect the video cable and the S-video cable to Video-1 simultaneously.

When you use a converter box with your TV, there may be features that you can not program using the remote control, such as programming your favorite channels labeling channels, and blocking channels.

Connecting a DVD/satellite receiver and a VCR

This connection allows you to watch DVD/satellite, video and TV programs. You can record one TV channel while watching another channel.

You will need:

- one coaxial cable
- two pairs of audio cables (only one cable for a mono VCR)
- one video cable
- one S-video cable

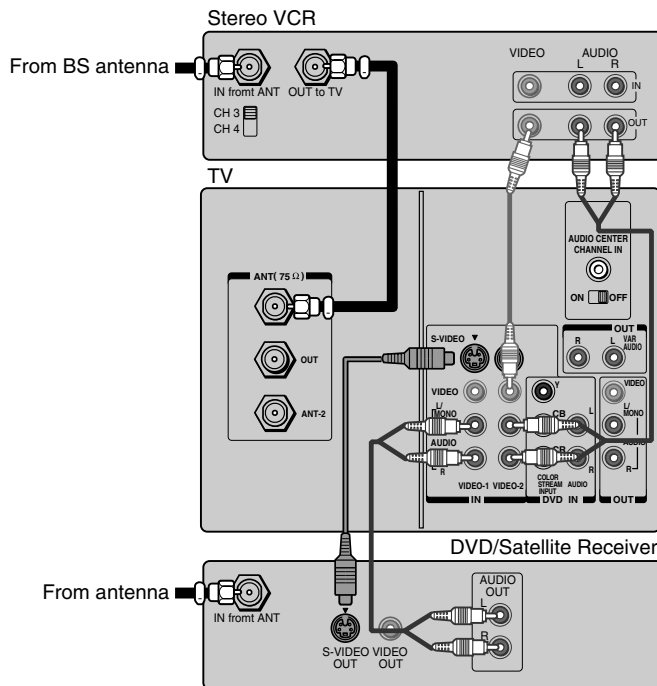

Caution:

You can use a video cable instead of the S-video cable, but the picture quality will decrease. If you use a S-video cable between the TV and DVD/satellite receiver, make the audio connections only and remove the video connection.

Do not connect the video cable and the S-video cable to Video-1 Simultaneously.

The unauthorized recording of television programs, video tapes and other materials may infringe upon the provisions of copyright laws.

Connecting a DVD with ColorStream™ and a VCR

This connection allows you to watch DVD, video or TV programs and to record DVD or TV programs. You can record from one source and watch a program from another source. Your TV is capable of using ColorStream (component video). Connecting your TV to a ColorStream compatible DVD, such as a Toshiba DVD, can greatly enhance picture quality and performance.

You will need:

- one coaxial cable
- three pairs of audio cables (only one cable for a mono VCR)
- two video cables
- one set of ColorStream video cables

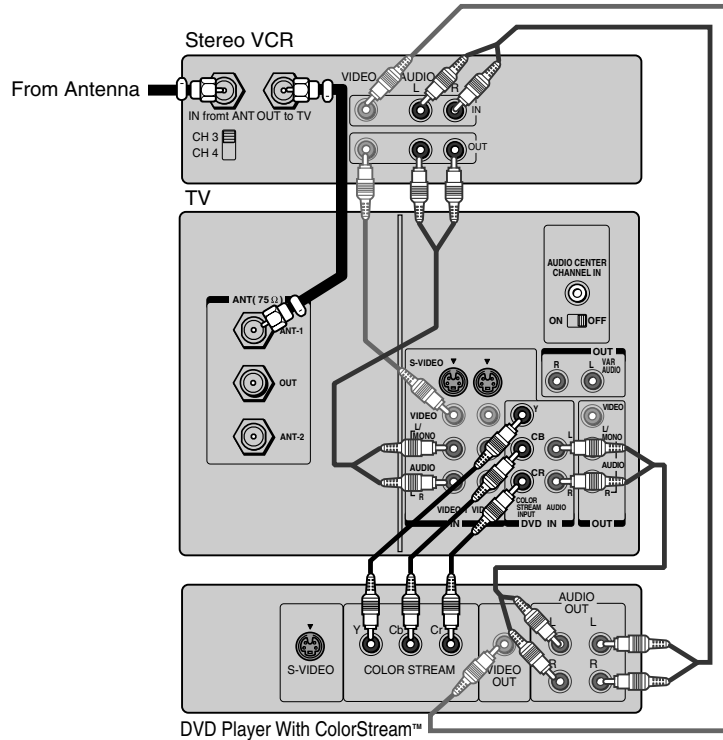

Caution:

To play from the DVD, the DVD and TV must use ColorStream connections. To record from the DVD, the DVD and TV must select Video.

The unauthorized recording of television programs, video tapes and other materials may infringe upon the provisions of copyright laws.

Connecting two VCRs

This connection allows you to record (dub/edit) from one VCR to another VCR while watching a video program. You will also be able to record from one TV channel while watching another channel.

You will need:

- one coaxial cable
- two pairs of audio cables (only two cables for mono VCRs)
- two video cables

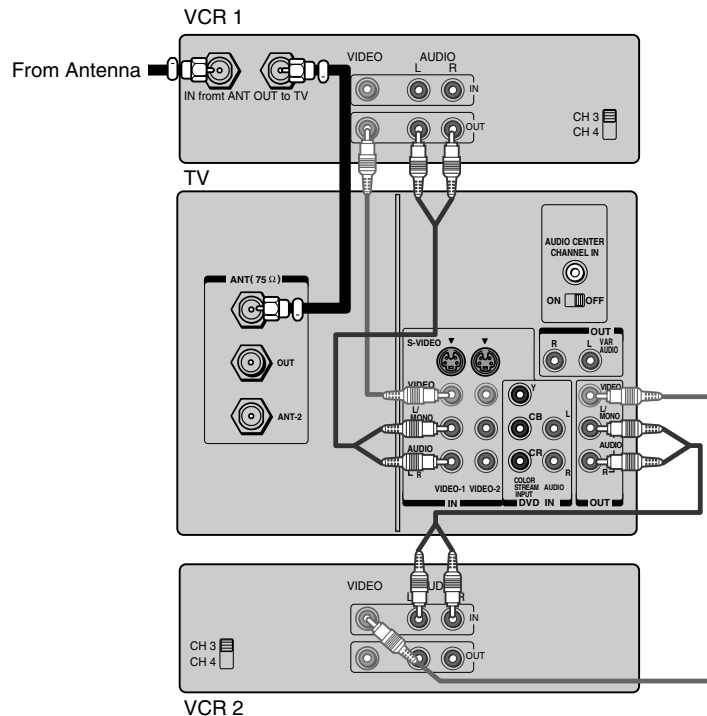

Caution:

Do not connect one VCR to the output and input jacks on the TV at the same time. If you are using a S-VHS VCR, use the S-video connections and remove the video cable. Do not connect the video cable and the S-video cable to Video-1 simultaneously.

The unauthorized recording of television programs, video tapes and other materials may infringe upon the provisions of copyright laws.

Note:

To monitor dubbing/editing, the VCR 2 for recording must select Line IN, and the TV must select Video-1.

Connecting a camcorder

This connection allows you to watch video materials recorded on a camcorder.

You will need:

- one pair of audio cables
- one video cable

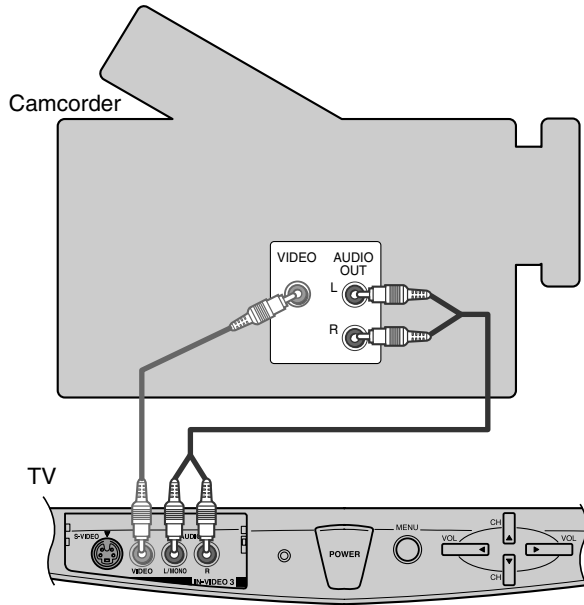

Caution:

If you are using a S-VHS camcorder with a S-video output, connect this to the S-video input on the TV and remove the video cable.

Do not connect the video cable and the S-video cable to Video-3 simultaneously.

Connecting an audio system

This connection allows you to use an audio amplifier to adjust the audio level. This also allows you to use external speakers.

To control the audio, turn on the TV and the stereo amplifier, then turn off the built-in speakers. (See “Turning off the built-in speakers” on page 40.)

You will need one pair of audio cables.

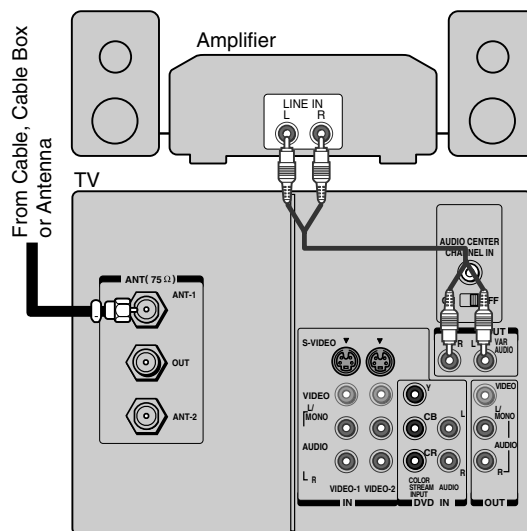

Connecting an A/V receiver

If you use a system that delivers Dolby Pro Logic* surround sound, you will probably want to use the TV speakers as center channel speakers.

A center channel speaker adds to the realism of a surround sound system such as Dolby Pro Logic.

You will need:

- one pair of audio cables
- one video cable
- one audio cable for audio center channel

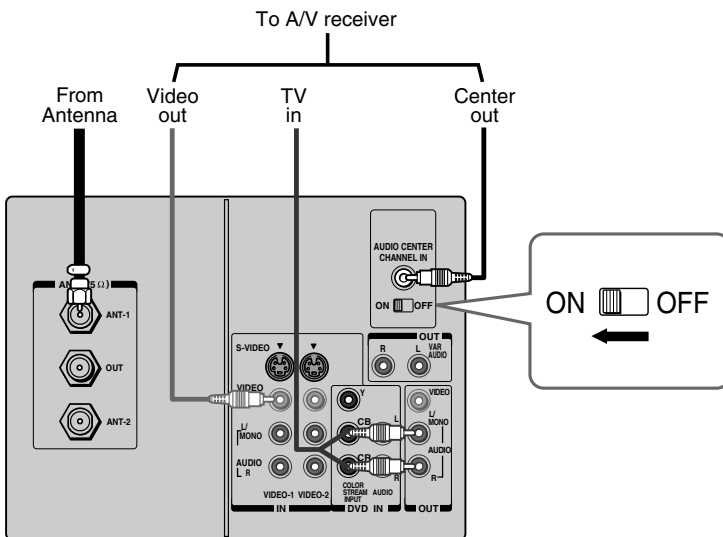

Caution:

Make sure the TV is turned off before connecting or disconnecting an audio cable to the Audio Center Channel IN jack. The speaker may be damaged.

Note:

Refer to the instructions furnished with the connected A/V receiver for detailed surround system.

When the Audio Center Channel ON/OFF switch is in the "ON" position, the TV speakers will function only as the center channel speakers.

Adjust the volume for center channel speakers with the center level control on the A/V receiver.

If you use the TV speakers as normal speakers, set the Audio Center Channel ON/OFF switch to the "OFF" position.

* "Dolby Pro Logic" is a trademark of Dolby Laboratories Licensing Corporation.

Connection example of Dolby Pro Logic surround system

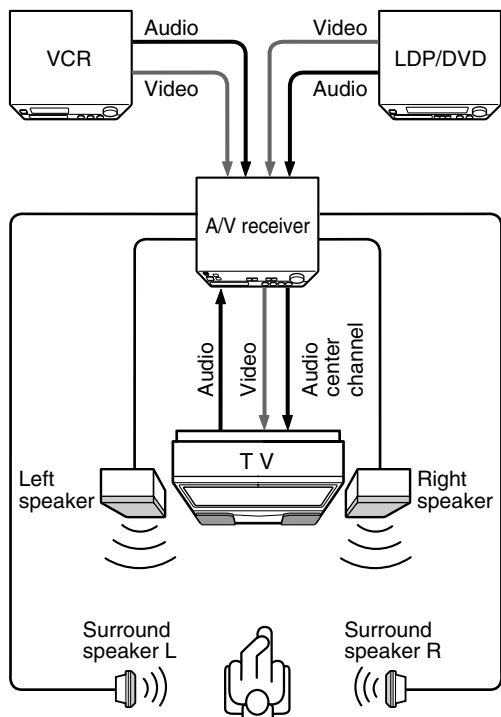

Using the remote control

Preparing the remote control for use

With the remote control, you can operate your TV, most VCR models, and cable TV converters together, even if they are different brands. If you will be using your TV with a Toshiba VCR, your remote control is already programmed and ready to use. If you own different brands of VCRs and/or converters, you first have to program your remote control. (See "Programming the remote control for use with a VCR or a cable TV converter" on page 12.)

Installing the remote control batteries

To install the batteries:

1. Slide the battery cover off of the back of the remote control.

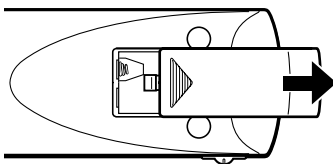

2. Install two "AA" size alkaline batteries. Match the + and - signs on the batteries to the signs on the battery compartment.

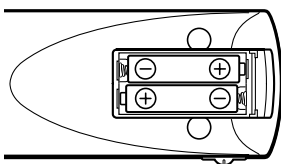

3. Slide the battery cover back on to the remote control until the lock snaps.

Using the remote control with a VCR or a cable TV converter

To control a Toshiba VCR:

Set the TV/CABLE/VCR switch to the VCR position. The buttons shown to the right will then control the VCR. The rest of the buttons will operate the TV as usual.

Note:

This remote control's functions may or may not operate your VCR or cable TV converter.

Refer to the owner's manuals supplied with the equipment to see which features are available. In addition, the original controllers may have features not available on this remote control. If you would like to continue to use these features, you may want to use the original remote control.

Caution:

- Dispose of your batteries in a designated disposal area. Do not throw your batteries into a fire.
- Do not mix battery types or combine used batteries with new ones.
- Remove dead batteries immediately to prevent battery acid from leaking into the battery compartment.
- If you do not intend to use the remote control for a long time, remove the batteries.

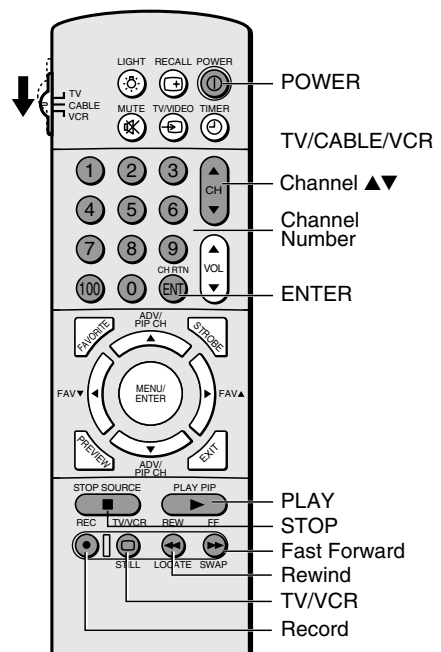

To control a cable TV converter:

Program the remote control to recognize the brand of your converter (see “Programming the remote control for use with a VCR or cable TV converter,” below). The shaded buttons shown on the right will control the cable TV converter.

Set the TV/CABLE/VCR switch to the CABLE position.

Programming the remote control for use with a VCR or a cable TV converter

This remote control is pre-programmed to operate Toshiba VCRs. To use VCRs or cable converters other than Toshiba models, you must follow the steps below before you operate your remote control.

1. Refer to the “VCR code table” or “Cable TV converter code table” on pages 13-14 to find the number that corresponds to the brand name of your VCR or converter.

If more than one number is listed, try each one separately until you find the one that works.

2. If you are reprogramming the remote control to operate your:
 - **VCR**, set the TV/CABLE/VCR switch on the remote control to VCR.
 - **cable converter**, set the TV/CABLE/VCR switch on the remote control to CABLE.

3. Hold down the RECALL button while using the Channel Number buttons to enter the three-digit code number of your brand of VCR or converter.

4. Point the remote control at the VCR or converter and press POWER to test the code number.

If the VCR or converter turns on, you have entered the right number.

If the VCR or converter does not respond to the remote control, you may have entered the wrong number. Repeat steps 1-4 with another code number.

5. Reset the TV/CABLE/VCR switch to TV to control the TV.

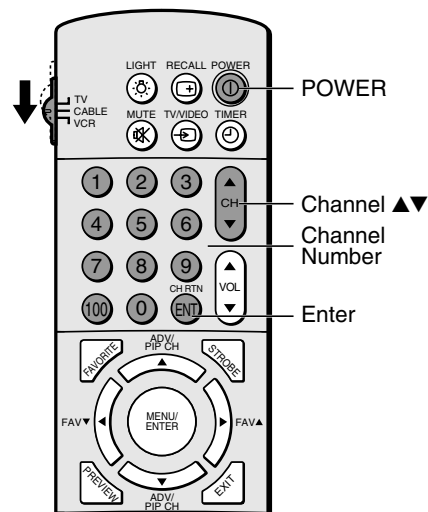

Note:

- Each time you replace the batteries, you must reprogram the remote control.
- Some newer VCRs are capable of working on either of two remote codes. These VCRs have a switch labeled “VCR1/VCR2.”

If your VCR has this kind of switch, it may not respond to any of the code numbers for your VCR brand name. In this case, set the switch to the other position (VCR1 or VCR2) and reprogram the remote control.

For future reference, write down the code numbers you used:

VCR code _____

Cable code _____

VCR code table

Brand name	Code number				
Adventura	019	Jensen	060	Quasar	054,096
Aiko	297	JVC	027,060,086	Radio Shack	019,056,344
Aiwa	019	Kenwood	057,060,086	Radix	056
Akai	060,068,080,125, 261	KLH	091	Randex	056
American High	054	Kodak	054,056	RCA	061,079,084,096, 124,125,168,221
Asha	259	Lloyd	019	Realistic	019,054,056,065, 066,067,081,085, 123,259
Audiovox	056	Lloyd's	227	Ricoh	053
Beaumont	259	Logik	091	Runco	058
Bell & Howell	123	LXI	056	Samsung	064,259
Brandt	206	Magnavox	054,058,100,129, 168	Sanky	058,067
Broksonic	140,203,230,314, 380	Magnin	259	Sansui	060,086
Calix	056	Marantz	054,100	Sanyo	065,066,123,259
Canon	054	Marta	056	Scott	062,064,140,203, 229,230,231
Capehart	039	Masushita	054	Sears	054,056,061,065, 066,073,085,123, 124
Carver	100	MEI	054	Sharp	067,081
CCE	091,297	Memorex	019,054,056,058, 065,066,067,123, 259	Shintom	091
Citizen	056,297	MGA	062,080	Shogun	259
Colt	091	MGN Technology	259	Singer	091
Craig	056,066,091,259	Minolta	061,124	Sony	051,052,053,054
Curtis Mathes	054,060,079	Mitsubishi	062,080,086,094, 192,233,261	STS	061
Cybernex	259	Motorola	054,067	Sylvania	019,054,062,100, 129
Daewoo	039,064,297	MTC	019,259	Symphonic	019,344
Daytron	039	Multitech	019,091	Tatung	060
Dynatech	019	Nad	077	Teac	019,060
Electrohome	056	NEC	057,059,060,069, 086	Technics	054,181
Electroponic	056	Nikko	056	Teknika	019,054,056,071
Emerex	051	Noblex	259	Telefunken	060,206
Emerson	019,021,056,062, 080,087,140,203, 227,228,230,231, 297,313,314,380, 498	Olympus	054	TMK	227,259
Fisher	066,073,085,123	Optimus	056,067,077,123	Toshiba	062,064,085,229, 231,385
Fuji	052,054	Optonica	081	Totevision	056,259
Funai	019,344	Orion	498	Unitech	259
Garrard	019,344	Panasonic	054,096,181,244	Vector	064
GE	054,079,084,221	Penney	054,056,057,059, 061,073,259	Vector Research	057,059
Go Video	251,298	Pentax	061,084,124	Video Concepts	059,064,080
Goldstar	037,056,057	Philco	054	Videosonic	259
Gradiente	019	Philips	054,081,100,129	Wards	019,054,061,066, 067,081,091,168, 231,259
Harley Davidson	019	Pilot	056	XR-1000	019,054,091
Harman/Kardon	057,094	Pioneer	077,086	Yamaha	057
Harwood	087,091	Portland	039	Zenith	052,053,058
Headquarter	065	Protec	091		
HI-Q	066	Pulsar	058		
Hitachi	060,061,084,124, 254	Quarter	065		
		Quartz	065		

Cable TV converter code table

Brand name	Code number		
ABC	020,022,026,027, 030,032,033,036, 066	Samsung	059,163
Antronix	041	Scientific Atlanta	025,027,036,296
Archer	041,058,172	Signal	034,059
Belcor	075	Signature	030
Cable Star	075	SL Marx	059
Cabletenna	041	Sprucer	040
Cableview	041	Standard	
Century	172	Components	174
Citizen	172	Starcom	022,034,066
Colour Voice	044,050	Stargate	034,059
Comtronics	059,079	Starquest	034
Contec	038	Sylvania	020
Dae Ryung	027	Teleview	059
Eastern	021	Texscan	020
Focus	419	Tocom	031,032,078
Garrard	172	Toshiba	019
GC Electronics	035,075	Tusa	034
Gemini	034,089	Unika	041,172
General Instrument	030,295	United Artists	026
GoldStar	059,163	United Cable	022
Hamlin	028,039,053,278, 292	Universal	041,058,075,096, 172,210
Hitachi	030	Viewstar	046,079,230
Hytex	026	Zenith	019
Jasco	172	Zentek	419
Jerrold	022,030,031,033, 034,043,066,295		
Macom	052		
Magnavox	046		
Memorex	019		
Movie Time	175		
NSC	089,175		
Oak	026,038,267		
Panasonic	019,040,126		
Paragon	019		
Philips	044,046,047,048, 049,050,172		
Pioneer	042,163,552		
Popular Mechanics	419		
Pulsar	019		
RCA	040		
Recoton	419		
Regal	039,278,292		
Regency	021		
Rembrandt	030,089		
Runco	019		

Learning about the remote control

POWER turns the TV on and off (pages 12 and 37)

TIMER sets the TV to go off at a set time (page 37)

TV/VIDEO selects video input source (page 34)

Channel ▲ ▼ cycles through programmed channels (page 19)

TV/CABLE/VCR switches between TV, Cable and VCR (page 12)

Channel Numbers allow direct access to channels (page 19)

VOLUME ▲ ▼ adjusts the volume level

CH RTN returns to the last viewed channel (page 21)

MENU allows access to programming menus (page 16)

ENTER sets programmed menu information (pages 16, 20-23)

▲ ▼ ◀ ▶ selects or adjusts programming menus (page 16)

PIP Channel ▲ ▼ cycles through PIP channels (page 24)

FAV ▼ ▲ cycles through favorite channels (page 21)

EXIT exits programming menus (page 16)

PIP Functions allow access to PIP functions (pages 24, 25)

VCR Functions allow access to VCR functions (page 11)

STOP press to stop a videotape

REC press to start recording a videotape

PLAY press to play a videotape

FF press to fast forward a videotape

REW press to rewind a videotape

TV/VCR toggles between TV and VCR
when viewing while recording

PREVIEW allows access to Multi-Window function (page 26)

FAVORITE allows access to Multi-Window function (page 26)

STROBE allows access to Multi-Window function (page 26)

MUTE mutes the sound (page 38)

LIGHT press to back-light buttons for five seconds

RECALL displays screen information (page 34)

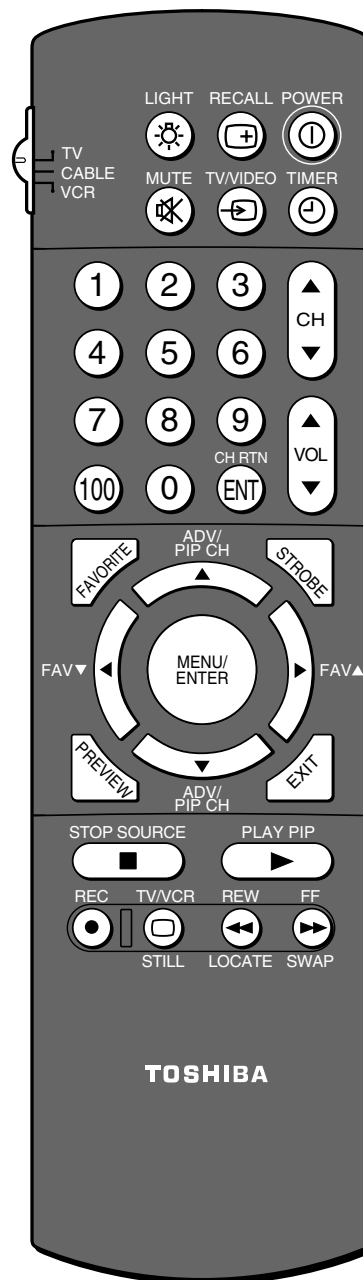

Setting up your TV

After you've installed the batteries and programmed the remote control, you need to set some preferences on the TV using the menu. You can access the menu with the buttons on your TV or by using the remote control.

1. Press MENU to display menu.
2. Press ◀ or ▶ to select menu.
3. Press ▲ or ▼ select an item.
4. Press ◀ or ▶ to select or adjust a setting.

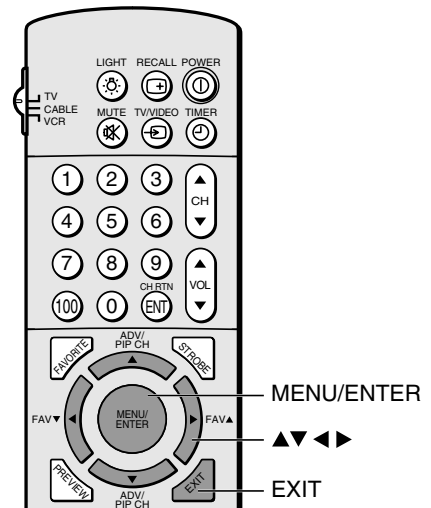
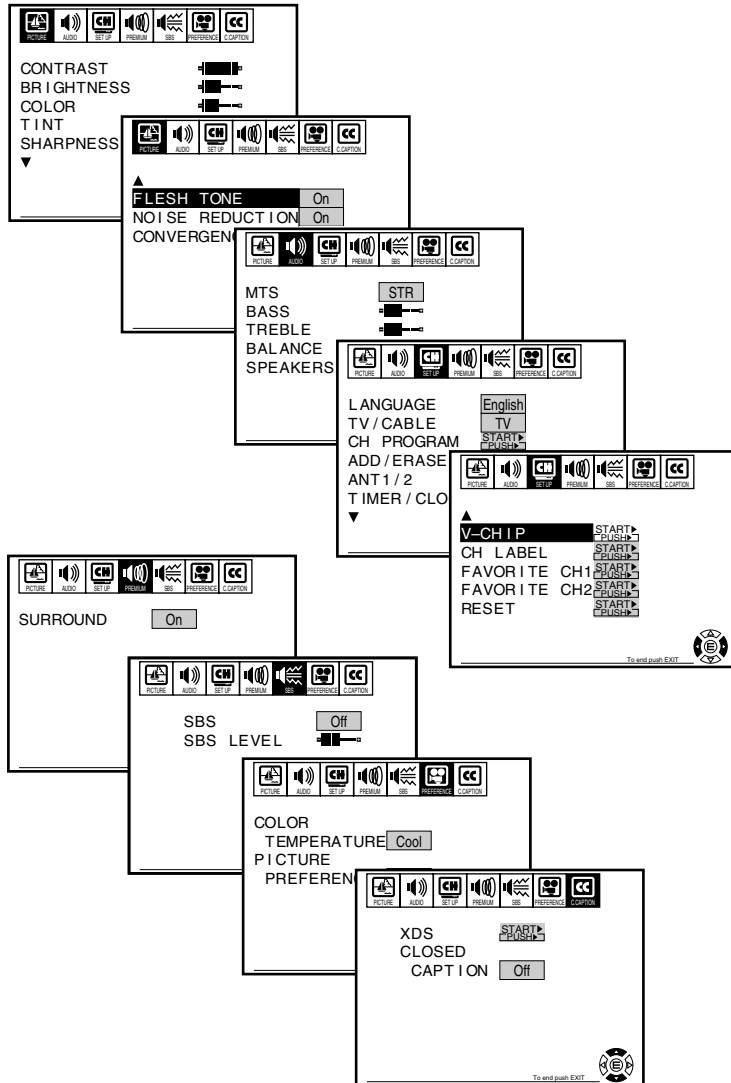
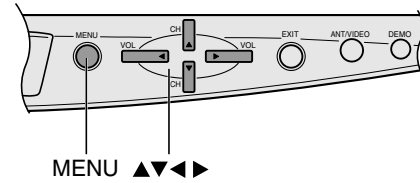

- Use the ENTER button to activate the function settings in the SET UP menu.
- The main menu display will disappear automatically if you do not make a selection within 15 seconds, and the other displays will disappear within 6 seconds.
- If you want to close all the on-screen displays instantly, press EXIT.

Changing the on-screen display language

You can choose from three different languages (English, French and Spanish) for the on-screen displays. Adjustment menus and messages will appear in the language of your choice.

To select a language:

1. Press MENU, then press ◀ or ▶ until the SET UP menu appears.
2. Press ▲ or ▼ to highlight LANGUAGE.

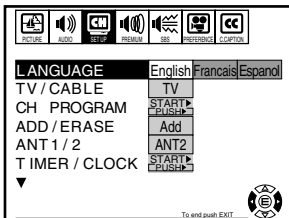

3. Press ◀ or ▶ to highlight your desired language.

Selecting the antenna input

You can connect to two different signal sources by choosing the antenna input (ANT 1 or ANT 2).

To select the antenna input:

1. Press MENU, then use ◀ or ▶ to highlight the SET UP menu.
2. Press ▲ or ▼ to highlight ANT 1/2.

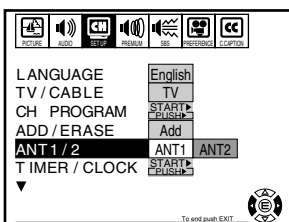

3. Press ◀ or ▶ to highlight either ANT 1 or ANT 2, depending on the antenna terminal you wish to use.

Using the ANT/ VIDEO button

You can monitor or change the signal source that is connected to the TV. By pressing the ANT/VIDEO button on your TV, you can select the VIDEO 1, VIDEO 2, VIDEO 3, ColorStream, ANT 1 or ANT 2 mode. The signal source you are currently connected to will be displayed in purple.

To select the antenna input:

1. Press the ANT/VIDEO button. The signal source you are connected to is displayed in purple.

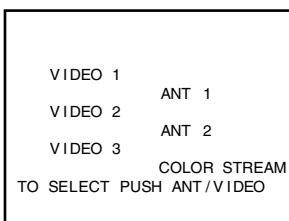

2. Press the button until ANT 1 or ANT 2 is displayed in purple, indicating the antenna terminal you wish to use.

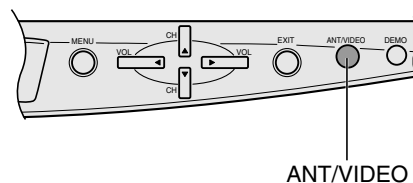
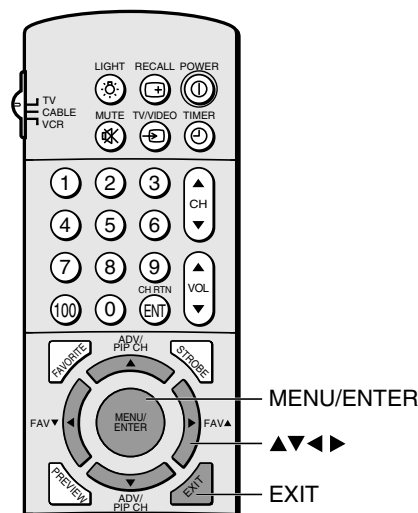
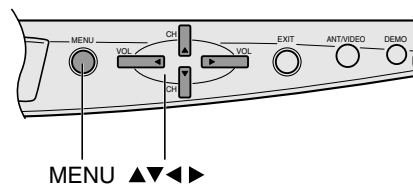

Adding channels to the TV's memory

Your TV will stop on specific channels that are stored in the TV's channel memory when you press Channel ▲ or ▼. Use the steps below to set all active channels in your area automatically.

Programming channels automatically

Your TV can automatically detect all active channels and store them in its memory. After the TV has stored the channels in its memory, you can erase channels or add your favorite channels. If you use both ANT-1 and ANT-2 terminals, you must program channels for each input source.

To add channels:

1. Press MENU, then press ◀ or ▶ until the SET UP menu appears.
2. Press ▲ or ▼ until the TV/CABLE is highlighted.
3. Press ◀ or ▶ to highlight either TV or CABLE, depending on which you use.

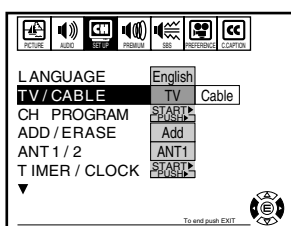

If you use an antenna, choose TV.

If you use cable, choose CABLE.

4. Press ▼ to select CH PROGRAM.
5. Press ◀ or ▶ to start channel programming. The TV will automatically cycle through all the TV or Cable channels (depending on which you selected), and store all active channels in the channel memory.

While the TV is cycling through the channels, the message "Programming Now Please Wait" appears.

6. When channel programming is complete, the message "Completed (channel or cable number)" appears.
7. Press Channel ▲ or ▼ to view the programmed channels.

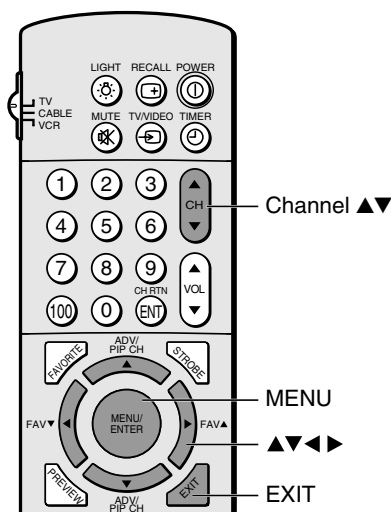

Adding and erasing channels manually

After you've programmed the channels, you can add or erase specific channels.

To add or erase channels:

1. Select the channel you want to add or erase using Channel ▲ or ▼. If adding channels, you must select the channel to add by using the Channel Number buttons.
2. Press MENU, then press ◀ or ▶ until the SET UP menu appears.
3. Press ▲ or ▼ to highlight ADD/ERASE.

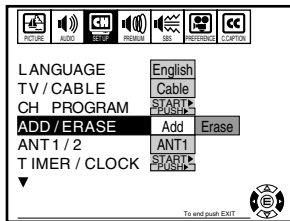

4. Press ◀ or ▶ to select Add or Erase, whichever function you want to perform.
5. Repeat steps 1-4 for other channels you want to add or erase.

Changing channels

To change the channel, you can:

- change the programmed channels using the remote control
- select a channel directly using the remote control
- scan the channels using the TV buttons

To change to the next programmed channel:

Press Channel ▲ or ▼ on the TV or remote control.

To change to a specific channel (programmed or unprogrammed):

Press the Channel Number buttons (0-9 and 100).

For example, to select channel 125, press the 100 button, the 2 button, and the 5 button.

Adjusting the color convergence

This projection TV uses three separate TV tubes: a red one, a green one, and a blue one. The red, green, and blue images are projected onto the screen where they converge to form a full color picture. You can see a clear picture only when they converge correctly.

Convergence may drift over time or if you move the TV. If you can see clear images on the screen, skip this procedure.

This adjustment should be made after the TV has been on for at least 30 minutes.

To check and adjust the color convergence:

1. Press MENU, then press ◀ or ▶ until the PICTURE menu appears.
2. Press ▲ or ▼ to highlight CONVERGENCE.
3. Press ◀ or ▶ to display the center CONVERGENCE menu.

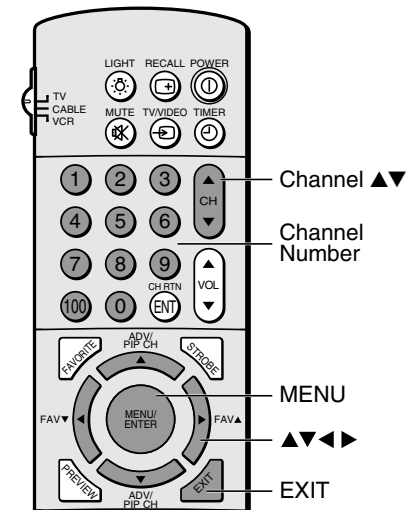
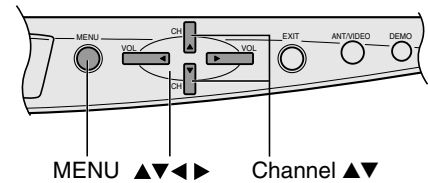

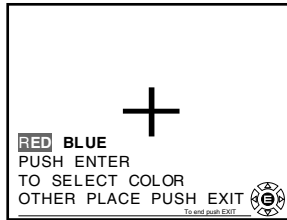
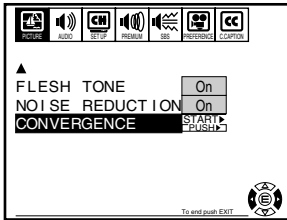

If you see separate colored lines, you have to adjust the convergence.

4. Press ENTER to highlight RED or BLUE.

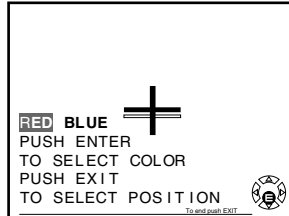
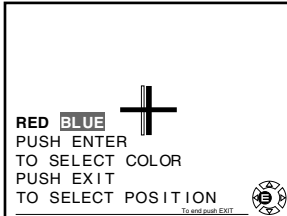

5. Press ▲ (up), ▼ (down), ◀ (left), or ▶ (right) to converge the red or blue line into the green line. When color convergence is correctly adjusted, you will see two single white lines.
6. Press EXIT to display the circumference CONVERGENCE menu.
7. Press the corresponding Number button (1-9) to select the place you want to adjust.

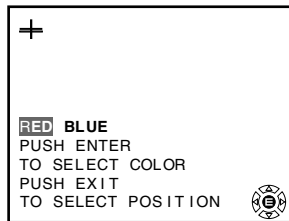
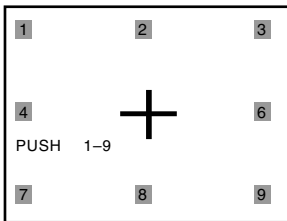

8. Press ENTER to highlight RED or BLUE.
9. Press ▲▼◀▶ to converge the red or blue line into the green line. Repeat steps 8 and 9 until you see two single white lines.
10. Press EXIT once to select any other place you want to adjust, then repeat steps 7 through 9.
11. Press EXIT twice to close the CONVERGENCE menu.

Using the TV's features

Adjusting the channel settings

Switching between two channels

You can switch between two channels without entering an actual channel number each time.

To switch between two channels:

1. Select the first channel you want to view.
2. Select a second channel with the Channel Number buttons (0-9, 100).
3. Press CH RTN. The previous channel will be displayed.

Each time you press CH RTN, the TV will switch back and forth between the two channels.

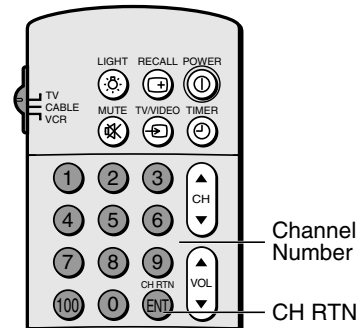

Programming your favorite channels

You can preset up to 9 of your favorite channels each for FAVORITE 1 and FAVORITE 2 modes using the Favorite Channel Programming feature. Because this feature scans through only your favorite channels, it allows you to skip other channels you do not normally watch.

You can still use Channel ▲▼ to scan through all the channels you programmed in the TV's memory.

To program your favorite channels:

1. Press MENU, then press ◀ or ▶ until the SET UP menu appears.
2. Press ▲ or ▼ to highlight FAVORITE CH1 or FAVORITE CH2.

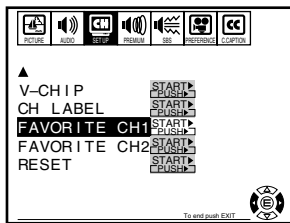
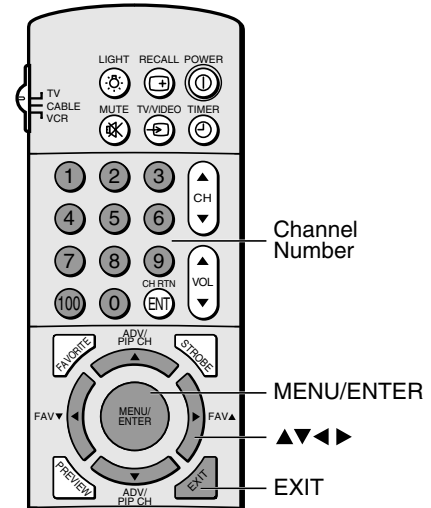

3. Press ◀ or ▶ to display the FAVORITE CH1 menu for example. SET/CLEAR will be highlighted.
4. Press ◀ or ▶ to highlight Set.

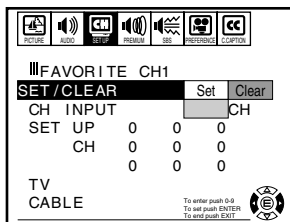

5. Press ▼ to highlight CH INPUT, then press the Channel Number buttons to enter the channel number.
6. Press ENTER.

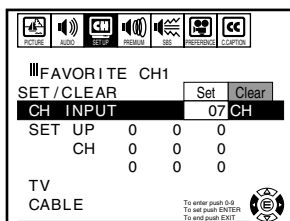

- Repeat steps 5 and 6 for other channels.

To select your favorite channels:

To scan your favorite channels in order one by one, press FAV ▼ or ▲ .

To scan your favorite channels with a 9-picture multi-window, press FAVORITE. (See page 26 for details.)

To clear your favorite channels:

- Press MENU, then press ◀ or ▶ until the SET UP menu appears.
- Press ▲ or ▼ to highlight FAVORITE CH2 for example.
- Press ◀ or ▶ to display the FAVORITE CH2 menu. SET/CLEAR will be highlighted.

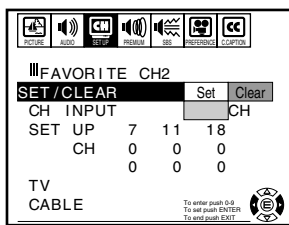

- Press ◀ or ▶ to highlight Clear, then press ENTER until “0” replaces the channel numbers you have programmed.

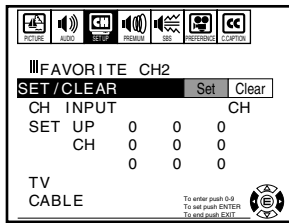

Labeling channels

Channel labels will appear over the channel number display each time you turn on the TV, select a channel, or press the RECALL button. You can choose any four characters to identify the channels.

To create channel labels:

- Press MENU, then press ◀ or ▶ until the SET UP menu appears.
- Press ▲ or ▼ to highlight CH LABEL.



- Press ◀ or ▶ to display the CH LABEL menu. SET/CLEAR will be highlighted.

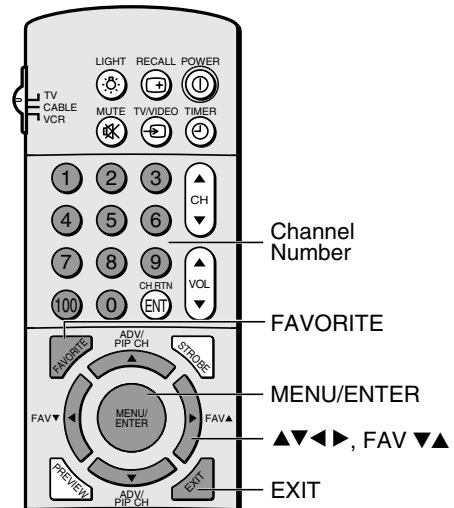

- Press ◀ or ▶ to highlight SET.

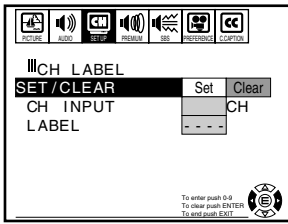

- Press ▼ to highlight CH INPUT, then select a channel you want to label.

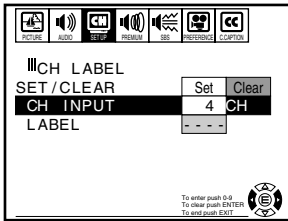

- Press ▼ to highlight LABEL.
- Assign the label to the channel. Press ◀ or ▶ to enter a character in the first space. Press the button repeatedly until the character you want appears on the screen. Press ENTER.

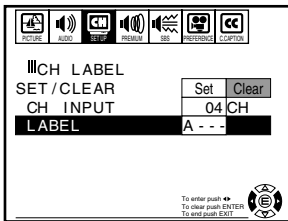

- Repeat step 7 to enter the rest of the characters.
If you would like a blank space in the label name, you must choose an empty space from the list of characters. Otherwise, a dash will appear in that space.
- Repeat steps 4 through 8 for other channels. You can assign up to 32 labels.

To erase channel labels:

- Press MENU, then press ◀ or ▶ until the SET UP menu appears.
- Press ▲ or ▼ to highlight CH LABEL.
- Press ◀ or ▶ to display the CH LABEL menu.
SET/CLEAR will be highlighted.
- Press ◀ or ▶ to highlight Clear.
- Press ▼ to highlight CH INPUT, then select the channel you want to clear with the Channel Number buttons.
- Press ENTER.
- Repeat steps 5 and 6 to erase other channel labels.

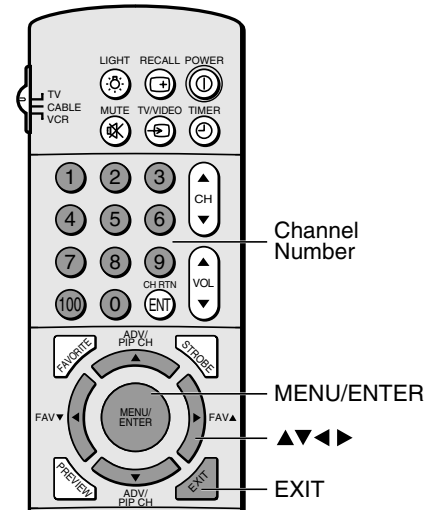

Watching picture-in-picture (PIP)

The picture-in-picture (PIP) feature allows you to watch two pictures at the same time. The smaller picture can be a TV broadcast or come from an external source, such as a VCR.

To display a TV broadcast as a small picture:

1. Turn on the TV and select the program you want to watch.
2. Press PIP once to display a small picture. A window 1/9 the size of the screen will appear. Press PIP a second time to display a 1/16 size window.

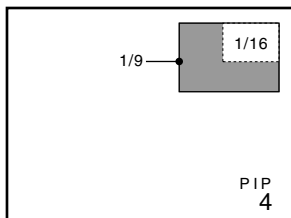

3. Press PIP CH ▲▼ to choose the program you want to be displayed as a small picture.

If the V-CHIP feature is active and you try to watch a TV program that exceeds the rating limits you set, the TV will enter into the program block mode. See “Using V-CHIP control” on page 27.

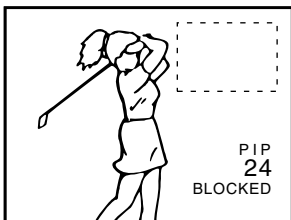

To display a picture from an external source as a small picture:

1. Make sure you have connected the external source equipment properly. For more information, see the “Connecting your TV” on page 5.
2. Turn on the TV and select the program you want to watch.
3. Press PIP once to display a small picture. A window 1/9 the size of the screen will appear. Press PIP a second time to display a 1/16 size window.
4. Press SOURCE repeatedly to select the input source (VIDEO 1, VIDEO 2 or VIDEO 3) for the small picture. The selected source will be displayed in purple. ColorStream can not be selected.

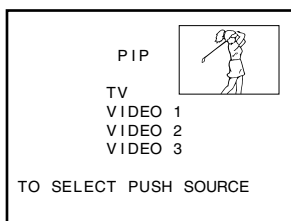

To turn PIP off:

Press PIP once or twice, depending on the size of the small picture screen you selected.

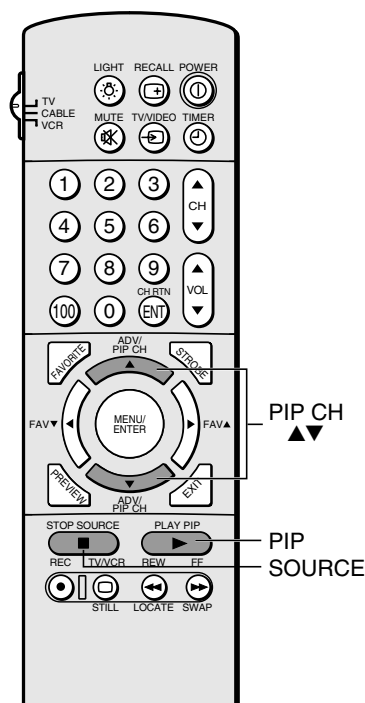

Note:

- PIP can not be turned on when the ColorStream input is being viewed.
- You can not display the signal sources input through the ANT-2 terminal as a small picture.

Switching the main and small pictures

Press SWAP while you are using the PIP feature to switch the main and small pictures. The main and small pictures will switch each time you press the SWAP button.

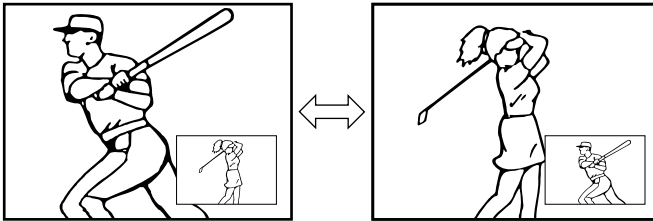

Changing the position of the small picture

Press LOCATE repeatedly while you are watching a small picture. The display position of the small picture will change in the following order:

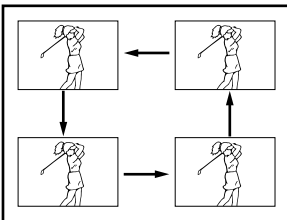

Freezing the small picture

Press STILL while you are watching a small picture. The small picture will become a still picture. To return to the moving picture, press STILL again.

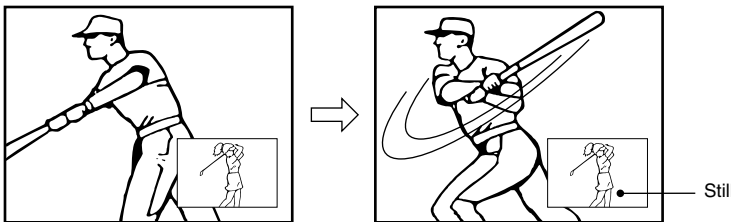

Using Multi-Window feature

The Multi-Window feature provides two channel search modes. One is the "PREVIEW" that scans the channels programmed in the TV memory by the CH PROGRAM function (6-picture multi-search), and the other is the "FAVORITE" that scans the channels programmed in the TV memory by the FAVORITE CH function (9-picture multi-search).

The STROBE function is convenient when watching a quickly moving picture such as a sports program.

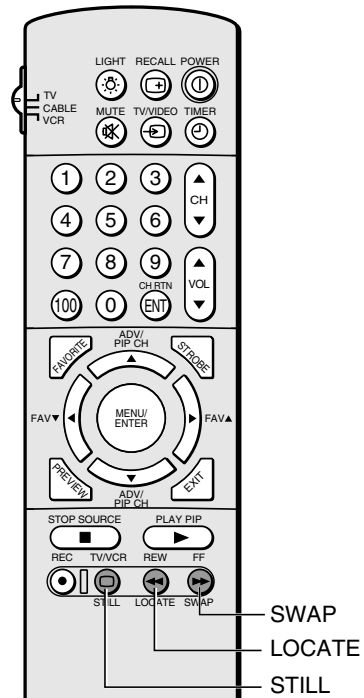

Using the preview function

Press **PREVIEW** to scan the channels programmed in the TV memory by the **CH PROGRAM** function. The 6-picture multi-search will start.

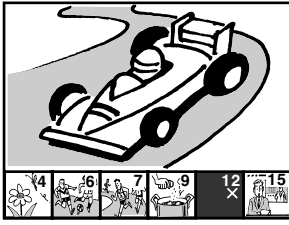

To cancel the preview function:
Press **PREVIEW** again.

Using the favorite function

1. Press **FAVORITE** to scan the channels programmed in the TV memory by the favorite channel function (page 21).
The 9-picture multi-search will start.
The first window will be displayed with a moving picture.
Each time you press **FAVORITE**, the display will change in the following order.
FAVORITE CH1 — FAVORITE CH2 — off
2. Press **▲▼◀▶** to select a channel you want to see with a moving picture.
3. Press **ENTER** to display the channel you selected at step 2 with a normal picture.

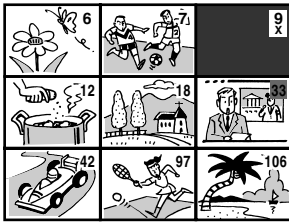

To cancel the favorite function:
Press **FAVORITE** again.

Using the strobe function

Press **STROBE** to start the strobe function. 9-picture multi-strobe starts for the present main picture.

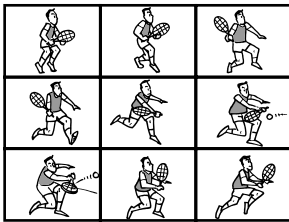

For example, you can watch a decisive moment of a sport program that has been recorded previously.

To cancel the strobe function:
Press **STROBE** again.

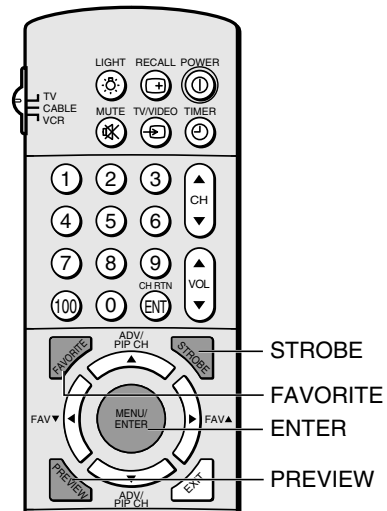

Note:

- When the main picture source is "color stream", the **PREVIEW**, **FAVORITE** and **STROBE** buttons are not available.
- The **FAVORITE** button will not work until you have programmed your favorite channels. See page 21 for details.
- The **PREVIEW** button will not work when the **ANT 2** mode is selected.
- If the **V-CHIP** feature is active and you try to scan a TV program that exceeds the rating limits you set, the "X" mark on the black window will appear. However, during the scanning period, the **V-CHIP** operation may not be done correctly.

Using V-CHIP control

Some TV programs and movies include signals that classify the content of the program (violence, sex, dialog, language). The V-CHIP control feature in this TV detects the signals and blocks the programs according to your selections. To use this feature, perform the following setup.

Selecting the V-CHIP menu

1. Press MENU, then press ◀ or ▶ until the SET UP menu appears.
2. Press ▲ or ▼ to highlight V-CHIP.

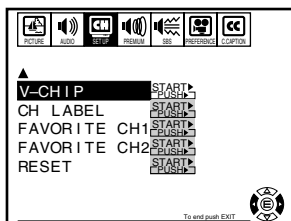

3. Press ◀ or ▶ to display the pin code entering mode.

- Factory reset status

Set your 4 digit code by pressing the Number buttons (0-9).

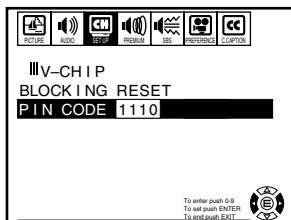

- When the pin code is already stored

Press the Number buttons (0-9) to enter the 4-digit pin code used to block channels.

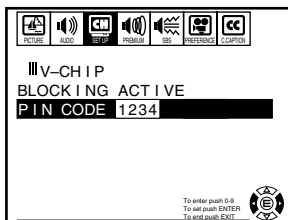

If a wrong pin code has been entered, the message “Incorrect” will appear. Try to enter the correct code again.

If you can not remember the pin code you have stored, while in the pin code entering mode, press the RECALL button four times within 5 seconds. The pin code you have stored will be released. (Factory reset status.)

4. Press ENTER to display the V-CHIP menu.

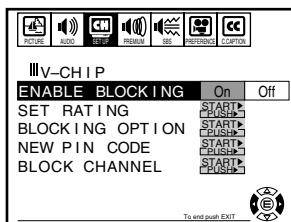

Continue to set each item following the steps on the next page.

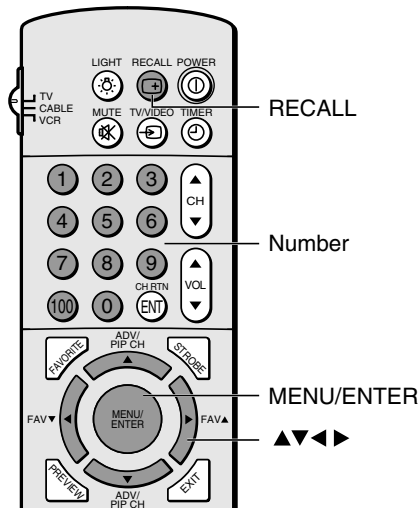

Adjusting the V-CHIP menu

ENABLE BLOCKING

Press ◀ or ▶ to select On or Off.

On : To enable your setting (Block)

Off : To release your setting (Unblock)

Note: The block channel function is not affected with this selection.

SET RATING (Setting the movie or TV ratings for your choice)

1. Press ◀ or ▶ to display the SET RATING menu.
2. Press ▼ (or ▲) to select item.
3. Press ▶ to block (display X)
Press ◀ to unblock (display ✓)
4. Repeat steps 2 and 3 to set the next item.

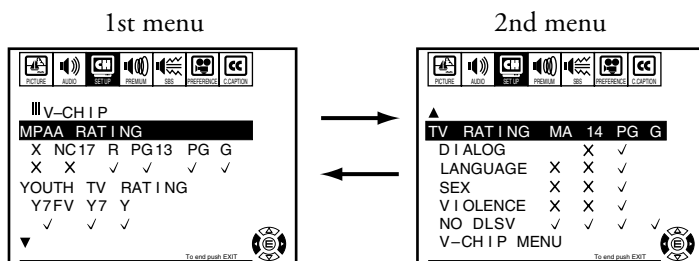

About Rating

MPAA RATING: Independent rating system for movies

G: General Audience (Appropriate for all ages)

PG: Parental Guidance Suggested (Some material may not be suitable for children)

PG13: Parents Strongly Cautioned (Some material may be inappropriate for children under 13)

R: Restricted (Under 17 requires accompanying parent or adult guardian.)

NC17: Not intended for anyone 17 and under

X: X-rated (For adults only)

TV RATING: Independent rating system for broadcasters

YOUTH TV RATING:

Y: All Children (This program is designed to be appropriate for all children)

Y7,Y7FV: Directed to Older Children (This program is designed for children age 7 and above. Note: For those programs where fantasy violence may be more intense or more combative than other programs in this category, such programs will be designated TV-Y7-FV.)

G: General Audience (Most parents would find this program suitable for all ages.)

PG: Parental Guidance Suggested (This program contains material that parents may find unsuitable for younger children.)

D) Some suggestive dialog L) Infrequent coarse language

S) Some sexual situations V) Moderate violence

14: Parents Strongly Cautioned (This program contains some material that many parents would find unsuitable for children under 14 years of age.)

D) Intensely suggestive dialog L) Strong coarse language

S) Intense sexual situations V) Intense violence

MA: Mature Audience Only (This program is specifically designed to be viewed by adults and therefore may be unsuitable for children under 17.)

L) Crude or indecent language S) Explicit sexual activity

V) Graphic violence

V-CHIP menu

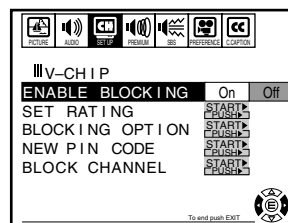

To select each item:

Press ▼ or ▲.

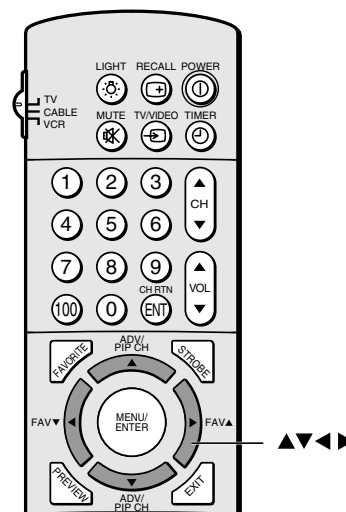

The rating of the TV programs you are now watching can be confirmed by pressing the RECALL button.

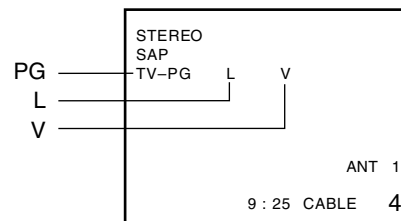

Adjusting the V-CHIP menu (continued)

BLOCKING OPTION

Press ◀ or ▶ to display the BLOCKING OPTIONS menu, then press ▼ or ▲ to select item.

MPAA UNRATED

Press ◀ or ▶ to select On (Block) or Off (Unblock) for unrated programs on MPAA rating system.

TV NONE RATING

Press ◀ or ▶ to select On (Block) or Off (Unblock) for programs rated NONE on TV PARENTAL GUIDELINES.

If you select On, the NOTES shown below will be displayed since the emergency information may also be blocked.

Note: The picture-in-picture is not blocked even if On is selected.

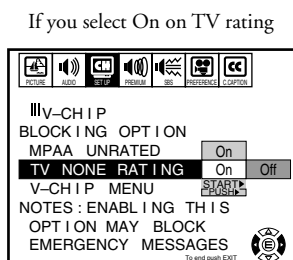
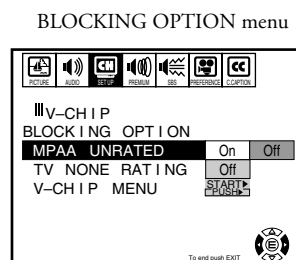

V-CHIP MENU:

Press ◀ or ▶ to return to the V-CHIP menu.

NEW PIN CODE (Changing Pin Code):

1. Press ◀ or ▶ to display the NEW PIN CODE menu.
2. Press the Number buttons (0-9) to enter a 4-digit code. The numbers you enter will replace the dashes in the display.

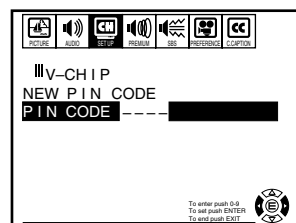

3. Press ENTER. The display will return to the V-CHIP menu.

V-CHIP menu

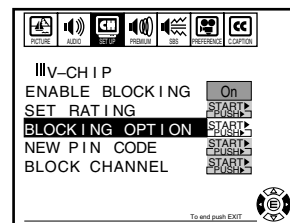

To select each item:

Press ▼ or ▲.

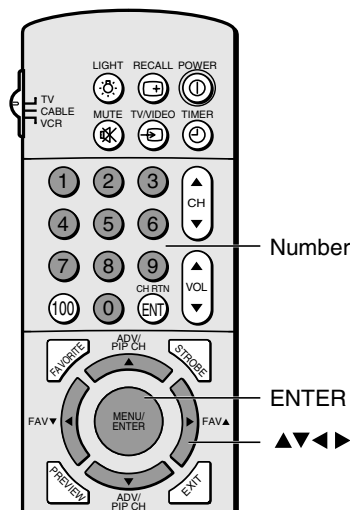

Unblocking programs temporarily

1. If you try to watch a TV program that exceeds the rating limits you set, the TV will enter into the program block mode.

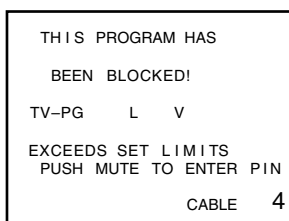

2. If you want to watch the blocked program temporarily, press MUTE.
3. Press the Number button (0-9) to enter the 4-digit code you have stored.

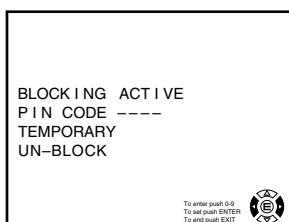

4. Press ENTER.

If the number is correct, the block mode will be released and the normal picture will appear.

All blocking is disabled until the TV is turned off.

It will be enabled when the power is reapplied.

If a wrong pin code is entered, the message appears.

Enter the correct code again.

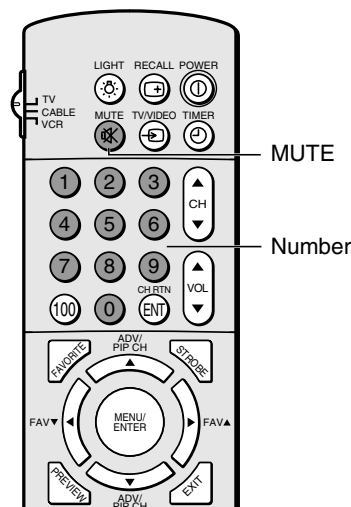

Blocking Channels

With the BLOCK CHANNEL feature, you can block specific channels. The TV will not be able to tune these channels with the Channel ▲▼ buttons or Channel Number buttons, unless you clear the setting.

This TV has 8 memory spaces total, 4 for TV mode and 4 for CABLE mode.

To block channels:

1. Press ◀ or ▶ to display the BLOCK CHANNEL menu. SET/CLEAR will be highlighted.
2. Press ◀ or ▶ to highlight Set.

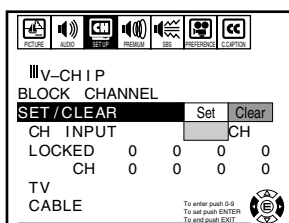

V-CHIP menu

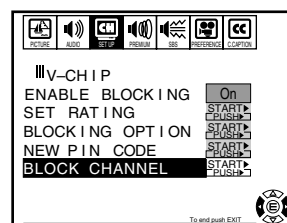

To select each item:
Press ▼ or ▲.

- Press ▼ to highlight CH INPUT, then press the Channel Number buttons to enter the channel number.
- Press ENTER.

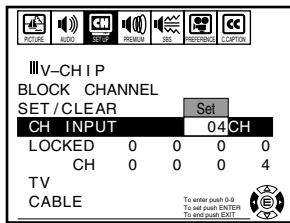

- Repeat steps 3 and 4 for other channels.
- Press EXIT to clear the screen.

To unlock channels:

- Select V-CHIP menu.
- Press ▲ or ▼ to highlight BLOCK CHANNEL.
- Press ◀ or ▶ to display the BLOCK CHANNEL menu.
- Press ◀ or ▶ to highlight Clear.

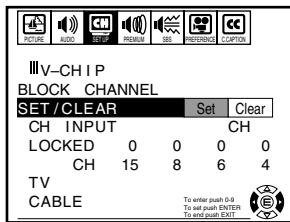

- Press ENTER until "0" replaces the channel numbers you have blocked.

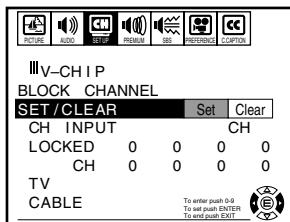

- Press EXIT to clear the screen.

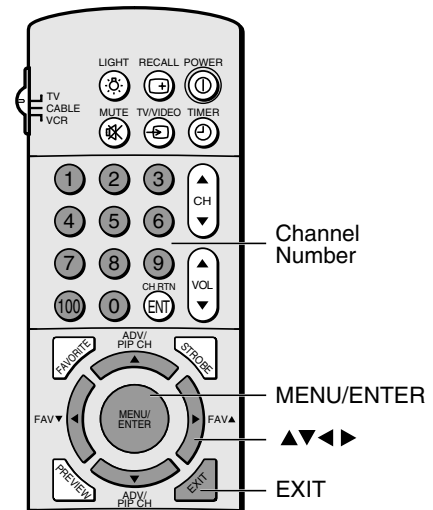

Adjusting the picture

Adjusting the picture quality

You can adjust the picture quality to your personal preferences, including the contrast, brightness, color, tint, sharpness, color temperature, picture preference, flesh tone and noise reduction. The qualities you choose will be stored automatically in your TV's memory so you can recall them at any time.

To adjust the picture quality:

1. Press MENU, then press ◀ or ▶ until the PICTURE menu appears.
2. Press ▲ or ▼ until the item you want to adjust is highlighted.

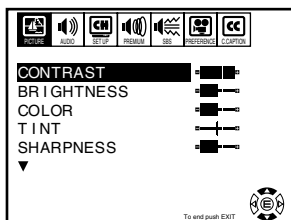

3. Press ◀ or ▶ to adjust the level.

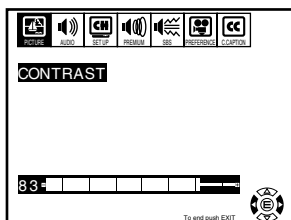

Selection	◀ Pressing ▶	
contrast	lower	higher
brightness	darker	lighter
color	paler	deeper
tint	reddish	greenish
sharpness	softer	sharper

The PICTURE items you have adjusted will be stored in the TV's memory automatically. You can keep these settings or choose preset options under the PREFERENCE menu. (See "Selecting the color temperature" and "Adjusting the picture preferences" on pages 32-33.)

Selecting the color temperature

You can change the quality of the picture by selecting from three preset color temperatures: cool, medium, and warm.

To select the color temperature:

1. Press MENU, then press ◀ or ▶ until the PREFERENCE menu appears.
2. Press ▲ or ▼ to highlight COLOR TEMPERATURE.
3. Press ◀ or ▶ to highlight the mode you want.

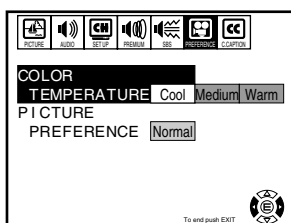

Mode	Picture Quality
cool	blueish
medium	neutral
warm	reddish

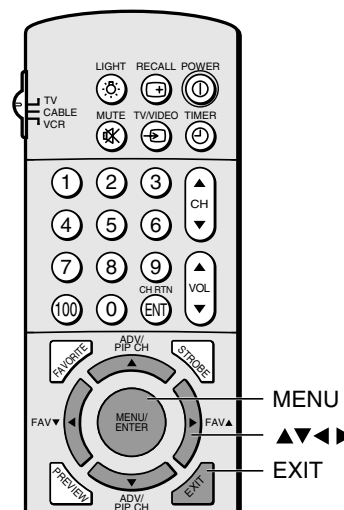
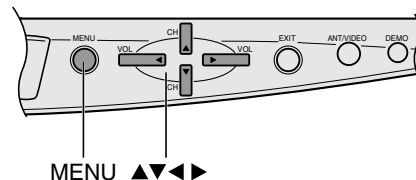

Adjusting the picture preferences

You can select your desired picture type from three preset picture modes: Normal, Theater, and Memory.

To select the picture preferences:

1. Press MENU, then press ◀ or ▶ until the PREFERENCE menu appears.
2. Press ▲ or ▼ to highlight PICTURE PREFERENCE.
3. Press ◀ or ▶ to highlight the mode you want.

The table below describes the effects of the different preferences.

Mode	Picture Quality
normal	picture quality set at factory
theater	movie-like picture setting
memory	your personal preference*

*(see "Adjusting the picture quality" on page 32)

Using the flesh tone feature

This feature allows you to obtain natural flesh tones by correcting the difference of tint between TV stations.

To turn on the flesh tone feature:

1. Press MENU, then press ◀ or ▶ until the PICTURE menu appears.
2. Press ▲ (or ▼) to highlight FLESH TONE.
3. Press ◀ or ▶ to highlight On.

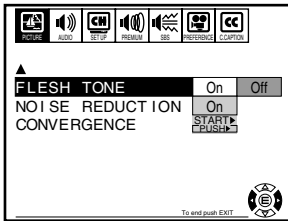

To turn off the flesh tone feature:

Choose Off in step 3 above.

Using the noise reduction feature

This feature allows you to reduce visible interference in your TV picture. This is useful when receiving a broadcast with a weak signal or playing back a video cassette or disk damaged by repeated use.

To turn on the noise reduction feature:

1. Press MENU, then press ◀ or ▶ until the PICTURE menu appears.
2. Press ▲ (or ▼) to highlight NOISE REDUCTION.
3. Press ◀ or ▶ to highlight On.

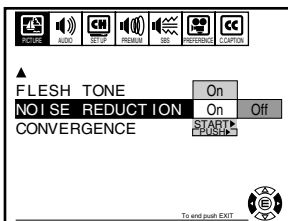

To turn off the noise reduction feature:

Choose Off in step 3 above.

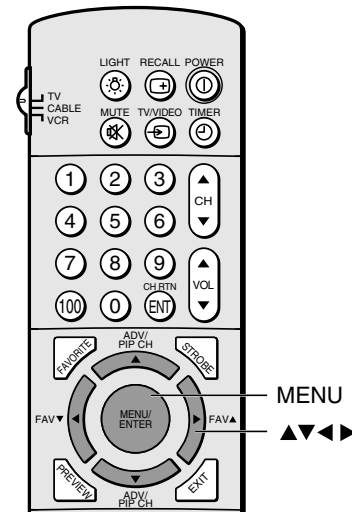

Resetting your adjustments to the factory settings

1. Press MENU, then press ◀ or ▶ until the SET UP menu appears.
2. Press ▲ or ▼ to highlight RESET.

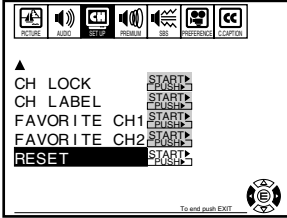

3. Press ◀ or ▶.

The RESET function adjusts the following picture and audio functions.

contrast	max	color temperature	cool
brightness	center	picture preference	normal
color	center	noise reduction	off
tint	center	bass	center
sharpness	center	treble	center
		balance	center

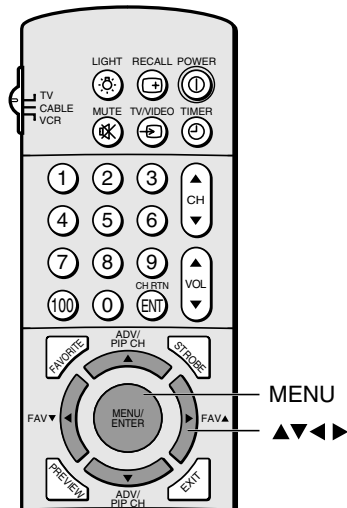

Watching video input

You can use the TV/VIDEO button on the remote or ANT/VIDEO button (page 17) on the TV to view a signal coming from other devices, such as VCRs or video disc players that may be connected to your TV. Select VIDEO 1, VIDEO 2, VIDEO 3, or ColorStream depending on which input jacks are used for connecting the devices. (See "Connecting your TV" on page 5.)

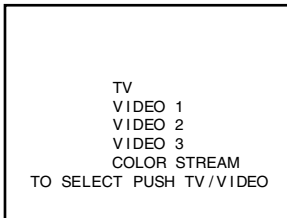

Note:

When ColorStream is selected, the video OUT signal will not have color.

To receive a color video OUT signal, a video or S-video IN jack must be used instead of the ColorStream connection.

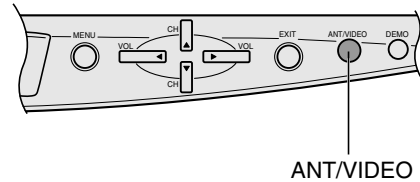

Displaying on-screen information

Press RECALL to display the following on-screen information:

- Antenna mode (when in TV mode)
- Channel number or VIDEO mode selected
- Time (if preset)
- Channel label (if preset)
- Stereo or SAP (second audio program) audio status
- V-CHIP rating status

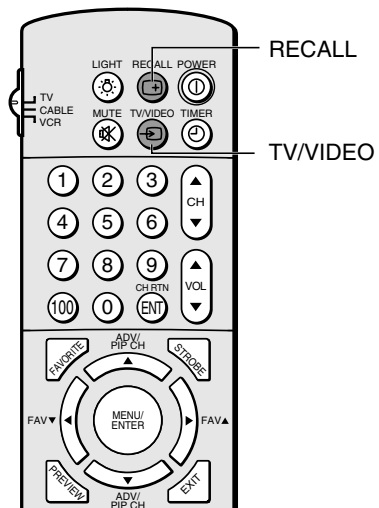
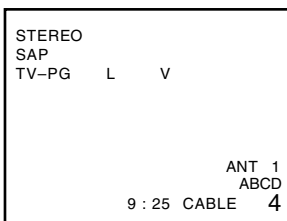

Auto power off

The TV will automatically turn itself off after approximately 15 minutes if it is tuned to a vacant channel or if a station completes its broadcast for the day and stops broadcasting on that channel. This feature, however, does not work in the VIDEO mode.

Displaying XDS information

1. Select the desired program.
2. Press MENU, then press ◀ or ▶ until the CLOSED CAPTION menu appears.
3. Press ▲ or ▼ to highlight XDS.

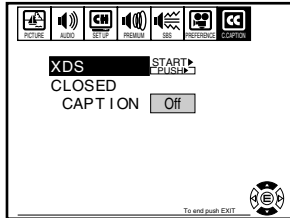

4. Press ◀ or ▶ to display the following XDS (extended Data Service) information for about 30 seconds.

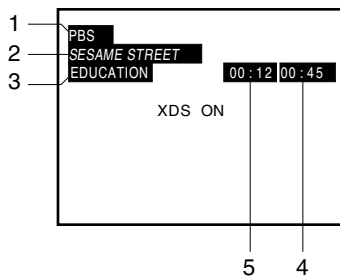

1. Network name
2. Program name
3. Program type
4. Program length
5. Elapsed time in show

Some of the above information may not be displayed.

If the TV program you are watching does not include XDS information. Only XDS ON will be displayed for about 4 seconds when you select the XDS mode.

To close the XDS display:

Press EXIT.

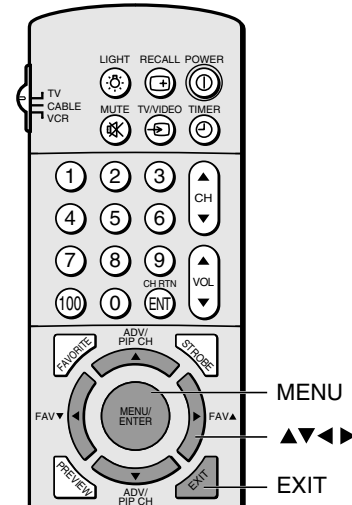

Using the closed caption feature

You have two options with the closed caption feature: captions or text. A caption is a printed version of the dialogue, narration and/or sound effects of a TV program. Text is information not related to the program that appears on half of the TV screen.

To view captions or text:

1. Select the desired program. The captioned programs are usually marked in your local TV listing by "CC."
2. Press MENU, then press ◀ or ▶ until the C.CAPTION menu appears.

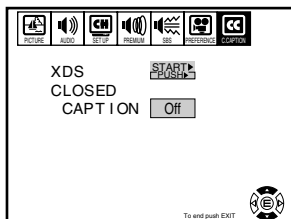

3. Press ▲ or ▼ to highlight CLOSED CAPTION.

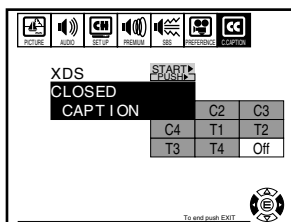

4. Press ◀ or ▶ to select the closed caption mode.
 - Select C1, C2, C3, or C4 to view captions. Select C1 for translation of the primary language in your area.



- Select T1, T2, T3, or T4 to view Text.

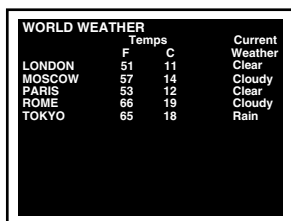

To turn off the closed-caption feature:
Select OFF in step 4.

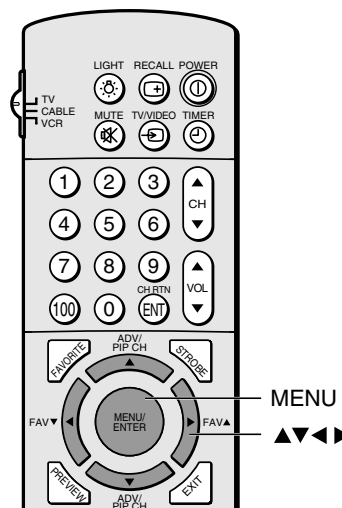

Note:

A closed caption signal may not be decoded in the following situations:

- when a video tape has been dubbed
- when the signal reception is weak
- when the signal reception is nonstandard

When you choose a closed captioned channel and the text mode, the text screen always appears. When there is no signal, however, the text screen will not display text characters.

Setting the off-timer

You can set the TV so it turns off automatically.

To set the off-timer:

1. Press **TIMER** once to select the **OFF TIMER**.
2. Press two Number buttons (0-9) to enter how long you want the TV to remain on (up to three hours, in 10 minute increments). Enter the numbers after the number position starts to blink.

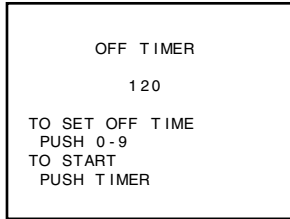

3. Press **TIMER** to start the timer. The display color will change from purple to blue, then turn off.

To cancel the off-timer:

Press **POWER** twice, once to turn the TV off, and once to turn it on again.

Setting the clock

To set the clock

1. Press **TIMER** twice to select the **CLOCK**.
2. Press four Number buttons (0-9) to enter the correct time. Enter the numbers after the number position starts to blink. The clock operates on a 12 hour-cycle.

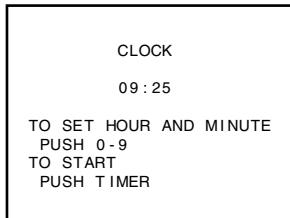

3. Press **TIMER** to start the clock. The display color will change from purple to blue, then turn off.

To monitor the time:

Press **RECALL**.

Note :

The timer can also be set through the **SET UP** menu.

If you want to see how much time remains before the shut-off time, press **TIMER** once.

The remaining time will be displayed. To erase the display, press **TIMER** again.

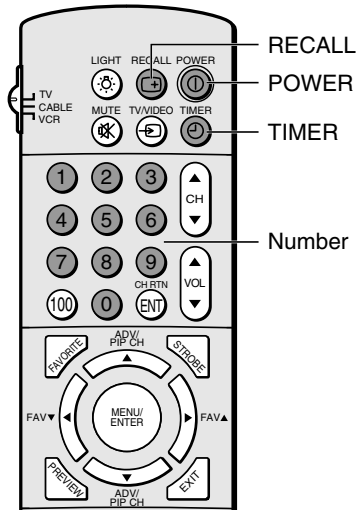

Note:

The clock can also be set through **SET UP** menu.

If the power source for the TV is interrupted (i.e., AC cord unplugged or power failure), the clock will have to be reset. (The time display will show "00:00.")

Adjusting the sound

Muting the sound

Press MUTE to temporarily turn off the sound. While the sound is off, the screen will display the word MUTE in the lower right-hand corner. To restore the sound, press MUTE again.

When you press the MUTE button, you automatically activate the closed caption feature. To deactivate this feature, press the MUTE button again. This feature only works when the closed caption mode is set to off. See "Using the closed caption feature" on page 36 for more information.

Selecting stereo/SAP broadcasts

You can enjoy watching TV while you listen to high-fidelity stereo sound with the Multi-channel TV Sound (MTS) feature. MTS can also transmit a second audio program (SAP) containing a second language or other audio information.

When the TV receives a stereo or SAP broadcast, the word STEREO or SAP appears on the screen when the TV is turned on, you change the channel, or press the RECALL button.

The MTS feature is not available while in the VIDEO mode.

To listen to stereo sound:

1. Press MENU, then press ◀ or ▶ until the AUDIO menu appears.

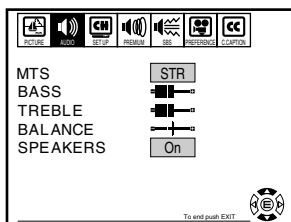

2. Press ▲ or ▼ to highlight MTS.
3. Press ◀ or ▶ to highlight STR.

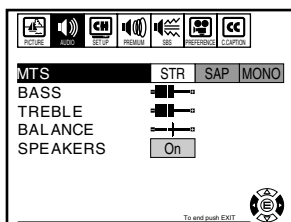

You should leave your TV set to STR so you can automatically receive stereo or monaural sound, depending on the broadcast type. If the stereo sound is noisy, select MONO to reduce the noise. The word STR or SAP is displayed in yellow when the TV receives the signal, and in purple when you have selected the feature.

To listen to a second audio program:

1. Press MENU, then press ◀ or ▶ until the AUDIO menu appears.
2. Press ▲ or ▼ to highlight MTS.
3. Press ◀ or ▶ to highlight SAP. You will hear only the second audio program from the left and right speakers.

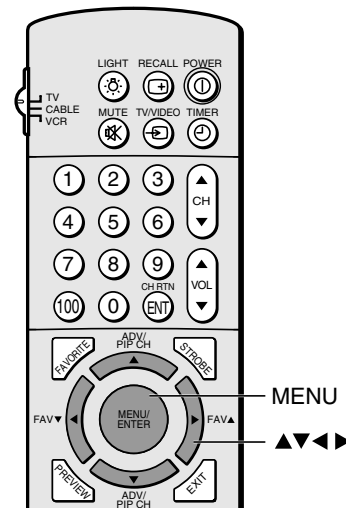
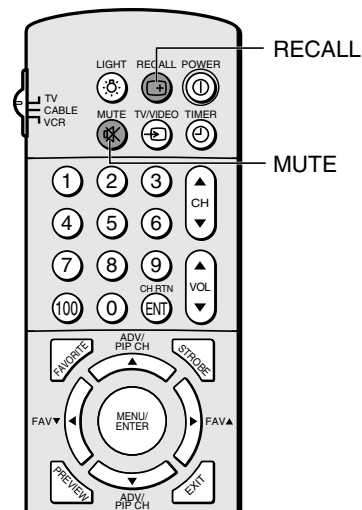

Adjusting the sound quality

You can change the sound quality of your TV by adjusting the bass, treble, and balance.

To adjust the sound quality:

1. Press MENU, then press ◀ or ▶ until the AUDIO menu appears.
2. Press ▲ or ▼ to highlight the item you want to adjust.

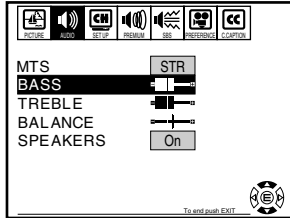

3. Press ◀ or ▶ to adjust the level.

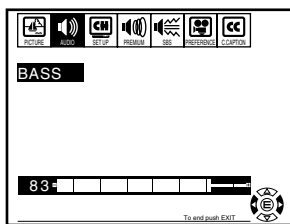

- ◀ makes the sound quality weaker or decreases the balance in the right channel, depending on the item selected.
- ▶ makes the sound quality stronger or decreases the balance in the left channel, depending on the item selected.

Using the surround sound feature

The surround sound feature expands the audio listening field wider and deeper to create exceptional sound quality from the TV's speakers. The feature uses stereo signals from a TV broadcast or video input.

To turn on the surround sound feature:

1. Select the stereo mode following the steps under "Selecting stereo/SAP broadcasts" on page 38.
2. Press MENU, then press ◀ or ▶ until the PREMIUM menu appears.
3. Press ▲ or ▼ to highlight SURROUND.
4. Press ◀ or ▶ to highlight On.

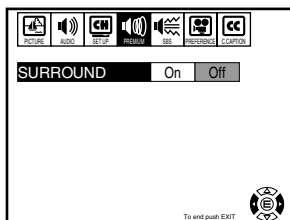

To turn off the surround sound feature:

Choose OFF in step 4 above.

In general, you should leave your TV set to SURROUND so it can automatically produce surround stereo or monaural sound, depending on the broadcast type.

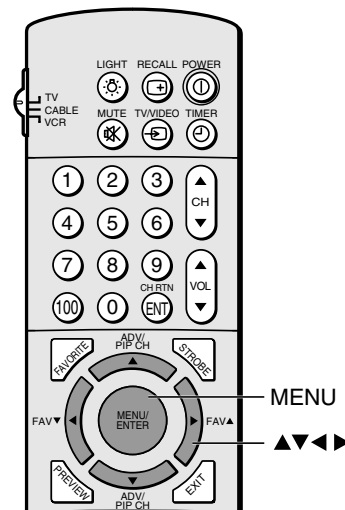

Using the Sub-Bass System (SBS)

The Sub-Bass System allows you to improve bass performance (even when the sound volume is low).

To turn on the Sub-Bass System:

1. Press MENU, then press ◀ or ▶ until the SBS menu appears.
2. Press ▲ or ▼ to highlight SBS.
3. Press ◀ or ▶ to highlight On.

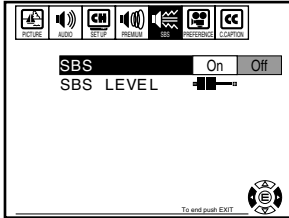

To adjust the SBS level:

4. Press ▲ or ▼ to highlight SBS LEVEL.
5. Press ◀ or ▶ to adjust the SBS level.

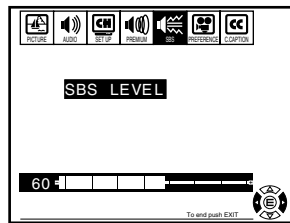
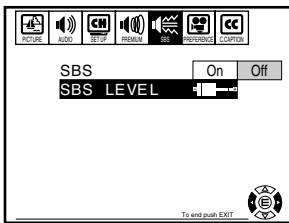

To turn off the Sub-Bass System:

Choose Off in step 3 above.

Turning off the built-in speakers

Use this feature to turn the TV speaker off when you connect an audio system. (See page 9.)

1. Press MENU, then press ◀ or ▶ until AUDIO menu appears.
2. Press ▲ or ▼ to highlight SPEAKERS.
3. Press ◀ or ▶ to highlight Off.

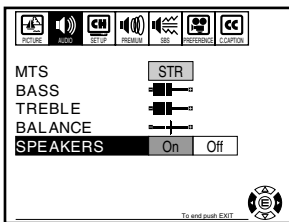

To turn on the built-in speakers:

Choose On in step 3.

Note:

The Sub-Bass System signal does not pass through the "Variable Audio OUT" jacks. (See page 9.)

However, the SBS menu will appear when the buttons are pressed.

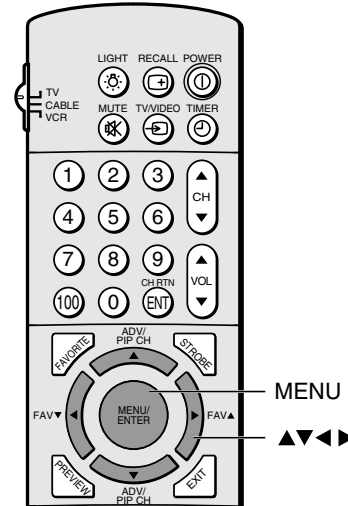

Note:

Make sure the volume control of your audio amplifier is set to a moderate listening level.

Viewing the demonstration mode

When you press DEMO, the TV will automatically display a variety of its on-screen menus and special features. This function is provided for demonstration purposes only.

- While in TV or VIDEO mode, the Multi-Window features demonstrate.
- While in ColorStream mode, other menus and features demonstrate.

To stop the demonstration mode:

Press DEMO again.

Understanding the last mode memory feature

If the power is cut off while you are viewing the TV and the power is resupplied, the last mode memory feature will turn the TV on automatically.

If the power is going to be off for a long time or you are going to be away from home for a long time, remove the power plug from the wall outlet to prevent the TV from turning on in your absence.

Appendix

Specifications

Television System	NTSC standard
Channel Coverage	VHF: 2 through 13 UHF: 14 through 69 Cable TV: Mid band (A-8 through A-1, A through I) Super band (J through W) Hyper band (AA through ZZ, AAA, BBB) Ultra band (65 through 94, 100 through 125)
Power Source	120 V AC, 60 Hz
Power Consumption	TZ50V61: 178 W (average) TZ55V61: 180 W (average) TZ61V61: 180 W (average)
Audio Power	14 W + 14 W
Speaker Type	Two 6-1/4 inches (16 cm) round
Video/Audio Terminals	S-VIDEO INPUT (VIDEO 1/VIDEO 2/VIDEO 3) Y-INPUT: 1 V(p-p), 75 ohm, negative sync. C-INPUT: 0.286 V(p-p) (burst signal), 75 ohm VIDEO 1/VIDEO 2/VIDEO 3 INPUT VIDEO: 1 V(p-p), 75 ohm, negative sync. AUDIO: 150 mV(rms) (30% modulation equivalent, 47 kohm) ColorStream™ (component video) INPUT Y-INPUT: 1V(p-p), 75 ohm Cr-INPUT: 0.7 V(p-p), 75 ohm Cb-INPUT: 0.7 V(p-p), 75 ohm AUDIO: 150 mV(rms), 47 kohm VIDEO/AUDIO OUTPUT VIDEO: 1 V(p-p), 75 ohm, negative sync. AUDIO: 150 mV(rms) (30% modulation equivalent, 4.7 kohm) VARIABLE AUDIO OUTPUT 0–350 mV(rms) (30% modulation equivalent, 4.7 kohm) AUDIO CENTER CHANNEL INPUT 1 V(rms) (30% modulation equivalent, 10 kohm)

Dimensions/Mass

	Dimension (W/H/D)	Mass
TZ50V61	42-1/4 x 50-5/8 x 20-13/16 inches (1,073 ξ 1,284 ξ 528 mm)	217 lbs (98.4 kg)
TZ55V61	46-5/6 ξ 53-9/16 ξ 22-15/16 inches (1,176 ξ 1,360 ξ 582 mm)	250 lbs (113 kg)
TZ61V61	51-1/16 x 57-3/16 ξ 24-9/16 inches (1,296 ξ 1,452 ξ 624 mm)	288 lbs (130 kg)

Supplied Accessories Remote Control with 2 size “AA” alkaline batteries

Design and specifications are subject to change without notice.

Troubleshooting

Before calling a service technician, please check the following table for a possible cause of the problem and some solutions.

Problem	Solution
TV will not turn on	<ul style="list-style-type: none">• Make sure the power cord is plugged in, then press POWER.• The remote control batteries may be dead. Replace the batteries.
No picture, no sound	<ul style="list-style-type: none">• Check the antenna/cable connections.
No sound, picture OK	<ul style="list-style-type: none">• The sound may be muted. Press VOLUME.• The station may have broadcast difficulties. Try another channel.• Check that the SPEAKERS function in AUDIO menu is properly set.
Poor sound, picture OK	<ul style="list-style-type: none">• The station may have broadcast difficulties. Try another channel.
Poor picture, sound OK	<ul style="list-style-type: none">• Check the antenna connections.• The station may have broadcast difficulties. Try another channel.• Adjust the PICTURE menu.
Poor reception of broadcast channels	<ul style="list-style-type: none">• The station may have broadcast difficulties. Try another channel.• Check the antenna connections.• If you are using a VCR, make sure the TV/VCR button is set correctly.
Cannot receive above channel 13	<ul style="list-style-type: none">• Make sure TV/CABLE is set to TV mode.
Black box appears on the screen	<ul style="list-style-type: none">• Captioning may be turned on.
Unable to select a certain channel	<ul style="list-style-type: none">• The channel may be locked out with the BLOCK CHANNEL feature, or erased with the ADD/ERASE feature.
Multiple images	<ul style="list-style-type: none">• The station may have broadcast difficulties. Try another channel.• Use a highly directional outdoor antenna.
Poor color or no color	<ul style="list-style-type: none">• The station may have broadcast difficulties. Try another channel.• Adjust the TINT and/or COLOR in the PICTURE menu.
No stereo or SAP sound from a known MTS broadcast	<ul style="list-style-type: none">• Make sure the MTS feature is set properly.
The remote control does not operate	<ul style="list-style-type: none">• Check if the TV/CABLE/VCR switch is properly set.• There may be an obstruction between the remote control and the remote control sensor.• The remote control batteries may be dead. Replace the batteries.

Limited United States Warranty

Toshiba America Consumer Products, Inc. ("TACP") and Toshiba Hawaii Inc. ("THI") make the following limited warranties. These limited warranties extend to the original consumer purchaser or any person receiving this set as a gift from the original consumer purchaser and to no other purchaser or transferee.

Limited One (1) Year Warranty

TACP and THI warrant this product and its parts against defects in materials or workmanship for a period of one (1) year after the date of original retail purchase. During this period, TACP and THI will repair or replace a defective part, at their option, with a new or refurbished part, without charge to you. TACP/THI Authorized Service Station personnel will come to your home when warranty service is required. Depending on the type of repair required, the service will either be performed in your home or the set will be taken to the TACP/THI authorized service station for repair and returned to your home at no cost to you.

Limited Two (2) Year Warranty of Picture Tube

TACP and THI further warrant the picture tube in this product against defects in materials or workmanship for a period of two (2) years after the date of original retail purchase. During this period, TACP and THI will repair or replace a defective picture tube at their option, with a new or refurbished picture tube, without charge to you, except that if a defective picture tube is replaced after one (1) year from the date of the original retail purchase, you pay labor charges involved in the replacement.

Rental Units

The warranty for rental units begins with the first rental or thirty (30) days from the date of shipment to the rental firm, whichever comes first.

Commercial Units

Products sold and used for commercial use have a limited ninety (90) day warranty for all parts, labor and picture tube.

How to Obtain Warranty Service

If after following all of the operating instructions in this manual and checking the section "BEFORE CALLING SERVICE PERSONNEL," you find that service is needed;

- (1) Call the TACP toll free number 1-800-631-3811 after you find a defective product or part to find the nearest TOSHIBA Authorized Service Station.
- (2) Please present your bill of sale or other proof to the Authorized Service Station. "Authorized TACP/THI service station personnel will come to your home when warranty service is required. Depending on the type of repair required, the service will either be performed in your home or the set will be taken to the TACP/THI Authorized service station for repair and returned to your home at no cost to you."

In the Continental United States call:



In Hawaii contact:

Toshiba Hawaii, Inc. 327 Kamakee Street, Honolulu, Hawaii 96814 (808) 521-5377

All warranties implied by state law, including the implied warranties of merchantability and fitness for a particular purpose, are expressly limited to the duration of the limited warranties set forth above. With the exception of any warranties implied by state law as hereby limited, the foregoing warranty is exclusive and in lieu of all other warranties, guarantees, agreements and similar obligations of manufacturer or seller with respect to the repair or replacement of any parts. In no event shall TACP or THI be liable for consequential or incidental damages.

No person, agent, distributor, dealer or company is authorized to change, modify or extend the terms of these warranties in any manner whatsoever. The time within which action must be commenced to enforce any obligation of TACP or THI arising under this warranty or under any state, or law of the United States or any state thereof, is hereby limited to 90 days from the date you discover or should have discovered, the defect. This limitation does not apply to implied warranties arising under state law.

This warranty gives you specific legal rights and you may also have other rights which may vary from state to state. Some states do not allow limitation on how long an implied warranty lasts, when an action may be brought, or the exclusion or limitation of incidental or consequential damages, so the above provisions may not apply to you.



ATTENTION CANADIAN CONSUMERS:

Canadian consumers are requested to complete the special Canadian "Warranty Registration Form" enclosed, and forward this completed form with a copy of bill of sale to TOSHIBA OF CANADA to "Register and Validate" their warranty.

Products purchased in the U.S.A. and used in Canada are not covered by these warranties.

Products Purchased in Canada and used in the U.S.A. are not covered by these warranties.

REV. 09-01

Index

A

- adding and erasing channels manually 19
- adding channels to the TV's memory 18
- adjusting
 - channel settings 21
 - color convergence 19
 - picture preferences 33
 - picture quality 32
 - sound 39
 - v-chip menu 28
- ANT/VIDEO button, using 17
- antenna input, selecting 17
- audio system, connecting 9
- auto power off 35
- A/V receiver, connecting 10

B

- batteries, installing into the remote control 11
- blocking channels 30

C

- cable converter box and a VCR, connecting 6
- cable converter box, connecting 6
- cable TV converter code table 14
- camcorder, connecting 9
- changing
 - channels 19
 - on-screen display language 17
 - position of the small picture (PIP) 25
- channel settings, adjusting 21
- channels
 - adding or erasing manually 19
 - adding to the TV's memory 18
 - blocking 30
 - changing 19
 - favorite, programming 21
 - labeling 22
 - programming automatically 18
 - switching between two 21
- cleaning your TV 2
- clock, setting 37
- closed caption feature, using 36
- code table
 - cable TV converter 14
 - VCR 13
- color convergence, adjusting 19
- color temperature, selecting 32

- connecting
 - audio system 9
 - A/V receiver 10
 - cable converter box 6
 - cable converter box and a VCR 6
 - camcorder 9
 - DVD with ColorStream and a VCR 7
 - DVD/satellite receiver and a VCR 7
 - TV 5
 - VCR 5
 - VCRs, two 8

D

- demonstration mode, viewing 41
- displaying on-screen information 34
- displaying XDS information 35
- DVD with ColorStream and a VCR, connecting 7
- DVD/satellite receiver and a VCR, connecting 7

F

- favorite channels, programming 21
- favorite function, using 26
- flesh tone feature, using 33
- freezing the small picture (PIP) 25

L

- labeling channels 22
- language, changing the on-screen display 17
- last mode memory feature, understanding 41

M

- multi-window feature, using 25
- muting the sound 38

N

- noise reduction feature, using 33

O

- off-timer, setting 37
- on-screen display language, changing 17
- on-screen information, displaying 34

P

- picture
 - adjusting 32
 - color temperature, selecting 32
 - preferences, adjusting 33
 - quality, adjusting 32

picture-in-picture (PIP)	
changing the position of the small picture	25
freezing the small picture	25
main and small pictures, switching	25
watching	24
power, auto off	35
preview function, using	26
programming	
channels automatically	18
favorite channels	21
remote control for use with a VCR	12

R

remote control	
batteries, installing	11
learning about	15
preparing for use	11
programming for use with a VCR	12
using	11
using with a VCR or cable TV converter	11

S

SAP, selecting	38
satellite receiver/DVD and a VCR, connecting	7
setting	
clock	37
off-timer	37
sound	
adjusting	38
muting	38
stereo/SAP broadcasts, selecting	38
sub-bass system, using	40
surround, using	39
speakers, turning off	40
specifications	42
stereo sound, selecting	38
strobe function, using	26
sub-bass system, using	40
surround sound, using	39
switching between two channels	21
switching the main and small pictures (PIP)	25

T

troubleshooting	43
TV	
cleaning	2
connecting	5
installing	2
setting up	16
using	2

V

v-chip control, using	27
VCR and a cable converter box, connecting	6
VCR and a DVD with ColorStream, connecting	7
VCR and a DVD/satellite receiver, connecting	7
VCR, connecting	5
VCRs, connecting two	8
video input, watching	34

W

warranty	44
watching	
picture-in-picture (PIP)	24
video input	34

TOSHIBA AMERICA CONSUMER PRODUCTS, INC.

HEAD OFFICE/82 TOTOWA ROAD, WAYNE, NEW JERSEY 07470
FACTORY SERVICE CENTER:1420B TOSHIBA DRIVE, LEBANON, TN. 37087

TOSHIBA HAWAII, INC.

HEAD OFFICE/327 KAMAKEE STREET, HONOLULU, HAWAII 96814, U.S.A. TEL: (808) 521-5377

TOSHIBA OF CANADA LTD.

HEAD OFFICE/191 McNABB STREET MARKHAM, ONTARIO L3R 8H2, CANADA TEL: (905) 470-5400
SERVICE CENTERS/TORONTO: 191 McNABB STREET MARKHAM, ONTARIO L3R 8H2, CANADA TEL: (905) 470- 5400
MONTREAL: 1643, NORTH SERVICE RD., TRANS-CANADA HIGHWAY, DORVAL QUEBEC, H9P 1J1, CANADA
TEL: (514) 856-4100
VANCOUVER: 22171 FRASERWOOD WAY, RICHMOND, B.C. V6W 1J5, CANADA TEL: (604) 303-2500

MANUFACTURED BY
TOSHIBA AMERICA CONSUMER PRODUCTS, INC.

PRINTED IN USA
(99-05)

TOSHIBA

23563585

Free Manuals Download Website

<http://myh66.com>

<http://usermanuals.us>

<http://www.somanuals.com>

<http://www.4manuals.cc>

<http://www.manual-lib.com>

<http://www.404manual.com>

<http://www.luxmanual.com>

<http://aubethermostatmanual.com>

Golf course search by state

<http://golfingnear.com>

Email search by domain

<http://emailbydomain.com>

Auto manuals search

<http://auto.somanuals.com>

TV manuals search

<http://tv.somanuals.com>