

**TOSHIBA**  
Leading Innovation >>>

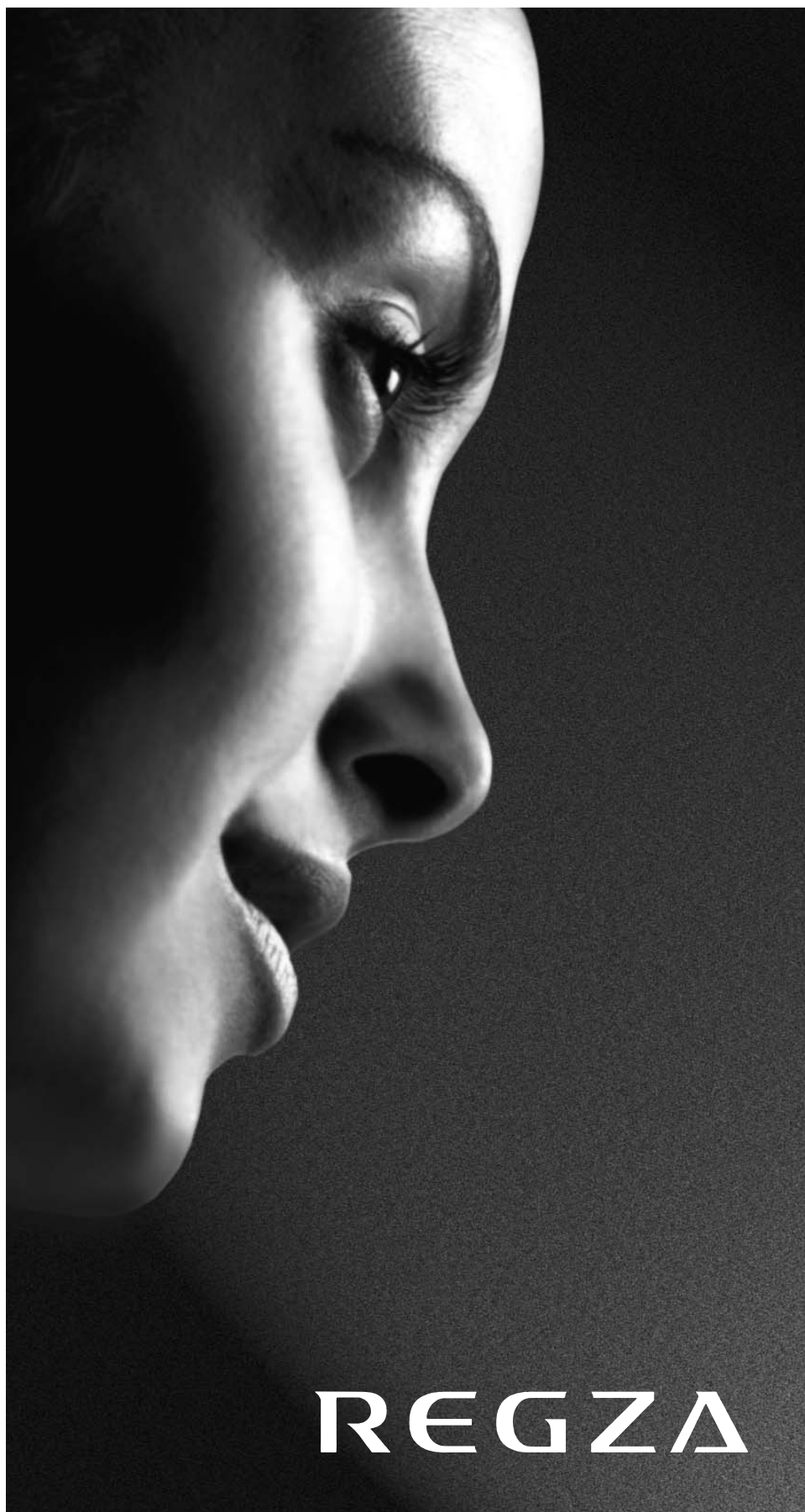

**XV\*\*\*  
Digital  
Series**



# Contents

## SETTING UP

<b>Safety precautions</b> – Some do's and don't for you to be aware of	4
<b>Installation and important information</b>	5
<b>The remote control</b> – an at-a-glance guide	6
<b>Connecting external equipment</b> – a guide to connecting external equipment to the back of the television	7
<b>REGZA-LINK connections</b>	8
<b>Connecting an HDMI or DVI device to the HDMI input</b>	9
<b>Connecting a computer</b> – connecting a computer to the HDMI terminal on the back of the television	10
<b>Acceptable signals through HDMI terminals</b>	11
<b>Connecting a computer</b> – connecting a computer to the RGB/PC terminal on the back of the television	12
<b>Acceptable PC signals through the PC terminal</b>	13
<b>Using the controls</b> – switching on the television, standby, using the remote control, using the controls on the television, headphone socket	14

## TUNING THE TELEVISION

<b>Tuning the television for the first time</b>	15
<b>Setting antenna or cable</b>	16
<b>DTV auto tuning, manual tuning, manual tuning for DVB-C</b>	17
<b>DTV location, auto channel update, DVB character set, Analogue switch off</b>	18
<b>DTV sorting channels, skipping channels</b>	19
<b>ATV manual tuning, broadcast system</b>	20
<b>ATV skipping channels, sorting channel positions</b>	21

## CONTROLS AND FEATURES

<b>General controls</b> – selecting programme positions	22
<b>Stereo and bilingual transmissions</b> – stereo/mono or dual language broadcasts	22
<b>Time display (ATV only)</b>	22
<b>Sound controls</b> – volume, sound mute	22
<b>Quick menu</b>	22
<b>Sound settings</b> – dual, bass, treble and balance, advanced sound settings (surround, voice enhancement, dynamic bass boost, external woofer), Dolby Volume®	23
<b>Sound settings</b> – dynamic range control (DTV only), audio level offset, headphone settings, audio description	24
<b>Widescreen viewing</b>	25
<b>Picture controls</b> – picture position (ATV only), picture mode, picture preferences (contrast, brightness, colour, tint, sharpness)	27
<b>Picture controls</b> – reset, backlight, 3D colour management, base colour adjustment	28
<b>Picture controls</b> – colour temperature, auto brightness sensor settings, active backlight control, black/white level	29
<b>Picture controls</b> – static gamma, MPEG noise reduction (MPEG NR), digital noise reduction (DNR), Resolution +	30
<b>Picture controls</b> – Active Vision M100, film stabilization, expert mode, reset	31
<b>Picture controls</b> – control visualization, panel lock (disabling the buttons on the television), automatic format (widescreen)	32
<b>Picture controls</b> – 4:3 stretch, blue screen, side panel adjustment, Toshiba illumination, picture still	33
<b>DTV programme timer</b>	34
<b>Timers</b> – on timer (setting the television to turn on)	34
<b>Timers</b> – cancelling the on timer, sleep timer (setting the television to turn off)	35
<b>DTV on-screen information</b>	36
<b>DTV programme guide</b>	37
<b>DTV Settings</b> – setting the PIN code, parental control, locking channels	38
<b>DTV Settings</b> – subtitles, audio languages, common interface	39

# Contents (continued)

<b>Software Upgrade</b> – auto upgrade, searching for new software, software licences, system information, reset TV	<b>40</b>
<b>Media player</b> – auto start, opening media player automatically, opening media player from the menu	<b>41</b>
<b>Media player</b> – multiview, single view, slideshow, interval time and repeat	<b>42</b>
<b>Media player</b> – playing movies, picture size and repeat, DivX® VOD	<b>43</b>
<b>Media player</b> – playing music, repeat mode	<b>44</b>
<b>Media player</b> – setting up the photo frame feature	<b>45</b>
<b>PC settings for RGB/PC connections</b> – picture position, clock phase, sampling clock, reset	<b>46</b>
<b>REGZA-LINK controls</b> – general information, input source selection	<b>47</b>
<b>REGZA-LINK menus</b> – enable REGZA-LINK	<b>48</b>
<b>REGZA-LINK menus</b> – TV auto power, auto standby, amplifier control, speaker preference	<b>49</b>
<b>Input selection and AV connections</b> – input selection, external input skip, input signal selection, PC audio	<b>50</b>
<b>Input selection and AV connections</b> – HDMI1 Audio, HDMI settings (lip sync, INSTAPORT™, RGB range), digital output	<b>51</b>
<b>TEXT SERVICES</b>	
<b>ATV text services</b> – selecting modes, general information, Auto and LIST modes	<b>52</b>
<b>ATV text services</b> – control buttons	<b>53</b>
<b>DTV interactive services</b> – general information	<b>53</b>
<b>PROBLEM SOLVING</b>	
<b>Questions and Answers</b> – answers to some common queries including manual fine tuning, colour system	<b>54</b>
<b>INFORMATION</b>	
<b>Disposal</b>	<b>58</b>
<b>Specifications and Accessories</b> – technical information about the television, supplied accessories	<b>59</b>

# Safety Precautions

This equipment has been designed and manufactured to meet international safety standards but, like any electrical equipment, care must be taken to obtain the best results and for safety to be assured. Please read the points below for your own safety. They are of a general nature, intended to help with all electronic consumer products and some points may not apply to the goods you have just purchased.

## Air Circulation

Leave more than 10cm clearance around the television to allow adequate ventilation. This will prevent overheating and possible damage to the television. Dusty places should also be avoided.

## Heat Damage

Damage may occur if the television is left in direct sunlight or near a heater. Avoid places subject to extremely high temperatures or humidity. Place in a location where the temperature remains between 5°C (41°F) min. and 35°C (94°F) max.

## Mains Supply

The mains supply required for this equipment is 220-240v AC 50/60Hz. Never connect to a DC supply or any other power source. DO ensure that the television is not standing on the mains lead. DO NOT cut off the mains plug from this equipment, this incorporates a special Radio Interference Filter, the removal of which will impair its performance.

In the UK, the fuse fitted in the plug is approved by ASTA or BSI to BS1362. It should only be replaced by a correctly rated and approved type and the fuse cover must be refitted.

IF IN DOUBT PLEASE CONSULT A COMPETENT ELECTRICIAN.

## Do

**DO** read the operating instructions before you attempt to use the equipment.

**DO** ensure that all electrical connections (including the mains plug, extension leads and inter-connections between pieces of equipment) are properly made and in accordance with the manufacturers' instructions. Switch off and withdraw the mains plug before making or changing connections.

**DO** consult your dealer if you are ever in doubt about the installation, operation or safety of your equipment.

**DO** be careful with glass panels or doors on equipment.

**DO NOT REMOVE ANY FIXED COVERS AS THIS WILL EXPOSE DANGEROUS AND 'LIVE' PARTS.**

**THE MAINS PLUG IS USED AS A DISCONNECTING DEVICE AND THEREFORE SHOULD BE READILY OPERABLE.**

## Do not

**DO NOT** obstruct the ventilation openings of the equipment with items such as newspapers, tablecloths, curtains, etc. Overheating will cause damage and shorten the life of the equipment.

**DO NOT** allow electrical equipment to be exposed to dripping or splashing or objects filled with liquids, such as vases, to be placed on the equipment.

**DO NOT** place hot objects or naked flame sources, such as lighted candles or nightlights on, or close to equipment. High temperatures can melt plastic and lead to fires.

**DO NOT** use makeshift stands and NEVER fix legs with wood screws. To ensure complete safety, always fit the manufacturers' approved stand, bracket or legs with the fixings provided according to the instructions.

**DO NOT** leave equipment switched on when it is unattended, unless it is specifically stated that it is designed for unattended operation or has a standby mode. Switch off by withdrawing the plug, make sure your family know how to do this. Special arrangements may need to be made for people with disabilities.

**DO NOT** continue to operate the equipment if you are in any doubt about it working normally, or it is damaged in any way – switch off, withdraw the mains plug and consult your dealer.

**WARNING** – excessive sound pressure from earphones or headphones can cause hearing loss.

**ABOVE ALL – NEVER let anyone, especially children, push or hit the screen, push anything into holes, slots or any other openings in the case.**

**NEVER guess or take chances with electrical equipment of any kind – it is better to be safe than sorry.**

# Installation and important information

## Where to install

Locate the television away from direct sunlight and strong lights, soft, indirect lighting is recommended for comfortable viewing. Use curtains or blinds to prevent direct sunlight falling on the screen.

Place the TV on a stable, level surface that can support the weight of the TV. **In order to maintain stability and prevent it falling over, secure the TV to the level surface using the strap located under the table top stand, or to a wall using a sturdy tie to the clip on the back of the table top stand.**

The LCD display panels are manufactured using an extremely high level of precision technology, however sometimes some parts of the screen may be missing picture elements or have luminous spots. This is not a sign of a malfunction.

Make sure the television is located in a position where it cannot be pushed or hit by objects, as pressure will break or damage the screen, and that small items cannot be inserted into slots or openings in the case.

### Cleaning the screen and cabinet...

Turn off the power, clean the screen and cabinet with a soft, dry cloth. We recommend that you **do not** use any proprietary polishes or solvents on the screen or cabinet as this may cause damage.

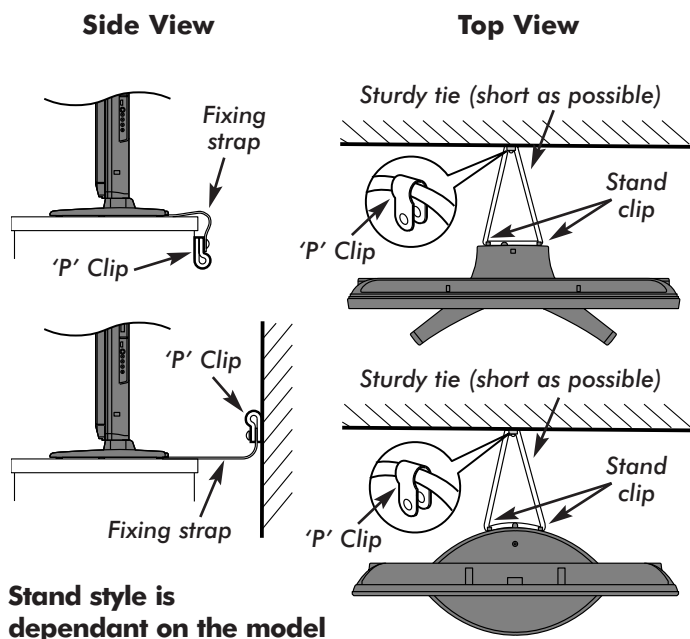

**Stand style is dependant on the model**

## Please take note

The digital reception function of this television is only effective in the countries listed in **Country** in the **SETUP** menu. Depending on the country/area some of this television's functions may not be available. Reception of future additional or modified services can not be guaranteed with this television.

If stationary images generated by 4:3 broadcasts, text services, channel identification logos, computer displays, video games, on screen menus, etc. are left on the television screen for any length of time they could become conspicuous, it is always advisable to reduce both the brightness and contrast settings.

Very long, continuous use of the 4:3 picture on a 16:9 screen may result in some retention of the image at the 4:3 outlines, this is not a defect of the LCD TV and is not covered under the manufacturers warranty. Regular use of other size modes (eg. Superlive) and varying the "side panel" brightness (if available on the model) will prevent permanent retention.

## EXCLUSION CLAUSE

Toshiba shall under no circumstances be liable for loss and/or damage to the product caused by:

- i) fire;
- ii) earthquake;
- iii) accidental damage;
- iv) intentional misuse of the product;
- v) use of the product in improper conditions;
- vi) loss and/or damage caused to the product whilst in the possession of a third party;
- vii) any damage or loss caused as a result of the owner's failure and/or neglect to follow the instructions set out in the owner's manual;
- viii) any loss or damage caused directly as a result of misuse or malfunction of the product when used simultaneously with associated equipment;

Furthermore, under no circumstances shall Toshiba be liable for any consequential loss and/or damage including but not limited to the following, loss of profit, interruption of business, the loss of recorded data whether caused during normal operation or misuse of the product.

**NOTE:** A Toshiba wall bracket or stand, where available, must be used to maintain the product's BEAB approval.



# The remote control

Simple at-a-glance reference of your remote control.

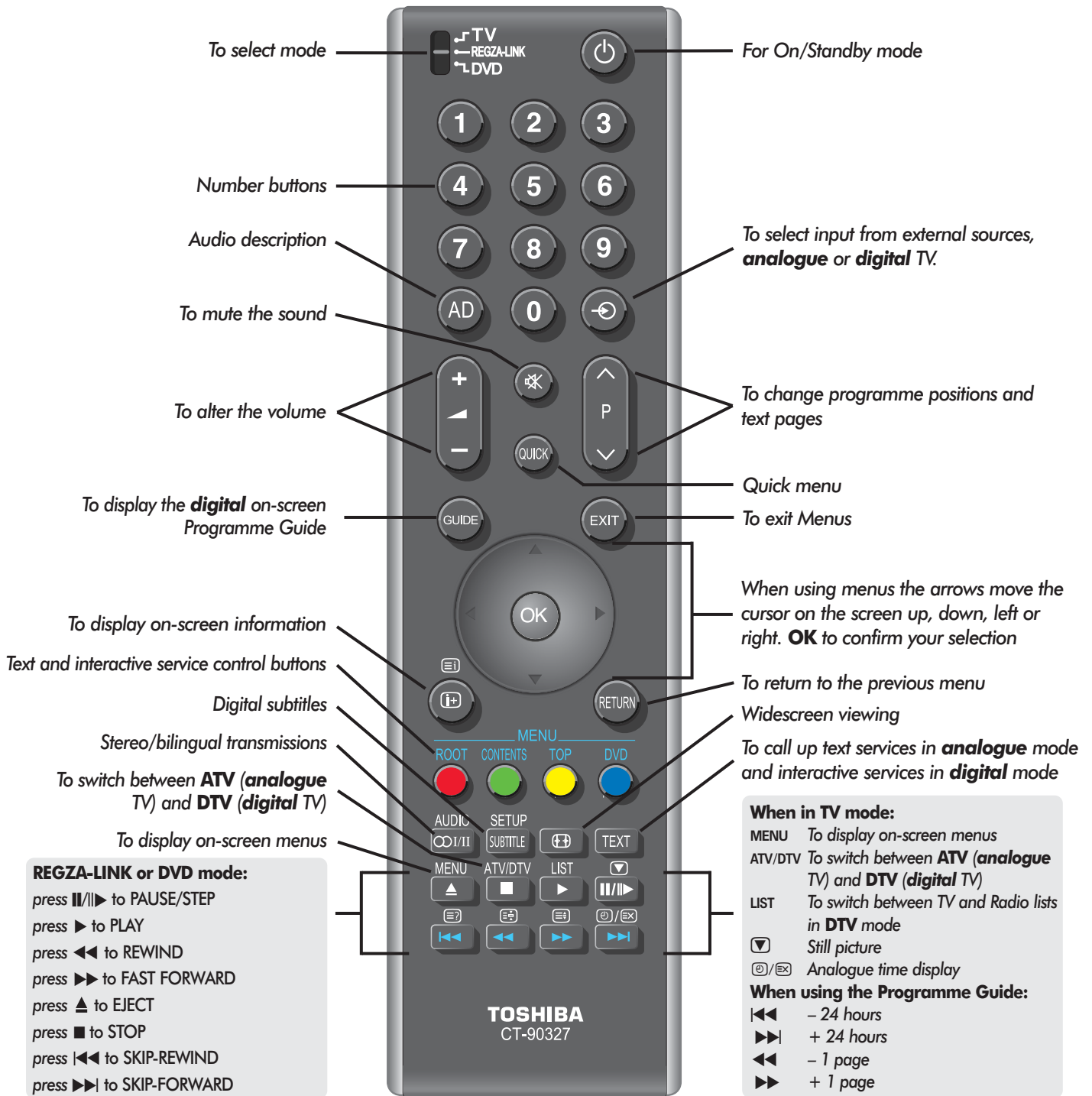

## Inserting batteries and effective range of the remote



Remove the back cover to reveal the battery compartment and make sure the batteries are inserted the right way round. Suitable battery types for this remote are AAA, IEC R03 1.5V.

Do not combine a used, old battery with a new one or mix battery types. Remove discharged batteries immediately to prevent acid from leaking into the battery compartment. Dispose of them in accordance with the disposal instructions in this manual. **Warning:** batteries must not be exposed to excessive heat such as sunshine, fire or the like.

The performance of the remote control will deteriorate beyond a distance of five metres or outside an angle of 30 degrees from the centre of the television. If the operating range becomes reduced the batteries may need replacing.

# Connecting external equipment

**Before connecting any external equipment, turn off all main power switches. If there is no switch remove the mains plug from the wall socket.**

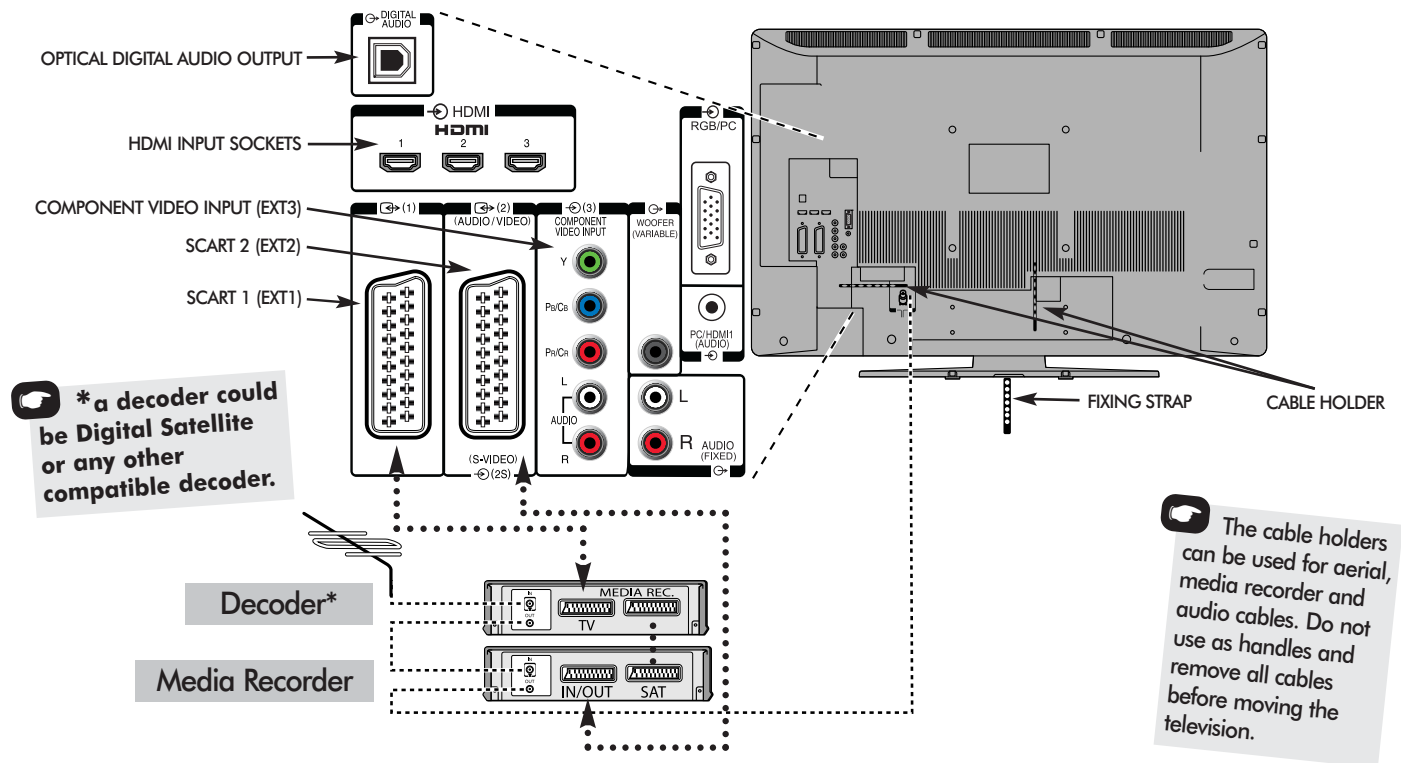

## Aerial cables:

Connect the aerial to the socket on the rear of the television. If you use a decoder\* and/or a media recorder it is essential that the aerial cable is connected through the decoder and/or through the media recorder to the television.

## SCART leads:

Connect the video recorder **IN/OUT** socket to the television. Connect the decoder **TV** socket to the television. Connect the media recorder **SAT** socket to the decoder **MEDIA REC.** socket.

Before running **Auto tuning** put your decoder and media recorder to **Standby**.

The phono sockets alongside the COMPONENT VIDEO INPUT sockets will accept L and R audio signals.

The Digital Audio Output socket enables the connection of a suitable surround sound system. **NOTE: this output is always active.**

HDMI (High-Definition Multimedia Interface) is for use with a DVD, decoder or electrical equipment with digital audio and video output. It is designed for best performance with 1080i and 1080p high-definition video signals but will also accept and display VGA, 480i, 480p, 576i, 576p and 720p signals.

**HDMI** HDMI, the HDMI logo and High-Definition Multimedia Interface are trademarks or registered trademarks of HDMI Licensing, LLC.

INSTAPORT™ and INSTAPORT logo are trademarks of Silicon Image, Inc. in the United States and other countries.

**PLEASE NOTE:** Although this television is able to connect to HDMI equipment it is possible that some equipment may not operate correctly.

**A wide variety of external equipment can be connected to the back of the television, therefore the relevant owners manuals for all additional equipment must be referred to.**

We recommend **SCART 1** for a decoder and **SCART 2** for a media recorder.

If connecting S-VIDEO equipment, set the **INPUT** for **EXT2**. See page 50.

If the television automatically switches over to monitor external equipment, return to normal television by pressing the desired programme position button. To recall external equipment, press **↺** to select between **TV, EXT1, EXT2, EXT3C, HDMI1, HDMI2, HDMI3, HDMI4** (Model dependant) or **PC**.

When the external input mode is selected whilst viewing DTV mode the SCART socket will not output video/audio signals. The SCART output will also be muted in EPG mode.



Manufactured under license from Dolby Laboratories.



Dolby and the double-D symbol are registered trademarks of Dolby Laboratories.



Manufactured under licence from Audyssey Laboratories U.S. and foreign patents pending. Audyssey EQ is a registered trademark of Audyssey Laboratories.

# REGZA-LINK connections

The basic functions of connected audio/video equipment can be controlled using the television's remote control if a REGZA-LINK compatible device is connected.

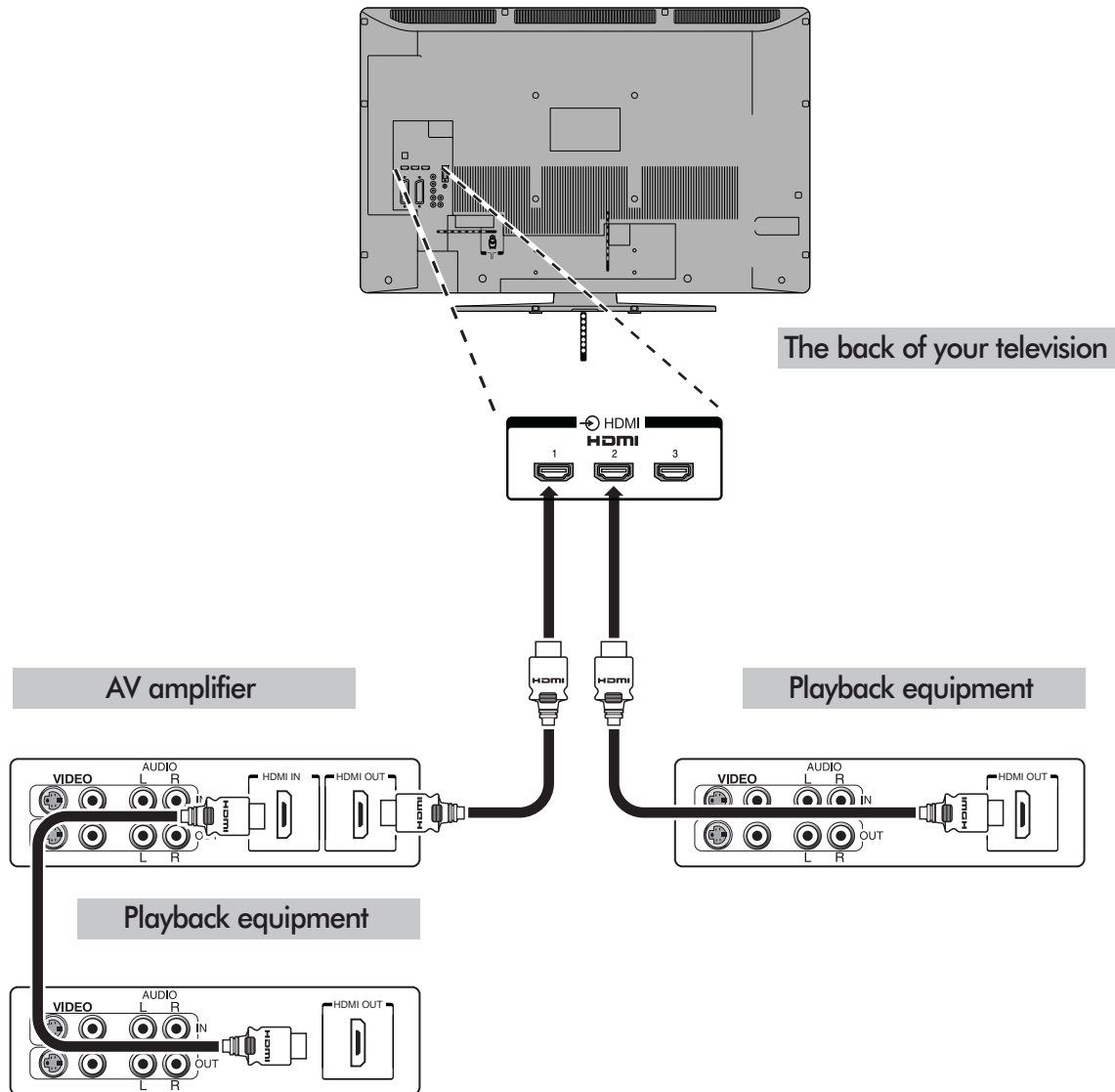

**NOTE:** It is recommended that for correct operation all audio/video devices are connected using HDMI cables branded with the HDMI logo (**HDMI**). If several devices are connected, the REGZA-LINK feature may not operate properly.

After connecting the equipment use the REGZA-LINK menus to setup the desired options. The connected equipment must also be set. For details see the operation manual for each connected device.

**NOTE:** The REGZA-LINK feature uses CEC Technology as regulated by the HDMI standard. This feature is limited to models incorporating Toshiba's REGZA-LINK. However, Toshiba is not liable for those operations. Refer to individual instruction manuals for compatibility information.



# Connecting an HDMI or DVI device to the HDMI input

The HDMI input on the television receives digital audio and uncompressed digital video from an HDMI source device, or uncompressed digital video from a DVI (Digital Visual Interface) source device.

This input is designed to accept HDCP (High-Bandwidth Digital-Content Protection) programme material in digital form from EIA/CEA-861-D-compliant [1] consumer electronic devices (such as a set-top box or DVD player with HDMI or DVI output). For acceptable signal formats, see page 11.

**NOTE:** Some early HDMI equipment may not work properly with the latest HDMI TV, due to the adoption of a new standard. Please unplug the HDMI cable first and then try setting the options in **HDMI Settings** to **Off**. See page 51.

Supported Audio format: Linear PCM, sampling rate 32/44.1/48kHz.

## Connecting an HDMI Device

Connect an HDMI cable (type A connector) to the HDMI terminal. For proper operation, it is recommended that an HDMI cable with the HDMI Logo ( **HDMI** ) is used.

If the HDMI connection is capable of 1080p and/or the television is capable of refresh rates greater than 60Hz, a Category 2 cable will be required. Conventional HDMI/DVI cable may not work properly with this mode.

HDMI cable transfers both video and audio. Separate analogue audio cables are not required. See "HDMI Audio" on page 51.

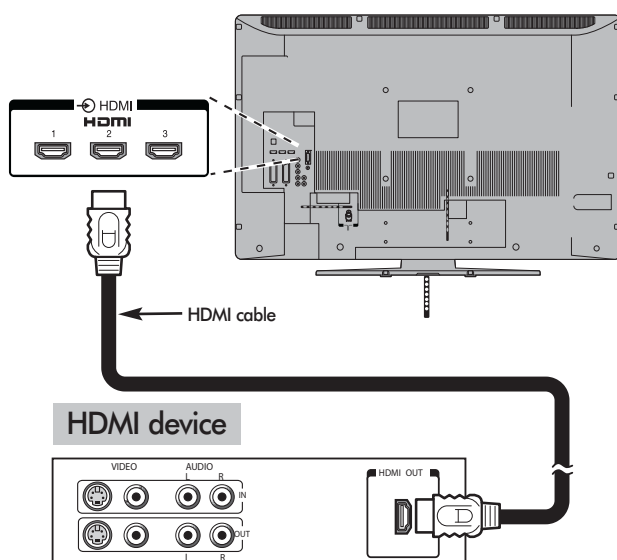

To view the HDMI device video, press the  to select HDMI1, HDMI2, HDMI3 or HDMI4 (Model dependant) mode.

## Connecting a DVI Device

Connect an HDMI-to-DVI adaptor cable (HDMI type A connector) to the HDMI1 terminal and audio cables to the HDMI1 (AUDIO) socket. The recommended HDMI-to-DVI adaptor cable length is 6.6 ft (2m).

An HDMI-to-DVI adaptor cable transfers video only. Separate analogue audio cables are required. See "HDMI Audio" on page 51.

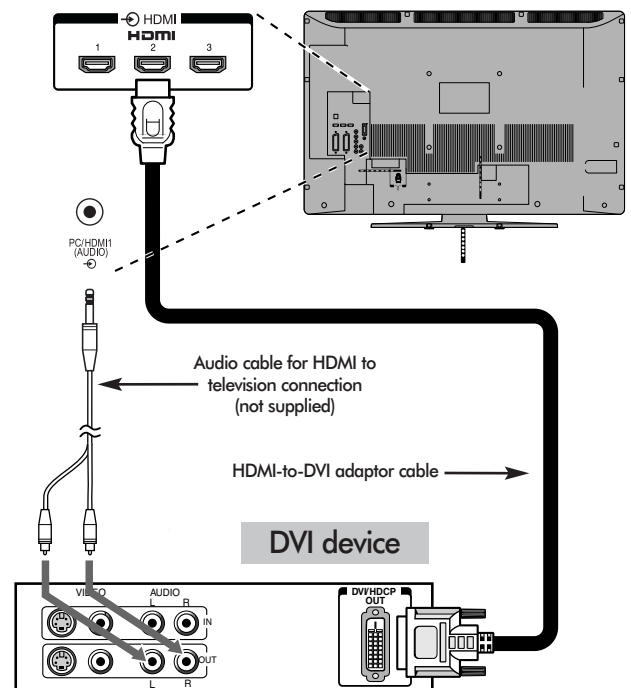

**NOTE:** To ensure that the HDMI or DVI device is reset properly, it is recommended that these procedures are followed:

When switching on electronic components, switch on the television first and then the HDMI or DVI device. To switch off, first switch off the HDMI or DVI device and then the television.

[1] EIA/CEA-861-D compliance covers the transmission of uncompressed digital video with high-bandwidth digital content protection, which is being standardised for reception of high-definition video signals. Because this is an evolving technology, it is possible that some devices may not operate properly with the television.

HDMI, the HDMI logo and High-Definition Multimedia Interface are trademarks or registered trademarks of HDMI Licensing, LLC. INSTAPORT™ and INSTAPORT logo are trademarks of Silicon Image, Inc. in the United States and other countries.

# Connecting a computer via HDMI

With the HDMI connection, you can watch your computer's display on the television and hear the sound from the television's speakers.

## Connecting a PC to the HDMI Terminal

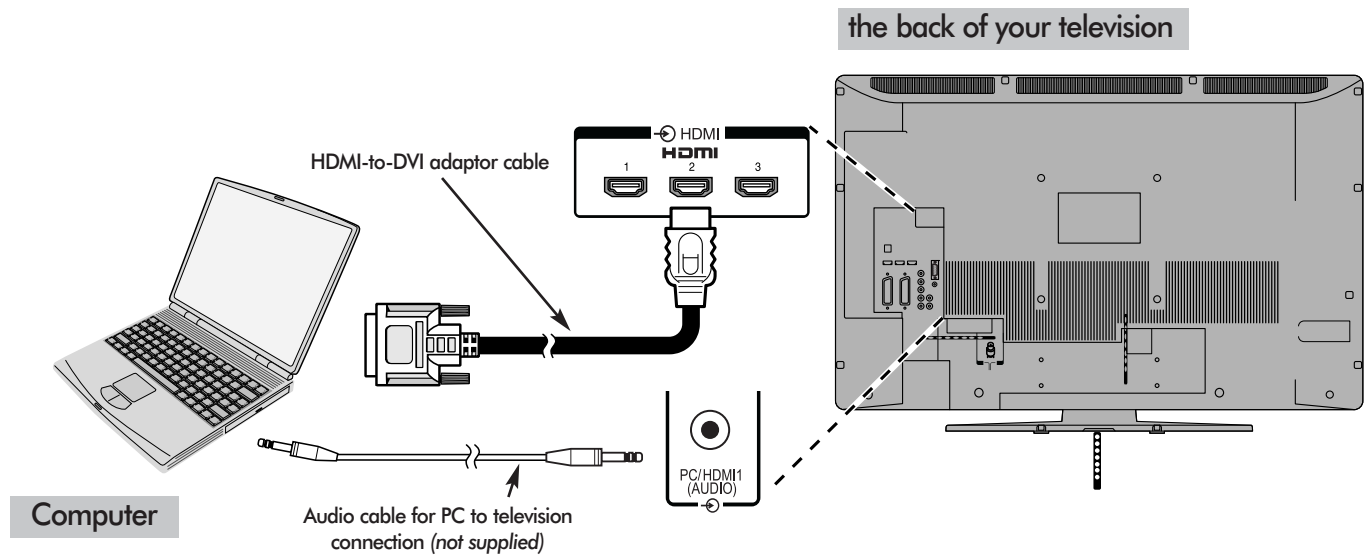

When connecting a PC to the HDMI terminal on the television, use an HDMI-to DVI adaptor cable and an analogue audio cable.

If connecting a PC with an HDMI terminal, use an HDMI cable (type A connector). A separate analogue audio cable is not necessary). See page 9.

### PLEASE NOTE:

It is possible that some PCs when connected may not display correctly. Some PC models cannot be connected to this television.

A band may appear at the edges of the screen or parts of the picture may be obscured. This is due to scaling of the picture by the set, it is not a malfunction.

# Acceptable signals through HDMI terminals

The HDMI inputs on this television only accept VGA, SVGA, XGA, WXGA and SXGA signal formats which are compliant with VESA as shown in the table below.

The input signals for some PCs and HDMI or DVI devices are different from the resolution and frequencies listed and this may cause the following; incorrect display, false format detection, picture position failure, blur or judder. These problems may be resolved by setting the monitor output format on the PC, HDMI or DVI device to conform to any of the signals listed in the table.

Format	Resolution	V. Frequency	H. Frequency	Pixel Clock Frequency	VESA Standard
480i	720 X 480i	59.940/60.000Hz	15.734/15.750kHz	27.000/27.027MHz	
576i	720 X 576i	50.000Hz	15.625kHz	27.000MHz	
480p	720 X 480p	59.940/60.000Hz	31.469/31.500kHz	27.000/27.027MHz	
576p	720 X 576p	50.000Hz	31.250kHz	27.000MHz	
1080i	1920 X 1080i	59.940/60.000Hz	33.716/33.750kHz	74.176/74.250MHz	
1080i	1920 X 1080i	50.000Hz	28.125kHz	74.250MHz	
720p	1280 X 720p	59.940/60.000Hz	44.955/45.000kHz	74.176/74.250MHz	
720p	1280 X 720p	50.000Hz	37.500kHz	74.250MHz	
1080p	1920 X 1080p	59.940/60.000Hz	67.433/67.500kHz	148.352/148.500MHz	
1080p	1920 X 1080p	50.000Hz	56.250kHz	148.500MHz	
1080p	1920 X 1080p	24.000Hz	27.000kHz	74.250MHz	
VGA	640 X 480	59.940/60.000Hz	31.469/31.500kHz	25.175/25.200MHz	●
		72.809Hz	37.861kHz	31.500MHz	●
		75.000Hz	37.500kHz	31.500MHz	●
SVGA	800 X 600	56.250Hz	35.156kHz	36.000MHz	●
		60.317Hz	37.879kHz	40.000MHz	●
		72.188Hz	48.077kHz	50.000MHz	●
		75.000Hz	46.875kHz	49.500MHz	●
XGA	1024 X 768	60.004Hz	48.363kHz	65.000MHz	●
		70.069Hz	56.476kHz	75.000MHz	●
		75.029Hz	60.023kHz	78.750MHz	●
WXGA	1280 X 768	59.995Hz	47.396kHz	68.250MHz	●
		59.870Hz	47.776kHz	79.500MHz	●
		74.893Hz	60.289kHz	102.250MHz	●
	1360 X 768	60.015Hz	47.712kHz	85.500MHz	●
SXGA	1280 X 1024	60.020Hz	63.981kHz	108.000MHz	●
		75.025Hz	79.976kHz	135.000MHz	●

# Connecting a computer via RGB/PC

**Before connecting any external equipment, turn off all main power switches. If there is no switch remove the mains plug from the wall socket.**

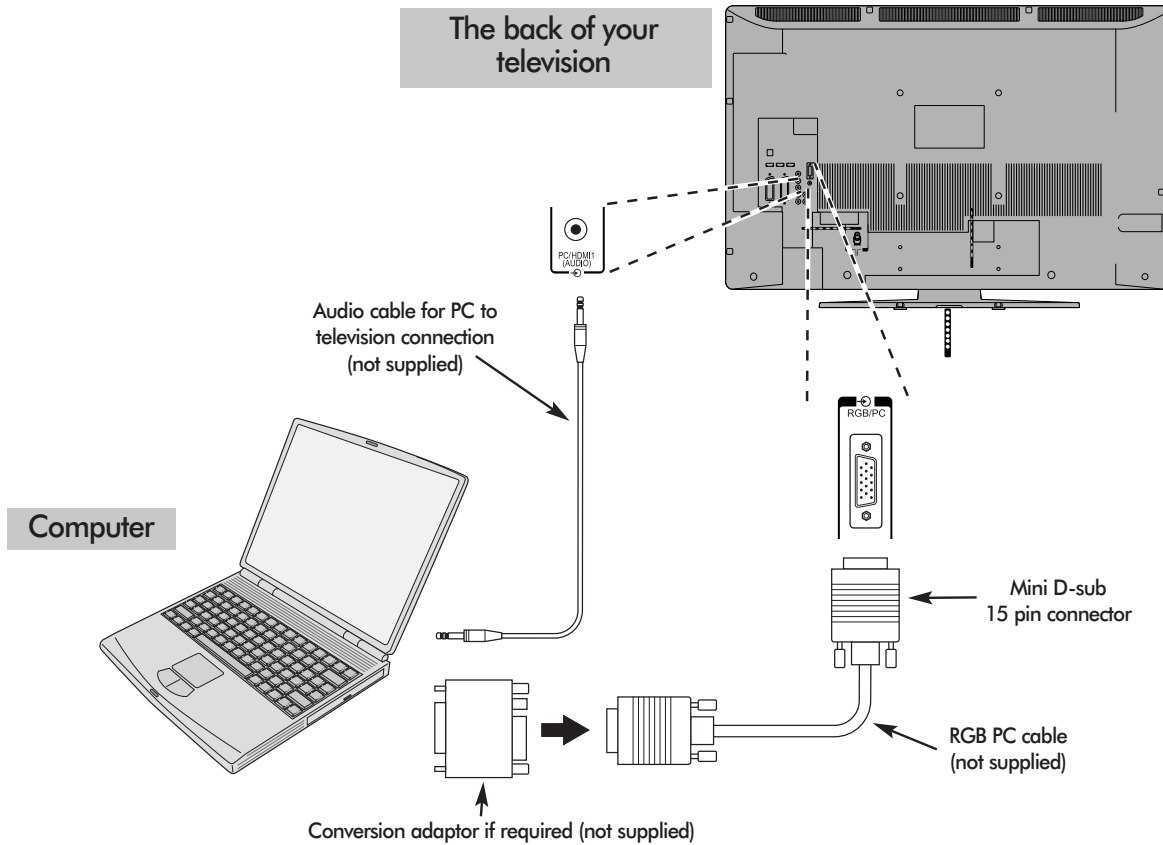

Connect the PC cable from the computer to the PC terminal on the back of the television, then the audio cable to the PC/HDMI1 Audio socket on the back of the television. Select **PC** from the **PC/HDMI1 Audio** options in the **AV connection** menu located in the **SET UP** menu.

Press the to select PC mode.

**IMPORTANT NOTE:** Some PCs when connected they may not display correctly.

**PLEASE NOTE:**

Some PC models cannot be connected to this television.

An adaptor is not needed for computers with a DOS/V compatible mini D-sub 15 pin terminal.

A band may appear at the edges of the screen or parts of the picture may be obscured. This is due to scaling of the picture by the set, it is not a malfunction.

When PC input mode is selected some of the television's features will be unavailable e.g. **Manual setting** in the **SET UP** menu, **Colour**, **Tint**, **DNR** and **Black/White Level** in the **PICTURE** menu.

Pin assignment for RGB/PC terminal

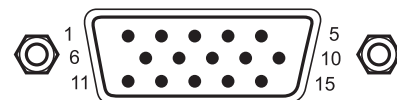

Signal information for Mini D-sub 15 pin connector

Pin No.	Signal name	Pin No.	Signal name
1	R	9	NC
2	G	10	Ground
3	B	11	NC
4	NC (not connected)	12	NC
5	NC	13	H-sync
6	Ground	14	V-sync
7	Ground	15	NC
8	Ground		

# Acceptable PC signals through the PC terminal

The PC input on this television only accepts signal formats which are compliant with VESA-DMT as shown in the table below.

Some PCs input signals are different from the resolution and frequencies listed and this may cause the following; incorrect display, false format detection, picture position failure, blur or judder. These problems may be resolved by setting the monitor output format on the PC to conform to any of the signals listed in the table.

Format	Resolution	V. Frequency	H. Frequency	Pixel Clock Frequency	VESA Standard (DMT)
VGA	640 X 480	59.940Hz	31.469kHz	25.175MHz	●
		72.809Hz	37.861kHz	31.500MHz	●
		75.000Hz	37.500kHz	31.500MHz	●
SVGA	800 X 600	56.250Hz	35.156kHz	36.000MHz	●
		60.317Hz	37.879kHz	40.000MHz	●
		72.188Hz	48.077kHz	50.000MHz	●
		75.000Hz	46.875kHz	49.500MHz	●
XGA	1024 X 768	60.004Hz	48.363kHz	65.000MHz	●
		70.069Hz	56.476kHz	75.000MHz	●
		75.029Hz	60.023kHz	78.750MHz	●
WXGA	1280 X 768	59.995Hz	47.396kHz	68.250MHz	●
		59.870Hz	47.776kHz	79.500MHz	●
		74.893Hz	60.289kHz	102.250MHz	●
	1360 X 768	60.015Hz	47.712kHz	85.500MHz	●
SXGA	1280 X 1024	60.020Hz	63.981kHz	108.000MHz	●
		75.025Hz	79.976kHz	135.000MHz	●



# Using the Controls

Whilst all the necessary adjustments and controls for the television are made using the remote control, the buttons on the television may be used for some functions.

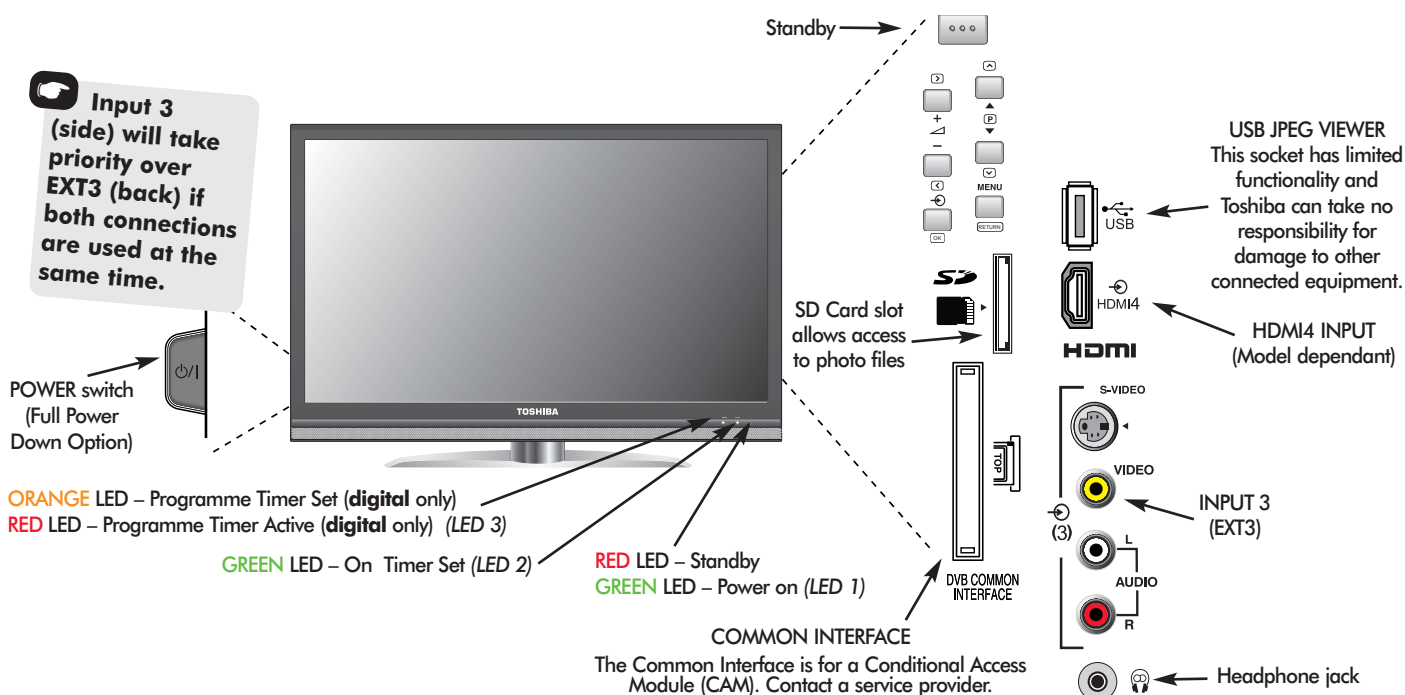

## Switching On

If the **RED** LED is unlit check that the mains plug is connected to the power supply and press the **POWER** button on the left side of the television. If the picture does not appear press **POWER** on the remote control, it may take a few moments, the **GREEN** LED will be lit.

To put the television into Standby press **POWER** on the remote control. To view the television press **POWER** again. The picture may take a few seconds to appear.

**NOTE:** When the television is put into standby it will automatically search for updates if **Auto Channel Update** has been activated.

When the **POWER** switch is turned off, the digital channel position you previously viewed may not be memorised in the television memory.

## Using the Remote Control

Press the **MENU** button on the remote control to see the menus.

The menu appears as a list of five topics. As each symbol is selected by pressing **LEFT** or **RIGHT** on the navigation ring on the remote control, its respective options will appear below.

**IMPORTANT:** At the bottom of the screen will be a bar displaying a selection of control functions, i.e. Select, Watch, Back, Watch TV.

**NOTE:** The same menu is displayed in **DTV** (Digital TV) and **ATV** (Analogue TV) modes, however, where some items are not available in a mode they will appear greyed out.

To use the options press the **UP** and **DOWN** button on the remote control to move up and down through them and **OK**, **LEFT** or **RIGHT** to select the required choice. Follow the on screen instructions. The functions of each menu are described in detail throughout the manual.

## Using the Controls

To alter the volume press **MIN** **+**.

To alter the programme position press **DOWN** **PAUSE** **UP**.

Press **MENU** and **LEFT**, **RIGHT**, **DOWN** or **UP** to control the sound and picture options. Press **MENU** to finish.

When connecting sound equipment to **EXT3**, connect the audio output of the equipment to the phono sockets on the television.

To select the external input, press **INPUT** and select the required input source. See page 50.

*Please always refer to the owner's manual of the equipment to be connected for full details.*









**NOTE:** Interactive video games that involve shooting a 'gun' type of joystick at an on-screen target may not work with this television.

# Tuning the television for the first time





Before switching on the television put your decoder and media recorder to **Standby** if they are connected and ensure the aerial is connected. To set up the television use the buttons on the remote control as detailed on page 6.

- 1 Press the  button, the **Quick Setup** screen will appear. This screen will appear the first time that the television is switched on and each time **Reset TV** is selected.

Quick Setup	
Menu Language	English
Country	UK
Primary Subtitle Language	English
Secondary Subtitle Language	English
Primary Audio Language	English
Secondary Audio Language	English

- 2 Using  highlight **Menu Language**, then  or  to select.
- 3 Press  to highlight **Country** and  or  to select. The television will now tune the stations for your country. Press **OK**.
- 4 The **Location** screen will appear, press  or  to select between **Home** or **Store** (for normal home use select **Home**) then press **OK**.

If **Home** is selected the **AutoView** option will be activated, automatically adjusting the picture setting to the current viewing conditions. In most cases the television will then operate with lower energy consumption.







- 5 If the **Ant/Cable In** screen appears, press  or  to select between **Antenna** or **Cable** then press **OK**.
- 6 The **Auto Tuning** start up screen will appear with the option to select between **DTV and ATV**, **DTV** or **ATV**. Using  or  select **DTV and ATV** then press  to highlight **Start Scan**.
- 7 Press **OK** again to start **Auto Tuning**. The television will start to search for all available **DTV** and **ATV** stations. The progress bar will indicate progress.



**You must allow the television to complete the search.**

Auto Tuning	
	Progress Found
DTV Tune	75%  80
ATV Tune	Waiting...
Channel: C58	

When the search is complete the television will automatically select position one.

The **Auto Tuning** screen will display the total number of services found.

Auto Tuning			
DTV Services Found: 90		ATV Services Found: 4	
DTV	ATV		
Type	Pos.	Name	CH
	1	BBC ONE	34
	2	BBC TWO	34
	3	ITV1	31
	4	Channel 4	31
	5	FIVE	48
	6	ITV2	31
	7	BBC THREE	34

- 8 Press  or  to view the **DTV** (digital channels) or **ATV** (analogue channels) lists.

Auto Tuning			
DTV Services Found: 90		ATV Services Found: 4	
DTV	ATV		
Pos.	Name		CH
0	VCR		C60
1	BBC ONE		C22
2	BBC TWO		C28
3	ITV		C25
4	CH4		C32

- 9 Use  or  to move through the list to select a channel then press **EXIT** to view.

In **ATV** mode some areas may receive duplicate stations. There may not be a clear picture or the signal may be weak, so the station order can be changed using **ATV Manual Tuning**.

**NOTE:** The time will be set automatically by transmission but can be advanced or decreased using **Local Time Setting** in the **DTV Settings** screen.

## PLEASE NOTE

The **Reset TV** menu can also be accessed at any time from the **SETUP** menu.

# Setting Antenna or Cable

## Ant/Cable In (if available)

If this feature is available the television can be configured to either **Antenna** or **Cable**. If the setting is changed the **Auto Tuning** screen will automatically appear (if a Pin Code has been set this will have to be entered in order to change the setting). All current programmes and settings will be lost.

- 1 Press **MENU** and use ◀ or ▶ to select **SETUP**. Use ▼ to highlight **Ant/Cable In**.

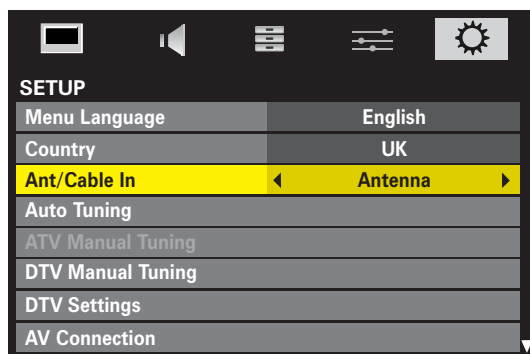

- 2 Press ◀ or ▶ to select **Antenna** or **Cable**.

A screen will appear warning that the television's features will be changed.

The **Auto Tuning** screen will appear. When **Cable** has been selected the **Auto Tuning** screen will show setting options.

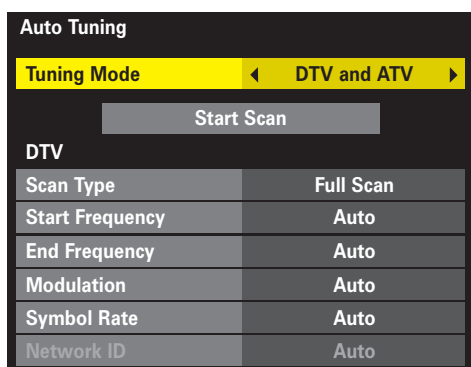

With the exception of **Scan Type** and **Modulation**, all of the settings have two options:

**Auto** – values are pre-set by the television's operating system.

**Input** – allows a single value to be entered in place of the pre-set value. If no channel is currently tuned and **Input** is chosen a system default value will be displayed. If a channel is currently tuned and **Input** is chosen the value of the channel will be displayed.

### Scan Type

There are two options, Full Scan and Quick Scan. Quick Scan is a simplified version of Full Scan and takes less time to complete.

### Start Frequency

This sets the frequency from which the scan will start.

### End Frequency

This sets the frequency at which the scan will stop.

The valid entry range for frequency items is 113.000-858.000 for C-Book/Other and 114.000-858.000 for Nordig-C. If numbers outside of this range are entered the values will automatically set to the minimum or maximum valid values.

### Modulation

There are five QAM modulation settings to choose from.

### Symbol Rate

This is the Baud rate (KS/s) of the scan.

The valid entry range for **Symbol Rate** is 4000-7200. If a number outside of this range is entered the value will automatically set to the minimum or maximum valid value.

### Network ID

This is the **Network ID** to be used for the scan. This item is greyed out when the Scan Type is set to **Full Scan**.

The valid entry range for **Network ID** is 1-65535. If a number outside of this range is entered the value will automatically set to the minimum or maximum valid value.

- 3 When the options have been set use ▼ or ▲ to highlight **Tuning Mode**, then press ◀ or ▶ to select between **DTV and ATV**, **DTV** or **ATV**.

- 4 Press ▼ to highlight **Start Scan**, then press **OK**.

# DTV auto tuning, manual tuning, manual tuning for DVB-C

**NOTE:** As new services are broadcast it will be necessary to re-tune the television in order to view them.

## Auto Tuning

**Auto tuning** will completely re-tune the television and can be used to up date the channel list.

**It is recommended that DTV Auto tuning is run periodically to ensure that new services are added.**

*All current programmes and settings, i.e. locked programmes, will be lost.*

- 1 Press **MENU** and use ◀ or ▶ to select **SETUP**. If available use ▼ to highlight **Ant/Cable In** and then ◀ or ▶ to select **Antenna** or **Cable**.
- 2 Use ▼ to highlight **Auto Tuning**. Press **OK**.

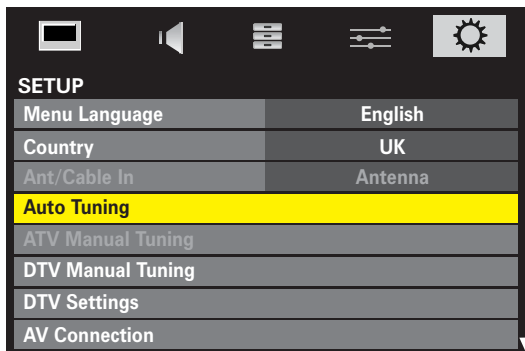

A screen will appear warning that previous digital channels and settings will be deleted.

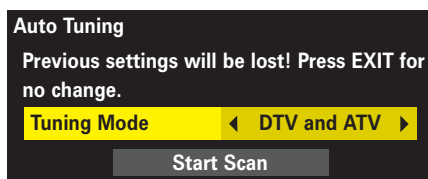

- 3 Use ◀ or ▶ to select **DTV** then press ▼ to select **Start Scan**, press **OK** to start **Auto tuning**.

The television will start to search for all available **DTV** stations.

**You must allow the television to complete the search.**

When the search is complete the **Auto Tuning** screen will display the services found.

- 4 Use ▼ or ▲ to move through the list to select a channel then press **OK** to view.

## Manual Tuning

*This feature is available for service engineers or can be used for direct channel entry if the multiplex channel is known.*

- 1 Select **DTV Manual Tuning** from the **SETUP** menu and press **OK**.
- 2 Enter the multiplex number using the number buttons or use ◀ or ▶ to adjust the number and then press ▼ to select **Start Scan**, press **OK**. The television will automatically search for that multiplex.

When the multiplex is found any channels not currently on the channel list will be added and the channel information at the top of the screen will be updated.

- 3 Repeat as necessary. Press **EXIT** to finish.

## Manual Tuning for DVB-C

When **Ant/Cable In** is set to **Cable**, **DTV Manual Tuning** will display the following information:

**Frequency** – a specific frequency can be input for scanning.

**Modulation** – select from five QAM modulation options.

**Symbol Rate** – A specific baud rate (KS/s) can be input for manual scanning.

# DTV location, auto channel update, DVB character set, Analogue switch off

## Location

There are two options available **Home** and **Store**. **Store** is for use when a television is being used for display, i.e. in shops etc. **Home** is recommended for normal home use.

- 1 Press **MENU** and use ◀ or ▶ to select **SETUP**.
- 2 Use ▼ to highlight **Location**.

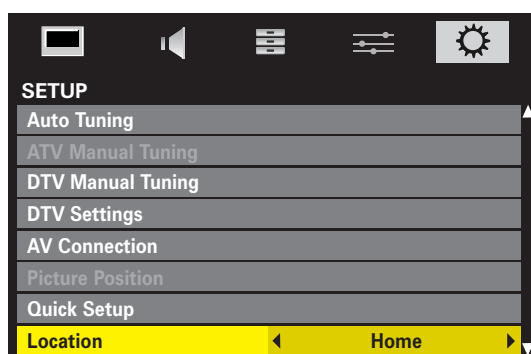

- 3 Use ◀ or ▶ to select **Home** or **Store**.

When **Home** is selected the **AutoView** option will be activated, automatically adjusting the picture setting to the current viewing conditions. In most cases the television will then operate with lower energy consumption.

## Auto Channel Update

If **Auto Channel Update** is set to **On** when the television is in standby mode Digital Tuning will automatically execute and new channels will be stored.

- 1 Press **MENU** and use ◀ or ▶ to select **SETUP**.
- 2 Use ▼ to highlight **DTV Settings** and press **OK**.

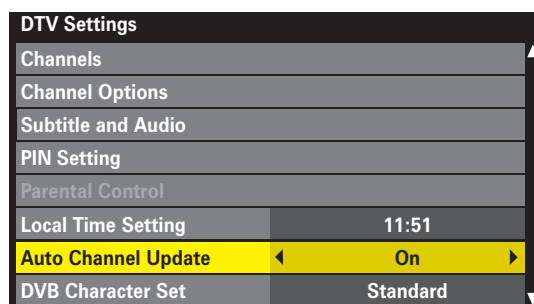

- 3 Press ▼ to select **Auto Channel Update** and use ◀ or ▶ to select **On**.

## DVB Character Set

The character set to be used for DVB-C or DVB-T channels can be set manually (**Standard** – Table 0 or **Western** – Table 5).

- 1 In the **SETUP** menu press ▼ to highlight **DTV Settings** and press **OK**.

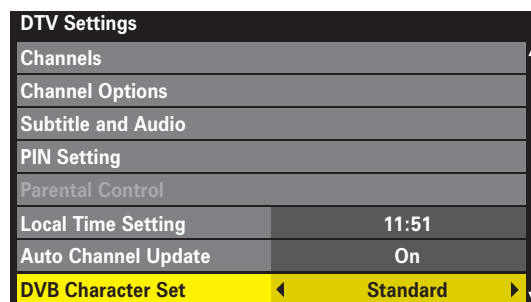

- 2 Press ▼ to select **DVB Character Set** and use ◀ or ▶ to select between **Standard** or **West**.

## Analogue Switch-off

This is a **digital** television which is integrated to allow the use of both **digital** and **analogue** services. However, during the lifetime of this set it is very likely that **analogue** services will be switched off to allow for more new **digital** services.

This 'switch-off' will happen in a number of phases, which will be advertised in your area well in advance. It is recommended that at each phase the television is re-tuned to ensure that existing and new **digital** services can be viewed without disruption.



# DTV sorting channels, skipping channels

**NOTE:** When the television is switched off the mode being viewed at the time will automatically be selected when the television is switched back on.

## Sorting Channels

The channel order may be changed to suit personal preference.

- 1 Press **MENU** and select the **SETUP** menu.
- 2 Use **▼** to move down through the list and highlight **DTV Settings**. Press **OK**.

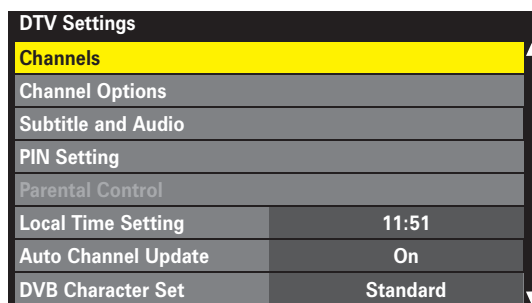

- 3 Use **▼** to select **Channels** then press **OK**.
- 4 With the list of channels now showing use **▼** or **▲** to highlight the station to be moved and press **OK**.

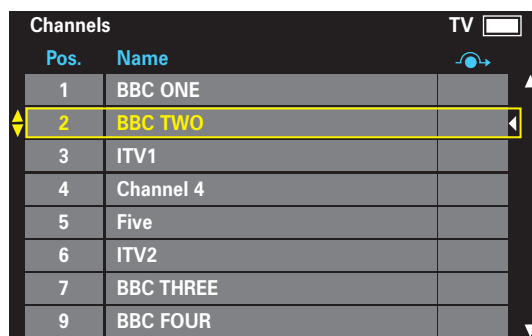



- 5 Use **▼** or **▲** to move through the list to the preferred position, the other channels will move to make room.
- Press **OK** to store the move. repeat as necessary then press **EXIT**.

## Skipping Channels

This feature allows the setting of channels that will be skipped when using **P▼** and **P▲**. However, skipped channels can still be accessed by direct number entry.

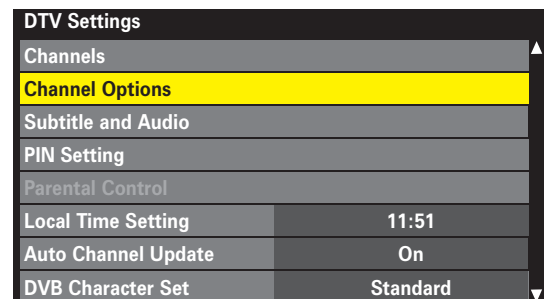
- 1 Press **MENU** and select the **SETUP** menu.
- 2 Use **▼** to move down through the list and highlight **DTV Settings**. Press **OK**.



- 3 Use **▼** to select **Channel Options** then press **OK**.
- 4 Use **▼** to select the channel to be skipped. Press **▶** repeatedly to select . Press **OK**, a tick will appear in the box to show that the channel has now been 'skipped'.



Repeat step 4 as necessary then press **EXIT**.

The selected channels will no longer be available when using **P▲** and **P▼** on the remote control.

# ATV manual tuning

The television can be tuned-in manually using **ATV Manual Tuning**. For example: if the television cannot be connected to a media recorder/decoder with a SCART lead or to tune-in a station on another **System**.

Use ◀ and ▶ to move across the screen and select any of these ATV Manual Tuning options, then ▲ and ▼ to adjust the settings.

Position	System	Colour System	Skip	Signal Class	Channel	Search	Manual Fine Tuning	Station

**Position:** The number to be pressed on the remote control.  
**System:** Specific to certain areas.  
**Colour System:** Factory set to Auto, should only be changed if problems are experienced, *i.e.* NTSC input from external source.  
**Skip:** ⏭ means nothing has been stored or the facility to *skip* the channel is ON. See page 21.  
**Signal Class:** C for standard terrestrial channels, S for cable channels  
**Channel:** The channel number on which a station is being broadcast.  
**Search:** Search up and down for a signal.  
**Manual Fine Tuning:** Only used if interference/weak signal is experienced. See page 54.  
**Station:** Station identification. Use the ▲ or ▼ and ◀ or ▶ buttons to enter up to seven characters.

To allocate a position on the television for a decoder and media recorder: turn the decoder on, insert a pre-recorded film in the media recorder and press PLAY, then manually tune.

- 1 Select **ATV** using **ATV/DTV**. Press **MENU** and use ◀ or ▶ to select the **SET UP** menu, with ▼ highlight **ATV Manual Tuning**, press **OK** to select.

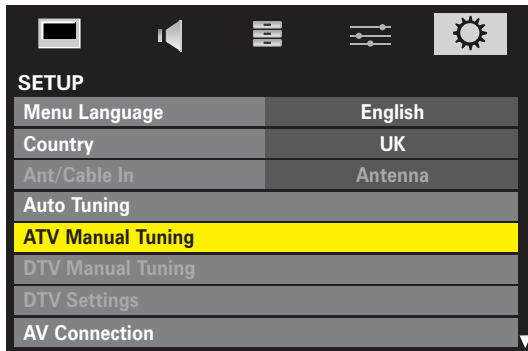

- 2 Use ▲ or ▼ to highlight the position required e.g. we suggest **Pos. 0** for a media recorder.

Pos.	Channel	Station
0	C60	
1	C22	BBC1
2	C28	BBC2
3	C25	ITV
4	C32	CH4
5	⏭ C69	
6	⏭ C69	
7	⏭ C69	

Different Channel numbers may be displayed

- 3 Press **OK** to select. If the position is skipped, **Skip** must be removed before storing.

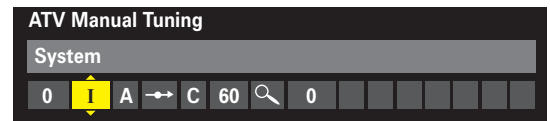

- 4 Press ▶ to select **System** and use ▲ or ▼ to change if required.

- 5 Then press ▶ to select **Search**.

- 6 Press ▲ or ▼ to begin the search. The search symbol will flash.

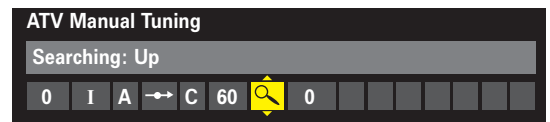

- 7 Each signal will show on the television, if it is not your media recorder, press ▲ or ▼ again to restart the search.

- 8 When your media recorder signal is found, press ▶ to move along to **Station**. With ▲, ▼, ◀ and ▶ put in the required characters, e.g. **VCR**.

# ATV manual tuning (continued), skipping channels, sorting channel positions

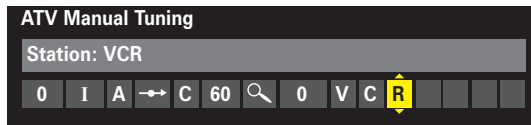

- 9 Press **OK** to store.
- 10 Repeat for each **programme position** you want to tune or, press **MENU** to return to the list of channels and select the next number to tune.
- 11 Press **EXIT** when you have finished.
- 12 To name external equipment, e.g. DVD on EXT2, press **↻** to select **↻2**, then select **Manual Settings** from the **SET UP** menu.
- 13 Press **▶** to select **Label** then using **▲**, **▼**, **◀** and **▶** put in the required characters. Press **OK**.

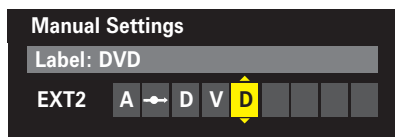

## PLEASE NOTE

This television has direct channel entry if the channel numbers are known. Select the **ATV Manual Tuning** screen in **Step 3**. Enter the **Programme number**, the **System**, then **C** for standard (terrestrial) channels or **S** for cable channels and the **Channel** number. Press **OK** to store.

## Skipping Channels

To prevent certain programmes from being viewed, the channel position can be skipped. The remote control must be removed as the channels will still be available using the number buttons. Programmes can then be watched as normal using the controls on the television, but the television will not show the skipped channel position.

- 1 Select **ATV Manual Tuning** from the **SET UP** menu.

Pos.	Channel	Station
2	C28	BBC2
3	C25	ITV
4	C32	CH4
5	↻ C69	
6	↻ C69	
7	↻ C69	
8	↻ C69	
9	↻ C69	

- 2 Use **▲** or **▼** to highlight the channel position to be skipped and press **OK** to select.

- 3 Press **▶** to select **Skip**.

- 4 Use **▲** or **▼** to turn **Skip** on. Press **OK**.

↻ on the screen indicates a skipped channel position.

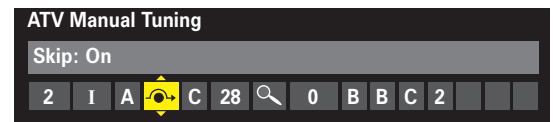

- 5 Press **MENU** and repeat from **Step 2** or press **EXIT**.

Each channel position has to be *individually* selected. To turn **Skip** off, repeat the procedure for each position.

Skipped channel positions **cannot** be selected by **P▲** and **P▼** or by the controls on the television, but **can** still be accessed by the number buttons on the remote control.

## Sorting Channel Positions

Channels may be moved and stored on the position of your choice.

- 1 Select **ATV Manual Tuning**.
- 2 With the list of channels showing use **▼** or **▲** to highlight the channel to be moved and press **▶**.

Pos.	Channel	Station
1	C22	BBC1
4	C32	CH4
2	C28	BBC2
3	C25	ITV
5	↻ C69	
6	↻ C69	
7	↻ C69	
8	↻ C69	



- 3 Use **▼** or **▲** to move through the list to your preferred position. As you do so the other channels will move to make room.

- 4 Press **◀** to store your move. Repeat as necessary, then press **EXIT**.

# General controls, stereo/bilingual transmissions, time display (**ATV** only), sound controls, quick menu

## Selecting Programme Positions

To select a programme position use the numbered buttons on the remote control.

Programme positions can also be selected using **P**  and **P** .

To display on-screen information i.e. programme position, channels, stereo/mono signal, signal strength, date and time, press . Press again to cancel. The information shown will vary depending on whether the television is in **DTV** or **ATV** mode.

Press **ATV/DTV** at any time to select between **DTV TV**, **DTV RADIO**, **DTV TEXT** and **ATV** modes.

## Stereo and Bilingual Transmissions

*If stereo or dual language broadcasts are transmitted the word Stereo or Dual will appear on the screen each time programme positions are changed, disappearing after a few seconds. If the broadcast is not in stereo the word Mono will appear.*

### For ATV programmes







**Stereo...** Press /II to select **Stereo** or **Mono**.

**Bilingual...** Bilingual transmissions are rare. If they are transmitted the word **Dual** will display. Choose the required programme number and if the word **Dual** appears press /II to select **Dual 1**, **Dual 2** or **Mono**.

### For DTV programmes



For stereo or dual mono broadcasts, press /II and use  or  to select settings.

The settings are as follows:

-  Stereo      Press  for Stereo → Left → Right
-  Dual Mono      Press  for Dual 1 → Dual 2 → Dual
-  Mono
-  Multichannel

## Time Display (**ATV** only)

*The time display facility allows the current (text service) time to be seen on the television screen.*

Press /  whilst watching a normal television broadcast to see a time display from the broadcaster. It will remain on screen for about 5 seconds.

NOTE: This display may not always be available.

## Sound Controls

### Volume

Press  or  to adjust the volume.

### Sound Mute

Press  once to turn the sound off and again to cancel.

## Quick Menu

The **Quick Menu** gives fast access to various features, i.e. **Picture Mode**, **Picture Size**, **Sleep Timer**, **Media Player** etc.

The availability of the various features is dependant on the current mode and input source.

To access the **Quick Menu**, press **QUICK** then use , ,  and  to select the features and to select options.

# Sound settings – dual, bass, treble and balance, advanced sound settings, Dolby Volume®

## Dual

If a programme or film is being broadcast with a soundtrack in more than one language, the **DUAL** feature allows selection between them.

- 1 Select the **SOUND** menu.
- 2 Use ▼ to highlight **Dual** then press ◀ or ▶ to choose between **Dual 1** or **Dual 2**.

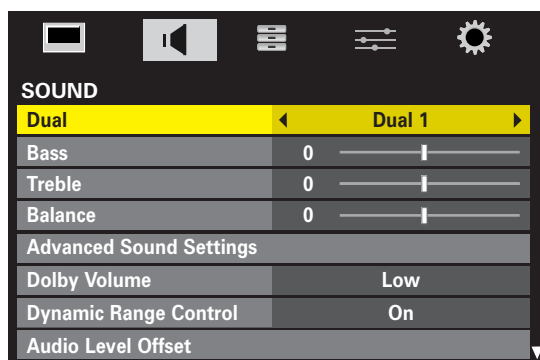

## Bass, Treble and Balance

The **Bass**, **Treble** and **Balance** can be individually set to personal preference.

- 1 Press **MENU** and ◀ or ▶ to select **SOUND**.
- 2 Press ▼ or ▲ to highlight **Bass**, **Treble** or **Balance** and ◀ or ▶ to change the setting.

## Advanced Sound Settings

The **Surround**, **Voice Enhancement** and **Dynamic Bass Boost/Ext. Woofer** features in the **Advanced Sound Settings** help to create an intense pseudo surround sound experience, making the television's audio sound richer and fuller.

- 1 In the **SOUND** menu select **Advanced Sound Settings** then press **OK**.

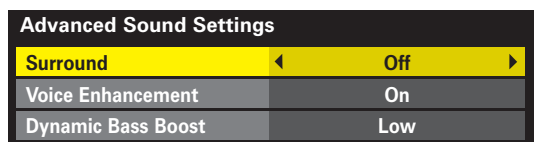

- 2 Use ▼ to highlight **Surround** then press ◀ or ▶ to select **Off**, **Spatial** or **Cinema**.
- 3 Use ▼ to highlight **Voice Enhancement** then press ◀ or ▶ to select **On** or **Off**.
- 4 Use ▼ to highlight **Dynamic Bass Boost** then press ◀ or ▶ to select **Low**, **High** or **Off**.

**NOTE:** If an active Super Woofer is connected to the Woofer Out connection on the back of the television, select **AV connection** in the **SET UP** menu, press ▼ to highlight **Woofer** and using ◀ or ▶ select **External**. (See 'Input Selection and AV Connections' section). The **Dynamic Bass Boost** settings are then replaced by **Ext. Woofer** settings.

## Dolby Volume®

The **Dolby Volume** feature gives a high quality sound and keeps the volume coming from the TV speakers consistent when changing programmes, channels and input sources.

- 1 In the **SOUND** menu use ▼ to highlight **Dolby Volume**.
- 2 Press ◀ or ▶ to select **Low**, **High** or **Off**.

**NOTE:** The **Dolby Volume** setting influences the **Dynamic Range Control** and **Digital Audio Output** settings.

If **Dynamic Range Control** is set to **On** this feature will be unavailable.

**AUDYSSEY**<sub>EQ</sub>

Manufactured under licence from Audyssey Laboratories U.S. and foreign patents pending. Audyssey EQ is a registered trademark of Audyssey Laboratories.

Audyssey EQ is based on the award-winning Audyssey MultiEQ technology. It is the first-ever room equalisation solution that can achieve optimum sound for a large listening area and it is featured in many high end home theatre products. Audyssey EQ is used in the TV tuning process to calculate an equalization solution that corrects time and frequency response problems in TV systems. This results in clear, rich sound with more intelligible dialogue.



# Sound settings (continued) – dynamic range control (DTV only), audio level offset, headphone settings, audio description

## Dynamic Range Control (DTV only)

**Dynamic Range Control** allows control of audio compression for some digital television programmes (except MPEG-1 and MPEG-2).

- 1 In the **SOUND** menu press ▼ to select **Dynamic Range Control**.
- 2 Press ◀ or ▶ to select **On** or **Off**.

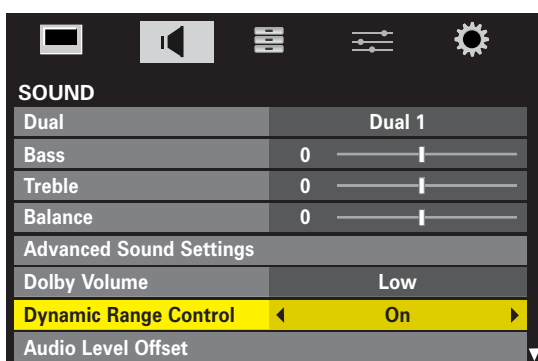

**NOTE:** If **Dolby Volume** is set to **Low** or **High** this feature will be unavailable.

## Audio Level Offset

This feature allows the audio level offsets for **ATV**, **DTV** and external equipment to be set separately in order to stop the sudden changes in volume when switching between sources.

- 1 In the **SOUND** menu press ▼ to select **Audio Level Offset** then press **OK**.

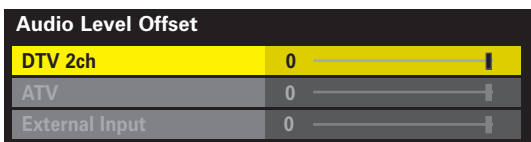

- 2 The selection available is dependant on which source is currently being viewed. Use ◀ or ▶ to adjust the level.

## Headphone Settings

This feature controls the volume through the headphones. If **Speaker Link** is set to **On** the television volume controls the headphones and the speakers.

If **Speaker Link** is set to **Off** the headphones work independently and the volume is controlled by the **Headphone Level** only.

- 1 In the **SOUND** menu. Press ▼ to highlight **Headphone Settings** then press **OK**.
- 2 Use ▼ to highlight **Speaker Link** then ◀ or ▶ to select **Off**.

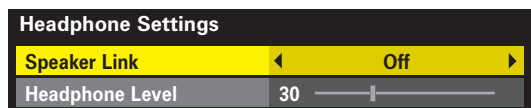

- 3 Use ▼ to highlight **Headphone Level** then press ◀ or ▶ to adjust the volume.

## Audio Description

This feature provides a detailed narrative sound track for the visually impaired, provided it is being broadcast. The function is available through the speakers or headphones and is activated by pressing the **AD** button (**AD** will appear in the channel banner if it is available). The volume is altered by using the **Mixing Level**.

- 1 Select **Audio Description** from the **SOUND** menu and press **OK**.
- 2 Use ▼ to highlight **Audio Description** then press ◀ or ▶ to select **On**.

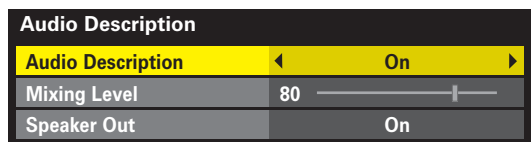

- 3 Use ▼ to highlight **Mixing Level** then press ◀ or ▶ to adjust the volume.
- 4 Use ▼ to highlight **Speaker Out** then press ◀ or ▶, select **On** for sound from both the headphones and speakers, select **Off** for sound from headphones only. (See 'Headphone Settings' to adjust the headphone sound).

# Widescreen viewing

Depending on the type of broadcast being transmitted, programmes can be viewed in a number of formats, **Wide**, **Super Live**, **Cinema**, **4:3**, **Subtitle** and **14:9**.

## **SUPER LIVE**

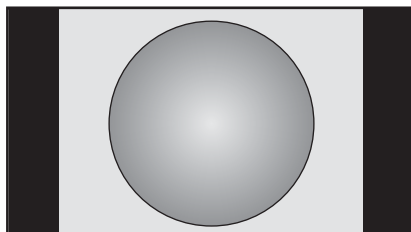

*This setting will enlarge a 4:3 image to fit the screen by stretching the image horizontally and vertically, holding better proportions at the centre of the image. Some distortion may occur.*

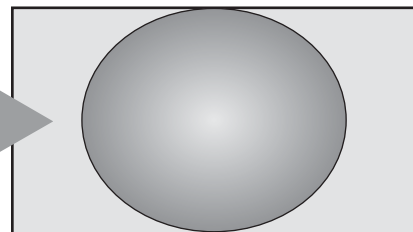

## **CINEMA**

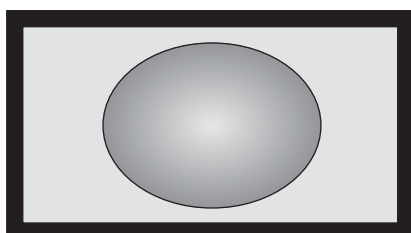

*When watching 'all sides panel format' films/video tapes, this setting will eliminate or reduce the black bars at all sides of the screen by zooming in and selecting the image without distortion.*

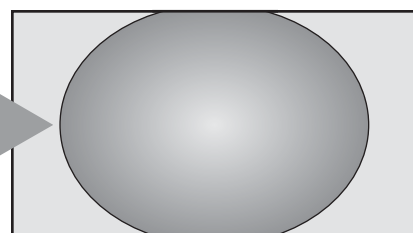

## **SUBTITLE**

*When subtitles are included on a letterbox format broadcast, this setting will raise the picture to ensure that all the text is displayed.*

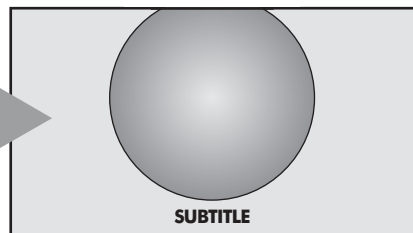

## **14:9**

*Use this setting when watching a 14:9 broadcast.*

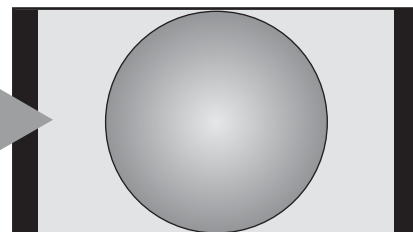

## **WIDE**

*Use this setting when watching a widescreen DVD, widescreen video tape or a 16:9 broadcast (when available). Due to the range of widescreen formats (16:9, 14:9, 20:9 etc.) black bars may be visible on the top and bottom of the screen.*

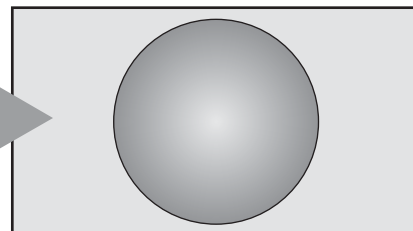

## **4:3**

*Use this setting to view a true 4:3 broadcast.*

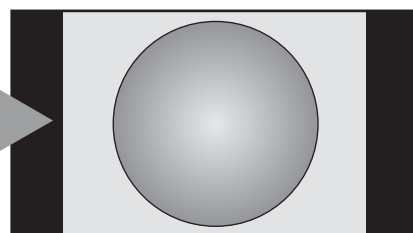

# Widescreen viewing (continued)

## NATIVE

This setting will show the picture without over scan, i.e. WYSIWYG.

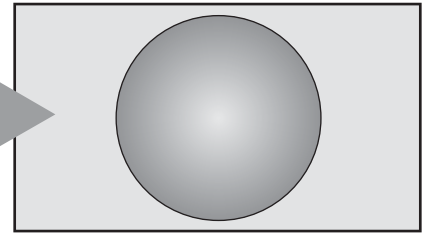

## AV FORMAT

Press **QUICK** to reveal the **Quick Menu**, press **▼** to highlight **Picture Size**, then **◀** or **▶** to view the list of available widescreen formats. Use **▼** or **▲** to highlight the required format and **OK** to select.

Picture Size
Wide
4:3
<b>Super Live</b>
Cinema
Subtitle
14:9
Native

## PC WIDE

This setting will show the picture without over scan and side panel.  
This option is only available when watching a PC signal source via HDMI or PC terminal.

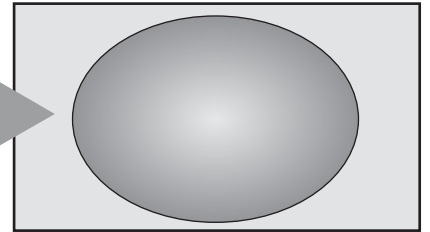

## PC NORMAL

This setting will show the picture without over scan, i.e. WYSIWYG.  
This option is only available when watching a PC signal source via HDMI or PC terminal.

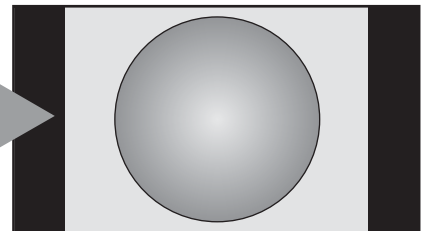

## DOT BY DOT

"Dot by Dot" is a non-scaling display. Depending on the input signal format this setting will display the picture with side panels and/or bars at the top and bottom (i.e. VGA input source)

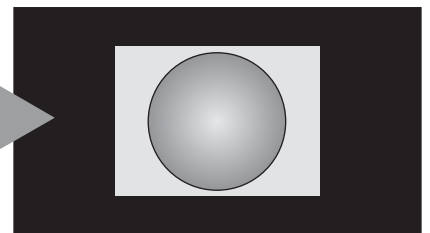

## PC FORMAT

Press **QUICK** to reveal the **Quick Menu**, press **▼** to highlight **Picture Size**, then **◀** or **▶** to view the list of available PC formats. Use **▼** or **▲** to highlight the required format and **OK** to select.

Picture Size
<b>PC Wide</b>
PC Normal
Dot by Dot

Using the special functions to change the size of the displayed image (i.e. changing the height/width ratio) for the purposes of public display or commercial gain may infringe on copyright laws.

# Picture controls

Most of the picture controls and functions are available in both **digital** and **analogue modes**. **PLEASE NOTE:** features not available will be greyed out.

## Picture Position (ATV only)

The picture position may be adjusted to suit personal preference and can be particularly useful for external inputs.

- 1 In the **SETUP** menu press ▼ until **Picture Position** is highlighted.

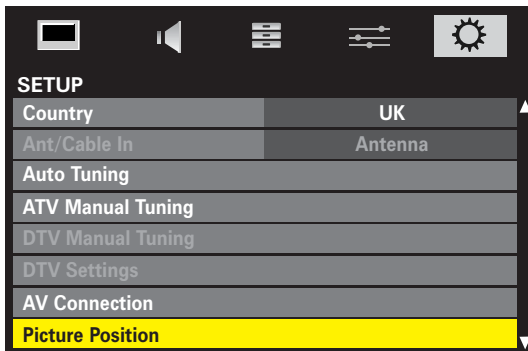

- 2 Press **OK** to view the options available for the picture format that has been selected.
- 3 Press ▲ or ▼ to select an option, then ◀ or ▶ to adjust the settings.

The options alter depending on the widescreen format chosen (see the *Quick Menu* section) and when viewing connected equipment.

In **Cinema**:

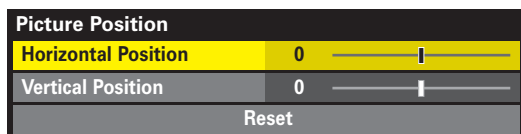

To return to the original factory settings select **Reset** in the **Picture Position** menu and press **OK**.

## Picture Mode

This television offers the choice of personalising the picture style.

**AutoView**, **Dynamic**, **Standard**, **Movie** and **Store** are preset options and effect many features/settings within the television. **Store** is only available when Location is set to **Store**.

**Game** option is available in external input mode (other than aerial input). Suitable widescreen formats will be selected.

**PC** option is available in RGB/PC input mode or HDMI input mode.

- 1 In the **PICTURE** menu press ▼ to select **Picture Mode**.

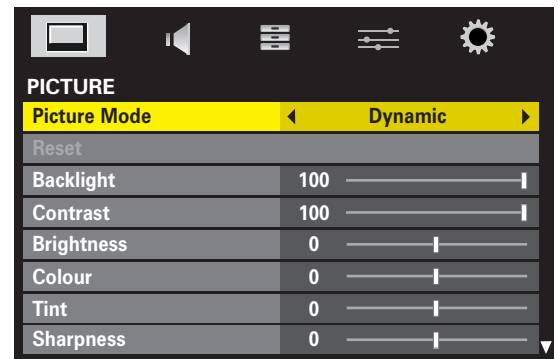

- 2 Press ◀ or ▶ to select an option.

**NOTE:** **AutoView** mode automatically adjusts picture settings according to the ambient light conditions and input signal, some features will not be available in this option.

The picture mode selected will only affect the source being viewed, different modes can be selected for each source.

## Picture Preferences

Picture modes can be customised by selecting a mode and adjusting the settings/features.

- 1 In the **PICTURE** menu use ▼ to select **Contrast**, **Brightness**, **Colour**, **Tint** and **Sharpness**.
- 2 Use ◀ or ▶ to adjust the settings.

# Picture controls (continued)

## Reset

**Reset** returns all customised picture settings (except **Picture Mode**) back to factory settings. This feature will not be available until picture settings have been changed.

- 1 In the **Picture** menu press ▼ to select **Reset**. Press **OK**.
- 2 A confirmation screen will appear. Press ◀ or ▶ to select **Yes** or **No**. Press **OK**.

## Backlight

Adjusting the **Backlight** can improve the clarity of the screen when viewing.

- 1 In the **PICTURE** menu press ▼ to select **Backlight**.

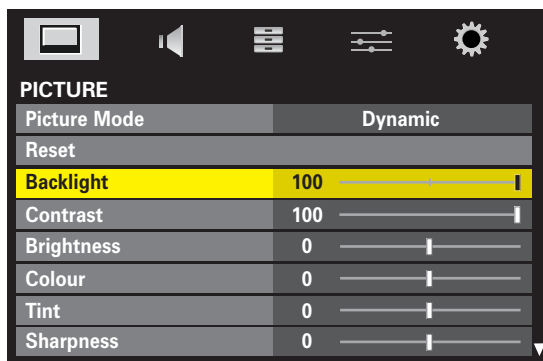

- 2 Press ◀ or ▶ to adjust.

## 3D Colour Management

When **3D Colour Management** is selected it allows the 'Base colour adjustment' feature to become available.

- 1 In the **Picture** menu press ▼ to highlight **Advanced Picture Settings**, press **OK**.

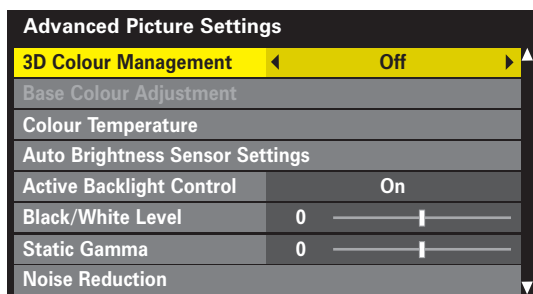

- 2 In the **Advanced Picture Settings** menu press ▼ to select **3D Colour Management** then use ◀ or ▶ to select **On**.

## Base Colour Adjustment

The **Base Colour Adjustment** feature allows the adjustment of individual colours to suit personal preference. This can be useful when using an external source.

- 1 In the **Advanced Picture Settings** menu press ▼ to select **Base Colour Adjustment**, then press **OK**.

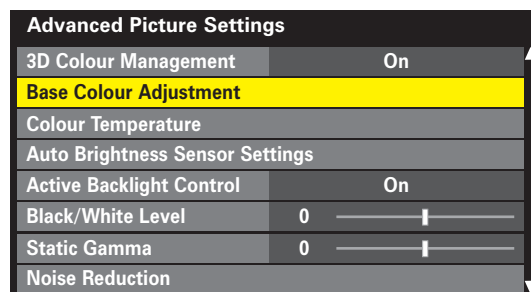

- 2 Press ▲ or ▼ to highlight an option.

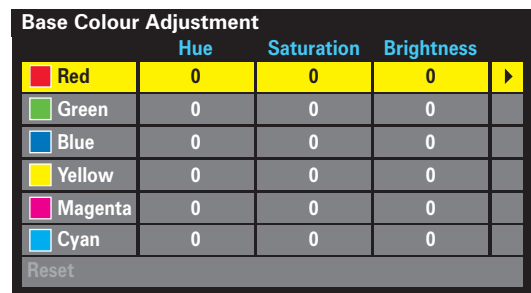

- 3 Press ▶ to select.



- 4 Press ▶ to select **Hue**, **Saturation** and **Brightness**, then press ▲ or ▼ to adjust the settings.

To return to the original factory settings select **Reset** and press **OK**.



# Picture controls (continued)

## Colour Temperature

**Colour Temperature** increases the 'warmth' or 'coolness' of a picture by increasing the red or blue tint.

- 1 In the **Advanced Picture Settings** menu press ▼ to highlight **Colour Temperature**, press **OK**.
- 2 Use ◀ or ▶ to select a setting from 0 to 10.

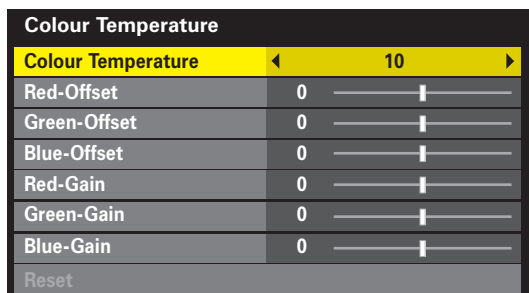

- 3 Press ▼ or ▲ to select an option, then ◀ or ▶ to adjust the setting.

**NOTE:** If **Picture Mode** is set to **AutoView** the colour options will not be selectable.

## Auto Brightness Sensor Settings

When the **Auto Brightness Sensor Settings** feature is activated it automatically adjusts the backlighting levels to suit the ambient light conditions.

- 1 In the **Advanced Picture Settings** menu press ▼ to highlight **Auto Brightness Sensor Settings** then press **OK**.

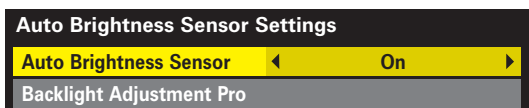

- 2 Press ◀ or ▶ to select **On**.
- 3 Press ▼ to select **Backlight Adjustment Pro** then press **OK**.

The **Backlight Adjustment Pro** screen will appear. Press **OK** again to view the adjustment window.

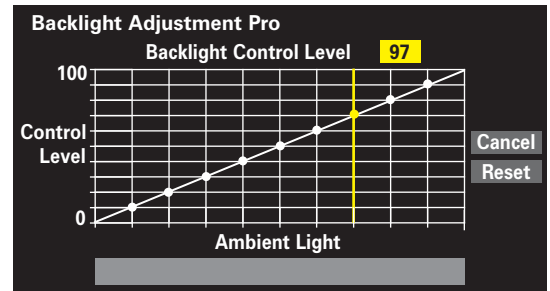

- 4 Press **OK** then ◀ or ▶ to select a point and ▼ or ▲ to adjust the level.
- 5 Press **OK** to store the adjustment.
- 6 To cancel the adjustment when selecting a point, press ▶ to select **Cancel** and press **OK**.
- 7 Select **Reset** then **OK** to return the adjustments to the factory settings.

## Active Backlight Control

When **Active Backlight Control** is activated it will automatically optimise the backlighting levels for dark scenes.

- 1 In the **Advanced Picture Settings** menu press ▼ to highlight **Active Backlight Control**.
- 2 Press ◀ or ▶ to select **On** or **Off**.

## Black/White Level

**Black/White Level** increases the strength of dark areas of the picture which improves the definition.

- 1 In the **Advanced Picture Settings** menu press ▼ to highlight **Black/White Level**.
- 2 Press ◀ or ▶ to adjust the level.

**NOTE:** The effect depends on the broadcast and is most noticeable on dark colours.

# Picture controls (continued)

## Static Gamma

The **Static Gamma** feature allows the adjustment of levels of black in the picture.

- 1 In the **Advanced Picture Settings** menu press ▼ to highlight **Static Gamma**.

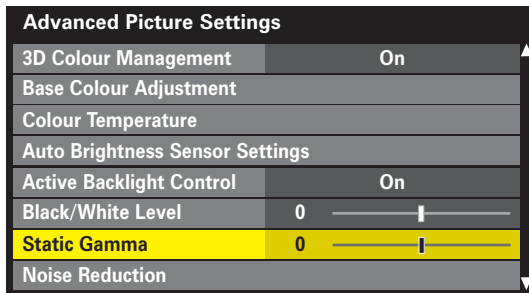

- 2 Press ◀ or ▶ to select adjust the level.

## MPEG NR – Noise Reduction

When watching a DVD the compression may cause some words or picture elements to become distorted or pixelated. Using the **MPEG NR** feature reduces this effect by smoothing out the edges.

- 1 In the **Advanced Picture Settings** menu press ▼ to highlight **Noise Reduction** then press **OK**.

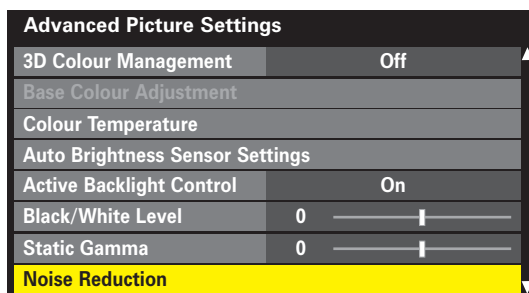

- 2 Press ▼ to select **MPEG NR**.



- 3 Press ◀ or ▶ to select between **Low**, **Middle**, **High** or **Off**.

## DNR – Digital Noise Reduction

**DNR** enables you to 'soften' the screen representation of a weak signal to reduce the noise effect.

- 1 Select **DNR** from the **Noise Reduction** menu.



- 2 Use ◀ or ▶ to select between **Auto**, **Off**, **Low**, **Middle** or **High**. The differences may not always be noticeable (for the best result use lower settings as picture quality can be lost if the setting is too high).

## Resolution +

This features modifies SD quality pictures to near HD quality levels, the levels can be selected for personal preference.

- 1 In the **Advanced Picture Settings** menu press ▼ to select **Resolution +** then press **OK**.

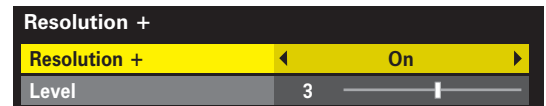

- 2 Press ▼ to select **Resolution +** and using ◀ or ▶ select **On**.
- 3 Press ▼ to select **Level** and using ◀ or ▶ adjust the level.

**NOTE:** Depending on the content, this may not work correctly.

Depending on the equipment connected to the television (i.e. equipment with specific enhancer functions), noise may appear on the image.

# Picture controls (continued)

## Active Vision M100

The **Active Vision M100** feature can reduce picture blur and/or judder without altering image brightness or adding flicker.

- 1 In the **Advanced Picture Settings** menu press ▼ to highlight **Active Vision M100**.

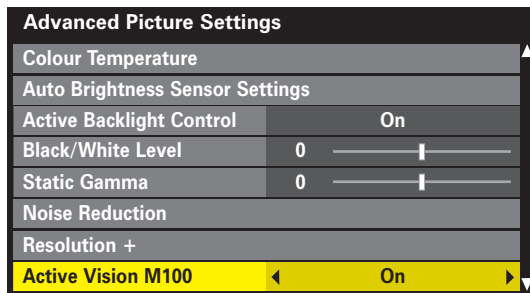

- 2 Press ◀ or ▶ to select **On** or **Off**.

## Film Stabilization

The **Film Stabilization** feature allows the adjustment of motion smoothness.

- 1 In the **Advanced Picture Settings** menu press ▼ to highlight **Film Stabilization**.

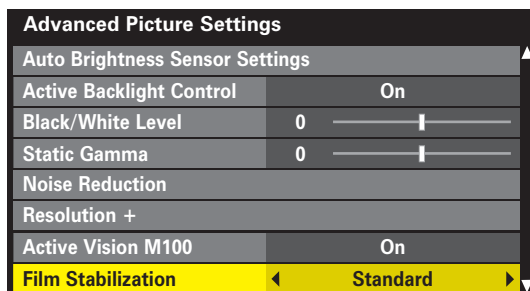

- 2 Press ◀ or ▶ to select between **Standard**, **Off** or **Smooth**.

**NOTE:** If **Picture Mode** is set to **AutoView** this feature will also have **Auto** mode.

## Expert Mode

**Expert Mode** allows the Red, Green and Blue colours to be switched on and off and individually adjusted.

- 1 In the **Advanced Picture Settings** menu press ▼ to select **Expert Mode** then press **OK**.

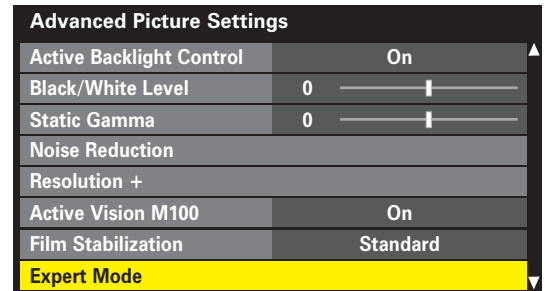

- 2 Press ▼ or ▲ to select a colour and then ◀ or ▶ to select **On**. Set the other colours to **Off**.

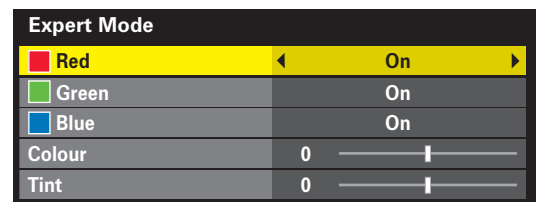

- 3 Press ▼ to select **Colour** or **Tint** then ◀ or ▶ to adjust.

**NOTE:** If **Picture Mode** is set to **AutoView** this feature will not be selectable.

## Reset

Using **Reset** will return **Advanced Picture Settings** back to the factory settings.

- 1 In the **Advanced Picture Settings** menu press ▼ to select **Reset**.

- 2 A confirmation screen will appear. Press ◀ or ▶ to select **Yes** or **No**. Press **OK**.

# Picture controls (continued)

## Control Visualization

This feature displays the brightness histogram and control curve of each scene.

- 1 In the **PICTURE** menu press ▼ to select **Control Visualization** then press **OK**.

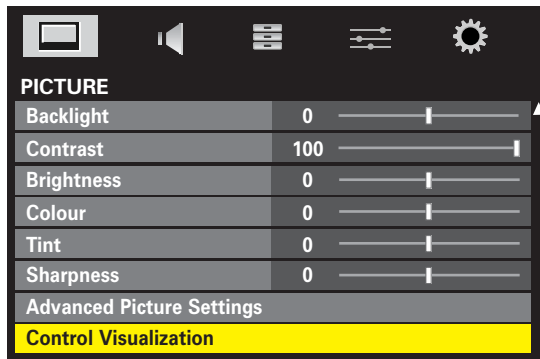

The histogram display will appear to the left of the picture being viewed.

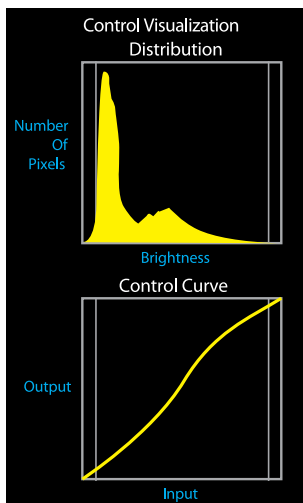

- 2 Press **EXIT** to finish.

## Panel Lock

**Panel lock** disables the buttons on the television. All buttons on the remote control can still be used.

- 1 In the **PREFERENCES** menu press ▼ to select **Panel Lock** and choose **On** or **Off** using ◀ or ▶.

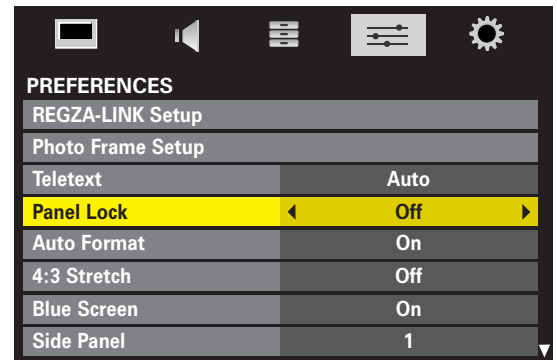

When **Panel lock** is **On**, a reminder will appear when the buttons on the television are pressed. **If the standby button is pressed the television will switch off and can only be brought out of standby by using the remote control.**

## Automatic Format (Widescreen)

When this television receives a true Widescreen picture and **Auto Format** is **On**, it will automatically be displayed in Widescreen format, irrespective of the television's previous setting.

- 1 In the **PREFERENCES** menu press ▼ to select **Auto Format**.

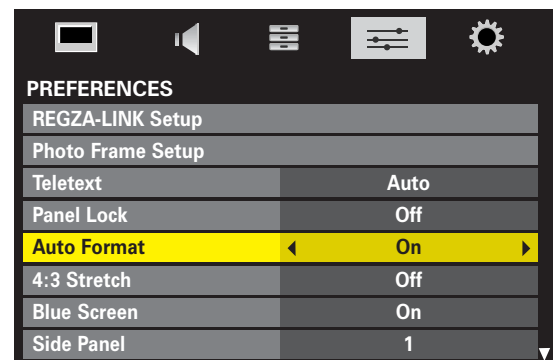

- 2 Press ◀ or ▶ to select **On** or **Off**.

# Picture controls (continued)

## 4:3 Stretch

When **4:3 Stretch** is activated the size switching system changes 4:3 programmes into a full screen picture.

- 1 In the **PREFERENCES** menu press ▼ to highlight **4:3 stretch**.

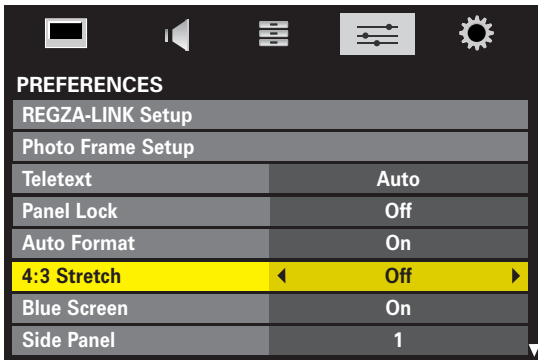

- 2 Press ◀ or ▶ to select **On** or **Off**.

## Blue Screen

When **Blue Screen** is selected the screen will turn blue and the sound will be muted when no signal is received.

- 1 In the **PREFERENCES** menu press ▼ to highlight **Blue Screen**.

- 2 Press ◀ or ▶ to select **On** or **Off**.

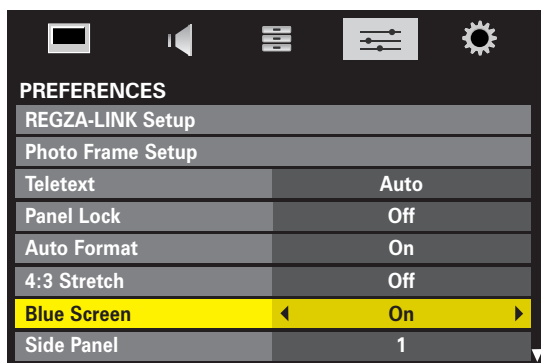

## Side Panel Adjustment

The **Side Panel** feature lightens or darkens the band each side of the screen when in 4:3 or 14:9 format. This helps prevent image retention of the band and can also make viewing in bright or dark conditions more comfortable.

- 1 In the **PREFERENCES** menu press ▼ until **Side Panel** is highlighted.

- 2 Press ◀ or ▶ to adjust.

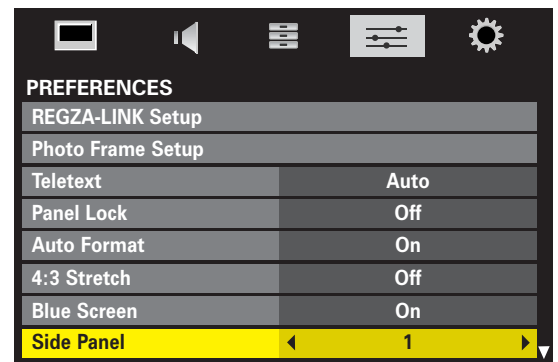

## TOSHIBA Illumination (Model dependant)

This allows the illumination of the TOSHIBA logo, situated on the front of the television, to be switched **On** or **Off**.

- 1 In the **PREFERENCES** menu press ▼ to select **TOSHIBA Illumination**.

- 2 Use ◀ or ▶ to select **On** or **Off**.

## Picture Still

This feature is used to hold a still image on the screen.

- 1 Press ◻ to hold an image on the screen, press ◻ again to cancel.

# The timers

## Programme Timers (DTV only)

This feature will set the television to go to a specific channel at a certain time. It can be used to view a particular programme, or by setting the mode to daily or weekly, can be used to view a series of programmes.

- 1 Press **MENU** and ◀ or ▶ to select the **APPLICATIONS** menu.

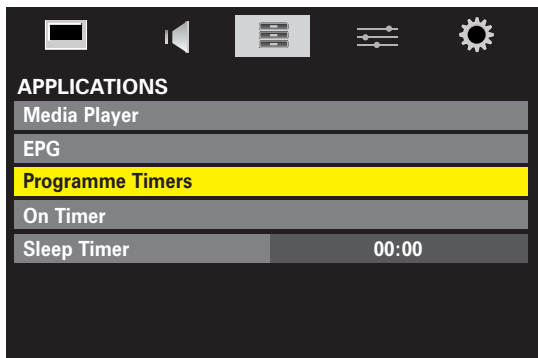

- 2 Press ▼ to select **Programme Timers**, then press **OK** to select.
- 3 Press ▼ to select the first programme to be timed, then press **OK**. The **EDIT TIMER** menu will now appear on screen.
- 4 Press ▲ and ▼ to go through the list adding the details of the programme to be timed by using the number buttons as well as ◀ and ▶ to make selections.

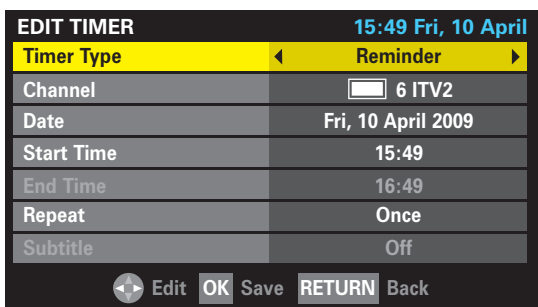

- 5 When all the details have been entered press **OK** to save the timer.

The Orange/Red programme timer indicator on the front of the television will be lit indicating that the **Programme Timers** have been set.

**PLEASE NOTE:** When a timed programme is about to start, an information screen will appear offering the option of watching or cancelling the programme. The menus and other channels will not be available during the timed programme unless the programme timer is cancelled.

If the television is turned off using the ⏻/I POWER button any programmes set in the timers will be cancelled.

It is possible to set the timers to record, the media recorder will need to be AV link compatible.

## Setting the On Timer

The **On Timer** sets the television to turn on automatically to a selected channel at a certain time of day or after a certain length of time.

- 1 In the **APPLICATIONS** menu, press ▼ to select **On Timer** then press **OK**.

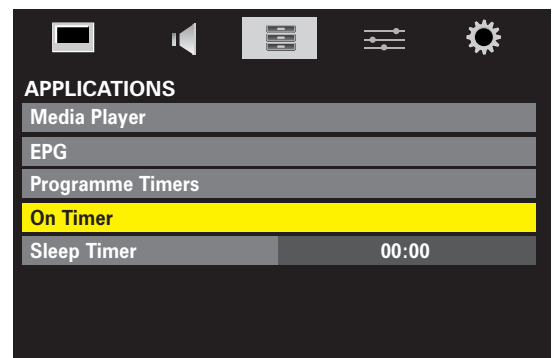

- 2 Press ▼ to highlight **Enable On Timer**, then ◀ or ▶ to select **On**.
- 3 Press ▼ to highlight **Enable DTV Clock**, then ◀ or ▶ to select **On**.

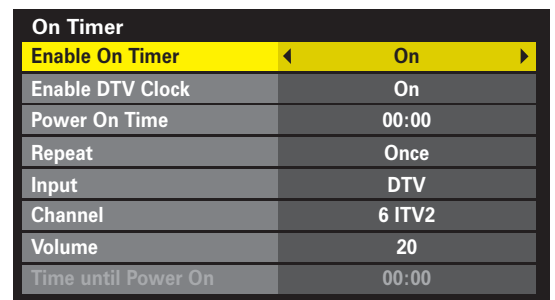

- 4 Press ▲ and ▼ to go through the list adding details to the on timer by using the number buttons as well as ◀ and ▶ to make selections.



# The timers (continued)

- 5** Press **OK** to save the timer. The Green timer indicator on the front of the television will indicate that the timer has been set.

NOTE: When an external input is selected in the **Input** option the **Channel** option will no longer be available.

The **Repeat** option is only available when **Enable DTV Clock** is set to **On**.

The **Time until Power On** option is only available when **Enable DTV Clock** is set to **Off**.

## Canceling the On Timer

- 1** To cancel the **On Timer** menu, use **▼** to select **Enable On Timer**.
- 2** Use **◀** or **▶** to select **Off**.

On Timer	
Enable On Timer	Off
Enable DTV Clock	On
Power On Time	00:00
Repeat	Once
Input	DTV
Channel	6 ITV2
Volume	20
Time until Power On	00:00

## Setting the Sleep Timer

The **Sleep Timer** turns the television off after a certain time.

- 1** In the **APPLICATIONS** menu, press **▼** to select **Sleep Timer**.

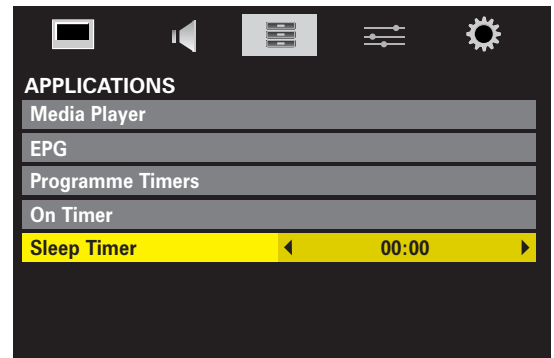

- 2** Using the number buttons set the required time. For example, to switch the television off in one and a half hours enter 01:30, or press **◀** or **▶** to increase/decrease in steps of 10 minutes.
- 3** Press **EXIT** to finish.
- 4** To cancel the **Sleep timer**, enter zero in the option.

# DTV on-screen information

When viewing in **digital** mode, the on-screen information gives access to programme details for all available channels.

## Information

- 1 Select information by pressing **i+**, the information screen will appear giving details of the channel and programme currently being viewed.



- 2 To see details of the next programme scheduled for the channel, press **▼** to select **Next**.
- 3 Press **▼** to select **Also**. Details of programmes that have started on other channels will be shown. Use **◀** or **▶** to change the display contents.
- 4 To set a reminder for the following programme, select **Next** then press **OK**. The **EDIT TIMER** screen will appear.



- 5 The details of the programme will have been added to the screen. Press **OK** to save. The timer icon will appear on the information screen.
- 6 To record the programme use **◀** or **▶** to change the **Timer Type** to **Record**. This will allow more options to be available. Press **▼** and **◀** or **▶** to select options. Press **OK** to save.

**NOTE:** In order for the recording operation to work the media recorder must be AV link compatible.

## On-screen Information Icons

Icons will appear on the Information screen giving details about the programmes being broadcast. Details of these icons are listed below:

### Service info

- Service type (TV, Radio)
- Skip
- Teletext

### Audio Info

- Mono
- Stereo
- Dual mono

### Audio/Subtitle info

- Hard of Hearing

### Event Info

- Video format
- Video aspect
- Teletext
- Subtitle (Single, Multi)
- Multi-audio track
- Encrypted

### Timer Info

- Timer status

# DTV programme guide

When viewing in **digital** mode, the programme guide gives access to programme details for all available channels.

## Guide

- 1 Select the on-screen guide by pressing **GUIDE**, the guide screen will appear highlighting details of the channel and programme currently being viewed. This may take a few moments to appear.

Channel	Programme
1 BBC ONE	BBC News ...   Spot..
2 BBC TWO	
3 ITV1	Loose Wom..   ITV Lunchtime   Good Bid, Good Buy   Daily Cooks ...
4 Channel 4	Where Angels Go, Trouble Follo...   Selling Houses Abroad
5 Five	House   Neighb...   Home and Aw..   O..O..   Love..
6 ITV2	Emmerdale   The Jeremy Kyle Show   The Jeremy Kyle Show
7 BBC THREE	This Is BBC THREE
9 BBC FOUR	This Is BBC FOUR
10 ITV3	Heartbeat   Pie in the Sky
11 SKY THREE	Shadow Of The Shark   Cruise & Stay ..   Residensea
12 UKTV Histo..	Antiques Roadshow   Sharpe
13 Channel 4..	News at No..   Su.
14 More 4	Deal or No Deal   ER   Hill Street Bl..

**NOTE:** The channels are displayed in groups of service type (i.e. TV, Radio, Text). Press the **ATV/DTV** button to change service types.

- 2 Press **◀** or **▶** for information on other features scheduled for the channel selected.
- 3 For details of other programmes currently available, press **▼** or **▲** to scroll up and down the channel list. As channels are selected details of the programme currently being broadcast will appear. Press **◀** or **▶** to view information on future features.
- 4 Press **P** **▼** to move on a page and **P** **▲** to return to the previous page.
- 5 Press **▶▶** to move forward 24 hours and **◀◀** to go back. Pressing **▶▶** or **◀◀** will move forwards or backwards a page.
- 6 For information on a highlighted programme press **i+**. To set the timer press the **BLUE** button to bring up the **Programme Timer** menu, then **OK** to set.

**NOTE:** Recording can be set from the guide. The media recorder must be set to the same time as the television. Refer to the the owner's manual for the recording equipment.

## Topic Selection and Search

From the Guide set topics by colour and display programmes according to their topic.

- 1 In the Guide screen press **QUICK**. Press **▼** to select **Genre Colour** then press **OK**.

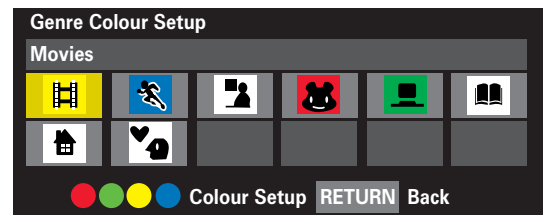

- 2 Use **◀**, **▶**, **▼** and **▲** select a topic, then press a colour button to assign that colour to the chosen topic. Four colours are available to set.
- 3 Press **RETURN** to return to the guide screen, the guide will automatically assign the colours to the chosen topics. Press the **YELLOW** button.

Genre Search

Movies

Rank	Programme	Time
38 Topup Anytime 1	Darkman II: The Return of Durant	Fri, 10 April 8:46-3:01
14 More 4	The Quiller Memorandum	Fri, 10 April 10:45-12:55
32 Film 4	The Ghost and Mrs Muir	Fri, 10 April 13:00-15:10
32 Film 4	Sands of Iwo Jima	Fri, 10 April 15:10-17:20
32 Film 4	Carry On Behind	Fri, 10 April 17:20-19:05
32 Film 4	Freaky Friday	Fri, 10 April 19:05-21:00
11 Sky THREE	Bloody Monday	Fri, 10 April 21:00-22:45
32 Film 4	Transporter 2	Fri, 10 April 21:00-22:40
10 ITV3	Bloody Sunday	Fri, 10 April 22:00-0:10
29 E4	The 51st State	Fri, 10 April 22:00-0:00
14 More 4	Another 48 Hrs	Fri, 10 April 22:35-0:25
32 Film 4	Fight Club	Fri, 10 April 22:50-1:35
30 E4+1	The 51st State	Fri, 10 April 23:00-1:00

- 4 Use **◀** or **▶** to select a topic. A list of available programmes and details will appear for that topic. Use **▼** or **▲** to highlight a particular programme.
- 5 For information on a highlighted programme press **i+**.
- 6 To view a current programme press **OK**.
- 7 Press the **BLUE** button to bring up the **Programme Timer** menu to set a reminder or record a future programme.

# DTV Settings – setting the PIN code, parental control, locking channels

In order to prevent viewing of unsuitable films and programmes, channels and menus can be locked. These can then only be accessed with a security code PIN when in **digital** mode.

## Setting the PIN

- 1 Press **MENU** and **▶** to select the **SETUP** menu.
- 2 Press **▼** to select **DTV Settings** then press **OK**.

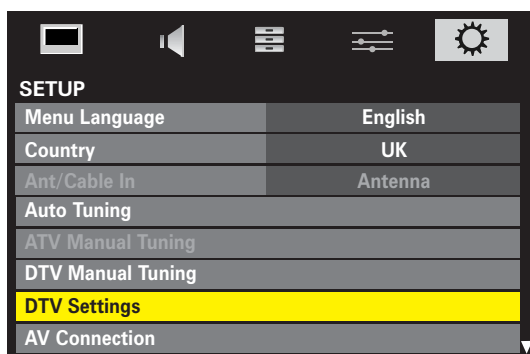

- 3 Use **▼** to select **PIN Setting** then press **OK**.

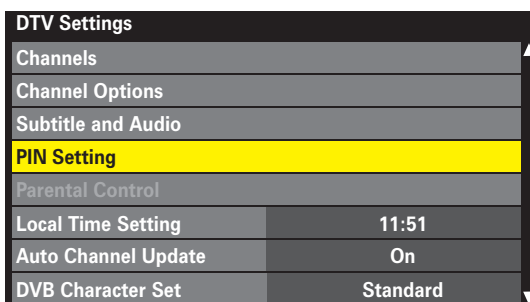

- 4 Using the number buttons enter a four digit number, when these have been entered they will need to be confirmed by entering them again.



The PIN number has now been set.

If the PIN number has been set a prompt will appear requiring the PIN number to be entered before television settings (i.e. **Auto Tuning**, **Reset TV** etc.) can be altered.

## Parental Control

The **Parental Control** feature allows the blocking of programmes according to their rating levels. It will only be available when a PIN number has been set.

- 1 From the **DTV Settings** menu press **▼** to select **Parental Control** and press **OK**.



- 2 Use **◀** or **▶** to choose between **None** and an age rating (**4 to 18**).

To activate the Parental Controls switch the television off then on again.

To view a blocked programme the PIN number will now have to be entered.

## Locking Channels

Locking channels stops the viewing of **digital** channels. The PIN must be set before programmes can be locked.

- 1 From the **DTV Settings** menu press **▼** to select **Channel Options** and press **OK**.



- 2 Use **▼** or **▲** to highlight channels, then press **▶** to select the 'lock' option.

- 3 Press **OK** to select, a tick will appear in the box.

- 4 Press **EXIT**.

The PIN must now be entered before the locked channels can be accessed.

# DTV settings – subtitles, audio languages, common interface

## Subtitles

When in digital mode this feature will show subtitles on the bottom of the screen in the selected language provided they are being broadcast.

- 1 From the **SETUP** menu press ▼ to select **DTV Settings**. Press **OK**.
- 2 Press ▲ or ▼ to highlight **Subtitle and Audio**, then press **OK**.

DTV Settings	
Channels	
Channel Options	
<b>Subtitle and Audio</b>	
PIN Setting	
Parental Control	
Local Time Setting	11:51
Auto Channel Update	On
DVB Character Set	Standard

- 3 Press ▼ to select **Subtitle Type** and use ◀ or ▶ to select **Normal** or **Hard of Hearing**.

Subtitle and Audio	
<b>Subtitle Type</b>	<b>Normal</b>
Primary Subtitle Language	English
Secondary Subtitle Language	English
Audio Type	Normal
Primary Audio Language	English
Secondary Audio Language	English

- 4 Press ▼ to select **Primary Subtitle Language** or **Secondary Subtitle Language** and use ◀ and ▶ to select an option.
- 5 Press the **SUBTITLE** button to select on or off, or choose if more than one of the selected languages are available.

## Audio Languages

This feature allows a programme or film to be viewed with a choice of soundtrack language, provided they are currently being broadcast.

- 1 In the **Subtitle and Audio** menu press ▼ to select **Audio Type** and use ◀ or ▶ to select **Normal** or **Hard of Hearing**.

Subtitle and Audio	
Subtitle Type	Normal
Primary Subtitle Language	English
Secondary Subtitle Language	English
<b>Audio Type</b>	<b>Normal</b>
Primary Audio Language	English
Secondary Audio Language	English

- 2 Press ▼ to select **Primary Audio Language** or **Secondary Audio Language** and use ◀ and ▶ to select an option.

**NOTE:** If more than one soundtrack is available, use ◯I/II to select between them.

## Common Interface

The *Common Interface Slot*, situated on the side of the television, enables the insertion of a CAM (Conditional Access Module) and card. These are purchased from a service provider and allow additional subscription broadcasts to be viewed. For information contact a service provider.

- 1 Insert the CAM and card into the Common Interface Slot, following the instructions provided with the CAM. A box will appear on screen to confirm that the CAM is loaded.
- 2 In the **DTV Settings** menu press ▼ or ▲ to select **Common Interface** and press **OK**.
- 3 Details of the CAM should now be available.

# Software upgrade, licences, system information, reset TV

## Auto Upgrade

If **Auto Upgrade** is set to **On** the software will automatically upgrade as each version becomes available, provided the television is on or in standby.

- 1 In the **SETUP** menu press ▲ or ▼ to select **Software Upgrade** and press **OK**.
- 2 Press ▲ or ▼ to select **Auto Upgrade**.

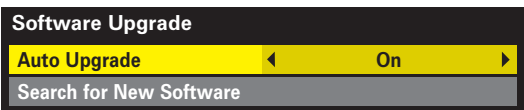

- 3 Use ◀ or ▶ to select **On** or **Off**.

## Searching for New Software

If preferred, software upgrades can be searched for manually using **Search for New Software**.

- 1 In the **Software Upgrade** menu press ▼ to select **Search for New Software**. Press **OK**.

The television will automatically start searching for a software upgrade, the progress bar will move along the line.

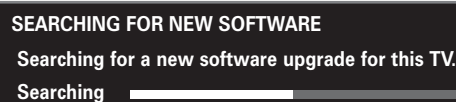
A screenshot of the television's search screen. The title is 'SEARCHING FOR NEW SOFTWARE'. Below it, the text reads 'Searching for a new software upgrade for this TV.' and 'Searching' followed by a progress bar that is approximately one-third full.

If an upgrade is found the television will automatically start downloading, if not a screen will appear stating that an upgrade is unavailable.

## Software Licences

The licences for the software used in this television are available for viewing on screen.

- 1 In the **SETUP** menu press ▲ or ▼ to select **Software Licences** and press **OK**.

A screen will appear displaying all the licensing information required for the televisions software.

## System Information

This feature can be used to check the version of software currently installed. In DTV mode it includes additional diagnostic information such as signal strength, signal quality, frequency etc.

- 1 From the **SETUP** menu press ▲ or ▼ to select **System Information**.
- 2 Press **OK** to display the **System Information**.

## Reset TV

Selecting **Reset TV** will delete all television settings/features, including stored channels, returning the television to the original factory set up.

- 1 In the **SETUP** menu press ▼ until **Reset TV** is highlighted.
- 2 Press **OK** to select. A screen will appear warning that all previous settings will be lost, press ◀ or ▶ to select **Yes** or **No**, then press **OK** to continue.

The television will switch off then back on again and the **Quick Setup** screen will appear. Press **OK** to continue (see 'Quick Setup' section).



# Media player – opening Media Player

The **Media Player** allows the viewing of photos (JPEG files), movies (DivX files) and music (MP3 files) stored in a USB storage device or SD memory card (photos only).

## Photo Viewer specifications

Data type: JPEG Exif Version 2.2

File Format: DCF Version 1.1

Maximum photo size: 9MB

Maximum number of files: 2000/Folder

Maximum photo resolution: 16384 x 16384 Pixels

## Movie Viewer specifications

File Format: DivX®

Maximum video resolution: 720 x 480 (30 fps)

Maximum number of files: 500/Folder

## Music Player specifications

File Format: MP3

Sampling frequency: 16kHz, 22.05kHz, 24kHz, 32kHz, 44.1kHz, 48kHz

Bit rate: from 8 to 320kbps

Maximum number of files: 500/Folder

### PLEASE NOTE

Insert the USB device or SD card gently into the television and do not remove while viewing Media Player.

Ensure the USB device is connected directly into the television, do not use a USB hub.

Some devices may not be compatible with the television.

Any required permission must be obtained from copyright owners to use copyright material. Toshiba cannot and does not grant such permission.

## Auto Start

If **Auto Start** is enabled **Media Player** will automatically display the opening screen prompt when a USB device or SD card is connected. If **Auto Start** is set to **Off Media Player** can only be opened from the menu.

- 1 Press **MENU** and ◀ or ▶ to select **APPLICATIONS**.
- 2 Press ▼ to select **Media Player** then press **OK**.



- 3 In **Media Player** press ▼ or ▲ to select **Auto Start**.
- 4 Use ◀ or ▶ to select **On** or **Off**.

## Opening Media Player automatically

- 1 Connect a USB flash drive to the USB Port or an SD memory card into the SD slot on the side of the television. A screen prompt will appear asking to open the **Media Player**.

USB device was connected to TV. Do you want to open Media Player?

No Yes

- 2 Press ◀ or ▶ to select **Yes**, the **Media Player** will open.

**NOTE:** The screen prompt will remain on screen for approximately 6 seconds. If the USB device is inserted and removed frequently the prompt may not appear.

## Opening Media Player from the menu

- 1 From the **APPLICATIONS** menu select **Media Player** then press **OK**.
- 2 Press ▼ or ▲ to highlight **Photo**, **Movie** or **Music** then press **OK**, the **Media Player** will open.

**NOTE:** The **Media Player** will open even if there are no images on the USB flash drive.

On-screen menus will not display while the **Media Player** is being used.

# Media player (continued) – multiview, single view, slideshow, interval and repeat

## Using Multi View

This view mode allows all the images within a selected folder to be viewed simultaneously, using thumbnail views in a grid. The initial highlighted position will be the top left image within the grid.

- 1 Open **Media Player**. Press ▲, ▼, ◀ and ▶ to select a folder then press **OK**. All the images in the folder will appear in the Multi View grid.

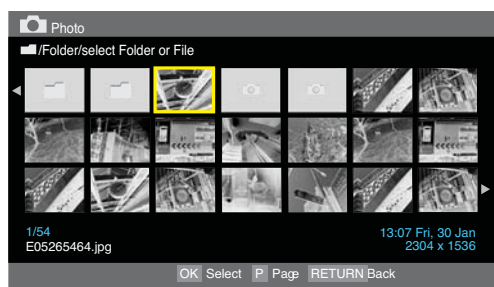

- 2 Press ▲, ▼, ◀ and ▶ to move through the images. If there are too many images for the screen, pressing ◀ on the top left image will show the previous page moving the highlight to the bottom right image. Alternatively, pressing ▶ on the bottom right image will show the next page moving the highlight to the top left image.

If there is more than one page of images within the folder pressing **P**▲ and **P**▼ will move through the pages.

- 3 Press **RETURN** to leave the current folder. Press **EXIT** to return to the last viewed source.

## Using Single View

This view mode displays all the images in a selected folder individually by scrolling through them manually.

- 1 In the Multi View grid use ▲, ▼, ◀ and ▶ to highlight an image. Press **OK**, the selected image will appear on the screen.
- 2 Press ▶ to move to the next image or ◀ to move back to the previous image.
- 3 Press ▲ to rotate the image 90° clockwise or ▼ to rotate 90° counterclockwise.

- 4 To display file information i.e. image number, image title, shot date and time, file size etc., press **(i+)**. The information will remain on screen for approximately 6 seconds or can be removed by pressing **(i+)** again.

- 5 Press **EXIT** to close **Media Player**.

## Using Slideshow

This view mode displays all the images in a selected folder as a slideshow, scrolling through them automatically.

- 1 In Single View press **OK**. Slideshow will now display all the images in the selected folder.
- 2 As with Single View pressing ◀ and ▶ will display previous and next images. The images can also be rotated and their information displayed.
- 3 Press **EXIT** to return to the last viewed source.

## Interval Time and Repeat Settings

This feature sets the interval time and repeat when in Single View and Slideshow modes.

- 1 While in Single View or Slideshow mode press **QUICK** to open the the **Quick Menu**.



- 2 Press ▲ or ▼ to select **Interval Time** then use ◀ or ▶ to adjust the setting.
- 3 Press ▼ to select Repeat then ◀ or ▶ to select **On** or **Off**.

# Media player (continued) – playing movies, repeat mode, DivX® VOD

## Playing Movies (USB devices only)

The **Movie** feature plays DivX® movie clips stored on a USB storage device.

- 1 In **Media Player** press ▼ or ▲ to select **Movie** then press **OK**.
- 2 Press ▼ or ▲ to select a file or folder. If there are more folders than will fit onto the screen use **P**▲ or **P**▼ to move onto the next or previous page.

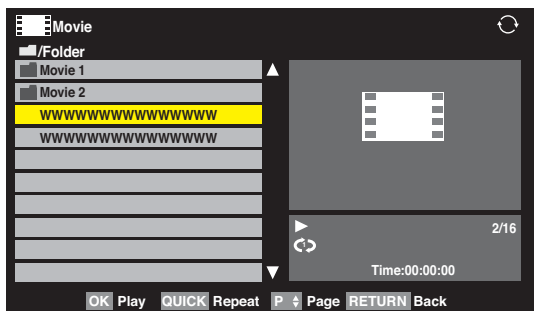

- 3 When a folder is selected press **OK** to view files in the folder. Press **RETURN** to move back.
- 4 When the required files has been selected press **OK** or ► to start playback.
- 5 Press ■ to stop playback.

**NOTE:** When playback is stopped Media Player memorises the point at which it is stopped and when ► is pressed playback resumes from that point. To start playback from the beginning of the files press ■ twice.

If playback is finished before ■ is pressed the next file will automatically start to play from the beginning. Depending on the size of the file it may take a few minutes for playback to begin.

- 6 To pause playback at any point press ||/||►. To resume play press ►.
- 7 Press ◀◀ or ▶▶ to fast reverse or fast forward during playback. Each time ◀◀ or ▶▶ is pressed the playback speed will change.
- 8 To locate a specific point press ◀◀| or |▶▶ repeatedly until the point is accessed.

**NOTE:** If a file is not compatible with **Media Player** it will automatically be skipped.

- 9 To display file information i.e. content number, movie title, progress time, etc., press (i+). The information will remain on screen for approximately 6 seconds or can be removed by pressing (i+) again.
- 10 To view subtitles press **SUBTITLE** repeatedly to select the required subtitle language.
- 11 Press **AUDIO** repeatedly to select the required audio language.
- 12 Press **EXIT** to close **Media Player**.

## Picture Size and Repeat

- 1 While the movie is showing, press **QUICK** to open the the **Quick Menu**.



- 2 Press ▲ or ▼ to highlight **Picture size** then use ◀ or ▶ to select **Super Live**, **Cinema**, **Subtitle** or **Wide**.
- 3 Press ▼ to highlight **Repeat** then ◀ or ▶ to select **Off**, **All** or **1**.
- 4 Press **RETURN**.

## DivX® VOD

To register the television to a DivX® account.

- 1 In **Media Player** press ▼ or ▲ to select **DivX® VOD** then press **OK**.
- 2 A screen will appear displaying **DivX® VOD** information and the eight character registration code. For details on registration go to the DivX website at <http://vod.divx.com/>.
- 3 Copy the activation file to a USB device and play it in the TV.

# Media player (continued) – playing music, repeat mode

## Playing Music (USB devices only)

The **Music** feature plays MP3 files stored on a USB storage device.

- 1 In **Media Player** press ▼ or ▲ to select **Music** then press **OK**.
- 2 Press ▼ or ▲ to select a file or folder. If there are more folders than will fit onto the screen use **P**▲ or **P**▼ to move onto the next or previous page.

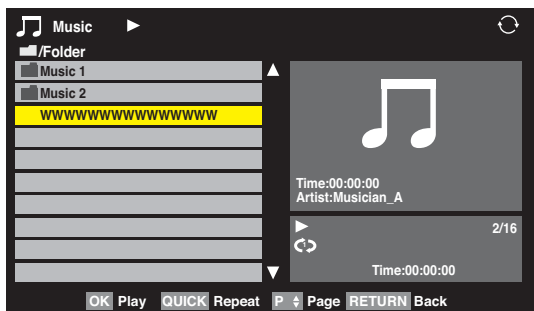

- 3 When a folder is selected press **OK** to view files in the folder. Press **RETURN** to move back.
- 4 When the required files has been selected press **OK** or ▶ to start playback.
- 5 Press ■ to stop playback.

**NOTE:** When playback is stopped Media Player memorises the point at which it is stopped and when ▶ is pressed playback resumes from that point. To start playback from the beginning of the files press ■ twice.

If playback is finished before ■ is pressed the next file will automatically start to play from the beginning. Depending on the size of the file it may take a few minutes for playback to begin.

- 6 To pause playback at any point press ||/||▶. To resume play press ▶.
- 7 Press ◀◀ or ▶▶ to fast reverse or fast forward during playback. Each time ◀◀ or ▶▶ is pressed the playback speed will change.
- 8 To locate a specific point press ◀◀| or |▶▶ repeatedly until the point is accessed.

**NOTE:** If a file is not compatible with **Media Player** it will automatically be skipped.

- 9 To view subtitles press **SUBTITLE** repeatedly to select the required subtitle language.
- 10 Press **AUDIO** repeatedly to select the required audio language.
- 11 Press **EXIT** to close **Media Player**.

## Repeat Mode

- 1 Press **QUICK** to open the the **Quick Menu**.



- 2 Use ◀ or ▶ to select **Off**, **All** or **1**.
- 3 Press **RETURN**.

# Media player (continued) – setting up the photo frame feature

## Photo Frame Setup

This feature allows a photograph to be displayed on the screen of the television using the set as a photo frame.

- 1 Insert a USB device or an SD card into the side of the television. In the **PREFERENCES** menu press **▼** until **Photo Frame Setup** is highlighted then press **OK**. The preview screen will appear.

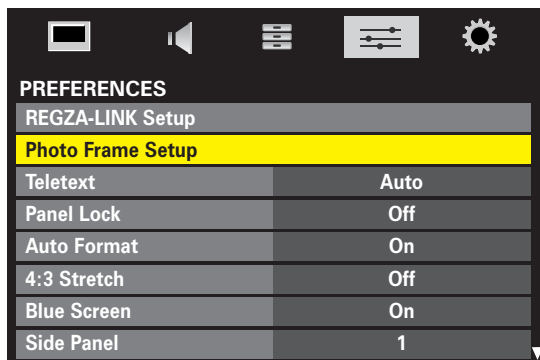

- 2 With **Photo Select** highlighted press **OK**.



- 3 Use **▼**, **▲**, **◀** and **▶** to locate the required photo, then press **OK** to select.

- 4 Press down to highlight **Photo Edit**, then **OK** to select.



- 5 If the photo requires rotating, use **▼** to select **Rotate** then press **OK**. Each time **OK** is pressed the photo will rotate 90°.

- 6 To delete the photo, use **▼** to highlight **Delete** then press **OK**. A screen prompt will appear, use **◀** or **▶** to select **Yes**. To choose another photo press **RETURN** then select as in Step 2 and 3.



- 7 Press **▼** to highlight **Settings** then press **OK**.



- 8 For a clock to appear on screen with the photo, with **Clock** highlighted use **◀** or **▶** to select **Digital**, **Analogue**, **Digital and Analogue** or **Off**.
- 9 Press **▼** to highlight **Position** and **◀** or **▶** to choose **Left** or **Right**. The clock will then move to whichever position has been chosen.
- 10 Press **▼** to highlight **Auto Power Off**. Using **◀** or **▶** to select between **00:30**, **01:00**, **02:00**, **04:00**, **06:00**, **12:00** or **Off**.

Setting this option will put the television into standby after the chosen time period.

- 11 Press **RETURN**.



- 12 Use **▲** to highlight **Photo Select** then **◀** or **▶** to highlight **Start**. Press **OK**.

The photo will now enlarge on the television screen with the clock, if set, in the required position. It will remain on screen for the chosen time period.

- 13 Pressing **EXIT** will take the television back to normal viewing.

**NOTE:** The clock display will appear only when the digital broadcast is received.

The Photo and Settings items are moved by 4 dots every 5 minutes to prohibit screen burn-in.

The pre-installed photo file is stored in the television's flash memory before shipment.

- 14 **Photo Frame** can also be opened from the **Quick Menu**. Press **QUICK** to open the **Quick Menu**.

- 15 Press **▲** or **▼** to select **Photo Frame** then press **OK**.

# PC settings for RGB/PC connections – picture position, clock phase, sampling clock, reset

## Picture Position

Connect the PC (as shown in the 'Connecting a PC via RGB/PC' section) and ensure that a picture is showing on the television screen. The picture position may now be adjusted to suit personal preference.

- 1 Press  to select **PC**, then select **PC Setting** from the **SET UP** menu.

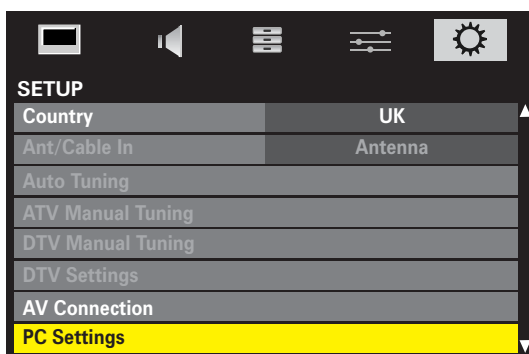

- 2 Press **OK**. Press **▲** and **▼** to select an option, then **◀** or **▶** to adjust the settings.

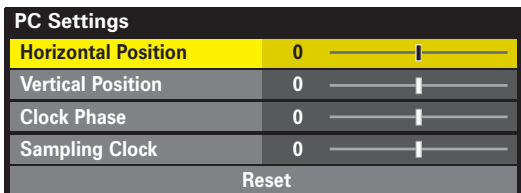

## Clock Phase

The **Clock phase** matches the PC signal with the LCD display. Adjusting this can clear horizontal stripes and picture blur.

- 1 In the **SET UP** menu press **▼** until **PC Setting** is highlighted.
- 2 Press **OK** to select, then **▼** to highlight **Clock phase**.
- 3 Use **◀** or **▶** to adjust until the picture clears.

## Sampling Clock

Adjusting the **Sampling clock** alters the number of pulses per scan, this will clear vertical lines on the screen.

- 1 In the **SET UP** menu press **▼** until **PC Setting** is highlighted.
- 2 Press **OK** to select, then **▼** to highlight **Sampling clock**.

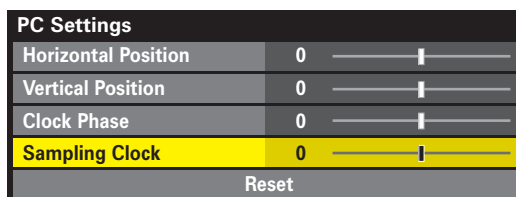

- 3 Use **◀** or **▶** to adjust until the picture clears.

**NOTE:** The screen may be momentarily disrupted when adjusting PC settings. The default settings and adjustment ranges may vary depending on the input signal format.

## Reset

To return to the original factory settings.

- 1 In the **SET UP** menu press **▼** until **PC Setting** is highlighted.
- 2 Press **OK** to select, then **▼** to highlight **Reset**.
- 3 Press **OK**.

**NOTE:** The screen will be disrupted momentarily when the PC settings are adjusted, this is not a sign of malfunction.

The default settings and adjustment ranges may vary depending on the input signal format.

### PLEASE NOTE

When a PC is connected using HDMI none of these functions will be available.



# REGZA-LINK controls

This feature uses CEC (Consumer Electronics Control) technology and allows the control of Toshiba REGZA-LINK compatible equipment from the television remote control. Note: not all Toshiba products currently support REGZA-LINK.

## REGZA-LINK Equipment Control

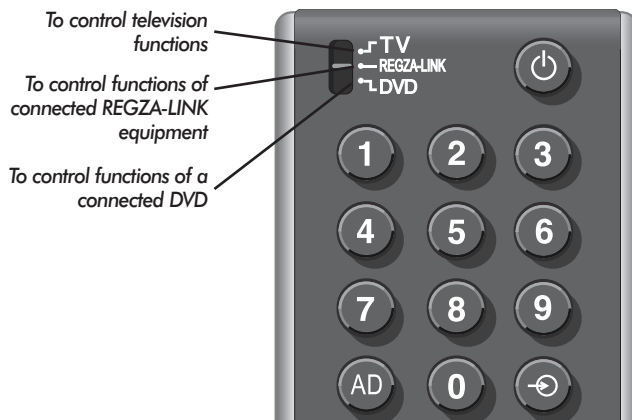

REGZA-LINK mode on the televisions remote control allows the control of connected REGZA-LINK equipment being watched.

To control the REGZA-LINK input source first select the equipment with REGZA-LINK input source selection, then switch the mode on the remote control to REGZA-LINK and press any buttons.

The available functions depend on the equipment connected. Not all the remote control keys may be available. Please refer to the operation manual for each piece of equipment connected.

The television features that can be controlled by the connected equipment are: Standby, Volume, Channel, Sound mute, Display information, Number buttons and Previous programme.

## REGZA-LINK Input Source Selection

When any equipment using CEC technology is connected the REGZA-LINK icon will show in the input source list allowing selection of individual devices.

- 1 Press and a list will appear on screen showing modes and all stored external equipment.
- 2 Press to highlight the input source showing the REGZA-LINK logo.

- 3 Press and a second selection screen will appear showing all connected REGZA-LINK equipment.

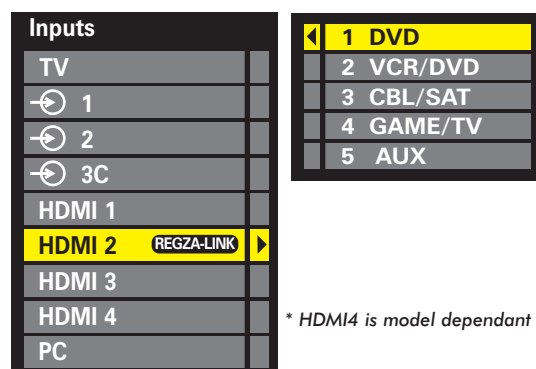

\* HDMI4 is model dependant

- 4 Use or to highlight an input source, then press **OK** to select.

**NOTE:** When the television is switched on it will take a few minutes for the REGZA-LINK logo to appear in the list, when an HDMI cable is removed it will take a few minutes for the logo to disappear.

**NOTE:** If the HDMI cable from connected equipment is changed or HDMI equipment settings are changed **Enable REGZA-LINK** in the REGZA-LINK setup menu may need to be reset to **On**.

When the REGZA-LINK input source is selected some REGZA-LINK equipment may automatically switch on.

The following features are dependent on the connected equipment. For operating information refer to the operation manual for all connected equipment.

# REGZA-LINK controls (continued), REGZA-LINK menus

By activating the Enable REGZA-LINK feature in the REGZA-LINK setup menu individual REGZA-LINK features can then be activated.

## REGZA-LINK One Touch Play

When connected equipment is switched on REGZA-LINK will automatically detect the television through the input selection. If the television is in standby it will be switched on automatically. This feature is selected in the **REGZA-LINK** setup menu.

**NOTE:** Even if the equipment is showing a menu the television may automatically show the input source.

**NOTE:** This feature is dependent on the connected equipment and television setting.

## REGZA-LINK System Standby

This feature automatically switches connected equipment into standby when the television goes into standby and conversely for the television to switch into standby when connected equipment goes into standby. It is selected in the **REGZA-LINK** setup menu.

**NOTE:** This feature is dependent on the connected equipment and television setting.

## REGZA-LINK System Audio Control

Using the Speaker Preference feature allows the televisions remote control to adjust the volume or mute the sound of the speakers connected to the television via an AV amplifier.

Ensure that the connected AV amplifier and REGZA-LINK equipment are selected in the input source selection and that the **Speaker Preference** is set to **Amplifier** in the **REGZA-LINK** setup menu.

**NOTE:** When the AV Amplifier is switched on, its input source changed or the volume adjusted, the sound will be output from the AV Amplifier's speakers even if **TV Speakers** has been selected. Turn the television off then on again to output the sound from the TV's speakers.

The full function may not work and is dependent on the Amplifier being used.

## REGZA-LINK PC link

This feature automatically adjusts the suitable widescreen formats and picture preferences when connected to a REGZA-LINK PC.

**NOTE:** This feature is dependent on the connected equipment.

## Enable REGZA-LINK

When **Enable REGZA-LINK** is set to **On** it allows the other functions to be enabled.

- 1 In the **PREFERENCES** menu press ▼ to select **REGZA-LINK Setup** then press **OK**.

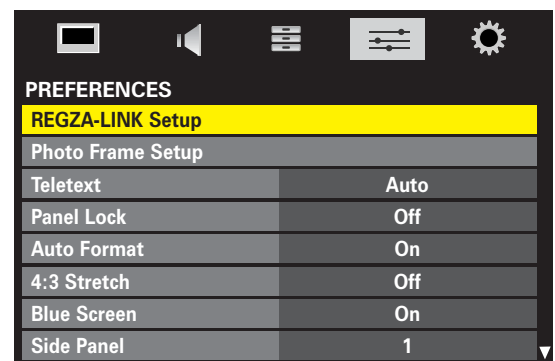

- 2 Press ▼ to highlight **Enable REGZA-LINK**, then ◀ or ▶ to select **On** or **Off**.

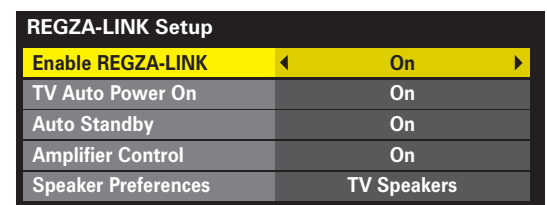

# REGZA-LINK menus

## TV Auto Power

The **TV Auto Power** setting allows the television to be automatically switched on or off if a REGZA-LINK device is turned on or off.

- 1 In the **PREFERENCES** menu press ▼ to select **REGZA-LINK Setup** then press **OK**.

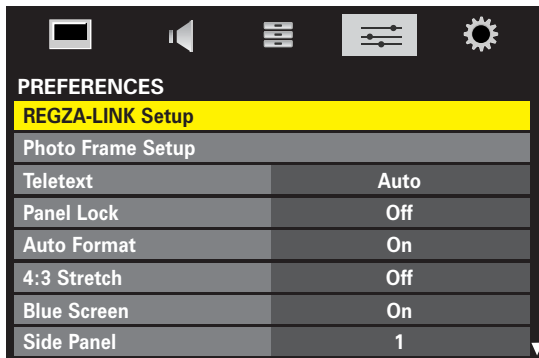

- 2 Press ▼ to highlight **TV Auto Power On**.

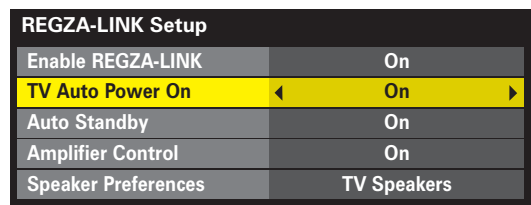

- 2 Press ◀ or ▶ to select **On** or **Off**.

## Auto Standby

When the **Auto Standby** is enabled the television when switched off will automatically switch off all connected REGZA-LINK equipment.

- 1 In the **REGZA-LINK Setup** menu press ▼ to highlight **Auto Standby**.

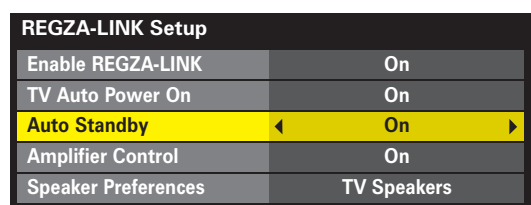

- 2 Press ◀ or ▶ to select **On** or **Off**.

## Amplifier Control

When **Amplifier Control** is enabled REGZA-LINK allows some of the amplifier features to be controlled with the television remote control.

- 1 In the **REGZA-LINK Setup** menu press ▼ to highlight **Amplifier Control**.

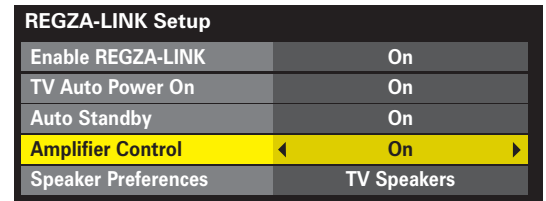

- 2 Press ◀ or ▶ to select **On** or **Off**.

## Speaker Preference

This feature allows the audio output preference to be set to the TV speakers or AV amplifier speakers. The AV Amplifier option lets the televisions remote control adjust or mute the volume of the audio.

- 1 In the **REGZA-LINK Setup** menu press ▼ to highlight **Speaker Preference**.

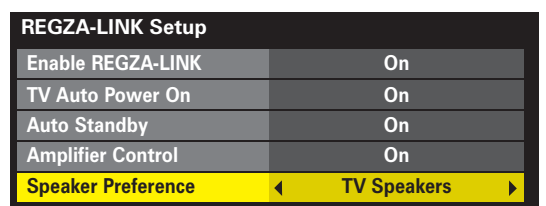

- 2 Press ◀ or ▶ to select **TV Speakers** or **Amplifier**.

# Input selection and AV connections

Defining the INPUT and OUTPUT sockets so that the television recognises connected equipment. See page 7 for a clear view of the back connection recommendations.



Most media recorders and decoder send a signal through the SCART lead to switch the television to the correct *Input* socket.

Alternatively press the external source selection button  until the picture from connected equipment is shown.



This button must be used to view equipment connected using the COMPONENT VIDEO INPUT (**EXT3C**).

An **S** in the display e.g.  **2S (EXT 2S)**, indicates the input is set for an S-Video signal.

## Input Selection



- At any time by pressing  a list will appear on screen showing modes and all stored external equipment. Use  or  to highlight and **OK** to select.

Pressing  on the remote control

Inputs
<b>TV</b>
 1
 2
 3C
HDMI 1
HDMI 2
HDMI 3
HDMI 4
PC

\* HDMI4 is model dependant

Pressing  on the TV side panel





Inputs
<b>DTV TV</b>
DTV RADIO
DTV TEXT
 1
 2
 3C
HDMI 1
HDMI 2
HDMI 3
HDMI 4
PC
ATV





HDMI displays equipment connected to *HDMI* on the back and side of the television.

PC displays a computer connected to *RGB/PC* on the back of the television.

## External input skip

This feature makes input selection more convenient.

- Press  to select the external input to be skipped (i.e.  1,  2 or  3C).

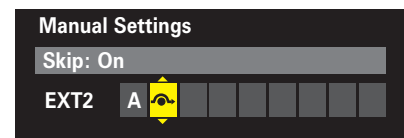

- In the **SETUP** menu press  to highlight **Manual Settings**, then press **OK**.
- Use  to select **Skip** then  or  to select **On**.



Press **EXIT**. The skipped input will now be greyed out on the Input list and will be skipped over when  is pressed to go through the list.

## INPUT Signal Selection

This specifies the type of signal going into SCART 2 (**EXT2**) on the back of the television. Please refer to the manufacturers instructions for the connected equipment.



- In the **SETUP** menu press  until **AV connection** is highlighted, then press **OK**.
- With  or  select either **AV** or **S-VIDEO** as the required *input* for **EXT2**.

AV Connection	
PC/HDMI1 Audio	PC
HDMI1 Audio	Digital
HDMI Settings	
<b>EXT2 Input</b>	<b>AV</b>
Woofer	Internal
Digital Audio Output	PCM

If the colour is missing try the alternative setting.

## PC Audio

To receive sound from a connected PC, plug the audio cable into the back of the television (see 'Connecting a computer' section), then use the **PC/HDMI1 Audio** setting.

- In the **AV connection** menu press  to highlight **PC/HDMI1 Audio**.
- Use to  or  select the **PC** option.

**NOTE:** Selecting the **PC** option will force HDMI into digital audio.

# Input selection and AV connections (continued)

## HDMI1 Audio

If the connected HDMI source does not support digital audio, plug the audio cable into **PC/HDMI1 (Audio)** on the back of the television (as shown in the 'Connecting an HDMI or DVI device to the HDMI input' section), then use the **HDMI1 Audio** setting.

- 1 In the **AV connection** menu press ▼ to highlight **PC/HDMI1 Audio** and using ► select **HDMI1**.
- 2 Press ▼ to highlight **HDMI1 Audio** and using ◀ or ► select **Auto**, **Digital** or **Analogue**.

AV Connection	
PC/HDMI1 Audio	HDMI1
<b>HDMI1 Audio</b>	<b>Auto</b>
HDMI Settings	
EXT2 Input	AV
Woofer	Internal
Digital Audio Output	PCM

If the sound is missing select an alternative setting.

**NOTE:** HDMI1 supports digital and analogue sound, HDMI2, HDMI3 and HDMI4 (Model dependant) are digital sound only.

Certain DVD disk formats may not output from this TV (32/44.1/48kHz and 16/20/24 bits are acceptable).

## HDMI Settings

The options in this features are only available when an HDMI input is selected (i.e. HDMI1, 2, 3 or 4). Some early HDMI equipment may not work properly with the HDMI television, setting the options in **HDMI Settings** to **Off** should help.

- 1 In the **AV connection** menu press ▼ to highlight **HDMI settings** then press **OK**.
- 2 Use ▲ or ▼ to select an option then ◀ or ► to select.

HDMI Settings	
<b>Lip Sync</b>	<b>On</b>
INSTAPORT™	On
RGB Range	Auto

### Lip Sync

Activates an audio/video display timing adjustment that allows HDMI devices to automatically synchronise accurately.

If the HDMI source does not support these features the television may not work properly when they are activated.

### INSTAPORT™

Reduces the log of switching times when switching HDMI sources.

### RGB Range

Adjusts RGB full range signal automatically. When **Limit** is selected the RGB signal's output range is 16 to 235. When **Full** is selected the RGB signal's output range is 0 to 255.

**NOTE:** If the HDMI connection is capable of 1080p and/or the television is capable of refresh rates greater than 50Hz or supports Deep Colour, a Category 2 cable will be required. Conventional HDMI/DVI cables may not work properly with this mode.

## Digital Output (optical)

When connecting a surround sound amplifier to the digital audio optical output (Sony/Philips Digital Interface Format [S/PDIF]) on the back of the television, the following options can be selected.

**PCM:** this mode outputs PCM format to the digital audio output socket.

**Auto:** this mode outputs audio format (eg. Dolby Digital) or PCM to the digital audio output socket providing it is being broadcast.

Dolby Digital → Dolby Digital  
Dolby Digital Plus → Dolby Digital  
MPEG → PCM  
HE-AAC → Dolby Digital

- 1 In the **AV connection** menu press ▼ to highlight **Digital Audio Output**.

- 2 Use ◀ or ► to select **PCM** or **Auto**.

**NOTE:** **Dolby Volume** will only be available when **Digital Audio Output** is set to **PCM**.

EIA/CEA-861-D compliance covers the transmission of uncompressed digital video with high-bandwidth digital content protection, which is being standardized for reception of high-definition video signals. Because this is an evolving technology, it is possible that some devices may not operate properly with the TV.

HDMI, the HDMI logo and High-Definition Multimedia Interface are trademarks or registered trademarks of HDMI Licensing, LLC. INSTAPORT™ and INSTAPORT logo are trademarks of Silicon Image, Inc. in the United States and other countries.

# ATV text services – selecting modes, general information, Auto and LIST modes

This television has a multi-page text memory, which takes a few moments to load. It offers two **Modes** of viewing text – **Auto** will display **Fastext**, if available. **LIST** will store your four favourite pages.

## Selecting Modes

The text character set will be automatically chosen by the language setting in the **SETUP** menu.

- 1 Select **Teletext** from the **PREFERENCES** menu.
- 2 With ◀ or ▶ choose **Auto** or **LIST** then press **EXIT**.

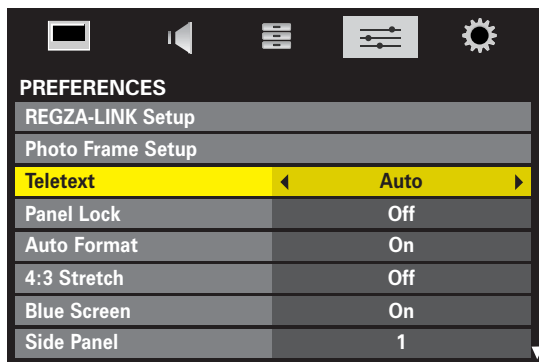

## Text Information

### The **TEXT** button:

To view text services press **TEXT**. Press again to superimpose the text over a normal broadcast picture and again to return to normal viewing. Channels cannot be changed until text is cancelled.

The first text page shown will be the *initial* page.

Any text page can be accessed by entering the 3 digit page number using the numbered buttons, pressing the coloured buttons or pressing **P** ^ to advance to the next page and **P** v to go back to the previous page.

Subtitles are available on page 888.

### Sub-pages

If there are sub-pages they will automatically load into memory without changing the page on screen. A bar with numbers will appear on the bottom of the screen.

If a text page with sub-pages is selected, the sub-pages are displayed in sequence automatically, pressing ◀ or ▶ will move through the sub-pages manually and cancel the automatic sequence.

The sub-page being viewed will be highlighted, as the television loads any additional sub-pages the page numbers will appear in the bar indicating that they have loaded.

These sub-pages will remain available to view until another page is chosen or, in normal TV mode, the channel is changed.

## Navigating Pages Using Auto

If **Fastext** is available four coloured titles will appear at the base of the screen.

To access one of the four given subjects, press the relevant coloured button on the remote control.

For further information on your particular text system(s), see the broadcast text index page or, consult your local Toshiba dealer.

## Navigating Pages Using LIST

The four coloured choices at the bottom of the screen are numbers – 100, 200, 300 and 400, which have been programmed into the television's memory. To view these pages press the relevant coloured buttons.

To *change* these stored pages press the relevant coloured button and enter the 3 digit number. This number will change in the top left of the screen and in the coloured highlight.

Press **OK** to store. **Whenever OK is pressed all four page numbers showing at the bottom will be stored and the previous ones will be lost.**

If **OK** is not pressed the selection will be forgotten when text is cancelled.

Other pages may be viewed by entering the 3 digit page number – but **DO NOT** press **OK** or these pages will be stored.



# ATV text services – control buttons

## DTV interactive services

Below is a guide to the functions of the remote control text buttons.



To display the index/initial page:

Press  to access the index/initial page. The one displayed is dependant on the broadcaster.

**TEXT** To display a page of text:

Press **TEXT** to display text. Press again to superimpose text over a normal picture. Press again to return to normal television viewing. Programmes cannot be changed until this has been done.





To reveal concealed text:

To discover the solutions on quiz and joke pages press the  button.



To hold a wanted page:

At times it is convenient to hold a page of text. Press  and  will appear in the top left of the screen. The page will be held on screen until the button is pressed again.





To enlarge the text display size:



Press  once to enlarge the top half of the page, press again to enlarge the bottom half of the page. Press again to revert to normal size.



To select a page whilst viewing a normal picture:

Enter the page number then press , a normal picture will be displayed. The television will indicate when the page is present by displaying the page number at the top of the screen. Press  to view the page.

To display news flashes:

Select the news flash page for the chosen text service (see the index page of text service). Press . The news flashes will be displayed as and when they are broadcast. Press  again to cancel the display.

**The news flash page must be cancelled before changing programmes.**



**Remember to cancel text before changing channels – press the TEXT button twice.**

## DTV Interactive Services

The **digital** interactive services are the up-to-date way of viewing service information, using computer-style formats, incorporating pictures and interactive views.

They offer high quality on-screen images with multi-colour photographic still images, advanced text and graphics and are user-friendly. These services are free to anyone with a digital television, however, they are not available for all digital stations and are dependant on the broadcaster.

- 1 Ensure that **digital** mode has been selected. Press **TEXT**, it may take a few moments to load.
- 2 To navigate the pages and use the pull-down menus, use the coloured buttons and ▲, ▼, ◀ and ▶ as directed.
- 3 Press **TEXT** again at any time to cancel.



# Questions and Answers

Below are the answers to some of the most common queries.

For more information go to [www.toshiba.co.uk](http://www.toshiba.co.uk)

**Q** Why is there no sound or picture?

**A** If the **RED** LED is unlit check that the mains plug is connected to the power supply and press the **POWER** button on the left side of the television. Then press **POWER** on the remote control, it may take a few moments, the **GREEN** LED will be lit.

**Q** Why doesn't the remote control work?

**A** Check the batteries aren't discharged completely or inserted incorrectly.

**Q** Why don't the controls on the front of the television work?

**A** Check that **Panel lock** is not **On**.

**Q** Why is **DTV** unavailable?

**A** Another mode is selected. Press **DTV** to select **DTV**.

**Q** Why is there a message permanently on the screen?

**A** Remove it by pressing **i+**.

**Q** Why is there a picture but no sound?

**A** Check all lead connections.  
Check the volume has not been turned down or that sound mute has not been selected.

**Q** Why doesn't the media being played show on screen?

**A** Make sure the media player is connected to the television as shown on page 7, then select the correct input by pressing **INPUT**.

**Q** Why is the media picture in black and white?

**A** Check the correct **input** has been chosen, **S-VIDEO** or **AV**. See **AV connections** page 50.

**Q** Why did the picture stop while recording via scart?

**A** Check whether the **STOP** button was pressed while recording was in progress.

**Q** What else can cause a poor **analogue** picture?

**A** Interference or a weak signal. Try a different television station. **Manual Fine Tuning** may help.

**1** Select the **ATV Manual Tuning** menu. Highlight the station and press **OK**, then press **▶** to select **Manual Fine Tuning**.

**2** Using **▲** or **▼** adjust to get the best picture and sound. Press **OK** and then **EXIT**.

**Q** There is a picture, but why is there little or no colour?

**A** When using an **external** source, for instance, a poor quality video tape, if there is little or no colour, improvements may sometimes be achieved. The colour is factory set to **Auto**, to automatically display the best colour system. To check that you have the best colour:

**1** With the external source playing, select **Manual Settings** from the **SETUP** menu.

**2** With **▲** or **▼** choose between **Auto**, **PAL**, **SECAM**, **NTSC 4. 43** or **3. 58**.

**Q** Why is there no sound or picture when in **HDMI** mode?

**A** Make sure that the cables used have the **HDMI** logo on them (**HDMI**).

Some early **HDMI** equipment may not work properly with the latest **HDMI** television products, due to new standard adoption. Try setting **Lip Sync**, **INSTAPORT™** and **RGB Range** to **Off**.

# Questions and Answers (continued)

**Q** Why are the colours wrong when an NTSC source is played?

**A** Connect the source via a SCART lead and play. Select **Manual Settings** from the **SETUP** menu.

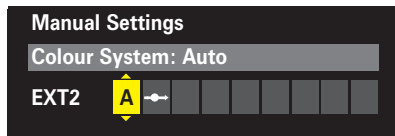

- 1** Set the Colour to **Auto** and exit.
- 2** Go to the **Picture settings** menu and adjust the tint.

**Q** Why can popping noises be heard or blocks appear on the screen?

**A** This is usually due to poor signal reception. Check the aerial/antenna connections and that the aerial has not moved direction. An aerial/antenna upgrade may be required in order to receive all available services.

**Q** Why is there a square shaped picture on the widescreen television?

**A** Some television programmes are transmitted in 4:3, in particular older programmes. Turning **Autoformat** off will stop the television showing native picture sizes.

**Q** Why can television channels be seen in the dark background areas when playing DVDs?

**A** This is usually due to poor connection leads (scart/HDMI) being used. Check all connections.

**Q** Why are there vertical stripes on the screen in PC mode?

**A** The **Sampling clock** may need adjustment. Select **PC Setting** from the **SET UP** menu, highlight **Sampling clock** and adjust until the lines clear.

**Q** Why are there horizontal stripes and/or blurred images on the screen in PC mode?

**A** The **Clock phase** may need adjustment. Select **PC Setting** from the **SET UP** menu, highlight **Clock phase** and adjust until the picture clears.

**Q** Why is there a good media picture but no sound?

**A** Check all lead connections.

**Q** Why is there no sound when the PC is connected?

**A** Check all leads and connections.  
Note: No sound is output from a DVI connection (if using a DVI to HDMI lead). The audio input connection must also be used.

**Q** Why is the soundtrack in English when a different audio language has been selected?

**A** The programme is currently being broadcast with an English soundtrack only.

**Q** Why is there incorrect or no sound when in DTV mode?

**A** Press  $\odot$  I/II to check if another audio track has been selected.

**Q** Why when **digital** subtitles have been selected are they not showing on screen?

**A** Subtitles are not currently being transmitted by the broadcaster.

**Q** Why is Digital Audio output for?

**A** This is a superior connection for connecting to an audio sound system and allows transmission of multichannel sound.

**Q** Why is the **digital** channel locked?

**A** The channel has been locked in **Channel Options** (see 'Digital Settings' section).

**Q** Why are some of the **digital** subscription channels unavailable?

**A** Your subscription needs upgrading. Contact your service provider.

# Questions and **Answers** (continued)

**Q** Why do other people receive a different number of digital channels?

**A** Different areas can receive different numbers of channels depending on the local transmissions. These can be checked on internet sites such as [www.ukfree.tv](http://www.ukfree.tv)

**Q** When tuning channels why are the channel numbers not in sequential order?

**A** In the UK **DTV** channel numbers are allocated by the broadcasters.

**Q** Why is there no **digital** text service?

**A** The **digital** channel being viewed is not broadcasting digital text. Try another **digital** channel.

**Q** Why are there problems with **analogue** text?

**A** Good performance of text depends on a good strong broadcast signal. This normally requires a roof or loft aerial. If the text is unreadable or garbled, check the aerial. Go to the *main index* page of the text service and look for the *User Guide*. This will explain the basic operation of text in some detail. If further information is needed on how to use text see the *text section*.

**Q** Why are the four coloured text numbers visible but no text?

**A** Text has been selected whilst viewing an external source i.e. DVD or VCR. No text will appear on screen or a box may appear stating no information is available. Select a broadcasting channel and press **TEXT** to access.

**Q** Why can't teletext be accessed when using a media recorder?

**A** Teletext is only available when viewing a broadcasting channel.

**Q** What is DVB-T?

**A** Digital Video Broadcast via an aerial/antenna.

**Q** What is DVB-C?

**A** Digital Video Broadcast via a cable connection (if available).

**Q** How are radio channels selected?

**A** Press **ATV/DTV** on the remote control and select **DTV RADIO**. Alternatively select from the **GUIDE**.

**Q** What does AD mean?

**A** Audio Description is a detailed narrative sound track, which is only available if being broadcast with the programme being watched.

**Q** What is a CI slot?

**A** The Common Interface slot is for pay per view services via a conditional access module. Contact your local service provider for further details.

**Q** Is the television HD?

**A** Yes, all Toshiba Regza LCD televisions are HD ready. A suitable HD decoder or similar is required to supply the television with an HD signal.

**Q** How can external speakers be connected?

**A** This is not an available option.

**Q** How can the signal be output via HDMI sockets?

**A** No HDMI connections are available from the television. An appropriate decoder or similar is required.

**Q** Why are the phono inputs different colours?

**A** Phono inputs are shown in different colours in order to identify the type of connection, i.e. red/white is usually left/right sound connections. Ensure colours are matched with the external equipment outputs.

# Questions and Answers (continued)

**Q** Why are the LEDs on the front of the television flashing?

**A** Check the table below.

LED indication			Condition	Solution
LED-3	LED-2	LED-1		
Orange (Solid)	Green (Solid)	Green (Solid)	Power ON On Timer is set Programme Timer is set	—
Red (Solid)	Green (Solid)	Green (Solid)	Power ON On Timer is set Programme Timer is working	—
OFF	Green (Solid)	Green (Solid)	Power ON On Timer is set Programme Timer is NOT set	—
Orange (Solid)	OFF	Green (Solid)	Power ON On Timer is NOT set Programme Timer is set	—
Red (Solid)	OFF	Green (Solid)	Power ON On Timer is NOT set Programme Timer is working	—
OFF	OFF	Green (Solid)	Power ON On Timer is NOT set Programme Timer is NOT set	—
Orange (Solid)	Green (Solid)	Red (Solid)	Power OFF (Standby) On Timer is set Programme Timer is set	—
Red (Solid)	Green (Solid)	Red (Solid)	Power ON (Standby) On Timer is set Programme Timer is working	—
OFF	Green (Solid)	Red (Solid)	Power OFF (Standby) On Timer is set Programme Timer is NOT set	—
Orange (Solid)	OFF	Red (Solid)	Power OFF (Standby) On Timer is NOT set Programme Timer is set	—
Red (Solid)	OFF	Red (Solid)	Power ON (Standby) On Timer is NOT set Programme Timer is working	—
OFF	OFF	Red (Solid)	Power OFF (Standby) On Timer is NOT set Programme Timer is NOT set	—
OFF	OFF	Red Blinks	Power protect detection	Turn OFF the TV and unplug the power cord. Plug the power cord in again and turn ON the TV

**Q** How can a camera/camcorder be connected?

**A** These can be plugged into the connections on the side of television.

**Q** Why doesn't REGZA-LINK work?

**A** If settings on connected REGZA-LINK equipment are changed the equipment may fail to work correctly with television. Removing the HDMI cable then replacing it may help. If not turn off the television, remove the power cable from the wall socket, then plug the television back in and switch on.

**Q** Will other manufacturers AV equipment work with REGZA-LINK (SKY, Home Cinema etc)?

**A** Most AV equipment with CEC link should function correctly, however only Toshiba products are assured to work.

**Q** Why is there a red light on the back of the television and is it dangerous?

**A** This is the optical Digital Audio output. Avoid contact with the eyes for any extended period of time.

**Q** What can be done if the PIN number has been forgotten?

**A** Use the Master PIN code of 1276, then change to a number of your choice. Ensure that no-one else can use the Master PIN by removing the Owner's Manual.

**Q** Where is the Serial number/model name located?

**A** The serial number is located centrally at the rear of the television. It is also printed on the carton box supplied.

**Q** Why does the television get hot?

**A** As with any device using lamps or similar, the television will output a certain amount of heat.

# Questions and **Answers** (continued)

**Q** Where can replacement parts be purchased?

**A** Contact your local dealer or the Toshiba helpline number.

**Q** What is the best way to clean the screen and bezel?

**A** Use a lint free cleaning cloth, similar to the one provided. Use a non solvent cleaning product.

**Q** Are floor stands available?

**A** Yes, these can be purchased from shops or directly from Toshiba Information Systems (UK) Ltd.

**Q** Can the television be hung on the wall?

**A** Yes, using an appropriate Vesa wall bracket. These are readily available from shops and the internet.

## IN NEED OF HELP

For television  
operation queries,  
please ring the  
helpline...

Toshiba customer helpline  
  
0844 856 0730

### DISPOSAL...

**The following information is only for EU-member states:**

#### **Disposal of products**

The crossed out wheeled dust bin symbol indicates that products must be collected and disposed of separately from household waste. Integrated batteries and accumulators can be disposed of with the product. They will be separated at the recycling centres.

The black bar indicates that the product was placed on the market after August 13, 2005.

By participating in separate collection of products and batteries, you will help to assure the proper disposal of products and batteries and thus help to prevent potential negative consequences for the environment and human health.

For more detailed information about the collection and recycling programmes available in your country, please contact your local city office or the shop where you purchased the product.

#### **Disposal of batteries and/or accumulators**

The crossed out wheeled dust bin symbol indicates that batteries and/or accumulators must be collected and disposed of separately from household waste.

If the battery or accumulator contains more than the specified values of lead (Pb), mercury (Hg), and/or cadmium (Cd) defined in the Battery Directive (2006/66/EC), then the chemical symbols for lead (Pb), mercury (Hg) and/or cadmium (Cd) will appear below the crossed out wheeled dust bin symbol.

By participating in separate collection of batteries, you will help to assure the proper disposal of products and batteries and thus help to prevent potential negative consequences for the environment and human health.

For more detailed information about the collection and recycling programmes available in your country, please contact your local city office or the shop where you purchased the product.



# Specifications and accessories

## DVB-T Broadcast systems/channels

UK	UHF 21-68
France	VHF 05-10 (VHF 01-05) UHF 21-69
Germany	VHF 05-12 UHF 21-69
Austria	VHF 05-12 UHF 21-69
Switzerland	VHF 05-12 UHF 21-69
Italy	VHF 05-12 (D,E,F,G,H,H1,H2) UHF 21-69
Spain	UHF 21-69
Netherlands	VHF 05-12 UHF 21-69
Sweden	VHF 05-12 UHF 21-69
Finland	VHF 05-12 UHF 21-69
Greece	VHF 05-12 UHF 21-69

**Video Input** PAL, SECAM, NTSC 3.58/4.43

## External connections

EXT1	Input	21-pin SCART	RGB, A/V
EXT2	Input/Output	21-pin SCART	A/V, S-video Selectable output (Scart output best suited for analogue channels)
EXT3	Input	Phono jacks Phono jacks	Y, P <sub>B</sub> /C <sub>B</sub> , P <sub>R</sub> /C <sub>R</sub> Audio L + R
EXT3	Input (Side)	Phono jacks Phono jacks	Video, S-Video Audio L + R
HDMI1/2/3	Input	HDMI (Audio LIP SYNC, INSTAPORT™, RGB Range supported)	
HDMI4	Input (Side) (Model dependant)	HDMI (Audio LIP SYNC, INSTAPORT™, RGB Range supported)	
PC	Input	Mini D-sub 15-pin	Analog RGB signal
PC/HDMI1 Audio		3.5mm mini jack	Audio
Digital Audio Output (S/PDIF)		Optical	
USB Port		USB Class: Mass Storage File System: FAT 12/16/32	
SD Card Slot		Supported media: SD Memory Card 8MB-2GB SDHC Memory Card 4GB-32GB	

## Broadcast systems/channels

PAL-I	UHF UK21-UK69
PAL-B/G	UHF E21-E69 VHF E2-E12, S1-S41
SECAM-L	UHF F21-F69 VHF F1-F10, B-Q
SECAM-D/K	UHF R21-R69 VHF R1-R12

## Stereo

Nicam  
2 carrier system

## Visible Screen Size (approx.)

37 XV 94cm  
42 XV 107cm  
46 XV 117cm

## Display

16:9

## Sound output (at 10% distortion)

Main 10W + 10W

## Power consumption (approx.)

37 XV 126W  
42 XV 144W  
46 XV 167W

## Standby (approx.)

37 XV 0.7W  
42 XV 0.7W  
46 XV 0.6W

## Dimensions (approx.)

37 XV 64cm (H) 91cm (W) 27cm (D)  
42 XV 71cm (H) 101cm (W) 32cm (D)  
46 XV 76cm (H) 111cm (W) 32cm (D)  
(Height dimension includes foot stand)

## Weight (approx.)

37 XV 17kg  
42 XV 23kg  
46 XV 25kg

## Headphone socket

3.5mm stereo

## Accessories

Remote control  
2 batteries  
(AAA, IEC R03 1.5V)  
Cleaning Cloth  
P Clip

## Remember...

For television  
operation queries,  
please ring the  
helpline...



**0844 856 0730**

**UK ONLY**

DivX® is a registered trademark of DivX, Inc., and is used under license.



SD Logo is a trademark

**DVB is a registered trademark of the DVB Project**

© Toshiba Information Systems (UK) Limited

All rights reserved. Reproduction in whole or part without written permission is strictly prohibited.

Origination by Zushi Digital, Bristol, UK.

**Toshiba Information Systems (UK) Limited**

Consumer Products Division,  
Toshiba Court, Weybridge Business Park,  
Addlestone Road, Weybridge,  
Surrey, KT15 2UL, England

Specification is subject to change without notice.

**VX1A00138300**

## Free Manuals Download Website

<http://myh66.com>

<http://usermanuals.us>

<http://www.somanuals.com>

<http://www.4manuals.cc>

<http://www.manual-lib.com>

<http://www.404manual.com>

<http://www.luxmanual.com>

<http://aubethermostatmanual.com>

Golf course search by state

<http://golfingnear.com>

Email search by domain

<http://emailbydomain.com>

Auto manuals search

<http://auto.somanuals.com>

TV manuals search

<http://tv.somanuals.com>