

TOSHIBA

NETWORK CAMERA

Model **IK-WB02A**

Safety Precautions



*A lens is not supplied with the network camera.

For information on the latest products and peripheral devices, refer to the following Web page.

■ <http://www.netcam.toshiba.com>

- The above URL is subject to change without prior notice. If the URL changes, refer to the Toshiba website (<http://www.cctv.toshiba.com>).
- The Operations Manual for this product is included on the supplied mini CD-ROM.
- These Safety Precautions apply to firmware version R 1.01 and later.

FCC(US) Information



Tested To Comply
With FCC Standards

FOR HOME OR OFFICE USE

Product Name : NETWORK CAMERA

Model Number(s) : IK-WB02A

FCC Notice “Declaration of Conformity Information”

This device complies with part 15 of the FCC Rules.

Operation is subject to the following two conditions :

- (1) This device may not cause harmful interference, and
- (2) this device must accept any interference received, including interference that may cause undesired operation.

Toshiba America Information System, Inc.

Security & Network Video Products

9740 Irvine Boulevard,

Irvine, California 92618-1697

(877)696-3822

This equipment has been tested and found to comply with the limits for a Class B digital device, pursuant to part 15 of the FCC Rules. These limits are designed to provide reasonable protection against harmful interference in a residential installation. This equipment generates, uses and can radiate radio frequency energy and, if not installed and used in accordance with the instructions, may cause harmful interference to radio communications. However, there is no guarantee that interference will not

occur in a particular installation. If this equipment does cause harmful interference to radio or television reception, which can be determined by turning the equipment off and on, the user is encouraged to try to correct the interference by one or more of the following measures:

- Reorient or relocate the receiving antenna.
- Increase the separation between the equipment and receiver.
- Connect the equipment into an outlet on a circuit different from that to which the receiver is connected.
- Consult the dealer or an experienced radio/TV technician for help.

Warning : Changes or modifications made to this equipment, not expressly approved by Toshiba or parties authorized by Toshiba could void the user's authority to operate the equipment.

Canadian Information

Industry Canada

This Class B digital apparatus complies with Canadian ICES-003.

Cet appareil numérique de la classe B est conforme à la norme NMB-003 du Canada.

Introduction

Thank you for purchasing the IK-WB02A Network Camera.

Before you start using the camera, read these Safety Precautions carefully to ensure correct usage. Once you have finished reading these Safety Precautions, keep it in a convenient place for future reference.

The design, specifications, software, and manual contents are subject to change without prior notice.

Some pictures and illustrations contained herein may slightly differ from the actual images.

Terms and Trademarks

- The term “OS” is used in the Operations Manual to indicate operating systems compatible with this product.
 - Windows 2000: Microsoft® Windows® 2000 operating system
 - Windows XP: Microsoft® Windows® XP operating system
- The formal name of Windows® is Microsoft® Windows® Operating System.
- Microsoft® and Windows® are trademarks or registered trademarks of Microsoft® Corporation in the United States and other countries.
- Adobe is a registered trademark and Acrobat Reader is a trademark of Adobe Systems Incorporated.
- Other product names appearing in these Safety Precautions or the Operations Manual may be trademarks or registered trademarks of their respective holders.

Accessories

Confirm that all of the following accessories have been supplied with the network camera.

Mini CD-ROM (x1)

*Includes the Operations Manual and the software Camera Finder.

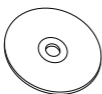

IRIS connector (x1)

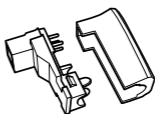

Safety Precautions and Quick Start Guide (this document) (x1)

*The Quick Guide is at the back of the Safety Precautions.



WARRANTY (x1)

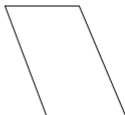

EMI core

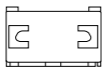

(x3)

For details on how to use the EMI core, refer to "How to use EMI core" on the mini CD-ROM.

About the POWER SELECT Switch (x1)

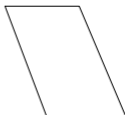



Table of Contents

Introduction... ..	4
Table of Contents	6
IMPORTANT SAFEGUARDS	7
NOTES ON USE AND INSTALLATION	11
Precautions for Use	12
Camera Installation Guide	15

For details on settings, operations, etc, refer to the Operations Manual (PDF file) included on the mini CD-ROM.

Acrobat Reader is required to view the PDF file. If you do not have Acrobat Reader, download it from the Web site of Adobe Systems Incorporated.

IMPORTANT SAFEGUARDS

1. Read Instructions

All the safety and operating instructions should be read before the product is operated.

2. Retain Instructions

The safety instructions and instruction manual should be retained for future reference.

3. Heed Warnings

All warnings on the product and in the instruction manual should be adhered to.

4. Follow Instructions

All operating and use instructions should be followed.

5. Cleaning

Disconnect this video product from the power supply before cleaning.

6. Attachments

Do not use attachments not recommended by the video product manufacturer as they may cause hazards.

7. Water and Moisture

Do not use this video product near water-for example, near a bath tub, wash bowl, kitchen sink, or laundry tub, in a wet basement, or near a swimming pool and the like.

8. Accessories

Do not place this video product on an unstable cart, stand, tripod, bracket or table. The video product may fall, causing serious injury to a child or adult, and serious damage to the product. Use only with stand, tripod, bracket, or table recommended by the manufacturer, or sold with the video product. Any mounting of the product should follow the manufacturer's instructions, and should use a mounting accessory recommended by the manufacturer.

IMPORTANT SAFEGUARDS (Cont.)

9. Ventilation

This video product should never be placed near or over a radiator or heat register. This video product should not be placed in a built-in installation such as a bookcase or rack unless proper ventilation is provided or the manufacturer's instructions have been adhered to.

10. Power Sources

This video product should be operated only from the type of power source indicated on the marking label. If you are not sure of the type of power supply to your location, consult your product dealer.

11. Power-Cord Protection

Power-Supply cords should be routed so that they are not likely to be walked on or pinched by items placed upon or against them, paying particular attention to cords at plugs, screws and the point where they exit from the product.

12. Lightning

For added protection for this video product during a lightning storm, or when it is left unattended and unused for long periods of time, unplug it from the wall outlet and disconnect the power supply and cable system. This will prevent damage to the video product due to lightning and power-line surges.

13. Overloading

Do not overload power supply and extension cords as this can result in a risk of fire or electric shock.

14. Object and Liquid Entry

Never push objects of any kind into this video product through openings as they may touch dangerous voltage points or short-out parts that could result in a fire or electrical shock. Never spill liquid of any kind on the video product.

15. Servicing

Do not attempt to service this video product yourself as opening or removing covers may expose you to dangerous voltage or other hazards. Refer all servicing to qualified service personnel.

16. Damage Requiring service

Disconnect this video product from the power supply and refer servicing to qualified service personnel under the following conditions.

- a. When the power-supply cord or plug is damaged.
- b. If liquid has been spilled, or objects have fallen into the video product.
- c. If the video product has been exposed to rain or water.
- d. If the video product does not operate normally by following the operating instructions in the instruction manual. Adjust only those controls that are covered by the instruction manual as an improper adjustment of other controls may result in damage and will often require extensive work by a qualified technician to restore the video product to its normal operation.
- e. If the video product has been dropped or the cabinet has been damaged.
- f. When the video product exhibits a distinct change in performance-this indicates a need for service.

17. Replacement Parts

When replacement parts are required, be sure the service technician has used replacement parts specified by the manufacturer with the same characteristics as the original part. Unauthorized substitutions may result in fire, electric shock or other hazards.

18. Safety Check

Upon completion of any service or repairs to this video product, ask the service technician to perform safety checks to determine that the video product is in proper operating condition.

IMPORTANT SAFEGUARDS (Cont.)



The CAUTION label, shown on the above part, is attached on the bottom of camera.



The lightning flash with arrowhead symbol, within an equilateral triangle, is intended to alert the user to the presence of uninsulated "dangerous voltage" within the product's enclosure that may be of sufficient magnitude to constitute a risk of electric shock to persons.



The exclamation point within an equilateral triangle is intended to alert the user to the presence of important operating and maintenance (servicing) instructions in the literature accompanying the appliance.

WARNING:

TO REDUCE THE RISK OF FIRE OR ELECTRIC SHOCK, DO NOT EXPOSE THIS APPLIANCE TO RAIN OR MOISTURE.

•CAUTION

CONNECT 24V AC UL LISTED CLASS 2 POWER SUPPLY.

FIELD INSTALLATION MARKING:

WORDED : "THIS INSTALLATION SHOULD BE MADE BY A QUALIFIED SERVICE PERSON AND SHOULD CONFORM TO ALL LOCAL CODES."

Note: The camera is designed for indoor use.

NOTES ON USE AND INSTALLATION

- **Do not aim the camera at the sun**

Do not aim the camera at the sun or point it at sun even if you are not shooting.

- **Do not shoot intense light**

Intense light such as a spotlight may cause a bloom or smear. A vertical stripe may appear on the screen. However, this not a malfunction.

- **Treat the camera with care**

Do not drop the camera or subject it to strong shock or vibration. Otherwise, the camera may malfunction.

- **Never touch internal parts**

Do not touch the internal parts of the camera other than the parts specified. Otherwise, the camera may malfunction.

- **Do not splash water on the camera**

Install the camera where the camera can be kept dry. If the camera gets wet, turn off the power and contact your dealer.

- **Install the camera**

Where no video noise appears

If cables are wired near electric lighting wires or a TV set, noise may appear in images. In this event, relocate cables or reinstall equipment.

- **Check the ambient temperature and humidity**

Avoid using the camera where the temperature is hotter or colder than specified. Otherwise, the quality of images may deteriorate or internal parts may be affected. Special care is required to use the camera at high temperature and humidity.

- **Should you notice any trouble**

If any trouble occurs while you are using the camera, turn off the power and contact your dealer. Continued use in this state might cause fire or electric shock. For details on repair, consult the place of purchase, or please contact the technical support number.

Precautions for Use

About the SD Memory Card

- There is a limit to the number of rewrites that is possible with the SD memory card. Replacing of the SD memory card when performing periodic maintenance of the camera is recommended.
- The camera supports the following SD memory cards. Do not use memory cards with other specifications.
SD memory card: 64MB, 128MB, 256MB and 512MB SD memory cards (3.3 V) supported.
Physical interface: Part 1. Physical Layer Specification; Version 1.01
- Images may not be recorded or read correctly if an unsupported SD memory card is used with the camera.
- Carefully read the User's guide, precautions on use, and any other information supplied with a purchased memory card.
- An SD memory card can be used for the loop recording of images. The life-span (number of rewrites possible) of an SD memory card is greatly affected by the capacity of the SD memory card. The use of a 128MB, 256MB or 512MB large-capacity SD memory card is recommended for loop recording.
- To achieve maximum performance of the camera, the use of a Toshiba SD memory card is recommended. If a card of another company is used, the recording intervals may lengthen and the erasure time during overwriting may increase. As a

result, the number of delivered frames of live video may decrease.

- Do not use a memory card containing the data recorded by another device with the camera as this may result in the camera not functioning correctly.
- Do not modify, overwrite the data, or change the folder name of an SD memory card. It may result in the camera not functioning correctly.
- Data recorded with the camera do not comply with the image file format Exif and the DCF standard. If the SD memory card is to be removed to play images, use a personal computer to play the images. Other devices may not be capable of displaying the images.

About the AC Adapter

- An AC adapter is not supplied with this model. If you want to use an AC adapter, you will need to provide an adapter with DC12V output or AC24V output that is capable of supplying at least 10 W.

About the PoE Power Supply Device

- A PoE power supply device is required for supplying power to the camera via the LAN cable.

Precautions for Use (Cont.)

About the software

This product contains a piece of software (hereafter the Software) licensed to TOSHIBA CORPORATION (hereafter TOSHIBA) by TOPCO CORPORATION. (hereafter TOPCO).

The copyright and other intellectual property rights of the software are held by TOPCO or the licensor.

The software is protected by the Copyright Law, Universal Copyright Convention, and other intellectual property laws and agreements. The permission of TOPCO or the licensor must therefore be obtained before the software can be reproduced.

Note, however, that the software is partly covered under the GNU General Public License Version 2 (hereafter GPL2). You can obtain a copy of GPL2 at <http://www.fsf.org/copyleft/gpl.html>. TOPCO will provide the GPL-covered source code of the software in accordance with the terms of GPL2. Contact TOPCO if you need it for more information.

Camera Installation Guide

Installation Example

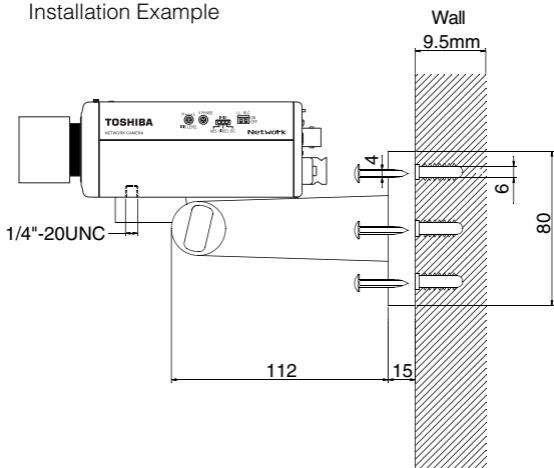

EIM-0010325 4/26/2000

The Installation Guide is for reference only.
Mounting bracket is not included.

TOSHIBA AMERICA INFORMATION SYSTEMS. INC

Security & Network Video Products

9740 Irvine Boulevard,

Irvine California 92618-1697

Phone Number: (877)696-3822

TOSHIBA

NETWORK CAMERA

Model: IK-WB02A

Operation Manual



*A lens is not supplied with the network camera.

To get started, read the separate “Safety Precautions” carefully.

For information on the latest products and peripheral devices, refer to the following Web page.

■<http://www.netcam.toshiba.com>

The above URL is subject to change without prior notice. If the URL changes, refer to the Toshiba website (<http://www.cctv.toshiba.com>).

This User's Guide applies to the firmware version R1.01 and later.

Table of Contents

●Table of Contents	2
●Important Safety Instructions	4
●Names and Features of Parts	5

Installation/Set up

●Installing a Lens/Connecting to a Video Monitor	8
• Installing a Lens	8
• Connecting to a Video Monitor	8
●Line-Lock control	9
●Adjusting a Lens	10
• Adjusting the Back Focus	10
• Adjusting the Iris	10
• Auto Iris Lens	10
• Fixed iris lens	11
• Back Light Compensation	11
• Auto White Balance (AWB)	11
●Setting Up the Network Camera Environment	12
• Requirements for Network Camera Monitoring System	12
●Connecting the Camera and Personal Computer by Network	13
• About the IP Address	13
• Structure of Connection	14
• Connecting	15
●Using the Camera Search Application “Camera Finder”	16
●Changing Administrator Login ID and Password	18
●Setting up Access Restriction	20
●Configuring the Network Manually	22

Viewing • Listening and Operation

●Viewing and Listening	26
• Viewing Images	26
• Audio Listening	26
• Camera Window Screen	27
• Menu that is displayed when right-clicking on the image	27
• Adjusting Images on the Camera	28
• Adding Images	30
●Using Playback Function	31
●Playing Alarm Images	32
●Playing Recorded Normal Images	33
●Viewing Logs	34
●Speaking	35

Recording

●About Recording Images	38
●Recording Images on an SD Memory Card	39
• Recording Settings	39
●Recording Images on FTP Server	41
• Record Settings	41
• Periodic FTP by Schedule	44
• FTP by External Alarm/Motion Detection	46

Installation/Set up

Viewing • Listening and Operation

Recording

Setting up

Others

• FTP by EXT Control (Recording Data by EXT Control)	48
• Image Accumulation to SD Memory Card	49
● File Transfer Order	50
• Periodic FTP by Schedule	50
● Recording Images on a Personal Computer	51
• Image Recording Feature	51
• Recording Current Image Data as Still Image	53

Setting up

● How to Set up	56
• General Configuration	56
● System Settings	57
• Restoring the default settings	58
• Rebooting the network camera	58
• Updating the Firmware	59
• Click “Firmware update”	59
• Importing the Settings Saved on a Personal Computer	59
● User Settings	60
● Admin Settings	62
● Alarm Settings	64
● Network Settings	66
● Mail Settings	68
● FTP Client Settings	70
● FTP Server Settings	71
● DDNS Settings	72
● Recording Settings	73
● Audio Settings	74
● Updating the Firmware	75
● Saving the Settings on a Personal Computer	77
• Importing the Settings Saved on a Personal Computer	78

Others

● Alarm Terminals	80
● Index (Glossary)	82
● Display of Logs	86
● Before Calling Service Personnel... ..	88
● Specifications	95
● Appearance Diagram	96

Important Safety Instructions

Be sure to read “IMPORTANT SAFEGUARDS” in the separate “Safety Precautions.”

Installation/Set up

Viewing • Listening
and Operation

Recording

Setting up

Others

Names and Features of Parts

●Front

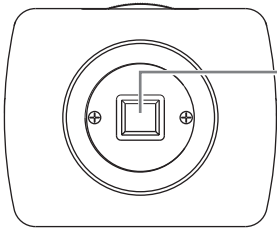
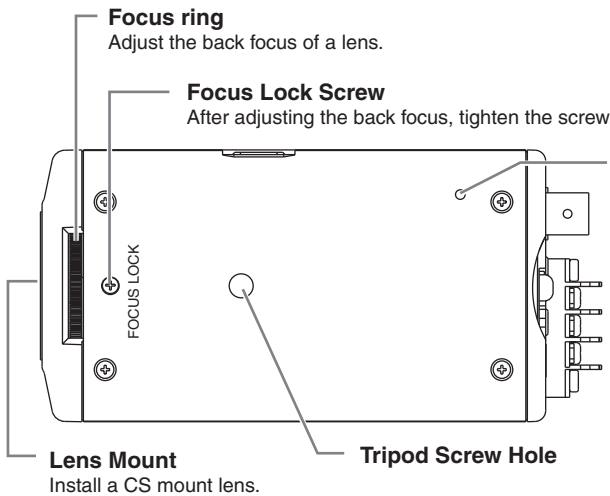

Image Pickup

Image sensors are embedded. Protect the part from dust, dirt and finger marks.

●Top



Focus ring

Adjust the back focus of a lens.

Focus Lock Screw

After adjusting the back focus, tighten the screw.

Reset Button

When the button is pressed, all the set values of the firmware on the network camera are reset to the default settings (initial state). (→ page. 93)

Lens Mount

Install a CS mount lens.

Tripod Screw Hole

●Rear

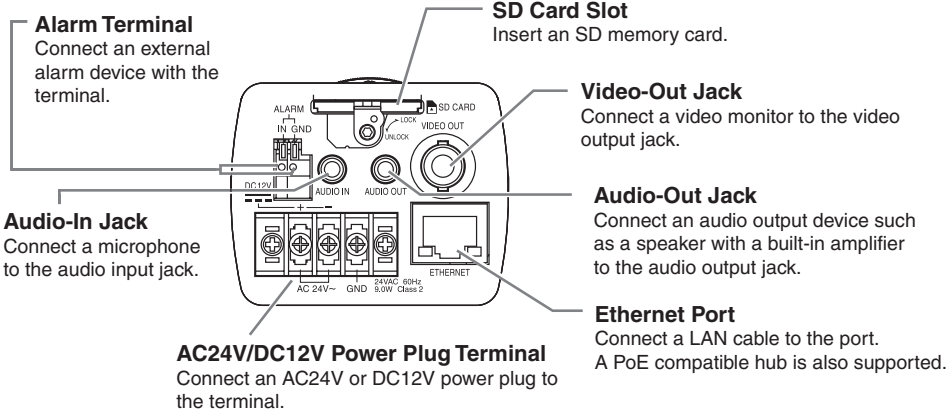

Alarm Terminal

Connect an external alarm device with the terminal.

SD Card Slot

Insert an SD memory card.

Video-Out Jack

Connect a video monitor to the video output jack.

Audio-In Jack

Connect a microphone to the audio input jack.

Audio-Out Jack

Connect an audio output device such as a speaker with a built-in amplifier to the audio output jack.

Ethernet Port

Connect a LAN cable to the port. A PoE compatible hub is also supported.

AC24V/DC12V Power Plug Terminal

Connect an AC24V or DC12V power plug to the terminal.

Names and Features of Parts (Cont.)

●Right

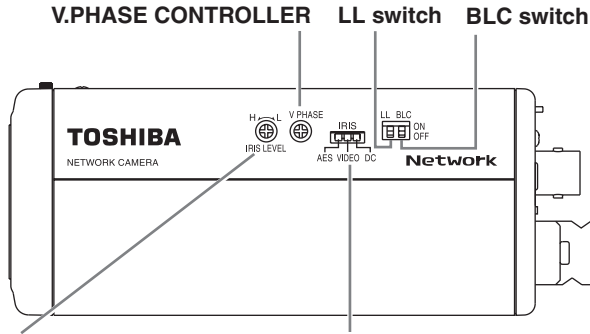

IRIS LEVEL

Control iris level for DC type auto iris lens.

IRIS switch

Change switch settings depending on the type of auto iris lens (DC/EE). Select "AES" for a fixed iris lens.

●Left

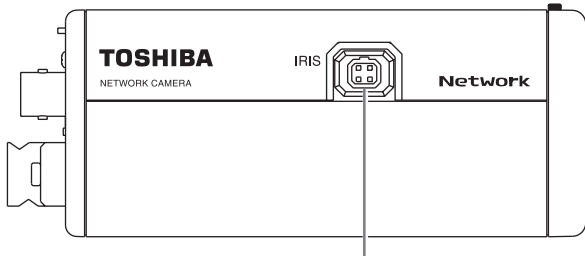

IRIS Jack (4P)

Connect an auto iris lens to the jack.

●Bottom

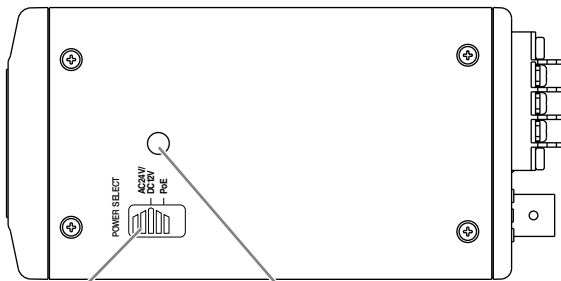

POWER SELECT switch

Select the type of power source input.

Tripod Screw Hole

Use a tripod screw to fasten the camera on the tripod. If the camera fails to be well fastened, it may fall and cause serious injury. Use a 7 mm or less tripod screw.

Installation/Setup

- **Installing a Lens/Connecting to a Video Monitor**
- **Line-Lock Control**
- **Adjusting a Lens**
- **Setting Up the Network Camera Environment**
- **Connecting the Camera and Personal Computer by Network**
- **Using the Camera Search Application “Camera Finder”**
- **Changing Administrator Login ID and Password**
- **Setting up Access Restriction**
- **Configuring the Network Manually**

Installing a Lens/Connecting to a Video Monitor

Installing a Lens

You can install a CS mount lens on the camera.

Important

- When using a lens that weighs 400g or more including a zoom lens, make sure the lens is supported as well as the camera in order not to cause damage due to overloading.

Connecting to a Video Monitor

You can view camera images on the video monitor. The camera also supports audio.

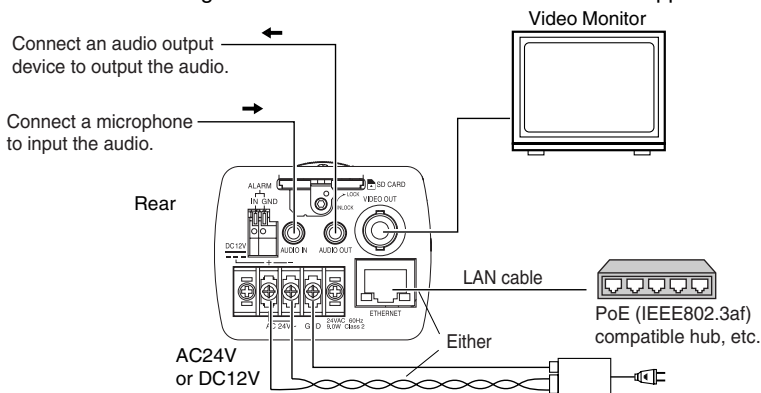

- On the power supply, use a PoE compatible hub, or connect AC24V or DC12V power plug.
- If power is to be supplied from a PoE compatible hub, etc., switch the POWER SELECT switch to PoE.
- If an AC24V or DC12V power supply is to be connected, switch the POWER SELECT switch to AC24V/DC12V.

■ About Audio Input/Output

Use a microphone with plug-in power operation and a 3.5 mm monaural mini jack for the AUDIO IN. Use a speaker with a built-in amplifier and a 3.5 mm monaural mini jack for the AUDIO OUT.

Important

- Power plugs of connected equipment must be disconnected before installation.
- A 75-ohm coaxial cable (3C-2V or 5C-2V) is required for standard connection.
- For details of wiring and operation of equipment to be connected, refer to their operation manuals.
- Lenses, coaxial cables for video signals, LAN cable and the power cord are not supplied with the camera.
- Do not connect AC24V and DC12V at the same time. It may cause a malfunction of the camera or AC adapter.
- Use a 4 pair twisted cable for the LAN cable to connect the camera to a PoE compatible hub.
- Use IEEE802.3af compliant PoE devices.
- An AC adapter is not supplied with the network camera. When using an AC adapter, a 10 watt or greater AC adapter is required.
- The camera takes about 30 seconds to start after the power is turned on.

Downloaded from www.seamless.com. All Manuals Search And Download.

Line-Lock control

- Matching the vertical synchronization with the power frequency is called the Line-Lock.
- This function is activated when the LL switch is set to ON.

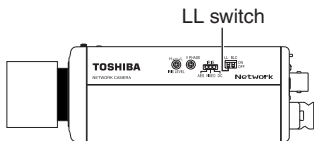

- When two or more cameras are switched by video switcher for viewing by a monitor TV, the vertical sync. phase can be locked with the power frequency, and a stable vertical sync. is obtained without being disturbed at the time of switching.

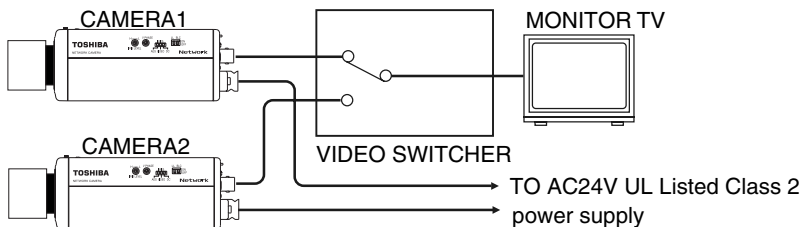

If two or more cameras within a system have different AC line phases are switched by the video switcher, the picture on the monitor TV will fluctuate vertically.

Connect 24V AC input line of all cameras so that they all share the same phase.

If you still have vertical fluctuation, adjust the V.PHASE controller.

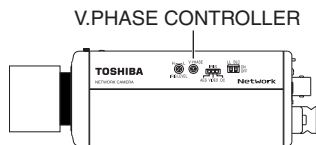

NOTE

- The camera is synchronized to the power frequency of 60 ± 1 Hz covering a normal fluctuation of the power frequency. However, the camera may not cover a large fluctuation caused from the power generated by an engine generator, etc.
- It takes about 10 seconds or more until a stable synchronization is obtained after the power is turned on. This is normal, because several seconds are required to stabilize the camera against power noise.

Adjusting a Lens

Adjusting the Back Focus

The back focus is set by default at the time of shipment. You may have to re-adjust the back focus depending on the type of your zoom lens.

Loosen the focus lock screw with the lens properly installed and then turn the back focus ring on top of the camera with the monitor until the subject distance comes into a proper distance scale. After the adjustment, fasten the focus lock screw.

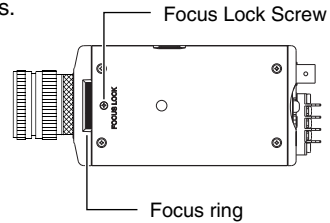

Adjusting the Iris

Auto Iris Lens

The camera is designed for two types of lens (iris lenses without EE Amp (DC) and with built-in EE amp (EE)/(VIDEO)).

- 1) Connect the iris connector of the auto iris lens to the iris jack (4P) on the left side of the camera.

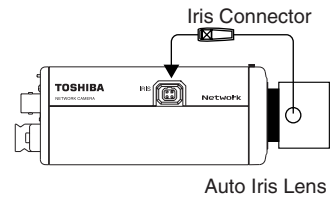

- 2) Set the iris switch on the right side of the camera (Default: DC).

For a DC lens, adjust the iris level on the right side of the camera to ensure correct exposure.

For an EE (VIDEO) lens, adjust the iris level on the lens.

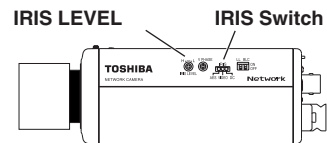

	EE (VIDEO) lens	DC lens
Iris jack	1. +12V	1. Damp-(y)
	2. NC	2. Damp+(y)
	3. VIDEO	3. Driver+(wh)
	4. GND	4. Driver-(g)
Iris switch	VIDEO	DC

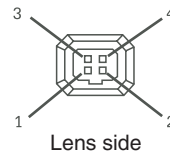

Important

- Improper setting with the iris switch and/or incorrect connection with the iris connector may generate heat to the interior of the camera, resulting in a malfunction or failure.
- When using an auto iris lens, do not select the “AES” setting in order not to cause a malfunction.
- When adjusting the iris of the auto iris lens, open the iris once under the full light condition. The camera may fail to work properly without sufficient light amounts.

■ Fixed iris lens

When the iris switch on the right side of the camera is set to “AES,” automatic electronic shutter mode becomes active (1/60s – 1/10,000s) for the fixed iris lens, according to the light amount on the subject to control the exposure.

When the iris switch is set to “VIDEO” or “DC,” the value of shutter comes to 1/60s.

Back Light Compensation

By turning on the back light compensation switch, the camera controls the back light automatically to ensure proper exposure in the specified area when using an auto iris lens or fixed iris lens with the “AES” mode.

For setting the metering area of back light compensation, go to page. 29.

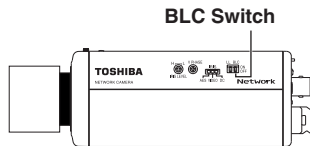

NOTE

- When there is a large differential of contrast between the subject and the surrounding (e.g. when the background is extremely bright), the BLC effect may be limited.

Auto White Balance (AWB)

The camera has an auto white balance capability in the range of 2,500K to 10,000K color temperature of light.

Setting Up the Network Camera Environment

Requirements for Network Camera Monitoring System

- Administrator's personal computer
 - This manual refers to a personal computer that has been granted all privileges for configuring, operating, monitoring, and other operations as the "administrator's personal computer."
- ★ This manual refers to a personal computer that is used just for monitoring images as a "user's personal computer." Multiple user's personal computers can monitor images from a single network camera.

System recommended requirements

- Windows® 2000/XP
- Internet Explorer™ Ver. 6.0 or later
- CPU: Intel® Pentium® III 500 MHz or greater
- Memory: at least 256 MB

- Network camera (this product)
 - Purchase the required and appropriate number of cameras for the installation location.
- Appropriate connection devices (hub, router, etc.) and LAN cable for the network system environment
 - The type of LAN cable depends on the connection method used. For details, refer to "Structure of Connection" (→ page. 14).
- Install the camera search application ("Camera Finder")
 - Install the application from the supplied mini CD-ROM (→ page. 16).

■ About the IP Address

To connect to the network, the administrator needs to set the network camera IP address.

There are two options to set the IP address.

- Obtaining an IP address automatically from the DHCP server
- Entering an IP address manually

● Obtaining an IP address automatically from the DHCP server

The default setting is “Automatically by DHCP” to obtain an IP address automatically from the DHCP server.

If your network is using DHCP server, keep the setting as “Automatically by DHCP”.

● Entering an IP Address Manually

- Enter an IP address manually if you are not using or do not want to use the DHCP server.
- If you use the DHCP server, the IP address of the network camera may be modified when necessary. Therefore, the previous IP address may no longer be valid, not allowing you to access to the camera. To access to the network camera every time, you need to set a fixed IP address (by manually setting) in the network camera. Also read carefully the operating instructions of the network system devices (routers, hubs, modems, etc.).
- To learn about the procedure for entering an IP address manually, refer to “Configuring the Network Manually” (→ page.22).

Connecting the Camera and Personal Computer by Network(Cont.)

Structure of Connection

There are following two structures for connection of the network camera:

- Use a crossover cable
- Connect with a hub or router

● Using a crossover cable to establish a connection (example)

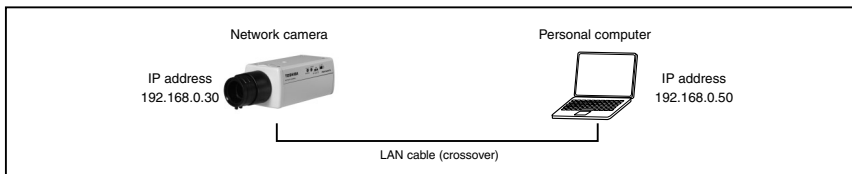

Crossover cable is not provided with the product.

● Establishing a connection via a hub or router (example)

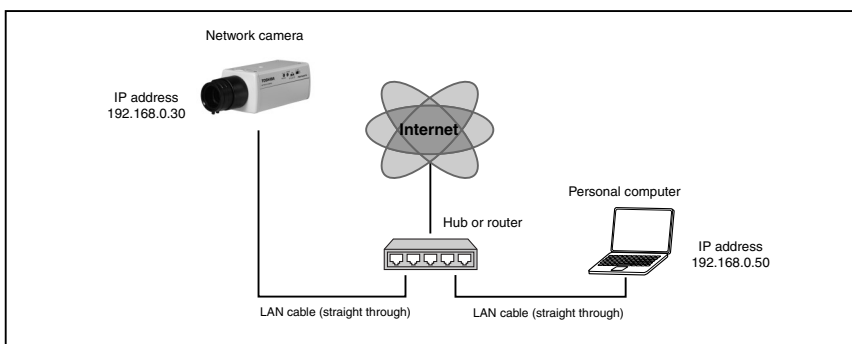

Straight through cable, hub, or router, etc. is not provided with the product.

NOTE

- You do not need to assign an IP address to a hub.
- In the case of not using DHCP server, the IP address for the camera is automatically set to 192.168.0.30 in default. Therefore, set the IP address for your computer to , for example, set to 192.168.0.50.(When directly connecting with a crossover cable or connecting with a hub, it should be run in the same network segment).

When using multiple cameras, connect the first camera at IP address 192.168.0.30 and set different IP addresses (192.168.0.31, etc.) for the second camera and after.

- There will be no problem to use the LAN port of your broadband router instead of using a hub.

However, when using the broadband router, if the “Connection Settings” is set “Automatically by DHCP” and turn on the power after connecting the camera with the router, the camera gets the IP address from the router’s DHCP server and it may not be 192.168.0.30.

For more information, read your user’s guide for broadband router.

It is also recommended to set the computer’s IP address from the router’s DHCP server. For more information, read your computer’s user’s guide.

Connecting

1 Connect a LAN cable and then turn the power on.

Connect the LAN cable (straight) leading to the camera with a powered hub. Alternatively, use a LAN cable (crossover) to connect the camera with the powered personal computer.

- When connecting a PoE compatible hub/router/LAN cable, available to the camera even though there is no connection at the power plug.
- When not using a PoE compatible hub, connect AC24V or DC12V power plug with the power plug terminal.

2 Set the IP address of the personal computer.

- Set the IP address of the computer to a setting different than 192.168.0.30 (camera's IP address).
- Set the IP address to 192.168.0.50 (and subnet mask to 255.255.255.0) as an example.
- For details on the procedure, refer to the user's guide of the personal computer.

3 Make sure whether the camera receives a reply from the personal computer.

- Start a command prompt and then run "ping 192.168.0.30."
- If the "Reply from..." message appears, the connection is correctly established.

4 Search for the network camera with the "Camera Finder" (→ page. 16) and then view camera images.

- a) Start "Camera Finder" and click the "Search" button.
 - Confirm that the camera name "nwcam02" and the IP address "192.168.0.30" are displayed in the camera list.
- b) Click camera name, "nwcam 02", to select.
 - Check that the camera name, the IP address and the HTTP port number are displayed in the login field of the network camera.
- c) Click the "User" button.
 - When the "User authorization" is set to "ON" (→ page.21), a screen appears, asking you to enter the user name and the password. Enter the Administrator login ID and password or the registered user name and password.
- d) The Camera Window screen appears.

NOTE

- To view the screen without using the "Camera Finder," start the Internet browser, enter the URL "http://192.168.0.30/" and then press ENTER. When you enter a port number other than 80, specify the port number after ":" (e.g. http://192.168.0.30:88/).
- The camera takes about 30 seconds to start after the power is turned on.

Using the Camera Search Application “Camera Finder”

The camera search application “Camera Finder” is an application that searches for network cameras. Install this application from the supplied mini CD-ROM.

● Setting up “Camera Finder”

1 Insert the supplied mini-CD-ROM into the CD-ROM drive of the personal computer.

2 Explore the CD-ROM and double click on “Setup.exe”. Then follow the instructions on the screen to install “Camera Finder.”

Important

- The Camera Finder is only supported by Windows 2000 and Windows XP. Do not install the application in other operating systems as it may cause damage on your personal computer.

● Using “Camera Finder” to Search for a Camera

1 From the “Start” menu, point to “Programs” and “TOSHIBA Network Camera”, and then select “Camera Finder.”

2 Start up “Camera Finder” and click “Search” button.

- All the cameras currently connected to the network appear.
To clear the results, click “Clear” button.

3 Click the camera you want to login from the list of cameras.

- The chosen camera name and IP address is displayed in the Network camera log-in fields.

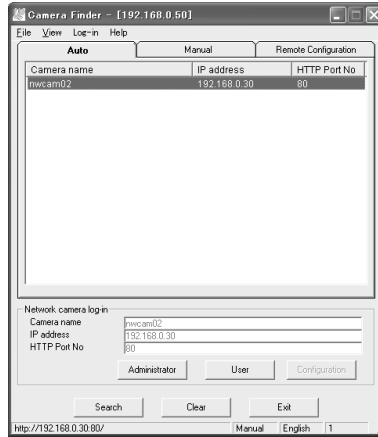

4 Click the “User” button.

- Click the “User” button to connect to the network camera from “Camera Finder.”
- The browser starts up and then the “Camera Window” screen appears.

To close the window without logging in

Click “Exit” button to close “Camera Finder”

Important

- Toshiba is not responsible for any damages caused by this software.
- The “Administrator” button in the “Camera Finder” is invalid for the IK-WB02A. When connecting to the IK-WB02A, be sure to click the “User” button.
- When you log in as Administrator, set up access restrictions (→ page. 20).

Changing Administrator Login ID and Password

Be sure to change the default login ID and password. You are able to change important information and settings of the camera through the Administrator Login. To have higher security, be sure to change your login ID and the password, and don't forget new login ID and password.

The default login ID is "root" and the default password is "ikwb".

1 Click "Configuration" on the left side of the "Camera Window" screen.

- The Configuration menu is displayed on the left side of the screen.

2 Click "Admin" on the left side of the screen.

- The Admin Settings window is displayed on the right side of the screen.

TOSHIBA
Network Camera

[System](#)
[User](#)
[Admin](#)
[Alarm](#)
[Network](#)
[Mail](#)
[FTP client](#)
[FTP server](#)
[DDNS](#)
[Recording](#)
[Camera Window](#)
[View Log](#)

Admin Settings (<http://192.168.0.30>) nwcam02 [Back to camera window](#)

Change ID/Password

Current login ID:
Current Password:
New login ID:
New Password:
New Password(Confirm):

Sound

ON OFF

Recording Storage

mount status:
remaining: KB

[Complete Format\(remove log messages\)](#)
[Quick Format\(remain log messages\)](#)
[Reboot IP Camera](#)

3 Enter “root” in the Current login ID field and “ikwb” in the Current Password field.

4 Enter a new login ID in the New login ID field and a new password in the New Password field and New Password (Confirm) field.

- Enter the same password in the New Password field and the New Password (Confirm) field.

5 Click the “Change” button.

- New login ID and password are stored in the network camera.

6 Click the browser.

- The current login operation terminates.
- Afterwards, follow the procedures to set up access restrictions (→ page. 20).

Setting up Access Restriction

You can set up the access restriction by requiring the user to enter the user ID and password for the Administrator login or the registered user ID and password.

1 Click “Configuration” on the left side of the “Camera Window” screen.

- The Configuration menu is displayed on the left side of the screen.

2 Click “User” on the left side of the screen.

- The User Setting menu is displayed on the right side of the screen.

TOSHIBA
Network Camera

[System](#)
[User](#)
[Admin](#)
[Alarm](#)
[Network](#)
[Mail](#)
[FTP client](#)
[FTP server](#)
[DDNS](#)
[Recording](#)
[Camera Window](#)
[View Log](#)

User Settings(<http://192.168.0.30>) [nwcam02](#) [Back to camera window](#)

User authorization required:
 ON OFF

Add a user or change password:
User ID:
Password:
Confirm:

Delete user:
Username:

Current users list:
[1: quest](#)

3 Enter the user name and the password for a new user in the field of “User ID” and “Password” respectively in “Add a user or change password.”

- Enter the password again in the “Confirm” field for verification.

4 Click the “Set/Change” button.

- New user ID and password for the User login are stored in the network camera.

5 Check “ON” in the “User authorization required” section.

6 Click the “Set” button.

- A screen appears, asking you to enter a user name and password.



7 Enter the Administrator login ID and password in the field of user name and password, respectively →Click the “OK” button.

8 Close the browser.

- When accessing to the camera next time, you are required to enter the user ID and password.
- To log in as User, both the user ID and the password are already registered as “guest.”

Configuring the Network Manually

You can change the settings of network connection manually.

- Enter an IP address manually if you are not using, or do not want to use the DHCP server.

1 Log in as Administrator.

2 Click “Configuration” on the left side of the “Camera Window” screen.

- The Configuration menu is displayed on the left side of the screen.

3 Click “Network” on the left side of the screen.

- The Network Connection setting menu appears on the right side of the screen.

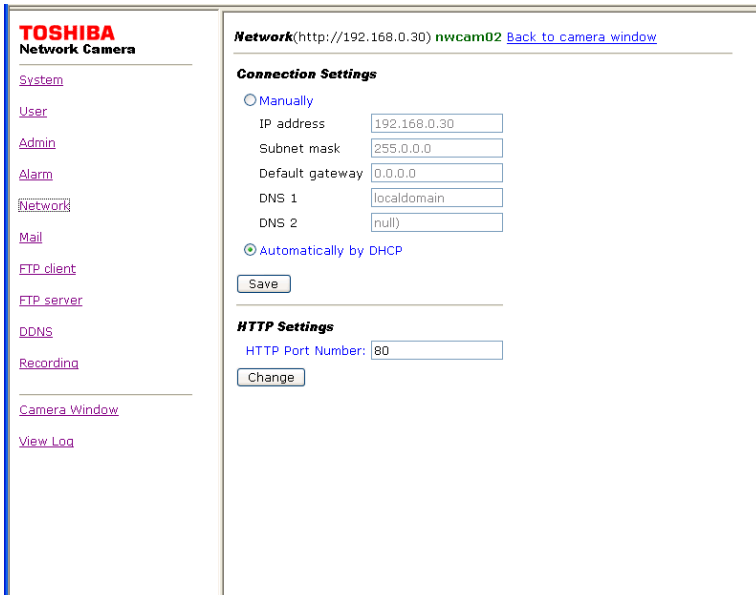

4 Select “Manually.”

- The default setting is “Automatically by DHCP”

5 Fill in “IP Address,” “Subnet Mask,” “Default Gateway,” “DNS1” and “DNS2.”

Important

- If you do not know the subnet mask, consult the provider or network system administration support center.
- You do not need to enter the default gateway if the network camera will not be accessed from another network. If you do need to enter a default gateway, consult the network system administration support center.

6 Click the “Save” button.

- The settings are registered.

Viewing • Listening and Operation

- Viewing and Listening
- Using Playback Function
- Playing Alarm Images
- Playing Recorded Normal Images
- Viewing Logs
- Speaking

Viewing and Listening

Viewing Images

The images in the network camera can be displayed with the Internet browser on the personal computer.

1 Search for the network camera with the “Camera Finder” → Log into the camera.

- The browser starts up and then the Camera Window screen appears for the network camera.
- To learn about how to log into the network camera with the “Camera Finder,” refer to “Using the Camera Search Application “Camera Finder”” (→ page.16).

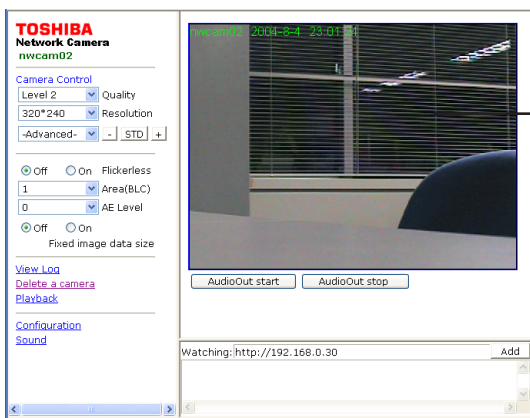

Image on the camera

2 Close the browser to log off (disconnect) the camera.

■ Audio Listening

You can output the sound of microphone that is connected to the audio-in jack on the network camera. For more details about audio settings, refer to page 74.

■ Camera Window Screen

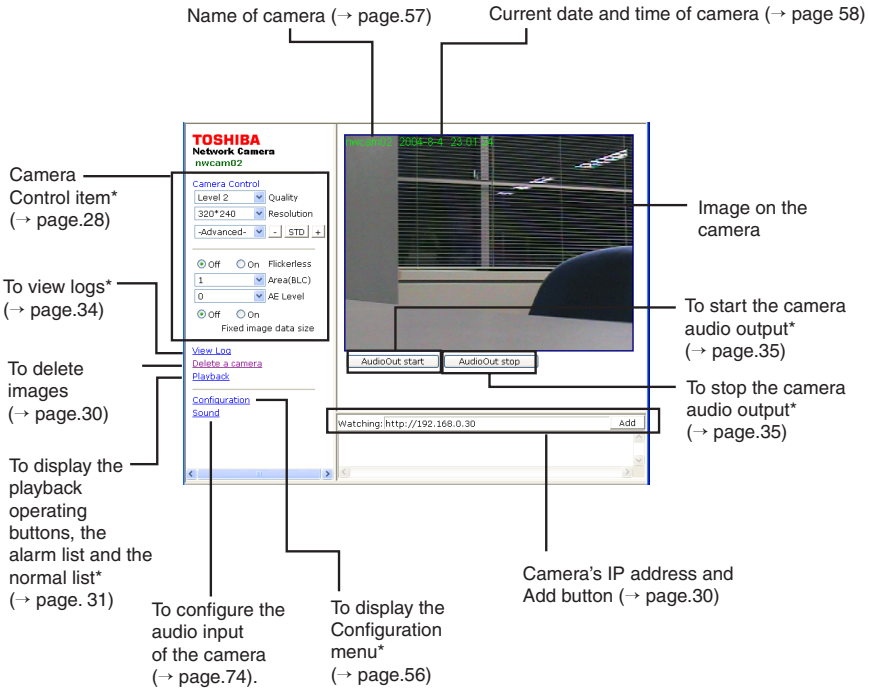

* Cannot be operated through the User login.

■ Menu that is displayed when right-clicking on the image

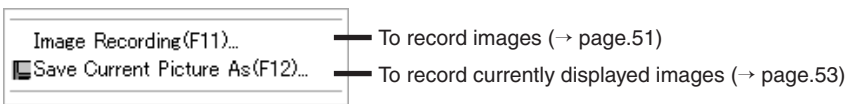

Viewing and Listening (Cont.)

Adjusting Images on the Camera

You can set up the image quality and resolution for the images on the camera. To perform the operation, you need to log in as Administrator. When you log in as User, the operation is disabled.

- 1 Adjust the settings in the Camera Control item on the left side of the Camera Window screen.

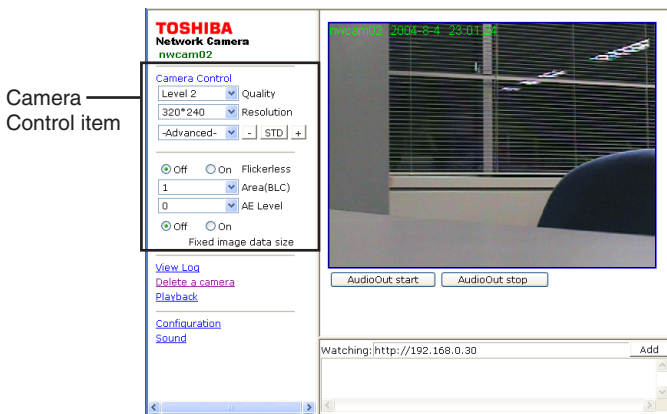

● Quality

You can set up the quality for recorded/delivered images.

Selectable settings: Level 1 to Level 5 (default: Level 2)

Images has the highest quality in Level 5. When the image size is the same, if the image quality is set to high, the file size is increased.

● Resolution

You can set up the resolution for recorded/delivered images.

Selectable settings: 160x120, 320x240, 640x480 (default: 320x240)

● Advanced

The following 4 items can be controlled individually:

Brightness

Contrast

Saturation

Hue

Click the “-” button: Lower (softer)

Click the “STD” button: Adjusted values for the selected item are reset to the default settings

- When “Advanced” is selected, the adjusted values of all the Advanced items are reset to the default settings.

Click the “+” button: Higher (harder)

- **Flickerless**

You can set up the function to reduce the flickering caused by lighting such as fluorescent lights. This function does not work in AES mode.

On: To activate the flicker compensation

Off: Not to activate the flicker compensation

(Default: Off)

- **Area (BLC)**

You can set up the target area for back light compensation (→ page.11).

Selectable settings: 1 to 5 (default: 1)

BLC1

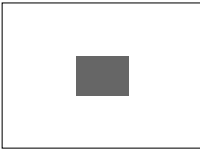

BLC2

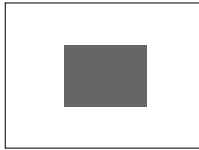

BLC3



BLC4



BLC5

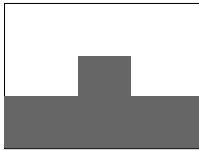

- **AE Level**

The camera adjusts the brightness of the image automatically. Adjust the setting to give you the best image for your environment.

Selectable settings: -20 to 20 (default: 0)

The higher the value is, the brighter the image looks.

- **Fixed image data size**

If this setting is set to “On,” the camera fixes the file size to about 24KB when the resolution is “640x480,” regardless of the values set for quality.

Viewing and Listening (Cont.)

Adding Images

You can add and view images on the other camera.

1 Enter the IP address of other camera in the “Watching:” field → Click “Add.”

- An image on the other camera is added on the Camera Window screen.
- Up to 9 images can be displayed on the Camera Window screen.

2 To delete the image you added, select the image you want to delete → Click “Delete a Camera.”

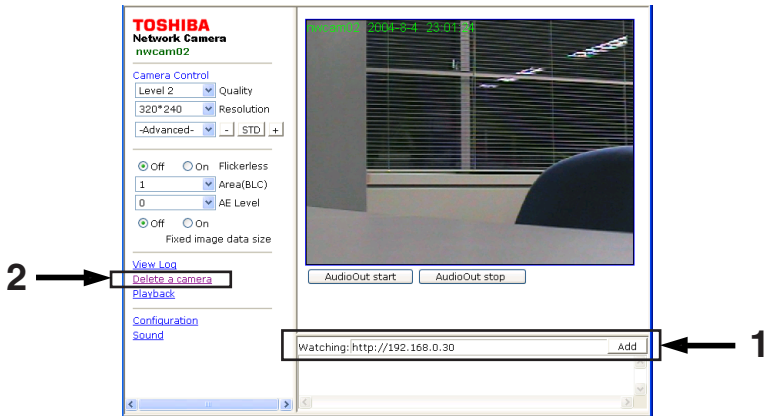

Using Playback Function

You can use the playback function to play back recorded images of the alarm list or the normal list in the SD memory card. To perform the operation, you need to log in as Administrator. When you log in as User, the operation is disabled.

1 Click “Playback” on the left side of the “Camera Window” screen.

- The playback function mode starts and the playback operating buttons, the alarm list and the normal list is displayed.
- To play back images of the alarm list or the normal list, go to page. 32 and page. 33.

2 To cancel the playback function mode, click the “Live” playback operating button.

- The playback function mode is switched to the current image mode again.

● About the Playback Operating Buttons

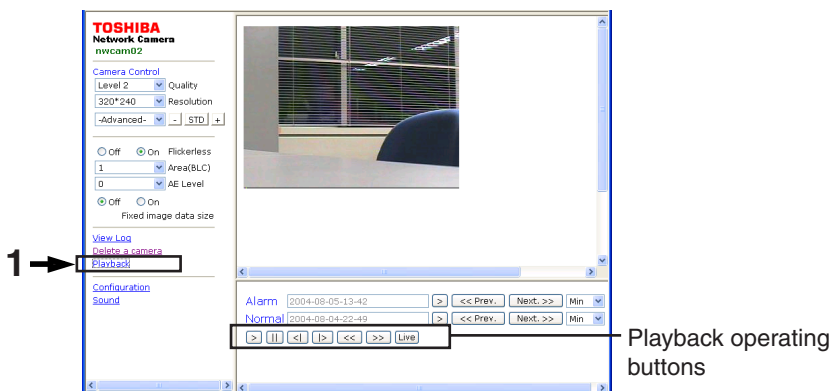

“>” button: To start playback

“>>>” button: To forward

“<<<” button: To rewind

“|>” button: To pause

“>|” button: To move forward one frame

“<|” button: To move backward one frame

“Live” button: To return to the current image mode

Playing Alarm Images

You can play alarm images (→ page.40) which are stored on an SD memory card. The images are played at fixed intervals regardless of the recording interval. The resolution (image size) varies depending on the settings for the time when the alarm is raised. To perform the operation, you need to log in as Administrator. When you log in as User, the operation is disabled.

1 Click “Playback” on the left side of the “Camera Window” screen to set to the playback function mode (→ page.31).

2 Select “Date,” “Hour,” “Min” or “Sec” from the pull-down menu on the right side of the alarm list.

3 Select an alarm list you want to play by pressing the “<<Prev.” and “Next.>>” buttons on the right side of the alarm list.

- You can search for the list by date, hour, minute and second when the Date, the Hour the Min and the Sec are selected, respectively, on Step 2.

4 Click the “>” button on the right side of the alarm list.

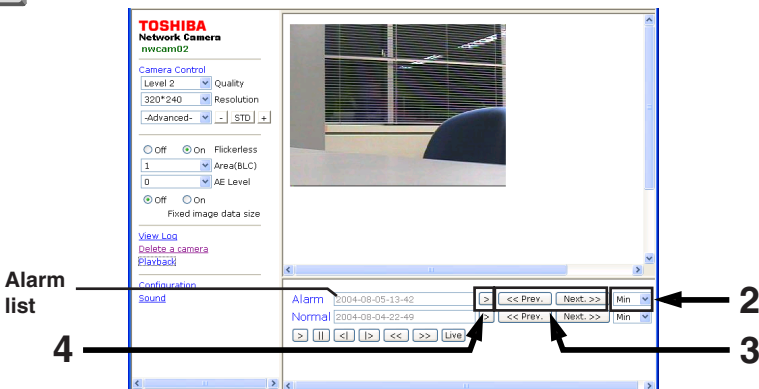

- The image of alarm list you selected is played.

NOTE

- The alarm list is displayed in a “yyyy-mm-dd HH-MM-SS” format.
- You can continuously play back, forward or rewind the image with the playback operating buttons (→ page. 31).
- To return to the current image mode screen from the playback screen, click the “Live” button.
- Another alarm cannot be set while the alarm tone is playing.

Playing Recorded Normal Images

You can play recorded normal images (→ page.40) which are stored on an SD memory card. The images are played at fixed intervals regardless of the recording interval. The resolution (image size) varies depending on the settings for the time of recording. To perform the operation, you need to log in as Administrator. When you log in as User, the operation is disabled.

1 Click “Playback” on the left side of the “Camera Window” screen to set to the playback function mode (→ page.31).

2 Select “Date,” “Hour,” or “Min” from the pull-down menu on the right side of the alarm list.

3 Select an normal list you want to play by pressing the “<<Prev.” and “Next.>>” buttons on the right side of the normal list.

- You can search for the list by date, hour and minute when the Date, the Hour and the Min are selected, respectively, on Step 2.

4 Click the “>” button on the right side of the normal list.

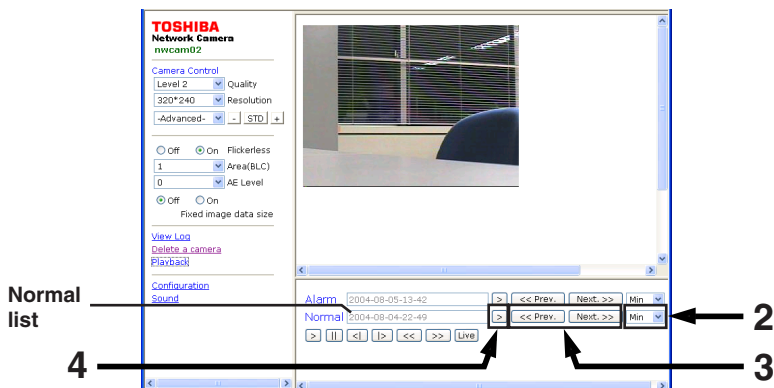

- The image of normal list you selected is played.

NOTE

- The normal list is displayed in a “yyyy-mm-dd HH-MM-SS” format.
- You can continuously play back, forward or rewind the image with the playback operating buttons (→ page. 31).
- To return to the current image mode screen from the playback screen, click the “Live” button.
- You cannot perform normal recording during playing.

Download from [Www.Somanuals.com](http://www.Somanuals.com). All Manuals Search And Download.

Viewing Logs

You can view a list of logs. To perform the operation, you need to log in as Administrator. When you log in as User, the operation is disabled.

1

Click “View log” on the left side of the Camera Window screen.

- A list screen of logs is displayed.
- For details on displayed logs, refer to “Display of Logs” (→ page.86).

NOTE

- Clicking the “Clear” button deletes the log data.
- To return to the image screen, click “Camera Window” on the left side of the screen.

Speaking

You can connect a microphone to a personal computer and hear the sound through a speaker connected to the camera. To perform the operation, you need to log in as Administrator. When you log in as User, the operation is disabled.

1 Click the “Audio Out start” button below the image.

- The audio out mode starts and sound captured by the microphone connected to the personal computer is heard from the speaker connected to the camera.

2 To cancel the audio output mode, click the “Audio Out stop” button.

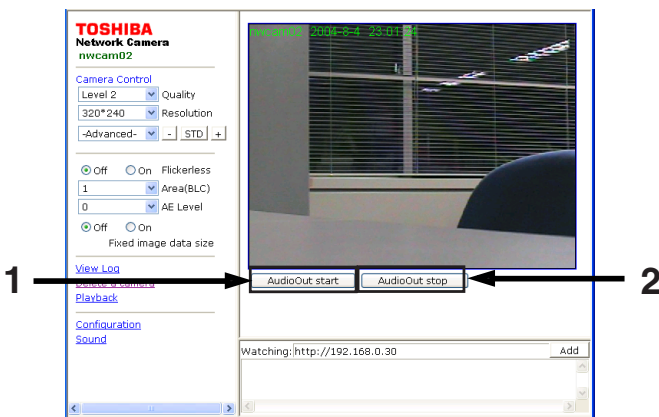

NOTE

- Connect an audio output device (such as a speaker with a built-in amplifier) with the audio-out jack of the camera. (No audio can be output when connecting a speaker without a built-in amplifier).
- For a microphone connected to a personal computer, refer to the operating instructions of your computer.
- You cannot output voices from the multiple personal computers simultaneously (from one computer only).
- When the camera is functioning in the audio output mode, you can not output the voices from the camera through a personal computer (→ page. 26).

Recording

- **About Recording Images**
- **Recording Images on an SD Memory Card**
- **Recording Images on FTP Server**
- **Recording Images on a Personal Computer**

About Recording Images

Network camera can record images according to your need. Recordable media and its recordable contents are as follows.

Recordable Media	Recordable Contents
SD Memory Card	<ul style="list-style-type: none">• Alarm Recording images configured in “Alarm Recording” settings (→ page 40). (Image data at the time of external alarm detection/motion detection)• Normal Recording images configured in “Normal” settings (→ page 40).
FTP Server	<ul style="list-style-type: none">• Data of “Periodic FTP by Schedule”• Data of “Extern Alarm Detection” or “Motion Detection”• Recording data by EXT control
Personal Computer	<ul style="list-style-type: none">• Image data recorded by “Image Recording” (JPEG) (→ page. 51)• Video data recorded by “Image Recording” (AVI) (→ page. 51)• Still images recorded by “Save Current Picture As” (→ page. 53)

Recording Images on an SD Memory Card

You can record image data when an alarm or motion detection occurs, normal recording images on an SD memory card that is inserted in the network camera. To record alarm images, perform administrator login and configure “Alarm Settings” first (→ page 64), then follow the steps below to configure “Recording Settings”.

Recording Settings

1 Insert an SD memory card.

- Insert an SD memory card into the SD card slot (→ page. 5). Turn the knob to the “LOCK” direction until it locks.
- When clicking “Complete Format” or “Quick Format” in the Admin Settings for formatting, you can delete files in an SD memory card (→ page. 63).

2 Click “Configuration” on the left side of the “Camera Window” screen.

- The Configuration menu appears on the left side of the screen.
- When you do not log in as Administrator, the “Configuration” menu does not appear. Perform the operation through the Administrator login.

3 Click “Recording” on the left side of the screen.

- The Recording setting screen appears on the right side of the display.

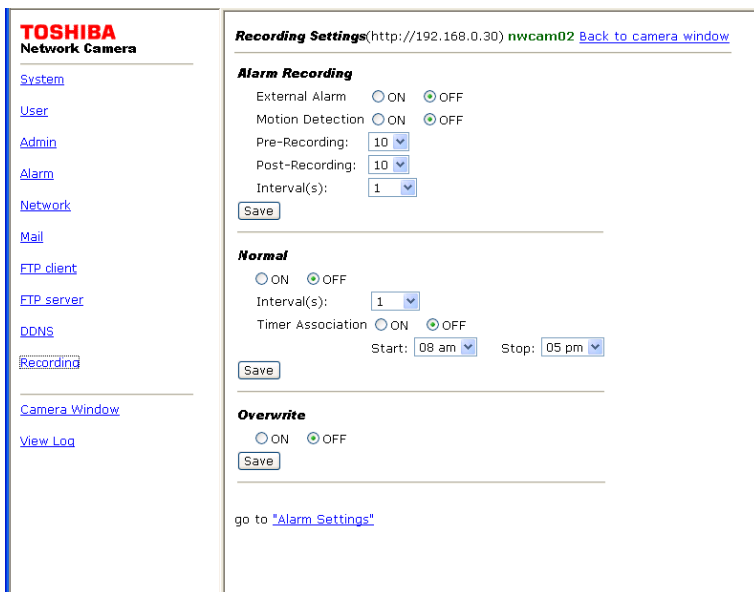

4 Configure each setting items.

■ Alarm Recording

● External Alarm

ON: To record images when an external alarm occurs.

OFF: Does not to record images when an external alarm occurs.

● Motion Detection

ON: To record images when a motion is detected

OFF: Not to record images when a motion is detected

● Pre-Recording

Pre-Recording records image(s) of right before alarm was generated.

You can set numbers of frames you want to record. The image at the moment the alarm was generated will not be included.

● Post-Recording

The Post-Recording records image (s) at the moment and after an alarm was generated.

You can set numbers of frames you want to record.

● Interval(s)

Configures recording cycle of Pro-Recording and Post Recording.

■ Normal

ON: To record images depending on the recording intervals and timer association

OFF: Not to operate normal recording

● Interval(s)

Configure recording cycle of Normal Recording images.

● Timer Association

ON: To turn on the timer association

OFF: To turn off the timer association

When "Timer Association" is set to "ON," configure the start/stop time for recording.

● Overwrite

ON: To overwrite data in the order of the oldest to the newest when the SD memory card becomes full during recording.

OFF: To stop recording when the SD memory card becomes full during recording.

5 To finish configuring Recording Settings, click the "Save" button below the setting.

- The changes are saved.

NOTE

- Total number of recorded image frames per one alarm will be the sum of Pre-Recording image(s) + Post-Recording image(s).
- To configure the external alarm/motion detection, select "ON" in "External Alarm Detect" or select "Enable" in "Motion Detect" in the alarm settings (→ page. 64).

Recording Images on FTP Server

By using FTP server, it becomes possible to manage periodic transferring and saving of huge amounts of recorded image data. The recordable images on an FTP server include “Periodic Recording Data by Schedule,” “Recording Data by External Alarm Detection” or “Recording Data by EXT Control.”

Record Settings

1 Click “Configuration” on the left side of the “Camera Window” screen.

- The Configuration menu appears on the left side of the screen.
- When you do not log in as Administrator, the “Configuration” menu does not appear. Perform the operation through the Administrator login.

2 Click “FTP client” on the left side of the screen.

- The FTP client setting screen appears on the right side of the display.

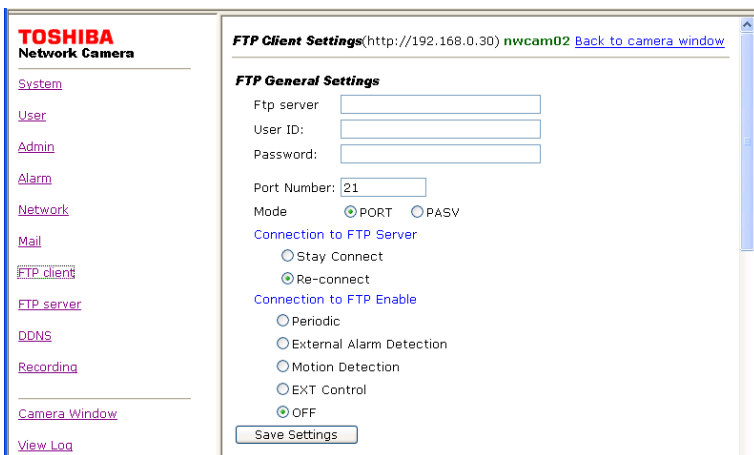

Recording Images on FTP Server (Cont.)

3 Configure each setting items.

■FTP General Settings

You can control the settings to connect to an FTP server.

●FTP sever:

Select either one of them below and enter correct information.

- Server Name
- IP Address

●User ID:

Only for a user who has the right to access FTP server. Ask FTP server administrator for details.

●Password:

- Enter password registered with user ID above.

●Port Number:

Usually, enter “21”.

Important

- Do not change the port number unless your provider or the network administrator instructs you to do so.

●MODE:

- PORT (active mode): Select PORT if you are unsure about which mode to choose.
- PASV (passive mode): When the camera’s network environment is protected by Firewall or the like, access from outside FTP server may not be possible with PORT (active mode). In this case, select PASV (passive mode).

●Connection to FTP Server:

- Select “Stay connect” when transferring data frequently, like “Periodic FTP by Schedule”. In this way, you can record images faster.

NOTE

- When selecting “Periodic”, network camera logs in to FTP server automatically a minute before the scheduled recording starts. When the scheduled recording stops, there may be some unsent image data left in the camera. The camera will not log out from the FTP server until all images have been transferred.
- When not selecting “Periodic,” network camera logs in/out automatically each time an alarm goes off. When there is more than one alarm at a time (receiving another alarm(s) while transferring a file), the camera logs out from the server after transferring last image data.

● **Connect to FTP Enable:**

Select one of the following recordable images on an FTP server:

- Periodic (periodic recording by schedule) (→ page 44)
- Extern Alarm Detection (recording by an external alarm detection) (→ page 46)
- Motion Detection (recording by motion detection) (→ page 46)
- EXT Control (recording by EXT control) (→ page 48)
- OFF (not to record on an FTP server)

You need to set up the configuration for the item you selected. For setup details on each item, refer to the section on the next page and after.

4

Click the “Save Settings” button below the setting.

Recording Images on FTP Server (Cont.)

■ Periodic FTP by Schedule

You can control the settings to record images for Periodic FTP by Schedule. To run the recording, select “Periodic” in “Connection to FTP Enable” (→ page. 43).

TOSHIBA
Network Camera

Periodic FTP by Schedule

Monday OFF All Day Timer Pattern1 Timer Pattern2
Tuesday OFF All Day Timer Pattern1 Timer Pattern2
Wednesday OFF All Day Timer Pattern1 Timer Pattern2
Thursday OFF All Day Timer Pattern1 Timer Pattern2
Friday OFF All Day Timer Pattern1 Timer Pattern2
Saturday OFF All Day Timer Pattern1 Timer Pattern2
Sunday OFF All Day Timer Pattern1 Timer Pattern2

Timer Pattern1 Start: 08 am Stop: 05 pm
Timer Pattern2 Start: 08 am Stop: 05 pm

Interval(s) 1

File Name(Pattern-1): yymmddHHMMS00.jpg
 File Name(Pattern-2): LV yyyymmddHHMMS***N.jpg

Server Path:

Save Settings

1) Configure recording schedule

Select one of the setting items for each day of a week.

“OFF”: No recording at all.

“All Day”: Records images all day.

“Timer Pattern 1”: Records images in a period you configured in “Timer Pattern 1”.

“Timer Pattern 2”: Records images in a period you configured in “Timer Pattern 2”.

2) Configure timer pattern

- You may configure both “Timer Pattern 1” and “Timer Pattern 2” and use them according to your need.

Possible setting timer range is between 00 am and 11 pm for both “Start” and “Stop”.

3) Configure Interval(s)

- Records 1 image per configured recording cycle (second).
- Setting ranges are 1 through 10.
- Configured recording cycle will be reflected to “All Day”, “Timer Pattern 1” and “Timer Pattern 2”.

NOTE

- The cycle may shift depending of Resolution (image size) and networking conditions.

4) Enter “File Name”

- Select one of two patterns, enter characters in the part described as (keyword).

File name will be shown like this:

e.g. Pattern1: (keyword) yy mm dd HH MM SS 00.JPG

Pattern2: LV (keyword) yyyy mm dd HH MM SS ***N.JPG

NOTE

- You cannot use these characters: \ / : ; , " | ? * < >

Followings are the meaning of each part.

(Keyword)	Enter user defined keyword in characters.
yyymmdd	Indicates date (Year, Month, Day). (e.g. January 1, 2004 → 04 01 01).
HHMMSS	Indicates time (Hour, Minute, Second). (e.g. 23:59:00 → 23 59 00). Time is displayed in 24-hour time display.
00	Fixed entry

LV	Indicates this is the “Periodic FTP by Schedule” file.
(Keyword)	Enter user defined keyword in characters.
yyyyymmdd	Indicates date (Year, Month, Day). (e.g. January 1, 2004 → 2004 01 01)
HHMMSS	Indicates time (Hour, Minute, Second). (e.g. 23:59:00 → 23 59 00). Time is displayed in 24-hour time display.
***	If the camera records more than one image at the same period, the order is indicated with 3-digit number. The bigger the number, the newer (latest) the image.
N	Indicates Daylight Saving. N: Not in Daylight Time D: Daylight (Summer) Time

5) Enter “Server Path”

- Configure FTP server directory to record files . If you do not know the directory, ask for your FTP server administrator.

6) Click “Save Settings” button to save configured items

- The changes are discarded.

Recording Images on FTP Server (Cont.)

■FTP by External Alarm/Motion Detection

You can control the settings to record images for FTP by External Alarm/Motion Detection.

- To configure the external alarm/motion detection, select “ON” in “External Alarm Detect” or “Motion Detect” in the alarm settings (→ page. 64)
- To run the recording, select “Extern Alarm Detection” or “Motion Detection” in “Connection to FTP Enable” (→ page. 43).

The screenshot shows the Toshiba Network Camera web interface. The left sidebar contains navigation links: System, User, Admin, Alarm, Network, Mail, FTP client, FTP server, DDNS, Recording, Camera Window, and View Log. The main content area is divided into three sections:

- FTP by External Alarm/Motion Detection:** Pre-Recording: 1 frames, Post-Recording: 1 frames, Interval(s): 1, File Name: (EX/MD) [] yyyyymmddHHMMSS**N--A.jpg, Server Path: [] Save Settings
- FTP by EXT Control:** Interval(s): 1, File Name(Pattern-1): [] yymmddHHMMSS [] .jpg, File Name(Pattern-2): [] yyyyymmddHHMMSS [] .jpg, Server Path: [] Save Settings
- Image Accumulation to SD memory card:** Image Accumulation: ON OFF, Restriction: No limit hours, Interval(s): 1, Overwrite: ON OFF, Re-transfer trigger: When Network Recovers, When EXT Control is opened, Re-transfer interval: 1, Check FTP status(sec): 1, Save Settings

At the bottom, there are links: go to "Alarm Settings" and go to "Mail Settings".

1) Configure the numbers of frames you want to record for Pre-Recording

- Possible numbers of frames are as follows:
Enter a number in the range of 0 through 30.

2) Configure the numbers of frames you want to record for Post-Recording

- Enter the number between 0 and 1000.

NOTE

- Numbers of recorded image frame may decrease depending on networking conditions and recording cycle.

3) Configure Interval(s)

- Records 1 image per configured recording cycle (second).
Setting ranges are 1 through 10.

NOTE

- Cycle may change depending on Resolution (image size) and networking conditions.
Download from Www.Somanuals.com. All Manuals Search And Download.

4) Enter “File Name”

- Enter characters in the part described as (keyword).
File name will be shown like this:
e.g. EX (keyword) yyyy mm dd HH MM SS ***N--A.JPG

NOTE

- You cannot use these characters: \ / : ; , " | ? * < >

Followings are the meaning of each part.

EX/MD	“EX” indicates this is the file for detected external alarm. “MD” indicates this is the file for detected motion.
(keyword)	Enter user defined keyword in characters.
yyyymmdd	Indicates date (Year, Month, Day). (e.g. January 1, 2004 → 2004 01 01)
HHMMSS	Indicates time (Hour, Minute, Second). (e.g. 23:59:00 → 23 59 00). Time is displayed in 24-hour time display.
***	If the camera records more than one image at the same period, the order is indicated with 3-digit number. The bigger the number, the newer (latest) the image.
N	Indicates Daylight Saving. N: Not in Daylight Time D: Daylight (Summer) Time
--	Indicates total number of generated alarm(s). when the number reaches to 99, it returns to 00 and starts adding again.
A/B/C	A: Pre-Recording images. B: Image when alarm has generated. C: Post-Recording images.

5) Enter “Server Path”

- Configure FTP server directory to record files. If you do not know the directory, ask for your FTP server administrator.

6) Click “Save Settings” button to save configured items

- The changes are discarded.

Recording Images on FTP Server (Cont.)

■FTP by EXT Control (Recording Data by EXT Control)

You can control the settings to record images for FTP by EXT Control.

- Select “EXT” in “External Alarm Detect” of the alarm settings (→ page. 64).
- To run the recording, select “EXT Control” in “Connection to FTP Enable” (→ page. 43).

1) Configure Interval(s)

- Records 1 image per configured recording cycle (second).
Enter a number to configure the interval.

NOTE

- Cycle may change depending on Resolution (image size) and networking conditions.

2) Enter “File Name”

- Select one of two patterns, enter appropriate characters in the (keyword 1) field and the (keyword 2) field, respectively.

File name will be shown like this:

e.g. Pattern1: (keyword1) yy mm dd HH MM SS (keyword2).JPG

Pattern2: (keyword1) yyyy mm dd HH MM SS (keyword2).JPG

NOTE

- You cannot use these characters: \ / : ; , " | ? * < >

Followings are the meaning of each part.

(keyword1)	Enter user defined keyword in characters.
yymmdd	Indicates date (Year, Month, Day). (e.g. January 1, 2004 → 04 01 01)
yyyymmdd	Indicates date (Year, Month, Day). (e.g. January 1, 2004 → 04 01 01)
HHMMSS	Indicates time (Hour, Minute, Second). (e.g. 23:59:00 → 23 59 00). Time is displayed in 24-hour time display.
(keyword2)	Enter user defined keyword in characters.

3) Enter “Server Path”

- Configure FTP server directory to record files. If you do not know the directory, ask for your FTP server administrator.

4) Click “Save Settings” button to save configured items

- The changes are discarded.

■ Image Accumulation to SD Memory Card

Configures whether or not to save image data on SD memory card when the camera can not record image(s) on FTP server due to network problems. The accumulated data is transferred to the FTP server when the line is restored.

1) Configure whether or not the Image Accumulation is active

- Select “ON” to save image data on SD memory card. Select “OFF” if you do not need to save image data on SD memory card.

2) Configure Restriction

- Select an accumulation time from the pull-down menu. (1 to 24 [unit: hour], No limit)

3) Configure Interval(s)

- Configure recording cycle of accumulated images.
Enter a number to configure the interval.

NOTE

- Set “Image Accumulation” to “ON” before setting Interval(s).

4) Set up Re-transfer Trigger

- You can select the timing to re-transfer accumulated images to the FTP server.
When Network Recovers: When the line is restored
When EXT Control is opened: When the contact of EXT Control is opened

5) Configure Re-transfer Interval

- Configure the interval (unit: second) for re-transferring accumulated images.
- Enter a number to configure the interval.

6) Configure settings for viewing FTP status

- Select the interval in “Check FTP status (sec)” from the pull-down menu to try to view the FTP status.

7) Click “Save Settings” button to save configured items

- The changes are discarded.

NOTE

- You can perform formatting an SD memory card by clicking “Complete Format” or “Quick Format” in the Admin settings (→ page. 63).
- If the setting is made to record image data in an SD memory card at the time of alarm generation (→ page.40), the data is recorded to an SD memory card when the alarm is raised regardless of ON/OFF setting in the “Image Accumulation.”

Recording Images on FTP Server (Cont.)

File Transfer Order

■ Periodic FTP by Schedule

Basically, files are transferred in recorded order. However, the camera may take the following processes depending on networking conditions.

- 1) When networking condition causes the file transferring delay, the camera may transfer the old files in the file transfer intervals.
- 2) When files that could not transfer are still left by the time transferring schedule comes to end, the camera will keep continue to transfer the files until it transfers all the files.

NOTE

- Depending on the conditions of networking and the FTP server, there may be occasions when files will not transfer. In this case, this camera is able to make backup data on the SD memory card. Go to the Network Setting screen and set "Image Accumulation" function under "Image Accumulation to SD Memory Card" to "ON". (→see page 49) If you set this function to "ON", the files will be transferred to FTP server by following the process described in 2) above.

Recording Images on a Personal Computer

You can record images in the JPEG file or AVI file format on a personal computer.

Image Recording Feature

1 Right-click on the image of the “Camera Window” screen.

- The operating menu appears on the screen.

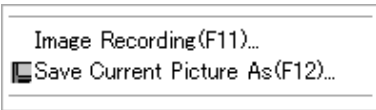

2 Click “Image Recording.”

- The image recording setting screen appears.

3 Setting up Recording.

When saving images as a JPEG file

The 'Image Recording' dialog box is shown with the 'JPEG' section selected. Annotations point to the following elements:

- DownLoad**: A checkbox labeled 'DownLoad' is checked.
- Select**: A group box containing 'Save as JPEG' (checked) and 'Save as AVI' (unchecked).
- JPEG**: A group box containing:
 - No Limit**: Selected radio button.
 - Number**: Radio button, with '100' in the 'Frames' field and '1' in the 'Save interval' field.
 - Size**: Radio button, with '1000' in the 'KBytes' field.
 - Time**: Radio button, with '10' in the 'Seconds' field.
 - Save Path**: Text box containing 'C:\Documents and Settings\TOSHIB'.
 - Pre Name**: Text box containing 'webcam'.
 - Save As**: Button.
- AVI**: A group box containing:
 - No Limit**: Selected radio button.
 - Number**: Radio button, with '500' in the 'Frames' field and '5' in the 'Frame Rate' field.
 - Size**: Radio button, with '100' in the 'KBytes' field.
 - Time**: Radio button, with '10' in the 'Seconds' field.
 - Save interval**: Text box containing '1'.
 - Frame Rate**: Radio button, with 'Auto' checked and '5' in the field.
- Maximum Number of Frame in Each File**: Text box containing '500'.
- Save Path**: Text box containing 'C:\Documents and Settings\TOSHIB'.
- Pre Name**: Text box containing 'webcam'.
- Save As**: Button.
- Buttons**: 'Start', 'Cancel', and 'Apply' buttons at the bottom.

When saving images as an AVI file

Recording Images on a Personal Computer (Cont.)

When saving images as an AVI file

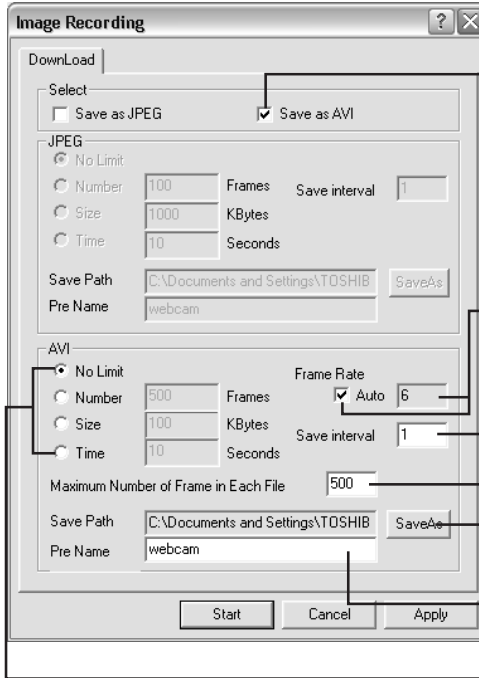

Mark here to save images as an AVI file.

Mark "Auto" or enter the frame rate value in the Frame Rate.

Enter the recording interval.

Enter the maximum number of frames recorded in one file.

Click the "Save As" button → Select the destination directory.

Enter the file name without the extension.

Specify the recording limit. Mark one of the items and enter the value in its field.

4 Click the "Start" button.

- The recording operation starts.

5 To stop the recording, right-click on the image → Click "Stop Image Recording" in the displayed operating menu.

Recording Current Image Data as Still Image

1 Right-click on the image of the “Camera Window” screen.

- The operating menu appears on the screen.



2 Click “Save Current Picture As.”

- A screen appears, asking you to specify the destination folder and file name.

3 Specify the destination folder and file name.

- You can save the data in any place and under any file name you like.
- The still image taken at the moment when clicking “Save Current Picture As” is saved.

Setting up

- **How to Set up**
- **System Settings**
- **User Settings**
- **Admin Settings**
- **Alarm Settings**
- **Network Settings**
- **Mail Settings**
- **FTP Client Settings**
- **FTP Server Settings**
- **DDNS Settings**
- **Recording Settings**
- **Audio Settings**
- **Updating the Firmware**
- **Saving the Settings on a
Personal Computer**

How to Set up

Only the Administrator is authorized to set up configurations for the network camera. You can select the setup items by clicking “Configuration” on the “Camera Window” screen.

General Configuration

1 Click “Configuration” on the left side of the “Camera Window” screen.

- The Configuration menu appears on the left side of the screen.
- When you do not log in as Administrator, the “Configuration” menu does not appear. Perform the operation through the Administrator login.

2 Click an item you want to configure in the Configuration menu on the left side of the screen.

- The setup screen for the clicked item appears on the right side of the display.

3 Configure each item.

- To update the settings, click the “Change” button, the “Save” button, the “Save Settings” button or the “Set” button etc. under the item.
- To return to the image screen after configuration, click “Camera Window” on the left side of the screen.
- On the screen in which “go to XX (name of setup item)” is displayed (e.g. “go to Mail Settings”), click it to display the setup screen for the item.

System Settings

You can change a camera name and control time set.

1 Click “Configuration” on the left side of the “Camera Window” screen.

- The Configuration menu appears on the left side of the screen.

2 Click “System” on the left side of the screen.

- The System setting screen appears on the right side of the display.

TOSHIBA
Network Camera

[System](#)
[User](#)
[Admin](#)
[Alarm](#)
[Network](#)
[Mail](#)
[FTP client](#)
[FTP server](#)
[DDNS](#)
[Recording](#)
[Camera Window](#)
[View Log](#)

System Setting (<http://192.168.0.30>) **nwcam02** [Back to camera window](#)

Camera name:

Camera's time: 8 Oct 2004 8:59:44
Date-Time Displaying Format:
Text Color:

NTP:
NTP Server:
Adjusting Cycle: hours

Input new time: Synchronize with PC's time
Date:
Time:
Time Zone:
Daylight Saving: ON OFF

[Restore factory default configuration](#)
[Reboot IP Camera](#)
[Firmware update](#)
[Export current configurations](#)
[Import new configurations](#)

3 Configure each item.

● Changing the camera name

- 1) Enter the camera name in the “Camera Name” field (default: nwcam02) (no more than 18 characters).
- 2) Click the “Change” button.

- The camera name is displayed in association with the images on the camera.

System Settings (Cont.)

● Setting up a format to display date/time

- 1) Select the “Date-Time Displaying Format” from the pull-down menu.
 - yyyy-mm-dd HH:MM:SS (ex. 2004-9-15 14:23:32)
 - dd Mmm yyyy HH:MM:SS (ex. 15 Sep 2004 14:23:32)
 - mm-dd-yyyy HH:MM:SS (ex. 9-15-2004 14:23:32)
(default: dd Mmm yyyy HH:MM:SS)
- 2) Click the “Change” button.

● Setting the color of date/time display

- 1) Select “Text Color” from the pull-down menu.
red/green/blue/white/black (default: green)
- 2) Click the “Change” button.

● Changing the time using an NTP server setting

- 1) Mark “NTP” (default: not marked).
- 2) Enter the host name of NTP server in the “NTP Server” field.
- 3) Set the “Adjusting Cycle” from the pull-down menu (to specify the intervals to adjust time) (default: 24 hours).
- 4) Click the “Adjust” button.

● Adjusting the date and time

- 1) Unmark “Synchronize with PC’s Time.”
- 2) Enter the value in “Date” with numbers and “/” (e.g. 20/9/2004).
- 3) Enter the value in “Time” with numbers and “:” (e.g. 14:23:32).
- 4) Click the “Adjust” button.
 - When “Synchronize with PC’s Time” is marked, you can synchronize the setting with the time on a personal computer (default: marked).

● Setting the time zone

- 1) Select “Time Zone” from the pull-down menu.
- 2) Click the “Adjust” button.

● Daylight Saving setting

- 1) Select “ON” or “OFF” for the “Daylight Saving” setting (default: OFF).
- 2) Click the “Adjust” button.

■ Restoring the default settings

You can restore the default settings (initial state).

- 1) Click “Restore factory default configuration.”

A confirmation message appears, asking whether or not the current settings should be restored to the default configuration.
- 2) Click “OK.”

■ Rebooting the network camera

You can restart the network camera.

1) Click “Reboot IP Camera.”

A confirmation message appears, asking whether or not the camera should be rebooted.

2) Click “OK.”

■ Updating the Firmware

You can update the firmware on the network camera.

Click “Firmware update.”

For details, refer to “Updating the Firmware” (page. 75).

■ Click “Firmware update.”

You can save the network camera settings on a personal computer.

Click “Export current configurations.”

For details, refer to “Saving the Settings on a Personal Computer” (page. 77).

When updating the firmware, the settings are reset. Make sure to save the settings of the camera on your personal computer before starting update operation.

■ Importing the Settings Saved on a Personal Computer

You can import the settings saved on a personal computer to the network camera.

Click “Import new configurations.”

For details, refer to “Saving the Settings on a Personal Computer” (page. 77).

User Settings

You can set up access rights.

1 Click “Configuration” on the left side of the “Camera Window” screen.

- The Configuration menu appears on the left side of the screen.

2 Click “User” on the left side of the screen.

- The User setting screen appears on the right side of the display.

TOSHIBA
Network Camera

[System](#)

[User](#)

[Admin](#)

[Alarm](#)

[Network](#)

[Mail](#)

[FTP client](#)

[FTP server](#)

[DDNS](#)

[Recording](#)

[Camera Window](#)

[View Log](#)

User Settings(<http://192.168.0.30>) [nwcam02](#) [Back to camera window](#)

User authorization required:

ON OFF

Add a user or change password:

User ID:

Password:

Confirm:

Delete user:

Username:

Current users list:

1: [guest](#)

3 Configure each item.

- **Displaying the screen asking a user name and password**
 - 1) Check “ON” in “User authorization required” (default: OFF).
 - 2) Click the “Set” button.
 - When accessing to the camera, you are required to enter a user name and password.

● Storing the user name and password

- 1) Enter the user name, password and password (confirm) for a new user in the field of "User ID," "Password" and "Confirm," respectively in "Add a user or change password."
- 2) Click the "Set/Change" button.
 - New user ID and password are stored in the network camera.

● Deleting a user name

- 1) Select the "User name" you want to delete from the pull-down menu.
- 2) Click the "Delete" button.

Admin Settings

You can change the Administrator ID and password and view the level of SD memory card.

1 Click “Configuration” on the left side of the “Camera Window” screen.

- The Configuration menu appears on the left side of the screen.

2 Click “Admin” on the left side of the screen.

- The Admin setting screen appears on the right side of the display.

TOSHIBA
Network Camera

[System](#)
[User](#)
[Admin](#)
[Alarm](#)
[Network](#)
[Mail](#)
[FTP_client](#)
[FTP_server](#)
[DDNS](#)
[Recording](#)
[Camera_Window](#)
[View_Log](#)

Admin Settings (<http://192.168.0.30>) [nwcam02](#) [Back to camera window](#)

Change ID/Password
Current login ID:
Current Password:
New login ID:
New Password:
New Password(Confirm):

Sound
 ON OFF

Recording Storage
mount status:
remaining KB
[Complete Format\(remove log messages\)](#)
[Quick Format\(remain log messages\)](#)
[Reboot IP Camera](#)

3 Configure each item.

● Changing the Administrator ID and password

- 1) Enter the current login ID and the current password in “Current Login ID” and “Current Password,” respectively.
- 2) Enter new login ID, new password and new password (confirm) in “New Login ID,” “New Password” and “New Password (Confirm),” respectively.
- 3) Click the “Change” button.

● Setting Sound

You can set up the camera to listen to sound on the camera even when logging in as User.

1) Set “Sound” to “ON” or “OFF”

ON: To enable you to listen to sound on the camera even when logging in as User.

(You can configure sound settings in “Audio Settings” (→ page. 74).)

OFF: To disable you to listen to sound on the camera when logging in as User.

(“Audio Settings” (→ page. 74) is not displayed when logging in as User.)

2) Click the “Set” button.

● Viewing the level of SD memory card

Click the “Reload” button.

● Formatting an SD memory card

Click the “Complete Format” or “Quick Format.”

The SD memory card is formatted used for the camera.

Complete Format: To delete all the data in the card. Only the log for the complete format remains.

Quick Format: To delete all the data except logs in the card.

● Restarting the camera

Click the “Reboot IP Camera.”

Important

- To change an SD memory card, turn off the camera once to switch cards and then turn on the power of the camera again. When the camera is powered with PoE, disconnect the LAN cable once to switch cards and then connect the LAN cable again.

Alarm Settings

You can configure the external alarm and motion detection.

If you connect a sensor or other device to the alarm input terminal (→ page 80), an alarm will notify you when the sensor detects anything out of the ordinary. For example, if you connect a sensor attached to a door, an alarm can notify you when the door is opened or closed. If you set the function of the “Motion Detect” to “Enable”, an alarm will notify you when a change is detected.

Furthermore, you can configure the EXT Control. When selecting the EXT Control, you can control when to start recording from the external area. Likewise, connect a device to the alarm input terminal when the EXT Control is used.

1 Click “Configuration” on the left side of the “Camera Window” screen.

- The Configuration menu appears on the left side of the screen.

2 Click “Alarm” on the left side of the screen.

- The Alarm setting screen appears on the right side of the display.

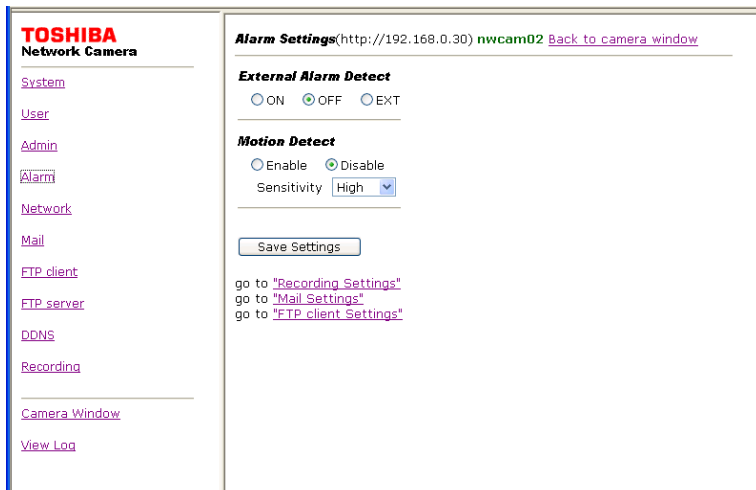

3 Configure each item.

● Configuring an external alarm

1) Select one of the followings in “External Alarm Detect:”

- ON : To detect an external alarm
 - OFF : Not to detect an external alarm
- (Default: OFF)

2) Click the “Save Settings” button.

● Setting the motion detection

1) Select one of the followings in “Motion Detect.”

Enable : To turn motion detection on.

Disable : To turn motion detection off.

(Default: Disable)

2) Select the “Sensitivity” level from the pull-down menu.

High : Generates an alarm upon detection even to the slightest change in brightness.

Middle : Sensitivity is at a level between High and Low.

Low : Generates an alarm upon detection of significant changes in brightness only.

(Default: Middle)

★If an alarm is detected frequently when there are no abnormalities, reduce the level of sensitivity.

3) Click the “Save Settings” button.

● Setting up EXT Control

1) Select “EXT” in “External Alarm Detect.”

2) Click the “Save Settings” button.

NOTE

- For record settings at the time of alarm generation, refer to “Alarm Recording” (→ page.40) and “FTP by External Alarm/Motion Detection” (→ page.46).
- For record settings when the EXT Control is used, refer to “FTP by EXT Control” (→ page.48).
- You can send an email at the time when an alarm is raised. For more information about settings, refer to “Mail Settings” (→ page. 68).

Network Settings

You can configure an IP address for network connection.

1 Click “Configuration” on the left side of the “Camera Window” screen.

- The Configuration menu appears on the left side of the screen.

2 Click “Network” on the left side of the screen.

- The Network setting screen appears on the right side of the display.

The screenshot shows the TOSHIBA Network Camera configuration interface. On the left is a navigation menu with links: System, User, Admin, Alarm, Network (highlighted), Mail, FTP client, FTP server, DDNS, Recording, Camera Window, and View Log. The main content area is titled 'Network (http://192.168.0.30) nwcam02 Back to camera window'. It contains two sections: 'Connection Settings' and 'HTTP Settings'. In 'Connection Settings', the 'Automatically by DHCP' option is selected. The 'Manually' option is also present but unselected. Below are input fields for IP address (192.168.0.30), Subnet mask (255.0.0.0), Default gateway (0.0.0.0), DNS 1 (localdomain), and DNS 2 (null). A 'Save' button is located below these fields. The 'HTTP Settings' section has an 'HTTP Port Number' field set to 80 and a 'Change' button.

3 Configure each item.

● Configuring the connection

- 1) To set an IP address manually, check “Manually.” To obtain an IP address from the DHCP server, check “Automatically by DHCP.”
(Default: Automatically by DHCP)
- 2) When “Manually” is checked, fill in “IP Address,” “Subnet Mask,” “Default Gateway,” “DNS1” and “DNS2.”
- 3) Click the “Save” button.

● Configuring the HTTP port number

- 1) Enter the HTTP port number in “HTTP Port Number” (default: 80).
 - For most applications, select 80 (default: 80).
- 2) Click the “Change” button.

Important

- If you do not know the subnet mask, consult the provider or relevant network system administration support center.
- You do not need to enter the default gateway if the network camera will not be accessed from another network. If you do need to enter a default gateway, consult your network system administration support center.
- When you try to reconnect to the network camera, be sure to confirm that the entered IP address and HTTP port number are new ones if you changed the IP address and HTTP port number.

Mail Settings

You can configure the camera to send an email up to 10 addresses when an external alarm goes off, any motions are detected or an error occurs in an SD memory card.

1 Click “Configuration” on the left side of the “Camera Window” screen.

- The Configuration menu appears on the left side of the screen.

2 Click “Mail” on the left side of the screen.

- The Mail setting screen appears on the right side of the display.

TOSHIBA
Network Camera

[System](#)
[User](#)
[Admin](#)
[Alarm](#)
[Network](#)
[Mail](#)
[FTP_client](#)
[FTP_server](#)
[DDNS](#)
[Recording](#)
[Camera Window](#)
[View Log](#)

Mail Settings(http://192.168.0.30/nwcam02 [Back to camera window](#))

Mail Server(SMTP):
POP before SMTP: ON OFF
User ID:
Password:
Sender email address:

Recipient email address1:
Recipient email address2:
Recipient email address3:
Recipient email address4:
Recipient email address5:
Recipient email address6:
Recipient email address7:
Recipient email address8:
Recipient email address9:
Recipient email address10:

Subject:
 Camera Name automatically
Message body:
Attach File:
 Send email when motion detected.
 Send email when external alarm detected.
 Send email when accumulation error caused.
 Send notification email by accumulating time.

3 Configure each item.

- 1) Enter the IP address or the server name of the SMTP in “Mail Server (SMTP).”
- 2) Enter the authorization ID and password of the POP3 server in “User ID” and “Password” of “POP before SMTP.”

When you are not using the POP3 server, check “OFF” in “POP before SMTP” (default: “OFF” in “POP before SMTP”).

- 3) Enter the email address of the Administrator in “Sender email address.”
- 4) Click the “Save Settings” button.
- 5) Enter email addresses of up to 10 destinations in “Receiver email address 1” to “Receiver email address 10.”
- 6) Click the “Save Settings” button.
- 7) Enter the mail title in “Subject” (default: TOSHIBA Network Camera).
If a check is added to “Camera Name automatically,” the camera name is set automatically as the subject.
- 8) Enter your message in the “Message body.”
- 9) Select the number of attached images from the “Attach File” pull-down menu.
- 10) Select whether or not a mail should be sent in the following cases:
 - “Send email when motion detected”
Check here to send a mail when a motion is detected.
 - “Send email when external alarm detected”
Check here to send a mail when an external alarm is detected.
 - “Send email when accumulator error caused”
Check here to send a mail when an error occurs in an SD memory card to accumulate images.
 - “Send notification email by accumulating time”
Check here to send a notification mail at 30-minute intervals up to the total length of time (240 minutes) when starting accumulating image data in an SD memory card.
30min, 60min, 90min, 120min, 150min, 180min, 210min, 240min
- 11) When an error occurs in sending a mail, you can set up the re-sending operation.
 - Follow the setup procedures below:
 - 11-1) Check “ON” of “In an email transmitting error, [] times resendings are tried every [] minutes” (default: not marked).
 - 11-2) Select the times of resending operation from the pull-down menu for the first [] (default: 3).
 - 11-3) Select the time interval of resending operation from the pull-down menu for the second [] (default: 3).
- 12) Click the “Save Settings” button.

NOTE

- POP3 is a protocol for receiving (retrieving) mail from the mailbox. However, these settings will not result in received mail, for example, being deleted because the network camera does not retrieve mail.
- The mail function of the network camera does not support “SMTP Auth”.
- The attached image data is in a format that ordinary mail client software can read.

FTP Client Settings

You can store images on an FTP server.

1 Click “Configuration” on the left side of the “Camera Window” screen.

- The Configuration menu appears on the left side of the screen.

2 Click “FTP client” on the left side of the screen.

- The FTP client setting screen appears on the right side of the display.

TOSHIBA
Network Camera

[System](#)
[User](#)
[Admin](#)
[Alarm](#)
[Network](#)
[Mail](#)
[FTP client](#)
[FTP server](#)
[DDNS](#)
[Recording](#)
[Camera Window](#)
[View Log](#)

FTP Client Settings(http://192.168.0.30) nwcam02 [Back to camera window](#)

FTP General Settings

Ftp server:
User ID:
Password:
Port Number:
Mode: PORT PASV

Connection to FTP Server

Stay Connect
 Re-connect

Connection to FTP Enable

Periodic
 External Alarm Detection
 Motion Detection
 EXT Control
 OFF

Periodic FTP by Schedule

Monday	<input checked="" type="radio"/> OFF	<input type="radio"/> All Day	<input type="radio"/> Timer Pattern1	<input type="radio"/> Timer Pattern2
Tuesday	<input checked="" type="radio"/> OFF	<input type="radio"/> All Day	<input type="radio"/> Timer Pattern1	<input type="radio"/> Timer Pattern2
Wednesday	<input checked="" type="radio"/> OFF	<input type="radio"/> All Day	<input type="radio"/> Timer Pattern1	<input type="radio"/> Timer Pattern2
Thursday	<input checked="" type="radio"/> OFF	<input type="radio"/> All Day	<input type="radio"/> Timer Pattern1	<input type="radio"/> Timer Pattern2
Friday	<input checked="" type="radio"/> OFF	<input type="radio"/> All Day	<input type="radio"/> Timer Pattern1	<input type="radio"/> Timer Pattern2

3 Configure each item.

- For details, refer to “Recording Images on FTP Server” (→ page. 41).

FTP Server Settings

You can configure the network camera as an FTP server to access to a specific directory from a personal computer.

1 Click “Configuration” on the left side of the “Camera Window” screen.

- The Configuration menu appears on the left side of the screen.

2 Click “FTP server” on the left side of the screen.

- The FTP server setting screen appears on the right side of the display.

TOSHIBA
Network Camera

[System](#)
[User](#)
[Admin](#)
[Alarm](#)
[Network](#)
[Mail](#)
[FTP_client](#)
[FTP_server](#)
[DDNS](#)
[Recording](#)
[Camera Window](#)
[View Log](#)

FTP Server Settings(http://192.168.0.30) nwcam02 [Back to camera window](#)

User ID:

Password:

FTP Root Path:

Max connection: ▼

3 Configure each item.

- 1) Enter the user name in “User ID” (default: ftproot).
- 2) Enter the password in “Password” (default: ftpikwb).
- 3) Enter the directory inside the camera (SD memory card) in “FTP Root Path.” (Example: /Normal/)
- 4) Select the number of maximum connections from the pull-down menu in “Max connection” (default: 1).
- 5) Click the “Save Settings” button.

You can now connect to the specified directory in the camera by using the user name and password you entered.

DDNS Settings

You can utilize the DDNS. Configure the connection for a DDNS server.

1 Click “Configuration” on the left side of the “Camera Window” screen.

- The Configuration menu appears on the left side of the screen.

2 Click “DDNS” on the left side of the screen.

- The DDNS setting screen appears on the right side of the display.

TOSHIBA
Network Camera

[System](#)
[User](#)
[Admin](#)
[Alarm](#)
[Network](#)
[Mail](#)
[FTP client](#)
[FTP server](#)
[DDNS](#)
[Recording](#)
[Camera Window](#)
[View Log](#)

DDNS Settings (http://192.168.0.30) nwcam02 [Back to camera window](#)

DDNS Enable Disable

UserName

Password

DDNS Server:

To sign up DDNS, click [here](#).

The MAC address of this camera is

3 Configure each item.

- 1) Select “ON” to use the DDNS (default: OFF).
- 2) Enter the user name in “User ID.”
- 3) Enter the password in “Password.”
- 4) Enter the DDNS server name in “DDNS Server” (default: www.netcam.zaantek.net). Do not change the DDNS server name.
- 5) Click the “Save” button.

Clicking “here” in “To sign up DDNS, click here.” displays a web page, allowing you to sign up to use a DDNS.

Recording Settings

You can control the settings for image data recording at the time of external alarm detection and motion detection as well as normal recording on an SD memory card inserted to the network camera.

1

Click “Configuration” on the left side of the “Camera Window” screen.

- The Configuration menu appears on the left side of the screen.

2

Click “Recording” on the left side of the screen.

- The Recording setting screen appears on the right side of the display.

TOSHIBA
Network Camera

[System](#)
[User](#)
[Admin](#)
[Alarm](#)
[Network](#)
[Mail](#)
[FTP client](#)
[FTP server](#)
[DDNS](#)
[Recording](#)
[Camera Window](#)
[View Log](#)

Recording Settings(<http://192.168.0.30>) [nwcam02](#) [Back to camera window](#)

Alarm Recording

External Alarm ON OFF
Motion Detection ON OFF
Pre-Recording: 10
Post-Recording: 10
Interval(s): 1
[Save](#)

Normal

ON OFF
Interval(s): 1
Timer Association ON OFF
Start: 08 am Stop: 05 pm
[Save](#)

Overwrite

ON OFF
[Save](#)

go to ["Alarm Settings"](#)

3

Configure each item.

- For details, refer to “Recording Images on an SD Memory Card” (→ page.39).

Audio Settings

You can configure the audio input from the network camera.

When setting to “ON” in “Sound” of the Admin Settings, the audio settings can be available even when logging in as User. When “OFF” is selected, the setting cannot be configured through the User login.

1 Click “Sound” on the left side of the “Camera Window” screen.

- The Audio setting screen appears on the right side of the display.
- When setting to “OFF” in “Sound” of the Admin Settings, “Sound” is not displayed on the left side of the “Camera Window” screen.

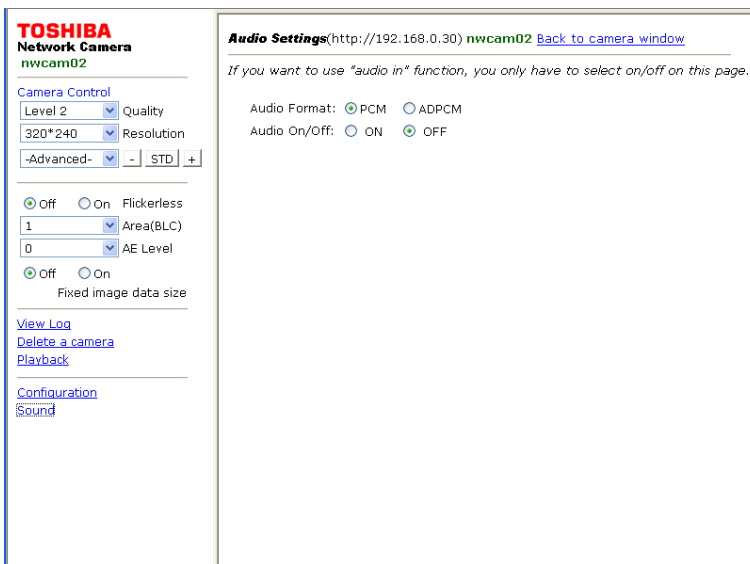

2 Configure each item.

- 1) Select one of the followings in “Audio Format:”
 - PCM : Normal audio format (default)
 - ADPCM : To reduce data capacity by compression as compared to PCM
- 2) Select one of the followings in “Audio On/Off:”
 - ON : To input audio from the network camera
 - OFF : Not to input audio from the network camera (default)

Updating the Firmware

Follow the procedures below to update the firmware.

- When updating the firmware, all the settings are reset except IP addresses. Make sure to back up the settings of the camera before starting update operation (→ page. 77).
- When the update operation is completed, import the setting data from your personal computer (→ page. 78).

■ Before Starting

Download the latest firmware.

- Create a folder where you want to save the latest firmware.
- Access to the following Toshiba Web page on the Internet.

URL: <http://www.netcam.toshiba.com>

- Download the latest firmware according to the instructions on the Web page.

1

Click “Configuration” on the left side of the “Camera Window” screen.

- The Configuration menu appears on the left side of the screen.

2

Click “System” on the left side of the screen.

- The System setting screen appears on the right side of the display.

The screenshot shows the 'System Setting' web page for a Toshiba Network Camera. On the left is a navigation menu with links: System, User, Admin, Alarm, Network, Mail, FTP client, FTP server, DDNS, Recording, Camera Window, and View Log. The main content area is titled 'System Setting' and includes the following fields and options:

- Camera name: nwcam02 (with a 'Change' button)
- Camera's time: 8 Oct 2004 8:59:44
- Date-Time Displaying Format: dd Mmm yyyy HH:MM:SS (dropdown menu)
- Text Color: green (dropdown menu, with a 'Change' button)
- NTP: NTP: NTP Server: [text box], Adjusting Cycle: 24 hours
- Input new time: Input new time: Synchronize with PC's time
- Date: 9/10/2004
- Time: 1:3:13
- Time Zone: GMT-07:00 (dropdown menu)
- Daylight Saving: ON OFF
- Adjust: [button]

At the bottom, there are links for: Restore factory default configuration, Reboot IP Camera, Firmware update, Export current configurations, and Import new configurations.

Updating the Firmware (Cont.)

3 Click “Firmware update.”

- The Firmware update screen appears on the right side of the display.

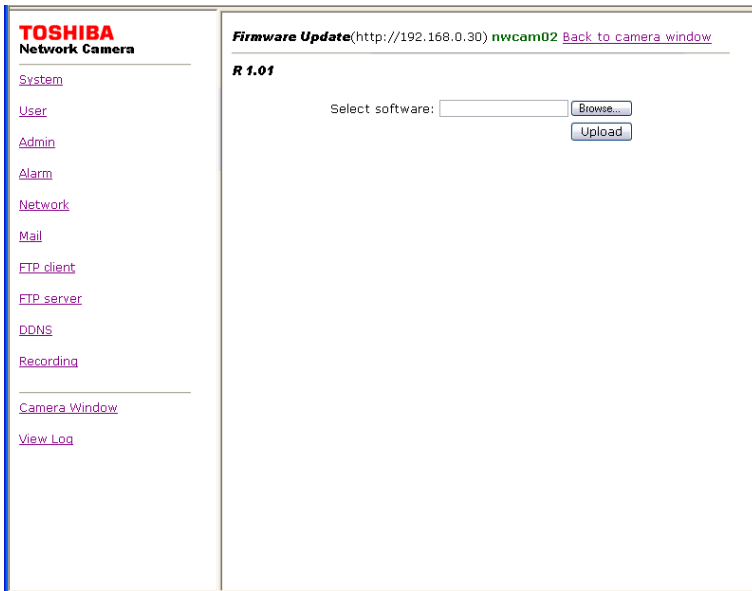

4 Click the “Browse” button.

- A screen appears, allowing you to select a file.

5 Select the file of the latest firmware you downloaded in the above “Before Starting” section.

- The name of selected file appears on the screen shown in Step 3.

6 Click “Upload” button on the screen shown in Step 3.

- Follow the instructions on the screen to update the firmware.
- Restart the camera after the firmware is completely updated.

Important

- Please ensure that your camera has the latest firmware update.
- All the operations stop in the camera while the firmware is updated.
- Never turn off the camera while the firmware is updated. It causes a failure of updating operation.
- Never disconnect a LAN cable from the camera while the firmware is being updated. Doing so may cause a malfunction.

Download from [Www.Somanuals.com](http://www.Somanuals.com). All Manuals Search And Download.

Saving the Settings on a Personal Computer

You can save the settings of the network camera on a personal computer.

1 Click “Configuration” on the left side of the “Camera Window” screen.

- The Configuration menu appears on the left side of the screen.

2 Click “System” on the left side of the screen.

- The System setting screen appears on the right side of the display.

TOSHIBA
Network Camera

[System](#)
[User](#)
[Admin](#)
[Alarm](#)
[Network](#)
[Mail](#)
[FTP client](#)
[FTP server](#)
[DDNS](#)
[Recording](#)
[Camera Window](#)
[View Log](#)

System Setting(<http://192.168.0.30/nwcam02> [Back to camera window](#))

Camera name

Camera's time: 8 Oct 2004 8:59:44
Date-Time Displaying Format
Text Color

NTP:
NTP Server:
Adjusting Cycle: hours
 Input new time: Synchronize with PC's time
Date
Time
Time Zone:
Daylight Saving ON OFF

[Restore factory default configuration](#)
[Reboot IP Camera](#)
[Firmware update](#)
[Export current configurations](#)
[Import new configurations](#)

3 Click “Export current configurations.”

- When a confirmation screen appears for saving a file, click “Save.”
- The Save As screen appears.

4 Specify the destination and then save the file.

- The file on settings is saved (example of file name: ikwb02conf.ini)

Saving the Settings on a Personal Computer (Cont.)

Importing the Settings Saved on a Personal Computer

1 Click “Import new configurations” on the System setting screen.

- The Import new configuration screen appears on the right side of the display.

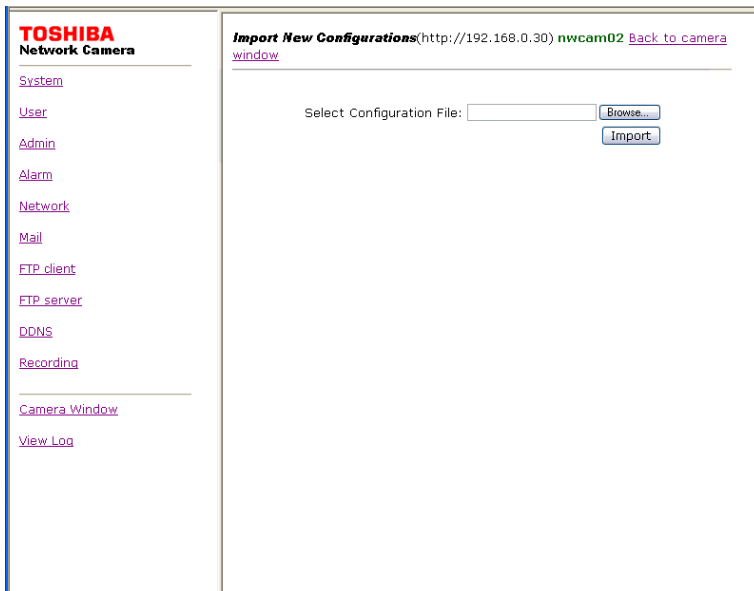

2 Click the “Browse” button.

- A screen appears, allowing you to select a file.

3 Select the file on settings you saved.

- The name of selected file appears on the screen shown in Step 1.

4 Click “Import” on the screen shown in Step 1.

- The settings of the network camera are replaced by the settings you saved.

Others

- **Alarm Terminals**
- **Index (Glossary)**
- **Display of Logs**
- **Before Calling Service Personnel...**
- **Specifications**
- **Appearance Diagram**

Alarm Terminals

You can connect a variety of sensors to the camera by using alarm terminals. See following table for functions of each terminal.

Name	Function	Description
ALARM IN	Alarm Input	Inputs External Alarm signal. Connect a sensor or other devices to the camera.
GND	GND	GND for a signal

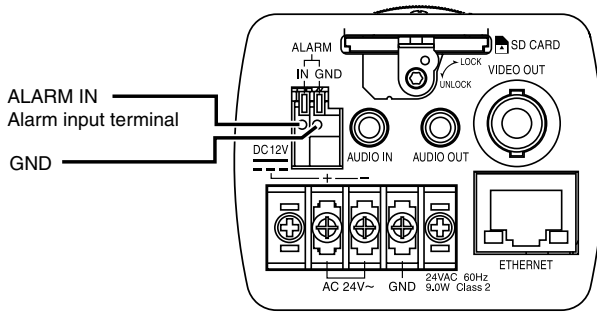

Specifications of Alarm Signals

Name	Internal Circuit	Signal Condition
Alarm Input		<p>Non-Voltage point signal, TTL signal inputs</p>

Example Circuit Connection

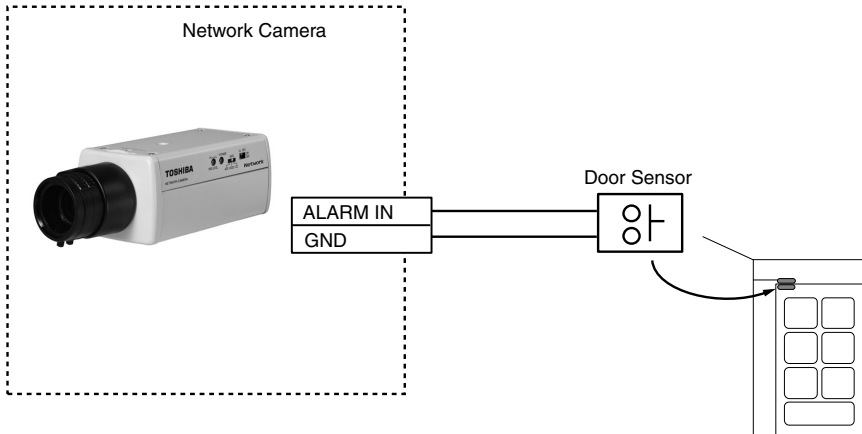

Installation/Set up

Viewing • Listening and Operation

Recording

Setting up

Others

Index (Glossary)

A

AC IN	5
Accessories	Safety Precautions5
Adjust the date and time	58
Administrator	18
ADPCM	74
AE level	29
Compensation for Automatic Exposure of the camera.	
AES	11
ALARM IN (Alarm input terminal)	80
Alarm list	32
Alarm settings	64
Attaching picture to mail	69
AUDIO IN	5
AUDIO OUT	5
Audio settings	74
AVI	52
AWB	11

B

Back Focus	10
Back light compensation (BLC)	11, 29
Before calling service personnel	88
Browser	15, 26
Software to view WEB screens. There is browser of Microsoft®'s Internet Explorer™	

C

Camera searching application "Camera Finder"	16
Camera name	27
Camera Window	27
Changing password	18
Connection	14
Crossover cable	14
One of the Ethernet cables made to connect 2 PCs without using hub or router.	
CS mount lens	8

D

Daylight Saving	58
DC IN (Power input terminal)	5

DC lens	10
DDNS	72
(Dynamic Domain Name System)	

This is the technique to overwrite the information of DNS (Domain Name System) server dynamically and forward only different information between DNS servers. Because of this, it enables to reduce forwarding data which are needed to renew information of DNS server, and reduce overhead of the network. If this combines with DHCP (Dynamic Host Configuration Protocol), it is possible to assign IP address and host name right away as the host on the LAN changes.

Default gateway	66
Network devices cannot communicate directly with devices in other networks. In this case, communication becomes possible by using devices like router. Generally, when communicating with other networks, you set the sending destination to that router.	

DHCP	13
(Dynamic Host Configuration Protocol)	

This is the protocol to assign IP address dynamically to each client on TCP/IP network. DHCP server controls information of IP address, gateway address, domain name and subnet mask and can assign these to client.

DNS	66
(Domain Name System)	

IP address is composed of list of numbers, and is hard to manage. Thus we use domain name which consists of alphabet and some symbols as alias to operate computers. This system, to correspond the IP address and the domain name, is called DNS.

Download	75
Taking and saving data from a device in remote place by using network.	

E

EE lens	10
Ethernet	5
Communication specification of computer network that is standardized by IEEE802.3	

EXT control	65
External Alarm	64

F

Firmware	75
----------------	----

Program to run this product. It is installed in the flash memory, and can overwrite the program from PC by using PC upload function of the WEB.

Formatting an SD memory card	63
------------------------------------	----

Frame rate	95
------------------	----

Barometer for renewing displayed images per second.

FTP	41
-----------	----

(File transfer Protocol)

A protocol to transfer file(s) to other computers. The network camera equips both Active and Passive modes, and also supports Firewall.

H

Hub	14
-----------	----

Wire gathering device used in 10Base-T/100Base-TX network. Build up a network by connecting devices around a hub radially. There are various ports, like 8port, 4port.

I

Image Accumulation	49
--------------------------	----

IP address	13
------------------	----

Address information for IP protocol. All devices communicate with IP must have IP addresses. Devices connected to the Internet must have only one global IP address in the world. IP address can be divided into network ID and host ID, and depending on the values of network ID, it also can be divided into class A, B and C.

Iris connector	10
----------------------	----

Iris level	10
------------------	----

Iris switch	10
-------------------	----

J

JPEG	51
------------	----

(Joint Photographic Experts Group)

Standard gauge for compression of colored still image by ITU-TS (International Telecommunication Union: ex-CCITT) and ISO (International Organization for Standardization). It can compress a still image between 1/10 to 1/100 of size.

L

LAN	14
-----------	----

(Local Area Network)

Computer networking in small area.

Lens	8
------------	---

Level of SD memory card	63
-------------------------------	----

LIVE	31
------------	----

Images which the camera is projecting is called LIVE.

Log	34
-----------	----

Login	18, 20
-------------	--------

M

MAC Address	72
-------------------	----

(Media Access Control Address)

Assigned individual code for each network card. Ethernet sends and receives the frame(data) by using this code.

Mail settings	68
---------------------	----

Motion detection	64
------------------------	----

N

Network	14
---------------	----

PCs and other devices are connected to each other for information exchange via cables, public lines and/or radio.

Networking settings	66
---------------------------	----

Normal list	33
-------------------	----

NTP server	58
------------------	----

(Network Time Protocol)

Server which provides accurate date and time from network.

Index (Glossary) (Cont.)

O

OS Safety Precautions4

P

PCM 74

Picture quality 28

Playback 31

The camera can play recorded images.
This function is called playback.

Playing recorded images 31

PoE 8, 94

POP3 68

(Post Office Protocol Version 3)

Protocol needed to receive e-mail on the Internet and Intranet. Client uses this when receiving e-mail from the mail server, and it has attesting function. Some mail servers use this function to send mail with SMTP.(POP3 before SMTP)

Port Number 67

The number to discriminate services (kinds of application) on TCP and UDP. For example, SMTP for e-mail uses 25 and 80 for HTTP in general.

Power cord 8

Protocol 95

Q

Quality 28

R

Reboot 58, 63

Recording normal images 40

Reset button 5, 93

Resolution 28

Returning to the default settings 58

RNCP 95

(Retrieve Neighborly Cameras Protocol)

Protocol for mutual communication. Because of this protocol, the cameras can identify each other. The camera searching application, Camera Finder, also uses this protocol.

Router 14

Device which relays data on a network to other network is called router. It decides by itself to which route to choose to forward the data by looking at IP address of network device.

S

Saving the settings 77

Screw holes for a tripod /stand 5, 6

SD memory card . 39, Safety Precautions12

Secure Digital memory card. New super compact memory card that can record huge volume of multi media data.

SMTP 68

(Simple Mail Transfer Protocol)

Protocol for sending e-mail on the Internet and Intranet. Used when exchanging e-mail between servers or when client sends mail to the server.

Specifications 95

Still image 51

Straight-through Cable 14

One of the Ethernet cables to connect PC and Ethernet hub.

Subnet mask 66

IP address is composed of network ID and host ID. It plays a role to judge the length of network ID to distinguish network ID and host ID. By using this system, it estimates whether IP address of the addressed host is in local network or remote network.

T

TCP/IP 95

(Transmission Control Protocol/Internet Protocol)

This is the standard protocol of the Internet and at the same time, it is the most popularized protocol. Network layer protocol is IP, and transport layer protocols are TCP (Transmission Control Protocol) and UDP (User Datagram Protocol). FTP, SMTP and other applications use TCP/IP.

Timer recording 40

U

Updating firmware 75

URL 15

(Uniform Resource Locator)

Method for assigning the Internet resource. "http://www.toshiba.com/" is the example of when accessing a website on the Internet.

V

VIDEO OUT 5
Video output 5

W

Wall bracket Safety Precautions 15
White Balance 11

Display of Logs

Logs are saved in an SD memory card. When the SD memory card is not set, no logs are accumulated.

Up to about 4,000 logs can be accumulated on an SD memory card.

Display	Description
System Boot	The system was booted (rebooted)
Change Quality	The image quality is changed
Change resolution	The resolution (image size) is changed
Change Brightness	The brightness is changed
Change Contrast	The contrast is changed
Change Saturation	The saturation is changed
Change Hue	The hue is changed
Set Flickerless	The flickerless is set
Change Area(BLC)	The back light compensation area is changed
Change AE Level	The AE level is changed
Camera Name	The camera name is changed
Set Time Type	The form of date/time display is changed
Set Text Color	The color of date/time display is changed
Change Camera Time	The date/time on the camera is changed
Set Daylight Saving	The daylight saving is set
Load default config	The settings are reset to the default state
Upload IPCamera	The firmware on the camera is updated
Export config	The configuration is exported
Import config	The configuration is imported
Set User check	The access restriction is set
Add User	The User login is added
Delete User	The User login is deleted
Change Admin	The Administrator login is changed
Format SD card	An SD memory card is formatted
Set Alarm Detect	The External Alarm Detection is set
Set Motion Detect	The Motion Detection is set
Set Connection	The connection setting is configured
Set Http port	The HTTP port number is set
Set Mail	The Mail setting is configured
Set POP before SMTP	The POP before SMTP setting was enabled
Set FTP Client	The FTP client setting is configured
Set FTP Port	The FTP port number is set
Set FTP Mode	The FTP transfer mode is set
Set FTP connection type	The FTP connection type is set
Connection FTP Enable	An item to record images to an FTP server is set
Change FTP Schedule	The Periodic FTP Recording by Schedule is changed
Change FTP Alarm/Motion Detection	The FTP Recording by External Alarm/Motion Detection is changed
Change FTP EXT Control	The FTP Recording by EXT Control is changed
Accumulation When FTP Error	The data accumulation to an SD memory card at the time of FTP error occurrences is set
Set FTP Server	The FTP Server setting is configured

Display	Description
Set DDNS	The DDNS setting is configured
Set Recording	The Record settings is configured
Set Record Schedule	The record schedule is set
Set Alarm Record	The recording at the time of external alarm generation is set
Set Motion Record	The recording at the time of motion detection is set
Ext control short/open	The EXT Control is short-circuited/opened
FTP down:re-connect	When an FTP server is down: Reconnected
FTP down:start accumulation	When an FTP server is down: Started the accumulation
FTP down:accumulation finish	When an FTP server is down: Ended the accumulation
FTP Server login in fail	Failed to log in an FTP server
FTP Client storage path isn't exist	No directory to store in an FTP server does not exist
FTP binary mode change fail	Failed to change to FTP binary mode
Mail connect	Connected to a mail server
Mail connect fail	Failed to connect to a mail server
Send e-mail finish	An e-mail is completely sent
NTP connect fail	Failed to connect to an NTP server
New client	A new client logged in to the camera
SD unmount, Recording failure	Recording failed because the SD card was not inserted
SD unmount, Accumulation failure	Accumulation failed because the SD card was not inserted
Completed sending accum data	All the accumulated data was re-transferred to the FTP server
discard, yymmddHHMMSS.jpg	A yymmddHHMMSS.jpg file was discarded internally
FTP fail to write image	A JPEG file failed to be written to the FTP server
FTP down: Accumulaiton of xxx min (incr)	The amount of data accumulated while the server was down is equivalent to xxx minutes (increase)
FTP down: Accumulaiton of xxx min (decr)	The amount of data accumulated while the server was down is equivalent to xxx minutes (decrease)

Before Calling Service Personnel...

Symptom	Cause	How to Manage
There is no IP address of your network camera on The Camera Finder's Network Camera List.	●The power of the camera is not turned on.	●Turn on the power.
	●LAN cable is not connected.	●Connect the LAN cable of the camera to a hub or router in the right way. ●Be sure to turn on the power of the hub and router.
	●LAN cable is not connected to the PC.	●Connect the LAN cable to the PC in the right way.
	●IP address of the PC is not configured.	●Configure the IP address of your PC correctly. (→ page 15).
Cannot display a browser from Camera Finder.	●Installed directory of browser is wrong.	●Assign the directory where you are going to install the browser. Start Camera Finder and go to "View"/"Customize"/"Default Browser."
The message, "The page cannot be displayed," shows up, and cannot login to the camera even if you start Camera Finder.	●The IP addresses of the camera and your PC are wrong.	●Set the correct IP address of the network camera. ●Set the correct IP address of your PC.
	●Proxy has set to the browser.	●When proxy is set to the browser, sometimes you may not able to login. Change the setting which will not via the IP address of the network camera from the proxy of the browser, or the setting of host name which will not via proxy.
Cannot login to the camera even though entering the IP address of the camera directly to the browser, and "The page cannot be displayed" shows up.	See "The message, 'The page cannot be displayed,' shows up, and cannot login to the camera even if you start Camera Finder."	

Symptom	Cause	How to Manage
Error message shows up when trying to login.	● Entering wrong login ID and password.	● Enter right login ID and password. The default login ID is "root," and the password is "ikwb."
	● CapsLock of the PC is ON.	● The camera discriminates capital letter and lower-case letter. Enter your right login ID and password.
	● You forget your login ID and the password.	● You need to reset the camera. Remember that if you perform reset procedure of the camera, all the settings you have made will be deleted and the camera goes back to its default settings.
Cannot access to the camera from the Internet.	● Default gateway is not configured.	● Register your broadband router to the network camera as default gateway. (→ page 66)
	● Port forwarding is not configured to the broadband router.	● Configure port forwarding function (static IP masquerade, NAT) to your broadband router. For details, read the user's guide of your broadband router.
	● Setting access restriction from the Internet (WAN side), like IP filter, to the broadband router.	● Change the restriction setting. For details, read the user's guide of your broadband router.
	● Using local (private) IP address.	● When accessing via the Internet, you need to set global IP address provided from your Internet provider to the broadband router. For details, read the user's guide of your broadband router. There are fixed IP address and IP address from DHCP server that an Internet provider provides as a global IP address. Ask your Internet provider for more information.
	● The IP address which was provided from the DHCP server of the provider has been changed.	● Confirm the new IP address and try to access again with the new IP address. ● Renew the information registered to the DDNS server.

Before Calling Service Personnel... (Cont.)

Symptom	Cause	How to Manage
Cannot perform settings.	●Lost the power of the camera during the performance.	●Make sure that the power of the network camera is ON.
	●LAN cable of the camera has been pulled off during the performance.	●Make sure that the LAN cable is connected to a hub or router in the right way.
	●LAN cable of the PC has been pulled off during the performance.	●Make sure that the LAN cable is connected to a hub or router in the right way.
	●Lost the power of a hub or router during the performance.	●Make sure that the power of a hub or router is ON.
	●IP address in "Connection Settings" in "Network Settings" has been changed.	<ul style="list-style-type: none"> ●If you change the IP address, you cannot keep your settings in the setting screen with your old IP address. Search your camera with the application, Camera Finder, and try administrator login procedure again. ●When you enter IP address of the camera directly to the browser, enter the new IP address in URL like example below, and try login procedure again. http://192.168.0.40/

Installation/Set up

Viewing • Listening and Operation

Recording

Setting up

Others

Symptom	Cause	How to Manage
No images are displayed.	●The iris switch is not set properly.	●Set the iris switch properly for your lens.
	●The iris of your lens is not adjusted properly.	●Adjust the iris of your lens properly.
	●Any of the cables are not connected properly.	●Connect the cable properly.
The colors of images are poor.	●The video monitor is not adjusted properly.	●Adjust the video monitor properly.
	●Lightings are dim.	●Brighten the lightings.
Cannot display images from the network camera.	●The Internet line is busy.	●Wait for a little while. Sometimes it takes time to display images.
	●There are not enough resources (CPU power, RAM).	●There are the recommended requirements of PC to view the images of the network camera. (page 12) ●Close all applications other than the network camera browser.
Renewal speed of network camera images is too slow. (Part 1)	●Picture size is too large.	●The default setting of picture size is QVGA(320x240). To increase the speed, select a small image size in "Resolution" of "Camera Window."
	●Picture quality is too high.	●When you lower the image quality in "Quality" of "Camera Window," the renewal speed becomes faster; however, the picture quality becomes poor.
Renewal speed of network camera images is too slow. (Part 2)	●More than one users are accessing the camera at the same time.	●When many users access to the camera at the same time, the renewal speed of the image becomes slow.
The network camera images are reversed in upside-down.	●Installed the camera in wrong way.	●Make sure that the camera is installed in right way. Adjust the setting to place the "Toshiba" logo in the right direction.

Before Calling Service Personnel... (Cont.)

Symptom	Cause	How to Manage
Colors of the images are poor.	●Monitor color setting of your PC is set to 16 bit or less.	●Set the monitor color higher than 16bit.
Focus of the images is poor.	●The lens cover of the camera is not clean, or some dusts are on it.	●Wipe off the lens with dried cloth.
	●Distance to an object is too far.	●Check the minimum object distance of your lens.
No sound is output.	●Sound volume on your PC is "0."	●Adjust the volume of your PC.
	●No microphone is installed.	●Install commercial microphone (→ page 8) to your network camera.
	●The microphone you are using is not a supported microphone.	●You can install only condenser typed monaural microphone. Plug type has to be monaural 3.5f.
Sound sensitivity of your camera is poor.	●The microphone is facing wrong way.	●Face the microphone of the camera where you want to gather sound.
Cannot send mail.	●Settings of SMTP, POP3 server may not be right.	●Check your SMTP and POP3 server which are provided from your provider. (→ page 68)
	●DNS server setting may not be right.	●Set your DNS server from your provider to "DNS1" (Primary) and "DNS2" (Secondary) in "DNS Settings." (→ page 66) *Sometimes "primary" is described as "master" and "secondary" is described as "slave," but these meanings are the same.
	●Mail sending conditions are not configured.	●To send mail, you need to perform mail sending settings of the camera. (→ page 69)
Cannot perform Auto Time Settings.	●NTP server setting may not be right.	●The NTP server released on the Internet may become invalid without notifying users.
Couldn't complete firmware updating.	●Couldn't complete the updating because of network trouble, the power has cut off or other reasons.	●Retry updating firmware by following steps of "Updating the Firmware" on page 75.

Installation/Set up

Viewing • Listening and Operation

Recording

Setting up

Others

Symptom	Cause	How to Manage
Recorded images are not saved in FTP server.	●FTP recording function is not set to ON.	●Check the FTP recording function whether it is set to ON. (→ page 43)
	●IP address of the FTP server, ID/ password or transfer directory is not set properly.	●Set the correct information in the setting screen. (→ page 42)
	●Could not keep the communication with the server during file transfer using FTP.	●If the recording did not resume even if you wait for more than 1 minute, check the connections with FTP server and the network camera. ●When "Image Accumulation" is set to "ON" (→ page. 49), unsent recording files are accumulated in an SD memory card of the network camera. When the connection is re-established, all the accumulated recording data is sent to an FTP server.
Pre-/post-recording files of the Alarm are not sent to the FTP server.	●Pre-recording data is the data before alarm has generated. Therefore, its data sending order is not necessarily in order.	●Depending on the conditions of your server, networking, image size and/or image quality settings, numbers of sent images may become fewer than your expectation.
Cannot solve the problems.	_____	●Press the reset button. Pressing the reset button returns all the firmware settings of the camera to their default values (initial state at the time of purchase). Perform the following procedure to initialize the camera settings. 1. Use a LAN cable to connect the camera to a hub with the power is turned on. 2. Turn on the camera. 3. Wait about one minute. 4. Press and hold the camera reset button for five to ten seconds. 5. Wait about one minute. Once the camera has restarted, reconfigure the settings. For details on the network and other initial settings, refer to page 13.
	_____	●Consult with your dealer.

Before Calling Service Personnel... (Cont.)

About PoE Power Supply Function for Supplying Power via a LAN Cable

- There are two PoE (Power Over Ethernet) methods: the Spare Pair method (a power supply method that uses the unused wires) and the Signal Pair method (a power supply method that uses the signal wires). The camera, which is on the receiving side, supports both methods, but there are hubs and other power supply devices that only support one of the methods. For details, refer to the user's manual of the power supply device.
- Be sure to use a 4 pair twisted cable for the LAN cable because power cannot be supplied from the above-mentioned power supply device when some types of LAN cable are used.

Others

- When very strong light strikes at the lens, you might see stripe patterns (smear) on the images, but these are not malfunctions. If this happens, reinstall the camera in another place, or try to change the direction of the lens.
- Sound may not always synchronize with the camera images.

Specifications

Model name	IK-WB02A
Power	AC 24V±10% 60Hz/DC 12V±10%/ PoE
Power consumption	Approx. 5.5w with AI lens
Image sensor	1/3 inch CCD image area sensor
Image pickup area	4.96mm (0.195inch) horizontal X 6.0mm (0.236inch) vertical (1/3inch type)
Effective picture element	771 horizontal x 492 vertical
Scanning system	2:1 interlace NTSC Standard TV system
Scanning frequency	15.734kHz horizontal 59.94Hz vertical
Synchronization	Line-Lock, Internal manually switchable
Resolution	Horizontal 480 TV line Vertical 350 TV line (NTSC)
Minimum illuminance of subject	0.2Lux (F1.0, more than 10% of image output =0.45)
S/N	50 dB (Typ.) (AGC off, weight ON)
Video output	VBS 1.0V p-p / 75 ohms, composite
Output impedance	75 unbalanced
White balance	Automatic (2500.K to 10,000.K)
Iris control	Video Out / Iris Driver Circuit Built in
Gain control	Average AGC, (18dB)
Automatic electronic shutter	ON (1/60s to 1/100000) / OFF (1/60s)
Backlight compensation	Manual ON/OFF switch (selectable 5 area)
Lens mount	CS mount
Alarm terminal	Input X 1, Output X 1
Image size	640 X 480 320 X 240 160 X 120
Image compression method	JPEG
Quality settings	5 levels
Maximum frame rate *1	Max. 22 fps (640 X 480) Max. 30 fps (320 X 240, 160 X 120)
Audio *2	Available (bi-directional (input through a microphone, output through a speaker), PCM, ADPCM) Audio-in jack: 3.5mm mono mini jack, plug-in power supported Audio-out jack: 3.5mm mono mini jack
Motion alarm feature	Available (Recordable to an SD memory card)
Image recording feature	Available (Recordable to an SD memory card)
Storage media	SD memory card (not supplied)
Mail notification feature	Available
Interface	RJ-45 (10Base-T/100Base-TX)
Protocols	TCP/IP, UDP/IP, HTTP, SMTP, DNS, FTPc, FTPs, DHCP, POP3, DDNS, NTP, ARP, ICMP, RNCp
Guaranteed operating temperature	-10°C to +40°C
Guaranteed operating humidity	From 30% to 90% (no condensation should occur)
Storage temperature	-20°C to +60°C
Weight	Approx. 430g (camera only)
External dimensions	2.74(W) X 1.97(H) X 4.56(D) inches (63 X 50 X 116mm) (camera only)
Accessories	mini CD-ROM (1), Safety Precautions and Quick Start Guide (1), IRIS connector (1), EMI core (3)

*1: The specification varies depending upon the subjects, the image quality, the network environment and/or your personal computers.

*2: The sound may not be clear depending on the conditions of the lines.

● Designs and specifications may change without prior notice for better improvement.

● Some screen displays, pictures and illustrations contained herein may slightly differ from the actual images.

Appearance Diagram

Unit: mm

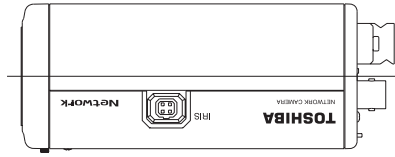

1/4-20UNC

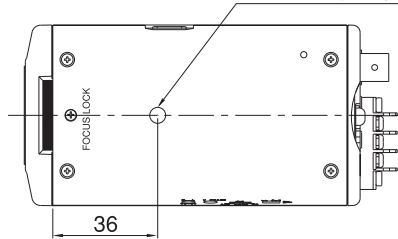

36

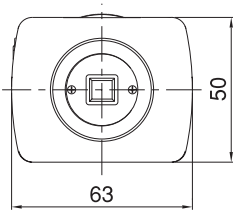

63

50

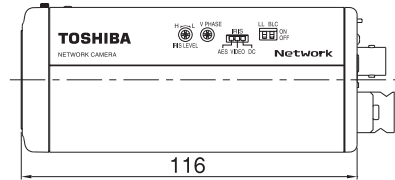

116

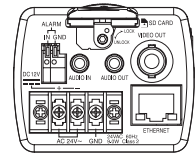

25

1/4-20UNC

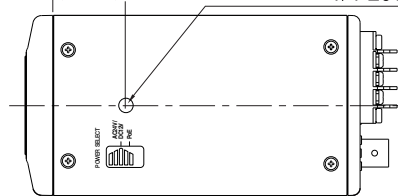

Installation/Set up

Viewing • Listening and Operation

Recording

Setting up

Others

TOSHIBA AMERICA INFORMATION SYSTEMS. INC

Security & Network Video Products

9740 Irvine Boulevard,

Irvine California 92618-1697

Phone Number: (877)696-3822

How to use "EMI core"

Three EMI cores are attached to this camera.

These parts are used like the following drawing.

If not used, an unnecessary radio wave may be emitted.

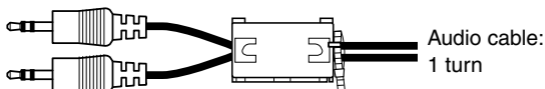
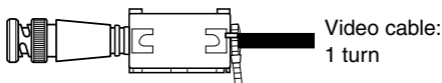

EMIコアの使いかた

このカメラには3個のEMIコアが同梱されています。

これらのコアは下図のようにしてお使いください。

使用されないと不要な電波が発生し、システムに障害が出る場合があります。

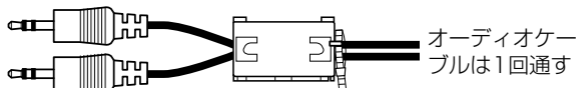

About the POWER SELECT Switch

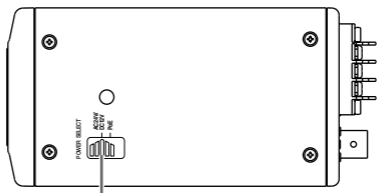

POWER SELECT Switch

When power is supplied from a PoE compatible hub, etc.

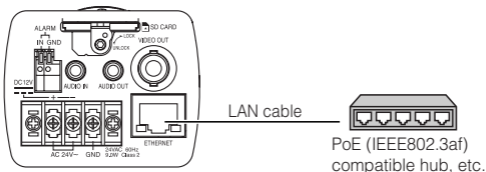

LAN cable

PoE (IEEE802.3af)
compatible hub, etc.



Switch the POWER SELECT switch to PoE.

When power is supplied from an AC24V or DC12V power source

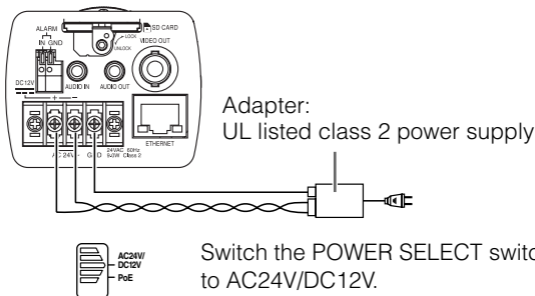

Adapter:
UL listed class 2 power supply



Switch the POWER SELECT switch to AC24V/DC12V.

Power will not be supplied if the power source type and

POWER SELECT switch do not match.

Free Manuals Download Website

<http://myh66.com>

<http://usermanuals.us>

<http://www.somanuals.com>

<http://www.4manuals.cc>

<http://www.manual-lib.com>

<http://www.404manual.com>

<http://www.luxmanual.com>

<http://aubethermostatmanual.com>

Golf course search by state

<http://golfingnear.com>

Email search by domain

<http://emailbydomain.com>

Auto manuals search

<http://auto.somanuals.com>

TV manuals search

<http://tv.somanuals.com>