

TOSHIBA

Leading Innovation >>>

dynadock™ wireless U User's Manual

GMAA00165010
07/09

Safety icons

This manual contains safety instructions that must be observed to avoid potential hazards that could result in personal injuries, damage to your equipment, or loss of data. These safety cautions have been classified according to the seriousness of the risk, and icons highlight these instructions as follows:

⚠ DANGER

Indicates an imminently hazardous situation which, if not avoided, will result in death or serious injury.

⚠ WARNING

Indicates a potentially hazardous situation which, if not avoided, could result in death or serious injury.

⚠ CAUTION

Indicates a potentially hazardous situation which, if not avoided, may result in minor or moderate injury.

CAUTION

Indicates a potentially hazardous situation which, if not avoided, may result in property damage.

NOTE

Provides important information.

Safety instructions

Always read the safety instructions carefully:

⚠ WARNING

Do not disassemble, modify, tamper with or repair the product

- ❖ Do not attempt to disassemble, modify, tamper with or repair the product (including the AC adaptor). Disassembly, modification, tampering or repairing the product could cause fire or electric shock, possibly resulting in serious injury.

Handling the AC adaptor and power cables/cords or plugs

- ❖ When handling the power cable/cord, follow these precautions:
 - ❖ Never tamper with the power cable/cord or plug.
 - ❖ Never splice or alter a power cable/cord.
 - ❖ Never bend or twist a power cable/cord.
 - ❖ Never pull on a power cable/cord to remove a plug from a socket. Always grasp the plug directly.
 - ❖ Never place heavy objects on a power cable/cord.
 - ❖ Never run a power cable/cord through a pinch point such as a door or window.
 - ❖ Never place a power cable/cord near a heat source.
 - ❖ Never use nails, staples or similar objects to fasten or attach cable/cord in place.
 - ❖ Never attempt to disassemble or repair an AC adaptor.Doing any of the above may damage the cables, and/or result in a fire or electric shock, possibly resulting in serious injury.

Attaching the power cable/cord

- ❖ Always confirm that the power plug (and extension cable plug if used) has been fully inserted into the socket, to ensure a secure electrical connection. Failure to do so may result in a fire or electric shock, possibly resulting in serious injury.
- ❖ Be careful if you use a power strip. An overload on one socket could cause a fire or electric shock, possibly resulting in serious injury.

Dust on the power plug connectors or connector base

- ❖ If dust gets on the power plug connectors or connector base, turn the power off and disconnect the power plug. Then clean the connector and/or connector base with a dry cloth. Continuing to use the product without cleaning the power plug may result in a fire or an electric shock, possibly resulting in serious injury.

Only use TOSHIBA AC adaptor

- ❖ Always use the TOSHIBA AC adaptor that may have been provided with your product, or use AC adaptors specified by TOSHIBA to avoid any risk of fire or other damage to the product. Use of an incompatible AC adaptor could cause fire or damage to the product, possibly resulting in serious injury. TOSHIBA assumes no liability for any damage caused by use of an incompatible adaptor.

Use correct power source

- ❖ Never plug the AC adaptor into a power source that does not correspond to both the voltage and the frequency specified on the regulatory label of the unit. Failure to do so could result in a fire or electric shock, possibly resulting in serious injury.

Only use approved power cables/cords

- ❖ Always use or purchase power cables/cords that comply with the legal voltage and frequency specifications and requirements in the country of use. Failure to do so could result in a fire or electric shock, possibly resulting in serious injury.

Do not handle the power plug with wet hands

- ❖ Never attempt to connect or disconnect a power plug with wet hands. Failure to follow this instruction could result in an electric shock, possibly resulting in serious injury.

Choking hazards

- ❖ Never leave small parts such as covers, caps and screws within the reach of infants or small children. Swallowing a small part may cause choking and suffocation resulting in death or serious injury. If a part is swallowed, immediately take appropriate emergency action and consult a doctor.

Avoid liquids, moisture and foreign objects

- ❖ Never allow any liquids to spill into any part of your product, and never expose the product to rain, water, seawater or moisture. Exposure to liquid or moisture can cause electric shock or fire, resulting in damage or serious injury. If any of these eventualities should accidentally occur, immediately disconnect the AC adaptor from the power plug socket and from the product.

Do not connect the power again until you have taken the product to an authorized service center. Failure to follow these instructions could result in serious injury or permanent damage to the product.

Never place your product or AC adaptor on a heat sensitive surface

- ❖ Never place your product or AC adaptor on a wooden surface, furniture, or any other surface that could be marred by exposure to heat since the product base and AC adaptor's surface increase in temperature during normal use.
 - ❖ Always place your product or AC adaptor on a flat and hard surface that is resistant to heat damage.
-

⚠ CAUTION

Never place your product in locations with excess heat

- ❖ Never place your product where it will be exposed to excess heat, such as in direct sunlight, in an unventilated vehicle or near a heater. This may result in a system failure, malfunction, loss of data or damage to the product.

Never place your product in a location with extremely low temperatures

- ❖ Never place your product in a location where it will be exposed to extremely low temperatures. This may result in a system failure, malfunction or loss of data.

Never subject your product to sudden temperature variations

- ❖ Never subject your product to sudden temperature variations. This may result in condensation, causing a system failure, malfunction or loss of data.

Never operate your product during a thunderstorm

- ❖ Never operate your product on AC power during a thunderstorm. If you see lightning or hear thunder, immediately unplug the product. An electric surge caused by the storm may result in a system failure, loss of data or hardware damage.

FCC information

FCC notice "Declaration of Conformity Information"

This equipment has been tested and found to comply with the limits for a Class B digital device, pursuant to part 15 of the FCC rules. These limits are designed to provide reasonable protection against harmful interference in a residential installation. This equipment generates, uses and can radiate radio frequency energy and, if not installed and used in accordance with the instructions, may cause harmful interference to radio communications. However, there is no guarantee that interference will not occur in a particular installation. If this equipment does cause harmful interference to radio or television reception, which can be determined by turning the equipment off and on, the user is encouraged to try to correct the interference by one or more of the following measures:

- ❖ Reorient or relocate the receiving antenna(s).
- ❖ Increase the separation between the equipment and receiver.
- ❖ Connect the equipment into an outlet on a circuit different from that to which the receiver is connected.
- ❖ Consult the dealer or an experienced radio/TV technician for help.

FCC Conditions

This equipment has been tested and found to comply with Part 15 of the FCC Rules. Operation is subject to the following two conditions:

- (1) This device may not cause harmful interference
- (2) This device must accept any interference received, including interference that may cause undesired operation.

FCC Notice "Equipment Authorization" Information

This device complies with part 15 of the FCC Rules. Operation is subject to the following two conditions: (1) this device may not cause harmful interference, and (2) this device must accept any interference received, including interference that may cause undesired operation.

This device is authorized under Title 47 CFR 15.519 (the FCC Rules and Regulations). The operation of this device is subject to the following restriction: This UWB device shall transmit only when it is sending information to an associated receiver. This UWB device shall cease transmission within 10 seconds unless it receives an acknowledgement from the associated receiver that its transmission is being received. An acknowledgement of reception must continue to be received by the transmitting device at least every 10 seconds of operation or the UWB device must cease transmitting.

▲ WARNING

Changes or modifications made to this equipment not expressly approved by Toshiba or parties authorized by Toshiba could void the user's authority to operate the device under the FCC Equipment Authorization. This includes changes or substitutions of the antennas which are furnished with the device.

NOTE

Consult the dealer or an experienced radio/TV technician for help. Only Peripherals complying with the FCC Class B limits may be attached to this equipment. Operation with noncompliant peripherals or peripherals not recommended by Toshiba is likely to result in interference to radio and TV reception. Shielded cables must be used between the external devices and the docking station's ports.

Contact

Address: TOSHIBA America Information Systems, Inc.
9740 Irvine Boulevard
Irvine, California 92618-1697

Telephone: (949) 583-3000

Copyright statement

This guide is copyrighted by Toshiba Corporation with all rights reserved. Under the copyright laws, this guide cannot be reproduced in any form without the prior written permission of Toshiba. No patent liability is assumed, however, with respect to the use of the information contained herein.

©2009 by Toshiba Corporation. All rights reserved.

Disclaimer

Information in this document is subject to change without notice. The manufacturer does not make any representations or warranties (implied or otherwise) regarding the accuracy and completeness of this document and shall in no event be liable for any loss of profit or any commercial damage, including but not limited to special, incidental, consequential, or other damage.

July 2009, Rev1.0

Trademarks

dynadock is a trademark of Toshiba Corporation.

Adobe and Reader are either registered trademarks or trademarks of Adobe Systems Incorporated in the United States and/or other countries.

AMD, AMD K6, Athlon and Duron are registered trademarks or trademarks of Advanced Micro Devices Incorporated.

Dolby and the double-D symbol are registered trademarks of Dolby Laboratories.

Ethernet is a registered trademark and Fast Ethernet is a trademark of Xerox Corporation.

Intel, Intel Core, Pentium and Celeron are trademarks or registered trademarks of Intel Corporation.

Microsoft, Windows, Windows XP and Windows Vista are either registered trademarks or trademarks of Microsoft Corporation in the United States and/or other countries.

Other brands and product names are trademarks or registered trademarks of their respective companies.

Contents

Safety icons	2
Safety instructions	3
FCC information	5
Introduction.....	12
Overview	13
Features	13
Quick Tour	14
Front view	14
Back view	16
Top view	18
Package contents.....	18
Computer requirements	19
Chapter 1: Setting Up the dynadock™ and Connecting Peripherals.....	20
Setting up the dynadock™	20
Assemble the dynadock™	20
Connect the power adaptor	21
Install the software	21
Connect the dynadock™ to your computer	24

Connecting your peripherals	28
Connecting to a network	28
Connecting a monitor	29
Connecting audio devices	30
Connecting USB devices	31
Chapter 2: Using the dynadock™ and Adjusting Settings.....	33
Undocking your computer	33
Undocking via the undock button	34
Undocking via the utility.....	34
Undocking and placing the computer into Sleep mode	35
Re-connecting and docking your computer	36
Using the dynadock™ software	37
The background utility	37
Using the Wireless USB Manager	37
Using the TOSHIBA dynadock Utility.....	42
Using the USB Multi-Channel Audio Device Utility	45
Using the TOSHIBA Video Dock Utility.....	45
Uninstalling the software	47
Adjusting video settings.....	47
Selecting Extended mode or Mirror mode	47
Supported display modes	49
Adjusting audio settings	50
Configuring audio ports	50
Enhancing sound quality.....	52
Enabling digital S/PDIF output	55
Charging USB devices.....	56
Using standby/sleep/hibernation modes with the dynadock™	57
Securing the dynadock™	58

Chapter 3: Troubleshooting and Support	59
Troubleshooting	59
Power	60
Display/Video	61
Audio/sound	65
Connection/Docking	66
Network	67
USB	68
Other	69
Toshiba Support	69
Before you call	69
Contacting Toshiba	69
Toshiba's technical support Web site	69
Toshiba voice contact	70
Chapter 4: Specifications.....	71
Specifications	71
Index.....	73

Introduction

Thank you for purchasing the dynadock™ wireless U, the universal docking station that enables you to connect your computer peripherals wirelessly or through a single USB cable to just about any Windows®-based computer. The wireless function uses UWB (ultra-wide band) radio technology.

Keep your dynadock™ up-to-date with the latest technological advances: visit pcsupport.toshiba.com periodically to obtain software driver and support updates.

Overview

Features

- ❖ Wireless or single USB cable connection to your computer*
- ❖ Upright slim design saves desktop space
- ❖ Easily accessible USB and audio ports located on the front
- ❖ Supports video resolutions up to 1680 x 1050/1600 x 1200 VESA CVT (Coordinated Video Timing) on an external monitor
- ❖ Hot-swappable: add or remove most devices without rebooting the computer
- ❖ Virtual 7.1 channel digital surround sound
- ❖ Includes TOSHIBA dynadock Utility for customizing dynadock™ settings
- ❖ Charges your USB peripherals with the front powered USB ports even when the connected computer is off
- ❖ Undock button allows you to easily and safely dock/undock your computer from the docking station

*For wireless communication, you will need a computer with Integrated Certified Wireless USB functionality or a Certified Wireless USB adaptor (included with certain models).



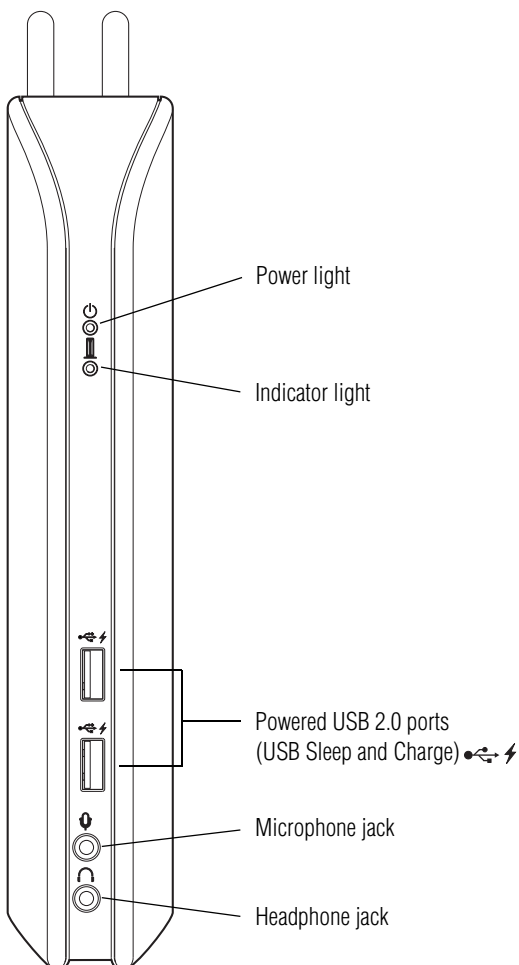

Quick Tour

This section identifies the various components of the dynadock™ wireless U. For a description of each component, please refer to the table beneath each illustration.

Front view









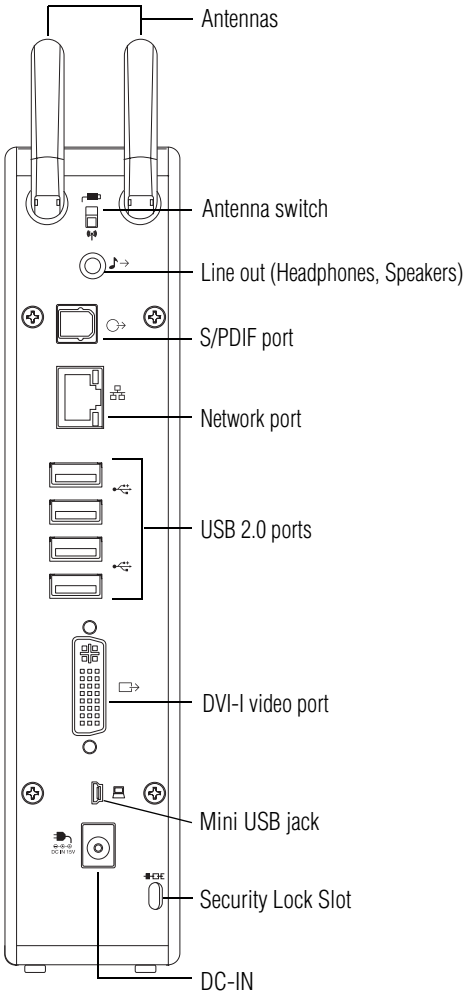



(Sample Illustration) Lights and connectors on the front of the dynadock™

<i>Component</i>		<i>Description</i>
Power light		Glows blue when power is being supplied from the AC adaptor.
Indicator light		Indicates the status of docking, undocking, and charging functions as follows: Flashing green: Docking is in process. Solid green: Computer is docked. Flashing orange: Undocking is in process. Solid orange: Computer is undocked or disconnected and the dynadock™'s USB Sleep and Charge ports are charging any connected, chargeable devices. Off: Computer is undocked or disconnected. dynadock™ USB Sleep and Charge ports are off.
Powered USB 2.0 ports (USB Sleep and Charge ports)		Connection points for USB 2.0 or 1.1 devices. When the dynadock™ is powered on, these ports charge connected battery-powered USB devices (such as PDAs, MP3 players, and cellular phones) even when the dynadock™ is disconnected from your computer or your computer is off. For more information, please see "Charging USB devices" on page 56 . Note 1: Some USB devices may not support this feature. Note 2: Certain USB devices, such as optical disk drives and hard disk drives, have high power requirements. Due to the power output limitations of the USB ports, you may not be able to operate more than one such device at a time. Note 3: If your USB device came with an AC adaptor, be sure to connect the device to a power outlet with the AC adaptor.
Microphone jack		A standard 3.5 mm mini jack for mono audio input from a microphone.
Headphone jack		A standard 3.5 mm mini jack for stereo audio output to headphones/headsets/speakers.

Back view



(Sample Illustration) Connections on the back of the dynadock™

Component		Description
Antennas		Send and receive wireless signals to/from the connected computer.
Antenna switch		Slide the switch down [] to enable wireless communication between your computer and the dynadock™. Slide the switch up [] to connect your computer to the dynadock™ with a USB cable.
Line out (Headphones, Speakers)		A standard 3.5 mm mini jack for stereo audio output to headphones/headsets/speakers.
Optical S/PDIF digital audio output port		Connection point for digital audio equipment (e.g. Dolby® Digital Surround Sound receiver and speaker system). Note: Requires an optical S/PDIF cable (not provided) and an optical S/PDIF input jack on the receiver.
Network port		Connection point for a 10/100 BASE-TX Ethernet cable (not provided).
USB 2.0 ports		Connection points for USB 2.0 and 1.1 devices. Note 1: Certain USB devices, such as optical disk drives and hard disk drives, have high power requirements. Due to the power output limitations of the USB ports, you may not be able to operate more than one such device at a time. Note 2: If your USB device came with an AC adaptor, be sure to connect the device to a power outlet with the AC adaptor.
DVI-I video port		Connection point for a DVI monitor, or a VGA monitor with use of the included DVI-I to VGA adaptor.
Mini USB jack		Connection point for the provided USB cable, used to connect the dynadock™ to your computer. Note: When setting up a wireless connection, you will need to use the USB cable temporarily to form an association between the two devices. For more information, see " Setting up the dynadock™ " on page 20 .
Security lock slot		Attachment point for an optional security cable (not provided) used to deter theft.
DC-IN		Socket for AC adaptor (provided). Note: The dynadock™ requires an external power supply, as it does not draw power from the computer's USB bus.

Top view

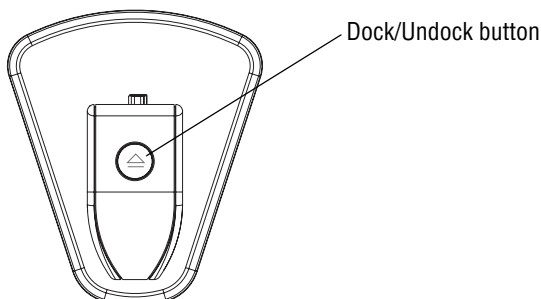

(Sample Illustration) The top of the dynadock™

Component		Description
Dock/Undock button		Stops or resumes communications between the computer and peripherals connected to the dynadock™. For more information, see “Undocking your computer” on page 33 and “Re-connecting and docking your computer” on page 36 . Also, stops the charging of USB devices connected to the front USB powered ports. For more information, see “Charging USB devices” on page 56 .

Package contents

Check to make sure you have all of the following items:

- ❖ dynadock™ wireless U docking station
- ❖ Base
- ❖ USB 2.0 cable
- ❖ AC adaptor and power cord/cable
- ❖ Wireless USB adaptor (included with select models only)
- ❖ DVI-I to VGA adaptor
- ❖ Installation CD (contains *User’s Manual* (this document), drivers and utilities)
- ❖ Quick Start Guide
- ❖ Standard limited warranty booklet

Computer requirements

- ❖ 1.2 GHz or higher processor (Intel® Pentium®/Celeron® family, or AMD K6®/AMD Athlon™/AMD Duron™ family, or compatible processor recommended. Intel® Core™ 2 Duo 2.0 GB or higher processor recommended for optimal video performance.)
- ❖ 512 MB memory or higher (1 GB memory or higher recommended)
- ❖ USB 2.0 port
- ❖ 30 MB of available disk space
- ❖ Certified Wireless USB adaptor or a computer with Integrated Certified Wireless USB functionality*
- ❖ Microsoft® Windows® XP (32-bit edition) with SP2/SP3, or Microsoft® Windows Vista® (32-bit or 64-bit editions) with SP1

NOTE

When Windows® 7 becomes available, Windows® 7-compatible drivers for the dynadock™ wireless U will be available for download from Toshiba's Web site at pcsupport.toshiba.com. Click the Download link, and then search for your product (part number: PA3686U).

*Required for wireless communication between the dynadock™ and your computer.

Chapter 1

Setting Up the dynadock™ and Connecting Peripherals

Setting up the dynadock™

This section provides instructions on setting up the dynadock™. You will need to perform the following steps in the order shown:

- 1 Assemble the dynadock™
- 2 Connect the power adaptor
- 3 Install the software
- 4 Connect the dynadock™ to your computer

You may either:

- a Set up a wireless connection

OR

- b Set up a USB cable connection

For more information on each step, refer to the appropriate section on the indicated page.

Assemble the dynadock™

Slide the dynadock™ onto the base as shown below.

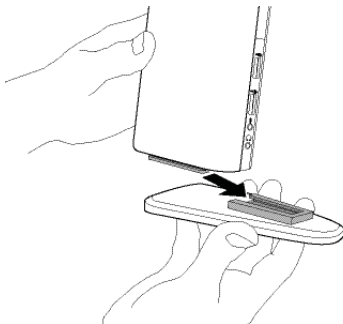

(Sample Illustration) Attaching the base to the dynadock™

Connect the power adaptor

- 1 Plug the AC adaptor cord/cable into the DC-IN on the back of the dynadock™.

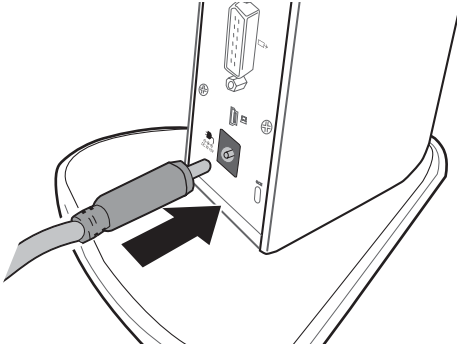

(Sample Illustration) Connecting the AC adaptor cord to the dynadock™

- 2 Connect the power cord/cable to the AC adaptor, and then connect the power plug to a live electrical outlet. The power light on the front panel glows blue when the dynadock™ is powered on.

Install the software

- 1 Insert the provided Installation CD into your optical disc drive. The dynadock Install Menu displays on your computer screen.

NOTE

If the dynadock Install Menu does not display, follow the steps provided below for your operating system:

In Windows® XP: 1) Double-click My Computer on your desktop. 2) Double-click the DVD/CD drive icon, and then double-click AutoRun.exe.

In Windows Vista®: 1) Click Start, Computer. 2) Double-click the DVD/CD drive icon, and then double-click AutoRun.exe.

NOTE

You may need to temporarily disable anti-spyware or anti-virus programs while installing the software. It is also recommended that all other applications are closed, as you will need to restart your computer after the software is installed. You need administrator privileges to install/uninstall the software.

2 Click **Setup**.

(Sample Image) dynadock Install Menu

NOTE

Some dynadock™ components require the installation of Microsoft® .NET Framework v2.0 in order to complete the installation process. If the dynadock™ installation program does not detect .NET Framework v2.0 on your computer, please click the "Install .NET Framework v2.0" button.

3 Click **Install** to install all of the listed programs.**NOTE**

Click Select All if any program in the list is unchecked.

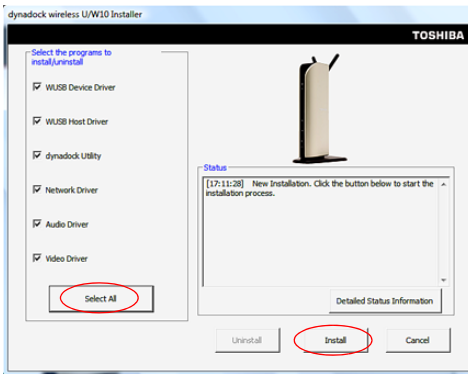

(Sample Image) dynadock Installer

The following programs are installed during the installation process:

<i>Driver Type</i>	<i>Driver Name</i>
Wireless USB device driver	Wireless USB Manager
Wireless USB host driver	
dynadock Utility	dynadock Utility II
Network driver	AX88772A & AX88772
Audio driver	USB Multi-Channel Audio Device
Video driver	TOSHIBA Video Dock Utility (DisplayLink Core software)

- 4 Follow the on-screen instructions to finish the installation.

NOTE

You will need to read and accept the DisplayLink software license agreement when prompted, to proceed with the installation.

- 5 Restart your computer when prompted.

For more information on the dynadock™ software, see [“Using the dynadock™ software” page 37.](#)

Connect the dynadock™ to your computer

You may either:

- ❖ **Set up a wireless connection**

OR

- ❖ **Set up a USB cable connection**

Refer to the appropriate section below for the type of connection you wish to establish.

Set up a wireless connection

NOTE

To set up a wireless connection, you will need either a Certified Wireless USB adaptor (included with certain models) or a computer with integrated Certified Wireless USB functionality.

If you are not using a Toshiba adaptor or if your computer has integrated Certified Wireless USB functionality, please refer to the documentation provided with your adaptor or computer for instructions on setting up a wireless connection, instead of following the steps below.

To set up a wireless connection:

- 1** Flip the dynadock™'s antennas into the upright position.

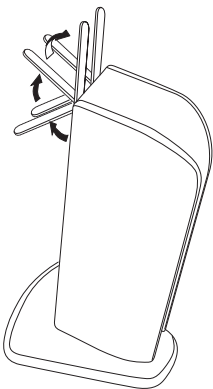

(Sample Illustration) dynadock™'s antennas in the upright position

- 2** Make sure the antenna switch on the back of the dynadock™ is set to the  (down) position.

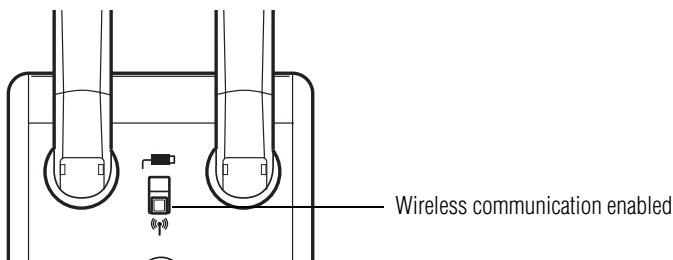

(Sample Illustration) Wireless communication enabled

- 3 Make sure your computer is turned on.
- 4 Connect a Certified Wireless USB adaptor (included with certain models) to your computer and place the adaptor's antenna in an upright position.

NOTE

Restarting may take longer than usual if the computer's operating system is configured to create a system restore point after a new device is installed. This occurs after initial installation only. When the computer restarts, the dynadock™ is ready to use.

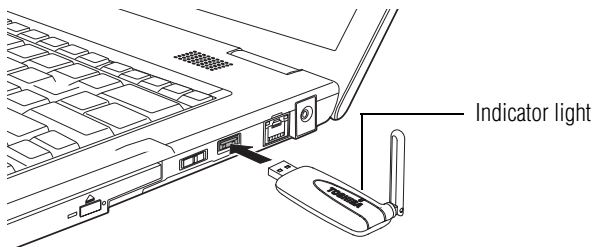

(Sample Illustration) Inserting a wireless USB adaptor

After you connect a wireless USB adaptor, the device is automatically detected and the driver is installed.

When the light on the adaptor glows blue, proceed to step 5.

- 5 Plug one end of the provided USB cable into the Mini USB port on the back of the dynadock™.

NOTE

The USB cable is needed only for initially setting up the wireless connection. The process of initially establishing a connection between the dynadock™ and your computer with the cable is called *association*.

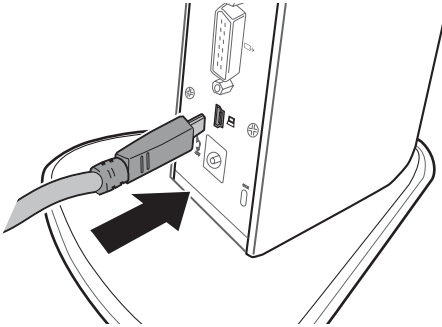

(Sample Illustration) Connecting the USB cable to the Mini USB port

- 6 Plug the other end of the USB cable into an available USB 2.0 port on your computer.

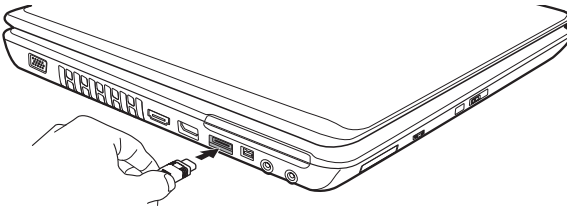

(Sample Illustration) Connecting the USB cable to your computer

The Wireless USB Manager opens automatically on your computer screen.

- 7 Click **Yes allow the device to associate** to start the association.

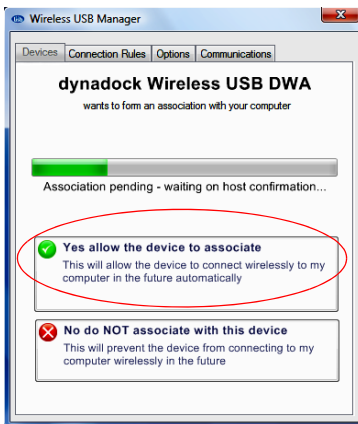

(Sample Image) Association screen

- 8 After successfully completing the association, remove the USB cable connecting the computer to the dynadock™.

After a few moments, a wireless **connection** is established and a message displays on your computer screen asking if you want to **dock** your computer.

NOTE

Connecting opens a line of communication between the computer and the dynadock™, but not between the computer and external devices connected to the dynadock™.

Docking enables the computer to communicate with devices connected to the dynadock™. The computer can only be docked with one dynadock™ at a time.

NOTE

For optimal performance, the dynadock™ must be within close range of the adaptor, with no obstructions between the devices.

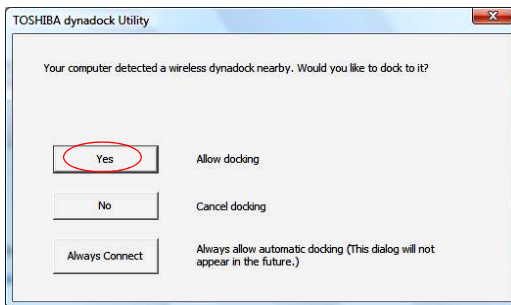

(Sample Image) Click Yes to dock wirelessly to your computer

- 9 Click **Yes** to dock your computer.
- 10 The dynadock™ drivers automatically install. Restart your computer when prompted.

NOTE

Restarting may take longer than usual if the computer's operating system is configured to create a system restore point after a new device is installed. This occurs after initial installation only. When the computer restarts, the dynadock™ is ready to use.

Set up a USB cable connection

- 1 Move the switch on the back of the dynadock™ to the USB [🔌] position.
- 2 Connect the provided USB cable to the Mini USB port on the back of the dynadock™.
- 3 Connect the other end of the USB cable to an available USB port on your computer.
Windows® automatically detects the device and installs the device drivers.
- 4 Restart your computer when prompted.

NOTE

Restarting may take longer than usual if the computer's operating system is configured to create a system restore point after a new device is installed. This occurs after initial installation only. When the computer restarts, the dynadock™ is ready to use.

Connecting your peripherals

Once you have set up a wireless or USB cable connection between your computer and the dynadock™, you can connect your computer peripherals to the appropriate ports on the dynadock™.

Please refer to the “[Quick Tour](#)” [page 14](#) for information on the dynadock's ports, and refer to the sections below for information on connecting specific types of devices.

Connecting to a network

Connect one end of a network cable (not provided) to the Network port (RJ-45) on the dynadock™ and the other end to your network.

If the network is not automatically connected, configure the network properties of the Ethernet adaptor as follows:

- 1 In Windows® XP, select **Start, Connect to**, and then **Show all Connections**.

In Windows Vista®, select **Start, Control Panel, View network status and tasks**, and then **Manage network connections**.

- 2 In the Network Connections folder, double-click the **Connection** icon for the dynadock's Ethernet adaptor, which is indicated by ASIX AX88772A USB2.0 to Fast Ethernet Adaptor. This will open the Local Area Connection Properties window for you to configure the network settings as required according to your network environment. If you are unsure about the settings, consult your network administrator for assistance.

NOTE

The dynadock's Network port does not support Wake-up-on-LAN. The Local Area Connection icon in the System tray/Notification Area of your Windows® desktop will not show a connection. Open "Network Connections" to view the Ethernet Connection.

Connecting a monitor

You can connect a digital (DVI) or analog (VGA) monitor to the dynadock™. Only one monitor can be connected to the dynadock™ at a time.

To connect a monitor to the dynadock™:

- 1 If you are connecting a VGA monitor, attach the DVI-I to VGA adaptor (included with the dynadock™) to the DVI-I video port on the dynadock™.
- 2 Connect the monitor cable (not provided) to the DVI-I video port on the dynadock™ or to the adaptor you connected in step 1.
- 3 Connect the other end of the cable to the external monitor.

NOTE

The monitor cable can be connected/disconnected at any time without disconnecting the dynadock™ from your computer.

By default, the external monitor is set to Extended mode. To switch to Mirror mode, see [“Adjusting video settings” page 47](#).

NOTE

If no output is seen on the monitor connected to the dynadock™, the current video resolution setting may not be supported by the monitor. This can happen if the monitor does not report its supported modes to the dynadock's DVI component. Adjust the resolution of the external monitor until an image is shown. For more information, see [“Using the TOSHIBA Video Dock Utility” page 45](#).

You can customize the video settings of the dynadock™. See “Adjusting video settings” page 47 for more information.

Connecting audio devices

The dynadock™ provides four audio ports, as shown in the following illustrations.

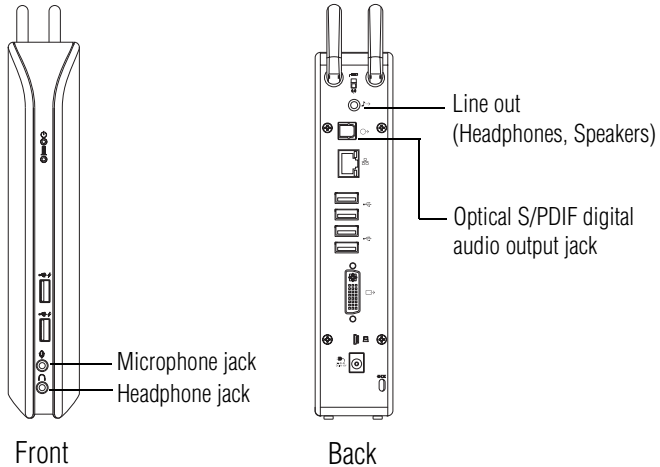

(Sample Illustration) dynadock™ wireless U audio ports

The following table indicates which port to use for each type of audio activity.

Activity	Audio Device	Use this port:
Audio recording	Microphone	Microphone jack
Audio playback	Headphones/headsets/speakers	Headphone jack or Line out
	Digital audio equipment (Egs: Dolby® Digital Surround Sound receiver and speaker system with optical S/PDIF input port)	S/PDIF jack

When your computer is docked, the audio ports on the computer are automatically disabled and the audio ports on the dynadock™ are automatically enabled. In most cases, simply connect your audio device to the appropriate port on the dynadock™ and the port is ready to use. To do any one of the following, please see the referenced section:

- ❖ To use the computer's audio ports (instead of the dynadock's audio ports) when the computer is docked, please see [“Configuring audio ports” page 50](#).
- ❖ To enable virtual 7.1-channel sound on your connected audio device, please see [“Enhancing sound quality” page 52](#). This will provide better sound quality over standard stereo output.
- ❖ To use the dynadock's S/PDIF jack, please see [“Enabling digital S/PDIF output” page 55](#).

NOTE

If you switch between the computer's audio ports and the dynadock's audio ports, you may have to restart your media player if it is running.

Connecting USB devices

The dynadock™ provides six USB 2.0 ports: four on the back and two on the front. To locate the USB ports on the dynadock™, please see the [“Quick Tour” page 14](#).

This section provides basic instructions for connecting most USB devices to the dynadock™. Please check the documentation that came with your USB device for any special instructions.

NOTE

You do not need to turn off the dynadock™ or the docked computer before connecting a USB device.

To connect a USB device to the dynadock™:

- 1** If your device came with its own AC adaptor, connect the AC adaptor to the device and to a live electrical outlet.
- 2** Use a USB cable to connect the device to one of the USB ports on the dynadock™.

NOTE

If you want to charge your USB device when the computer connected to the dynadock™ is off or when there is no computer connected to the dynadock™, be sure to connect your device to one of the powered USB ports on the front of the dynadock™. The indicator light glows orange when charging is taking place.

- 3** Wait for Windows® to recognize the device and install the drivers. A message should display on your computer screen indicating when installation is complete and the device is ready to use.

Chapter 2

Using the dynadock™ and Adjusting Settings

Undocking your computer

CAUTION

To avoid losing data and/or damaging your computer and/or peripherals, be sure to undock your computer from the dynadock™ as described in this section before you do any one of the following:

- ❖ Disconnect the USB wireless adaptor from your computer.
 - ❖ Disconnect the USB cable connecting your computer to the dynadock™ (if you are not using a wireless connection).
 - ❖ Move the computer outside of the operational range (approximately 10 meters/32 feet) of the wireless connection.
-

"Undocking" your computer stops all communications with the external devices connected to the dynadock™. After you undock your computer, it is safe to break the wireless or cable connection between the computer and the dynadock™.

To undock your computer, either:

- ❖ Use the button on the top of the dynadock™, or
 - ❖ Use the TOSHIBA dynadock Utility.
-

NOTE

If you are using a wireless USB adaptor, you can leave the adaptor connected to the computer after undocking. However, be careful not to damage the adaptor (for example, while moving the computer).

Undocking via the undock button

- 1 Press the Undock button on the top of the dynadock™ once.

The indicator light on the front of the dynadock™ flashes orange, and the following message appears on your computer screen.

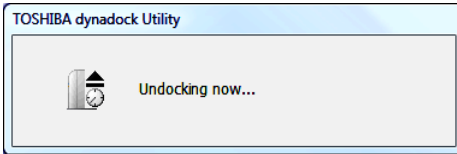

(Sample Image) Undocking in progress

- 2 When the indicator light stops flashing or turns off, it is safe to move the computer out of range of the dynadock™ antennas or to disconnect the USB cable if you are using one.

Undocking via the utility

Follow the steps below to undock your computer through the TOSHIBA dynadock Utility:

- 1 Right-click the **TOSHIBA dynadock Utility** icon in the System tray/Notification Area of your Windows® desktop.



(Sample Image) TOSHIBA dynadock Utility icon

NOTE

If the icon is not visible in your System tray/Notification Area, make sure the dynadock™ is connected and docked, and then click the Show Hidden Icons button [], if necessary, to display hidden icons.

- 2 Select **Eject Dock** from the menu.



(Sample Image) The Eject Dock command

The indicator light on the front of the dynadock™ flashes orange, and the following message appears on your computer screen.

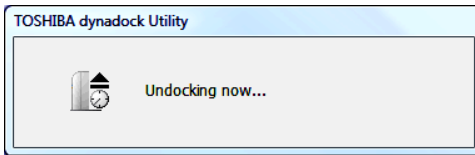

(Sample Image) Undocking in progress

- 3 When the indicator light stops flashing or turns off, it is safe to move the computer out of range of the dynadock™ antennas or to disconnect the USB cable if you are using one.

NOTE

If you are using a wireless USB adaptor, you can leave the adaptor connected to the computer after undocking. However, be careful not to damage the adaptor (for example, while moving the computer).

Undocking and placing the computer into Sleep mode

Use the Eject and Sleep option of the TOSHIBA dynadock Utility to quickly stop all communications with external devices and place the computer into Sleep mode.

- 1 Right-click the **TOSHIBA dynadock Utility** icon in the System tray/Notification Area of your Windows® desktop.



(Sample Image) TOSHIBA dynadock Utility icon

NOTE

If the icon is not visible in your System tray/Notification Area, make sure the dynadock™ is connected and docked, and then click the Show Hidden Icons button [<], if necessary, to display hidden icons.

- 2 Select **Eject and Sleep** from the **TOSHIBA dynadock Utility** menu.



(Sample Image) The Eject and Sleep command

- 3 Wait before disconnecting the dynadock™ from the computer.

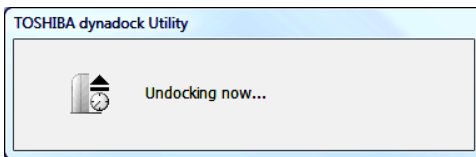

(Sample Image) Undocking in progress

When the computer is undocked, the dynadock Utility icon no longer appears in the System tray/Notification Area.

- 4 After the computer is undocked, the computer enters Sleep mode.

Re-connecting and docking your computer

To re-connect and dock your computer to the dynadock™ (upon returning to your desk with your computer after a meeting, for example), do the following:

- ❖ If you are using a wireless USB adaptor, make sure the adaptor is properly connected or re-connect the adaptor.
- ❖ Make sure the computer is within wireless communication range of the dynadock™.
- ❖ Remove any obstructions between the computer and the dynadock™.
- ❖ If the computer is in standby/sleep/hibernation mode, press the computer's power button to resume.
- ❖ Press the **Dock** button on the top of the dynadock™ to dock.
The indicator light on the front of the dynadock™ flashes green to indicate docking is in progress. The light turns solid green when docking is completed.

Using the dynadock™ software

This section provides information on using the following software to manage the dynadock™ and adjust settings to suit your needs:

- ❖ The background utility
- ❖ Wireless USB Manager
- ❖ TOSHIBA dynadock Utility
- ❖ USB Multi-Channel Audio Device utility
- ❖ TOSHIBA Video Dock utility

You can also refer to this section to learn how to uninstall the software.

The background utility

After the TOSHIBA dynadock Utility is installed and the computer is restarted, a program named TOSDockApp.exe will run automatically in the background. This program will be listed in the Windows® Task Manager. This program detects the connection and removal of the dynadock™ from the computer.

The background utility does not impact any other programs running on your computer. Do not turn off the utility as it is required for proper operation of the dynadock™.

Using the Wireless USB Manager

The Wireless USB Manager is the driver software for the Toshiba Certified Wireless USB adaptor (included with certain models). This driver is automatically installed when you run the dynadock Installation CD (see “[Install the software](#)” on page 21 for more information).

The Toshiba Certified Wireless USB adaptor contains a radio transmitter/receiver that enables your computer to communicate wirelessly with the dynadock™. This radio is known as the host radio. The Wireless USB Manager driver software enables you to manage the host radio and perform tasks such as the following:

- ❖ Associate the dynadock™ with your computer
- ❖ Connect/Disconnect the dynadock™ from your computer
- ❖ Change/Select the channel used for radio communication
- ❖ Disable/Enable radio communications
- ❖ Disable/Enable pop-up messages

NOTE

If you are using a non-Toshiba Certified Wireless USB adaptor or a Certified Wireless USB radio built into your computer to communicate with the dynadock™, you may need to use the driver provided with your wireless USB host module instead of the driver provided with the dynadock™ to accomplish these tasks.

Accessing the Wireless USB Manager

To start the Wireless USB Manager:

- ❖ Double-click the **Wireless USB Manager** icon in the System tray/Notification Area of your Windows® desktop.



(Sample Image) The Wireless USB Manager icon

NOTE

The Wireless USB Manager icon appears in your System tray/Notification Area only when the wireless USB adaptor is connected to your computer. You may need to click the Show Hidden Icons button [, to display hidden icons. If the adaptor is not connected to your computer, you can access the Wireless USB Manager by double-clicking the Wireless USB Manager icon on your Windows® desktop.

The Wireless USB Manager displays.

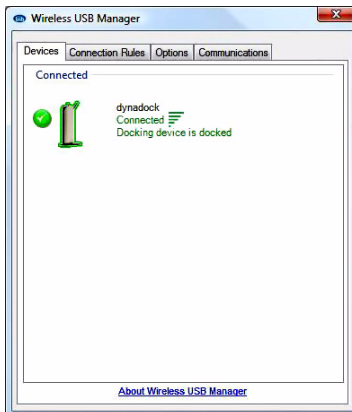

(Sample Image) The Wireless USB Manager

The dynadock™ appears on the **Devices** tab of the **Wireless USB Manager**.

Changing the Connection Rules

The **Connection Rules** tab of the **Wireless USB Manager** allows you to change the default association behavior of the host radio. The following options are provided:

- ❖ **Require my permission** (default): Each time you connect a compatible wireless USB device to your computer with a USB cable, the Wireless USB Manager will prompt you to allow or reject an association.
- ❖ **Always allow associations**: An association will automatically be established between any compatible wireless USB device and your computer when you connect the device to your computer with a USB cable.
- ❖ **Never allow associations**: All association requests from compatible wireless USB devices connected to your computer with a USB cable will be rejected by the host radio.

Connecting/disconnecting the dynadock™ from your computer

Your computer can only be docked with one dynadock™ at a time. If you have more than one dynadock™ within range of your computer, you may want to temporarily prevent your computer from connecting wirelessly to a particular dynadock™. To temporarily prevent your computer from connecting wirelessly to a dynadock™:

- ❖ On the **Devices** tab of the **Wireless USB Manager**, click the green button next to the **dynadock** icon. The button turns gray to indicate the dynadock™ is in a non-connectable state. Click the button again to allow connection.

NOTE

You can change the name of the each dynadock™ listed on the Devices tab of the Wireless USB Manager. This is especially useful if you have multiple dynadocks, to differentiate between them. To rename a dynadock™, right-click on the default name, select **Rename** from the shortcut menu, and then enter a custom name.

To permanently remove the association between the dynadock™ and the host radio:

- ❖ On the **Devices** tab of the **Wireless USB Manager**, right-click on the **dynadock** icon and select **Remove** from the menu.

NOTE

If you permanently remove the device, you will not be able to connect to that particular device again until the device has been re-associated. To re-associate the device, follow the instructions in the section “[Set up a wireless connection](#)” on page 24.

Disable/Enable pop-up messages

The **Options** tab of the **Wireless USB Manager** enables you to disable or enable pop-up messages that appear in the System tray/Notification Area of your Windows® desktop. For example, a pop-up message informs you when an associated wireless USB device, such as the dynadock™, has been connected or disconnected from your computer. These messages are enabled by default.

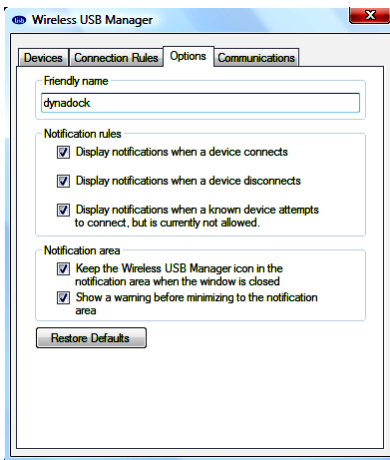

(Sample Image) The Options tab

Change/Select the channel used for radio communication

The **Communications** tab of the **Wireless USB Manager** enables you to view and change radio settings. The default channel setting is **Automatic**, which enables the host radio to automatically locate an available channel for communications.

NOTE

It is recommended to leave this setting on Automatic. If you manually select a channel that is being used by another dynadock™ in the vicinity, the channel bandwidth will be shared by both devices. To maximize performance, a separate channel should be used for each dynadock™.

If you wish to manually select the channel to be used for communications between the dynadock™ and your computer, you can do so by clicking the **Requested Channel** drop-down menu and then selecting any channel from the list.

Disable/Enable radio communications

If you take your computer and wireless USB adapter on board an airplane, FCC regulations require that you disable the host radio in your wireless USB adaptor to prevent it from transmitting during the flight.

To temporarily disable the host radio, do one of the following:

- ❖ Click the **Off** button on the **Communications** tab of the **Wireless USB Manager** (in the **Communication status** area of the window).
- ❖ Right-click the **Wireless USB Manager** icon in your Windows® System tray/Notification Area and select **Disable communications** from the menu. The icon turns from blue to yellow to indicate the change in status.
- ❖ Undock the dynadock™ by pressing the Undock button, and then unplug the Certified Wireless USB adaptor from your computer.

To re-enable communications, reverse the procedure.

Uninstalling the Wireless USB Manager and Host/Device Drivers

To uninstall the Wireless USB Manager and the Wireless USB Host and Device Drivers, do the following:

- ❖ **To uninstall the Wireless USB Manager and Host Driver:** Click **Start, Programs, Toshiba, Wireless USB**, and then **Uninstall**. Follow the onscreen instructions to complete the uninstall.
- ❖ **To uninstall the Wireless USB Device Driver:** Click **Start, Programs, Toshiba, Wireless USB**, and then **Uninstall DWA Driver**. Follow the onscreen instructions to complete the install.

To remove all dynadock™ software from your computer, please see “Uninstalling the software” on page 47.

Using the TOSHIBA dynadock Utility

The TOSHIBA dynadock Utility provides options for changing default settings, undocking, configuring audio ports, and more.

Accessing the TOSHIBA dynadock Utility

Click the **TOSHIBA dynadock Utility** icon for quick access to the options listed in the table below.



(Sample Image) TOSHIBA dynadock Utility icon

<i>Option</i>	<i>Use this option to:</i>
Eject Dock	Undock your computer from the dynadock™. For more information, see “Undocking your computer” on page 33 .
Eject and Sleep	Undock and place your computer into Sleep mode.
Select Sound Device...	Configure your audio ports. For more information, see “Adjusting audio settings” on page 50 .
Update Support	Connect to Toshiba support Web sites to obtain updated drivers, find answers to frequently asked questions, and more.
Settings	Turn Eject & Sleep mode and Charge mode on or off; Turn notification messages on or off. For more information, see “Undocking and placing the computer into Sleep mode” on page 35 , “Charging USB devices” on page 56 , and “Selecting message options” on page 44 .
User's Manual	View the dynadock™ wireless U User's Manual (this document) on your computer screen.
About	Find the version number for the TOSHIBA dynadock Utility software.

NOTE

If the TOSHIBA dynadock Utility icon is not visible in your System tray/Notification Area, make sure the dynadock™ is connected and docked, and then click the Show Hidden Icons button [<], if necessary, to display hidden icons.

You can also access the Settings options of the TOSHIBA dynadock Utility through the Windows® Control Panel. Click Start, Control Panel to open the Control Panel, and then double-click the TOSHIBA dynadock Utility icon. If the icon is not shown, click Classic view on the left side of the Control Panel window.

Setting Sleep mode options

Sleep mode enables you to place the computer into Sleep, Standby, or Hibernation mode after undocking. When the Sleep mode setting in the TOSHIBA dynadock Utility is enabled, you can do this by selecting **Eject and Sleep** from the **TOSHIBA dynadock Utility** menu. Sleep mode is enabled by default.

To set Sleep mode options:

- 1 Click the **TOSHIBA dynadock Utility** icon in your Windows® System tray/Notification Area.



(Sample Image) TOSHIBA dynadock Utility icon

- 2 Click **Settings**.
- 3 Select the **Eject Dock** and **Sleep PC Service** checkbox to enable Sleep mode, or de-select the checkbox to disable it.
- 4 If you are enabling Sleep mode, select **Standby** or **Hibernation** from the **Sleep Mode** drop-down list to specify the Sleep mode you want.

NOTE

For information on Standby and Hibernation modes, see the documentation that came with your computer.

- 5 Click **OK**.

Enabling/disabling Charge mode

When the dynadock™ is disconnected from your computer or the computer's power is turned off, the front USB ports will charge certain connected USB devices if Charge mode is enabled. Charge mode is enabled by default.

NOTE Some USB devices may not support this feature.

To enable or disable Charge mode:

- 1 Click the **TOSHIBA dynadock Utility** icon in your Windows® System tray/Notification Area.



(Sample Image) TOSHIBA dynadock Utility icon

- 2 Click **Settings**.
- 3 Select the **Set charge mode after undock** checkbox to enable Charge mode, or de-select the checkbox to disable it.
- 4 Click **OK**.

For more information, see “[Adjusting audio settings](#)” on page 50 for more information.

Selecting message options

A warning message displays on your computer screen if you disconnect your computer from the dynadock™ without first undocking it. To avoid data loss or equipment damage, it is important to undock to stop all communications with connected peripherals before you disconnect your computer from the dynadock™. TOSHIBA recommends that you do not turn off this warning message.

A message will also display to notify you when undocking is complete and it is safe to disconnect your computer from the dynadock™.

To turn messages on or off:

- 1 Click the **TOSHIBA dynadock Utility** icon in your Windows® System tray/Notification Area.



(Sample Image) TOSHIBA dynadock Utility icon

- 2 Click **Settings**.
- 3 Select the checkboxes next to **Show undocking complete** message and **Show unexpected remove** message to turn these messages on, or de-select the checkboxes to turn them off.
- 4 Click **OK**.

Using the USB Multi-Channel Audio Device Utility

Use the USB Multi-Channel Audio Device utility to adjust the settings for audio playback and recording devices connected to the dynadock™. With this utility, you can enable virtual 7.1-channel surround sound and digital S/PDIF output, and otherwise optimize your audio effects.

To access this utility, click the **USB Multi-Channel Audio Device** icon in the System tray/Notification Area of your Windows® desktop.



(Sample Image) USB Multi-Channel Audio Device Utility icon

NOTE

If the icon is not visible in your System tray/Notification Area, make sure the dynadock™ is connected and docked, and then click the Show Hidden Icons button [<], if necessary, to display hidden icons.

For more information on using this utility, see [“Enhancing sound quality” on page 52](#) and [“Enabling digital S/PDIF output” on page 55](#).

Using the TOSHIBA Video Dock Utility

Use the TOSHIBA Video Dock Utility to adjust the settings for the monitor connected to the dynadock™. With this utility, you can select Mirror mode or Extended mode, and select screen resolution, color quality, and refresh rates.

To access the Video Dock Utility:

- 1 Right-click the **TOSHIBA Video Dock** icon in the System tray/Notification Area of your Windows® desktop.



(Sample Image) TOSHIBA Video Dock icon

NOTE

If the icon is not visible in your System tray/Notification Area, make sure the dynadock™ is connected and docked, and then click the Show Hidden Icons button [], if necessary, to display hidden icons.

- 2 Select one of the following options from the menu:

Option	Use this option to:
Screen Resolution	Change the resolution setting of the external monitor connected to the dynadock™. For more information, see “Supported display modes” on page 49.
Color Quality	Select 16-bit or 32-bit color depth for the external display connected to the dynadock™.
Screen Rotation	Rotate the image on the external monitor connected to the dynadock™.
Extend To	Specify the extension direction if you are using multiple monitors and Extended mode. This setting should match the physical orientation of the connected monitors relative to each other. For example, if the external monitor is physically positioned to the right of your computer’s display, select “Extend to Right”.
Extend	Extend your desktop space across multiple monitors, so that you can display different information on each monitor connected to your computer.
Mirror	Duplicate the image showing on your computer’s screen on the external monitor connected to the dynadock™.
Off	Turn off the external display. Devices connected to the dynadock will still function.
Advanced...	Access the Windows® Display Properties dialog box.

For more information on using this utility, see [“Adjusting video settings” on page 47.](#)

CAUTION

Be sure to select only supported resolution, color quality, and refresh rate settings. Placing a monitor into an unsupported mode for long periods can damage it.

If you use multiple dynadocks with a single computer (for example, one at work and one at home), the video settings for each dynadock™ are saved when you disconnect the computer. This will enable you to have each dynadock™ adjusted to different video

settings for each location. The settings will be retained each time you use the dynadock™ with your computer.

Uninstalling the software

To remove the dynadock™ software from your computer, please follow the steps below.

NOTE

Before uninstalling the software, do the following:

- ❖ Undock the computer from the docking station. See [“Undocking your computer” on page 33](#) for more information.
- ❖ Disconnect the dynadock™ from the computer by removing the USB cable or the wireless USB adaptor.
- ❖ Close all programs running on your computer.

-
- 1 Click **Start, Programs** or **All programs, dynadock**, and then **Uninstall dynadock**.
 - 2 Follow the on-screen directions to finish the uninstall.

Adjusting video settings

For a basic overview of the video setting options, please see [“Using the TOSHIBA Video Dock Utility” on page 45](#). For more detailed information on adjusting the video settings for a monitor connected to the dynadock™, read this section.

NOTE

For instructions on connecting a monitor to the dynadock™, see [“Connecting a monitor” on page 29](#).

Selecting Extended mode or Mirror mode

You can choose to set the dynadock’s video output signal to **Extended mode** or **Mirror mode**. The default setting is Extended mode.

Extended mode extends your desktop space across multiple monitors, so that you can display different information on each monitor connected to your computer. This provides a number of advantages to increase productivity, including the ability to:

- ❖ View large spreadsheets across two screens
- ❖ Multitask more effectively without overlapping windows
- ❖ Compare two documents simultaneously across two screens
- ❖ View videos/TV on one screen and reviews on the other

Mirror mode duplicates the image on your computer screen on the external monitor(s) connected to the dynadock™. This mode is useful if, for example, you want to view information on a larger, external desktop monitor instead of a smaller, built-in computer screen. In Mirror mode, the dynadock™ automatically adjusts the external monitor's resolution, color quality, and refresh rate settings to provide the best overall image quality based on your computer's settings.

To configure the dynadock's video output signal to Mirror mode or Extended mode, connect an external monitor to the dynadock™ as described in the section "Connecting a monitor" on page 29, and then follow the steps below:

- 1 Right-click the **TOSHIBA Video Dock** icon in the System tray/Notification Area of your Windows® desktop.



(Sample Image) TOSHIBA Video Dock icon

NOTE If the icon is not visible in your System tray/Notification Area, make sure the dynadock™ is connected and docked, and then click the Show Hidden Icons button [], if necessary, to display hidden icons.

- 2 Select **Extend** or **Mirror** from the menu.

NOTE If you notice certain windows or other parts of your display are missing when you disconnect your computer from the dynadock™, you may need to de-select the Extend my Windows® desktop onto this monitor checkbox in your Windows® Display Properties dialog box to return the entire image to your primary screen.

NOTE You can also use the Windows® Display Properties screen to switch between Extended mode and Mirror mode.

NOTE The external monitor connected to the dynadock™ may be identified as either "2" or "3" on the Windows® Display Properties screen (depending on your computer model), even though there may not be three viewable displays.

Supported display modes

Three components make up the display mode: resolution, color depth, and refresh rate. These components are defined as follows.

- ❖ **Resolution:** In common usage, the resolution is the number of pixels displayed on the screen horizontally and vertically.
- ❖ **Color Depth:** The number of different colors that can be shown on the screen at the same time.
- ❖ **Refresh rate:** The speed at which the entire screen is rescanned. Higher frequencies reduce flicker.

The dynadock™ supports the following display modes:

<i>Resolution</i>	<i>Refresh Rates (Hz)</i>	<i>Color Depth</i>
640 x 480	60, 67, 72, 75, 85	
720 x 400	70, 85, 88	
720 x 480	50, 60	
768 x 576	50, 60	
800 x 480	60	
800 x 600	56, 60, 72, 75, 85	
832 x 624	75	
848 x 480	60	
1024 x 600	60	
1024 x 768	60, 70, 75, 85	
1152 x 864	75	
1152 x 870	75	
1280 x 720	50, 60	
1280 x 768	60, 75, 85	
1280 x 960	60, 85	
1280 x 1024	60, 75, 85*	
1280 x 800	60	
1360 x 768	60	
1366 x 768	50, 60	
1368 x 768	60	
1400 x 1050	60, 75, 85	
1440 x 900	60	
1600 x 1200	60	
1680 x 1050	60	

All modes available in both 16-bit and 32-bit color except modes marked with an asterisk(*)

*Available in 16-bit color mode only.

Please note the following:

- ❖ Interlaced modes are not supported.
- ❖ The display modes listed above may not be supported by your monitor, or your monitor may offer additional modes not supported by the dynadock™. For information on display modes supported by your monitor, be sure to check the documentation supplied with your monitor. Select a mode that both the dynadock™ and the monitor support.
- ❖ Placing a monitor into an unsupported mode for long periods can damage it.
- ❖ If you are using Mirror mode to clone the primary display's image on an external monitor, the dynadock™ will attempt to use the same display mode on the external monitor that you selected for the primary display. In some cases, however, this may not be the most appropriate mode for the mirrored desktop (for example, if the aspect ratio of the displays is not the same). In these cases, change the primary display mode to match the optimum display mode for the external monitor.

Adjusting audio settings

Configuring audio ports

You can playback or record audio either through the dynadock's audio ports or the docked computer's audio ports. However, you cannot use the audio ports on the docked computer and on the dynadock™ at the same time.

By default, the audio ports on the dynadock™ are automatically enabled each time you dock the computer. When you undock the computer, the audio ports on the computer are automatically re-enabled.

To change the default settings, you may need to manually adjust the audio settings in Windows®, as described in this section. For example, if you want to use the computer's audio ports while the computer is docked, you will need to change the default settings.

Configuring audio playback ports

- 1 Click the **TOSHIBA dynadock Utility** icon in the System tray/Notification Area of your Windows® desktop.



(Sample Image) TOSHIBA dynadock Utility icon

NOTE If the icon is not visible in your System tray/Notification Area, make sure the dynadock™ is connected and docked, and then click the Show Hidden Icons button [<], if necessary, to display hidden icons.

- 2 Select **Select Sound Device...** from the menu.
 - 3 On the **Playback** tab of the dialog box, select one of the following:
 - ❖ To use the dynadock's Headphone/Speakers/Line out jack, select **USB Multi-Channel Audio Device**.
 - ❖ To use the docked computer's Headphone/Speakers/Line out jack, select a different playback device (other than USB Multi-Channel Audio Device).
 - 4 Click **Set Default**.
 - 5 Click **OK**.
 - 6 Connect your audio playback device to the jack you enabled in step 3.
-

NOTE You may need to restart your media player for the audio changes to take effect.

Configuring audio recording ports (Microphone)

- 1 Click the **TOSHIBA dynadock Utility** icon in the System tray/Notification Area of your Windows® desktop.



(Sample Image) TOSHIBA dynadock Utility icon

NOTE If the icon is not visible in your System tray/Notification Area, make sure the dynadock™ is connected and docked, and then click the Show Hidden Icons button [<], if necessary, to display hidden icons.

- 2 Select **Select Sound Device...** from the menu.
- 3 On the **Recording** tab of the dialog box, select one of the following:
 - ❖ To use the dynadock's Microphone jack, select **USB Multi-Channel Audio Device**.

-
- ❖ To use the docked computer's Microphone jack, select a different recording device (other than USB Multi-Channel Audio Device).
- 4 Click **Set Default**.
 - 5 Click **OK**.
 - 6 Connect your microphone to the jack you enabled in step 3.

Enhancing sound quality

With the included software, you can experience 7.1-channel virtual surround sound through two-channel speakers or headphones connected to the dynadock™.

To enable virtual 7.1-channel sound:

- 1 Connect your two-channel speakers or headphones to the dynadock™.
- 2 Click the **USB Multi-Channel Audio Device** icon in the System tray/Notification Area of your Windows® desktop.



(Sample Image) USB Multi-Channel Audio Device Utility icon

NOTE

If the icon is not visible in your System tray/Notification Area, make sure the dynadock™ is connected and docked, and then click the Show Hidden Icons button [], if necessary, to display hidden icons.

The USB Multi-Channel Audio Device Utility opens.

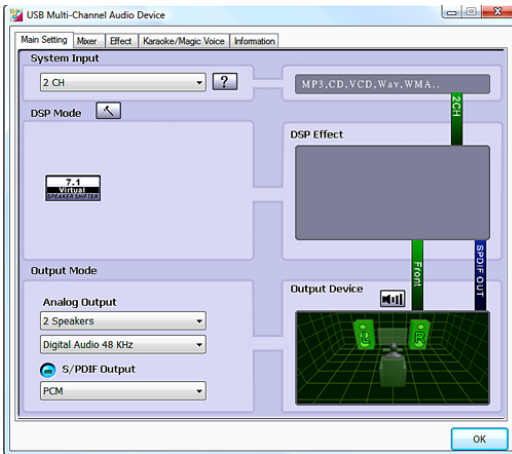

(Sample Image) The USB Multi-Channel Audio Device Utility

- 3 In the **Analog Output** section of the dialog box, select one of the following:
 - ❖ **Headphone** or [🎧], if you connected headphones in step 1.
 - ❖ **2 Speakers**, if you connected speakers in step 1.
- 4 In the DSP Mode section of the dialog box, click the **7.1 Virtual Speaker Shifter** button.

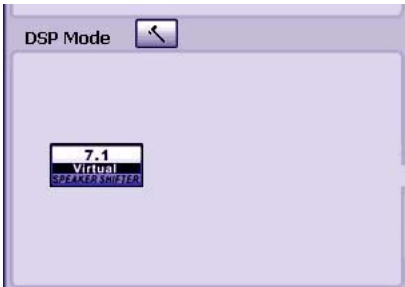

(Sample Image) The 7.1 Virtual Speaker Shifter button

- 5 Click the **Advanced Settings** button next to **DSP Mode**.



(Sample Image) The Advanced Settings button

The Speaker Shifter controls display.



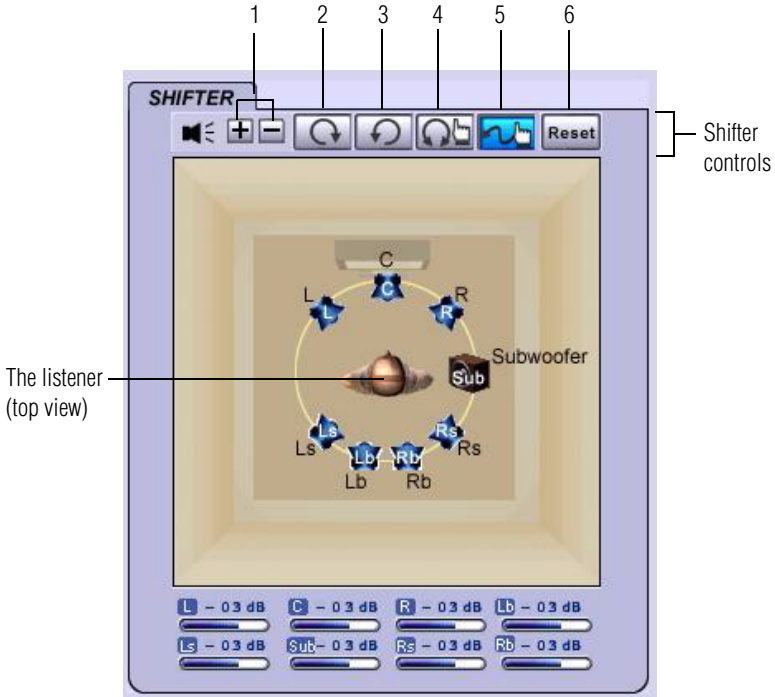

- Use the Shifter controls to adjust your virtual speaker settings, as indicated in the table below.



(Sample Image) Shifter Controls

NOTE

The dialog box shows the location of the virtual speakers relative to the listener, depicted in the center.

	<i>Control(s)</i>	<i>Click to:</i>
1	+/-	Increase/decrease the volume of all virtual speakers
2		Rotate all virtual speakers clockwise
3		Rotate all virtual speakers counterclockwise
4		Manually rotate all virtual speakers
5		Manually change the location of a specific speaker. Click the button and then click and drag the speaker to the desired location. This control enables you to enhance an individual channel. For example, a low-volume center (for dialog) can be enhanced by dragging it closer to the listener.
6	Reset	Return to the default settings

- 7 Click the **Advanced Settings** button next to **DSP Mode** to close the Shifter controls and return to the basic controls screen.
- 8 Adjust other settings, if desired, to suit your sound preferences.
- 9 Click **OK** to close the dialog box.

You can now listen to virtual 7.1-channel sound through your two-channel headphones or speakers.

Enabling digital S/PDIF output

Using the S/PDIF Output feature in the included software you can directly output the digital sound source from your computer to your home theater equipment without loss of sound quality.

To experience true digital sound quality, your digital audio content and your external decoder/AV receiver connected to the dynadock™ must both support Dolby® Digital or DTS decoding. You will also need to enable the S/PDIF output function in the USB Multi-Channel Audio Device utility, as described below.

To enable digital S/PDIF output:

- 1 Connect your external decoder/AV receiver/speakers to the dynadock's S/PDIF jack. You will need a Toslink optical digital audio cable (purchased separately), to connect the dynadock™ to your audio equipment.

- 2 Click the **USB Multi-Channel Audio Device** icon in the System tray/Notification Area of your Windows® desktop.



(Sample Image) USB Multi-Channel Audio Device Utility icon

NOTE If the icon is not visible in your System tray/Notification Area, make sure the dynadock™ is connected and docked, and then click the Show Hidden Icons button [], if necessary, to display hidden icons.

- 3 Click the [] button next to S/PDIF Output, and then select **Digital Audio 48KHz** from the drop-down list.
- 4 Click **OK**.
- 5 Configure the Audio Output setting of your media playback software to use S/PDIF.

NOTE To locate the Audio Out control, access your media player's setup or configuration screen. For more information, please see the documentation provided with your media playback software.

Charging USB devices

- You can charge select USB devices (such as PDAs, MP3 players, and cellular phones) using the dynadock's two front USB ports (USB Sleep and Charge ports) even when your computer is undocked or disconnected from the dynadock™, or your computer is off.

Charge mode is enabled by default. See “Using the TOSHIBA dynadock Utility” on page 42 to enable/disable Charge mode.

NOTE Some USB devices may not support this feature.

To charge a device when the dynadock™ is disconnected or the connected computer is off:

- 1 Make sure the dynadock's AC adaptor is connected to an electrical outlet.
- 2 Connect the device you want to charge to one of the dynadock's front USB ports.
- 3 Press the Dock/Undock button once. The indicator light glows orange to indicate charging is in progress.

To stop charging the device, press the Dock/Undock button again. The indicator light turns off.

Using standby/sleep/hibernation modes with the dynadock™

When your docked computer enters standby/sleep/hibernation mode, devices connected to the dynadock™ will not function until the computer returns to an active state. For example, if you are using the Ethernet port for high-speed network access, network access will not be available until the computer resumes from standby/sleep/hibernation.

In addition, please keep in mind the following important information regarding the affect of standby/sleep/hibernation mode on external monitors connected to the dynadock™:

- ❖ The external monitor connected to the dynadock™ will go blank if the computer enters standby/sleep/hibernation mode.
- ❖ In Mirror mode, the external monitor retains the settings it had previously when the computer resumes from standby/sleep/hibernation.
- ❖ In Extended mode, windows that were previously on the external monitor may appear on the computer's built-in display when the computer resumes from standby/sleep/hibernation. You may need to reposition the windows by dragging them to the external desktop again.
- ❖ If the external monitor is in Extended mode and the computer requires you to log in after resuming from standby/sleep/hibernation, the login screen will appear on the primary computer monitor, not the external monitor. This is consistent with Windows® operating system standards.

Securing the dynadock™

The security lock slot enables you to connect a security cable (not provided) to help prevent unauthorized removal of the dynadock™.

Follow these steps to secure your dynadock™:

- 1** Attach your security cable (purchased separately) to a desk or other large object, following the instructions included with your security cable.
- 2** Insert the lock end of the security cable into the dynadock's security lock slot.
- 3** Turn the key or set the combination on the end of the security cable.

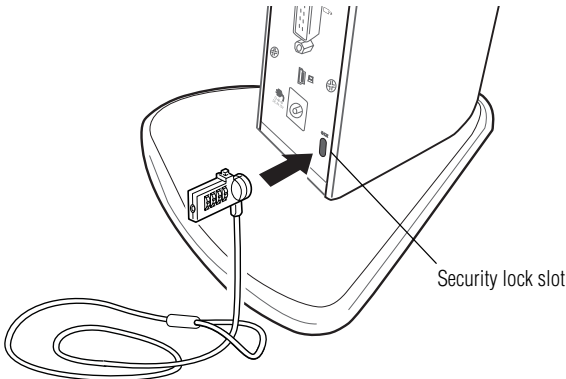

(Sample Illustration) Connecting a security cable to the dynadock™

Chapter 3

Troubleshooting and Support

Troubleshooting

This section provides answers for problems you may encounter when using your dynadock™. Some problems are relatively easy to identify and solve; however, others may require help from your network administrator or company technical support staff. If you need to contact Toshiba, you will find information regarding Toshiba's support services at the end of this section.

Before you contact Toshiba, please read the troubleshooting advice in this manual, in your computer's user's guide and/or in any manuals that came with your optional peripheral devices.

This section provides troubleshooting guidance for problems in the following categories:

- ❖ Power
- ❖ Display/Video
- ❖ Audio/sound
- ❖ Connection/Docking
- ❖ Network
- ❖ USB
- ❖ Other

NOTE

Due to USB bandwidth limitations, you may notice performance issues if you are performing several resource-intensive tasks simultaneously (such as playing audio over more than two channels while simultaneously recording audio, transferring large files and using a high-definition web camera). This type of activity is common when running instant messaging applications. In such situations, the screen may go black or become unresponsive or there may be no sound from the connected audio device. To avoid these performance limitations, use two-channel audio output and/or connect fewer devices at a time.

Power

<i>Problem(s)</i>	<i>Solution(s)</i>
What is the button on the top of the dynadock™ used for? Is it a power button?	It is used to stop any devices connected to the dynadock™ so that the dynadock™ can be safely disconnected from your computer. It is not a power button.
Docked computer will not turn on (your computer's AC power light does not turn on).	The dynadock™ does not power the computer. Use the AC adaptor that came with your computer to power your computer.
Why doesn't the dynadock™ charge the computer's battery and power the computer like a port replicator?	The dynadock™ is a universal docking station that connects to the computer via USB. USB provides only 500mA of electric current, which is not enough to power a computer or charge its battery.
The dynadock™ does not turn on (the dynadock's power light does not turn on).	<p>Check the connections. Make sure the AC adaptor and power cord/cable that came with the dynadock™ is firmly connected to the dynadock™ and a live electrical outlet.</p> <p>Check the condition of the AC adaptor, power cord/cable, and plug prongs. If they are damaged, replace the adaptor and power cord/cable.</p> <p>Disconnect and reconnect the AC adaptor.</p>

Display/Video

NOTE

For additional information on troubleshooting dynadock™ video issues, please visit the DisplayLink Web site at www.displaylink.com.

<i>Problem(s)</i>	<i>Solution(s)</i>
External monitor does not turn on (the monitor's power light does not turn on).	<p>Make sure that the external monitor's power switch is on. Confirm that the external monitor's power cable is plugged into a live electrical outlet.</p> <p>Make sure that the external monitor is securely connected to the dynadock™.</p> <p>Check the external monitor settings.</p> <p>Make sure the dynadock™ is connected to your computer (wirelessly or with a USB cable) and the computer is docked (indicator light on dynadock™ is green).</p> <p>Refer also to the computer user's manual and to the external monitor's documentation.</p>
No image displays on the external monitor connected to the dynadock™.	<p>Try adjusting the resolution, contrast and or brightness controls on the external monitor.</p> <p>Make sure the external display is not set to Off in the TOSHIBA Video Dock Utility. For more information, see Using the TOSHIBA Video Dock Utility.</p> <p>Check that the dynadock™ is connected (wirelessly or with a USB cable) to your computer.</p> <p>Check to make sure that the computer is docked (the indicator light on the front of the dynadock™ is solid green). For more information, please see "Re-connecting and docking your computer" on page 36.</p> <p>Make sure your Windows® operating system is updated with the latest available Service Pack from Microsoft®. Your computer BIOS (Basic Input/Output System) may also need to be updated. Refer to the your computer manufacturer's Web site for more information. Restart your computer after updating the operating system and/or the BIOS, and try using the dynadock™ again.</p>
Display error.	<p>Check that the cable connecting the external monitor to the dynadock™ is firmly attached.</p>
A program window on the external monitor connected to the dynadock™ has gone black or is unresponsive.	<p>Try restarting the application.</p> <p>If you are performing several resource-intensive tasks simultaneously (for example, playing audio over more than two channels, recording audio, transferring large files, and using a web camera at the same time), the issue may be due to USB bandwidth limitations.</p> <p>To avoid these performance limitations, use two-channel audio output and/or connect fewer devices at a time.</p>

<i>Problem(s)</i>	<i>Solution(s)</i>
The Fn + F5 and Fn + Space hot keys on my Toshiba computer do not affect the external monitor connected to my system via the dynadock™.	The Fn + F5 and Fn + Space hot key functionality detailed in your Toshiba computer User's Guide controls the video controller for the computer's built-in display and your computer's video port. These hot keys cannot be used to control an external display connected via the dynadock™. To control the video adaptor within the dynadock™, see "Adjusting video settings" on page 47 .
The external monitor connected to the dynadock™ shows only the wallpaper background of my Windows® desktop.	The default configuration for the external monitor connected to the dynadock™ is Extended mode (an extension of the image on the computer). This mode allows you to display different information on each monitor connected to your computer. Drag a window off of the right side of your primary display to have it appear on the external monitor. To switch to Mirror mode, so that an exact duplicate of the image on your primary monitor displays on the external monitor, please see "Adjusting video settings" on page 47 .
Video or game playback is slow or choppy on the external monitor connected to the dynadock™.	The dynadock™ uses an advanced video graphics controller to display images on an external monitor connected to the dynadock™. However, the dynadock™ connects to the computer via USB, and due to USB 2.0 data transfer speed limitations, some or all portions of video/game playback may appear slow or choppy. This is not a malfunction of the dynadock™. For optimal video playback performance, use your computer's display.
My Windows Vista® system runs more slowly when an external monitor is connected to the computer via the dynadock™.	This may occur if the external monitor is set to Mirror mode and the display resolution is higher than 1280 x 800. You can take one or more of the following actions to resolve the problem: <ul style="list-style-type: none"> ❖ Disable the Aero color scheme. (Click Start, Control Panel, Appearance and Personalization, Personalization, and then Window Color and Appearance. The Appearance Settings window opens. Select a different color scheme other than "Windows Aero.") ❖ Lower the display resolution. ❖ Switch to Extended mode.
Cannot play videos on an external monitor connected to the dynadock™.	Try a different media player. For optimal video playback performance, use the computer's display.
The Video Dock icon menu does not list all of the resolution modes my monitor is capable of displaying.	The dynadock™ video card requires Extended Display Identification Data (EDID) to be supplied by a connected monitor. This information includes resolution settings supported by the monitor. Some monitors do not supply this information, and in such cases the resolution settings available in the Video Dock icon menu will be limited, to avoid damage to the monitor.

<i>Problem(s)</i>	<i>Solution(s)</i>
I cannot open the ATI Catalyst Control Center on my computer since I installed the dynadock™ display drivers and utility.	Some versions of ATI Catalyst Control Center are not supported by the dynadock™. Use Windows® Display Properties and the Toshiba Video Dock utility instead to control your display(s).
The external monitor connected to the dynadock™ is incorrectly identified as a "Non-PNP monitor" in the Windows® Device Manager.	The monitor name displayed in the Windows® Device Manager is controlled by Windows®. This designation will not affect the functionality of the device.
I cannot run Transient Multi-Monitor Manager in Windows Vista® since I installed the dynadock™ display drivers and utility.	Transient Multi-Monitor Manager (TMM) in Windows Vista® is not supported by this product. Use the TOSHIBA Video Dock utility instead to configure your computer for using an external monitor connected to the dynadock™.
After I re-dock my computer or after my computer resumes from standby/sleep/hibernation mode, windows that were previously displayed on the extended desktop are now displayed on the primary monitor.	External monitors are automatically disabled when you undock or when the system enters standby/sleep/hibernation mode. This may sometimes cause windows to be returned to the primary display when you re-dock or the system resumes. To reposition the windows, drag the window(s) to the external display.
When I undock my computer, windows that were previously displayed on the extended desktop do not return to my primary display.	To return an open window to the primary display, right-click the taskbar button for that program and select Minimize, and then right-click the button again and select Maximize. Using the Video Dock utility, change the display mode to Mirror mode. All open windows will return to the primary display. To prevent this from occurring the next time you undock, you can either set the display mode to Mirror before undocking or drag all windows to the primary desktop before undocking.
I cannot use full-screen DOS mode on an external monitor connected to the dynadock™.	This product does not support full-screen DOS mode on an external monitor connected to the dynadock™. To use full-screen DOS mode, disconnect the dynadock™ and use your computer's display.
The computer's built-in display does not turn off when the external monitor connected to the dynadock™ is set as the primary monitor.	On some systems, the dynadock™ video adapter cannot control the internal display.

<i>Problem(s)</i>	<i>Solution(s)</i>
Mirror mode is not available (grayed out).	Mirror mode is not available if the external monitor connected to the dynadock™ is set as the primary display. To enable Mirror mode, set the computer's built-in display as the primary display in the Windows Display Properties dialog box.
Scalable Link Interface (SLI) mode is not available.	This product does not support SLI mode when more than two graphics cards are installed in the connected computer. In such cases, SLI mode is disabled.
In Windows Display Properties, I cannot move the external monitor icon where I want relative to the icon of the computer's built-in display	Try dragging the computer's built-in display icon instead, relative to the external monitor icon.
I cannot drag windows from my primary display to the external monitor connected to the dynadock™.	<p>Follow these steps to fix the problem:</p> <ol style="list-style-type: none"> 1 Open the Windows® Display Properties dialog box and position the monitor icons on the Settings tab to match the physical arrangement of your monitors. 2 In the Toshiba Video Dock utility, make sure the "Extend to" setting matches the physical arrangement of your monitors. For example, if the external monitor is to the right of the computer display, select "Extend to right." 3 Drag the window you want to move in the direction that matches the extension setting. <p>For example, if the desktop space is extended to the right, drag the window off of the right edge of the primary display and it will appear on the extended desktop.</p>
I cannot run a 3D program or a program using DirectDraw commands on the external monitor connected to the dynadock™.	This product does not support 3D programs. Running applications that use certain DirectDraw commands (such as some 2D gaming applications) is also not supported. If you want to play these games in full-screen mode, disconnect the dynadock™ and use your computer's display.

Audio/sound

<i>Problem(s)</i>	<i>Solution(s)</i>
There is no sound coming from the external audio device connected to the dynadock™.	<p>Check and adjust the volume settings.</p> <p>Make sure the cable connecting the audio device to the dynadock's Line out, Headphone, or Microphone jack is secure.</p> <p>Check that the Mute all/Mute checkboxes in Microsoft® Windows® are not selected or that the volume is not set too low. To locate these settings, double-click the speaker icon in your Windows® System tray/Notification Area.</p> <p>Close your media player application, if it is running. Wait approximately 10-15 seconds for the operating system to recognize the audio device connected to the dynadock™ and then restart your media player application.</p> <p>The audio port on the dynadock™ may be disabled. To enable the port, follow the instructions in "Configuring audio ports" on page 50.</p> <p>Due to USB bandwidth limitations, the dynadock™ may not be able to play sound over more than two channels if you are simultaneously performing other resource-intensive tasks. To avoid these performance limitations, use two-channel audio output and/or connect fewer devices at a time.</p>
There is no sound coming from the computer's internal speakers, or from the headphones/headset connected directly to the docked computer.	<p>By default, the internal speakers and audio ports on the computer are disabled when the computer is docked. To enable the speakers or audio ports on the docked computer, so that you can connect audio devices directly to your computer when it is docked, follow the instructions in "Configuring audio ports" on page 50.</p> <p>Check that the Mute all/Mute checkboxes in Windows® are not selected. To locate these settings double-click the speaker icon in your Windows® System tray/Notification Area.</p> <p>Close the media player application, if it is running. Wait approximately 10-15 seconds for the operating system to recognize the audio device and then restart the media player application.</p>
No sound outputs from the dynadock™ audio ports after I restart my computer or after it resumes from standby/sleep/hibernation mode.	<p>Manually enable the dynadock™ audio ports as described in the section "Adjusting audio settings" on page 50.</p>
After my computer is restarted, the input volume for the microphone connected to the dynadock™ reverts to the default setting.	<p>The computer's operating system controls the default volume after the system is restarted. You will need to manually reset the volume to the desired level after the system has restarted.</p>

<i>Problem(s)</i>	<i>Solution(s)</i>
Sound is distorted or delayed when playing some multimedia files.	Disconnect the dynadock™ from your computer and play the file again.

Connection/Docking

<i>Problem(s)</i>	<i>Solution(s)</i>
My computer does not automatically detect the Certified Wireless USB adaptor.	<p>Make sure you have properly connected the adaptor to your computer.</p> <p>Disconnect and then reconnect the adaptor.</p> <p>The computer's USB port may be damaged. Check to see if other devices can be successfully connected to the port.</p>
What is the difference between connecting and docking?	<p><i>Connecting</i> opens a line of communication between the computer and the dynadock™, but not between the computer and external devices connected to the dynadock™.</p> <p><i>Docking</i> enables the computer to communicate with devices connected to the dynadock™. The computer can only be docked with one dynadock™ at a time.</p>
I cannot get the computer to connect and dock (the indicator light does not turn solid green).	<p>If you are using a wireless connection:</p> <ul style="list-style-type: none"> ❖ The computer may be too far away from the dynadock™; move closer to the dynadock™. ❖ Make sure that there is nothing between the computer and the dynadock™ (for example, walls/monitors). ❖ Make sure the wireless USB adaptor is properly connected to your computer. ❖ Make sure the adaptor's antenna (if you are using an adaptor) and the dynadock's antennas are in the upright position. ❖ Make sure the antenna switch on the back of the dynadock™ is set to the down position. ❖ Verify that the settings in the Wireless USB Manager utility are configured correctly to enable wireless communication. For more information, please see "Using the Wireless USB Manager" on page 37. <p>If you are using a wired (USB cable) connection:</p> <ul style="list-style-type: none"> ❖ Make sure the USB cable connecting the devices is secure on both ends. ❖ Make sure the antenna switch on the back of the dynadock™ is set to the  (up) position.

<i>Problem(s)</i>	<i>Solution(s)</i>
The connection to the dynadock™ has been lost.	<p>The computer may be out of wireless communication range. Bring the computer within close range of the dynadock™ to automatically reconnect.</p> <p>The computer may be in standby/sleep/hibernation mode. The computer will re-connect when it resumes from standby/sleep/hibernation.</p> <p>In wireless mode, the USB adaptor may have been disconnected. Re-connect the USB adaptor to the computer.</p> <p>In wired mode, the USB cable may have been disconnected. Re-connect the USB cable.</p> <p>There may be an obstruction between the dynadock™ and your computer that is preventing wireless communication. Remove the obstruction.</p> <p>Make sure the antenna switch on the back of the dynadock™ is in the correct position (up for communication via a USB cable; down for wireless communication).</p>

Network

<i>Problem(s)</i>	<i>Solution(s)</i>
Cannot access the local area network (LAN).	<p>Check that the computer is properly configured to communicate with the network before connecting the LAN cable to the dynadock™. If necessary, contact your system administrator for assistance.</p> <p>Check that the network cable is properly connected to the dynadock™. For more information see "Connecting to a network" on page 28.</p> <p>Make sure the dynadock™ is connected to your computer (wirelessly or with a USB cable) and the computer is docked (indicator light on dynadock™ is green).</p> <p>If the problem is related to the dynadock™ hardware, see the "Toshiba Support" on page 69.</p>

USB

<i>Problem(s)</i>	<i>Solution(s)</i>
USB device does not work.	<p>Make sure the dynadock™ is connected to your computer (wirelessly or with a USB cable) and the computer is docked (indicator light on dynadock™ is green).</p> <p>Check that the cable connection between the USB port on the dynadock™ and the USB device is secure.</p> <p>Make sure that the USB device drivers are properly installed. Refer to the operating system documentation for more information.</p> <p>Make sure that the AC adaptor (if applicable) is connected securely to the USB device and a live electrical outlet.</p> <p>Refer to the documentation that came with the USB device.</p>
A USB device(s) connected to the dynadock™ does not work after resumption from standby/sleep/hibernation or restart. Yellow exclamation points appear in the Windows Device Manager next to one or more of the connected USB devices.	This problem may occur when there are six USB devices connected to the dynadock™ and the computer enters standby/sleep/hibernation mode or is restarted. To resolve the issue, disconnect and then re-connect one of the USB devices.
The dynadock™ is not charging the USB device.	<p>Make sure that the USB device is connected to one of the front powered USB ports.</p> <p>Make sure the AC adaptor/cord is firmly connected to the dynadock™ and a live electrical outlet.</p> <p>Make sure that "Charge mode" is enabled. See "Charging USB devices" on page 56.</p> <p>Make sure that the dynadock's blue power light is on.</p> <p>Some USB devices may not support this feature.</p>
My real-time device (for example, a Web camera, microphone, or speakers) does not operate properly when connected to the dynadock™.	Due to USB bandwidth limitations, real-time devices (for example, Web cameras, microphones, and speakers) may not operate properly if more than two such devices are connected to the dynadock™ at the same time.

Other

<i>Problem(s)</i>	<i>Solution(s)</i>
My computer's display is showing a blue error screen, after I connected the dynadock™ to my computer.	Make sure your Windows® operating system is updated with the latest available Service Pack from Microsoft®. Your computer BIOS (Basic Input/Output System) may also need to be updated. Refer to the your computer manufacturer's Web site for more information. Restart your computer after updating the operating system and/or the BIOS, and try using the dynadock™ again. The blue error screen may be unrelated to the dynadock™. Refer to the documentation that came with your computer and your computer manufacturer's Web site for more information.

Toshiba Support

If you require additional help or are still having problems operating the dynadock™, you may need to contact Toshiba for additional technical assistance.

Before you call

Since some problems may be related to software or the operating system, it is important that you investigate other sources of assistance first.

Try the following, before contacting Toshiba:

- ❖ Review the user's manual and/or troubleshooting sections in the documentation supplied with your software and/or peripheral devices.
- ❖ If a problem occurs when you are running software applications, consult the software documentation for troubleshooting suggestions. Contact the software company's technical support department for assistance.
- ❖ Consult the reseller or dealer from whom you purchased your computer, dynadock™, optional peripheral devices and/or software. They are your best resource for current information and support.

Contacting Toshiba

Toshiba's technical support Web site

For technical support, or to stay current on the most recent software and hardware options for your dynadock™ and for other product information, be sure to regularly check the Toshiba Web site at pcsupport.toshiba.com.

Toshiba voice contact

Before calling Toshiba, make sure you have:

- ❖ Your dynadock's serial number
- ❖ The computer and any optional devices related to the problem
- ❖ Backup copies of your Windows® operating system and all other preloaded software on your choice of media
- ❖ Name and version of the program involved in the problem, if applicable, along with the its installation media
- ❖ Information about what you were doing when the problem occurred
- ❖ Exact error messages and when they occurred

For technical support, call the Toshiba Customer Support Center:

Within the United States at (800) 457-7777

Outside the United States at (949) 859-4273

Appendix A

Specifications

Specifications

This section summarizes the dynadock's technical specifications.*

Physical dimensions

Weight	490 g/17.2 oz (including the base)
Size	42 (w) x 77 (d) x 222 (h) mm/1.7 (w) x 3.0 (d) x 8.7 (h) in (main body)
	112.5 (w) x 130 (d) x 234 (h) mm/4.4 (w) x 5.2 (d) x 9.3 (h) in (with base connected)

Environmental requirements

<i>Conditions</i>	<i>Ambient temperature</i>	<i>Relative humidity</i>
Operating	5 to 35 °C (41 to 95 °F)	20 to 80%
Non-operating	-20 to 65 °C (-4 to 149 °F)	10 to 90%
Thermal Gradient	20 °C per hour maximum	
Wet-bulb Temperature	26 °C maximum	

Power requirements

AC adaptor	100-240 volts AC 50-60 Hz (cycles per second)
dynadock™	15V DC 3.0/4.0 amperes (differs per unit)

General specifications

Computer Interface	USB 2.0 or UWB (ultra-wide band radio link)
Ports and Connectors	4 USB 2.0 ports in the back 2 USB 2.0 Powered ports in front 1 S/PDIF connector (optical digital audio output) 1 Ethernet port (10/100 Base-T Ethernet RJ-45 connector) 1 DVI-I port (Digital 24-pin Female Connector) 1 Microphone connector (3.5 mm mono audio in) 1 Headphones connector (3.5 mm stereo audio out) 1 Line out(3.5 mm stereo audio out) 1 DC-IN socket 1 Security lock slot
Supported Video Display Modes	Windows® XP: Mirror Desktop, Extended Desktop, Primary Display Windows Vista®: Mirror Desktop, Extended Desktop, Primary Display *Depending on your operating system, some built-in video adaptors may prevent a second monitor from being the primary display.

*Specifications are subject to change without further notice.

Index

A

- AC power
 - connection 21
- adjusting
 - audio settings 50
 - video settings 47
- antenna switch 17
- antennas 17
- assemble
 - dynadock™ 20
- associations
 - dynadock™ with computer 39
- audio devices
 - connecting 30
- audio ports
 - configuring 50
- audio settings
 - adjusting 50
- audio/sound
 - issues 65

B

- back view
 - Quick Tour 16
- background utility 37

- button
 - dock/undock 18
 - undocking 34

C

- changing
 - Connection Rules 39
- Charge mode
 - enabling/disabling 44
- charging
 - USB devices 56
- computer
 - docking 36
 - re-connecting 36
 - undocking 33
- computer requirements 19
- configuring
 - audio ports 50
- connect
 - AC power 21
 - DC-IN 21
 - dynadock™ to computer 24
- connecting
 - audio devices 30
 - Mini USB cable 26

- monitor to dynadock™ 29
- peripherals 28
- to a network 28
- USB cable to computer 26
- USB devices 31
- connecting/disconnecting
 - dynadock™ from computer 39
- Connection Rules
 - changing 39
- connection/docking
 - issues 66
- contacting Toshiba 69

D

- DC-IN
 - connection 21
- DC-IN port 17
- disable/enable
 - pop-up messages 40
 - radio communications 41
- display/video
 - issues 61
- dock/undock button 18
- docking
 - your computer 36
- dynadock Install Menu 22
- dynadock™
 - antennas 17
 - assemble 20
 - environmental requirements 71
 - general specifications 72
 - physical dimensions 71
 - power requirements 71
 - security lock slot 58
 - setting up 20
- dynadock™ software
 - using 37

E

- enable
 - virtual 7.1 channel surround
 - sound 52
- enabling

- S/PDIF output 55
- enhancing
 - sound quality 52
- environmental requirements
 - dynadock™ 71
- Extended/Mirror mode
 - selecting 47

F

- FCC information 5
- front view
 - Quick Tour 14

G

- general specifications
 - dynadock™ 72

H

- Headphone jack 15, 17
- Hibernation mode 57
- Host/Device Drivers
 - uninstalling 41

I

- icon
 - safety 2
- icons
 - safety 2
- indicator light 15
- inserting
 - wireless USB adaptor 25
- install
 - software 21
- instructions
 - safety 3
- introduction 12
- issues
 - audio/sound 65
 - connection/docking 66
 - display/video 61
 - Network 67
 - Other 69
 - power 60
 - USB 68

L

- light
 - indicator 15
 - power 15

Line out 17

M

- Microphone jack 15
- Mini USB jack 17
- monitor
 - connecting 29

N

- Network
 - issues 67
- network
 - connecting 28
- Network port 17

O

- Optical S/PDIF 17
- Other
 - issues 69

P

- package contents 18
- peripherals
 - connecting 28
- physical dimensions
 - dynadock™ 71
- pop-up messages
 - disable/enable 40
- port
 - DC-IN 17
 - Headphone jack 15
 - Line out (Headphones, Speakers) 17
 - Microphone jack 15
 - Mini USB 17
 - Mini USB, connecting 26
 - Network 17
 - Optical S/PDIF 17
 - USB 2.0 (2) (USB Sleep and Charge ports) 15

- power
 - issues 60
- power light 15
- power requirements
 - dynadock™ 71

Q

- Quick Tour 14
 - back view 16
 - front view 14
 - top view 18

R

- radio communication 40
- radio communications
 - disable/enable 41
- re-connecting
 - your computer 36

S

- S/PDIF output
 - enabling 55
- safety
 - icons 2
 - instructions 3
- security lock slot 17
 - dynadock™ 58
- selecting
 - Extended/Mirror mode 47
 - message options 44
- set up
 - USB cable connection 28
 - wireless connection 24
- setting
 - Sleep mode options 43
- setting up
 - the dynadock™ 20
- Sleep mode 57
 - undocking 35
- Sleep mode options
 - setting 43
- software
 - install 21

- uninstalling 47
- sound quality
 - enhancing 52
- specifications 71
- Standby mode 57
- switch
 - antenna switch 17
- T**
- top view
 - Quick Tour 18
- Toshiba
 - Web site 69
- TOSHIBA dynadock Utility
 - using 42
- Toshiba support 69
- TOSHIBA Video Dock Utility
 - using 45
- troubleshooting 59
- U**
- undocking
 - Sleep mode 35
 - via button 34
 - via the utility 34
 - your computer 33
- uninstalling
 - Host/Device Drivers 41
 - software 47
 - Wireless USB Manager 41
- USB
 - issues 68
- USB 2.0 (2) (USB Sleep and Charge ports) 15
- USB cable connection
 - set up 28
- USB devices
 - charging 56
 - connecting 31
- USB Multi-Channel Audio Utility
 - using 45
- using
 - dynadock™ software 37
 - TOSHIBA dynadock Utility 42
 - TOSHIBA Video Dock Utility 45
 - USB Multi-Channel Audio Utility 45
 - Wireless USB Manager 37
- utility
 - undocking 34
- V**
- video settings
 - adjusting 47
- virtual 7.1 channel surround sound
 - enable 52
- W**
- Web site
 - Toshiba 69
- wireless connection
 - set up 24
- Wireless USB Manager
 - uninstalling 41
 - using 37
- Wireless USB Manager window 38

Free Manuals Download Website

<http://myh66.com>

<http://usermanuals.us>

<http://www.somanuals.com>

<http://www.4manuals.cc>

<http://www.manual-lib.com>

<http://www.404manual.com>

<http://www.luxmanual.com>

<http://aubethermostatmanual.com>

Golf course search by state

<http://golfingnear.com>

Email search by domain

<http://emailbydomain.com>

Auto manuals search

<http://auto.somanuals.com>

TV manuals search

<http://tv.somanuals.com>