

libretto™ U105¹

Model Name	Description	Part Number	UPC Code
libretto U105	Microsoft® Windows® XP Professional, Intel Pentium® M Processor 753, 7.2" WXGA TFT, 512MB, 60GB, 802.11b/g, DVD Dock with DVD SuperMulti drive, Bluetooth Specification 2.0 with EDR	PLU10U-00901D	032017348523

System Characteristics²**Operating System³**

- Microsoft® Windows® XP Professional

Processor

- Intel Pentium® M Processor Ultra Low Voltage 753 [1.20GHz, 2MB L2, 400MHz FSB]
- Toshiba® Express Media Player for quick access to CD, DVD⁴ (functional with DVD Dock)

Chipset

- Intel 855GME Chipset

Memory⁵

- Configured with 512MB DDR SDRAM memory module on 1 memory slot
- 256MB (Min)/1024MB (Max), 1 memory slot for 256MB, 512MB, or 1024MB PC2700 DDR 333MHz SDRAM 2.5V SODIMM memory module. Current memory module must be removed to upgrade to maximum memory.

Mass Storage

- 60GB (4200 RPM) Enhanced IDE (ATA-6) hard disk drive; 8.0mm height; service removable

Optical Drive (via the libretto DVD Dock)

- DVD SuperMulti Drive

Display⁶

- 7.2" diagonal widescreen TruBrite™ TFT active-matrix LCD display at 1280x768 native resolution (WXGA)
- Maximum Brightness 220 cd/m²
- Viewing Angle
 - Horizontal – 120 degrees
 - Vertical – 105 degrees
- Brightness Control – FN+F6/F7

Graphics⁷

- Intel Extreme Graphics 2, 16MB-64MB of graphics memory is taken from the main memory via UMA (Unified Memory Architecture)

Sound

- Analog Devices AD1981B integrated 16-bit stereo software sound
- Built-in stereo speakers
- Built-in monaural speaker
- Direct 3D Sound; DirectSound, Direct Music, MIDI (playback) Support
- Sound Volume Control Dial
- TOSHIBA Audio enhancement with SRS WOW and SRS TruSurround XT⁸

Input Devices

- Keyboard
 - 84 key US keyboard
 - Hot Key Functions (FN); please see electronic User's Guide for more information
 - Windows Key Function
 - Application Key Function
- Pointing Device:
 - Toshiba Accupoint™
- Others:
 - CD Buttons (Skip to Previous Track, Play, Stop, Skip to Next Track) available only on libretto DVD Dock

Expandability

- 1 PC Card slot support 1 Type II, PCMCIA R2.01, PC Card16, CardBus
- Secure Digital® Adaptor (supports SD-IO, supports mini-SD with optional adaptor)

Communications

- Integrated V.92 modem⁹
- Intel® PRO/100 VE Network Connection - 10/100 Base-TX Ethernet
- Atheros® 802.11b/g wireless-LAN supporting Atheros SuperG™ technology¹⁰
- Bluetooth® version 2.0 plus Extended Data Range (EDR) with TOSHIBA Bluetooth stack software

Ports

- RGB (monitor) port (via mini-RGB adaptor)
- i.LINK™ IEEE-1394
- 2 Universal Serial Bus (USB) ports (v2.0)
- Headphone jack
- RJ-45 LAN port
- RJ-11 modem port
- Docking connector

Physical Description

- Dimensions (WxDxH Front/H Rear): 8.27" (210.0mm) x 6.50" (165.0mm) x 1.17" (29.8mm)[F]/1.31" (33.4mm)[R] without feet
- Weight¹¹: 2.16lb (0.98kg) depending upon configuration (without libretto DVD Dock)
 - libretto DVD Dock weight: 0.99 lbs (.45kg)
- LED Indicators: DC-IN, Primary HDD access, Main Battery Charging Status, Wireless Communication (for Wireless LAN/Bluetooth)

Power Supply

- 60W Auto sensing external AC Adapter, 100-240V / 50-60Hz frequency (Universal) input.
- Weight: starting at 0.58 lbs
- Dimensions (WxDxH): 4.39" (111.5mm) x 1.95" (49.5mm) x 1.14" (29mm)

Battery¹²

- 6-cell (3400mAh) rechargeable, removable Lithium Ion (Li-Ion) battery pack
- Weight: starting at 0.52 lbs
- Dimensions (WxDxH): 6.2" (160mm) x 0.8" (20.7mm) x 1.8" (47mm)
- Battery Life: Up to 5 hours (measured by MobileMark™) (6-cell battery)¹³
- Recharge Time: approximately 3.0 hours (System Off) or approximately 3.0 hours to 8.0 hours or longer (System On)

Toshiba Mobility Enhancements

- HDD Shock Absorption¹⁴
- Toshiba 3D Accelerometer
- Built-in finger print sensor
- Physical Security
 - Slot for cable lock;
 - Items protected by a screw: Memory and Main HDD
- Software Security
 - Passwords: User Power-on password, Supervisor Password
 - Hotkey locks: Keyboard, Screen Blank
 - Software: Screen Saver (by software).

BIOS

- ACPI v1.0b, PNP v1.0, VESA, DPMS, DDC, SM BIOS v2.3, PCI BIOS v2.1 support

Software¹⁵**Toshiba Software and Utilities**

- Toshiba ConfigFree™
- Toshiba Custom Utilities
- Electronic User's Guide

TOSHIBA

Third-party Software

- Microsoft® Works
- Microsoft® Office OneNote™
- Software Decoder: Intervideo® (WinDVD™ 5)
- Sonic® Solutions Drive Letter Access (DLA)
- Sonic® Solutions RecordNow! Basic
- OmniPass Finger Print Software Version 3.50
- McAfee VirusScan (30 Day Trial)
- AOL® Internet Service¹⁶ (90 day trial)
- AT&T® Worldnet® Service¹⁷

Environmental Specifications

	Operating	Non-Operating
Temperature ¹⁸	5° to 35°C (41° to 95°F)	-20° to 65°C (-4° to 149°F)
Thermal Gradient	15°C per hour maximum	20°C per hour maximum
Relative Humidity	20% to 80%	10% to 90%
Altitude (relative to sea level)	-60 to 3000 meters	-60 to 10,000 meters
Shock	7G	60G
Vibration	0.2G	1.0G

Limited Warranty¹⁹

Limited Warranty Upgrades and Extensions

Toshiba offers many different warranty extensions and enhanced service

plans such as SystemGuard®, At-Home Repair, and Service Express to provide additional support to your notebook PC. For a full description and complete list of programs, please visit www.accessories.toshiba.com

Accessories

For additional and most update accessories, please visit www.accessories.toshiba.com

Memory

Part Number	Description
KTT3311/512	Kingston DDR 333, 512MB
KTT3311/1G	Kingston DDR 333, 1GB

Storage

Part Number	Description
PA3109U-1FDD	Toshiba USB Floppy Disk Drive Kit

Power

Part Number	Description
PA3241U-1ACA	Toshiba 45W Global AC Adapter
PA3442U-1BRS	Toshiba Primary Battery Pack (6 Cell)

Wireless/Bluetooth

Part Number	Description
PA1381U-1ETC	Toshiba Wireless Headphone w/Bluetooth Technology

Subject to Change

While Toshiba has made every effort at the time of publication to ensure the accuracy of the information provided herein, product specifications, configurations, prices, system/component/options availability are all subject to change without notice. For the most up-to-date product information about your computer, or to stay current with the various computer software or hardware options, visit Toshiba's Web site at <http://www.pcsupport.toshiba.com>.

Return Policy

Notwithstanding anything to the contrary in any third party License Agreement or product documentation supplied with your PC, Toshiba America Information Systems, Inc. ("TAIS") does not accept the return of component parts, or bundled software, that have been removed from the PC system. Pro-rata refunds on individual PC components or bundled software, including the operating system, will not be granted. If you wish to return a complete PC system, contact the TAIS dealer where you purchased the product, and comply with the dealer's standard return policies and procedures.

Toshiba America Information Systems, Incorporated ("TAIS")
9740 Irvine Boulevard
Irvine CA 92618
ToshibaDirect website: <http://www.toshibadirect.com>
TAIS website for resellers: <http://sell.toshiba.com>
TAIS PC Support website: <http://pcsupport.toshiba.com>

Portégé, Satellite, Tecra, Slim SelectBay and SystemGuard are registered trademarks and ConfigFree is a trademark of Toshiba America Information Systems, Inc. and/or Toshiba Corporation. Intel, Celeron, Centrino, Intel Inside, Pentium, the Intel Centrino logo, and the Intel Inside logo are trademarks or registered trademarks of Intel Corporation or its subsidiaries in the United States and other countries. Microsoft and Windows are registered trademarks and OneNote is a trademark of Microsoft Corporation in the United States and/or other countries. Winstone® is a registered trademark and BatteryMark™ is a trademark of Ziff Davis Publishing Holdings Inc. in the U.S. and other countries. MobileMark™ is a trademark of the Business Applications Performance Corporation. Wi-Fi is a registered certification mark of the Wi-Fi Alliance. The Bluetooth word mark and logos are owned by the Bluetooth SIG, Inc. and any use of such marks by Toshiba is under license. NVIDIA and GeForce are registered trademarks or trademarks of NVIDIA Corporation in the United States and/or other countries. All other trademarks are the property of their respective owners.

¹ **Product Series Legal Footnote.** The product specifications and configuration information are designed for a product Series. Your particular model may not have all the features and specifications listed or illustrated.

Product Offering Legal Footnote. Toshiba America Information Systems, Inc. reserves the right to modify or withdraw this offer at anytime without notice.

² **Build-to-Order/Configure-to-Order.** Certain notebook chassis are designed to accommodate all possible configurations for an entire product series. Your select model may not have all the features and specifications corresponding to all of the icons or switches shown on the notebook chassis, unless you have selected all those features. Configuring (customization) of your notebook takes an additional 12 to 15 working days.

³ **Operating System.** Certain Microsoft® software product(s) included with this computer may use technological measures for copy protection. IN SUCH EVENT, YOU WILL NOT BE ABLE TO USE THE PRODUCT IF YOU DO NOT FULLY COMPLY WITH THE PRODUCT ACTIVATION PROCEDURES. Product activation procedures and Microsoft's privacy policy will be detailed during initial launch of the product, or upon certain reinstallations of the software product(s) or reconfigurations of the computer, and may be completed by Internet or telephone (toll charges may apply). Some software may differ from its retail version (if available), and may not include user manuals or all program functionality.

⁴ The Qosmio™Player is not a Windows based application. When using the Qosmio™Player, the Audio / Video recording feature will not function.

⁵ **Memory (Main System).** Part of the main system memory may be used by the graphics system for graphics performance and therefore reduce the amount of main system memory available for other computing activities. The amount of main system memory allocated to support graphics may vary depending on

the graphics system, applications utilized, system memory size and other factors.

⁶ **Display.** Small bright dots may appear on your screen display when you turn on your PC. Your display contains an extremely large number of thin-film transistors (TFT) and is manufactured using high-precision technology. Any small bright dots that may appear on your display are an intrinsic characteristic of the TFT manufacturing technology. Over a period of time, and depending on the usage of the computer, the brightness of the screen will deteriorate. This is also an intrinsic characteristic of the screen technology.

When the computer is operated on battery power, the screen will dim and you may not be able to increase the brightness of the screen while on battery power.

⁷ **Graphics (Graphics Processing Unit).** GPU performance may vary depending on product model, design configuration, applications, power management settings and features utilized. GPU performance is only optimized when operating in AC power mode and may decrease considerably when operating in battery power mode.

⁸ **SRS TruSurround XT** – only available in Windows® mode

⁹ **Modem Speed.** Due to FCC limitations, speeds of 53 kbps are the maximum permissible transmission rates during download. Actual data transmission speeds will vary depending on line conditions.

¹⁰ **Wireless.** Wireless connectivity and some features may require you to purchase additional software, external hardware or services. Availability of public wireless LAN access points may be limited. The transmission speed over the wireless LAN and the distance over which wireless LAN can reach may vary depending on surrounding electromagnetic environment, obstacles, access point design and configuration, and client design and software/hardware configurations. The actual transmission speed will be lower than the theoretical maximum speed. To use the Atheros SuperAG™ or SuperG™ wireless function, if available, your client and access point must support the corresponding feature. Performance of these functions may vary depending on the format of data transmitted.

¹¹ **Weight.** Weight may vary depending on product configuration, vendor components, manufacturing variability and options selected.

¹² **Battery Life.** Battery life may vary considerably from specifications depending on product model, configuration, applications, power management settings and features utilized, as well as the natural performance variations produced by the design of individual components. Published battery life numbers are achieved on select models and configurations tested by Toshiba at the time of publication. See "Detailed Specs" for specific battery measurement test. Recharge time varies depending on usage. Battery may not charge while computer is consuming full power. After a period of time, the battery will lose its ability to perform at maximum capacity and will need to be replaced. This is normal for all batteries. To purchase a new battery pack, see the accessories information that shipped with your computer or visit the Toshiba web site at www.accessories.toshiba.com.

¹³ **Battery Life - MobileMark™.** Measured by MobileMark. MobileMark is a trademark of the Business Applications Performance Corporation.

¹⁴ **Shock Protection.** Toshiba's shock absorption technology provides higher impact protection for your system as compared to Toshiba systems without similar shock protection features based on Toshiba's drop tests. Toshiba's standard limited warranty terms and limitations apply. Visit www.warranty.toshiba.com for details.

¹⁵ **Software.** Some software may differ from its retail version (if available), and may not include user manuals or all program functionality.

Certain Microsoft® software product(s) included with this computer may use technological measures for copy protection. IN SUCH EVENT, YOU WILL NOT BE ABLE TO USE THE PRODUCT IF YOU DO NOT FULLY COMPLY WITH THE PRODUCT ACTIVATION PROCEDURES. Product activation procedures and Microsoft's privacy policy will be detailed during initial launch of the product, or upon certain reinstallations of the software product(s) or reconfigurations of the computer, and may be completed by Internet or telephone (toll charges may apply).

¹⁶ **AOL® Internet Service.** Availability may be limited, especially during peak times. TO AVOID BEING CHARGED A MONTHLY MEMBERSHIP FEE, SIMPLY CANCEL BEFORE THE THREE-MONTH PROMOTIONAL PERIOD ENDS. Premium services carry surcharges and communication surcharges may apply, including AK, even during promotional period. Members may incur telephone charges on their phone bill, depending on their location and calling plan, even during promotional period. Available to new AOL members in the United States, age 18 or older; a major credit card or checking account is required.

¹⁷ **AT&T® Worldnet® Service.** Telephone access and other charges and other terms and conditions may apply. Offer available to new customers only.

¹⁸ **Temperature (Environmental) Conditions.** All temperature references are approximate and the performance of your computer may vary from specifications even when operating within the recommended temperature range.

¹⁹ **Warranty.** Toshiba's standard limited warranty, extended warranty and service upgrade terms and conditions are available at <http://www.warranty.toshiba.com>.

Front with display open

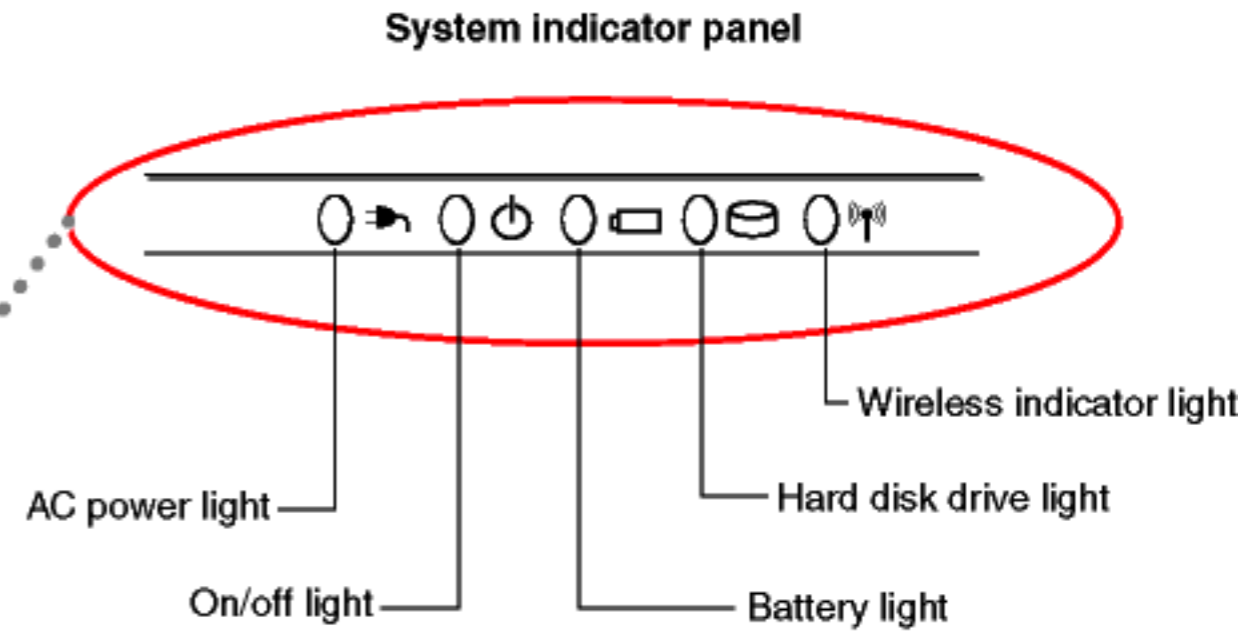
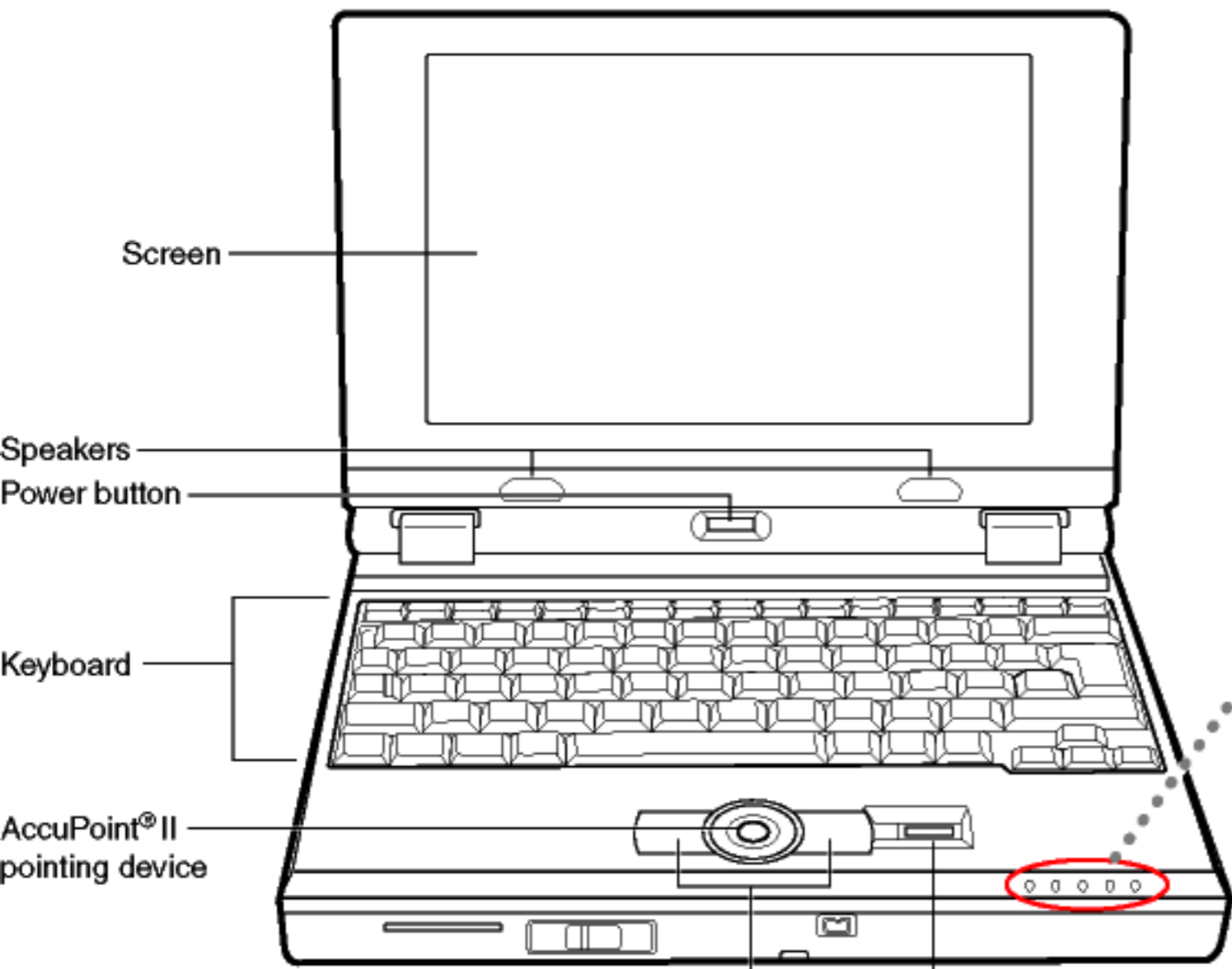

Front with display closed

System indicator lights

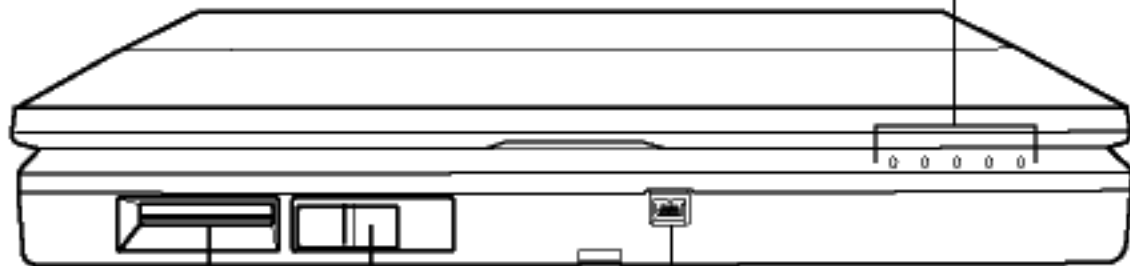

SD™ card
slot

PC Card
eject switch

i.LINK® port

Left side

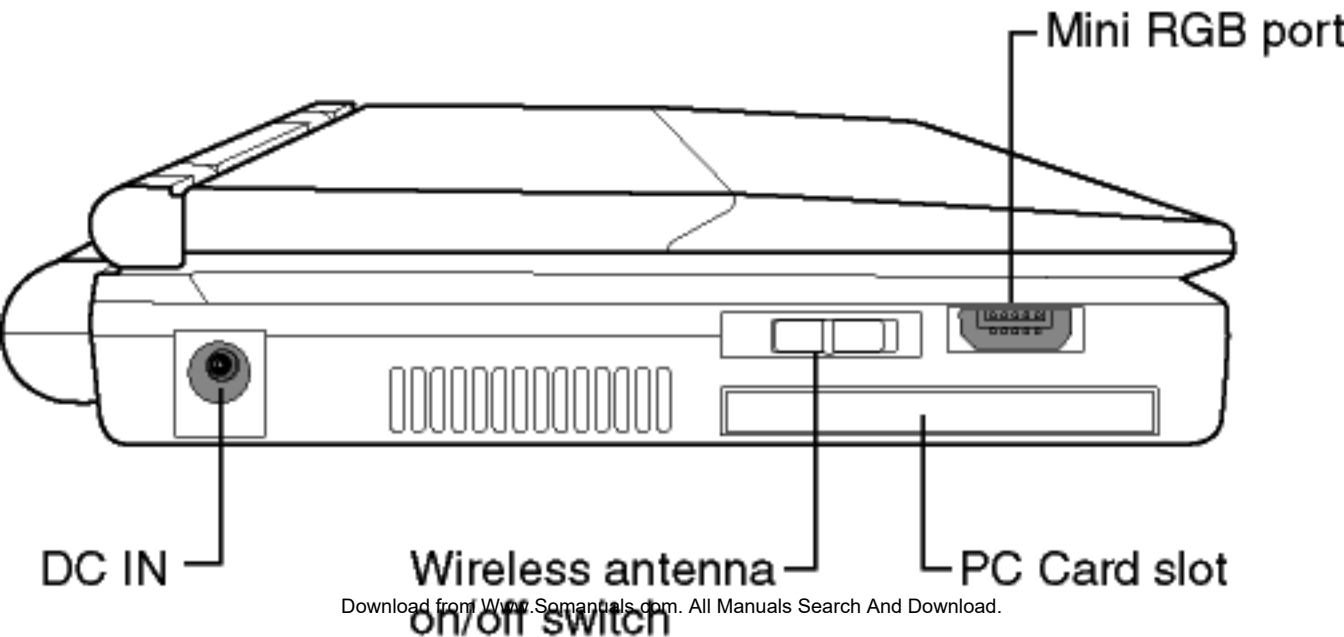

Right side

Volume control dial

USB ports

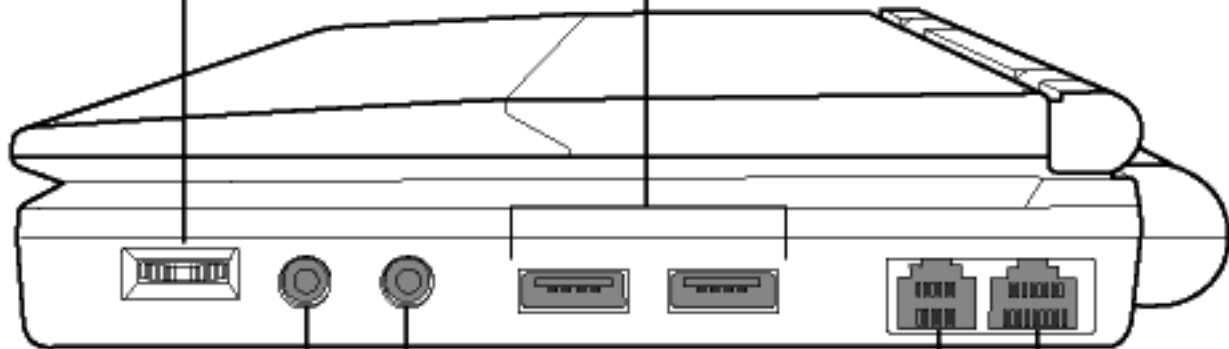

Headphone jack

Microphone jack

Modem port

Network port

Back

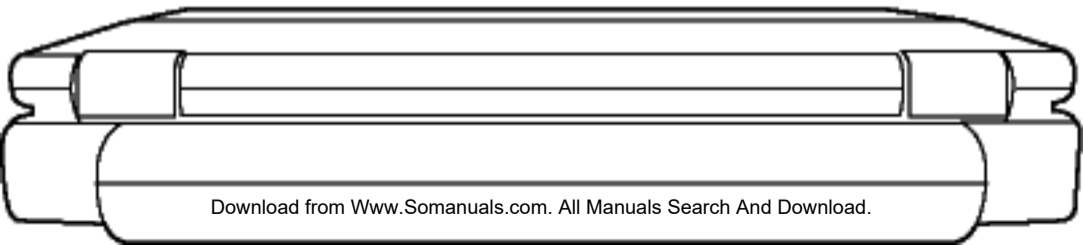

Download from [Www.Somanuals.com](http://www.Somanuals.com). All Manuals Search And Download.

Underside

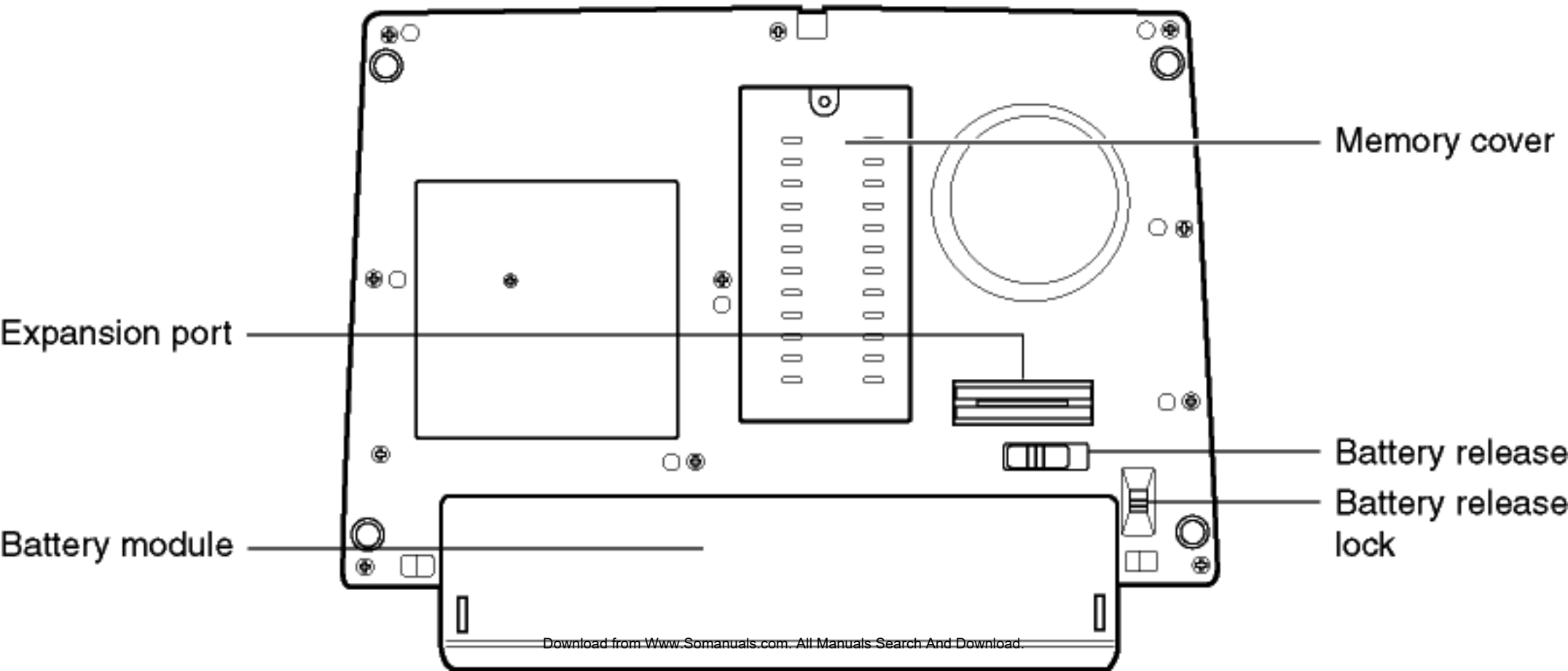

Free Manuals Download Website

<http://myh66.com>

<http://usermanuals.us>

<http://www.somanuals.com>

<http://www.4manuals.cc>

<http://www.manual-lib.com>

<http://www.404manual.com>

<http://www.luxmanual.com>

<http://aubethermostatmanual.com>

Golf course search by state

<http://golfingnear.com>

Email search by domain

<http://emailbydomain.com>

Auto manuals search

<http://auto.somanuals.com>

TV manuals search

<http://tv.somanuals.com>