

TOSHIBA

Leading Innovation >>>

User's Manual

**TECRA A10/S10/P10/M10/
Satellite S300L/
Satellite Pro S300/S300L
Series**

Table of Contents

Copyright.....	vi
Disclaimer.....	vi
Trademarks.....	vi
FCC information.....	vii
EU Conformity Statement.....	viii
VCCI Class B Information.....	viii
Modem warning notice.....	viii
Japan regulations.....	ix
Instructions for IC CS-03 certified equipment.....	xii
Notes for Users in Australia and New Zealand.....	xiii
Following information is only valid for EU-member States:.....	xvi
Disposing of the computer and the computer's batteries.....	xvi
Optical disc drive safety instructions.....	xvii
International precautions.....	xxi

Preface

Conventions.....	xxiii
------------------	-------

General Precautions

Provide adequate ventilation.....	xxvi
Creating a computer-friendly environment.....	xxvii
Stress injury.....	xxvii
Heat injury.....	xxvii
Pressure or impact damage.....	xxviii
PC Card overheating.....	xxviii
Mobile phones.....	xxviii
Instruction Manual for Safety and Comfort.....	xxviii

Chapter 1 Getting Started

Equipment checklist.....	1-1
Getting Started.....	1-3
System Recovery Options.....	1-12
System Recovery.....	1-13

Chapter 2	The Grand Tour	
	Front with the display closed	2-1
	Left side	2-2
	Right side	2-4
	Back	2-6
	Underside	2-7
	Front with the display open	2-9
	Indicators	2-12
	Optical disc drives	2-14
	AC adaptor	2-17
Chapter 3	Hardware, Utilities and Options	
	Hardware	3-1
	Special features	3-6
	TOSHIBA Value Added Package	3-10
	Utilities and Applications	3-11
	Optional devices	3-16
	Bridge media slot	3-22
	Optional accessories	3-39
Chapter 4	Operating Basics	
	TOSHIBA Dual Pointing Device	4-1
	Using the Fingerprint Sensor	4-3
	Web Camera	4-10
	Using the TOSHIBA Face Recognition	4-11
	Using optical disc drives	4-14
	Writing CDs on DVD-ROM&CD-R/RW drives	4-18
	Writing CD/DVDs on DVD Super Multi drives	4-20
	Media care	4-26
	Sound System	4-27
	Modem	4-30
	Wireless communications	4-33
	LAN	4-37
	Computer Handling	4-39
	Using the Hard Disk Drive (HDD) Protection	4-40
	Using the TOSHIBA USB Sleep and Charge Utility	4-42
	Heat dispersal	4-44
Chapter 5	The Keyboard	
	Typewriter keys	5-1
	Function keys: F1 ... F12	5-2
	Soft keys: FN key combinations	5-2
	Hot keys	5-3
	Windows special keys	5-5
	Keypad overlay	5-6
	Generating ASCII characters	5-7

<i>Chapter 6</i>	Power and Power-Up Modes	
	Power conditions	6-1
	Monitoring of power condition	6-2
	Battery	6-3
	TOSHIBA Password Utility.	6-10
	Power-up modes.	6-13
	Panel power on/off	6-13
	System automatic Sleep/Hibernation	6-13
<i>Chapter 7</i>	HW Setup	
	Accessing HW Setup	7-1
	HW Setup window	7-1
<i>Chapter 8</i>	Troubleshooting	
	Problem solving process.	8-1
	Hardware and system checklist	8-3
	TOSHIBA support.	8-29
<i>Appendix A</i>	Specifications	
	Physical Dimensions	A-1
	Environmental Requirements	A-1
<i>Appendix B</i>	Display Controller and Video mode	
	Display controller	B-1
	Video mode	B-1
<i>Appendix C</i>	Wireless LAN	
	Card Specifications	C-1
	Radio Characteristics.	C-2
	Supported Frequency Sub-bands.	C-3
<i>Appendix D</i>	Bluetooth wireless technology Interoperability	
	Bluetooth wireless technology and your Health	D-2
	Regulatory statements	D-2
	Using Bluetooth Adaptor from TOSHIBA equipment in Japan	D-4
<i>Appendix E</i>	AC Power Cord and Connectors	
	Certification agencies	E-1
<i>Appendix F</i>	TOSHIBA Anti-theft Protection Timer	
<i>Appendix G</i>	TOSHIBA PC Health Monitor	
	Starting the TOSHIBA PC Health Monitor.	G-2
	If a TOSHIBA PC Health Monitor message is displayed.	G-2
	Cleaning the cooling module	G-3
<i>Appendix H</i>	Legal Footnotes	
	Non-applicable Icons*1	H-1
	CPU*2.	H-1
	Memory (Main System)*3.	H-2

Battery Life *4	H-3
Hard Disk Drive (HDD) Capacity *5	H-3
LCD *6.....	H-3
Graphics Processor Unit ("GPU") *7	H-3
Wireless LAN *8.....	H-4
Copy Protection *9	H-4
Images *10	H-4

Glossary

Index

Copyright

© 2009 by TOSHIBA Corporation. All rights reserved. Under the copyright laws, this manual cannot be reproduced in any form without the prior written permission of TOSHIBA. No patent liability is assumed, with respect to the use of the information contained herein.

TOSHIBA TECRA A10/S10/P10/M10/Satellite S300L/Satellite Pro S300/S300L Portable Personal Computer User's Manual

First edition July 2009

Copyright authority for music, movies, computer programs, databases and other intellectual property covered by copyright laws belongs to the author or to the copyright owner. Copyrighted material can be reproduced only for personal use or use within the home. Any other use beyond that stipulated above (including conversion to digital format, alteration, transfer of copied material and distribution on a network) without the permission of the copyright owner is a violation of copyright or author's rights and is subject to civil damages or criminal action. Please comply with copyright laws in making any reproduction from this manual.

Disclaimer

This manual has been validated and reviewed for accuracy. The instructions and descriptions it contains are accurate for the TOSHIBA TECRA A10/S10/P10/M10/Satellite S300L/Satellite Pro S300/S300L Portable Personal Computer at the time of this manual's production. However, succeeding computers and manuals are subject to change without notice. TOSHIBA assumes no liability for damages incurred directly or indirectly from errors, omissions or discrepancies between the computer and the manual.

Trademarks

IBM is a registered trademark and IBM PC is a trademark of International Business Machines Corporation.

Intel, Intel SpeedStep, Intel Core and Centrino are trademarks or registered trademarks of Intel Corporation.

Windows, Microsoft and Windows logo are registered trademarks of Microsoft Corporation.

Bluetooth is a trademark owned by its proprietor and used by TOSHIBA under license.

Photo CD is a trademark of Eastman Kodak Company.

Memory Stick, Memory Stick PRO, Memory Stick PRO Duo and i.LINK are trademarks or registered trademarks of Sony Corporation.

ConfigFree is a trademark of Toshiba Corporation.

Wi-Fi is a registered trademark of the Wi-Fi Alliance.

Secure Digital and SD are trademarks of SD Card Association.

MultiMediaCard and MMC are trademarks of MultiMediaCard Association.
xD-Picture Card is a trademark of FUJIFILM Corporation.
Other trademarks and registered trademarks not listed above may be used in this manual.

FCC information

FCC notice "Declaration of Conformity Information"

This equipment has been tested and found to comply with the limits for a Class B digital device, pursuant to part 15 of the FCC rules. These limits are designed to provide reasonable protection against harmful interference in a residential installation. This equipment generates, uses and can radiate radio frequency energy and, if not installed and used in accordance with the instructions, may cause harmful interference to radio communications. However, there is no guarantee that interference will not occur in a particular installation. If this equipment does cause harmful interference to radio or television reception, which can be determined by turning the equipment off and on, the user is encouraged to try to correct the interference by one or more of the following measures:

- Reorient or relocate the receiving antenna.
- Increase the separation between the equipment and receiver.
- Connect the equipment into an outlet on a circuit different from that to which the receiver is connected.
- Consult the dealer or an experienced radio/TV technician for help.



Only peripherals complying with the FCC class B limits may be attached to this equipment. Operation with non-compliant peripherals or peripherals not recommended by TOSHIBA is likely to result in interference to radio and TV reception. Shielded cables must be used between the external devices and the computer's external monitor port, Universal Serial Bus (USB 2.0) ports, eSATA/USB combo port, i.LINK® (IEEE1394) port, serial port and microphone jack. Changes or modifications made to this equipment, not expressly approved by TOSHIBA or parties authorized by TOSHIBA could void the user's authority to operate the equipment.

FCC conditions

This device complies with part 15 of the FCC Rules. Operation is subject to the following two conditions:

1. This device may not cause harmful interference.
2. This device must accept any interference received, including interference that may cause undesired operation.

Contact

Address: TOSHIBA America Information Systems, Inc.
9740 Irvine Boulevard
Irvine, California 92618-1697

Telephone: (949) 583-3000

EU Conformity Statement



This product and - if applicable - the supplied accessories too are marked with "CE" and comply therefore with the applicable harmonized European standards listed under the Low Voltage Directive 2006/95/EC, the EMC Directive 2004/108/EC and/or R&TTE Directive 1999/5/EC.

Responsible for CE-marking: TOSHIBA EUROPE GMBH, Hammfelddamm 8, 41460 Neuss, Germany.

Manufacturer: Toshiba Corporation, 1-1 Shibaura 1-chome, Minato-ku, Tokyo, 105-8001, Japan

The complete official EU CE Declaration can be obtained on following internet page:

<http://epps.toshiba-teg.com/>

VCCI Class B Information

この装置は、クラスB情報技術装置です。この装置は、家庭環境で使用することを目的としていますが、この装置がラジオやテレビジョン受信機に近接して使用されると、受信障害を引き起こすことがあります。取扱説明書に従って正しい取り扱いをしてください。

VCCI-B

Modem warning notice



This information is applicable to the models equipped with a built-in modem.

Conformity Statement

The equipment has been approved to [Commission Decision "CTR21"] for pan-European single terminal connection to the Public Switched Telephone Network (PSTN).

However, due to differences between the individual PSTNs provided in different countries/regions the approval does not, of itself, give an unconditional assurance of successful operation on every PSTN network termination point.

In the event of problems, you should contact your equipment supplier in the first instance.

Network Compatibility Statement

This product is designed to work with, and is compatible with the following networks. It has been tested to and found to conform with the additional requirements conditional in EG 201 121.

Germany	ATAAB AN005,AN006,AN007,AN009,AN010 and DE03,04,05,08,09,12,14,17
Greece	ATAAB AN005,AN006 and GR01,02,03,04
Portugal	ATAAB AN001,005,006,007,011 and P03,04,08,10
Spain	ATAAB AN005,007,012, and ES01
Switzerland	ATAAB AN002
All other countries/regions	ATAAB AN003,004

Specific switch settings or software setup are required for each network, please refer to the relevant sections of the user guide for more details.

The hookflash (timed break register recall) function is subject to separate national type approvals. It has not been tested for conformity to national type regulations, and no guarantee of successful operation of that specific function on specific national networks can be given.

Japan regulations

Region selection

If you are using the computer in Japan, technical regulations described in the Telecommunications Business Law require that you select the Japan region mode. It is illegal to use the modem in Japan with any other selection.

Redial

Up to two redial attempts can be made. If more than two redial attempts are made, the modem will return **Black Listed**. If you are experiencing problems with the Black Listed code, set the interval between redials at one minute or longer.

Japan's Telecommunications Business Law permits up to two redials on analogue telephones, but the redials must be made within a total of three minutes.

The internal modem is approved by Japan Approvals Institute for Telecommunications Equipment.

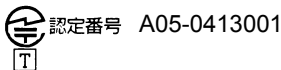

This label is located on the module.

Agere Delphi D40 Agere System Inc. Chile approval No.3785 Morocco : 25142005 Askey Technology(Jiang Su) Ltd. US:AGSMD01BDELPHI IC:4005B-DELPHI REN:0.1 TECWRN/IMOD-08/02/122.MAY 07 Date of approval:31st.May.2007 Delphi D40 AMS Made In China	MODEL APPROVED BY طراز معتمد من UAE LAB مختبر الامارات للاتصالات EMIRATES TELECOM LAB ETISALAT PERMIT NO: E05/01/254/G
EQUIPO HOMOLOGADO POR ANTEL N° de aprob : MC-106 Fecha : fecha 29 de agosto 2005 Empr es a : Agere System Inc	MIC ASI-DELPHI-D40 A05-0413001 CCAC07M1001076
13132 1119 1310101 313 010 03090023 11 10701 1001 1001 0211 AGERE SYSTEMS 11721 112101 010101 010101 010101 010101 1121010101010101 1100 1101 1101 1101010101010101 110101 010101 010101	
04604/POSTEL/2007 1911 NYCE/CT/0003/07/TS Cofetel n°: TTDAGDE07-056	
Certified for use in Hong Kong 經驗證可在香港使用	N723
OFTA Certificate No.#SL405083 證書號碼 電話管理局	

(01) 0789 834989 0382	ANATEL 0455-05-2565 0455-05-2565
NTC Type Approved No.ESD-CPE-0500938	ICA SA TE-2008174 APPROVED
CCC SAE	CNG MODEM DELPHI D40 04-0681
TELEPERMIT This Agere Delphi D40 56k Modem may be connected to the Telecom Network PTC 2117 05 / 074	Approval by PTA,2007 E252909 Factory ID:AJ RIN-EU-5

Pursuant to FCC CFR 47, Part 68:

When you are ready to install or use the modem, call your local telephone company and give them the following information:

- The telephone number of the line to which you will connect the modem
 - The registration number that is located on the device
- The FCC registration number of the modem will be found on either the device which is to be installed, or, if already installed, on the bottom of the computer outside of the main system label.
- The Ringer Equivalence Number (REN) of the modem, which can vary. For the REN of your modem, refer to your modem's label.

The modem connects to the telephone line by means of a standard jack called the USOC RJ11C.

Type of service

Your modem is designed to be used on standard-device telephone lines. Connection to telephone company-provided coin service (central office implemented systems) is prohibited. Connection to party lines service is subject to state tariffs. If you have any questions about your telephone line, such as how many pieces of equipment you can connect to it, the telephone company will provide this information upon request.

Telephone company procedures

The goal of the telephone company is to provide you with the best service it can. In order to do this, it may occasionally be necessary for them to make changes in their equipment, operations, or procedures. If these changes might affect your service or the operation of your equipment, the telephone company will give you notice in writing to allow you to make any changes necessary to maintain uninterrupted service.

If problems arise

If any of your telephone equipment is not operating properly, you should immediately remove it from your telephone line, as it may cause harm to the telephone network. If the telephone company notes a problem, they may temporarily discontinue service. When practical, they will notify you in advance of this disconnection. If advance notice is not feasible, you will be notified as soon as possible. When you are notified, you will be given the opportunity to correct the problem and informed of your right to file a complaint with the FCC. In the event repairs are ever needed on your modem, they should be performed by TOSHIBA Corporation or an authorized representative of TOSHIBA Corporation.

Disconnection

If you should ever decide to permanently disconnect your modem from its present line, please call the telephone company and let them know of this change.

Fax branding

The Telephone Consumer Protection Act of 1991 makes it unlawful for any person to use a computer or other electronic device to send any message via a telephone fax machine unless such message clearly contains in a margin at the top or bottom of each transmitted page or on the first page of the transmission, the date and time it is sent and an identification of the business, other entity or individual sending the message and the telephone number of the sending machine or such business, other entity or individual. In order to program this information into your fax modem, you should complete the setup of your fax software before sending messages.



Use only No. 26AWG or larger modular cable.

Instructions for IC CS-03 certified equipment

1. The Industry Canada label identifies certified equipment. This certification means that the equipment meets certain telecommunications network protective, operational and safety requirements as prescribed in the appropriate Terminal Equipment Technical Requirements document(s). The Department does not guarantee the equipment will operate to the user's satisfaction.

Before installing this equipment, users should ensure that it is permissible to be connected to the facilities of the local telecommunications company. The equipment must also be installed using an acceptable method of connection.

The customer should be aware that compliance with the above conditions may not prevent degradation of service in some situations. Repairs to certified equipment should be coordinated by a representative designated by the supplier. Any repairs or alterations made by the user to this equipment, or equipment malfunctions, may give the telecommunications company cause to request the user to disconnect the equipment.

Users should ensure for their own protection that the electrical ground connections of the power utility, telephone lines and internal metallic water pipe systems, if present, are connected together. This precaution may be particularly important in rural areas.



Users should not attempt to make such connections themselves, but should contact the appropriate electric inspection authority, or electrician, as appropriate.

2. The user manual of analog equipment must contain the equipment's Ringer Equivalence Number (REN) and an explanation notice similar to the following:

The Ringer Equivalence Number (REN) of the modem, which can vary. For the REN of your modem, refer to your modem's label.



The Ringer Equivalence Number (REN) assigned to each terminal device provides an indication of the maximum number of terminals allowed to be connected to a telephone interface. The termination on an interface may consist of any combination of devices subject only to the requirement that the sum of the Ringer Equivalence Numbers of all the devices does not exceed 5.

3. The standard connecting arrangement (telephone jack type) for this equipment is jack type(s): USOC RJ11C.
The IC registration number of the modem is shown below.

Canada: 4005B-DELPHI

Notes for Users in Australia and New Zealand

Modem warning notice for Australia

Modems connected to the Australian telecoms network must have a valid Austel permit. This modem has been designed to specifically configure to ensure compliance with Austel standards when the country/region selection is set to Australia. The use of other country/region setting while the modem is attached to the Australian PSTN would result in you modem being operated in a non-compliant manner. To verify that the country/region is correctly set, enter the command ATI which displays the currently active setting.

To set the country/region permanently to Australia, enter the following command sequence:

```
AT%TE=1
ATS133=1
AT&F
AT&W
AT%TE=0
ATZ
```

Failure to set the modem to the Australia country/region setting as shown above will result in the modem being operated in a non-compliant manner. Consequently, there would be no permit in force for this equipment and the Telecoms Act 1991 prescribes a penalty of \$12,000 for the connection of non-permitted equipment.

Notes for use of this device in New Zealand

- The grant of a Telepermit for a device in no way indicates Telecom acceptance of responsibility for the correct operation of that device under all operating conditions. In particular the higher speeds at which this modem is capable of operating depend on a specific network implementation which is only one of many ways of delivering high quality voice telephony to customers. Failure to operate should not be reported as a fault to Telecom.
- In addition to satisfactory line conditions a modem can only work properly if:
 - a/ it is compatible with the modem at the other end of the call and.
 - b/ the application using the modem is compatible with the application at the other end of the call - e.g., accessing the Internet requires suitable software in addition to a modem.
- This equipment shall not be used in any manner which could constitute a nuisance to other Telecom customers.

- Some parameters required for compliance with Telecom's PTC Specifications are dependent on the equipment (PC) associated with this modem. The associated equipment shall be set to operate within the following limits for compliance with Telecom Specifications:
 - a/ There shall be no more than 10 call attempts to the same number within any 30 minute period for any single manual call initiation, and
 - b/ The equipment shall go on-hook for a period of not less than 30 seconds between the end of one attempt and the beginning of the next.
 - c/ Automatic calls to different numbers shall be not less than 5 seconds apart.
- Immediately disconnect this equipment should it become physically damaged, and arrange for its disposal or repair.
- The correct settings for use with this modem in New Zealand are as follows:
 - ATB0 (CCITT operation)
 - AT&G2 (1800 Hz guard tone)
 - AT&P1 (Decadic dialing make-break ratio =33%/67%)
 - ATS0=0 (not auto answer)
 - ATS6=4 (Blind dial delay)
 - ATS7=less than 90 (Time to wait to carrier after dialing)
 - ATS10=less than 150 (loss of carrier to hangup delay, factory default of 15 recommended)
 - ATS11=90 (DTMF dialing on/off duration=90 ms)
 - ATX2 (Dial tone detect, but not (U.S.A.) call progress detect)
- When used in the Auto Answer mode, the S0 register must be set with a value of 3 or 4. This ensures:
 - a person calling your modem will hear a short burst of ringing before the modem answers. This confirms that the call has been successfully switched through the network.
 - caller identification information (which occurs between the first and second ring cadences) is not destroyed.
- The preferred method of dialing is to use DTMF tones (ATDT...) as this is faster and more reliable than pulse (decadic) dialing. If for some reason you must use decadic dialing, your communications program must be set up to record numbers using the following translation table as this modem does not implement the New Zealand "Reverse Dialing" standard.
 - Number to be dialed: 0 1 2 3 4 5 6 7 8 9
 - Number to program into computer: 0 9 8 7 6 5 4 3 2 1
 - Note that where DTMF dialing is used, the numbers should be entered normally.

- The transmit level from this device is set at a fixed level and because of this there may be circumstances where the performance is less than optimal. Before reporting such occurrences as faults, please check the line with a standard Telepermitted telephone, and only report a fault if the phone performance is impaired.
- It is recommended that this equipment be disconnected from the Telecom line during electrical storms.
- When relocating the equipment, always disconnect the Telecom line connection before the power connection, and reconnect the power first.
- This equipment may not be compatible with Telecom Distinctive Alert cadences and services such as FaxAbility.

NOTE THAT FAULT CALLOUTS CAUSED BY ANY OF THE ABOVE CAUSES MAY INCUR A CHARGE FROM TELECOM

General conditions

As required by PTC 100, please ensure that this office is advised of any changes to the specifications of these products which might affect compliance with the relevant PTC Specifications.

The grant of this Telepermit is specific to the above products with the marketing description as stated on the Telepermit label artwork. The Telepermit may not be assigned to other parties or other products without Telecom approval.

A Telepermit artwork for each device is included from which you may prepare any number of Telepermit labels subject to the general instructions on format, size and color on the attached sheet.

The Telepermit label must be displayed on the product at all times as proof to purchasers and service personnel that the product is able to be legitimately connected to the Telecom network.

The Telepermit label may also be shown on the packaging of the product and in the sales literature, as required in PTC 100.

The charge for a Telepermit assessment is \$337.50. An additional charge of \$337.50 is payable where an assessment is based on reports against non-Telecom New Zealand Specifications. \$112.50 is charged for each variation when submitted at the same time as the original.

An invoice for \$NZ1237.50 will be sent under separate cover.

Following information is only valid for EU-member States:

Disposal of products



The crossed out wheeled dust bin symbol indicates that products must be collected and disposed of separately from household waste. Integrated batteries and accumulators can be disposed of with the product. They will be separated at the recycling centres.

The black bar indicates that the product was placed on the market after August 13, 2005.

By participating in separate collection of products and batteries, you will help to assure the proper disposal of products and batteries and thus help to prevent potential negative consequences for the environment and human health.

For more detailed information about the collection and recycling programmes available in your country, please visit our website (<http://eu.computers.toshiba-europe.com>) or contact your local city office or the shop where you purchased the product.

Disposal of batteries and/or accumulators



The crossed out wheeled dust bin symbol indicates that batteries and/or accumulators must be collected and disposed of separately from household waste.

If the battery or accumulator contains more than the specified values of lead (Pb), mercury (Hg), and/or cadmium (Cd) defined in the Battery Directive (2006/66/EC), then the chemical symbols for lead (Pb), mercury (Hg) and/or cadmium (Cd) will appear below the crossed out wheeled dust bin symbol.

By participating in separate collection of batteries, you will help to assure the proper disposal of products and batteries and thus help to prevent potential negative consequences for the environment and human health.

For more detailed information about the collection and recycling programmes available in your country, please visit our website (<http://eu.computers.toshiba-europe.com>) or contact your local city office or the shop where you purchased the product.



These symbols may not stick depending on the country and region where you purchased.

Disposing of the computer and the computer's batteries

- Discard this computer in accordance with applicable laws and regulations. For further information, contact your local government.
- This computer contains rechargeable batteries. After repeated use, the batteries will finally lose their ability to hold a charge and you will need to replace them. Under certain applicable laws and regulation, it may be illegal to dispose of old batteries by placing them in the trash.
- Please be kind to our shared environment. Check with your local government authority for details regarding where to recycle old batteries or how to dispose of them properly. This product contains mercury. Disposal of this material may be regulated due to environmental considerations. For disposal, reuse or recycling information, please contact your local government.

Optical disc drive safety instructions



Be sure to check the international precautions at the end of this section.

TEAC

DVD-ROM drive DV-28S



- *The DVD-ROM drive model employs a laser system. To ensure proper use of this product, please read this instruction manual carefully and retain for future reference. Should the unit ever require maintenance, contact an authorized service location.*
- *Use of controls, adjustments or the performance of procedures other than those specified may result in hazardous radiation exposure.*
- *To prevent direct exposure to the laser beam, do not try to open the enclosure.*

Location of the required label

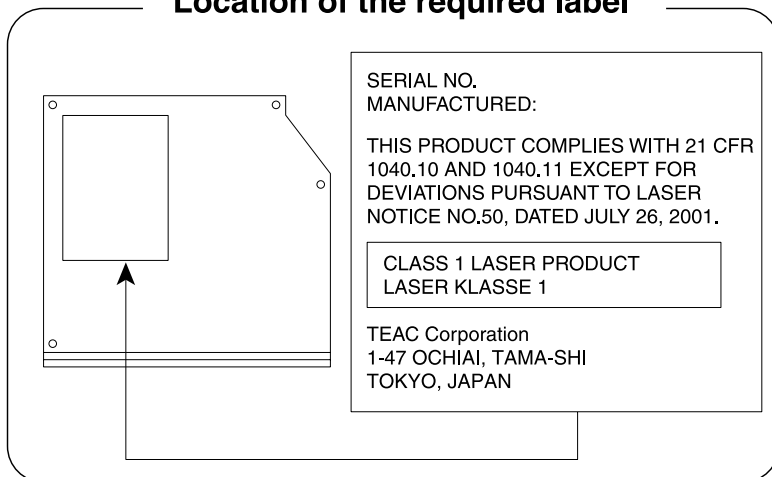

TEAC

DVD-ROM & CD-R/RW drive DW-224S



- *The DVD-ROM & CD-R/RW drive model employs a laser system. To ensure proper use of this product, please read this instruction manual carefully and retain for future reference. Should the unit ever require maintenance, contact an authorized service location.*
- *Use of controls, adjustments or the performance of procedures other than those specified may result in hazardous radiation exposure.*
- *To prevent direct exposure to the laser beam, do not try to open the enclosure.*

Location of the required label

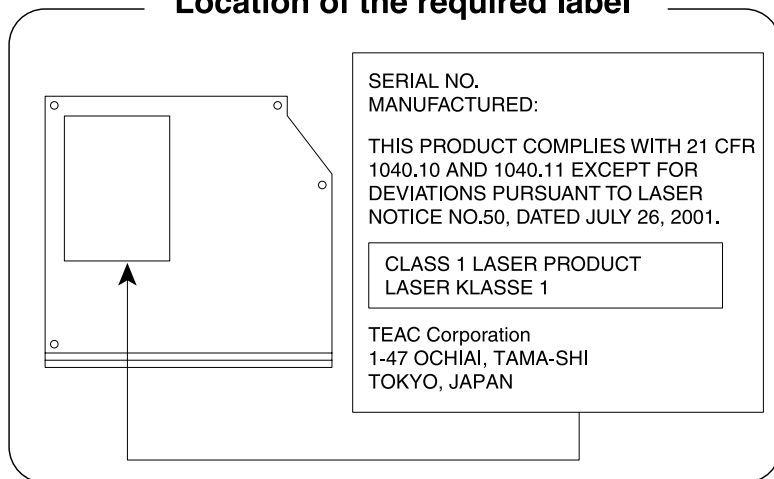

TEAC**DVD Super Multi with Double Layer Recording DV-W28S**

- *The DVD Super Multi drive model employs a laser system. To ensure proper use of this product, please read this instruction manual carefully and retain for future reference. Should the unit ever require maintenance, contact an authorized service location.*
- *Use of controls, adjustments or the performance of procedures other than those specified may result in hazardous radiation exposure.*
- *To prevent direct exposure to the laser beam, do not try to open the enclosure.*

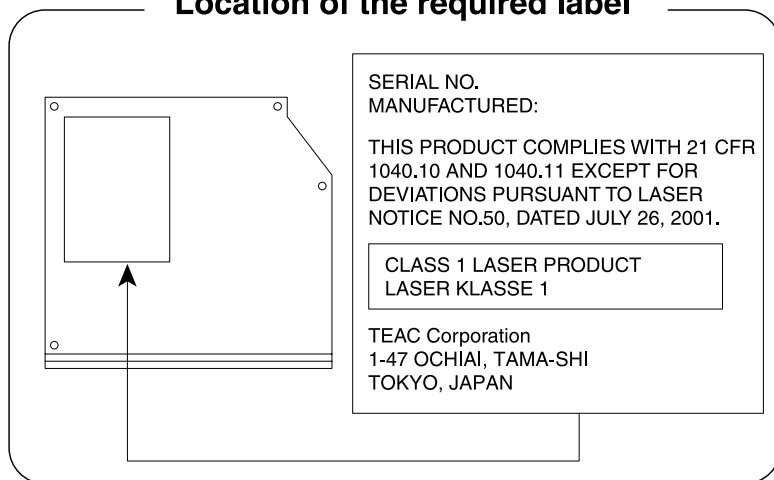
Location of the required label

Panasonic Communications

DVD Super Multi with Double Layer Recording UJ870/UJ880



- *The DVD Super Multi drive model employs a laser system. To ensure proper use of this product, please read this instruction manual carefully and retain for future reference. Should the unit ever require maintenance, contact an authorized service location.*
- *Use of controls, adjustments or the performance of procedures other than those specified may result in hazardous radiation exposure.*
- *To prevent direct exposure to the laser beam, do not try to open the enclosure.*

Location of the required label

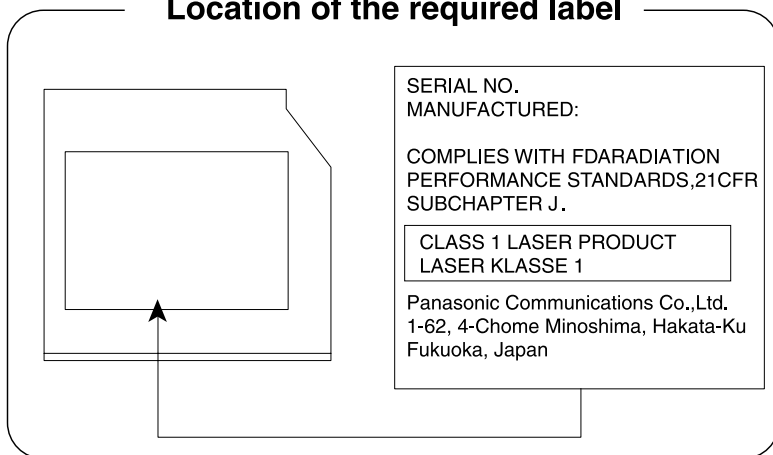

International precautions

CLASS 1 LASER PRODUCT
LASER KLASSE 1 PRODUKT
TO EN 60825-1
クラス1 レーザ 製品

CAUTION: *This appliance contains a laser system and is classified as a "CLASS 1 LASER PRODUCT." To use this model properly, read the instruction manual carefully and keep this manual for your future reference. In case of any trouble with this model, please contact your nearest "AUTHORIZED service station." To prevent direct exposure to the laser beam, do not try to open the enclosure.*

CLASS 1 LASER PRODUCT
LASERSCHUTZKLASSE 1
PRODUKT
TOEN60825-1

VORSICHT: *Dieses Gerät enthält ein Laser-System und ist als "LASERSCHUTZKLASSE 1 PRODUKT" klassifiziert. Für den richtigen Gebrauch dieses Modells lesen Sie bitte die Bedienungsanleitung sorgfältig durch und bewahren diese bitte als Referenz auf. Falls Probleme mit diesem Modell auftreten, benachrichtigen Sie bitte die nächste "autorisierte Service-Vertretung". Um einen direkten Kontakt mit dem Laserstrahl zu vermeiden darf das Gerät nicht geöffnet werden.*

ADVERSEL:USYNLIG
LASERSTRÅLING VED
ÅBNING, NÅR
SIKKERHEDSAF-BRYDER
ER UDE AF FUNKTION.
UNDGÅ UDSÆTTSELSE
FOR STRÅLING

ADVARSEL: *Denne mærkning er anbragt udvendigt på apparatet og indikerer, at apparatet arbejder med laserstråler af klasse 1, hvilket betyder, at der anvendes laserstråler af svageste klasse, og at man ikke på apparatets yderside kan bilve udsat for utilladelig kraftig stråling.*

**APPARATET BOR KUN ÅBNES AF
FAGFOLK MED SÆRLIGT KENDSKAB
TIL APPARATER MED
LASERSTRÅLER!**

Indvendigt i apparatet er anbragt den her gengivne advarselmærkning, som advarer imod at foretage sådanne indgreb i apparatet, at man kan komme til at udsatte sig for laserstråling.

OBS! Apparaten innehåller laserkomponent som avger laserstråling överstigande gränsen för laserklass 1.

VAROITUS. Suojakoteloä si saa avata. Laite sisältää laseriodin, joka lähettää näkymätöntä silmille vaarallista lasersäteilyä.

CAUTION: USE OF CONTROLS OR ADJUSTMENTS OR PERFORMANCE OF PROCEDURES OTHER THAN THOSE SPECIFIED IN THE OWNER'S MANUAL MAY RESULT IN HAZARDOUS RADIATION EXPOSURE.

VORSICHT: DIE VERWENDUNG VON ANDEREN STEURUNGEN ODER EINSTELLUNGEN ODER DAS DURCHFÜHREN VON ANDEREN VORGÄNGEN ALS IN DER BEDIENUNGSANLEITUNG BESCHRIEBEN KÖNNEN GEFÄHRLICHE STRAHLENEXPOSITIONEN ZUR FOLGE HABEN.

Preface

Congratulations on your purchase of the TECRA A10/S10/P10/M10/Satellite S300L/Satellite Pro S300/S300L Series computer. This powerful notebook computer provides excellent expansion capability, includes multimedia functionality, and is designed to provide years of reliable, high-performance computing.

This manual tells how to set up and begin using your TECRA A10/S10/P10/M10/Satellite S300L/Satellite Pro S300/S300L computer. It also provides detailed information on configuring your computer, basic operations and care, using optional devices and troubleshooting.

If you are a new user of computers or if you're new to portable computing, first read over the Chapter 1, *Getting Started* and Chapter 3, *Hardware, Utilities and Options* chapters to familiarize yourself with the computer's features, components and accessory devices. Then read Chapter 1, *Getting Started* for step-by-step instructions on setting up your computer.

If you are an experienced computer user, please continue reading the preface to learn how this manual is organized, then become acquainted with this manual by browsing through its pages. Be sure to read the *Special features* section in Chapter 3, *Hardware, Utilities and Options* to learn about features that are uncommon or unique to this computer, as well as the section on Chapter 7, *HW Setup*, to understand how to setup and configure these features.

Read Chapter 3, *Hardware, Utilities and Options* if connecting optional products or external devices.

Conventions

This manual uses the following formats to describe, identify, and highlight terms and operating procedures.

Abbreviations

On first appearance, and whenever necessary for clarity, abbreviations are enclosed in parentheses following their definition. For example: Read Only Memory (ROM). Acronyms are also defined in the Glossary.

Icons

Icons identify ports, dials, and other parts of your computer. The indicator panel also uses icons to identify the components it is providing information on.

Keys

The keyboard keys are used in the text to describe many computer operations. A distinctive typeface identifies the key top symbols as they appear on the keyboard. For example, **ENTER** identifies the **ENTER** key.

Key operation

Some operations require you to simultaneously use two or more keys. We identify such operations by the key top symbols separated by a plus sign (+). For example, **CTRL + C** means you must hold down **CTRL** and at the same time press **C**. If three keys are used, hold down the first two and at the same time press the third.

ABC

When procedures require an action such as clicking an icon or entering text, the icon's name or the text you are to type in is represented in the typeface you see to the left.

Display



ABC

Names of windows or icons or text generated by the computer that appear on its display screen are presented in the type face you see to the left.

Messages

Messages are used in this manual to bring important information to your attention. Each type of message is identified as shown below.



Pay attention! A caution informs you that improper use of equipment or failure to follow instructions may cause data loss or damage your equipment.



Please read. A note is a hint or advice that helps you make best use of your equipment.



Indicates a potentially hazardous situation, which could result in death or serious injury, if you do not follow instructions.

Terminology

This term is defined in this document as follows:

- Start** The word "**Start**" refers to the "" button in Windows 7.
- HDD or Hard disk drive** Some models are equipped with a "Solid State Drive (SSD)" instead of a hard disk drive. In this manual, the word "HDD" or "Hard disk drive" also refers to the SSD unless otherwise stated.

General Precautions

TOSHIBA computers are designed to optimize safety, minimize strain and withstand the rigors of portability. However, certain precautions should be observed to further reduce the risk of personal injury or damage to the computer.

Be certain to read the general precautions below and to note the cautions included in the text of the manual.

Provide adequate ventilation

- Always make sure your computer and AC adaptor have adequate ventilation and are protected from overheating when the power is turned on or when an AC adaptor is connected to a power outlet (even if your computer is in Sleep Mode). In this condition, observe the following:
 - Never cover your computer or AC adaptor with any object.
 - Never place your computer or AC adaptor near a heat source, such as an electric blanket or heater.
 - Never cover or block the air vents including those located at the base of the computer.
 - Always operate your computer on a hard flat surface. Using your computer on a carpet or other soft material can block the vents.
- Always provide sufficient space around the computer.
- Overheating your computer or AC adaptor could cause system failure, computer or AC adaptor damage or a fire, possibly resulting in serious injury.

Creating a computer-friendly environment

Place the computer on a flat surface that is large enough for the computer and any other items you are using, such as a printer.

Leave enough space around the computer and other equipment to provide adequate ventilation. Otherwise, they may overheat.

To keep your computer in prime operating condition, protect your work area from:

- Dust, moisture, and direct sunlight.
- Equipment that generates a strong electromagnetic field, such as stereo speakers (other than speakers that are connected to the computer) or speakerphones.
- Rapid changes in temperature or humidity and sources of temperature change such as air conditioner vents or heaters.
- Extreme heat, cold, or humidity.
- Liquids and corrosive chemicals.

Stress injury

Carefully read the *Instruction Manual for Safety and Comfort*. It contains information on the prevention of stress injuries to your hands and wrists that can be caused by extensive keyboard use. *Instruction Manual for Safety and Comfort* also includes information on work space design, posture and lighting that can help reduce physical stress.

Heat injury

- Avoid prolonged physical contact with the computer. If the computer is used for long periods, its surface can become very warm. While the temperature will not feel hot to the touch, if you maintain physical contact with the computer for a long time, for example if you rest the computer on your lap or if you keep your hands on the palm rest, your skin might suffer a low-heat injury.
- If the computer has been used for a long time, avoid direct contact with the metal plate supporting the various interface ports as this can become hot.
- The surface of the AC adaptor can become hot when in use but this condition does not indicate a malfunction. If you need to transport the AC adaptor, you should disconnect it and let it cool before moving it.
- Do not lay the AC adaptor on a material that is sensitive to heat as the material could become damaged.

Pressure or impact damage

Do not apply heavy pressure to the computer or subject it to any form of strong impact as this can damage the computer's components or otherwise cause it to malfunction.

PC Card overheating

Some PC Cards can become hot during prolonged use which may result in errors or instability in the operation of the device in question. In addition, you should also be careful when you remove a PC Card that has been used for a long time.

Mobile phones

Please be aware that the use of mobile phones can interfere with the audio system. The operation of the computer will not be impaired in any way, but it is recommended that a minimum distance of 30cm is maintained between the computer and a mobile phone that is in use.

Instruction Manual for Safety and Comfort

All important information on the safe and proper use of this computer is described in the enclosed Instruction Manual for Safety and Comfort. Be sure to read it before using the computer.

Chapter 1

Getting Started

This chapter provides an equipment checklist, and basic information to start using your computer.



Some of the features described in this manual may not function properly if you use an operating system that was not pre-installed by TOSHIBA.

Equipment checklist

Carefully unpack your computer, taking care to save the box and packaging materials for future use.

Hardware

Check to make sure you have all the following items:

- TECRA A10/S10/P10/M10/Satellite S300L/Satellite Pro S300/S300L Portable Personal Computer
- AC adaptor and power cord (2-pin plug or 3-pin plug)
- Battery pack
- Spare AccuPoint (pointing device) cap (Is included with some models)

Documentation

- TECRA A10/S10/P10/M10/Satellite S300L/Satellite Pro S300/S300L Series User Information Guide
- Instruction Manual for Safety and Comfort
- End User License Agreement

If any of the items are missing or damaged, contact your dealer immediately.

Software

The following Windows® operating system and utility software are pre-installed.

- Windows 7
- TOSHIBA Value Added Package
- TOSHIBA Recovery Media Creator
- TOSHIBA DVD Player
- TOSHIBA SD Memory Utilities
- TOSHIBA SD Memory Boot Utility
- TOSHIBA Assist
- TOSHIBA ConfigFree™
- TOSHIBA HDD Protection
- TOSHIBA Disc Creator
- TOSHIBA Face Recognition (Is preinstalled in some models)
- TOSHIBA eco Utility
- Fingerprint Utility
- Windows Mobility Center
- Online Manual
 - TECRA A10/S10/P10/M10/Satellite S300L/Satellite Pro S300/S300L User's Manual (This manual)

Getting Started



- *All users should be sure to read the section [Starting up for the first time](#).*
- *Be sure to read the enclosed [Instruction Manual for Safety and Comfort](#) for information on the safe and proper use of this computer. It is intended to help you be more comfortable and productive while using a notebook computer. By following the recommendations in it you may reduce your chance of developing a painful or disabling injury to your hand, arms, shoulders or neck.*

This section provides basic information to start using your computer. It covers the following topics:

- Connecting the AC adaptor
- Opening the display
- Turning on the power
- Starting up for the first time
- Turning off the power
- Restarting the computer
- System Recovery Options
- Creating Recovery Media
- Restoring the pre-installed software from the Recovery hard disk drive
- Restoring the pre-installed software from your created Recovery Media



- *Use a virus-check program and make sure it is updated regularly.*
- *Never format storage media without checking its content - formatting destroys all stored data.*
- *It is a good idea to periodically back up the internal hard disk drive or other main storage device to external media. General storage media is not durable or stable over long periods of time and under certain conditions may result in data loss.*
- *Before you install a device or application, save any data in memory to the hard disk drive or other storage media. Failure to do so may result in the loss of data.*

Connecting the AC adaptor

Attach the AC adaptor when you need to charge the battery or you want to operate from AC power. It is also the fastest way to get started, because the battery pack will need to be charged before you can operate from battery power.

The AC adaptor can be connected to any power source supplying from 100 to 240 volts and 50 or 60 hertz. For details on using the AC adaptor to charge the battery pack, refer to Chapter 6, *Power and Power-Up Modes*.



- *Always use the TOSHIBA AC adaptor that was included with your computer, or use AC adaptors specified by TOSHIBA to avoid any risk of fire or other damage to the computer. Use of an incompatible AC adaptor could cause fire or damage to the computer possibly resulting in serious injury. TOSHIBA assumes no liability for any damage caused by use of an incompatible adaptor.*
- *Never plug the AC adaptor into a power source that does not correspond to both the voltage and the frequency specified on the regulatory label of the unit. Failure to do so could result in a fire or electric shock, possibly resulting in serious injury.*
- *Always use or purchase power cables that comply with the legal voltage and frequency specifications and requirements in the country of use. Failure to do so could result in a fire or electric shock, possibly resulting in serious injury.*
- *The supplied power cord conforms to safety rules and regulations in the region the product is bought and should not be used outside this region. For use in other regions, please buy power cords that conform to safety rules and regulations in the particular region.*
- *Do not use a 3-pin to 2-pin conversion plug.*
- *When you connect the AC adaptor to the computer, always follow the steps in the exact order as described in the User's Manual. Connecting the power cable to a live electrical outlet should be the last step otherwise the adaptor DC output plug could hold an electrical charge and cause an electrical shock or minor bodily injury when touched. As a general safety precaution, avoid touching any metal parts.*
- *Never place your computer or AC adaptor on a wooden surface, furniture, or any other surface that could be marred by exposure to heat since the computer base and AC adaptor's surface increase in temperature during normal use.*
- *Always place your computer or AC adaptor on a flat and hard surface that is resistant to heat damage.*

Refer to the enclosed Instruction Manual for Safety and Comfort for detailed precautions and handling instructions.

1. Connect the power cord to the AC adaptor.

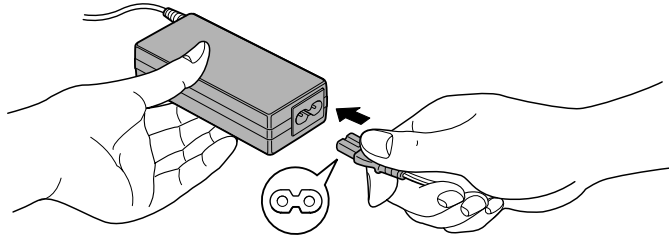

Figure 1-1 Connecting the power cord to the AC adaptor (2-pin plug)

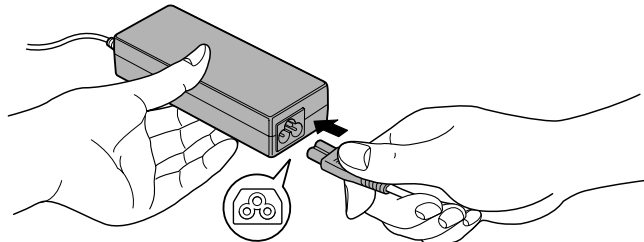

Figure 1-2 Connecting the power cord to the AC adaptor (3-pin plug)



Either a 2-pin or 3-pin adaptor/cord will be included with the computer depending on the model.

2. Connect the AC adaptor's DC output plug to the DC IN 15V jack on the back of the computer.

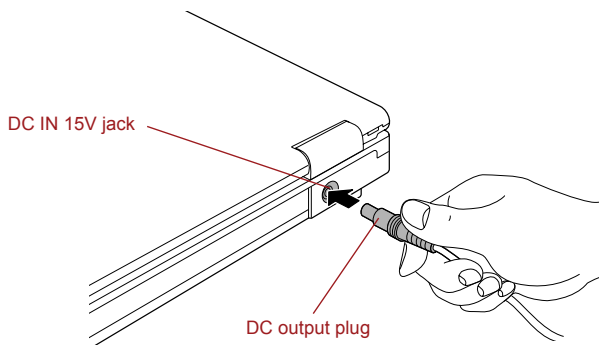

Figure 1-3 Connecting the DC output plug to the computer

3. Plug the power cord into a live wall outlet - the **Battery** and **DC IN** indicators on the front of the computer should glow.

Opening the display

The display panel can be opened to a wide range of angles for optimal viewing.

While holding down the palm rest with one hand so that the main body of the computer is not raised, slowly lift the display panel - this will allow the angle of the display panel to be adjusted to provide optimum clarity.

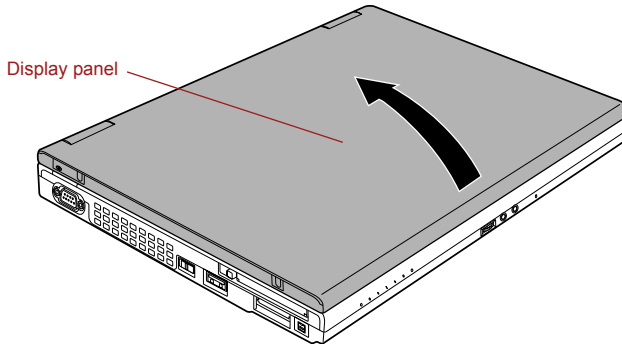

Figure 1-4 Opening the display panel



Use reasonable care when opening and closing the display panel. Opening it vigorously or slamming it shut could damage the computer.



- *Be careful not to open the display panel too far as this could put stress on the display panel's hinges and cause damage.*
- *Do not press or push on the display panel.*
- *Do not lift the computer by the display panel.*
- *Do not close the display panel with pens or any other objects left in between the display panel and the keyboard.*
- *When opening or closing the display panel, place one hand on the palm rest to hold the computer in place and use the other hand to slowly open or close the display panel (Do not use excessive force when opening or closing the display panel).*

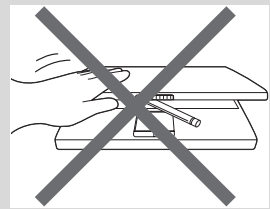
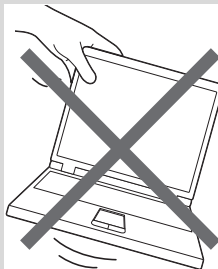
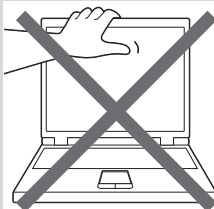

Turning on the power

This section describes how to turn on the power - the **Power** indicator will then indicate the status. Please refer to the [Monitoring of power condition](#) section in Chapter 6, Power and Power-Up Modes for more information.



- After you turn on the power for the first time, do not turn it off until you have set up the operating system. Please refer to the section [Starting up for the first time](#) for more information.
- Volume cannot be adjusted during Windows Setup.

1. Open the display panel.
2. Press and hold the computer's power button for two or three seconds.

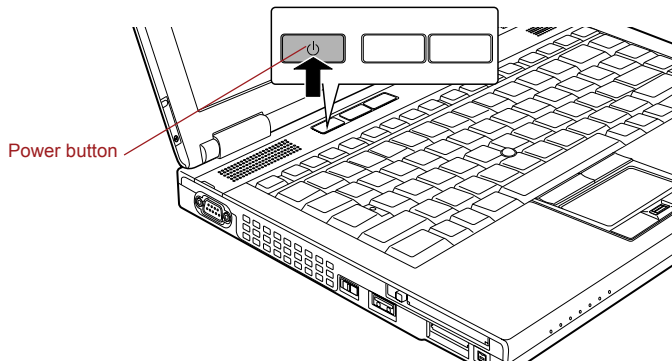

Figure 1-5 Turning on the power

Starting up for the first time

The Windows 7 Startup Screen will be the first screen displayed when you turn on the power. Follow the on-screen instructions on each screen in order to properly install the operating system.



*When it is displayed, be sure to read the **Software License Terms** carefully.*

Turning off the power

The power can be turned off in one of three modes, either Shut Down Mode, Hibernation Mode or Sleep Mode.

Shut Down Mode

When you turn off the power in Shut Down Mode no data will be saved and the computer will boot to the operating system's main screen the next time it is turned on.

1. If you have entered data, either save it to the hard disk drive or to other storage media.
2. Make sure all disk/disc activity has stopped before removing the CD/DVD or floppy diskette.



- **Make sure the Hard Disk Drive/Optical Disc Drive indicators are off.** If you turn off the power while a disk (disc) is being accessed, you may lose data or damage the disk.
- **Never turn off the power while an application is running.** Doing so could cause loss of data.
- **Never turn off the power, disconnect an external storage device or remove storage media during data read/write.** Doing so can cause data loss.

3. Click **Start**.

4. Click the **Shut down** button ().

5. Turn off any peripheral devices connected to your computer.



Do not turn the computer or peripheral devices back on immediately - wait a short period to avoid any potential damage.

Sleep Mode

If you have to interrupt your work, you are able to turn off the power without exiting from your software by placing the computer into Sleep Mode. In this mode data is maintained in the computer's main memory so that when you turn on the power again, you can continue working right where you left off.



When you have to turn off your computer aboard an aircraft or in places where electronic devices are regulated or controlled, always completely shut down the computer. This includes turning off any wireless communication switches or devices, and canceling settings that reactivate the computer automatically, such as a timer recording function. Failure to completely shut down the computer in this way could allow the operating system to reactivate and run pre-programmed tasks or preserve unsaved data, which could interfere with aviation or other systems, possibly causing serious injury.



- **Before entering Sleep Mode, be sure to save your data.**
- **Do not install or remove a memory module while the computer is in Sleep Mode.** The computer or the memory module could be damaged.
- **Do not remove the battery pack while the computer is in Sleep Mode (unless the computer is connected to an AC power source).** Data in memory could be lost.



- *When the AC adaptor is connected, the computer will go into Sleep Mode according to the settings in the Power Options (to access it, **Start** -> **Control Panel** -> **System and Security** -> **Power Options**).*
- *To restore the operation of the computer from Sleep Mode, press and hold the power button or any key on the keyboard for a short amount of time. Please note that keyboard keys can only be used if the Wake-up on Keyboard option is enabled within the HW Setup utility.*
- *If the computer enters Sleep Mode while a network application is active, the application might not be restored when the computer is next turned on and the system returns from Sleep Mode.*
- *To prevent the computer from automatically entering Sleep Mode, disable Sleep Mode within the Power Options (to access it, **Start** -> **Control Panel** -> **System and Security** -> **Power Options**).*
- *To use the Hybrid Sleep function, configure it in the Power Options.*

Benefits of Sleep Mode

The Sleep Mode feature provides the following benefits:

- Restores the previous working environment more rapidly than does the Hibernation Mode feature.
- Saves power by shutting down the system when the computer receives no input or hardware access for the time period set by the System Sleep Mode feature.
- Allows the use of the panel power off feature.

Executing Sleep Mode



*You can also enable Sleep Mode by pressing **FN + F3** - please refer to Chapter 5, [The Keyboard](#), for further details.*

You can enter Sleep Mode in one of three ways:

- Click **Start**, point to the arrow icon () and then select **Sleep** from the menu.
- Close the display panel. Please note that this feature must be enabled within the Power Options (to access it, click **Start** -> **Control Panel** -> **System and Security** -> **Power Options**).
- Press the power button. Please note that this feature must be enabled within the Power Options (to access it, click **Start** -> **Control Panel** -> **System and Security** -> **Power Options**).

When you turn the power back on, you can continue where you left when you shut down the computer.



- *When the computer is in Sleep Mode, the power indicator will blink orange.*
- *If you are operating the computer on battery power, you can lengthen the overall operating time by turning it off into Hibernation Mode - Sleep Mode will consume more power while the computer is off.*

Sleep Mode limitations

Sleep Mode will not function under the following conditions:

- Power is turned back on immediately after shutting down.
- Memory circuits are exposed to static electricity or electrical noise.

Hibernation Mode

The Hibernation Mode feature saves the contents of memory to the hard disk drive when the computer is turned off so that, the next time it is turned on, the previous state is restored. Please note that the Hibernation Mode feature does not save the status of any peripheral devices connected to the computer.



- *Save your data. While entering Hibernation Mode, the computer saves the contents of memory to the hard disk drive. However, for safety sake, it is best to save your data manually.*
- *Data will be lost if you remove the battery or disconnect the AC adaptor before the save is completed. Wait for the **Hard Disk Drive** indicator to go out.*
- *Do not install or remove a memory module while the computer is in Hibernation Mode. Data will be lost.*

Benefits of Hibernation Mode

The Hibernation Mode feature provides the following benefits:

- Saves data to the hard disk drive when the computer automatically shuts down because of a low battery condition.
- You can return to your previous working environment immediately when you turn on the computer.
- Saves power by shutting down the system when the computer receives no input or hardware access for the time period set by the System Hibernate feature.
- Allows the use of the panel power off feature.

Starting Hibernation Mode



*You can also enable Hibernation Mode by pressing **FN + F4** - please refer to Chapter 5, [The Keyboard](#), for further details.*

To enter Hibernation Mode, follow the steps below.

1. Click **Start**.
2. Point to the arrow icon () and then select **Hibernate** from the menu.

Automatic Hibernation Mode

The computer can be configured to enter Hibernation Mode automatically when you press the power button or close the lid. In order to define these settings, you can follow the steps as described below:

1. Click **Start** and click the **Control Panel**.
2. Click **System and Security** and click **Power Options**.
3. Click **Choose what the power button does** or **Choose what closing the lid does**.
4. Enable the desired Hibernation Mode settings for **When I press the power button** and **When I close the lid**.
5. Click the **Save changes** button.

Data save in Hibernation Mode

When you turn off the power in Hibernation Mode, the computer will take a moment to save the current data in memory to the hard disk drive. During this time, the **Hard Disk Drive** indicator will glow.

After you turn off the computer, and the content of memory has been saved to the hard disk drive, turn off the power to any peripheral devices.



Do not turn the computer or devices back on immediately. Wait a moment to let all capacitors fully discharge.

Restarting the computer

Certain conditions require that you reset the computer, for example if:

- You change certain computer settings.
- An error occurs and the computer does not respond to your keyboard commands.

If you need to restart the computer, there are three ways this can be achieved:

- Click **Start**, point to the arrow icon () and then select **Restart** from the menu.
- Press **CTRL**, **ALT** and **DEL** simultaneously (once) to display the menu window, then select **Restart** from the **Shut down options**.
- Press the power button and hold it down for five seconds. Once the computer has turned itself off, wait between ten and fifteen seconds before turning the power on again by pressing the power button.

System Recovery Options

There is a hidden partition allocated on the hard disk drive for the System Recovery Options.

This partition stores files which can be used to repair the system in the event of a problem.



The System Recovery Options feature will be unusable if this partition is deleted.

System Recovery Options

The System Recovery Options feature is installed on the hard disk when shipped from the factory. The System Recovery Options menu includes tools to repair startup problems, run diagnostics or restore the system.

See the **Windows Help and Support** content for more information about **Startup Repair**.

The System Recovery Options can also be run manually to repair problems.

The procedure is as follows. Follow the instructions shown on the on-screen menu.

1. Turn off the computer.
2. While holding the **F8** key, turn on the computer.
3. The **Advanced Boot Options** menu will be displayed.
Use the arrow keys to select **Repair Your Computer** and press **ENTER**.
4. Follow the on-screen instructions.



Check your Windows® manual for more information on backing up your system (including the system image backup feature).

System Recovery

This section describes the creation of Recovery Media and their use.

Creating Recovery Media

This section describes how to create Recovery Media.



- *Be sure to connect the AC adaptor when you create Recovery Media.*
- *Be sure to close all other software programs except the Recovery Media Creator.*
- *Do not run software such as screen savers which can put a heavy load on the CPU.*
- *Operate the computer at full power.*
- *Do not use power-saving features.*
- *Do not write to the media when the virus check software is running. Wait for it to finish, then disable virus detection programs including any software that checks files automatically in the background.*
- *Do not use utilities, including those intended to enhance hard disk drive access speed. They may cause unstable operation and damage data.*
- *Do not shut down/log off or Sleep/Hibernate while writing or rewriting the media.*
- *Set the computer on a level surface and avoid places subjected to vibrations such as airplanes, trains, or cars.*
- *Do not use on an unstable surface such as a stand.*

A recovery image of the software on your computer is stored on the hard disk drive, and can be copied to either CD, DVD or USB Flash Memory by using the following steps:

1. Select either blank CD, DVD or USB Flash Memory.

The application will allow you to choose from a variety of different media onto which the recovery image can be copied including CD-R, CD-RW, DVD-R, DVD-R DL, DVD-RW, DVD+R, DVD+R DL, DVD+RW and USB Flash Memory.



- *Please note that some of the above media may not be compatible with the optical disc drive installed into your computer. You should therefore verify the optical disc drive supports the blank media you have chosen before proceeding.*
- *USB Flash Memory will be formatted and all the data in the USB Flash Memory will be lost when proceeding.*

2. Turn on your computer and allow it to load the Windows 7 operating system from the hard disk drive as normal.
3. Insert the media into the computer.
 - Insert the first blank disc into the optical disc drive tray, or Insert the USB Flash Memory into one available USB port

4. Double click the **Recovery Media Creator** icon on the Windows 7 desktop, or select the application from **Start** Menu.
5. After Recovery Media Creator starts, select the type of media and the title you wish to copy, and then click the **Create** button.

Restoring the pre-installed software from the Recovery hard disk drive

A portion of the total hard disk drive space is configured as a hidden recovery partition. This partition stores files which can be used to restore pre-installed software in the event of a problem.

If you subsequently set up your hard disk drive again, do not change, delete or add partitions in a manner other than specified in the manual, otherwise you may find that space for the required software is not available.

In addition, if you use a third-party partitioning program to reconfigure the partitions on your hard disk drive, you may find that it becomes impossible to setup your computer.



*When the sound mute feature has been activated by pressing the **FN + ESC** key, be sure to disable this to allow sounds to be heard before starting the restore process. Please refer to Chapter 5, [The Keyboard](#), for further details.*

You can not use System Recovery Options if restoring the pre-installed software without System Recovery Options.



When you reinstall the Windows operating system, the hard disk will be reformatted and all data will be lost.

1. Turn off your computer.
2. While holding down **0** (zero) key on the keyboard, turn on your computer.
3. A menu will be displayed from which you should follow the on-screen instructions.

Restoring the pre-installed software from your created Recovery Media

If the pre-installed files are damaged, you are able to either use the Recovery Media you have created or the hard disk drive recovery process to restore the computer to the state it was in when you originally received it. To perform this restoration, follow the steps below:



*When the sound mute feature has been activated by pressing the **FN + ESC** key, be sure to disable this to allow sounds to be heard before starting the restore process. Please refer to Chapter 5, [The Keyboard](#), for further details.*

You can not use System Recovery Options if restoring the pre-installed software without System Recovery Options.



When you reinstall the Windows operating system, the hard disk will be reformatted and all data will be lost.

1. Load the Recovery Media into the computer and turn off the computer's power.
2. While holding down **F12** key on the keyboard, turn on your computer - when the **TOSHIBA** logo screen appears, release the **F12** key.
3. Use the left and right cursors key to select the appropriate icon (CD-ROM or USB icon) of your actual recovery media from the menu. Please refer to the [Boot Priority](#) section in Chapter 7, HW Setup for further information.
4. A menu will be displayed from which you should follow the on-screen instructions.



*When drivers/utilities are installed, you can setup the respective drivers/utilities from the following place. To open the setup files, Click **Start -> All Programs -> TOSHIBA -> Applications and Drivers**.*

Chapter 2

The Grand Tour

This chapter identifies the various components of the computer - it is recommended that you become familiar with each before you operate the computer.

Legal Footnote (Non-applicable Icons)*1

For more information regarding Non-applicable Icons, please refer to the Legal Footnotes section in Appendix H or click the *1 above.



Please handle your computer carefully to avoid scratching or damaging the surface.

Front with the display closed

The following figure shows the computer's front with its display panel in the closed position.

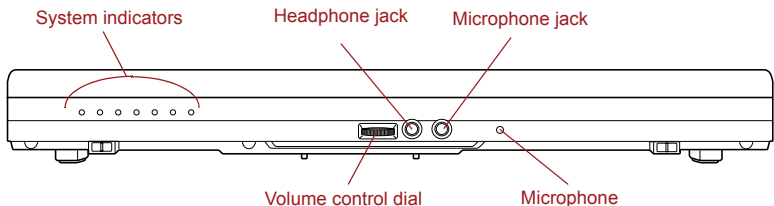





Figure 2-1 Front of the computer with display panel closed

System indicators

These LED indicators allow you to monitor the status of various computer functions and are described in more detail within the [System indicators](#) section.

	Volume control dial	<p>Use this dial to adjust the volume of the internal stereo speaker and optional external stereo headphones (if connected).</p> <p>Move the Volume control dial to the right to increase the volume and to the left to decrease the volume.</p>
	Headphone jack	<p>A 3.5 mm mini headphone jack enables connection of stereo headphones.</p>
	Microphone jack	<p>A 3.5 mm mini microphone jack enables connection of a three-conductor mini jack for monaural microphone input.</p>
	Microphone	<p>A built-in microphone allows you to import and record sounds for your application - please refer to the Sound System section in Chapter 4, Operating Basics for more information. Some models are equipped with a Microphone.</p>

Left side

The following figure shows the computer's left side.

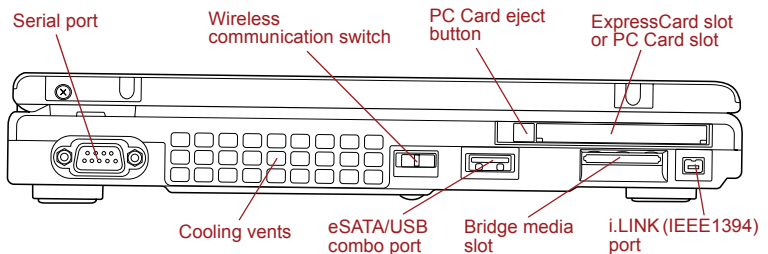

Figure 2-2 The left side of the computer



Serial port	<p>Use this 9-pin port to connect serial devices such as an external modem, serial mouse or serial printer.</p> <p>Some models are equipped with a serial port.</p>
--------------------	---

Cooling vents	<p>The cooling vents help keep the processor from overheating.</p>
----------------------	--



Do not block the cooling vents. Keep foreign metal objects, such as screws, staples and paper clips, out of the cooling vents. Foreign metal objects can create a short circuit, which can cause damage and fire, possibly resulting in serious injury.



Wireless communication switch

Slide this switch to the right to turn off Wireless LAN, Bluetooth™ and Wireless WAN functions. Slide it to the left to turn on the functions.

Only some models are equipped with Bluetooth, Wireless LAN and Wireless WAN functions.



- *Do not use the Wireless LAN (Wi-Fi®) or Bluetooth functionalities near a microwave oven or in areas subject to radio interference or magnetic fields. Interference from a microwave oven or other source can disrupt Wi-Fi or Bluetooth operation.*

- *Turn all wireless functionalities off when near a person who may have a cardiac pacemaker implant or other medical electric device. Radio waves may affect pacemaker or medical device operation, possibly resulting in serious injury. Follow the instruction of your medical device when using any wireless functionality.*

- *Always turn off wireless functionality if the computer is near automatic control equipment or appliances such as automatic doors or fire detectors. Radio waves can cause malfunction of such equipment, possibly resulting in serious injury.*



eSATA/USB combo port

One eSATA/USB combo port, which complies to the USB 2.0 standard, is provided on the left hand side of the computer. The ports with the icon (⚡) has **USB Sleep and Charge**. This port has eSATA (External Serial ATA) function. Some models are equipped with a eSATA/USB combo port.



Keep foreign metal objects, such as screws, staples and paper clips, out of the eSATA/USB combo port. Foreign metal objects can create a short circuit, which can cause damage and fire, possibly resulting in serious injury.



Please note that it is not possible to confirm the operation of all functions of all USB devices that are available. In view of this it may be noted that some functions associated with a specific device might not operate properly.



Bridge media slot

This slot lets you insert an SD™/SDHC™ memory card, miniSD™/microSD™ Card, Memory Stick® (PRO™/PRO Duo™), xD-Picture Card™ and MultiMediaCard™. Refer to the [Optional devices](#) section in Chapter 3, Hardware, Utilities and Options.



Keep foreign metal objects, such as screws, staples and paper clips, out of the Bridge media slot. Foreign metal objects can create a short circuit, which can cause damage and fire, possibly resulting in serious injury.

ExpressCard slot

This slot allows you to install a single ExpressCard device.

PC Card slot

This slot can accommodate a single Type II, 16-bit or 32-bit (CardBus) PC Card device.

PC Card eject button

This button is used in order to remove a PC Card from within the computer.



Keep foreign metal objects, such as screws, staples and paper clips, out of the PC Card slot. Foreign metal objects can create a short circuit, which can cause damage and fire, possibly resulting in serious injury.



S400

i.LINK (IEEE1394) port

This port allows you to connect an external device, such as a digital video camera for high-speed data transfer.

Some models are equipped with a i.LINK (IEEE1394) port.

Right side

The following figure shows the computer's right side.

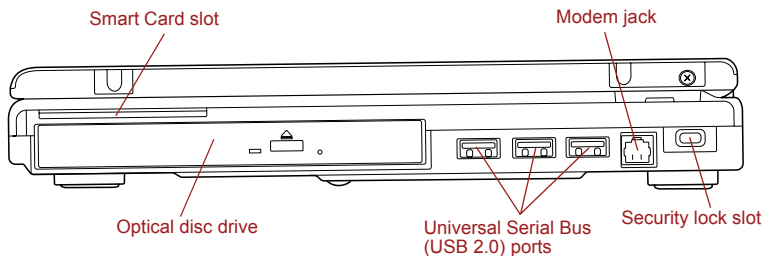

Figure 2-3 The right side of the computer

Smart Card

Smart Card slot

This slot can accommodate a single Smart Card device. Some models are equipped with a Smart Card slot.



Keep foreign metal objects, such as screws, staples and paper clips, out of the Smart Card slot. Foreign metal objects can create a short circuit, which can cause damage and fire, possibly resulting in serious injury.

Optical disc drive

The computer is configured with a DVD-ROM, DVD-ROM&CD-R/RW or DVD Super Multi drive.

**Universal Serial Bus (USB 2.0) ports**

Three Universal Serial Bus ports, which comply to the USB 2.0 standard, are provided on the right hand side of the computer.



Keep foreign metal objects, such as screws, staples and paper clips, out of the USB connectors. Foreign metal objects can create a short circuit, which can cause damage and fire, possibly resulting in serious injury.



Please note that it is not possible to confirm the operation of all functions of all USB devices that are available. In view of this it may be noted that some functions associated with a specific device might not operate properly.

**Modem jack**

The modem jack lets you use a modular cable to connect the modem directly to a telephone line. Some models are equipped with a modem jack.



■ *Connection to any communication line other than an analog phone line could cause a PC system failure.*

■ *Connect the built-in modem only to ordinary analog phone lines.*

■ *Never connect the built-in modem to a digital line (ISDN).*

■ *Never connect the built-in modem to the digital connector on a public telephone or to a digital private branch exchange (PBX).*

■ *Never connect the built-in modem to a key telephone system for residences or offices.*

■ *Avoid using your computer modem with the telephone cable connected during an electrical storm. There may be a remote risk of electric shock from lightning.*

**Security lock slot**

A security cable can be attached to this slot and then connected to a desk or other large object in order to deter theft of the computer.

Back

The following figure shows the computer's back.

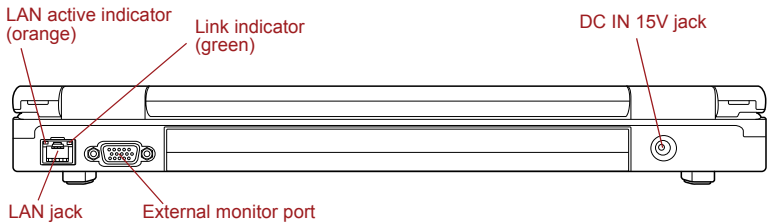

Figure 2-4 The back of the computer



LAN jack

This jack lets you connect to a LAN. The adaptor has built-in support for Ethernet LAN (10 megabits per second, 10BASE-T), Fast Ethernet LAN (100 megabits per second, 100BASE-TX). Some models are equipped with a Gigabit Ethernet LAN (1000 megabits per second, 1000BASE-T). Refer to Chapter 4, *Operating Basics*, for details.



- Do not connect any cable other than a LAN cable to the LAN jack. It could cause damage or malfunction.
- Do not connect the LAN cable to a power supply. It could cause damage or malfunction.

Link indicator (green)

This indicator glows green when the computer is connected to a LAN and the LAN is functioning properly.

LAN active indicator (orange)

This indicator glows orange when data is being exchanged between the computer and the LAN.



External monitor port

This port provides 15-pin, analog VGA port. This port allows you to connect an external monitor to the computer.



DC IN 15V jack

The AC adaptor connects to this jack in order to power the computer and charge its internal batteries. Please note that you should only use the model of AC adaptor supplied with the computer at the time of purchase - using the wrong AC adaptor can cause damage to the computer.

Underside

The following figure shows the underside of the computer. You should ensure that the display is closed before the computer is turned over to avoid causing any damage.

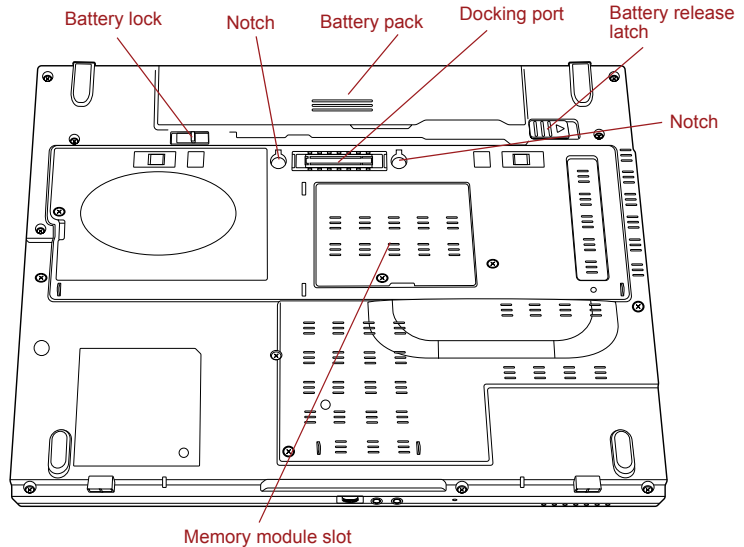

Figure 2-5 The underside of the computer

Notches

Notches on the computer engage hooks on the TOSHIBA Express Port Replicator to ensure a secure connection.



Docking port

This port enables connection of an optional TOSHIBA Express Port Replicator described in Chapter 3, *Hardware, Utilities and Options*.

Some models are equipped with a Docking port.



- *Only the TOSHIBA Express Port Replicator can be used with this computer. Do not attempt to use any other Port Replicator.*
- *Keep foreign objects out of the docking port. A pin or similar object can damage the computer's circuitry.*
- *Do not use the computer's External monitor port, when connecting the TOSHIBA Express Port Replicator to the computer.*

**Memory module slot**

The memory module slot allows for the installation, replacement and removal of additional memory module.

Refer to the [Additional memory module](#) section in Chapter 3, Hardware, Utilities and Options.

**Battery release latch**

Slide and hold this latch into its 'Unlock' position in order to release the battery pack for removal. For more detailed information on removing the battery pack please refer to Chapter 6, [Power and Power-Up Modes](#).

Battery pack

The battery pack provides power to the computer when the AC adaptor is not connected. For more detailed information on the use and operation of the battery pack please refer to Chapter 6, [Power and Power-Up Modes](#).

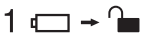
**Battery lock**

Slide the battery lock to release the battery pack ready for removal.

Front with the display open

This section shows the computer with the display panel open. In order to open the display, lift the display panel up and position it at a comfortable viewing angle for you.

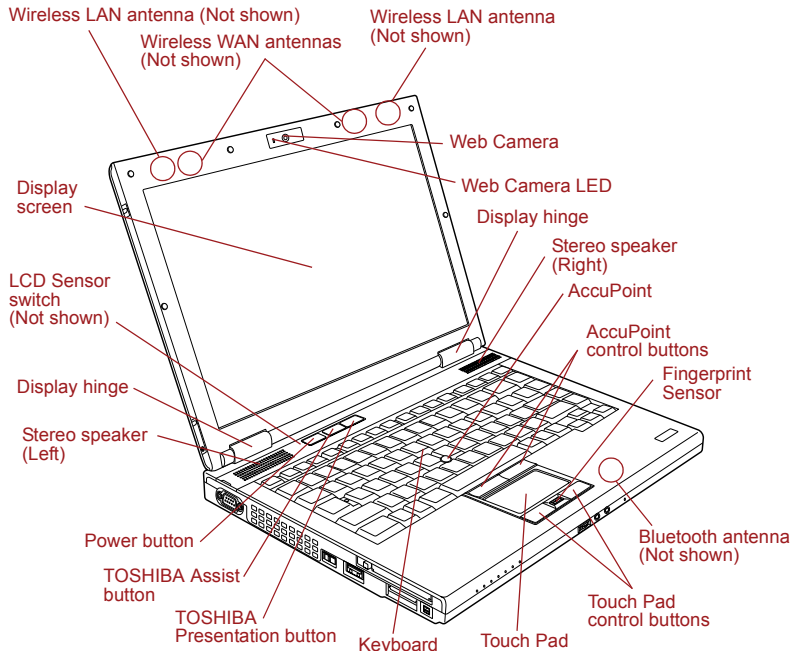



Figure 2-6 The front of the computer with the display panel open

Display hinges	The display hinges allow the display panel to be position at a variety of easy-to-view angles.
Display screen	Please be aware that, when the computer is operating on the AC adaptor, the image displayed on the internal screen will be somewhat brighter than when it operates on battery power. This difference in brightness levels is intended to save power when operating on batteries. For more information on the computer's display, please refer to the Display Controller and Video mode section in Appendix B.
Web Camera LED	The Web Camera LED glows when the Web Camera is operating.

Web Camera	<p>Web Camera is a device that allows you to record video or take photographs with your computer. You can use it for video chatting or video conferences using a communication tool such as Windows Live Messenger. TOSHIBA Web Camera Application will help you to add various video effects to your video or photograph. Enables the transmission of video and use of video chat via the internet using specialized applications.</p> <p>Some models are equipped with a Web Camera. Please refer to the Web Camera section in Chapter 4, Operating Basics.</p>
Touch Pad	<p>The Touch Pad located in the center of the palm rest is used to control the movement of the on-screen pointer. For more information, please refer to the Using the Touch Pad section in Chapter 4, Operating Basics.</p>
Touch Pad control buttons	<p>The control buttons located below the Touch Pad allow you to select menu items or manipulate text and graphics as designated by the on-screen pointer.</p>
AccuPoint control buttons	<p>Control buttons below the keyboard let you select menu items or manipulate text and graphics designated by the on-screen pointer. Refer to the Using the AccuPoint section in Chapter 4, Operating Basics.</p> <p>Some models are equipped with a AccuPoint control buttons.</p>
AccuPoint	<p>A pointer control device located in the center of the keyboard is used to control the on-screen pointer. Refer to the Using the AccuPoint section in Chapter 4, Operating Basics.</p> <p>Some models are equipped with a AccuPoint.</p>
Keyboard	<p>The internal keyboard provides the embedded numeric overlay keys, dedicated cursor control overlay keys, and  and  Keys. The keyboard is compatible with the IBM® enhanced keyboard. Refer to Chapter 5, The Keyboard, for details.</p>
Stereo speakers	<p>The speakers emit sound generated by your software as well as audio alarms, such as low battery condition, generated by the system.</p>

**Power button**

Press this button to turn the computer's power on and off.

**TOSHIBA Assist button**

Press this button to launch the program automatically. When power-off, Sleep Mode and Hibernation Mode, press this button to start the computer and launch the program.

Some models are equipped with a TOSHIBA Assist button.

**TOSHIBA Presentation button**

The TOSHIBA Presentation button has the same functionality as the Connect display button in the Mobility Center.

Some models are equipped with a TOSHIBA Presentation button.

Fingerprint Sensor

This sensor enables you to enroll and recognize a fingerprint.

For detailed information on Fingerprint Sensor, refer to Chapter 4, *Using the Fingerprint Sensor*.

Some models are equipped with a Fingerprint Sensor.

LCD Sensor switch

This switch senses when the display panel is either closed or opened and activates the Panel Power Off/On feature as appropriate. For example, when you close the display panel the computer enters Hibernation Mode and shuts itself down and then, when you next open the display, the computer will automatically start up and return you to the application you were previously working on.

You can specify within the Power Options. To access it, click **Start -> Control Panel -> System and Security -> Power Options**.



Do not put any magnetic objects close to this switch as they may cause the computer to automatically enter Hibernation Mode and shut down even if the Panel Power Off feature is disabled.

Bluetooth antenna

Some computers in this series are equipped with a Bluetooth antenna.

Wireless LAN antennas

Some computers in this series are equipped with the Wireless LAN antennas.

Wireless WAN antennas

Some computers in this series are equipped with the Wireless WAN antennas.

Indicators

This section explains indicator functions.

System indicators

LED system indicators next to their respective icons, glow when specific computer operations are in progress.



Figure 2-7 System indicators

	DC IN	The DC IN indicator normally glows green when power is being correctly supplied from the AC power adaptor. However, if the output voltage from the adaptor is abnormal, or if the computer's power supply malfunctions, this indicator will flash orange.
	Power	The Power indicator normally glows green when the computer is turned on. However, if you turn the computer off into Sleep Mode, this indicator will flash orange - approximately one second on, two seconds off - both while the system is shutting down and while it remains turned off.
	Battery	The Battery indicator shows the condition of the battery's charge - green indicates the battery is fully charged, orange indicates the battery is charging, and flashing orange indicates a low battery condition. Please refer to Chapter 6, Power and Power-Up Modes for more information on this feature.
	Hard Disk Drive/ Optical Disc Drive	The Hard Disk Drive/Optical Disc Drive indicator glows green whenever the computer is accessing the built-in hard disk drive, optical disc drive or eSATA device.
	Bridge media slot	The Bridge media slot indicator glows green when the computer is accessing the Bridge media slot.



Wireless communication

The **Wireless communication** indicator blinks orange when the Bluetooth and Wireless LAN functions are turned on.

Only some models are equipped with Bluetooth and Wireless LAN functions.



Wireless WAN

The Wireless WAN indicator glows or blinks blue when the Wireless WAN function is on.

The indicator will glow or blink in order to indicate the connection status of the Wireless WAN function.

A Wireless WAN module must be installed to use this function. Some models are equipped with a Wireless WAN module.

Keyboard indicators

The following figures show the positions of the CAPS LOCK indicator and the keypad overlay indicators which show the following conditions:

- When the CAPS LOCK indicator glows, the keyboard will produce capitals when any letter is typed.
- When the Arrow Mode indicator glows, the keypad overlay allows you to use cursor functions.
- When the Numeric Mode indicator glows, the keypad overlay allows you to enter numbers.

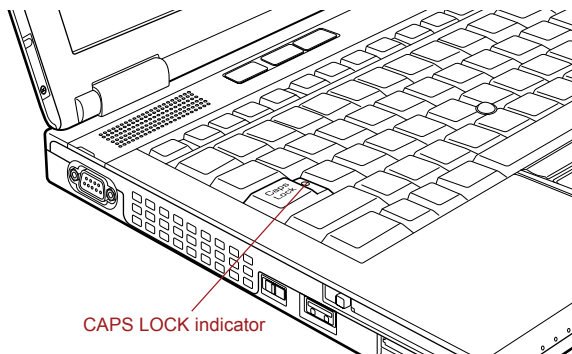

Figure 2-8 CAPS LOCK indicator

CAPS LOCK

This indicator glows green when letter keys are locked into their uppercase format.

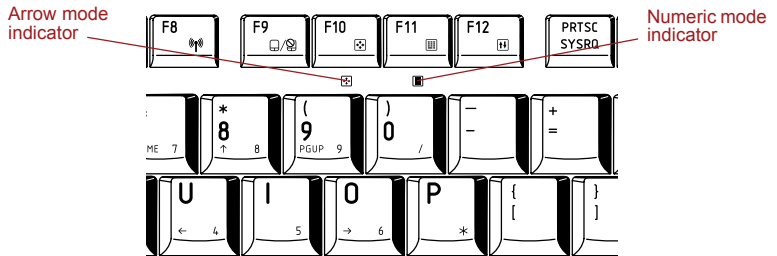

Figure 2-9 Keypad overlay indicators



Arrow mode

When the **Arrow mode** indicator lights green, you can use the gray labeled keys on the keypad overlay as cursor keys. Please refer to the [Keypad overlay](#) section in Chapter 5, The Keyboard for more information.



Numeric mode

When the **Numeric mode** indicator lights green, you can use the gray labeled keys on the keypad overlay for number entry. Please refer to the [Keypad overlay](#) section in Chapter 5, The Keyboard for more information.

Optical disc drives

The computer is installed with a DVD-ROM, DVD-ROM&CD-R/RW or DVD Super Multi drive. A Serial ATA interface controller is used for CD/DVD-ROM operation. When the computer is accessing a CD/DVD, an indicator on the drive glows.

Some models are equipped with an optical disc drive.

For information on loading and unloading discs refer to the [Using optical disc drives](#) section in Chapter 4, Operating Basics.

Region codes for DVD drives and media

DVD Super Multi drives and their associated media are manufactured according to the specifications of six marketing regions. When you purchase DVD-Video, make sure it matches your drive, otherwise it will not play properly.

Code	Region
1	Canada, United States
2	Japan, Europe, South Africa, Middle East
3	Southeast Asia, East Asia

4	Australia, New Zealand, Pacific Islands, Central America, South America, Caribbean
5	Russia, Indian Subcontinent, Africa, North Korea, Mongolia
6	China

Writable discs

This section describes the types of writable CD/DVD discs. Check the specifications of your drive to see the types of discs it can write. Use TOSHIBA Disc Creator to write compact discs. Refer to Chapter 4, *Operating Basics*.

CDs

- CD-R discs can be written only once. The recorded data cannot be erased or changed.
- CD-RW discs including multi speed CD-RW discs, high-speed CD-RW discs and ultra-speed CD-RW discs can be recorded more than once.

DVDs

- DVD-R, DVD+R, DVD-R (Dual Layer) and DVD+R (Double Layer) discs can be written only once. The recorded data cannot be erased or changed.
- DVD-RW, DVD+RW and DVD-RAM discs can be recorded more than once.

Formats

The drives support the following formats.

DVD-ROM drive

The drive supports the formats CD-ROM, DVD-ROM, DVD-Video, CD-DA, CD-Text, Photo CD™ (single/multi-session), CD-ROM Mode 1, Mode 2, CD-ROM XA Mode 2 (Form1, Form2), Enhanced CD (CD-EXTRA) and Addressing Method 2.

DVD-ROM&CD-R/RW drive

The drive supports the formats in addition to the DVD-ROM drive, and CD-R, CD-RW.

DVD Super Multi drive Double Layer

The drive supports the formats in addition to the DVD-ROM&CD-R/RW drive, and DVD-R, DVD-RW, DVD+R, DVD+RW, DVD-RAM, DVD-R DL (Format1), DVD+R DL.



Some types and formats of DVD-R DL and DVD+R DL discs may be unreadable.

DVD-ROM drive

The full-size DVD-ROM drive module lets you run either 12 cm (4.72") or 8 cm (3.15") CD/DVDs without using an adaptor.



The read speed is slower at the center of a disc and faster at the outer edge.

DVD read	8 speed (maximum)
CD read	24 speed (maximum)

DVD-ROM&CD-R/RW drive

The full-size DVD-ROM&CD-R/RW drive module lets you record data to rewritable CDs as well as run either 12 cm (4.72") or 8 cm (3.15") CD/DVDs without using an adaptor.



The read speed is slower at the center of a disc and faster at the outer edge.

DVD read	8 speed (maximum)
CD read	24 speed (maximum)
CD-R write	24 speed (maximum)
CD-RW write	24 speed (maximum, Ultra-speed media)

DVD Super Multi drive Double Layer

The full-size DVD Super Multi drive module lets you record data to rewritable CD/DVDs as well as run either 12 cm (4.72") or 8cm (3.15") CD/DVDs without using an adaptor.



The read speed is slower at the center of a disc and faster at the outer edge.

DVD read	8 speed (maximum)
DVD-R write	8 speed (maximum)
DVD-R DL write	6 speed (maximum)
DVD-RW write	6 speed (maximum)
DVD+R write	8 speed (maximum)
DVD+R DL write	6 speed (maximum)
DVD+RW write	8 speed (maximum)
DVD-RAM write	5 speed (maximum)
CD read	24 speed (maximum)
CD-R write	24 speed (maximum)
CD-RW write	24 speed (maximum, Ultra-speed media)

AC adaptor

The AC adaptor can automatically adjust to any voltage ranging from 100 to 240 volts and to a frequency of either 50 or 60 hertz, enabling you to use this computer in almost all country/region. The adaptor converts AC power to DC power and reduces the voltage supplied to this computer.

To recharge the battery, simply connect the AC adaptor to a power source and to the computer. Please refer to Chapter 6, [Power and Power-Up Modes](#) for further information.

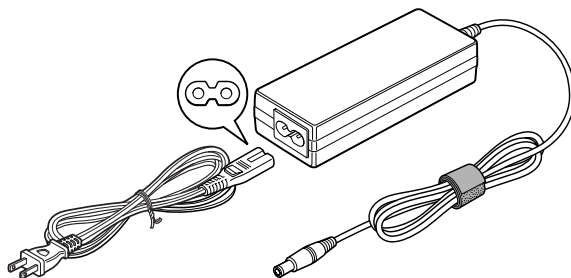

Figure 2-10 The AC adaptor (2-pin plug)

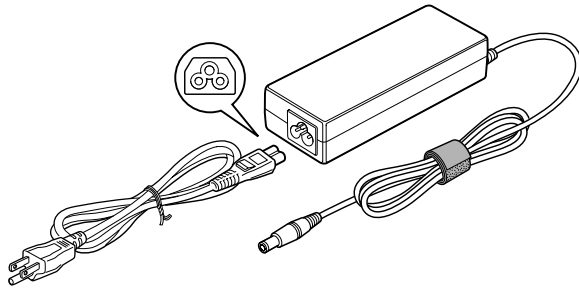

Figure 2-11 The AC adaptor (3-pin plug)



- Depending on the model in question, either a 2-pin or 3-pin adaptor/power lead will be bundled with the computer.
- Do not use a 3-pin to 2-pin conversion plug.
- The supplied power cord conforms to safety rules and regulations in the region the product is bought and should not be used outside of this region. In order to use the adaptor/computer in other regions, you should please buy a power cord that conforms to the safety rules and regulations in that particular region.



Always use the TOSHIBA AC adaptor that was included with your computer, or use AC adaptors specified by TOSHIBA to avoid any risk of fire or other damage to the computer. Use of an incompatible AC adaptor could cause fire or damage to the computer possibly resulting in serious injury. TOSHIBA assumes no liability for any damage caused by use of an incompatible adaptor.

Chapter 3

Hardware, Utilities and Options

Hardware

This section describes the hardware of your computer.
The actual specifications may vary depending on the model you purchased.

Processor

CPU

Your computer is equipped with one processor and processor type varies depending on model.
To check which type of processor is included in your model, open the TOSHIBA PC Diagnostic Tool Utility by clicking **Start -> All Programs -> TOSHIBA -> Utilities -> PC Diagnostic Tool**.



Some models in this series use Intel® Centrino® 2 processor technology which is based on three separate components, the Intel® Core™ 2 Duo processor, Intel® Wi-Fi Link 5300AGN -OR- 5100AGN and the Intel® GM/PM45 Express Chipset.

Legal Footnote (CPU)*2

For more information on the CPU, please refer to the Legal Footnotes section in Appendix H or Click the *2 above.

Memory

Memory slots	512, 1,024, 2,048 or 4,096MB memory modules can be installed in the computer's two memory slots for a maximum of 8,192MB system memory. This computer can be equipped with memory modules of a maximum size of 8,192MB. The actual amount of useable system memory will be less than the installed memory modules.
Video RAM	<p>The memory in a computer's graphics adaptor, used to store the image displayed on a bitmap display.</p> <p>The amount of Video RAM available is dependent on the computer's system memory.</p> <p>Start -> Control Panel -> Appearance and Personalization -> Display -> Adjust resolution.</p> <p>The amount of Video RAM can be verified by clicking the Advanced Settings button in the Screen Resolution window.</p>



If your computer is configured with more than 3 GB memory, the memory might be displayed as approximately 3 GB only (depending on the computer's hardware specifications).

This is correct because the operating system usually displays the available memory instead of the physical memory (RAM) built into the computer.

Various system components (like the video adapter's GPU and PCI devices like Wireless LAN, etc.) require their own memory space. Since a 32-bit operating system cannot address more than 4 GB of memory, these system resources overlap the physical memory. It is a technical limitation that the overlapped memory is not available to the operating system. Even though some tools might display the actual physical memory built into your computer, the memory available to the operating system will still be approximately 3 GB only.

Legal Footnote (Memory (Main System))*3

For more information regarding Memory (Main System), please refer to the Legal Footnotes section in Appendix H or click the *3 above.

Power

Battery pack	The computer is powered by one rechargeable lithium-ion battery pack.
---------------------	---

Legal Footnote (Battery Life)*4

For more information regarding Battery Life, please refer to the Legal Footnotes section in Appendix H or click the *4 above.

RTC battery	The internal RTC battery backs up the Real Time Clock (RTC) and calendar.
AC adaptor	<p>The AC adaptor provides power to the system and recharges the batteries when they are low. It comes with a detachable power cord which will either have a 2-pin or 3-pin plug enclosure.</p> <p>As the AC adaptor is universal, it can receive a range of AC voltages from 100 to 240 volts, however you should note that the output current varies among different models. Using the wrong adaptor can damage your computer. Refer to the AC adaptor section in Chapter 2, The Grand Tour.</p>

Disks

Hard disk drive or Solid state drive	<p>This computer is equipped with one of the following hard disk drive (HDD) types. The capacity of each hard disk drive model is different.</p> <p>Some models are equipped with a "Solid State Drive (SSD)" instead of a hard disk drive.</p> <ul style="list-style-type: none"> ■ HDD <ul style="list-style-type: none"> ■ 80GB ■ 120GB ■ 160GB ■ 200GB ■ 250GB ■ 320GB ■ SSD <ul style="list-style-type: none"> ■ 64GB ■ 128GB <p>Please note that part of the hard disk or Solid state drive's overall capacity is reserved as administration space. Additional HDD/SSD drive sizes may be introduced.</p>
---	---



- In this manual, the word "HDD" or "Hard disk drive" also refers to the SSD unless otherwise stated.
- SSD is a large-capacity storage media which uses Solid-State Memory in place of a magnetic disk of the hard disk.



Under certain unusual conditions of prolonged non-use and/or exposure to high temperatures, the SSD may be vulnerable to data retention errors.

Legal Footnote (Hard Disk Drive (HDD) Capacity)*5

For more information regarding Hard Disk Drive (HDD) Capacity, please refer to the Legal Footnotes section in Appendix H or click the *5 above.

Optical disc drive

Drive

The following optical disc drive is pre-installed in this computer.

- DVD-ROM drive
- DVD-ROM&CD-R/RW drive
- DVD Super Multi drive Double Layer



2.6GB and 5.2GB DVD-RAM media cannot be read from or written to.

Display

The computer's internal display panel supports high-resolution video graphics and can be set to a wide range of viewing angles for maximum comfort and readability.

Display panel

- TECRA A10/S10/P10, Satellite S300L, Satellite Pro S300/S300L
15.4" TFT LCD screen, 16 million colors, with one of the following resolutions:
 - WXGA, 1280 horizontal x 800 vertical pixels
 - WSXGA+, 1680 horizontal x 1050 vertical pixels
- TECRA M10
14.1" TFT LCD screen, 16 million colors, with one of the following resolutions:
 - WXGA, 1280 horizontal x 800 vertical pixels
 - WXGA+, 1440 horizontal x 900 vertical pixels

Legal Footnote (LCD)*6

For more information regarding the LCD, please refer to the Legal Footnotes section in Appendix H or click the *6 above.

Graphics controller The graphics controller maximizes display performance. Refer to [Display Controller and Video mode](#) section in Appendix B for more information.

Legal Footnote (Graphics Processor Unit ("GPU"))*7

For more information regarding the Graphics Processor Unit ("GPU"), please refer to the Legal Footnotes section in Appendix H or click the *7 above.

Sound

Sound system The integrated sound system provides support for the computer's internal speakers and microphone, as allowing an external microphone and headphones to be connected via the appropriate jacks.

Multimedia

Web Camera **Web Camera** is a device that allows you to record video or take photographs with your computer. You can use it for video chatting or video conferences using a communication tool such as **Windows Live Messenger**. **TOSHIBA Web Camera Application** will help you to add various video effects to your video or photograph. Please refer to the [Web Camera](#) section in Chapter 4, Operating Basics.

Communications

Modem	<p>The integrated modem provides capability for data and fax communications that support the V.90 (V.92) standards and includes a modem jack for connection to the telephone line. Please note that both the V.90 and V.92 standards are only supported in the USA, Canada, United Kingdom, France, Germany and Australia - only the V.90 standard is supported in other regions. You should also be aware that the speed of data and fax transfer will depend on the analog telephone line conditions.</p> <p>Some models are equipped with the integrated modem.</p>
LAN	<p>The computer has built-in support for Ethernet LAN (10 megabits per second, 10BASE-T), Fast Ethernet LAN (100 megabits per second, 100BASE-TX) and Gigabit Ethernet LAN (1000 megabits per second, 1000BASE-T).</p>
Bluetooth	<p>Some computers in this series have Bluetooth wireless communication function which eliminates the need for cables between electronic devices such as computers, printers and mobile phones. When it is enabled, Bluetooth provides the wireless personal area network environment which is safe and trustworthy, that is quick and easy.</p>
Wireless LAN	<p>Some computers in this series are equipped with a Wireless LAN module that is compatible with other LAN systems based on Direct Sequence Spread Spectrum/Orthogonal Frequency Division Multiplexing radio technology that complies with the IEEE 802.11 Standard.</p>

Legal Footnote (Wireless LAN)*8

For more information regarding Wireless LAN, please refer to the Legal Footnotes section in Appendix H or click the *8 above.

Special features

The following features are either unique to TOSHIBA computers or are advanced features which make the computer more convenient to use.

Access each function using the following procedures.

*1 To access the Power Options, click **Start -> Control Panel -> System and Security -> Power Options**.

TOSHIBA Assist button	<p>Press this button to launch the program automatically. When power-off, Sleep Mode and Hibernation Mode, press this button to start the computer and launch the program.</p> <p>Some models are equipped with a TOSHIBA Assist button.</p>
TOSHIBA Presentation button	<p>The TOSHIBA Presentation button has the same functionality as the Connect display button in the Mobility Center.</p> <p>Some models are equipped with a TOSHIBA Presentation button.</p>
Hot keys	<p>Hot keys are specific key combinations that let you quickly change the system configuration directly from the keyboard without running a system program.</p>
Display automatic power off *1	<p>This feature automatically cuts off power to the computer's display panel when there is no keyboard input for a specified time, with power being restored the next time a key is pressed. This can be specified in the Power Options.</p>
HDD automatic power off *1	<p>This feature automatically cuts off power to the hard disk drive when it is not accessed for a specified time, with power being restored when the hard disk drive is next accessed. This can be specified in the Power Options.</p>
System automatic Sleep/Hibernation Mode *1	<p>This feature automatically shuts down the system into either Sleep Mode or Hibernation Mode when there is no input or hardware access for a specified time. This can be specified in the Power Options.</p>
Keypad overlay	<p>A ten-key numeric keypad is integrated into the keyboard. Please refer to the Keypad overlay section in Chapter 5, The Keyboard, for information on using this feature.</p>
Power on password	<p>Two levels of password security, supervisor and user, are available to prevent unauthorized access to your computer.</p>
Instant security	<p>A specific hot key function automatically locks the system providing data security.</p>

Intelligent power supply *1	A microprocessor in the computer's intelligent power supply detects the battery's charge, automatically calculates the remaining battery capacity and protects electronic components from abnormal conditions such as a voltage overload from the AC adaptor. This can be specified in the Power Options.
Battery save mode *1	This feature lets you configure the computer in order to save battery power. This can be specified in the Power Options.
Panel power on/off *1	This feature automatically turns power to the computer off when the display panel is closed, and turns it back on when the display panel is opened. This can be specified in the Power Options.
Low battery automatic Hibernation Mode *1	When battery power is exhausted to the point that computer operation cannot be continued, the system automatically enters Hibernation Mode and shuts itself down. This can be specified in the Power Options.
Heat dispersal *1	To protect against overheating, the processor has an internal temperature sensor so that, if the computer's internal temperature rises to a certain level, the cooling fan is turned on or the processing speed is lowered. This can be specified in the Power Options.
TOSHIBA HDD Protection	This feature uses the acceleration sensor built in the computer to detect vibration and shocks, and automatically moves the hard disk drive's read/write head to a safe position in order to reduce the risk of damage that could be caused by head-to-disk contact. Refer to the Using the Hard Disk Drive (HDD) Protection section in Chapter 4, Operating Basics, for more details.



- *The TOSHIBA HDD Protection function does not guarantee that the hard disk drive will not be damaged.*
- *TOSHIBA HDD Protection cannot be used in models that are equipped with SSD.*

Hibernation Mode	This feature lets you turn off the power to the computer without exiting from your software. The contents of main memory are automatically saved to the hard disk drive so that when you next turn the power on again, you can continue working right where you left off. Refer to the Turning off the power section in Chapter 1, Getting Started, for more details.
Sleep Mode	If you have to interrupt your work, you can use this feature to allow you to turn off power to the computer without exiting from your software. Data is maintained in the computer's main memory so that when you next turn on the power, you can continue working right where you left off.
USB Sleep and Charge function	This feature allows you to charge USB-compatible external devices such as mobile phones or portable digital music players via the USB port when your computer is in Sleep Mode, Hibernation Mode or in the shutdown state. This function is worked by the USB Sleep and Charge Utility. For more information, please refer to the Using the TOSHIBA USB Sleep and Charge Utility section in Chapter 4, Operating Basics.
USB Wakeup function	This function restores the computer from Sleep Mode depending on the external devices connected to the USB ports. For example, if a mouse or USB keyboard is connected to a USB port, moving the mouse/keyboard will wakeup the computer. The "USB Wakeup function" operates under Windows 7 operating system and it works for all USB ports.
TOSHIBA PC Health Monitor	The TOSHIBA PC Health Monitor application proactively monitors a number of system functions such as power consumption, battery health and system cooling, informing you of significant system conditions. This application recognizes the system and individual component serial numbers and will track specific activities related to their usage. Refer to Appendix G, TOSHIBA PC Health Monitor .

TOSHIBA Value Added Package

This section describes the TOSHIBA Component features pre-installed on the computer.

TOSHIBA Power Saver	TOSHIBA Power Saver provides you with the features of more various power supply managements.
TOSHIBA Button Support	<p>This utility controls the following computer button functions.</p> <ul style="list-style-type: none"> ■ TOSHIBA Assist ■ TOSHIBA Presentation <p>The starting application from the button can be changed.</p>



TOSHIBA Button Support cannot be used in models that are not equipped with TOSHIBA Assist button and TOSHIBA Presentation button.

TOSHIBA Zooming Utility	This utility allows you to enlarge or reduce the icon size on the Windows Desktop, or the zoom factor associated with specific supported applications.
TOSHIBA PC Diagnostic Tool	The TOSHIBA PC Diagnostic Tool will display basic system configuration information and allow the functionality of some of the computer's built-in hardware devices to be tested.
TOSHIBA Password Utility	The TOSHIBA Password utility allows you to set a password in order to restrict access to the computer.
TOSHIBA Flash Cards	<p>The TOSHIBA Flash Cards provide a quick way to modify selected system functions and to launch applications.</p> <ul style="list-style-type: none"> ■ Hot key function ■ TOSHIBA utility launcher function

HW Setup	This utility allows you to customize your hardware settings according to the way you work with the computer and the peripherals you use.
TOSHIBA Accessibility	The TOSHIBA Accessibility utility provides support to movement impaired users when they need to use the TOSHIBA Hot-key functions. In use, the utility allows you to make the FN key 'sticky', that is you can press it once, release it, and they press one of the ' Function ' keys in order to access its specific function. When set, the FN key will remain active until another key is pressed.

Utilities and Applications

This section describes the pre-installed utilities that come with the computer and details how to start them. For further information on their operation, please refer to each utility's online manual, help files or README.TXT file.

Fingerprint Utility	<p>This product has a fingerprint utility installed for the purpose of enrolling and recognizing fingerprints which can then be linked to a username and password in order to remove the need to input these details from the keyboard. Just by swiping an enrolled finger against the fingerprint sensor, the following functions will be enabled:</p> <ul style="list-style-type: none"> ■ Logon to Windows and access a security enabled homepage through Internet Explorer. ■ Files and folders can be encrypted/decrypted and third party access to them is prevented. ■ Disable the password-protected screen-saver when returning from a power-saving mode such as Sleep Mode. ■ Authentication of the User Password (and, if applicable, the HDD(Hard Disk Drive) Password) when booting up the computer (Power-on Security). ■ Single Sign-on feature
----------------------------	---



Fingerprint security cannot be used in models that do not have a fingerprint module installed.

TOSHIBA Face Recognition

TOSHIBA Face Recognition uses a face verification library to verify the face data of users when they log in to Windows. If the verification is successful, the user will be logged into Windows automatically. The user can thus avoid having to enter a password or the like, which makes the login process easier.

TOSHIBA DVD Player

This software is provided for playback of DVD Video.

It has an on-screen interface and functions. Click **Start -> All Programs -> TOSHIBA DVD PLAYER -> TOSHIBA DVD PLAYER**.

For details on how to use TOSHIBA DVD PLAYER, see the help file.



- *Frame dropping, audio skipping or out of synch audio and video may occur during playback of some DVD Video titles.*
- *Make sure to connect the computer's AC adaptor when playing a DVD Video. Power-saving features may interfere with smooth playback.*
- *If you see the screen blinking while playing DVD with subtitle on at Media Player, please use TOSHIBA DVD Player or Media Center to play DVD.*

Bluetooth Stack for Windows by Toshiba

This software enables communication between the computer and external Bluetooth devices such as printers and mobile phones.



Bluetooth functions cannot be used in models that do not have a Bluetooth module installed.

TOSHIBA SD Memory Boot Utility

The TOSHIBA SD Memory Boot Utility allows you to create a bootable SD memory card to start the system. You can boot TOSHIBA SD Memory Boot Utility from the menu bar as follows. Click **Start -> All Programs -> TOSHIBA -> Utilities -> SD Memory Boot Utility**.



SD Memory Card Format Utility and other SD functions are packaged into TOSHIBA SD Memory Utilities.

TOSHIBA SD Memory Card Format	This utility allows you to format an SD/SDHC memory card by the SD standard format.
TOSHIBA Assist	TOSHIBA Assist is a graphical user interface that provides access to specific tools, utilities and applications that make the use and configuration of the computer easier.
TOSHIBA ConfigFree	TOSHIBA ConfigFree is a suite of utilities that improve the ease and control of communication devices and network connections, help in the identification of communication problems and allow the creation of profiles if you need to switch between different locations and communication networks. To access this utility, click Start -> All Programs -> TOSHIBA -> ConfigFree .
TOSHIBA Mic Effect	TOSHIBA Mic Effect provides you the Echo Canceller and the Microphone Array functions. For more instructions for this software, refer to the Sound System section in Chapter 4, Operating Basics.
TOSHIBA eco Utility	This PC is equipped with "eco mode". This mode slightly lowers performance of some devices to reduce electric power consumption. You can realize measurable power savings by using it continuously. TOSHIBA eco Utility helps you monitor your power savings by showing approximate real time power consumption. Furthermore, it shows approximate accumulated power consumption and approximate accumulated power savings when using eco mode daily, weekly, and monthly. You can track power savings by using eco mode continuously.
TOSHIBA Disc Creator	You can create CD's and DVD's in a number of formats including audio CD's that can be played on a standard CD player, and data CD's/DVD's which can store copies of the files and folders on your computer's hard disk drive. This software can be used on models with a DVD Super Multi drive. To start this utility, click Start -> All Programs -> TOSHIBA -> CD&DVD Applications -> Disc Creator .

TOSHIBA DVD-RAM Utility

This utility has the function of Physical Format and Write-Protect to DVD-RAM. This utility is contained the setup module of TOSHIBA Disc Creator. To start this utility, click **Start -> All Programs -> TOSHIBA -> CD&DVD Applications -> DVD-RAM Utility.**

TOSHIBA HDD/SSD Alert Utility

This utility includes wizard functions to monitor the Disk Drive operating status and execute the system backup.

To access the utility, click **Start -> All Programs -> TOSHIBA -> Utilities -> HDD SSD Alert.**

TOSHIBA Service Station

This application allows your computer to automatically search for TOSHIBA software updates or other alerts from TOSHIBA that are specific to your computer system and its programs. When enabled, this application periodically transmits to our servers a limited amount of system information, which will be treated in strict accordance with the rules and regulations as well as applicable data protection law.

To access this utility, click **Start -> All Programs -> TOSHIBA -> Utilities -> Service Station.**

Display Rotation Settings

This utility allows you to quickly rotate the Windows Desktop by either 0 degrees and 180 degrees. In use you are able to perform a rotation function by pressing either **CTRL + ALT + Up Arrow (↑)** to rotate 0 degrees or **CTRL + ALT + Down Arrow (↓)** to rotate 180 degrees - in a multi-monitor setup, the display that contains the cursor will be affected by these changes.

Windows Mobility Center

Mobility Center is a utility for accessing several mobile PC settings quickly in one window. A default maximum of eight tiles are provided by the operating system, and the additional two tiles are added to your Mobility Center.

■ Lock Computer:

This can be used to lock your computer without turning it off. This has the same function as selecting **Lock** from the **Start** menu (click **Start**, point to the arrow icon () and then select **Lock** from the menu).

■ TOSHIBA Assist:

This can be used to open **TOSHIBA Assist** if it is already installed in your computer.

TOSHIBA USB Sleep and Charge Utility

This utility is able to either enable or disable the USB Sleep and Charge function.

Shows the positions of USB ports that support the USB Sleep and Charge function and displays the battery's remaining capacity.

To start this utility, click **Start -> All Programs -> TOSHIBA -> Utilities -> USB Sleep and Charge**.

Trusted Platform Module (TPM)

The TPM (Trusted Platform Module) is a security encryption device for the hard disk drive.

BIOS setup and Infineon TPM Software Professional Package must be configured in order to use TPM.



To enable TPM through the BIOS setup:

1. Turn on the computer while pressing the **ESC** key.
2. Press the **F1** key when directed.
3. Press the **PGDN** key.
4. Set the **TPM** in **SECURITY CONTROLLER** to **Enabled**.
5. Press the **Y** key to save the changes.
6. Press **END** and then press the **Y** key to accept the changes. The computer will restart.

*In order to change the **TPM** setting when the **Hide TPM** setting is currently set to **Yes**, switch the **Hide TPM** setting from **Yes** to **No**.*

Optional devices

Optional devices can expand the computer's capabilities and its versatility. This section describes the connection or installation of the following devices:

Cards/memory

- ExpressCard/PC Card
- Smart Card
- Bridge media slot
 - Secure Digital™ (SD) Card (SD memory card, SDHC memory card, miniSD Card, microSD Card)
 - Memory Stick (Memory Stick, Memory Stick PRO, Memory Stick PRO Duo)
 - xD picture card
 - MultiMediaCard
- Additional memory module

Peripheral devices

- Hard disk drive pack
- External monitor
- USB FDD Kit
- eSATA
- i.LINK (IEEE1394)
- Serial port
- TOSHIBA Express Port Replicator

Other

- Security lock

ExpressCard

The computer is equipped with a single ExpressCard slot into which any ExpressCard device that meets industry standards, either manufactured by TOSHIBA or another vendor, can be installed. The slot supports hot plug connection and utilizes the PCI Express interface that supports the reading and writing of data at a theoretical maximum rate of 2.5Gbps.

Inserting an ExpressCard

The Windows hot-install feature allows you to insert ExpressCards while the computer is turned on.



Do not insert an ExpressCard while the computer is in Sleep Mode or Hibernation Mode as you may find that some cards do not work properly.

To insert an ExpressCard, follow the steps as detailed below:

1. Press the Dummy card in order to eject the Dummy card partially out of the computer.
2. Grasp the Dummy card and draw it.
3. Insert the ExpressCard into the ExpressCard slot on the side of the computer.
4. Press the ExpressCard gently to ensure a firm connection is made.

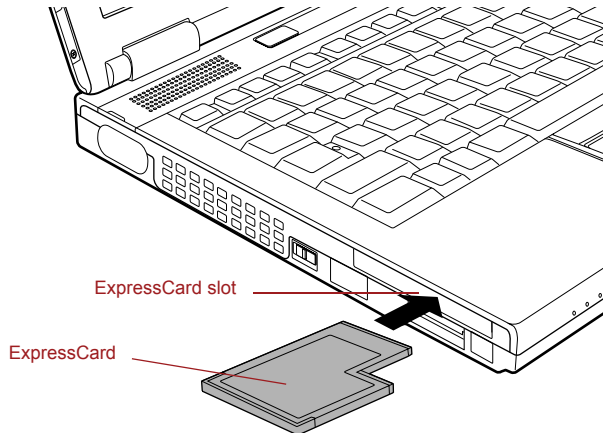

Figure 3-1 Inserting the ExpressCard (ExpressCard Model)

5. After inserting the ExpressCard you should refer to its documentation and also check the configuration in Windows in order to ensure that it is correct.

Removing an ExpressCard

To remove an ExpressCard, follow the steps as detailed below.

1. Open the **Safely Remove Hardware** icon on the Windows Taskbar.
2. Point to **ExpressCard** and click the left Touch Pad control button.
3. Press the ExpressCard in order to eject the ExpressCard partially out of the computer.
4. Grasp the ExpressCard and remove it.

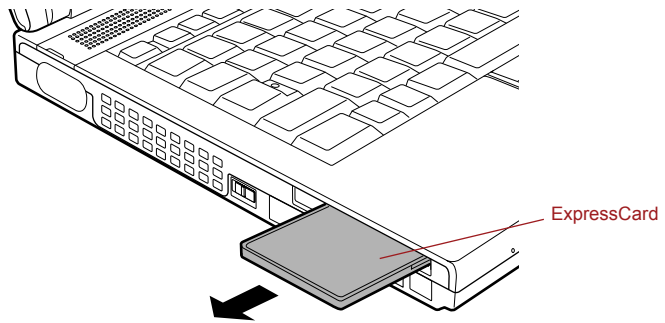

Figure 3-2 Removing the ExpressCard (ExpressCard Model)

5. Insert the Dummy card into the ExpressCard slot.



When you do not use an ExpressCard, please be sure to insert a Dummy card.

PC Card

The computer is equipped with a single PC Card slot that can accommodate a Type II format card. Any PC Card that meets industry standards, either manufactured by TOSHIBA or another vendor, can be installed as the slot supports 16-bit PC Cards and 32-bit CardBus cards. For reference, CardBus supports the newer standard of 32-bit PC Cards and provides superior performance for the greater demands of applications such as multimedia data transmission.



PC Cards can sometimes become hot during computer operation. Before you remove a PC Card always wait for it to cool. You could get burned removing a hot PC Card.

Inserting a PC Card

The Windows hot-install feature allows you to insert PC Cards while the computer is turned on.



Do not insert a PC Card while the computer is in Sleep Mode or Hibernation Mode as you may find that some cards do not work properly.

To insert a PC Card, follow the steps as detailed below:

1. Insert the PC Card into the PC Card slot on the side of the computer.
2. Press the PC Card gently to ensure a firm connection is made.

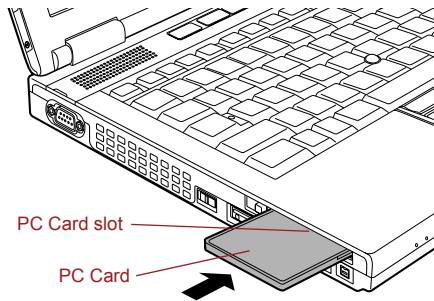

Figure 3-3 Inserting the PC Card

3. After inserting the PC Card you should refer to its documentation and also check the configuration in Windows in order to ensure that it is correct.

Removing a PC Card

To remove a PC Card, follow the steps as detailed below:

1. Open the **Safely Remove Hardware** icon on the Windows Taskbar.
2. Point to **PC Card** and click the left Touch Pad control button.
3. Press the PC Card eject button to partially extend it out of the computer.



If the PC Card is not inserted all the way into the computer, the eject button may not cause it to pop out sufficiently to allow it to be grasped. In this instance, simply push the PC Card firmly back into the computer and then press the eject button again.

4. Press the extended PC Card eject button in order to eject the PC Card partially out of the computer.
5. Grasp the PC Card and remove it.

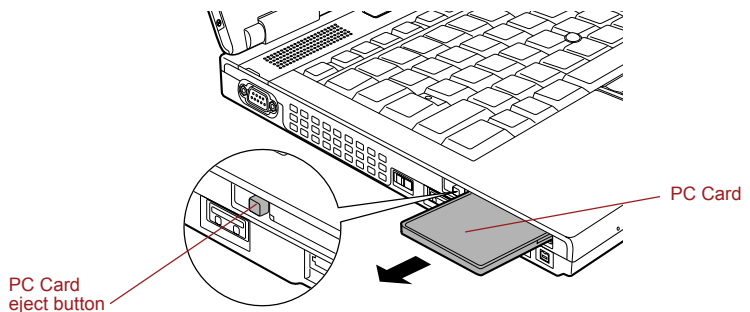

Figure 3-4 Removing the PC Card

Smart Card

A Smart Card is a credit card sized plastic card. An extremely thin integrated circuit (IC chip) is embedded into the card on which information can be recorded. These cards can be used for a wide variety of applications including telephone related and electronic monetary payments. This section contains information on the proper use of the Smart Card slot, and it is strongly recommended that you read it before operating the computer.

Some models are equipped with a Smart Card slot.



- *Your computer supports ISO7816-3 asynchronous cards (support protocols are T=0 and T=1) with a working voltage of 5V.*
- *The computer is equipped with either a PC Card slot or a Smart Card slot.*

Inserting a Smart Card

The Smart Card slot is located on the left side of the computer. The Windows hot-install feature allows you to insert a Smart Card while the computer is turned on.

To install a Smart Card, follow the steps as detailed below:

1. Insert the Smart Card into the Smart Card slot with the metal connectors facing up.
2. Press the Smart Card gently to ensure a firm connection is made. The computer will identify the Smart Card and display an icon in the Windows Taskbar.



- *When inserting a Smart Card into the Smart Card slot, make sure to confirm that the card is oriented correctly before inserting.*
- *Insert the Smart Card until it reaches the end of the Smart Card slot. There will be about 2cm of the Smart Card sticking out of the Smart Card slot. Do not attempt to insert it further.*
- *Always remove the Smart Card from the Smart Card slot before moving the computer.*
- *Remove the Smart Card after use.*

Failure to follow these instructions may result in damage to the computer and/or damage to the Smart Card.

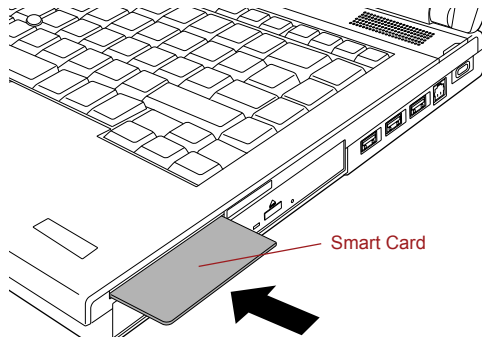

Figure 3-5 Inserting a Smart Card

3. After inserting the Smart Card, you should refer to its documentation and also check the configuration in Windows in order to ensure that it is correct.

Removing a Smart Card

To remove a Smart Card, follow the steps as detailed below:

1. Open the **Safely Remove Hardware** icon on the Windows Taskbar.



- Before removing the Smart Card, confirm that the Smart Card is not working with any program or system.
- Be careful not to bend the Smart Card while removing it from the computer.

2. Point to **Smart Card** and click the left Touch Pad control button.
3. Grasp the Smart Card and remove it.

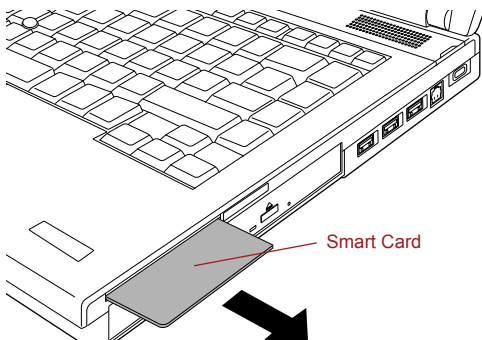

Figure 3-6 Removing a Smart Card

Bridge media slot

The computer is equipped with a Bridge media slot that can accommodate some kinds of memory media with various memory capacities so that you can easily transfer data from devices, such as digital cameras and Personal Digital Assistants.



- *Keep foreign objects out of the Bridge media slot. Never allow metal objects, such as screws, staples and paper clips, to enter the computer or Keyboard. Foreign metal objects can create a short circuit, which can cause computer damage and fire, possibly resulting in serious injury.*
- *Memory Stick Duo is not compatible with the Bridge media slot. Do not insert Memory Stick Duo into the slot or you may not be able to remove it. Data may be lost or damaged if you use any memory media other than those supported.*



- *This Bridge media slot supports the following memory media.*
 - *Secure Digital (SD) Card (SD memory card, SDHC memory card, miniSD Card, microSD Card)*
 - *Memory Stick (Memory Stick, Memory Stick PRO, Memory Stick PRO Duo)*
 - *xD picture card*
 - *MultiMediaCard (MMC™)*
- *Please note that an adaptor is required to use miniSD/microSD Card.*
- *Please note that an adaptor is required to use Memory Stick PRO Duo.*
- *Please note that not all memory media have been tested and verified to work correctly. Therefore, it is not possible to guarantee that all memory media will operate properly.*
- *The slot does not support Magic Gate functions.*

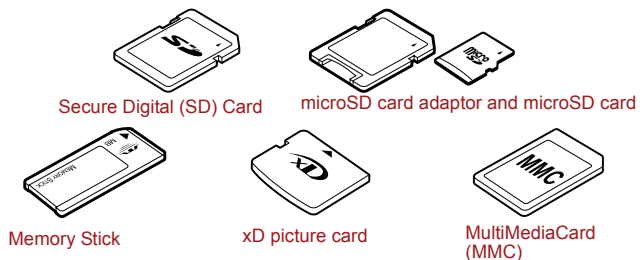

Figure 3-7 Examples of memory media

Memory media

This section provides the important safety precautions in order to handle your memory media.

Points to note about the SD/SDHC memory card

SD/SDHC memory cards comply with SDMI (Secure Digital Music Initiative), which is a technology adopted to prevent unlawful copy or playback of digital music. For this reason, you cannot copy or playback protected material on another computer or other device, and you may not reproduce any copyrighted material except for your personal enjoyment.

Below is a simple explanation for distinguishing SD memory cards from SDHC memory cards.

- SD and SDHC memory cards appear the same externally. However, the logo on SD and SDHC memory cards is different, so pay careful attention to the logo when purchasing.



- The SD memory card logo is ().

- The SDHC memory card logo is ().

- The maximum capacity of SD memory cards is 2GB. The maximum capacity of SDHC memory cards is 16GB.

Card Type	Capacities
SD	8MB, 16MB, 32MB, 64MB, 128MB, 256MB, 512MB, 1GB, 2GB
SDHC	4GB, 8GB, 16GB

Memory media format

New media cards are formatted according to specific standards. If you wish to reformat a media card, be sure to do so with a device that uses media cards.

Formatting an SD/SDHC memory card

SD/SDHC memory cards are sold already formatted in conformity to specific standards. If you format the SD/SDHC memory card again, be sure to format it with the TOSHIBA SD Memory Card Format utility, not with the format command provided within Windows.

In order to run the TOSHIBA SD Memory Card Format utility, click **Start -> All Programs -> TOSHIBA -> Utilities -> SD Memory Card Format**.



The TOSHIBA SD Memory Card Format utility does not format the protected area of the SD/SDHC memory card - should you need to format all areas of the memory card, including the protected area, you will need to obtain an appropriate application that applies the copy protection system.

Media care

Observe the following precautions when handling the card.

Card care

- Do not twist or bend cards.
- Do not expose cards to liquids or store in humid areas or lay media close to containers of liquid.
- Do not touch the metal part of a card or expose it to liquids or let it get dirty.
- After using card, return it to its case.
- The card is designed so that it can be inserted only one way. Do not try to force the card into the slot.
- Do not leave a card partially inserted in the slot. Press the card until you hear it click into place.

Memory card care

- Set the write-protect switch to the lock position, if you do not want to record data.
- Memory cards have a limited lifespan, so it is important to backup important data.
- Do not write to a card if the battery power is low. Low power could affect writing accuracy.
- Do not remove a card while read/write is in progress.



For more details on using memory cards, see manuals accompanying the cards.

About the write-protect

The following memory media have a function for protect.

- SD Card (SD memory card, SDHC memory card)
- Memory Stick (Memory Stick, Memory Stick PRO, Memory Stick PRO Duo)
- MultiMediaCard (MMC)



Set the write-protect switch to the lock position, if you do not want to record data.

Inserting a memory media

The following instructions apply to all types of supported media devices. To insert a memory media, follow the steps as detailed below:

1. Turn the memory media so that the contacts (metal areas) are face down.
2. Insert the memory media into the Bridge media slot on the side of the computer.

3. Press the memory media gently to ensure a firm connection is made.

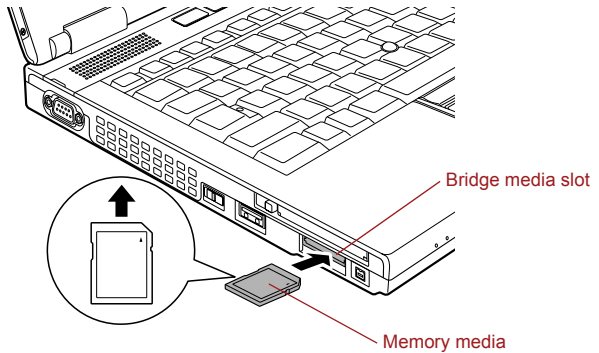

Figure 3-8 Inserting a memory media



- Make sure memory media is oriented properly before you insert it. If you insert the media in wrong direction, you may not be able to remove it.
- When inserting memory media, do not touch the metal contacts. You could expose the storage area to static electricity, which can destroy data.
- Do not turn the computer off or switch to Sleep Mode or Hibernation Mode while files are being copied - doing so may cause data to be lost.

Removing a memory media

The following instructions apply to all types of supported media devices. To remove a memory media, follow the steps as detailed below:

1. Open the **Safely Remove Hardware** icon on the Windows Taskbar.
2. Point to **memory media** and click the left Touch Pad control button.
3. Press the memory media to partially extend it out of the computer.
4. Grasp the media and remove it.

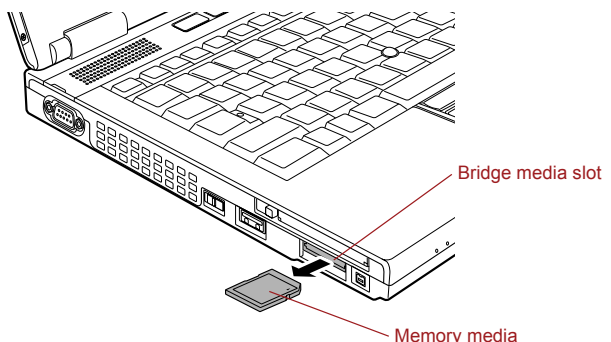

Figure 3-9 Removing memory media



- *Make sure the **Bridge Media slot** indicator is out before you remove the memory media or turn off the computer's power. If you remove the memory media or turn off the power while the computer is accessing the memory media, you may lose data or damage the media.*
- *Do not remove the memory media while the computer is in Sleep or Hibernation Mode. The computer could become unstable or data in the memory media could be lost.*
- *Do not remove only the miniSD/microSD Card while leaving the adaptor in the Bridge Media slot.*

Additional memory module

You can install additional memory into the computer in order to increase the amount of system memory that is available. This section describes how to install and remove optional memory modules.



- *You should place a mat beneath the computer in order to prevent the computer's lid from becoming scratched or damaged when you are installing/replacing the memory module. In this instance you should avoid mats that are made of materials that hold or generate static electricity.*
- *When installing or removing a memory module, you must ensure that you do not touch any other internal areas of the computer.*
- *Insert the two memory modules into Slot A and Slot B respectively. The computer will operate in dual channel mode. You can access the inserted memory modules efficiently in dual channel.*



- *Use only memory modules approved by TOSHIBA.*
- *Do not try to install or remove a memory module under the following conditions.*
 - a. *The computer is turned on.*
 - b. *The computer was shut down in either Sleep or Hibernation Mode.*
 - c. *Wake-up on LAN is enabled.*
 - d. *The wireless communication switch is turned on.*
- *Be careful not to let screws or other foreign matter fall into the computer. It could cause malfunction or electric shock.*
- *Additional memory module is a precision electronic component that may be fatally damaged by static electricity. Since the human body can carry static electricity, it is important that you discharge yourself before touching or installing any additional memory modules. To discharge your body's static electricity, simply touch any metal close to you with bare hands.*

Point to note about memory module error

If you install a memory module that is not compatible with the computer, the **Power** indicator will flash (on for 0.5 seconds, off for 0.5 seconds) in the following ways;

- If there is an error in only Slot A or no memory module is inserted in Slot A: repeatedly flashes orange twice, then green.
- If there is an error in Slot B: repeatedly flashes orange, then green twice.
- If there are errors in both Slot A and Slot B: repeatedly flashes orange twice, then green twice.

In all instances you should shut down the computer and remove the incompatible module(s).



Use a point size 0 Phillips screwdriver to remove and fasten the screws - the use of an incorrect screwdriver can damage the screw heads.

Installing a memory module

To install a memory module, follow the steps as detailed below:

1. Shut down the computer - make sure the **Power** indicator is off (refer to the [Turning off the power](#) section in Chapter 1, Getting Started if required).
2. Remove the AC adaptor and all cables and peripherals connected to the computer.
3. Close the display panel.
4. Turn the computer upside down and remove the battery pack (refer to [Replacing the battery pack](#) section in Chapter 6, Power and Power-Up Modes, if required).
5. Loosen the one screw securing the memory module cover in place - please note that this screw is attached to the cover in order to prevent it from being lost.



Use a point size 0 Phillips screwdriver.

- Slide your fingernail or a thin object under the cover and lift it off.

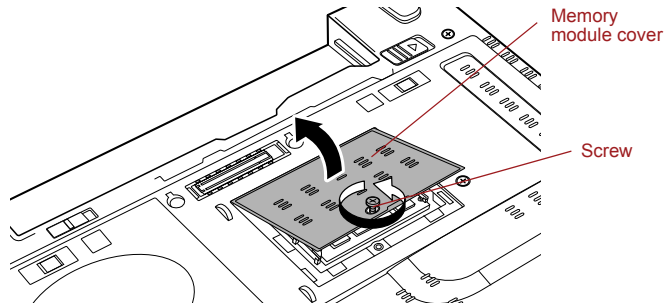

Figure 3-10 Removing the memory module cover

- Align the notch of the memory module with that of the memory slot and gently insert the module into the slot at about a 45 degree angle before holding it down until the latches on either side snap into place.

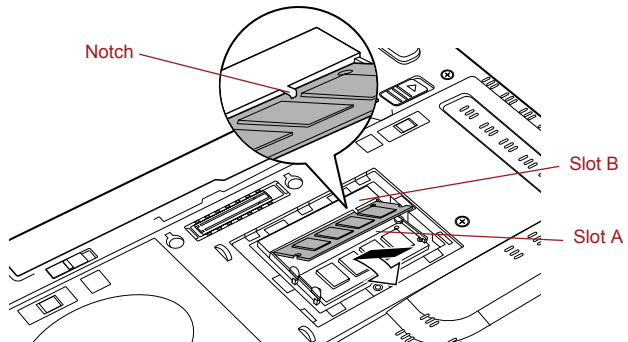

Figure 3-11 Seating the memory module



- **Never allow metal objects, such as screws, staples and paper clips, to enter the computer. Foreign metal objects can create a short circuit, which can cause computer damage and fire, possibly resulting in serious injury.**
- **Do not touch the connectors on the memory module or on the computer. Debris on the connectors may cause memory access problems.**



- The slot A is reserved for the first memory module. Use the slot B for expanded memory. If only one module is installed, use the slot A. When inserting or removing memory modules, use the A and B marked on the computer chassis to determine which slot is A and which is B.
- Align the grooves along the edges of the memory module with the locking tabs on the connector and insert the module into the connector firmly - if you find it difficult to install the memory module, gently prise the locking tabs outwards using the tip of your finger.
Please also ensure that you hold the memory module along its left and right hand edges - the edges with the grooves in.

8. Seat the memory module cover in place and secure it with one screw.



Take care to ensure that the memory module cover is firmly closed.

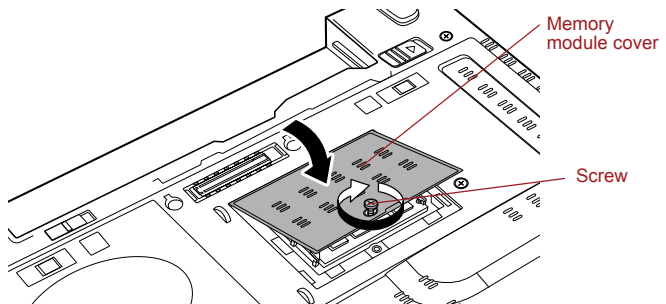

Figure 3-12 Seating the memory module cover

9. Install the battery pack - refer to [Replacing the battery pack](#) section in Chapter 6, Power and Power-Up Modes, if required.
10. Turn your computer over.
11. Turn the computer on and make sure the added memory is recognized - to confirmed it, **Start** -> **Control Panel** -> **System and Security** -> **System** icon.

Removing a memory module

To remove the memory module, follow the steps as detailed below:

1. Shut down the computer - make sure the **Power** indicator is off (refer to the [Turning off the power](#) section in Chapter 1, Getting Started if required).
2. Remove the AC adaptor and all cables and peripherals connected to the computer.
3. Close the display panel.
4. Turn the computer upside down and remove the battery pack (refer to [Replacing the battery pack](#) section in Chapter 6, Power and Power-Up Modes, if required).

5. Loosen the one screw securing the memory module cover in place - please note that this screw is attached to the cover in order to prevent it from being lost.
6. Slide your fingernail or a thin object under the cover and lift it off.
7. Push the latches away from the module in order to release it - a spring will force one end of the module up at an angle.
8. Grasp the module by its edges and remove it from the computer.



- *If you use the computer for a long time, the memory modules and the circuits locating close to the memory modules will become hot. In this case, let them cool to room temperature before you replace them. Or you will get burnt if you touch any of them.*
- *Do not touch the connectors on the memory module or on the computer. Debris on the connectors may cause memory access problems.*

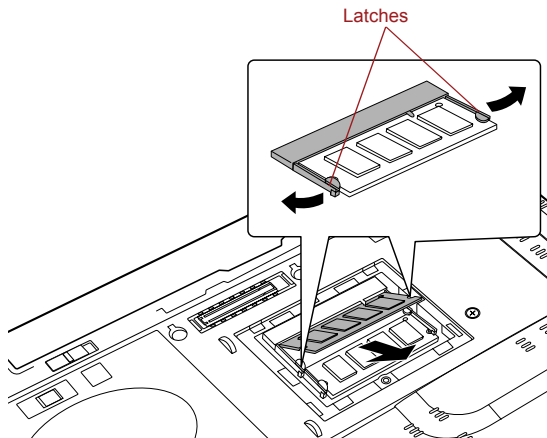

Figure 3-13 Removing the memory module

9. Seat the memory module cover in place and secure it with one screw.



Take care to ensure that the memory module cover is firmly closed.

10. Install the battery pack - refer to [Replacing the battery pack](#) section in Chapter 6, Power and Power-Up Modes, if required.
11. Turn your computer over.

External monitor

An external analog monitor can be connected to the external monitor port on the computer. To connect a monitor, follow the steps as detailed below:

Connecting the monitor cable

1. Turn the computer's power off.
2. Connect the monitor cable to the external monitor port and tighten the screws on the left and right hand side of the connector as required.

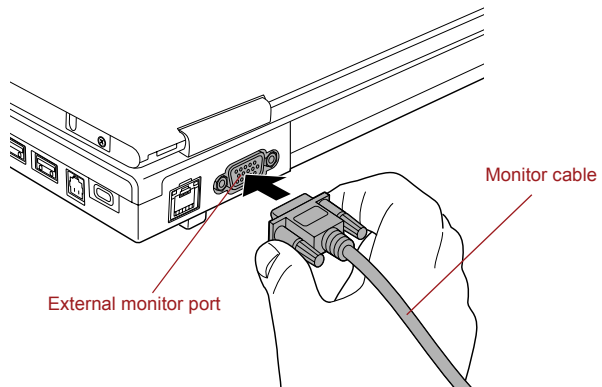

Figure 3-14 Connecting the monitor cable to the external monitor port

3. Turn the external monitor's power on.
4. Turn the computer's power on.

When you turn on the power, the computer will automatically recognize the monitor and determine whether it is a color or monochrome device. In the event that you find that there are issues getting an image displayed on the correct monitor, you should consider using the **FN + F5** hot key to change the display settings (if you then disconnect the external monitor before you turn the computer's power off, be sure to press **FN + F5** hot key again to switch to the internal display).

Please refer to Chapter 5, *The Keyboard*, for further details on using hot keys to change the display setting.



Do not disconnect the external monitor while in Sleep or Hibernation Mode. Turn off the computer before disconnecting the external monitor.

When displaying desktop at external analog monitor, desktop is sometimes displayed on the center of the monitor with black bars around desktop (with small size).

At that time, please read the manual of the monitor and set the display mode which is supporting at the monitor. Then it will be displayed with suitable size with correct aspect ratio.

USB FDD Kit

The USB floppy diskette drive accommodates either a 1.44MB or 720KB floppy diskette and connects to one of the computer's USB ports.

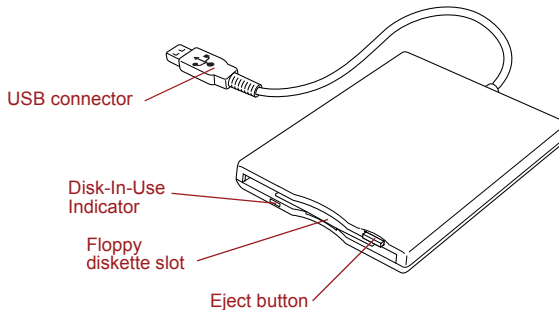

Figure 3-15 The USB floppy diskette drive

Connecting the USB floppy diskette drive

To connect the drive, plug the floppy diskette drive's USB connector into a computer's USB port.



Make sure the connector is properly aligned with the socket. Do not try to force the connection, doing so can damage the connecting pins.

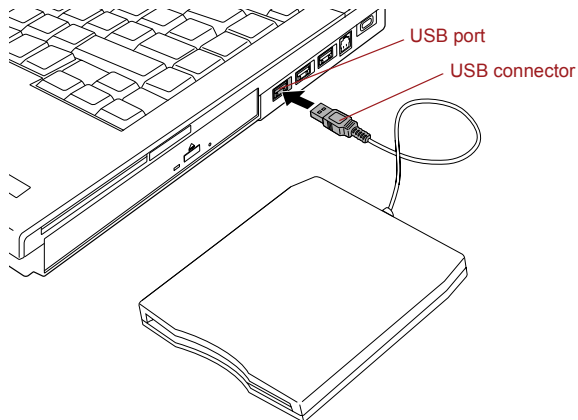

Figure 3-16 Connecting the USB floppy diskette drive



If you connect the USB floppy diskette drive after the computer has already been turned on, it will take about ten seconds for it to be recognized by the computer. Do not attempt to disconnect and reconnect the drive before this period has elapsed.

Disconnecting the USB floppy diskette drive

When you have finished using the USB floppy diskette drive, you can follow the procedures below in order to disconnect it:

1. Wait for the Disk-In-Use Indicator light to go out to make sure all floppy diskette activity has stopped.



If you disconnect the USB floppy diskette drive or turn off the power while the computer is accessing the drive you may lose data or damage the floppy diskette or the drive.

2. Click the **Safely Remove Hardware** icon on the Windows Taskbar.
3. Click the USB floppy diskette drive device that you want to remove.
4. Carefully pull the floppy diskette drive's USB connector out from within the computer's USB port.

eSATA (External Serial ATA)

A device corresponding to eSATA function can be connected to the eSATA/USB combo port on the computer.

Connecting the eSATA device

To connect an eSATA device, follow the steps as detailed below:

1. Connect an eSATA cable to the eSATA/USB combo port.



Make sure the connector is properly aligned with the socket. Do not try to force the connection, doing so can damage the connecting pins.

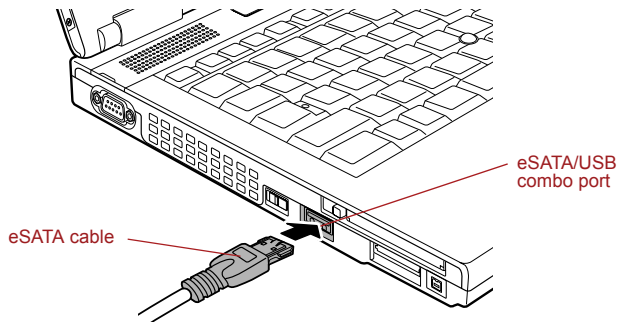

Figure 3-17 Connecting an eSATA cable to the eSATA/USB combo port



- A connected eSATA device may not be recognized if it is connected to the computer's eSATA/USB combo port while the computer is in Sleep Mode or Hibernation Mode. If this occurs, disconnect the eSATA device and then reconnect the device while the computer is turned on.
- If you connect an eSATA device after the computer has already been turned on, it will take about ten seconds for it to be recognized by the computer.
Do not attempt to disconnect and reconnect the drive before this period has elapsed.

Disconnecting an eSATA device

When you have finished using an eSATA device, you can follow the procedures below in order to disconnect it:

1. Wait for the indicator light of an eSATA device to go out to make sure all activity has stopped.



If you disconnect an eSATA device or turn off the power while the computer is accessing the drive you may lose data or damage an eSATA device or the drive.

2. Click the **Safely Remove Hardware** icon on the Windows Taskbar.
3. Click an eSATA device that you want to remove.
4. Carefully pull an eSATA device's eSATA/USB combo connector out from within the computer's eSATA/USB combo port.

i.LINK (IEEE1394)

i.LINK (IEEE1394) is used for high-speed data transfer for a range of compatible devices such as:

- Digital video cameras
- Hard disk drives
- MO drives
- Writable optical disc drives

Some models are equipped with a i.LINK (IEEE1394) port.



i.LINK uses a four-pin connector, which does not carry any electric current. External devices will need their own power supply to operate.

Precautions

- Make a back-up of your data before transferring it to the computer. There is a possibility that the original data will be damaged. There is a particular risk that some frames will be deleted in the case of digital video transfer. TOSHIBA assumes no liability for such loss of data.
- Do not transfer data in areas where static electricity is easily generated or in areas subjected to electronic noise. Data can be destroyed.

- If you are transferring data through an IEEE1394 hub, do not connect or disconnect other devices from the hub during data transfer. There is a likelihood that data will be damaged. Connect all devices to the hub before you turn on the computer's power.
- You may not use any copyrighted video or music data copied from a video camera except for your personal enjoyment.
- If you connect/disconnect an i.LINK device to/from another i.LINK device that is currently exchanging data with the computer, data frames might be dropped.
- Make sure data transfer has ended or turn off the computer, before you:
 - Connect/disconnect an i.LINK device to/from the computer.
 - Connect/disconnect an i.LINK device to/from another i.LINK device that is connected to the computer.

Connecting the i.LINK (IEEE1394) cable

To connect the i.LINK (IEEE1394) cable, follow the steps as detailed below:

1. Make sure the connectors are properly aligned and plug the i.LINK (IEEE1394) cable into the computer.

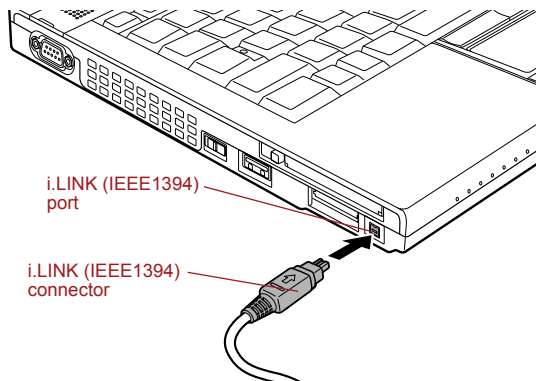

Figure 3-18 Connecting the i.LINK (IEEE1394) cable into the computer

2. Plug the other end of the cable into the device.

Note the following when you use i.LINK:

- You may need to install drivers for your i.LINK devices.
- Not all i.LINK devices have been tested. Therefore, compatibility with all i.LINK devices cannot be guaranteed.
- Some devices might not support sleep or automatic off functions.
- Do not connect or disconnect an i.LINK device while it is using an application or when the computer is automatically shutting it down to save power. Data might be destroyed.

Disconnecting the i.LINK (IEEE1394) cable

To disconnect the i.LINK (IEEE 1394) cable, follow the steps as detailed below:

1. Open the **Safely Remove Hardware** icon on the Windows Taskbar.
2. Point to **i.LINK (IEEE1394) device** and click.
3. Disconnect the cable from the computer then from the i.LINK device.



Refer also to the documentation that came with your i.LINK device.

Serial port

The serial connector can be used to connect to RS-232C compatible devices.

RS-232C compatible devices include the following:

- Modem
- Mouse
- Printer

Some models are equipped with a serial port.

To connect a serial port, follow the steps as detailed below:

1. Turn the computer's power off.
2. Connect the serial connector to the serial port and tighten the screws on the left and right hand side.

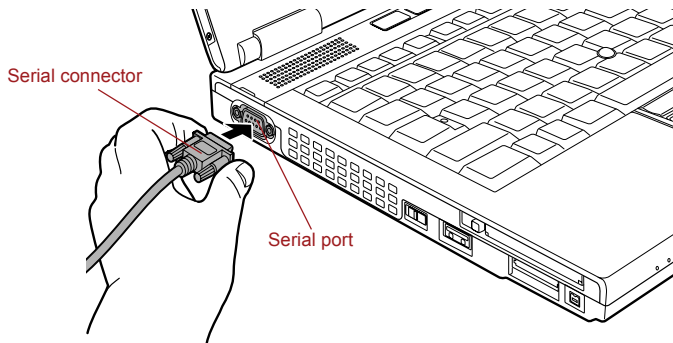

Figure 3-19 Connecting the serial connector to the serial port

TOSHIBA Express Port Replicator

In addition to the ports available on the computer, the TOSHIBA Express Port Replicator also provides several kinds of ports. The TOSHIBA Express Port Replicator connects directly to the docking interface on the underside of the computer. The AC adaptor connects the TOSHIBA Express Port Replicator to a power source.



The computer must be configured properly before connecting to a LAN. Logging onto a LAN using the computer's default settings could cause a malfunction in LAN operation. Check with your LAN administrator regarding set-up procedures.



- You must connect the AC adaptor before you connect to a TOSHIBA Express Port Replicator.
- When a TOSHIBA Express Port Replicator is connected to the computer, you can not use the following computer's ports: LAN jack, DC IN 15V jack and External monitor port.
- When connecting an AC Adaptor to the TOSHIBA Express Port Replicator, use only the AC Adaptor included with TOSHIBA Express Port Replicator. Do not use the computer's AC Adaptor.

The following ports are available on the TOSHIBA Express Port Replicator.

- RJ45 LAN jack
- External monitor port
- DC IN 15V jack
- Security lock slot
- Universal Serial Bus 2.0 port (four)
- DVI port



- As the port operation of all DVI (Digital Visual Interface) monitors has not been confirmed, some DVI monitors may not function properly.
- Set the TOSHIBA Express Port Replicator's Slide Adjuster to SLIDE position #3 or #5 when connecting this computer to the TOSHIBA Express Port Replicator. Refer to the TOSHIBA Express Port Replicator User's Manual for more details on connection methods.

Security lock

A security locks enable you to anchor your computer a desk or other heavy object in order to help prevent unauthorized removal or theft. The computer has a security lock slot on its right side into which you can attach one end of the security cable, while the other end attaches to a desk or similar object. The methods used for attaching security cables differ from product to product. Please refer to the instructions for the product you are using for more information.

Connecting the security lock

In order to connect a security cable to the computer, follow the steps as detailed below:

1. Turn the computer so its right hand side faces you.
2. Align the security cable with the lock slot and secure it in place.

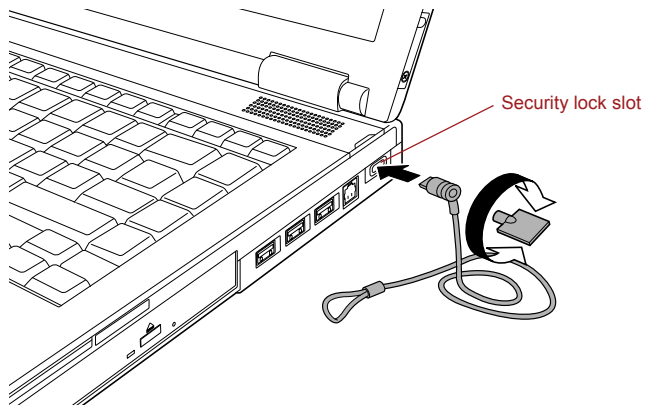

Figure 3-20 Security lock

Optional accessories

You are able to add a number of options and accessories in order to make your computer even more powerful and convenient to use. For reference, the following list details some of the items that are available from your reseller or TOSHIBA dealer:

DDR2-667 Memory Kit	A 512MB, 1,024MB or 2,048MB memory module (DDR2-667) can easily be installed in the computer.
DDR2-800 Memory Kit	A 1,024MB, 2,048MB or 4,096MB memory module (DDR2-800) can easily be installed in the computer.
Universal AC Adaptor	If you frequently use your computer at more than one site, it may be convenient to purchase an additional AC adaptor to be kept at each site in order to remove the need to always carry the adaptor with you.
Battery Pack	An additional battery pack can be purchased for use as either a spare or replacement. Please refer to Chapter 6, <i>Power and Power-Up Modes</i> for further information.
High Capacity Battery Pack	An additional battery pack can be purchased for use as either a spare or replacement.
Extended Capacity Battery Pack	An additional battery pack can be purchased for use as either a spare or replacement.
Battery Charger	The optional battery charger allows you to charge extra battery packs outside of having to use the computer.
USB FDD Kit	The USB floppy diskette drive accommodates either a 1.44MB or 720KB floppy diskette through connection to one of the computer's USB ports. In use, please be aware that, while you cannot format 720KB floppy diskettes under Windows 7, you are able to read and write to diskettes that have already been formatted.
TOSHIBA Express Port Replicator	The TOSHIBA Express Port Replicator provides the ports available on the computer in addition to a digital visual interface (DVI) port, External monitor port, four Universal Serial Bus ports (USB 2.0) and a LAN jack.

Chapter 4

Operating Basics

This chapter describes the basic operations of your computer, highlights the precautions that should be taken when using it.

TOSHIBA Dual Pointing Device

Some models are equipped with a dual point system: a Touch Pad and an AccuPoint pointing stick.

Using the Touch Pad

To use the Touch Pad, simply touch and move your fingertip across it in the direction you want the on-screen pointer to go.

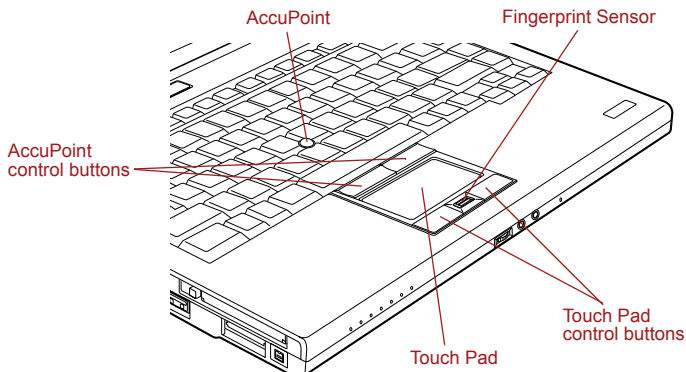

Figure 4-1 Touch Pad and Touch Pad control buttons

The two buttons below the Touch Pad are used like the buttons on a standard mouse - press the left button to select a menu item or to manipulate text or graphics designated by the pointer, and press the right button to display a menu or other function depending on the software you are using.



You can also tap the Touch Pad to perform functions similar to those of the left button on a standard mouse.

Click: Tap once

Double-click: Tap twice

Drag and drop: Tap to select the item(s) you want to move, leave your finger on the Touch Pad after the second tap and then move the item(s) to their new destination.

Using the AccuPoint

To use the AccuPoint, simply push it with your finger tip in the direction you want to move the on-screen pointer.

Two buttons above the Touch Pad work in the same way with the AccuPoint as they do with the Touch Pad. Refer to the [Using the Touch Pad](#) section for details.

Some models are equipped with an AccuPoint.

AccuPoint precautions

Certain conditions can affect the on-screen pointer when using AccuPoint. For example, the pointer may travel contrary to AccuPoint operation or an error message may appear, if

- You touch the AccuPoint during power-up.
- You apply constant, soft pressure during power-up.
- There is a sudden temperature change.
- Strong stress is applied to the AccuPoint.

If an error message appears, reboot the computer. If an error message does not appear, wait a moment for the pointer to stop, then continue operation.

Replacing the cap

The AccuPoint cap is an expendable item that should be replaced after prolonged use. The spare AccuPoint cap is supplied with some models.

1. To remove the AccuPoint cap, firmly pinch the cap and pull it straight up.

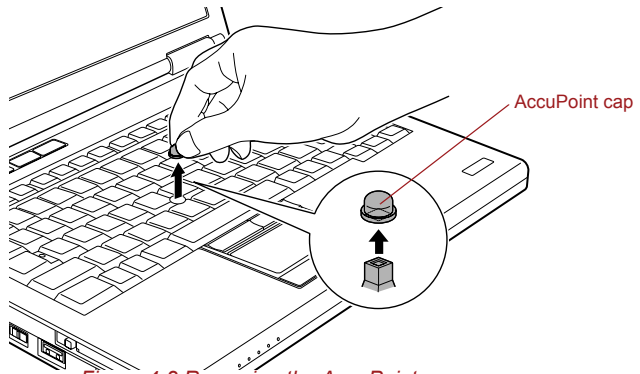

Figure 4-2 Removing the AccuPoint cap

2. Position a new cap on the peg and press it into place.



The peg is square, so be careful to align the cap's square hole with the peg.

Using the Fingerprint Sensor

This product has a fingerprint utility installed for the purpose of enrolling and recognizing fingerprints. By enrolling the ID and password onto the fingerprint authentication feature, it is no longer necessary to input the password from the keyboard. Fingerprint feature enables you to:

- Logon to Windows and access a security enabled homepage through Internet Explorer.
- Files and folders can be encrypted/decrypted and third party access to them prevented.
- Disable the password-protected screen-saver when returning from a power-saving mode such as Sleep Mode.
- Authentication of the User Password (and, if applicable, the HDD (Hard Disk Drive) Password) when booting up the computer (boot authentication).
- Single Sign-On feature



Fingerprint cannot be used in models that do not have a fingerprint module installed.

How to Swipe your Finger

Using the following steps when swiping fingers for fingerprint registration or authentication will help to minimize authentication failures:

Align the first joint of the finger to the center of the sensor. Lightly touch the sensor and swipe finger levelly towards you until the sensor surface becomes visible. In performing this process, you should also take care to ensure that the center of your fingerprint is on the sensor.

The following illustrations show the recommended way to swipe your finger over the fingerprint sensor.

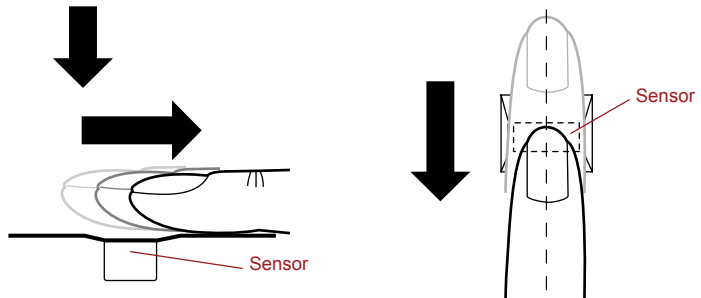

Figure 4-3 Swipe the finger



- *Avoid swiping with your finger stiff or pressed too hard onto the sensor, and take care to ensure that the center of the fingerprint is touching the sensor before swiping. Either of these conditions may cause fingerprint reading to fail.*
- *Check the center of the fingerprint whorl before swiping and then ensure this is swiped along the center line of the sensor.*
- *There is a possibility of authentication failures if the finger is swiped too quickly or too slowly - follow any on-screen instructions to adjust the speed used during the swipe process.*

Points to note about the Fingerprint Sensor

Please be aware of the following considerations when using the fingerprint sensor. A failure to follow these guidelines might result in damage to the sensor, sensor failure, fingerprint recognition problems or a lower fingerprint recognition success rate.

- Do not scratch or poke the sensor with your nails or any hard or sharp objects.
- Do not press the sensor strongly.
- Do not touch the sensor with a wet finger or any wet objects - keep the sensor surface dry and free from water vapor.
- Do not touch the sensor with a soiled or dirty finger as minute foreign particles of dust and dirt may scratch it.
- Do not paste stickers or write on the sensor.
- Do not touch the sensor with a finger or any other object which may have a build-up of static electricity on it.

Observe the following before you place your finger on the sensor whether for fingerprint enrollment/registration or recognition.

- Wash and dry your hands thoroughly.
- Remove static electricity from your fingers by touching any metal surface. Static electricity is a common cause of sensor failures, especially when the weather is dry.
- Clean the sensor with a lint-free cloth - do not use detergent or any other chemicals to clean the sensor.
- Avoid the following finger conditions for enrollment or recognition as they may result in fingerprint enrollment errors or a drop in the fingerprint recognition success rate
 - Soaked or swollen finger, for example as may occur after taking a bath.
 - Injured finger
 - Wet finger
 - Soiled or oily finger
 - Extremely dry skin condition on finger

Observe the following to improve the fingerprint recognition success rate.

- Enroll two or more fingers.
- Enroll additional fingers if a recognition failure often occurs when using already enrolled fingers.
- Check the condition of your finger - any conditions which have changed since enrollment, such as injury, rough skin, and extremely dry, wet, soiled, dirty, oily, soaked or swollen fingers, may lower the recognition success rate. Also if the fingerprint is worn down or the finger becomes thinner or fatter, the recognition success rate may be lowered.
- As the fingerprint for each finger is different and unique you should ensure that only the registered or enrolled fingerprint or fingerprints are used for identification.

- Check the position and speed at which you swipe your finger across the sensor - please refer to the preceding drawing.
- The fingerprint sensor compares and analyzes the unique characteristics in a fingerprint. However, there may be instances where certain users are unable to register their fingerprints due to insufficient unique characteristics in their fingerprints.
- The recognition success rate may differ from user to user.

Points to note about Fingerprint Utility

- If Windows 7 file encryption function EFS (Encryption File System) is used to encrypt a file, the file cannot be further encrypted using the encryption function of this software.
- You can back up the fingerprint data or the information registered to Automatic password input in IE.
- Please use Import/Export on TOSHIBA Fingerprint Utility main menu.
- Please also refer to the fingerprint utility Help file for more information. You can start it using the following method:
 - Click **Start -> All Programs -> TOSHIBA -> Utilities -> TOSHIBA Fingerprint Utility**. The main screen is displayed. Click ? in the lower left corner of the screen.

Fingerprint utility limitations

TOSHIBA does not guarantee that the fingerprint utility technology will be completely secure or error-free, or that it will accurately screen out unauthorized users at all times. TOSHIBA is not liable for any failure or damage that might arise out of the use of the fingerprint software.



- *The fingerprint sensor compares and analyzes the unique characteristics in a fingerprint. However, there may be instances where certain users are unable to register their fingerprints due to insufficient unique characteristics in their fingerprints.*
- *The recognition success rate may differ from user to user.*

Setup Fingerprint Registration

Please use the following procedure when first using fingerprint authentication.



- *In use, the fingerprint authentication system will use the same username and password as defined within the Windows operating system. If no Windows password has been configured, you must do this before starting the fingerprint registration process.*
- *This sensor has the memory space for at least twenty fingerprint patterns. You might be able to register more fingerprint patterns depending on the sensor memory usage.*

1. Click **Start -> All Programs -> TOSHIBA -> Utilities -> TOSHIBA Fingerprint Utility**, or click the Fingerprint utility icon in the Taskbar.

2. The **Enroll** screen is displayed. Enter the current account password into the **Windows Password** field. If no Windows password has been configured, you will be asked to configure the new logon password. Then click **Next**.
3. Click the non-enrolled finger icon above the finger you want to register and then click **Next**.
4. The note for enrollment operation screen is displayed. Confirm the message and then click **Next**.
5. The scanning practice screen is displayed. You are able to practice swiping (three times) your finger to ensure you use the correct method. When you have finished practicing swiping your finger, click **Next**.
6. Swipe three times with the same finger. If scanning of fingerprint succeeds, "**Enrollment succeed. Do you want to save this fingerprint?**" message box will appear. Click **OK**.
7. The following message will be displayed: "**It is strongly recommended you enroll one more finger.**" Click **OK** and repeat Step 3, 4, 5 and 6 with another finger.



- *It is strongly recommended that you register 2 or more fingerprints.*
- *You cannot enroll the same fingerprint more than once, even on a different user account.*

Delete the Fingerprint Data

Saved fingerprint data is stored in special non-volatile memory inside the fingerprint sensor. Therefore, if you give the computer to someone else, or dispose of it in any way, the following process is recommended to delete your fingerprint information:

Delete the fingerprint data for the currently logged in user

1. Click **Start** -> **All Programs** -> **TOSHIBA** -> **Utilities** -> **TOSHIBA Fingerprint Utility**, or double click the utility icon in the Taskbar.
2. Swipe your finger across the fingerprint sensor.
3. The **TOSHIBA Fingerprint Utility** main menu is displayed. Select **Enroll** in the main menu.
4. In the **Enroll** window, it enables you to delete the fingerprint data for the currently logged in user. Click an enrolled finger you want to delete. "**Are you sure you want to delete this template?**" message box will appear on the screen and then click **OK** button. If you want to delete other fingerprints, repeat this step. If only one fingerprint is registered, the message "**Sorry! At least one fingerprint is required**" will appear after clicking **OK**. You are not allowed to delete a unique fingerprint.
5. Click **Close**.
6. "**Are you sure you want to quit?**" is displayed. Click **OK**. It will be returned to the **TOSHIBA Fingerprint Utility** main menu.

Delete all users fingerprints

1. In the **TOSHIBA Fingerprint Utility** main menu, click **Run as administrator** in the lower left.
2. User Account Control window is displayed. Click **Yes**.
3. Swipe your enrolled finger.
4. Select **Fingerprint Control** option.
5. A list of fingerprint information for all users is shown in the screen. Click **Delete All** in the lower right.
6. "Are you sure you want to delete all fingerprints?" message box will appear on the screen. Click **OK**.
7. Click **Close**.
8. "Are you sure you want to quit?" is displayed. Click **OK**. It will be returned to the **TOSHIBA Fingerprint Utility** main menu.

Windows Logon via Fingerprint Authentication

In place of the usual Windows logon by ID and password, fingerprint authentication also allows logon to Windows.

This is useful especially when many users are using the PCs, as user selection can be skipped.

Fingerprint Authentication Procedure

1. Start up the computer.
2. The Logon Authorization screen is displayed. Choose any of the enrolled fingers and swipe the fingerprint on the sensor. If authentication is successful, the user will be logged on to Windows.



- *If the fingerprint authentication fails, please logon using the Windows logon password.*
- *Please logon using the Windows logon password if the fingerprint authentication failed for five times. To logon using the Windows logon password, enter the Windows logon password at the [Welcome] screen as normal.*
- *A warning message will be displayed when authentication is abnormal or authentication is not successful within a fixed duration.*

Fingerprint boot authentication and Single Sign-on feature

Overview about Fingerprint boot authentication

The fingerprint authentication system can be used to replace the keyboard based User Password authentication system when booting up.

If you do not want to use the fingerprint authentication system for password authentication when booting up, but prefer to use the keyboard-based system instead, click the user's tile when the Fingerprint System Authentication screen is displayed. This will switch the password input screen across to the keyboard-based one.



- You must ensure that you use the TOSHIBA Password Utility to register a User Password before using the Fingerprint boot authentication and its extended function to allow fingerprints to be used to access the computer when it is turned on.
- If the fingerprint authentication process fails five times, a preset time limit is exceeded, or you press the **BACK SPACE** key, [Password =] will be displayed on the screen and you will have to enter either the User Password or Supervisor Password manually in order to start the computer.
- When swiping your finger, please ensure that you do it slowly and at a constant speed. If you find that this does not improve the authentication rate, you should try to adjust the speed at which the finger is swiped.
- If there are any changes in the environment or settings related to authorization, you will be required to provide authorization information such as a User Password (and, if applicable, the HDD(Hard Disk Drive) password).

Overview about Fingerprint Single Sign-on feature

This is a feature that allows the user to complete the authentication for both the User/BIOS Password (and, if applicable, the HDD(Hard Disk Drive) Password) and logging onto Windows using only one fingerprint authentication when booting up.

It is necessary to register the User/BIOS Password and Windows Logon Password before using the Fingerprint boot authentication and this Fingerprint Single Sign-On Feature. Please use the TOSHIBA Password Utility to register your User/BIOS Password. If Windows Logon is not the default for your system, see Manual to register your Windows Logon Password.

Only one fingerprint authentication is required to replace the User/BIOS Password (and, if applicable, the HDD(Hard Disk Drive) Password) and the Windows Logon Password.

How to Enable Fingerprint boot authentication and Single Sign-On feature

It is necessary to first enroll your fingerprint with the TOSHIBA Fingerprint Utility prior to enabling and configuring the boot authentication and Single Sign-On feature. You should check that your fingerprint is enrolled before configuring the settings.

1. Logon as Administrator (means a user has administrator privileges).
2. Click **Start -> All Programs -> TOSIHBA -> Utilities -> TOSHIBA Fingerprint Utility**.
3. Swipe your finger across the fingerprint sensor.
4. The **TOSHIBA Fingerprint Utility** main menu is displayed. Click **Run As Administrator** in lower left.
5. User Account Control window is displayed. Click **Yes**.
6. Swipe your finger across the fingerprint sensor.

7. Select **Setting** in the main menu to open the Setting window, you can
 - Select **Boot authentication** check box if you want to use the fingerprint boot authentication feature.
 - Select **Boot authentication** and **Single sign-on** check boxes if you want to use the Single Sign-on feature.
8. Click **Apply**.
9. "**Save succeeded**" is displayed. Click **OK**.
10. Click **Close**.
11. "**Are you sure you want to quit?**" is displayed. Click **OK**. It will be returned to the **TOSHIBA Fingerprint Utility** main menu.

This modified configuration for fingerprint boot authentication and Single Sign-on feature becomes effective the next time the system is booted up.

Web Camera

Web Camera is a device that allows you to record video or take photographs with your computer. You can use it for video chatting or video conferences using a communication tool such as **Windows Live Messenger**. **TOSHIBA Web Camera Application** will help you to add various video effects to your video or photograph.

Enables the transmission of video and use of video chat via the internet using specialized applications.

The effective pixel count for this web camera is 0.3 million (maximum photograph size: 640x480 pixels) or 1.31 million (maximum photograph size: 1280x1024 pixels).

Some models are equipped with a Web Camera.

Please refer to the Web Camera Application Online Help for details.

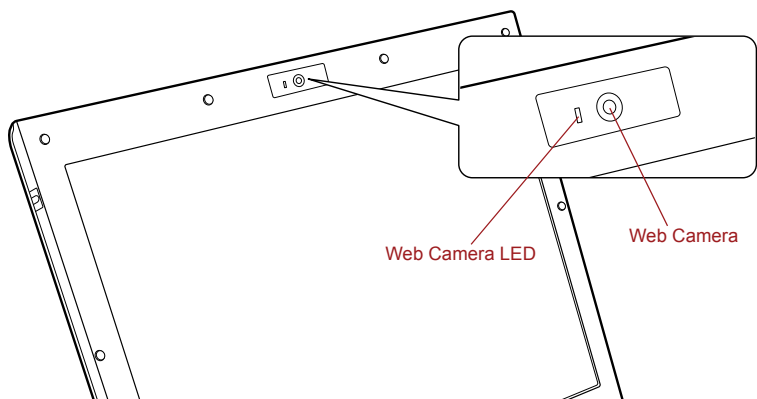

Figure 4-4 Web Camera



- *Do not point the web camera directly at the sun.*
- *Do not touch or press strongly on the web camera lens. Doing so may reduce image quality. Use an eyeglass cleaner (cleaner cloth) or other soft cloth to clean the lens if it becomes dirty.*
- *Setting the [Size] to more than "800x600" will cause a larger amount of data to be written to the hard disk drive and may interfere with smooth recording.*
- *When recording in dimly lit environments, select "Night Mode" which allows for brighter images with less noise.*

Using the TOSHIBA Face Recognition

TOSHIBA Face Recognition uses a face verification library to verify the face data of users when they log in to Windows. The user can thus avoid having to enter a password or the like, which makes the login process easier.



- *TOSHIBA Face Recognition does not guarantee the correct identification of a user. Changes to the likeness of a registrant, such as hair style changes, wearing a cap, or wearing glasses may effect the recognition rates when such changes occur after the registrant had registered.*
- *TOSHIBA Face Recognition may incorrectly recognize faces that are similar to a registrant.*
- *For high security purposes, TOSHIBA Face Recognition is not a suitable substitute for Windows passwords. When security is a high priority, use your established Windows passwords to log in.*
- *Bright background light and/or shadows may prevent a registrant from being recognized correctly. In that case, log in using your Windows password. If recognition of a registrant fails repeatedly, refer to your computer documentation to learn ways to improve recognition performance.*
- *TOSHIBA Face Recognition records face data in a log when face recognition fails. When transferring ownership or disposing of your computer, please uninstall the application or delete all the logs created by the application. For details on how to do this, see help file.*
- *TOSHIBA Face Recognition can be used only in Windows 7.*

Disclaimer

Toshiba does not guarantee that the face recognition utility technology will be completely secure or error-free. Toshiba does not guarantee that the face recognition utility will accurately screen out unauthorized users at all times. Toshiba is not liable for any failure or damage that might arise out of the use of the face recognition software or utility.

TOSHIBA, ITS AFFILIATES AND SUPPLIERS SHALL HAVE NO RESPONSIBILITY FOR DAMAGE TO OR LOSS OF ANY BUSINESS, PROFITS, PROGRAMS, DATA, NETWORK SYSTEMS OR REMOVABLE STORAGE MEDIA ARISING OUT OF OR RESULTING FROM THE USE OF THE PRODUCT, EVEN IF ADVISED OF THE POSSIBILITY THEREOF.

How to register the Face Recognition Data

Take a picture for facial verification purposes, and register the data needed when you log in. To register the data needed when you log in, follow the steps as described below:

1. To launch this utility, click **Start** -> **All Programs** -> **TOSHIBA** -> **Utilities** -> **Face Recognition**.
 - The **Registration** screen is displayed for a logged-in user whose face has not been registered.
 - The **Management** screen is displayed for a logged-in user whose face has already been registered.
2. Click **Run as administrator** in lower left of the **Management** screen, and then click the **Register** button. The **Registration** screen is displayed.
 - If you wish to practice, click on the **Next** button in the **Registration** screen.
 - If you do not wish to practice, click on the **Skip** button in the **Registration** screen.
3. Click the **Next** button to start the guide. Please follow the guide to practice.
 - Click the **Back** button to practice the guide once more.
4. Click the **Next** button to start image-capturing process. Adjust the position of your face so that it fits within the face-shaped frame.
5. Once your face has been positioned properly, the recording will commence.
Start moving your neck very slightly to the left and right, and then move your neck down and up.
6. Registration will end after you have repeatedly moved your neck left, right, down and up.
When the register succeeds, below message will be displayed on the screen:
"Registration successful. Now we'll do the verification test. Click the Next button."
Click the **Next** button to perform the verification test.
7. Perform the verification test. Face the screen as you do when you register.
 - If verification fails, click the **Back** button and re-register. Please refer to step 6 from step 4.
8. If verification is successful, click the **Next** button and register an account.

9. Register the account.
Fill in all the fields.
10. The **Management** screen is displayed.
The registered account name will be displayed. Clicking on it will cause the captured image of your face to be displayed on the left.

How to Delete the Face Recognition Data

Delete image data, account information, and personal record data created during registration. To delete the Face Recognition Data, follow the steps as described below:

1. To launch this utility, click **Start** -> **All Programs** -> **TOSHIBA** -> **Utilities** -> **Face Recognition**.
The **Management** screen is displayed.
2. Select a user which is displayed in the **Management** screen.
3. Click the **Delete** button. "You are about to delete the user data. Would you like to continue?" will be displayed on the screen.
 - If you do not want the data to be deleted, click the **No** button and you will then be returned to the **Management** screen.
 - Clicking on the **Yes** button will remove the selected user from the **Management** screen.

How to launch the help file

For further information on this utility, please refer to help file.

1. To launch the help file, click **Start** -> **All Programs** -> **TOSHIBA** -> **Utilities** -> **Face Recognition Help**.

Windows Logon via TOSHIBA Face Recognition

This section explains how to login to Windows with TOSHIBA Face Recognition. Two authentication modes are provided.

- **AUTO Mode Login screen:** If the face authentication tile is selected by default, you can log in without using the keyboard or mouse.
- **1:1 Mode Login screen:** This mode is essentially the same as AUTO mode, but the **Select Account** screen will appear before the **Display Captured Image** screen, and you will need to select the user account to be authenticated in order to start the authentication process.

AUTO Mode Login screen

1. Turn on the computer.
2. The **Select Tiles** screen will be displayed.
3. Select **Start face recognition** ().
4. "Please face the camera" will be displayed.

5. Verification will be performed. If the authentication is successful, the image data taken in step 4 will be faded in and placed over one another.
 - If an error occurs during authentication, you will be returned to the **Select Tiles** screen.
6. The Windows **Welcome** screen will be displayed, and will be logged in automatically to Windows.

1:1 Mode Login screen

1. Turn on the computer.
2. The **Select Tiles** screen will be displayed.
3. Select **Start face recognition** ().
4. The **Select Account** screen will be displayed.
5. Select the account, and click the **arrow** button.
6. "**Please face the camera**" will be displayed.
7. Verification will be performed. If the authentication is successful, the image data taken in step 6 will be faded in and placed over one another.
 - If an error occurs during authentication, you will be returned to the **Select Tiles** screen.
8. The Windows **Welcome** screen will be displayed, and will be logged in automatically to Windows.
 - If authentication was successful, but an authentication error subsequently occurred during the login to Windows, you will be asked to provide your account information.

Using optical disc drives

The full-size drive provides high-performance execution of CD/DVD-ROM-based programs. You can run either 12 cm (4.72") or 8 cm (3.15") CD/DVDs without an adaptor. A Serial ATA interface controller is used for CD/DVD-ROM operation. When the computer is accessing a CD/DVD-ROM, an indicator on the drive glows.



Use the DVD playback application to view DVD-Video discs.

If you have a DVD-ROM&CD-R/RW drive, refer also to the [Writing CD/DVDs on DVD Super Multi drives](#) section for precautions on writing to CDs.

If you have a DVD Super Multi drive, refer also to the [Writing CD/DVDs on DVD Super Multi drives](#) section for precautions on writing to CDs/DVDs.

Loading discs

To load CD/DVDs, follow the steps as detailed below:

1. When the computer's power is on, press the eject button to open the disc tray slightly.
2. Grasp the disc tray gently and pull until it is fully opened.

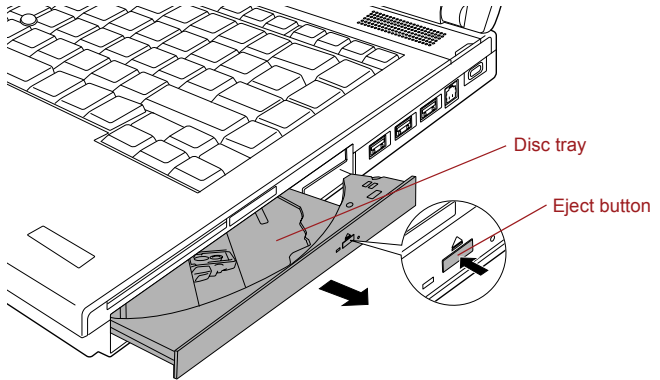

Figure 4-5 Pressing the eject button and pulling the disc tray open

3. Lay the CD/DVD, label side up, in the disc tray.

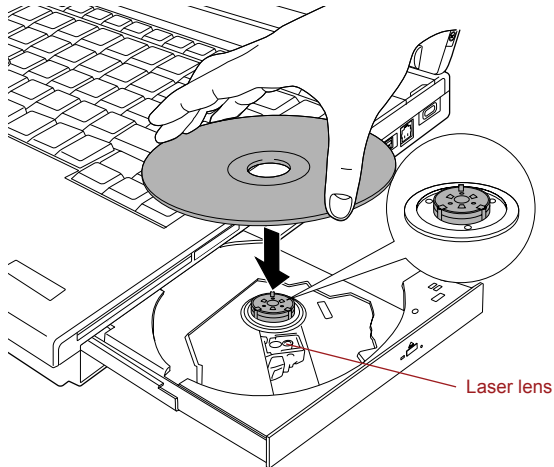

Figure 4-6 Inserting a CD/DVD



When the disc tray is fully opened, the edge of the computer will extend slightly over the CD/DVD tray. Therefore, you will need to turn the CD/DVD at an angle when you place it in the disc tray. After seating the CD/DVD, however, make sure it lies flat.



- *Do not touch the laser lens or any portion of its surrounding casing as this could cause misalignment.*
- *Prevent foreign objects from entering the drive. Check the surface of the disc tray, especially the area behind the front edge of the disc tray, to make sure there are no such objects before closing the drive.*

4. Press gently at the center of the CD/DVD until you feel it click into place. The CD/DVD should lie below the top of the spindle, flush with the spindle base.
5. Push the center of the disc tray to close it. Press gently until it locks into place.



If the CD/DVD is not seated properly when the disc tray is closed, the CD/DVD might be damaged. Also, the disc tray might not open fully when you press the eject button.

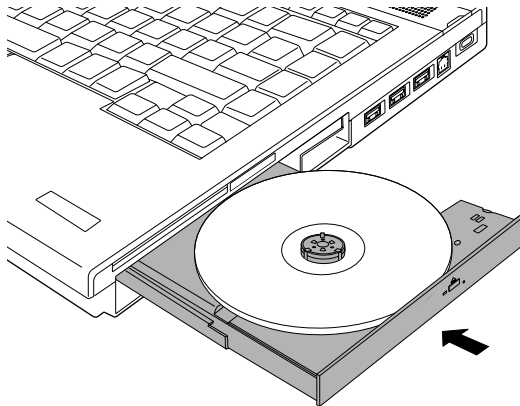

Figure 4-7 Closing the CD/DVD disc tray

Removing discs

To remove the CD/DVD, follow the steps as detailed below:



Do not press the eject button while the computer is accessing the media drive. Wait for the optical disc drive indicator to go out before you open the disc tray. Also, if the CD/DVD is spinning when you open the disc tray, wait for it to stop before you remove it.

1. To pop the disc tray partially open, press the eject button. Gently pull the disc tray out until it is fully opened.



When the disc tray pops open slightly, wait a moment to make sure the CD/DVD has stopped spinning before pulling the disc tray fully open.

- The CD/DVD extends slightly over the sides of the disc tray so you can grasp it. Gently lift out the CD/DVD.

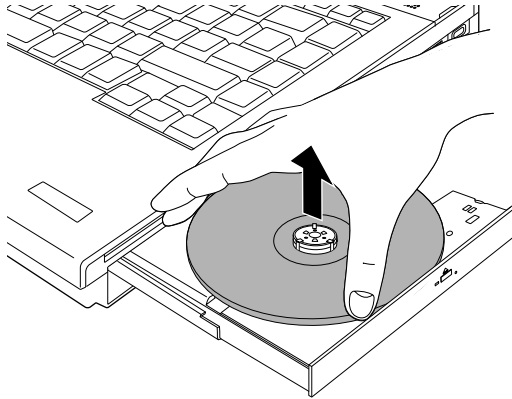

Figure 4-8 Removing a CD/DVD

- Push the center of the disc tray to close it. Press gently until it locks into place.

How to remove CD/DVD when the disc tray will not open

Pressing the eject button will not open the disc tray when the computer power is off. If the power is off, you can open the disc tray by inserting a slender object (about 15 mm) such as a straightened paper clip into the eject hole near the eject button.

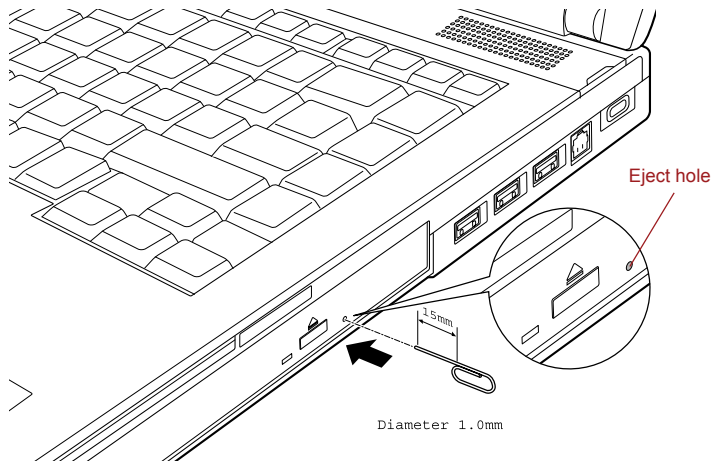

Figure 4-9 Manual release with the eject hole



Turn off the power before you use the eject hole. If the CD/DVD is spinning when you open the disc tray, the CD/DVD could fly off the spindle and cause injury.

Writing CDs on DVD-ROM&CD-R/RW drives

Depending on the type of drive installed, you may be able to write CDs. The DVD-ROM&CD-R/RW drive lets you write as well as read CD-ROMs. Observe the precautions in this section to ensure the best performance for writing CDs. For information on loading and unloading CDs refer to the [Media care](#) section.



- Please refer to the [Writable discs](#), Chapter 2 for details about the types of writable CD and DVD discs that can be supported by this computer.
- Do not turn off the power to the optical disc drive while the computer is accessing it as this may cause you to lose data.
- To write data to CD-R/-RW media, use the **TOSHIBA Disc Creator** feature that is installed on your computer.



When writing information to media using an optical drive, you should always ensure that you connect the AC adaptor to a live power socket. It is possible that, if data is written while powered by the battery pack, the write process may sometimes fail due to low battery power - in these instances data loss may occur.

Before writing or rewriting

- Based on TOSHIBA's limited compatibility testing, we suggest the following manufacturers of CD-R, CD-RW media, however, it must be noted that disc quality can affect write or rewrite success rates. Please also be aware that in no event does TOSHIBA guarantee the operation, quality or performance of any disc.

CD-R:

TAIYO YUDEN CO., Ltd.
 MITSUBISHI KAGAKU MEDIA CO., LTD.
 Ricoh Co., Ltd.
 Hitachi Maxell, Ltd.

CD-RW: (Multi-Speed and High-Speed)

MITSUBISHI KAGAKU MEDIA CO., LTD.
 Ricoh Co., Ltd.

CD-RW: (Ultra-Speed)

MITSUBISHI KAGAKU MEDIA CO., LTD.

- If the disc is poor in quality, or is dirty or damaged, writing or rewriting errors may be noted - ensure that you check all discs for dirt or damage before you use them.
- The actual number of rewrites to CD-RW media will be affected by the quality of the disc itself and the way in which it is used.
- Data written to a CD-R disc cannot be deleted either in whole or in part.

- Data deleted/erased from a CD-RW disc cannot be recovered. You must check the content of the disc carefully before you delete it, taking care that, if multiple drives that can write data to discs are connected, you do not delete data from the wrong one.
- When multiple drives that can write data to discs are connected, be sure that you do not write to or delete data from the wrong drive.
- Be sure to connect the AC adaptor to the computer before you write or rewrite any information.
- Be sure to close all other software programs except for the writing software itself.
- Do not run software such as a screen saver which can put a heavy load on the processor.
- Operate the computer at its full power settings - do not use any power-saving features.
- Do not write information while virus checking software is running, instead wait for it to finish, then disable the virus protection applications, including any software that checks files automatically in the background.
- Do not use any hard disk utilities, including those that are intended to enhance hard disk drive access speeds, as they may cause unstable operation and damage data.
- CD-RW (Ultra Speed +) media should not be used as data may be lost or damaged.
- You should always write from the computer's hard disk drive onto the CD/DVD - do not try to write from shared devices such as a server or any other network device.
- Writing with software other than TOSHIBA Disc Creator has not been confirmed, therefore operation with other software applications cannot be guaranteed.

When writing or rewriting

Please observe the following points while you write or rewrite data to CD-R, CD-RW media:

- Always copy data from the hard disk drive to the optical media - do not use the cut-and-paste function as the original data will be lost if there is a write error.
- Do not perform any of the following actions:
 - Change users in the Windows 7 operating system.
 - Operate the computer for any other function, including such tasks as using a mouse or Touch Pad, or closing/opening the display panel.
 - Start a communication application such as a modem.
 - Apply impact or vibration to the computer.

- Install, remove or connect external devices, including such items as a PC Card, SD/SDHC memory card, miniSD/microSD Card, Smart Card, Memory Stick/Memory Stick PRO/Memory Stick PRO Duo, xD picture card, MultiMediaCard, USB device, external monitor, i.LINK device, or an optical digital device.
- Use the audio/video control button to reproduce music or voice.
- Open the optical disc drive.
- Do not use shut down, log off, Sleep Mode or Hibernation Mode functions while writing or rewriting.
- Make sure that the write/rewrite operation is completed before going into either Sleep Mode or Hibernation Mode (writing is completed if you can remove an optical media on the DVD-ROM&CD-R/RW drive).
- If the media is of poor quality, or is dirty or damaged, writing or rewriting errors may occur.
- Set the computer on a level surface and avoid places subject to vibration such as airplanes, trains or cars. In addition, do not use the computer on an unstable surface such as a stand.
- Keep mobile phones and other wireless communication devices away from the computer.

Writing CD/DVDs on DVD Super Multi drives

You can use the DVD Super Multi drive to write data to either CD-R, CD-RW, DVD-R, DVD-R (Dual Layer), DVD-RW, DVD+R, DVD+R (Double Layer), DVD+RW or DVD-RAM discs. The TOSHIBA Disc Creator is provided as writing software with this computer.



- Please refer to the [Writable discs](#), Chapter 2 for details about the types of writable CD and DVD discs that can be supported by this computer.
- Do not turn off the power to the optical disc drive while the computer is accessing it as this may cause you to lose data.
- To write data to CD-R/-RW media, use the **TOSHIBA Disc Creator** feature that is installed on your computer.



When writing information to media using an optical drive, you should always ensure that you connect the AC adaptor to a live power socket. It is possible that, if data is written while powered by the battery pack, the write process may sometimes fail due to low battery power - in these instances data loss may occur.

Important message

Before you write or rewrite to any of the media supported by the DVD Super Multi Drive, please read and follow all of the setup and operating instructions in this section. If you fail to do so, you may find that the DVD Super Multi drive may not function properly, and you may fail to write or rewrite information successfully - this may cause you to either lose data or incur other damage to the drive or media.

Disclaimer

TOSHIBA does not bear responsibility for the following:

- Damage to any CD-R, CD-RW, DVD-R, DVD-R (Dual Layer), DVD-RW, DVD+R, DVD+R (Double Layer), DVD+RW or DVD-RAM disc that may be caused by writing or rewriting with this product.
- Any change or loss of the recorded contents of CD-R, CD-RW, DVD-R, DVD-R (Dual Layer), DVD-RW, DVD+R, DVD+R (Double Layer), DVD+RW or DVD-RAM media that may be caused by writing or rewriting with this product, or for any business profit loss or business interruption that may be caused by the change or loss of the recorded contents.
- Damage that may be caused by using third party equipment or software.

Given the technological limitations of current optical disc writing drives, you may experience unexpected writing or rewriting errors due to disc quality or problems with hardware devices. In view of this, it is good practice to make two or more copies of important data, in case of any undesired change or loss of the recorded contents.

Before writing or rewriting

- Based on TOSHIBA's limited compatibility testing, we suggest the following manufacturers of CD-R, CD-RW, DVD-R, DVD-R (Dual Layer), DVD-RW, DVD+R, DVD+R (Double Layer), DVD+RW or DVD-RAM media, however, it must be noted that disc quality can affect write or rewrite success rates. Please also be aware that in no event does TOSHIBA guarantee the operation, quality or performance of any disc.

CD-R:

TAIYO YUDEN CO., Ltd.
MITSUBISHI KAGAKU MEDIA CO., LTD.
Ricoh Co., Ltd.
Hitachi Maxell, Ltd.

CD-RW: (Multi-Speed and High-Speed)

MITSUBISHI KAGAKU MEDIA CO., LTD.
Ricoh Co., Ltd.

CD-RW: (Ultra-Speed)

MITSUBISHI KAGAKU MEDIA CO., LTD.

DVD-R:**DVD Specifications for Recordable Disc for General Version 2.0**

TAIYO YUDEN Co.,Ltd. (for 8x and 16x speed media)

MITSUBISHI KAGAKU MEDIA CO., LTD. (for 4x, 8x and 16x speed media)

Hitachi Maxell, Ltd. (for 8x and 16x speed media)

DVD-R (Dual Layer):

MITSUBISHI KAGAKU MEDIA CO., LTD. (for 4x and 8x speed media)

DVD+R:

MITSUBISHI KAGAKU MEDIA CO., LTD. (for 8x and 16x speed media)

Ricoh Co., Ltd. (for 8x and 16x speed media)

TAIYO YUDEN CO., Ltd. (for 8x and 16x speed media)

DVD+R (Double Layer):

MITSUBISHI KAGAKU MEDIA CO., LTD. (for 2.4x and 8x speed media)

DVD-RW:**DVD Specifications for Recordable Disc for Version 1.1 or version 1.2**

Victor Company of Japan, Ltd. (JVC) (for 2x, 4x and 6x speed media)

MITSUBISHI KAGAKU MEDIA CO., LTD. (for 2x, 4x and 6x speed media)

DVD+RW:

Ricoh Co., Ltd. (for 2.4x, 4x and 8x speed media)

MITSUBISHI KAGAKU MEDIA CO., LTD. (for 2.4x, 4x and 8x speed media)

DVD-RAM: (DVD Super Multi drive only)**DVD Specifications for DVD-RAM Disc for Version 2.0, Version 2.1 or Version 2.2**

Matsushita Electric Industrial Co.,Ltd. (for 3x and 5x speed media)

Hitachi Maxell, Ltd. (for 3x and 5x speed media)



- *DVD Super Multi drive cannot use discs that allow writing faster than 16x speed (DVD-R and DVD+R media), 8x speed (DVD-R (Dual Layer), DVD+RW and DVD+R (Double Layer) media), 6x speed (DVD-RW media), 5x speed (DVD-RAM media).*
- *Some types and formats of DVD-R (Dual Layer) and DVD+R (Double Layer) discs may be unreadable.*
- *2.6GB and 5.2GB DVD-RAM media cannot be read from or written to.*
- *DISC created in DVD-R (Dual Layer) format4 (Layer Jump Recording) cannot be read.*

- If the disc is poor in quality, or is dirty or damaged, writing or rewriting errors may be noted - ensure that you check all discs for dirt or damage before you use them.
- The actual number of rewrites to CD-RW, DVD-RW, DVD+RW or DVD-RAM media will be affected by the quality of the disc itself and the way in which it is used.
- There are two types of DVD-R media available, authoring discs and general use discs. Do not attempt to use authoring discs as only general use discs can be written to by a computer drive.
- You can use both DVD-RAM discs that can be removed from a cartridge and DVD-RAM discs designed without a cartridge.
- You may find that other computer DVD-ROM drives or other DVD players may not be able to read DVD-R, DVD-R (Dual Layer), DVD-RW, DVD+R, DVD+R (Double Layer) or DVD+RW discs.
- Data written to a CD-R, DVD-R, DVD-R (Dual Layer), DVD+R or DVD+R (Double Layer) discs cannot be deleted either in whole or in part.
- Data deleted/erased from a CD-RW, DVD-RW, DVD+RW or DVD-RAM disc cannot be recovered. You must check the content of the disc carefully before you delete it, taking care that, if multiple drives that can write data to discs are connected, you do not delete data from the wrong one.
- In writing to DVD-R, DVD-R (Dual Layer), DVD-RW, DVD+R, DVD+R (Double Layer), DVD+RW or DVD-RAM media, some space is required for file management, so you may not be able to write to the full capacity of the disc.
- Since the disc is based on the DVD standard, it might be filled with dummy data if the written data is less than about 1GB. Therefore, in these circumstance, even if you write only a small amount of data, it might take additional time to fill in the dummy data.
- When multiple drives that can write data to discs are connected, be sure that you do not write to or delete data from the wrong drive.
- Be sure to connect the AC adaptor to the computer before you write or rewrite any information.
- Before you enter either Sleep Mode or Hibernation Mode, take care to ensure that any DVD-RAM writing has been completed. In this instance, writing is finished if you can eject the DVD-RAM media.
- Be sure to close all other software programs except for the writing software itself.
- Do not run software such as a screen saver which can put a heavy load on the processor.
- Operate the computer at its full power settings - do not use any power-saving features.
- Do not write information while virus checking software is running, instead wait for it to finish, then disable the virus protection applications, including any software that checks files automatically in the background.

- Do not use any hard disk utilities, including those that are intended to enhance hard disk drive access speeds, as they may cause unstable operation and damage data.
- CD-RW (Ultra Speed +) media should not be used as data may be lost or damaged.
- You should always write from the computer's hard disk drive onto the CD/DVD - do not try to write from shared devices such as a server or any other network device.
- Writing with software other than TOSHIBA Disc Creator has not been confirmed, therefore operation with other software applications cannot be guaranteed.

When writing or rewriting

Please observe the following points while you write or rewrite data to CD-R, CD-RW, DVD-R, DVD-R (Dual Layer), DVD-RW, DVD+R, DVD+R (Double Layer), DVD+RW or DVD-RAM media:

- Always copy data from the hard disk drive to the optical media - do not use the cut-and-paste function as the original data will be lost if there is a write error.
- Do not perform any of the following actions:
 - Change users in the Windows 7 operating system.
 - Operate the computer for any other function, including such tasks as using a mouse or Touch Pad, or closing/opening the display panel.
 - Start a communication application such as a modem.
 - Apply impact or vibration to the computer.
 - Install, remove or connect external devices, including such items as a PC Card, SD/SDHC memory card, miniSD/microSD Card, Smart Card, Memory Stick/Memory Stick PRO/Memory Stick PRO Duo, xD picture card, MultiMediaCard, USB device, external monitor, i.LINK device, or an optical digital device.
 - Use the audio/video control button to reproduce music or voice.
 - Open the optical disc drive.
- Do not use shut down, log off, Sleep Mode or Hibernation Mode functions while writing or rewriting.
- Make sure that the write/rewrite operation is completed before going into either Sleep Mode or Hibernation Mode (writing is completed if you can remove an optical media on the DVD Super Multi drive).
- If the media is of poor quality, or is dirty or damaged, writing or rewriting errors may occur.
- Set the computer on a level surface and avoid places subject to vibration such as airplanes, trains or cars. In addition, do not use the computer on an unstable surface such as a stand.
- Keep mobile phones and other wireless communication devices away from the computer.

TOSHIBA Disc Creator

Please be aware of the following limitations when you use the TOSHIBA Disc Creator:

- DVD Video cannot be created using TOSHIBA Disc Creator.
- DVD Audio cannot be created using TOSHIBA Disc Creator.
- You cannot use TOSHIBA Disc Creator's 'Audio CD for Car or Home CD Player' function to record music to DVD-R, DVD-R (Dual Layer), DVD-RW, DVD+R, DVD+R (Double Layer) or DVD+RW media.
- Do not use the 'Disc Backup' function of TOSHIBA Disc Creator in order to copy DVD Video or DVD-ROM material that has copyright protection.
- DVD-RAM discs cannot be backed up using the 'Disc Backup' function of TOSHIBA Disc Creator.
- You cannot back up CD-ROM, CD-R or CD-RW media to DVD-R, DVD-R (Dual Layer) or DVD-RW media using the 'Disc Backup' function of TOSHIBA Disc Creator.
- You cannot back up CD-ROM, CD-R or CD-RW media to DVD+R, DVD+R (Double Layer) or DVD+RW media using the 'Disc Backup' function of TOSHIBA Disc Creator.
- You cannot back up DVD-ROM, DVD Video, DVD-R, DVD-R (Dual Layer), DVD-RW, DVD+R, DVD+R (Double Layer) or DVD+RW to CD-R or CD-RW media using the 'Disc Backup' function of TOSHIBA Disc Creator.
- TOSHIBA Disc Creator cannot record in packet format.
- You might not be able to use the 'Disc Backup' function of TOSHIBA Disc Creator to back up a DVD-R, DVD-R (Dual Layer), DVD-RW, DVD+R, DVD+R (Double Layer) or DVD+RW disc that was made with other software on a different optical media recorder.
- If you add data to a DVD-R, DVD-R (Dual Layer), DVD+R or DVD+R (Double Layer) disc that you have already recorded to, you might not be able to read the added data under some circumstances. For example, it cannot be read under 16-bit operating systems, such as Windows 98SE and Windows Me, while in Windows NT4 you will need Service Pack 6 or later, and in Windows 2000, you will need Service Pack 2. In addition to this, some DVD-ROM and DVD-ROM / CD-R/RW drives cannot read this added data regardless of the operating system.
- TOSHIBA Disc Creator does not support recording to DVD-RAM discs - to achieve this you should use Windows Explorer or another similar utility.
- When you back up a DVD disc, be sure that the source drive supports recording to DVD-R, DVD-R (Dual Layer), DVD-RW, DVD+R, DVD+R (Double Layer) or DVD+RW media - if this is not the case then the source disc might not be backed up correctly.
- When you back up a DVD-R, DVD-R (Dual Layer), DVD-RW, DVD+R, DVD+R (Double Layer) or DVD+RW disc, be sure to use the same type of disc.
- You cannot partially delete any data written to a CD-RW, DVD-RW or DVD+RW disc.

Data Verification

To verify that data has been written or rewritten correctly to a data CD/DVD you should follow the steps below before you begin the write/rewrite process:

1. Display the setting dialog box by one of the following two steps:
 - Click the **Recording settings** button () for writing on the main toolbar in the **Data CD/DVD** mode.
 - Select **Settings for Each Mode** -> **Data CD/DVD** in the **Settings** menu.
2. Mark the **Verify Written Data** check box.
3. Select **File Open** or **Full Compare** mode.
4. Click the **OK** button.

How to learn more about TOSHIBA Disc Creator

Please refer to the Help files for additional TOSHIBA Disc Creator information.

Media care

This section provides tips on protecting data stored on your CD's, DVD's and floppy diskettes. Handle your media with care. Following the simple precautions listed below will increase the lifetime of your media and protect the data stored on it.

CD/DVDs

1. Store your CD's and DVD's in the containers they originally came in to protect them and keep them clean.
2. Do not bend the CD's or DVD's.
3. Do not write on, apply a sticker to, or otherwise mar the surface of the CD or DVD that contains the data.
4. Hold the CD or DVD by its outside edge or the edge on the center hole - any fingerprints on the surface of the disc can prevent the drive from properly reading data.
5. Do not expose the CD or DVD to direct sunlight, extreme heat or cold.
6. Do not place heavy objects on your CD's or DVD's.
7. If your CD's or DVD's become dusty or dirty, wipe them with a clean dry cloth from the center hole outwards - do not wipe in a circular direction. If necessary, you can use a cloth that has been lightly dampened in water or a neutral cleaner but you must not use benzine, thinner or any similar cleaning solution.

Floppy diskettes



The USB floppy diskette drive is available only as an option.

1. Store your floppy diskettes in the container they came in to protect them and keep them clean. If a floppy diskette becomes dirty, clean it with a soft, lightly dampened cloth - do not use cleaning fluid.
2. Never open the shutter or touch the magnetic surface of your floppy diskette - doing this could permanently damage it and lose data.
3. Always handle floppy diskettes with care to prevent the loss of stored data.
4. Always apply the floppy diskette label in the correct location and never apply a new label on top of an existing one - in this instance the label could come loose and damage the floppy diskette drive.
5. Never use a pencil for writing on a floppy diskette label as the dust from the pencil lead could cause a system malfunction if it found its way onto the computer's components. In this instance, always use a felt-tipped pen and write the label first before applying it to the floppy diskette.
6. Never put a floppy diskette in a location where water or other liquid may make contact with it, or where it is excessively damp - either of these conditions could cause data loss.
7. Never use a wet or damp floppy diskette - this could damage the floppy diskette drive or other devices within the computer.
8. Data may be lost if the floppy diskette is twisted, bent, or exposed to direct sunlight, extreme heat or cold.
9. Do not place heavy objects on your floppy diskettes.
10. Do not eat, smoke, or use items such as erasers near your floppy diskettes as foreign particles inside the jacket of the floppy diskette can damage the magnetic surface.
11. Magnetic energy can destroy the data on your floppy diskettes. In view of this you should keep your floppy diskettes away from speakers, radios, televisions and other sources of magnetic fields.

Sound System

This section describes some of the audio control functions.

Volume Mixer

The Volume Mixer utility lets you control the audio volume for playback of devices and applications under Windows.

- To launch the Volume Mixer utility, right click on the speaker icon on the Taskbar, and select **Open Volume Mixer** from the sub menu.
- To adjust the volume level of speakers or headphones, move the **Speakers** slider.
- To adjust the volume level of an application that you are using, move the slider for the corresponding application.

Microphone Level

Follow the steps below to change the microphone recording level.

1. Right click on the speaker icon on the Taskbar, and select **Recording devices** from the sub menu.
2. Select **Microphone**, and click **Properties**.
3. On the **Levels** tab move the **Microphone** slider to increase or decrease the microphone volume level.

If you feel the microphone volume level is inadequate, move the **Microphone Boost** slider to a higher level.

PC Beep Level

Follow the steps below to change the PC Beep playback level.

1. Right click on the speaker icon on the Taskbar, and select **Playback devices** in the sub menu.
2. Select **Speakers**, and click **Properties**.
3. On the **Levels** tab move the **PC Beep** slider to increase or decrease the PC Beep volume level.

Audio Enhancements

In order to apply the sound effects for your current speaker, follow the steps below.

1. Right click on the speaker icon on the Taskbar, and select **Playback Devices** from the sub menu.
2. Select **Speakers**, and click **Properties**.
3. On the **Enhancements** tab select the sound effects you would like, and click **Apply**.

Realtek HD Audio Manager

You can confirm and change the audio configuration using the **Realtek Audio Manager**. To launch the **Realtek Audio Manager**, click **Start** -> **Control Panel**, select **Large icons** from **View by**, then click **Realtek HD Audio Manager**.

When you first launch the Realtek Audio Manager, you will see two device tabs. **Speakers** is the default output device. **Microphone** is the default input device. To change the default device, click the **Set Default Device** button under the chosen device tab.

Information

Click the **information button**  to view hardware information, software information, and language setting.

Power Management

The audio controller in your computer can be turned off when the audio function is not used. To adjust the configuration of audio power

management, click the **battery button**  .

- When audio power management is enabled, the circle button at the upper left of the Power Management is blue and convex.
- When audio power management is disabled, the button is black and concave.

Speaker Configuration

Click the **Auto Test button**  to confirm the internal speakers or the headphone sound is coming from the right direction.

Default Format

You can change the sample rate and bit depth of sound.

TOSHIBA Mic Effect

TOSHIBA Mic Effect provides you with a hands-free environment for holding mutual communication via the Internet Protocol or Local Area Network. If you wish to communicate with someone on your computer, you can use a messenger application. However, with such an application, you would hear your own voice returning to you as echo during the communication if you did not use a headset system or headphone. TOSHIBA Mic Effect will reduce these echoes generated on your computer.

To apply the echo cancellation, follow the steps below.

1. Click the right button of a mouse on the speaker icon on the Taskbar, and select **Playback Devices** in the sub menu.
2. On the **Playback** tab, select **Speakers**, and click **Properties**.
3. On the **Advanced** tab, select "**16 bit, 48000 Hz (DVD Quality)**" in the pull-down menu of Default Format, and then click **OK**.
4. On the **Recording** tab, select **Microphone**, and click **Properties**.
5. On the **Advanced** tab, select "**2 channel, 16 bit, 48000 Hz (DVD Quality)**" in the pull-down menu of the Default Format pane.
6. On the **TOSHIBA Mic Effect** tab, select the **Enable Echo Canceller** check box, and click **Apply**.

Modem

This section describes how to connect and disconnect the internal modem to and from a telephone jack.



- *Connection to any communication line other than an analog phone line could cause a computer system failure.*
 - *Connect the built-in modem only to ordinary analog phone lines.*
 - *Never connect the built-in modem to a digital line (ISDN).*
 - *Never connect the built-in modem to the digital connector on a public telephone or to a digital private branch exchange (PBX).*
 - *Never connect the built-in modem to a key telephone system for residences or offices.*
- *Avoid using your computer modem with the telephone cable connected during an electrical storm. There may be a remote risk of electric shock from lightning.*



Modem functions cannot be used in models which are not equipped with a modem.

Region selection

Telecommunication regulations vary from one region to another, so you will need to make sure the internal modem's settings are correct for the region in which it will be used.



The built-in modem can be used only in specified countries and regions. Using the modem in an area not specified for use may cause a system failure. Check the specified areas carefully before using it.

To select a region, follow the steps as detailed below:

1. Click **Start -> All Programs -> TOSHIBA -> Networking -> Modem Region Select**.



If it is available, do not use the Country/Region Select function included as part of the modem setup utility within the Control Panel - if you change the country/region setting this way you may find that the change does not take effect.

2. The Region Selection icon will appear in the Windows Taskbar.
3. Click the icon with the primary (left) mouse button to display a list of regions that the modem supports, together with a sub-menu which details telephony location information - a check mark will appear next to the currently selected region and telephony location.

4. Select either a region from the region menu or a telephony location from the sub-menu.
 - When you click a region it becomes the modem's default selection for any new dialling locations that are created within the Windows Control Panel (Phone and Modem Options).
 - When you select a telephony location, the corresponding region is automatically selected and becomes the modem's default setting.

Properties menu

Click the icon with the secondary (right) mouse button in order to display a Properties menu on the screen.

Setting

Within the Properties menu you are able to either enable or disable the following settings:

AutoRun Mode

Allows you to configure whether the Modem Region Select utility starts automatically whenever you start up the operating system.

Open the Dialing Properties dialog box after selecting region.

Allows you to configure whether the dialing properties dialog box will be displayed automatically after you have selected a region.

Location list for region selection.

Displays a sub-menu appears which details location information.

Open dialog box, if the modem and Telephony Current Location region code do not match.

Displays a warning if the current settings for both region code and telephony location are different.

Modem Selection

If the computer cannot recognize the internal modem, a dialog box is displayed from which you should select the appropriate communications port for your modem to use.

Dialing Properties

You should select this item in order to display the dialing properties.



If you are using the computer in Japan, the Telecommunications Business Law requires that you select Japan region mode. It is illegal to use the modem in Japan with any other selection.

Connecting the modular cable

To connect the modem's modular cable, follow the steps as detailed below:



- *Connection to any communication line other than an analog phone line could cause a computer system failure.*
- *Connect the built-in modem only to ordinary analog phone lines.*
- *Never connect the built-in modem to a digital line (ISDN).*
- *Never connect the built-in modem to the digital connector on a public telephone or to a digital private branch exchange (PBX).*
- *Never connect the built-in modem to a key telephone system for residences or offices.*
- *Avoid using your computer modem with the telephone cable connected during an electrical storm. There may be a remote risk of electric shock from lightning.*

1. Plug the end of the modular cable into the computer's modem jack.
2. Plug the other end of the modular cable into a telephone jack.

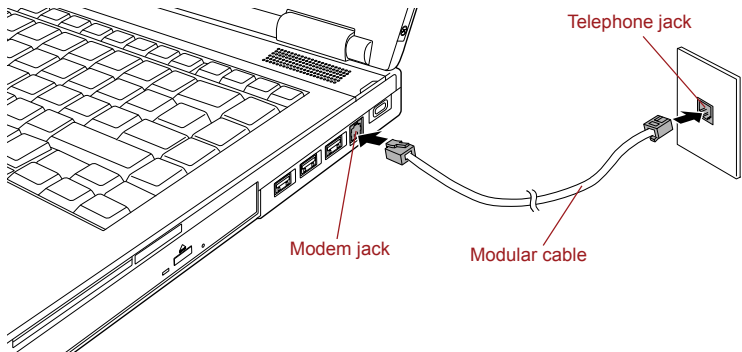

Figure 4-10 Connecting the internal modem



Do not pull on the cable or move the computer while the cable is connected.



If you use a storage device such as an optical disc drive or hard disk drive connected to a 16-bit PC Card, you might experience the following problems with the operation of the modem:

- *The modem speed is slow or communication is periodically interrupted.*
- *Skips or jumps may be noted in sound.*

Disconnecting the modular cable

To disconnect the modular cable, follow the steps as detailed below:

1. Pinch the lever on the plug in the telephone jack and pull it out from within the connector.
2. Pinch the lever on the plug in the computer's modem jack and pull it out from within the computer.

Wireless communications

The computer's wireless communication function supports some wireless communication devices.

Only some models are equipped with both Wireless LAN and Bluetooth functions.



- *Do not use the Wireless LAN (Wi-Fi) or Bluetooth functionalities near a microwave oven or in areas subject to radio interference or magnetic fields. Interference from a microwave oven or other source can disrupt Wi-Fi or Bluetooth operation.*
- *Turn all wireless functionalities off when near a person who may have a cardiac pacemaker implant or other medical electric device. Radio waves may affect pacemaker or medical device operation, possibly resulting in serious injury. Follow the instruction of your medical device when using any wireless functionality.*
- *Always turn off wireless functionality if the computer is near automatic control equipment or appliances such as automatic doors or fire detectors. Radio waves can cause malfunction of such equipment, possibly resulting in serious injury.*
- *It may not be possible to make a network connection to a specified network name using the ad hoc network function. If this occurs, the new network(*) will have to be configured for all computers connected to the same network in order to re-enable network connections.*
** Please be sure to use new network name.*

Wireless LAN

The Wireless LAN is compatible with other LAN systems based on Direct Sequence Spread Spectrum / Orthogonal Frequency Division Multiplexing radio technology that complies with the IEEE802.11 Wireless LAN standard.

- Frequency Channel Selection of 5GHz for IEEE 802.11a or/and IEEE802.11n draft 2.0
- Frequency Channel Selection of 2.4GHz for IEEE 802.11b/g or/and IEEE802.11n draft 2.0
- Roaming over multiple channels
- Card power management
- Wired Equivalent Privacy (WEP) data encryption based on an 128-bit encryption algorithm
- Wi-Fi Protected Access™ (WPA™)



The transmission speed over the wireless LAN, and the distance over which the wireless LAN can reach, may vary depending on surrounding electromagnetic environment, obstacles, access point design and configuration, client design and software/hardware configurations. The transmission rate described is the theoretical maximum speed as specified under the appropriate standard - the actual transmission speed will be lower than the theoretical maximum speed.

Setting

1. Please make sure that the **Wireless Communication Switch** is turned on.
2. Click **Start -> Control Panel -> Network and Internet -> Network and Sharing Center**.
3. Click **Set up a connection or network**.
4. Follow the wizard. You will need the name of the wireless network together with security settings. Consult the documentation accompanied with your router or ask your wireless network administrator for the settings.

Security

- TOSHIBA strongly recommend that you enable encryption functionality, otherwise your computer will be open to illegal access by an outsider using a wireless connection. If this occurs, the outsider may illegally access your system, eavesdrop, or cause the loss or destruction of stored data.
- TOSHIBA is not liable for the loss of data due to eavesdropping or illegal access through the wireless LAN and the damage thereof.

Bluetooth wireless technology

Bluetooth wireless technology eliminates the need for cables, such as desktop computers, between your PC and other electronic devices, example of printers and mobile phones.

You cannot use the computer's built-in Bluetooth functions and an external Bluetooth adaptor simultaneously. For reference, Bluetooth wireless technology has the following features:

Worldwide operation

The Bluetooth radio transmitter and receiver operate in the 2.4GHz band, which is license-free and compatible with radio systems in most countries in the world.

Radio links

You can easily establish links between two or more devices, with these links being maintained even if the devices are not within a line-of-sight of each other.

Security

Two advanced security mechanisms ensure a high level of security:

- Authentication prevents access to critical data and makes it impossible to falsify the origin of a message.
- Encryption prevents eavesdropping and maintains link privacy.

Bluetooth Stack for Windows by TOSHIBA

Please note that this software is specifically designed for the following operating systems:

- Windows 7

Information regarding the use of this software with these operating systems is listed below, with further details being contained with the electronic help files supplied with the software.



This Bluetooth Stack is based on the Bluetooth Version 1.1/1.2/2.0+EDR/2.1+EDR specification. However, TOSHIBA cannot confirm the compatibility between any computing products and/or other electronic devices that use Bluetooth, other than TOSHIBA notebook computers.

Release Notes related to the Bluetooth Stack for Windows by TOSHIBA

1. Fax application software:
Please be aware that there is some fax application software that you cannot use on this Bluetooth Stack.
2. Multi-user considerations:
On Windows 7, the use of Bluetooth is not supported in a multi-user environment. This means that, when you use Bluetooth, other users that are logged into the same computer will not be able to use this type of functionality.

Product Support:

The latest information regarding operating system support, language support or available upgrades can be found on our web site <http://www.toshiba-europe.com/computers/tnt/bluetooth.htm> in Europe or www.pcsupport.toshiba.com in the United States.

Wireless communication switch

You can enable or disable Wireless communication functions, with the on/off switch. No transmissions are sent or received when the switch is off. Slide the switch forward to turn it on and backward to turn it off.

Wireless communication Indicator

The wireless communication indicator shows the status of the computer's wireless communication functions.

Indicator status	Indication
Indicator off	The wireless communication switch is off - no wireless functionality is available.
Indicator glows	Wireless communication switch is on. Except for the stopped device by the software switch, all the wireless-communications functions can output a radio wave.

If you used the Taskbar to disable the wireless LAN, restart the computer or perform the following procedure to re-enable it: **Start -> Control Panel -> System and Security -> System -> Device Manager -> Network adapters** and right click the wireless device then choose **enable**.

LAN

The computer has built-in support for Ethernet LAN (10 megabits per second, 10BASE-T), Fast Ethernet LAN (100 megabits per second, 100BASE-TX) and Gigabit Ethernet LAN (1000 megabits per second, 1000BASE-T).

This section describes how to connect/disconnect to a LAN.



Do not install or remove a memory module while Wake-up on LAN is enabled.



- *The Wake-up on LAN function consumes power even when the system is off. Leave the AC adaptor connected while using this feature.*
- *The Link speed (10/100/1000 megabits per second) changes automatically depending on the network conditions (connected device, cable or noise and so on).*

LAN cable types



The computer must be configured properly before connecting to a LAN. Logging onto a LAN using the computer's default settings could cause a malfunction in LAN operation. Check with your LAN administrator regarding set-up procedures.

If you are using Gigabit Ethernet LAN (1000 megabits per second, 1000BASE-T), be sure to connect with a CAT5E cable or higher. You cannot use a CAT3 or CAT5 cable.

If you are using Fast Ethernet LAN (100 megabits per second, 100BASE-TX), be sure to connect with a CAT5 cable or higher. You cannot use a CAT3 cable.

If you are using Ethernet LAN (10 megabits per second, 10BASE-T), you can connect with a CAT3 or higher cable.

Connecting the LAN cable

To connect the LAN cable, follow the steps as detailed below:



- *Connect the AC adaptor before connecting the LAN cable. The AC adaptor must remain connected during LAN use. If you disconnect the AC Adaptor while the computer is accessing a LAN, the system may hang up.*
- *Do not connect any other cable to the LAN jack except the LAN cable. Otherwise, malfunctions or damage may occur.*
- *Do not connect any power supplying device to the LAN cable that is connected to the LAN jack. Otherwise, malfunctions or damage may occur.*

1. Turn off the power to the computer and to all external devices connected to the computer.

2. Plug one end of the cable into the LAN jack. Press gently until you hear the latch click into place.

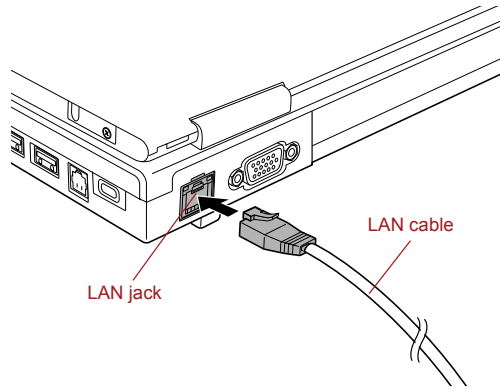

Figure 4-11 Connecting the LAN cable

3. Plug the other end of the cable into a LAN hub connector or router. Check with your LAN administrator and hardware or software vendor before using or configuring a network connection.



When the computer is exchanging data with the LAN, the **LAN Active** indicator glows orange. When the computer is connected to a LAN hub but is not exchanging data, the **Link** indicator glows green.

Disconnecting the LAN cable

To disconnect the LAN cable, follow the steps as detailed below:



Make sure the **LAN Active** indicator (orange LED) is out before you disconnect the computer from the LAN.

1. Pinch the lever on the connector in the computer's LAN jack and pull out the connector.
2. Disconnect the cable from the LAN hub or router in the same manner. Check with your LAN administrator and hardware or software vendor before disconnecting from the hub.

Computer Handling

This section explains computer handling and maintenance.

Cleaning the computer

To help ensure long, trouble-free operation, keep the computer free of dust and dirt, and use care with all liquids around it.

- Be careful not to spill liquids into the computer. If the computer does get wet, turn the power off immediately and let the computer dry completely - in these circumstance you should get the computer inspected by an authorized service provider in order to assess the scope of any damage.
- Clean the plastics of the computer using a slightly water dampened cloth.
- You can clean the display screen by spraying a small amount of glass cleaner onto a soft, clean cloth and then wiping the screen gently with the cloth.



Never spray cleaner directly onto the computer or let liquid run into any part of it. Never use harsh or caustic chemical products to clean the computer.

Moving the computer

While the computer is designed for rugged durability you should exercise a few simple precautions when moving it in order to help ensure trouble-free operation.

- Before moving the computer, it is recommended that you change the setting associated with the Hard Disk Drive Protection feature. Please refer to the section, [Using the Hard Disk Drive \(HDD\) Protection](#), in this chapter for further information.
- Make sure all disk/disc activity has ended before moving the computer - check that the HDD and other indicators on the front of the computer are off.
- Turn off (shut down) the computer.
- Disconnect the AC adaptor and all peripherals before moving the computer.
- Close the display panel.
- Do not pick up the computer by its display panel.
- Before carrying your computer, shut it down, disconnect the AC adaptor and allow it to cool down - a failure to follow this instruction may result in minor heat injury.
- Be careful not to subject the computer to impact or shock - a failure to follow this instruction could result in damage to computer, computer failure or loss of data.

- Never transport your computer with any cards installed - this may cause damage to either the computer and/or the card resulting in product failure.
- Always use a suitable carry case when transporting the computer.
- When carrying your computer, be sure to hold it securely so that it does not fall or hit anything.
- Do not carry your computer by holding any of its protruding elements.

Using the Hard Disk Drive (HDD) Protection

This computer has a function for reducing the risk of damage on the hard disk drive.

Using an acceleration sensor built into the computer, TOSHIBA HDD Protection detects vibration shocks and similar signs of movement of the computer, and automatically moves the Hard Disk Drive head to a safe position to reduce the risk of damage that could be caused by head-to-disk contact.



- *The TOSHIBA HDD Protection function does not guarantee that the hard disk drive will not be damaged.*
- *TOSHIBA HDD Protection cannot be used in models that are equipped with SSD.*

When vibration is detected, a message will be displayed on the screen, and the icon in the Taskbar notification area will change to the protection state. This message is displayed until the **OK** button is pressed or 30 seconds pass. When vibration subsides, the icon returns to the normal state.

Taskbar icon

State	Icon	Description
Normal		TOSHIBA HDD Protection is enabled.
Protection		TOSHIBA HDD Protection is active. The hard disk drive head is in a safe position.
OFF		TOSHIBA HDD Protection is disabled.

TOSHIBA HDD Protection Properties

You can change the TOSHIBA HDD Protection settings by using the TOSHIBA HDD Protection Properties window. To open the window, click **Start -> All Programs -> TOSHIBA -> Utilities -> HDD Protection Settings**. The window can also be started from the icon on the Taskbar or from the **Control Panel**.

HDD Protection

You can choose whether to enable or disable TOSHIBA HDD Protection.

Detection Level

This function can be set to four levels. The sensitivity levels in which vibrations, impacts and their similar signs are detected can be set to OFF, 1, 2 and 3 in ascending order. Level 3 is recommended for better protection of the computer. However, when the computer is used in a mobile environment or in other unstable conditions, setting the detection level to 3 could result in frequent execution of TOSHIBA HDD Protection, which will slow Hard Disk Drive reading and writing. Set a lower detection level when the speed of Hard Disk Drive reading and writing is a priority.

Different detection levels can be set depending on whether the computer is used as handheld or mobile usages, or whether it is used in a stable environment such as on a table in the workplace or at home. By setting different detection levels for the computer depending on whether it runs with the AC power (desktop) or with batteries (handheld or mobile usage), the detection level automatically switches according to the power connection mode.

3D Viewer

This feature displays a 3D object on the screen which moves in according to tilting or vibration of the computer.

When the TOSHIBA HDD Protection detects computer vibration the Hard Disk Drive head is parked and the 3D object disk rotation will stop. When the head is un-parked the disk will begin to rotate again.

The **3D Viewer** can be started from the icon in the task tray.



- *This 3D object virtually represents the Computer's internal Hard Disk Drive. This representation may vary from the actual number of disks, disk rotation, head movement, part size, shape and direction.*
- *This feature may use a large amount of CPU and memory on some models. The computer may become slow or sluggish when attempting to run other applications while the 3D Viewer is displayed.*
- *Intensely shaking the computer or other subjecting it to strong impacts may cause damage to the computer.*

Details

To open the Details window, click the **Setup Detail** button in the TOSHIBA HDD Protection Properties window.

Detection Level Amplification

When the AC adaptor is disconnected or the lid is closed, HDD Detection assumes that the computer will be carried and sets the detection level to the maximum for 10 seconds.

HDD Protection Message

Specify whether to display a message when TOSHIBA HDD Protection is active.



This function does not work when the computer is booting, in Sleep Mode, in Hibernation Mode, in transition to Hibernation Mode, recovering from Hibernation Mode, or powered off. Do not subject the computer to vibration or impact while the function is disabled.

Using the TOSHIBA USB Sleep and Charge Utility

This utility displays whether the USB Sleep and Charge function is enabled or disabled and shows the positions of USB ports that support the USB Sleep and Charge function. It also displays the remaining battery capacity.

USB Sleep and Charge

Your computer can supply USB bus power (DC5V) to the USB port even when the power of the computer is turned OFF. "Power OFF" includes Sleep Mode, Hibernation Mode or shutdown state.

This function can be used for ports that support the USB Sleep and Charge function (hereinafter called "compatible ports").

Compatible ports are USB ports that have the (⚡) symbol icon.

You can use the "USB Sleep and Charge function" to charge certain USB-compatible external devices such as mobile phones or portable digital music players.

However, the "USB Sleep and Charge function" may not work with certain external devices even if they are compliant with the USB specification. In those cases, turn the power of the computer ON to charge the device.



- When "USB Sleep and Charge function" is set to [Enabled], USB bus power (DC5V) will be supplied to compatible ports even when the power of the computer is turned OFF.
USB bus power (DC5V) is similarly supplied to the external devices which are connected to the compatible ports. However, some external devices cannot be charged solely by supplying USB bus power (DC5V).
As for the specifications of the external devices, please contact the device manufacturer or check the specifications of the external devices thoroughly before use.
- Using the USB sleep and charge function to charge external devices will take longer than charging the devices with their own chargers.
- If USB Sleep and Charge function is enabled, the computer's battery will discharge during hibernation or when the computer is turned off. It is recommended that you connect the AC adaptor to the computer when enabling the USB Sleep and Charge function.
- External devices connected to the USB bus power (DC5V) function that interfaces with the power ON/OFF of the computer may always be in an operational state.
- When there is a current overflow of the external devices connected to the compatible ports, USB bus power (DC5V) supply may be stopped for safety reasons.
- When "USB Sleep and Charge function" is set to [Enabled], the "USB Wakeup function" does not work for compatible ports.
In that case, if there is a USB port that does not have the USB Sleep and Charge function-compatible icon (⚡), attach the mouse or keyboard to it.
If all USB ports have the USB Sleep and Charge function-compatible icon (⚡), change the "USB Sleep and Charge function" setting to [Disabled].
The "USB Wakeup function" will now work, but the "USB Sleep and Charge function" will be disabled.



Metal paper clips or hair pins/clips will generate heat if they come into contact with USB ports. Do not allow USB ports to come into contact with metal products, for example when carrying the computer in your bag.

Starting the USB Sleep and Charge Utility

To start the utility, click **Start-> All Programs -> TOSHIBA -> Utilities -> USB Sleep and Charge**.

Enabling USB Sleep and Charge

This utility can be used to enable and disable the USB Sleep and Charge function in groups. USB Sleep and Charge compatible USB ports are assigned to each group.

Check the check boxes for each group to enable the USB Sleep and Charge function for the USB ports assigned to that group. In the default state all groups are disabled.

Power supply mode settings

There are several USB Sleep and Charge function modes.

"Mode 1" should normally be used. Set one of the other modes if the charge function cannot be used in "Mode 1". The selected charge mode will be applied to all groups.

Some groups may be grayed out and not able to be selected for some modes. This indicates that those groups are not compatible with the selected mode and the USB Sleep and Charge function cannot be used.

In this situation, either select a different mode, or set one of the selectable "Groups". This function may not be able to be used with some connected external devices even if the appropriate group is selected. In this situation, uncheck the check boxes for each group and stop using this function.

Battery Settings

This utility can be used to specify the lower limit of remaining battery life for USB Sleep and Charge. Move the slider bar to specify the lower limit. If the remaining battery life falls below the setting, the USB Sleep and Charge function will be stopped. Checking the "AC Only" check box sets the utility to only charge when the AC adaptor is connected.

Heat dispersal

To protect against overheating, the processor is equipped with an internal temperature sensor which activates a cooling fan or lowers the processing speed if the computer's internal temperature rises to a certain level. You are able to select whether to control this temperature by either turning on the fan first, then if necessary lowering the processor speed, or by lowering the processor speed first, then if necessary turning on the fan. Both of these functions are controlled through the Power Options.

When the processor's temperature falls within normal range, the fan will be turned off and the processor operation returned to its standard speed.



If the processor's temperature reaches an unacceptably high level with either setting, the computer automatically shuts down to prevent any damage. In this instance all unsaved data in memory will be lost.

Chapter 5

The Keyboard

The computer's keyboard layouts are compatible with a 104/105-key enhanced keyboard - by pressing some keys in combination, all of the 104/105-key enhanced keyboard functions can be performed on the computer.

The number of keys available on your keyboard will depend on which country/region your computer is configured for, with keyboards being available for numerous languages.

In use there are six different types of keys, specifically typewriter keys, function keys, soft keys, Hot keys, Windows special keys and the keypad overlay.

Typewriter keys

The typewriter keys produce the upper-case and lower-case letters, numbers, punctuation marks, and special symbols that appear on the screen. However, there are some differences between using a typewriter and using a computer keyboard:

- Letters and numbers produced in computer text vary in width. Spaces, which are created by a 'space character' may also vary depending on line justification and other factors.
- The lowercase l (el) and the number 1 (one), together with the uppercase O (oh) and the 0 (zero), are not interchangeable on computers as they are on a typewriter.
- The **CAPS LOCK** function key locks only the alphabetic characters into upper-case while the Shift Lock function on a typewriter places all keys in the shifted position.
- The **SHIFT** keys, the **Tab** key, and the **BACK SPACE** key perform the same function as their typewriter counterparts but also have special computer functions.



Never remove the key caps on your keyboard. Doing so could cause damage to the parts under the key caps.

Function keys: F1 ... F12

The function keys (not to be confused with the special **FN** key) are the twelve keys at the top of your keyboard - these keys function differently from other keys.



F1 through **F12** are called function keys because they execute programmed functions when pressed and, when used in combination with the **FN** key, those keys marked with icons also execute specific functions on the computer. Please refer to the section, [Soft keys: FN key combinations](#), in this chapter for further information, taking care to note that the function executed by individual keys will depend on the software you are using.

Soft keys: FN key combinations

The **FN** (function) is unique to TOSHIBA computers and is used in combination with other keys to form soft keys. Soft keys are key combinations that enable, disable or configure specific features.



Please note that some software may disable or interfere with soft-key operations, and that the soft-key settings are not restored when the computer returns from Sleep Mode.

Emulating keys on an enhanced keyboard

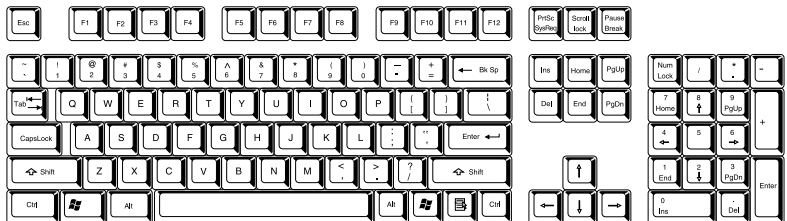
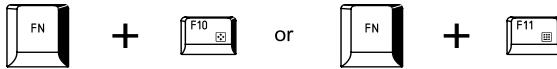

Figure 5-1 A 104-key enhanced keyboard layout

This computer's keyboard is designed to provide all the features of the 104-key enhanced keyboard.

Since the keyboard is smaller and has fewer keys, some of the enhanced keyboard functions must be simulated using two keys instead of one on the larger keyboard.

The **FN** key can be combined with the following keys to simulate functions similar to those of keys on the 104/105 key enhanced keyboard which are not on this computer's keyboard.



Press **FN + F10** or **FN + F11** to access the computer's integrated keypad. When activated, the keys with grey markings on their bottom edge become either numeric keypad keys (**FN + F11**) or cursor control keys (**FN + F10**). Please refer to the [Keypad overlay](#) section in this chapter for more information on how to operate these keys, taking care to note that the power on default for both settings is off.



Press **FN + F12 (ScrLock)** to lock the cursor on a specific line. The power on default is off.

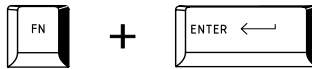

Press **FN + ENTER** to simulate **ENTER** on the enhanced keyboard's numeric keypad.

Hot keys

Hot keys (pressing **FN** + a function or **ESC** key) let you enable or disable certain features of the computer.

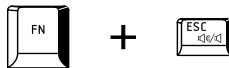

Mute: Pressing **FN + ESC** turns the volume on and off.



Lock: Pressing **FN + F1** enters "Lock computer mode". To restore your desktop, you need to log on again.



Power Plan: Pressing **FN + F2** changes the power settings.



Sleep: Pressing **FN + F3** switches the system to Sleep Mode.



Hibernate: Pressing **FN + F4** switches the system to Hibernation Mode.



Output: Pressing **FN + F5** changes the active display device.



To use a simultaneous mode, you must set the resolution of the internal display panel to match the resolution of the external display device.



Brightness Down: Pressing **FN + F6** decreases the computer's display panel brightness in individual steps.



Brightness Up: Pressing **FN + F7** increases the computer's display panel brightness in individual steps.



Wireless: Pressing **FN + F8** switches the active wireless devices if the wireless communication switch is switched on.



If no wireless communication device is installed, no dialog box will appear.

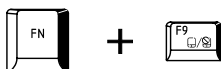

Touch Pad: Pressing **FN + F9** enables or disables the Touch Pad and AccuPoint function.

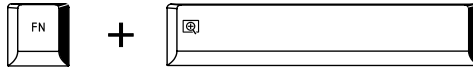

Zoom: Pressing **FN + Space** changes the display resolution.



TOSHIBA Zooming Utility (reduce): Pressing **FN + 1** reduces the icon size on the desktop or the font sizes within one of the supported application windows.



TOSHIBA Zooming Utility (enlarge): Pressing **FN + 2** enlarges the icon size on the desktop or the font sizes within one of the supported application windows.

FN Sticky key

You can use the TOSHIBA Accessibility Utility to make the **FN** key sticky, that is, you can press it once, release it, and then press an "**F Number**" key. To start the TOSHIBA Accessibility utility, click **Start -> All Programs -> TOSHIBA -> Utilities -> Accessibility**.

Windows special keys

The keyboard provides two keys that have special functions in Windows, the Windows Start Button key activates the **Start** menu while the application key has the same function as the secondary (right) mouse button.



This key activates the Windows **Start** menu.



This key has the same function as the secondary (right) mouse button.

Keypad overlay

Your computer's keyboard does not have a separate numeric keypad but includes a numeric keypad overlay which functions like one - this is located in the center of the keyboard with the relevant keys having grey letters at their front edge. The overlay provides the same functions as the numeric keypad on a standard 104/105-key enhanced keyboard.

Turning on the overlays

The numeric keypad overlay can be used for numeric data input or cursor and page control.

Arrow Mode

To turn on Arrow Mode, press **FN + F10** - the Arrow Mode indicator lights and you are able to access cursor and page control functions by using the keys. You are able to press **FN + F10** again to turn off this overlay function.

Numeric Mode

To turn on Numeric Mode, press **FN + F11** - the Numeric Mode indicator lights and you are able to access numeric characters by using the keys. You are able to press **FN + F11** again to turn off this overlay function.

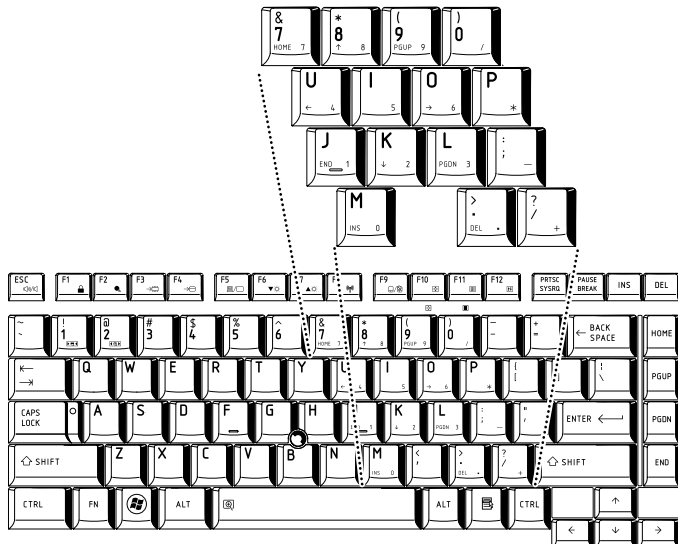

Figure 5-2 The numeric keypad overlay

Temporarily using normal keyboard (overlay on)

While using the overlay, you can temporarily access the normal keyboard functions without having to turn the overlay off:

1. Hold down **FN** key and press any other key - this key will operate as if the overlay were off.
2. Type upper-case characters by holding down **FN + SHIFT** and pressing a character key.
3. Release **FN** key to continue using the selected overlay function.

Temporarily using overlay (overlay off)

While using the normal keyboard function, you can temporarily use the keypad overlay without having to turn it on:

1. Hold down **FN** key.
2. Check the keyboard indicators as pressing the **FN** key will turn on the most recently used overlay function - if the Numeric Mode indicator lights you can use the overlay for numeric entry, while if the Arrow Mode indicator lights, you can use the overlay for cursor and page control function.
3. Release **FN** key to return to normal keyboard operation.

Temporarily changing modes

If the computer is in **Numeric Mode**, you can switch temporarily to **Arrow Mode** by pressing a **SHIFT** key, while if it is in **Arrow Mode**, you can switch temporarily to **Numeric Mode** by also pressing a **SHIFT** key.

Generating ASCII characters

Not all ASCII characters can be generated using normal keyboard operation, but you are able to generate these characters using their specific ASCII codes.

With the overlay on:

1. Hold down **ALT** key.
2. Using the overlay keys, type the ASCII code of the character you require.
3. Release **ALT** - the ASCII character will appear on the display screen.

With the overlay off:

1. Hold down **ALT + FN**.
2. Using the overlay keys, type the ASCII code of the character you require.
3. Release **ALT + FN** - the ASCII character will appear on the display screen.

Chapter 6

Power and Power-Up Modes

The computer's power resources include the AC adaptor, battery pack and any internal batteries. This chapter provides details on making the most effective use of these resources, and includes information on charging and changing batteries, tips for saving battery power, and information on the different power-up modes.

Power conditions

The computer's operating capability and battery charge status are affected by different power conditions, including whether an AC adaptor is connected, whether a battery pack is installed and what the charge level is for that battery.

Table 6-1 Power conditions

		Power on	Power off (no operation)
AC adaptor connected	Battery fully charged	<ul style="list-style-type: none"> Operates No charge LED: Battery green DC IN green 	<ul style="list-style-type: none"> No charge LED: Battery green DC IN green
	Battery partially charged or no charge	<ul style="list-style-type: none"> Operates Charge LED: Battery orange DC IN green 	<ul style="list-style-type: none"> Quick charge LED: Battery orange DC IN green
	No battery installed	<ul style="list-style-type: none"> Operates No charge LED: Battery off DC IN green 	<ul style="list-style-type: none"> No charge LED: Battery off DC IN green

Table 6-1 Power conditions continued

		Power on	Power off (no operation)
AC adaptor not connected	Battery charge is above low battery trigger point	<ul style="list-style-type: none"> Operates LED: Battery off DC IN off 	
	Battery charge is below low battery trigger point	<ul style="list-style-type: none"> Operates LED: Battery flashes orange DC IN off 	
	Battery charge is exhausted	Computer shuts down	
	No battery installed	<ul style="list-style-type: none"> No operation LED: Battery off DC IN off 	

Monitoring of power condition

As shown in the below table, the **Battery**, **DC IN** and **Power** indicators on the system indicator alert you to the computer's operating capability and battery charge status.

Battery indicator

Check the **Battery** indicator to determine the status of the battery pack. The following indicator lights indicate the battery status:

Flashing orange	The battery charge is low, the AC adaptor must be connected in order to recharge the battery.
Orange	Indicates the AC adaptor is connected and the battery is charging.
Green	Indicates the AC adaptor is connected and the battery is fully charged.
No light	Under any other conditions, the indicator does not light.



*If the battery pack becomes too hot while it is being charged, the charge will stop and the **Battery** indicator will go out. When the battery pack's temperature falls to a normal range, charging will resume - this process will occur regardless of whether the computer's power is on or off.*

DC IN indicator

Check the **DC IN** indicator to determine the power status with the AC adaptor connected - the following indicator conditions should be noted:

Green	Indicates the AC adaptor is connected and is correctly supplying power to the computer.
Flashing orange	Indicates a problem with the power supply. You should initially try plugging the AC adaptor into another power outlet - if it still does not operate properly, you should contact your reseller or dealer.
No light	Under any other conditions, the indicator does not light.

Power indicator

Check the **Power** indicator to determine the power status of the computer - the following indicator conditions should be noted:

Green	Indicates power is being supplied to the computer and the computer is turned on.
Blinking orange	Indicates that the computer is in Sleep Mode and that there is sufficient power available (AC adaptor or battery) to maintain this condition. In Sleep Mode, this indicator will turn on for one second and off for two seconds.
No light	Under any other conditions, the indicator does not light.

Battery

This section explains battery types, use, recharging methods and handling.

Battery types

The computer has four different types of batteries.

Battery pack

When the AC adaptor is not connected, the computer's main power source is a removable lithium ion battery pack, also referred to in this manual as the main battery. You can purchase additional battery packs for extended use of the computer away from an AC power source although you should not change the battery pack while the AC adaptor is connected.

Before you remove the battery pack, save your data and shut down the computer, or place the computer into Hibernation Mode. Please be aware that, when placing the computer into Hibernation Mode, the contents of memory will be saved to the hard disk drive, although for safety sake, it is best to also save your data manually.

Extended Capacity Battery Pack (Included with some models, or option)

The Extended Capacity Battery Pack is included with some models, or can be purchased separately as an optional accessory.

High Capacity Battery Pack (Included with some models, or option)

The High Capacity Battery Pack is included with some models, or can be purchased separately as an optional accessory.

Real Time Clock (RTC) battery

The Real Time Clock (RTC) battery provides power for the internal real time clock and calendar function and also maintains the system configuration while the computer is turned off. If the RTC battery becomes completely discharged, the system will lose this information and the real time clock and calendar will stop working - in this instance the following message will be displayed when you turn on the power:



```
**** RTC battery is low or CMOS checksum is
inconsistent ****
Press [F1] key to set Date/Time.
```

You can change the Real Time Clock settings by turning the computer on while pressing the **ESC** key and then the **F1** key when prompted. Please refer to Chapter 8 [Troubleshooting](#) for further information.



The RTC battery does not charge while the computer is turned off even if the AC adaptor is attached.

Care and use of the battery pack

This section provides the important safety precautions in order to handle your battery pack properly.

Refer to the enclosed **Instruction Manual for Safety and Comfort** for detailed precautions and handling instructions.



- *Make sure the battery is securely installed in the computer before attempting to charge the battery pack. Improper installation could generate smoke or fire, or cause the battery pack to rupture.*
- *Keep the battery pack out of reach of infants and children. It can cause injury.*



- *The battery pack, Extended Battery Pack and High Capacity Battery Pack are lithium ion batteries, which can explode if not replaced, used, handled or disposed of properly. Dispose of the battery as required by local ordinances or regulations. Use only batteries recommended by TOSHIBA as replacements.*
- *The computer's RTC battery is a Ni-MH battery and should be replaced only by your dealer or by a TOSHIBA service representative. The battery can explode if not properly replaced, used, handled or disposed. Dispose of the battery as required by local ordinances or regulations.*
- *Charge the battery pack only in an ambient temperature between 5 and 35 degrees Celsius. Otherwise, the electrolyte solution might leak, battery pack performance might deteriorate and the battery life might be shortened.*
- *Never install or remove the battery pack without first turning off the power and disconnecting the AC adaptor. Never remove the battery pack while the computer is in Sleep Mode. Data could be lost.*
- *When the High Capacity Battery Pack is connected to the computer, do not hold on only to the High Capacity Battery Pack when lifting the computer up. The High Capacity Battery Pack may separate from the computer, causing it to fall and cause injuries.*



Never remove the battery pack while the Wake-up on LAN function is enabled. Data will be lost. Before you remove a battery pack, disable the Wake-up on LAN function.

Charging the batteries

When the power in the battery pack becomes low, the **Battery** indicator will flash orange to indicate that only a few minutes of battery power remain. If you continue to use the computer while the **Battery** indicator flashes, the computer will enable Hibernation Mode so that you do not lose any data, and automatically turn itself off.

You must recharge a battery pack when it becomes discharged.

Procedures

To recharge a battery pack while it is installed in the computer, connect the AC adaptor to the DC IN 15V jack and plug the other end into a working outlet - the **Battery** indicator will glow orange while the battery is being charged.



Use only the computer connected to an AC power source or optional TOSHIBA Battery charger to charge the battery pack. Never attempt to charge the battery pack with any other charger.

Time

Refer to User Information Guide about Charging time.

Battery charging notice

The battery may not begin charging immediately under the following conditions:

- The battery is extremely hot or cold (if the battery is extremely hot, it might not charge at all). To ensure the battery charges to its full capacity, you should charge it at room temperature of between 5° to 35°C (41° to 95°F).
- The battery is nearly completely discharged. In this instance you should leave the AC adaptor connected for a few minutes and the battery should begin charging.

The **Battery** indicator may show a rapid decrease in battery operating time when you try to charge a battery under the following conditions:

- The battery has not been used for a long time.
- The battery has completely discharged and been left in the computer for a long time.
- A cool battery is installed in a warm computer.

In such cases you should follow the steps as detailed below:

1. Fully discharge the battery by leaving it in the computer with the power on until the system automatically turns itself off.
2. Connect the AC adaptor to the DC IN 15V jack of the computer, and to a wall outlet that is supplying power.
3. Charge the battery until the **Battery** indicator glows green.

Repeat these steps two or three times until the battery recovers normal capacity.

Monitoring battery capacity

Remaining battery power can be monitored using the following methods.

- Clicking the battery icon on the Taskbar
- Via the Battery Status in the Windows Mobility Center window



- *You should wait at least 16 seconds after turning on the computer before trying to monitor the remaining operating time. This is because the computer needs this time to check the battery's remaining capacity and then calculate the remaining operating time, based on this together with the current power consumption.*
- *Please be aware that the actual remaining operating time may differ slightly from the calculated time.*
- *With repeated discharges and recharges, the battery's capacity will gradually decrease. In view of this it will be noted that an often used, older battery will not operate for as long as a new battery even when both are fully charged.*

Maximizing battery operating time

A battery's usefulness depends on how long it can supply power on a single charge, while how long the charge lasts in a battery depends on:

- Processor speed
- Screen brightness
- System Sleep Mode
- System Hibernation Mode
- Display power off period
- Hard disk drive power off period
- How often and for how long you use the hard disk drive and external disk(c) drives, for example, optical disc and floppy diskette drive.
- How much charge the battery contained to begin with.
- How you use optional devices, such as a PC Cards, to which the battery supplies power.
- Whether you enable Sleep Mode, which can conserve battery power if you are frequently turning the computer off and on.
- Where you store your programs and data.
- Whether you close the display panel when you are not using the keyboard - closing the display saves power.
- The environmental temperature - operating time decreases at low temperatures.
- The condition of the battery terminals - you should always ensure the terminals stay clean by wiping them with a clean dry cloth before installing the battery pack.

Retaining data with power off

Refer to User Information Guide about Retaining time.

Extending battery life

To maximize the life of your battery packs:

- At least once a month, disconnect the computer from a power source and operate it on battery power until the battery pack fully discharges. Before doing so, follow the steps as detailed below.
 1. Turn off the computer's power.
 2. Disconnect the AC adaptor and turn on the computer's power - if it does not turn on then go to Step 4.
 3. Operate the computer on battery power for five minutes. If you find that the battery pack has at least five minutes of operating time, continue operating until the battery pack is fully discharged, however, if the **Battery** indicator flashes or there is some other warning to indicate a low battery condition, go to Step 4.

4. Connect the AC adaptor to the DC IN 15V jack of the computer, and to a wall outlet that is supplying power. The **DC IN** indicator should glow green, and the **Battery** indicator should glow orange to indicate that the battery pack is being charged, however, in the event that **DC IN** indicator does not glow this indicates that power is not being supplied - check the connections for the AC adaptor and the power cord.
5. Charge the battery pack until the **Battery** indicator glows green.
 - If you have extra battery packs, rotate their use.
 - If you will not be using the system for an extended period, for example for more than one month, remove the battery pack from the computer.
 - Store spare battery packs in a cool dry place out of direct sunlight.

Replacing the battery pack

Please be aware that the battery pack is classified as a consumable item.

The operating life of the battery pack will gradually reduce through repeated charging and discharging, and will need to be replaced when it reaches the end of its operating life. In addition to this, you might also replace a discharged battery pack with a charged spare when you are operating your computer away from an AC power source for an extended period of time.

This section explains how to remove and install the battery pack, and begins with the removal process which is detailed through the following steps.



- *Do not remove the battery pack while the computer is in Sleep Mode. Data is stored in RAM, so if the computer loses power it could be lost.*
- *In Hibernation Mode, data will be lost if you remove the battery pack or disconnect the AC adaptor before the save is completed. Wait for the **Hard Disk Drive** indicator to go out.*
- *Do not touch the battery release latch while holding the computer or the battery pack might fall out due to the unintentional release of the battery release latch and cause injuries.*

Removing the battery pack

To remove a discharged battery, follow the steps as detailed below:

1. Save your work.
2. Turn the computer's power off - ensure that the **Power** indicator is off.
3. Remove all cables and peripherals that are connected to the computer.
4. Close the display panel and turn the computer upside down.
5. Slide the battery lock (1) into its (2) position.

- Slide and hold the battery release latch (2) to disengage the battery pack and then remove it from the computer (3).

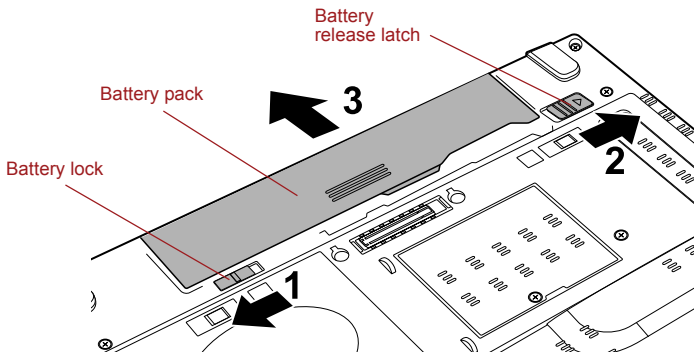



Figure 6-1 Releasing the battery pack

Installing the battery pack

To install a battery pack, follow the steps as detailed below:



Do not touch the battery release latch while holding the computer or the battery pack might fall out due to the unintentional release of the battery release latch and cause injuries.

- Insert the battery pack as far as it will go into the computer (1).
- Ensure that the battery pack is securely in place and the battery lock (2) is in its () position.

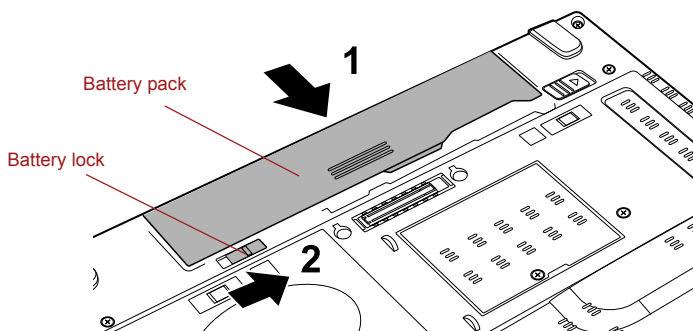

Figure 6-2 Securing the battery pack

- Turn your computer over.

TOSHIBA Password Utility

The TOSHIBA Password Utility provides two levels of password security: User and Supervisor.



Passwords set by the TOSHIBA Password Utility function are different from the Windows password.

User Password

To start the utility, point to or click the following items:

Start -> All Programs -> TOSHIBA -> Utilities -> Password Utility

The User Password dialog box contains two main fields: **User Password** and **User Token**.

User authentication may be required to validate user rights when using "TOSHIBA Password Utility" to delete or change passwords, or create tokens, etc.

User Password field

■ **Set** (button)

Click this button to register a password of up to 50 characters. After a password is set, you will be prompted to enter it when you start the computer. Check "Set the same string simultaneously as the HDD User Password" when setting the HDD User Password.



- *After you set the password, a dialog box will be displayed asking whether you want to save it to a floppy diskette or other media. If you forget the password, you can open the password file on another computer. Be sure to keep the media in a safe place.*
- *When entering the character string to register the password, enter from the keyboard character by character and do not enter as ASCII code or copy-and-paste the character string. In addition, ensure that the registered password is correct by outputting the character string to the password file.*
- *When entering a password, do not enter any characters (for example "!" or "#") produced by pressing the **SHIFT** or **ALT** keys and so on.*

■ **Delete** (button)

Click this button to delete a registered password. Before you can delete a password, you must first enter the current password correctly or insert a proper token. Please use BIOS Setup to change or delete the HDD Passwords or to set the HDD Master Password.



■ *To start BIOS Setup;*

1. *Turn on the computer while pressing the **ESC** key.*
2. *Press the **F1** key when directed.*

■ *To end the BIOS Setup;*

1. *Press **End** and then press the **Y** key to accept the changes. The computer will restart.*

- **Change** (button)
Click this button to change a registered password. Before you can change a password, you must first enter the current password correctly or insert a proper token. Please use BIOS Setup to change or delete the HDD Passwords or to set the HDD Master Password.
- **Owner String** (text box)
You can use this box to associate text with the password. After you enter text, click **Apply** or **OK**. When the computer is started, this text will be displayed together with the prompt asking you to enter a password.



- *If you forget your HDD User Password, TOSHIBA will NOT be able to assist you, and your HDD will be rendered COMPLETELY and PERMANENTLY INOPERABLE. TOSHIBA will NOT be held responsible for any loss of any data, any loss of use or access to your HDD, or for any other losses to you or any other person or organization that result from the loss of access to your HDD. If you can't accept this risk, don't register the HDD User Password.*
- *When saving the HDD User Password shut down or restart the computer. If the computer is not shut down or restarted, the saved data may not be correctly reflected. For more information on shutting down or restarting the computer, refer to [Turning on the power in Chapter 1](#).*

User Token field

- **Create** (button)
You can use an SD Card token, instead of entering the password. After you have registered a password, insert an SD Card in SD Card slot and click **Create**. You can use an SD Card of any capacity, but it must be formatted correctly.

If an unformatted card or one with an incompatible format is inserted, you will be prompted to format it with a tool named TOSHIBA SD Memory Card Format. To start the format tool, point to or click the following items:

Start -> All Programs -> TOSHIBA -> Utilities -> SD Memory Card Format



When you format an SD memory card, all data will be deleted. Be sure to save data on the card to other media before you format the card.

- **Disable** (button)
Click this button to invalidate the token. You cannot re-validate old tokens, but you can use the same SD Cards to create new tokens.



After using the token created for authentication, do not leave it inserted in the SD Card slot, ensure that the token is removed from the slot and stored in a safe location. If the token is left in the slot, there is a danger of theft or a third party using it for authentication and operating the user's computer (resulting in extraction, modification or deletion of data) when the user is not at their desk.

Supervisor Password

If you set a Supervisor Password, some functions might be restricted when a user logs on with the User Password. To set a Supervisor Password, execute the file TOSPU.EXE. The file is located at:

C:\Program Files\Toshiba>PasswordUtility\TOSPU.exe

This utility lets you do the following:

- Register, delete or change the Supervisor Password.
- Create or invalidate a Supervisor Password token.



This function in the TOSHIBA Password Utility lets you invalidate only supervisor tokens or all tokens, including user and supervisor tokens.

- Specify restrictions for general users.

Starting the computer by password

If you have already registered a password, there are three ways to start the computer:

- Insert an SD Card token before you turn on the computer. The computer will start normally, without displaying a password prompt.
- Swipe your fingerprint on the sensor if you have already registered the fingerprint with the Fingerprint utility and enabled Fingerprint System Boot Authentication. If you would not like to swipe your finger or cannot authenticate the fingerprint for some reasons, push the **BACK SPACE** key to skip the fingerprint authentication screen. You can try to swipe the fingerprint up to five times. If you failed fingerprint authentication five times, you must enter the password manually to start the computer.
- Enter the password manually.



The password is necessary only if the computer was turned off in Shut Down Mode or Hibernation Mode.

It is not needed in Sleep Mode and Restart.

To enter a password manually, follow the steps as detailed below:

1. Turn on the power as described in Chapter 1, [Getting Started](#). The following message will appear in the screen:



Password=

2. Enter the Password.
3. Press **ENTER**.



If you enter the password incorrectly three times in a row, the computer shuts off. In this case, you must turn the computer back on to retry password entry.

Power-up modes

The computer has three different power-up modes as follows:

- **Shut Down Mode** : The computer will shut down without saving data - in view of this you must always save your work before you turn the computer off.
- **Hibernation Mode** : Data in memory will be saved to the hard disk drive.
- **Sleep Mode** : Data will be maintained in the computer's memory.



Please refer to the sections [Turning on the power](#) and [Turning off the power](#) in Chapter 1, [Getting Started](#) for further information.

Windows utilities

You can configure various settings associated with both Sleep Mode and Hibernation Mode within the Power Options (to access it, **Start** -> **Control Panel** -> **System and Security** -> **Power Options**).

Hot keys

You can use the **FN + F3** hot key to enter Sleep Mode or **FN + F4** to enter Hibernation Mode - please refer to Chapter 5, [The Keyboard](#) for further details.

Panel power on/off

You can set up your computer so that power is turned off automatically when you close the display panel, and turned on again when you open it. Please note that this function is only available for Sleep Mode or Hibernation Mode, not for Shut Down Mode.



If the panel power off function is enabled, and you manually shut down Windows, do not close the display panel until the shut down process has been completed.

System automatic Sleep/Hibernation

This feature automatically turns off the system in Sleep or Hibernation Mode if the computer is not used for a set duration. Refer to [Special features](#), in Chapter 3 for an explanation of how to set the duration.

Chapter 7

HW Setup

This chapter explains how to use the TOSHIBA HW Setup program to configure your computer, and provides information on settings for various functions.

Accessing HW Setup

To run the HW Setup program, click **Start -> All Programs -> TOSHIBA -> Utilities -> HWSetup**.

HW Setup window

The HW Setup window contains a number of tabs (General, Display, Boot Priority, Keyboard, CPU, LAN, Device Config and USB) to allow specific functions of the computer to be configured.

In addition there are also three buttons : **OK**, **Cancel** and **Apply**.

OK	Accepts your changes and closes the HW Setup window.
Cancel	Closes the window without accepting your changes.
Apply	Accepts all your changes without closing the HW Setup window.

General

This window displays the BIOS version and contains two buttons : **Default** and **About**.

Default	Return all HW Setup values to the factory settings.
About	Display the HW Setup version.

Setup

This field displays the installed **BIOS version** and date.

Display

This tab lets you customize your computer's display settings for either the internal display or an external monitor.

Power On Display

This tab allows you to select the display to be used when the computer is started. Please note that this setting is only available on standard VGA mode and is not available as part of the Windows Desktop properties.



The Power On Display is supported with some models.

Auto-Selected	Selects an external monitor if one is connected, otherwise, it selects the internal display (default).
LCD + Analog RGB	Selects both the internal display and an external monitor for simultaneous display.
System LCD Only	Selects the internal LCD, even if an external monitor is connected.



If the connected external monitor does not support the computer's current video mode, selecting the LCD + Analog RGB mode will not display any image on the external monitor.

Boot Priority

Boot Priority Options

This tab allows you to select the priority for booting the computer - the following settings are available:

FDD → HDD → CD-ROM → LAN	The computer looks for bootable files on devices in the following order: 1. floppy diskette drive* ¹ , 2. hard disk drive, 3. CD-ROM* ² , 4. LAN.
HDD → FDD → CD-ROM → LAN	The computer looks for bootable files on devices in the following order: 1. hard disk drive, 2. floppy diskette drive* ¹ , 3. CD-ROM* ² , 4. LAN.
FDD → CD-ROM → LAN → HDD	The computer looks for bootable files on devices in the following order: 1. floppy diskette drive* ¹ , 2. CD-ROM* ² , 3. LAN, 4. hard disk drive.
HDD → CD-ROM → LAN → FDD	The computer looks for bootable files on devices in the following order: 1. hard disk drive, 2. CD-ROM* ² , 3. LAN, 4. floppy diskette drive* ¹ .
CD-ROM → LAN → FDD → HDD	The computer looks for bootable files on devices in the following order: 1. CD-ROM* ² , 2. LAN, 3. floppy diskette drive* ¹ , 4. hard disk drive.
CD-ROM → LAN → HDD → FDD	The computer looks for bootable files on devices in the following order: 1. CD-ROM* ² , 2. LAN, 3. hard disk drive, 4. floppy diskette drive* ¹ .

You can override the settings and manually select a boot device by pressing one of the following keys while the computer is booting:

U	Selects the USB floppy diskette drive* ¹ .
N	Selects the network.
1	Selects the built-in hard disk drive.
C	Selects the CD-ROM* ² .
M	Selects the USB memory drive.
E	Selects the eSATA HDD.

*¹ The floppy diskette drive will be used to start the computer when there is a bootable disk contained in the external drive. If SD memory card is installed as well, the external floppy diskette drive will be checked first, followed by the SD memory device itself.

*² The optical disc drive will be used to start the computer when there is a bootable disk contained in the drive.

To change the boot drive, follow the steps below.

1. Hold down **F12** and boot the computer.
2. The following menu will be displayed with the following icons: Built-in hard disk drive, eSATA hard disk drive, CD-ROM, FDD (or SD memory card), Network (LAN), USB Memory boot.



Please note that a highlighted bar will only appear under the selected device.

3. Use the left/right cursor keys to highlight the boot device you want and press **ENTER**.



If a Supervisor Password has been set, manual boot device selection functions may be restricted.

The boot device selection methods described above will not change the boot priority settings that have been configured in HW Setup. In addition, if you press a key other than one of those listed, or if the selected device is not installed, the system will continue to boot according to the current and available settings in HW Setup.

HDD Priority Options

If more than one hard disk drive is installed in the computer, this option allows you to set the priority associated with hard disk drive detection - the first hard disk drive detected that has a valid boot command on it will be the device from which the computer will start.

Built-in HDD -> USB -> eSATA	This option sets the priority as the built-in hard disk drive -> USB -> eSATA (Default).
USB -> Built-in HDD -> eSATA	This option sets the priority as the USB -> built-in hard disk drive -> eSATA.
Built-in HDD -> eSATA -> USB	This option sets the priority as the built-in hard disk drive -> eSATA -> USB.
USB -> eSATA -> Built-in HDD	This option sets the priority as the USB -> eSATA -> built-in hard disk drive.
eSATA -> Built-in HDD -> USB	This option sets the priority as the eSATA -> built-in hard disk drive -> USB.
eSATA -> USB -> Built-in HDD	This option sets the priority as the eSATA -> USB -> built-in hard disk drive.



- *If a boot command is not found on the first detected hard disk drive, the system will not boot from next hard disk drive in the list, instead it will search for the next device in the Boot Priority list and startup from this as appropriate.*
- *Please be aware that some modules may not be displayed.*

USB Memory BIOS Support Type

This option allows you to set the type of the USB memory to be used as a startup device.

HDD	Sets the USB memory to be the equivalent of a hard disk drive (default). With this setting, the USB memory device can be used to start the computer as though it were a hard disk drive based on the hard disk drive settings within both the Boot Priority and HDD Priority options detailed previously.
FDD	Sets the USB memory to be the equivalent of a floppy diskette drive. With this setting, the USB memory device can be used to start the computer as though it were a floppy diskette based on the floppy diskette drive settings within the Boot Priority option detailed previously.

Keyboard

Wake-up on Keyboard

When this feature is enabled, and the computer is in Sleep Mode, you can turn on the system by pressing any key. However, please be aware that this option will only work with the internal keyboard and only when the computer is in Sleep Mode.

Enabled	Enables the Wake-up on Keyboard function.
Disabled	Disables the Wake-up on Keyboard function (Default).

CPU

This function allows you to set the processor's operating mode.

Dynamic CPU Frequency Mode

This option allows you to configure the power saving modes associated with the processor - the following settings are available:

Dynamically Switchable	The processor's power consumption and automatic clock speed switching functions are enabled - in use the processor's operation is automatically switched when necessary (default).
Always High	The processor's power consumption and automatic clock speed switching functions are disabled - in use the processor will always run at its highest level of power consumption and its highest speed.
Always Low	The processor's power consumption and automatic clock speed switching functions are disabled - in use the processor will always run at a lower level of power consumption and a low speed.

LAN

Wake-up on LAN

This feature lets the computer's power be turned on when it receives a wake-up signal from the LAN.



Do not install or remove a memory module while Wake-up on LAN is enabled.



- *The Wake-up on LAN function consumes power even when the system is off. Leave the AC adaptor connected while using this feature.*
- *To enable it, you must check both the "Allow the device to wake the computer" and "Only allow management stations to wake the computer" check box within the "Intel Network Connection".*

Power will be automatically turned on when a signal is received from an administrator's computer which is connected via a network.

The following settings can be changed when the Built-in LAN is **Enabled**.

Connect the AC adaptor when using the Wake-up on LAN function. The battery retention time will be shorter than the times listed in this manual when this function is enabled. Refer to the section in chapter 6, [Retaining data with power off](#).

Enabled	Enables Wake-up on LAN (Default).
Disabled	Disables Wake-up on LAN.

Built-in LAN

This feature enables or disables the Built-in LAN.

Enabled	Enables Built-in LAN functions (Default).
Disabled	Disables Built-in LAN functions.

Device Config

Device Configuration

This option allows you to set how the computer's hardware devices will be configured.

All Devices	The computer's BIOS will setup and configure all devices.
Setup by OS	The operating system will setup and configure all of the devices that it can control (Default).

USB

USB KB/Mouse Legacy Emulation

You can use this option to enable or disable USB keyboard/mouse legacy emulation so that, even if your operating system does not support USB devices, you can still use a standard USB mouse and keyboard - to achieve this you should set the appropriate option(s) to Enabled.

Enabled	Enables the USB KB/Mouse Legacy Emulation function (Default).
Disabled	Disables the USB KB/Mouse Legacy Emulation function.

USB-FDD Legacy Emulation

Use this option to enable or disable USB floppy diskette drive legacy emulation. If your operating system does not support USB, you can still use a USB floppy diskette drive by setting the **USB-FDD Legacy Emulation** item to **Enabled**.

Enabled	Enables the USB floppy diskette drive legacy emulation function (Default).
Disabled	Disables the USB floppy diskette drive legacy emulation function.

Chapter 8

Troubleshooting

TOSHIBA have designed this computer for durability, however, should problems occur you are able to use the procedures detailed in this chapter to help determine the cause.

All users should become familiar with this chapter as knowing what might go wrong can help prevent problems from occurring in the first place.

Problem solving process

Resolving problems will be much easier if you observe the following guidelines:

- Stop immediately when you recognize a problem exists as taking further action may result in data loss or damage, or you may destroy valuable problem related information that can help solve the problem.
- Observe what is happening - write down what the system is doing and what actions you performed immediately before the problem occurred. If you have a printer attached, print a copy of the screen using the computer's **PRTSC** key.

Please also be aware that the questions and procedures described in this chapter are meant only as a guide, they are not definitive problem solving techniques. In reality many problems can be solved simply, but a few may require help from your reseller, dealer or service provider - if you find you need to consult others, be prepared to describe the problem in as much detail as possible.

Preliminary checklist

You should always consider the simplest solution first - the items detailed in this checklist are easy to fix and yet can cause what appears to be a serious problem:

- Make sure you turn on all peripheral devices before you turn on the computer - this includes your printer and any other external device you are using.

- Before you attach an external device you should first turn the computer off, then when you turn the computer back on again it will recognize the new device.
- Make sure all optional accessories are configured properly in the computer's setup program and that all required driver software has been loaded (please refer to the documentation included with the optional accessories for further information on its installation and configuration).
- Check all cables to ensure they are correctly and firmly attached to the computer - loose cables can cause signal errors.
- Inspect all connecting cables for loose wires and all connectors for loose pins.
- Check that your floppy diskette, CD or DVD media is correctly loaded and, in the case of a floppy diskette, that its write protect tab is correctly set.

Always try to make detailed notes of your observations and keep them in a permanent error log - this will help you to describe your problems to your reseller, dealer or service provider. In addition, if a problem recurs, the log you have made will help to identify the problem faster.

Analyzing the problem

Sometimes the computer will give you clues that can help you identify why it is malfunctioning. In view of this you should keep the following questions in mind:

- Which part of the computer is not operating properly - keyboard, hard disk drive, display panel, touch pad, touch pad control buttons - as each device will produce different symptoms.
- Check the options within the operating system to ensure that its configuration is set properly.
- What appears on the display? Does it display any messages or random characters? If you have a printer attached, print a copy of the screen using the **PRINT** key and, if possible, look up the messages in the documentation included with the computer, software or operating system.
- Check that all connecting cables are correctly and firmly attached as loose cables can cause erroneous or intermittent signals.
- Do any indicators light, if so, which ones, what color are they and do they stay on or blink? Write down what you see.
- Do you hear any beeps, if so how many, are they long or short and are they high pitched or low pitched? In addition, is the computer making any unusual noises? Write down what you hear.

Record your observations so you can describe them in detail to your reseller, dealer or service provider.

Software	<p>The problems may be caused by your software or disk. If you cannot load a software package, the media may be damaged or the program might be corrupted - in these instances try loading another copy of the software if possible.</p> <p>If an error message appears while you are using a software package you should refer to the documentation supplied with it as this will usually include a problem solving section or a summary of error messages.</p> <p>Next, you should check any error messages against the operating system documentation.</p>
Hardware	<p>If you cannot find a software problem, you should then check the setup and configuration of your hardware. First run through the items in the preliminary checklist as described previously then, if you still cannot correct the problem, try to identify the source - the next section provides checklists for individual components and peripherals.</p>



Before using a peripheral device or application software that is not an authorized Toshiba part or product, make sure the device or software can be used with your computer. Use of incompatible devices may cause injury or may damage your computer.

Hardware and system checklist

This section discusses problems caused by your computer's hardware or attached peripherals. Basic problems may occur in the following areas:

- System start-up
- Self test
- Power
- Password
- Keyboard
- Internal display panel
- Hard disk drive
- DVD-ROM drive
- DVD-ROM&CD-R/RW drive
- DVD Super Multi drive
- USB floppy diskette drive
- PC Card
- ExpressCard
- Smart Card
- SD/SDHC Card
- Memory Stick
- xD picture card
- MultiMediaCard
- Dual Pointing Device
- Fingerprint Sensor
- USB device
- eSATA device
- Additional memory module
- Sound system
- Volume control dial
- External monitor
- i.LINK (IEEE1394) device
- Modem
- LAN
- Wireless LAN
- Bluetooth
- Recovery Discs

System start-up

When the computer does not start properly, check the following items:

- Self Test
- Power Sources
- Power-on Password

Self test

While booting up the computer, self test is executed automatically and the **TOSHIBA** logo is displayed on the screen.

This message remains on the screen for a few seconds.

If the self test is successful, the computer tries to load the operating system according to how the **Boot Priority** option is set within the TOSHIBA HW Setup program.

If any of the following conditions are present, the self test has failed:

- The computer stops and does not proceed to display information or messages except for the TOSHIBA logo.
- Random characters appear on the screen and the system does not function normally.
- The screen displays an error message.

In these instances, turn off the computer, check all cable connections and then restart it - if the self test fails again, contact your reseller, dealer or service provider.

Power

When the computer is not plugged into an AC power outlet, the battery pack is the primary power source. However, your computer also has a number of other power resources, including an intelligent power supply and a Real Time Clock (RTC) battery, all of which are interrelated with any one having the ability to produce apparent power problems.

This section provides checklists for AC power and the battery. If you cannot resolve a problem after following them, the cause may lie with another power related resource - in such an instance you should contact your reseller, dealer or service provider.

Overheating power down

If the processor's temperature reaches an unacceptably high level with either setting, the computer will automatically shuts down to prevent any damage - in this instance all unsaved data in memory will be lost.

Problem	Procedure
Computer shuts down and DC IN indicator blinks orange	Leave the computer off until the DC IN indicator stops blinking.



*It is recommended to leave the computer off until the interior reaches room temperature even though the **DC IN** indicator stops blinking.*

If the computer has reached room temperature and it still does not start, or if it starts but shuts down quickly, contact your reseller, dealer or service provider.

Computer shuts down and its DC IN indicator is flashing green	This indicates a problem with the heat dispersal system - you should contact your reseller, dealer or service provider.
--	---

AC power

If you have trouble turning on the computer with the AC adaptor connected you should check the status of the **DC IN** indicator. Please refer to Chapter 6, [Power and Power-Up Modes](#) for further information.

Problem	Procedure
AC adaptor doesn't power the computer (DC IN indicator does not glow green)	<p>Check the connections to make sure that the power cord/adaptor is firmly connected to the computer and a working power outlet.</p> <p>Check the condition of the cord and terminals. If the cord is frayed or damaged it should be replaced, while if the terminals are soiled, they should be cleaned with a clean cotton cloth.</p> <p>If the AC adaptor still does not power the computer, you should contact your reseller, dealer or service provider.</p>

Battery

If you suspect a problem with the battery, you should check the status of the **DC IN** indicator as well as the **Battery** indicator. Please refer to Chapter 6, *Power and Power-Up Modes* for more information on these indicators, together with general battery operation.

Problem	Procedure
Battery doesn't power the computer	The battery may be discharged - connect the AC adaptor to recharge the battery.
Battery doesn't charge when the AC adaptor is attached (Battery indicator does not glow orange).	<p>If the battery is completely discharged, it will not begin charging immediately, in these instances you should wait a few minutes before trying again. If the battery still does not charge, you should check that the power outlet the AC adaptor is connected to is supplying power - this can be tested by plugging another appliance into it.</p> <p>Check whether the battery is hot or cold to the touch - if so, it will not charge properly and should be allowed to reach room temperature before you try again.</p> <p>Unplug the AC adaptor and remove the battery to make sure its connecting terminals are clean - if necessary wipe them with a soft dry cloth lightly dipped in alcohol.</p> <p>Connect the AC adaptor and replace the battery, taking care to ensure that it is securely seated in the computer.</p> <p>Check the Battery indicator - if it does not glow, allow the computer to charge the battery for at least twenty minutes. If the Battery indicator starts to glow after this period, allow the battery to continue to charge for at least another twenty minutes before turning on the computer. However, if the indicator still does not glow, the battery may be at the end of its operating life and should be replaced. However, if you do not believe the battery is at the end of its operating life, you should speak to your reseller, dealer or service provider.</p>
Battery doesn't power the computer as long as expected	<p>If you frequently recharge a partially charged battery, the battery might not charge to its full potential - in these instances you should fully discharge the battery and then attempt to charge it again.</p> <p>Check the Power saver option under Select a power plan in the Power Options.</p>

Real Time Clock

Problem	Procedure
<p>The following message is Displayed on the screen:</p> <p>RTC battery is low or CMOS checksum is inconsistent. Press [F1] key to set Date/Time.</p>	<p>The charge in the Real Time Clock (RTC) battery has run out - you will need to set the date and time in the BIOS setup application by using the following steps:</p> <ol style="list-style-type: none"> 1. Press the F1 key - the BIOS setup application will load. 2. Set the date in the System Date field. 3. Set the time in the System Time field. 4. Press the END key - a confirmation message will be displayed. 5. Press the Y key - the BIOS setup application will end and the computer will restart.

Password

Problem	Procedure
Cannot enter password	Please refer to the TOSHIBA Password Utility section in Chapter 6, Power and Power-Up Modes for further information.

Keyboard

Keyboard problems can be caused by the setup and configuration of the computer - please refer to Chapter 5, [The Keyboard](#) for further information.

Problem	Procedure
Some letter keys produce numbers	Check that the numeric keypad overlay is not activated - press the FN + F11 hot key and try typing again.
Output to screen is garbled	<p>Please refer to your software's documentation to ensure that its is not remapping the keyboard in any way (remapping involves changing or reassigning the function of each key).</p> <p>If you are still unable to use the keyboard, you should contact your reseller, dealer or service provider.</p>

Internal display panel

Apparent computer's display panel problems may be related to the computer's setup and configuration - please refer to Chapter 7, *HW Setup*, for further information.

Problem	Procedure
No display	Press the FN + F5 hot keys to adjust the display priority, and to make sure it is not set for output to an external monitor.
Markings appear on the computer's display panel.	These marks may have come from contact with the keyboard and Touch Pad while the display panel has been closed. You should try to remove the marks by gently wiping the display panel with a clean dry cloth or, if this fails, with a good quality LCD screen cleaner. In this latter instance you should always follow the instructions with the screen cleaner and always ensure you let the display panel dry properly before closing it.
Problems above remain unresolved or other problems occur	You should initially refer to the documentation supplied with you software to determine if it is this that is causing the problems. Alternatively you may wish to run the TOSHIBA PC Diagnostic Tool to check the general operation of the computer. If you are still unable to resolve the problem, contact your reseller, dealer or service provider.

Hard disk drive

Problem	Procedure
Computer does not boot from hard disk drive	Check to see whether that is a floppy diskette in the floppy diskette drive or a CD-ROM/DVD-ROM in the optical disc drive - if so remove it and try to start the computer again. If this has no effect, check the Boot Priority setting within the TOSHIBA HW Setup utility - please refer to the <i>Boot Priority</i> section in Chapter 7, HW Setup for further information.
	Please refer to your operating system documentation in order to determine whether there is a problem with any of the operating system files or settings.

Problem	Procedure
Slow performance	<p>The files on the hard disk drive may be fragmented - in this instance you should run the disk Defragmentation utility to check the condition of your files and the hard disk drive. Please refer to the operating system's documentation or online Help File for further information on operating and using the Defragmentation utility.</p> <hr/> <p>As a last resort you should reformat the hard disk drive and then reload the operating system and all other files and data. If you are still unable to resolve the problem, contact your reseller, dealer or service provider.</p>

DVD-ROM drive

For more information, refer to Chapter 4, *Operating Basics*.

Problem	Procedure
You cannot access a CD/DVD in the drive	<p>Make sure the drive's disc tray is securely closed. Press gently until it clicks into place.</p> <hr/> <p>Open the disc tray and make sure the CD/DVD is properly seated. It should lie flat with the label facing up.</p> <hr/> <p>A foreign object in the disc tray could block laser light from reading the CD/DVD. Make sure there is no obstruction. Remove any foreign object.</p> <hr/> <p>Check whether the CD/DVD is dirty. If it is, wipe it with a clean cloth dipped in water or a neutral cleaner. Refer to the <i>Media care</i> section in Chapter 4 for details on cleaning.</p>
Some CD/DVDs run correctly, but others do not	<p>The software or hardware configuration may be causing a problem. Make sure the hardware configuration matches your software's needs. Check the CD/DVD's documentation.</p>

Check the type of CD/DVD you are using. The drive supports:

DVD-ROM: DVD-ROM, DVD-Video

CD-ROM: CD-DA, CD-Text, Photo CD (single/multi-session), CD-ROM Mode 1, Mode 2, CD-ROM XA Mode 2 (Form1, Form2), Enhanced CD (CD-EXTRA), Addressing Method 2

Check the region code on the DVD. It must match that on the DVD-ROM. Region codes are listed in the [Optical disc drives](#) section in Chapter 2, The Grand Tour.

DVD-ROM&CD-R/RW drive

For more information, refer to Chapter 4, [Operating Basics](#).

Problem	Procedure
<p>You cannot access a CD/DVD in the drive</p>	<p>Make sure the drive's disc tray is securely closed. Press gently until it clicks into place.</p> <hr/> <p>Open the disc tray and make sure the CD/DVD is properly seated. It should lie flat with the label facing up.</p> <hr/> <p>A foreign object in the disc tray could block laser light from reading the CD/DVD. Make sure there is no obstruction. Remove any foreign object.</p> <hr/> <p>Check whether the CD/DVD is dirty. If it is, wipe it with a clean cloth dipped in water or a neutral cleaner. Refer to the Media care section in Chapter 4 for details on cleaning.</p>
<p>Some CD/DVDs run correctly, but others do not</p>	<p>The software or hardware configuration may be causing a problem. Make sure the hardware configuration matches your software's needs. Check the CD/DVD's documentation.</p>

Check the type of CD/DVD you are using. The drive supports:

DVD-ROM: DVD-ROM, DVD-Video

CD-ROM: CD-DA, CD-Text, Photo CD (single/multi-session), CD-ROM Mode 1, Mode 2, CD-ROM XA Mode 2 (Form1, Form2), Enhanced CD (CD-EXTRA), Addressing Method 2

Recordable CD: CD-R, CD-RW

Check the region code on the DVD. It must match that on the DVD-ROM&CD-R/RW drive. Region codes are listed in the [Optical disc drives](#) section in Chapter 2, The Grand Tour.

Cannot write correctly

If you have trouble writing, make sure you are observing the following precautions:

- Use only media recommended by TOSHIBA.
- Do not use the mouse or keyboard during writing.
- Use only the software supplied with the computer for recording.
- Do not run or start other software during writing.
- Do not jar the computer during writing.
- Do not connect/disconnect external devices or install/remove internal cards during writing.

If you are still unable to resolve the problem, contact your reseller, dealer or service provider.

DVD Super Multi drive

For more information, refer to Chapter 4, *Operating Basics*.

Problem	Procedure
<p>You cannot access a CD/DVD in the drive</p>	<p>Make sure the drive's disc tray is securely closed. Press gently until it clicks into place.</p> <hr/> <p>Open the disc tray and make sure the CD/DVD is properly seated. It should lie flat with the label facing up.</p> <hr/> <p>A foreign object in the disc tray could block laser light from reading the CD/DVD. Make sure there is no obstruction. Remove any foreign object.</p> <hr/> <p>Check whether the CD/DVD is dirty. If it is, wipe it with a clean cloth dipped in water or a neutral cleaner. Refer to the <i>Media care</i> section in Chapter 4 for details on cleaning.</p>
<p>Some CD/DVDs run correctly, but others do not</p>	<p>The software or hardware configuration may be causing a problem. Make sure the hardware configuration matches your software's needs. Check the CD/DVD's documentation.</p> <hr/> <p>Check the type of CD/DVD you are using. The drive supports:</p> <p>DVD-ROM: DVD-ROM, DVD-Video</p> <p>CD-ROM: CD-DA, CD-Text, Photo CD (single/multi-session), CD-ROM Mode 1, Mode 2, CD-ROM XA Mode 2 (Form1, Form2), Enhanced CD (CD-EXTRA), Addressing Method 2</p> <p>Recordable DVD: DVD-R/+R DL, DVD+R/+R DL, DVD-RW, DVD+RW, DVD-RAM</p> <hr/> <p>Check the region code on the DVD. It must match that on the DVD Super Multi drive. Region codes are listed in the <i>Optical disc drives</i> section in Chapter 2, The Grand Tour.</p>

USB floppy diskette drive

For further information, please refer to Chapter 3, *Hardware, Utilities and Options*.

Problem	Procedure
Drive does not operate	Check the connection between the computer and the drive to ensure that it is properly attached.
Some programs run correctly but others do not	The computer's software or hardware configuration may be causing a problem - ensure that these configurations match your requirements (refer to any relevant documentation, for example that supplied with any software in use, for further information).
You cannot access the external floppy diskette drive	Try another floppy diskette in the drive - if you are able to access this disk then it indicates the original disk and not the drive is probably causing the problem. If you are still unable to resolve the problem, contact your reseller, dealer or service provider.

PC Card

For further information, please refer to Chapter 3, *Hardware, Utilities and Options*.

Problem	Procedure
PC Card error occurs	Remove the PC Card from the computer and then reinsert it in order to ensure it is firmly connected. In the event that the PC Card is attached to an external peripheral device, ensure that this connection is properly made. If the problem persists, then you should refer to the documentation supplied with your PC Card for further information. If you are still unable to resolve the problem, contact your reseller, dealer or service provider.

SD/SDHC Card

For further information, please refer to Chapter 3, *Hardware, Utilities and Options*.

Problem	Procedure
SD/SDHC Card error occurs	Remove the SD/SDHC Card from the computer and then reinsert it in order to ensure it is firmly connected. If the problem persists, then you should refer to the documentation supplied with your SD/SDHC Card for further information.
You cannot write to an SD/SDHC Card	Remove the SD/SDHC Card from the computer and check to ensure that it is not write protected.
You cannot read a file	Check to ensure the required file is actually on the SD/SDHC Card that is inserted into the computer. If you are still unable to resolve the problem, contact your reseller, dealer or service provider.

Smart Card

For further information, please refer to Chapter 3, *Hardware, Utilities and Options*.

Problem	Procedure
Smart Card error occurs	Remove the Smart Card from the computer, make sure to confirm that the card oriented correctly and reinsert it in order to ensure it is firmly connected. If the problem persists, then you should refer to the documentation supplied with your Smart Card for further information.

Memory Stick

For further information, please refer to Chapter 3, *Hardware, Utilities and Options*.

Problem	Procedure
Memory Stick/Memory Stick PRO/Memory Stick PRO Duo error occurs	Remove the Memory Stick/Memory Stick PRO/Memory Stick PRO Duo from the computer and then reinsert it in order to ensure it is firmly connected. If the problem persists, then you should refer to the documentation supplied with your Memory Stick/Memory Stick PRO/Memory Stick PRO Duo for further information.
You cannot write to an Memory Stick/Memory Stick PRO/Memory Stick PRO Duo	Remove the Memory Stick/Memory Stick PRO/Memory Stick PRO Duo from the computer and check to ensure that it is not write protected.
You cannot read a file	Check to ensure the required file is actually on the Memory Stick/Memory Stick PRO/Memory Stick PRO Duo that is inserted into the computer. If you are still unable to resolve the problem, contact your reseller, dealer or service provider.

xD picture card

For further information, please refer to Chapter 3, *Hardware, Utilities and Options*.

Problem	Procedure
xD picture card error occurs	Remove the xD picture card from the computer and then reinsert it in order to ensure it is firmly connected. If the problem persists, then you should refer to the documentation supplied with your xD picture card for further information.
You cannot read a file	Check to ensure the required file is actually on the xD picture card that is inserted into the computer. If you are still unable to resolve the problem, contact your reseller, dealer or service provider.

MultiMediaCard

For further information, please refer to Chapter 3, *Hardware, Utilities and Options*.

Problem	Procedure
MultiMediaCard error occurs	Remove the MultiMediaCard from the computer and then reinsert it in order to ensure it is firmly connected. If the problem persists, then you should refer to the documentation supplied with your MultiMediaCard for further information.
You cannot write to a MultiMediaCard	Remove the MultiMediaCard from the computer and check to ensure that it is not write protected.
You cannot read a file	Check to ensure the required file is actually on the MultiMediaCard that is inserted into the computer. If you are still unable to resolve the problem, contact your reseller, dealer or service provider.

Dual Pointing device

If you are using a USB mouse, you should also refer to both the *USB device* section in this chapter, and the documentation supplied with your mouse.

Touch Pad/AccuPoint

Problem	Procedure
Either the Touch Pad or the AccuPoint does not work.	Check the Device Select settings. Click Start -> Control Panel -> Hardware and Sound -> Mouse . Pressing FN + F9 to enables.
On-screen pointer does not respond to pointing device operation	In this instance the system might be busy - Try moving the mouse again after waiting a short while.
Double-tapping (Touch Pad) or double-clicking (AccuPoint) does not work	In this instance, you should initially try changing the double-click speed setting within the Mouse Control utility. <ol style="list-style-type: none"> 1. To access this utility, click Start -> Control Panel -> Hardware and Sound -> Mouse. 2. Within the Mouse Properties window, click the Buttons tab. 3. Set the double-click speed as required and click OK.

Problem	Procedure
The on-screen pointer moves too fast or too slow	<p data-bbox="520 135 1041 199">In this instance, you should initially try changing the speed setting within the Mouse Control utility.</p> <ol data-bbox="520 199 1041 391" style="list-style-type: none"><li data-bbox="520 199 1041 263">1. To access this utility, click Start -> Control Panel -> Hardware and Sound -> Mouse.<li data-bbox="520 263 1041 327">2. Within the Mouse Properties window, click the Pointer Options tab.<li data-bbox="520 327 1041 391">3. Set the pointer speed as required and click OK.
The reaction of Touch pad is either too sensitive or not sensitive enough.	<p data-bbox="520 391 1041 430">Adjust the touch Sensitivity.</p> <ol data-bbox="520 430 1041 957" style="list-style-type: none"><li data-bbox="520 430 1041 494">1. Click Start -> Control Panel -> Hardware and Sound -> Mouse.<li data-bbox="520 494 1041 558">2. Within the Mouse Properties window, click the Advanced tab.<li data-bbox="520 558 1041 622">3. Click the Advanced feature settings... button.<li data-bbox="520 622 1041 654">4. Advanced feature settings is displayed.<li data-bbox="520 654 1041 742">5. In the Touch Pad tab, click Settings... button within the Pointer speed and tapping settings.<li data-bbox="520 742 1041 805">6. Detailed Touch Pad settings window is displayed.<li data-bbox="520 805 1041 869">7. Move the slider bar to adjust the sensitivity in the Touch Sensitivity.<li data-bbox="520 869 1041 901">8. Click OK button.<li data-bbox="520 901 1041 957">9. Click the OK button on Advanced feature setting screen. <p data-bbox="520 957 1041 1023">If you are still unable to resolve the problem, contact your reseller, dealer or service provider.</p>

USB mouse

Problem	Procedure
On-screen pointer does not respond to mouse operation	<p>In this instance the system might be busy - Try moving the mouse again after waiting a short while.</p> <hr/> <p>Remove the mouse from the computer and then reconnect it to a free USB port it in order to ensure it is firmly attached.</p>
Double-clicking does not work	<p>In this instance, you should initially try changing the double-click speed setting within the Mouse Control utility.</p> <ol style="list-style-type: none">1. To access this utility, click Start -> Control Panel -> Hardware and Sound -> Mouse.2. Within the Mouse Properties window, click the Buttons tab.3. Set the double-click speed as required and click OK.
The on-screen pointer moves too fast or too slow	<p>In this instance, you should initially try changing the speed setting within the Mouse Control utility.</p> <ol style="list-style-type: none">1. To access this utility, click Start -> Control Panel -> Hardware and Sound -> Mouse.2. Within the Mouse Properties window, click the Pointer Options tab.3. Set the pointer speed as required and click OK.
The on-screen pointer moves erratically	<p>The elements of the mouse responsible for detecting movement might be dirty - please refer to the documentation supplied with the mouse for instructions on how to clean it.</p> <p>If you are still unable to resolve the problem, contact your reseller, dealer or service provider.</p>

Fingerprint Sensor

Problem	Procedure
Reading of the fingerprint was not successful.	<p>In this instance you should try the fingerprint reading operation again using the correct finger position - please refer to <i>Using the Fingerprint Sensor</i> in Chapter 4, Operating Basics for further information.</p> <p>Alternatively, you should try the recognition process again using another enrolled finger.</p> <p>The fingerprint sensor compares and analyzes the unique characteristics in a fingerprint. However, there may be instances where certain users are unable to register their fingerprints due to insufficient unique characteristics in their fingerprints.</p> <p>The recognition success rate may differ from user to user.</p>
The fingerprint cannot be read due to injuries to the finger.	<p>In this instance you should try the recognition process again using another enrolled finger. However, if fingerprints from all the enrolled fingers cannot be read, you should instead log into the computer by using the keyboard to input the password.</p> <p>If you are still unable to resolve the problem, contact your reseller, dealer or service provider.</p>

USB device

In addition to the information in this section, please also refer to the documentation supplied with your USB device.

Problem	Procedure
USB device does not work	<p>Remove the USB device from the computer and then reconnect it to a free port it in order to ensure it is firmly attached.</p> <hr/> <p>Ensure that any required USB device drivers are properly installed - to achieve this you should refer to both the device documentation and the operating system documentation.</p> <hr/> <p>If you are using an operating system that does not support USB, you are still able to use a USB mouse and/or USB keyboard by setting the USB KB/Mouse Legacy Emulation option within the TOSHIBA HW Setup utility to Enabled.</p> <p>If you are still unable to resolve the problem, contact your reseller, dealer or service provider.</p>

USB Sleep and Charge function

For more information and settings, please refer to the [Using the TOSHIBA USB Sleep and Charge Utility](#) section in Chapter 4, Operating Basics.

Problem	Procedure
I cannot use the "USB Sleep and Charge function".	<p>The setting of "USB Sleep and Charge function" may be [Disabled]. Change the setting to [Enabled].</p> <hr/> <p>When there is a current overflow of the external device connected to the compatible port, USB bus power (DC5V) supply may be stopped for safety reasons. When this happens, disconnect an external device if some external devices are connected. After that, turn the power of the computer ON/OFF to restore the function. If this function can not be still used even if only one external device is connected, stop using the external device because its current is over the acceptable value of this computer.</p>

Problem	Procedure
	<p>Some external devices may not be able to use the "USB Sleep and Charge function". In this case, please try one or more of the following methods.</p> <ul style="list-style-type: none"> ■ Change a mode setting of [Enabled]. ■ Turn OFF the computer while external devices are connected. ■ Connect external devices after turning OFF of the computer. <p>If this function can not be still used, change the setting to [Disabled] and stop using this function.</p>
<p>The battery depletes quickly even when I turned OFF the power of the computer.</p>	<p>When "USB Sleep and Charge function" is set to [Enabled], USB bus power (DC5V) will be supplied to the external device connected to the compatible port. If external device is connected to the compatible port when the AC adaptor is not connected to the computer, the battery of the computer will be depleted even when the power of the computer is turned OFF.</p> <p>Connect the AC adaptor to the computer or change the "USB Sleep and Charge function" setting to [Disabled] or if there is a USB port that does not have the USB Sleep and Charge function-compatible icon (⚡), use that port.</p>
<p>External devices connected to the compatible ports do not work when connected to a compatible port.</p>	<p>Some external devices may not work when connected to a compatible port when the "USB Sleep and Charge function" is [Enabled].</p> <p>Reconnect the external device after turning ON the computer.</p> <p>If the external device still does not work, connect device to a USB port, if there is one, that does not have the USB Sleep and Charge function-compatible icon (⚡) or change the "USB Sleep and Charge function" setting to [Disabled].</p>
<p>The "USB Wakeup function" does not work.</p>	<p>When "USB Sleep and Charge function" is set to [Enabled], the "USB Wakeup function" does not work for ports that support the USB Sleep and Charge function.</p> <p>In that case, use a USB port, if there is one, that does not have the USB Sleep and Charge function-compatible icon (⚡) or change the "USB Sleep and Charge function" setting to [Disabled].</p>

eSATA device

In addition to the information in this section, please also refer to the documentation supplied with your eSATA device.

Problem	Procedure
eSATA device does not work	<p>Remove the eSATA device from the computer and then reconnect it to a free port it in order to ensure it is firmly attached.</p> <p>A connected eSATA device may not be recognized if it is connected to the computer's eSATA/USB combo port while the computer is in Sleep Mode or Hibernation Mode. If this occurs, disconnect the eSATA device and then reconnect the device while the computer is turned on.</p> <hr/> <p>Ensure that any required eSATA device drivers are properly installed - to achieve this you should refer to both the device documentation and the operating system documentation.</p> <p>If you are still unable to resolve the problem, contact your reseller, dealer or service provider.</p>

Additional memory module

Please also refer to Chapter 3, *Hardware, Utilities and Options*, for further information on installing and removing memory modules.

Problem	Procedure
<p>If there is a memory malfunction, the Power indicator will repeatedly flash (on for 0.5 seconds, off for 0.5 seconds) in the following patterns;</p> <p>If there is an error in only slot A or no memory module is inserted in Slot A: orange twice, then green once.</p> <p>If there is an error in Slot B: orange once, then green twice.</p> <p>If there are errors in both Slot A and Slot B: orange twice, then green twice.</p>	<p>In the event the Power indicator flashes when the computer is turned on, you should first check that the installed memory module(s) are compatible with the computer. If there is an error with a compatible memory module, there is a possibility the memory module is damaged.</p> <hr/> <p>If you determine that an incompatible module has been installed, you should follow the steps as detailed below:</p> <ol style="list-style-type: none"> 1. Turn off the computer. 2. Disconnect the AC adaptor and all peripheral devices. 3. Remove the battery pack. 4. Remove the incompatible memory module. 5. Install the battery and/or connect the AC adaptor. 6. Turn on the computer. <p>If you are still unable to resolve the problem, contact your reseller, dealer or service provider.</p>

Problem	Procedure
An error will occur if a memory module is inserted into Slot B while no memory module is inserted in Slot A.	Remove the memory module from Slot B and insert it into Slot A.

Sound system

In addition to the information in this section, please also refer to the documentation supplied with your audio device.

Problem	Procedure
No sound is heard	<p>Adjust the volume control dial.</p> <p>To increase the volume move the volume control dial to the right, and to decrease it move the volume control dial to the left.</p> <hr/> <p>Check the software volume settings.</p> <hr/> <p>Please check to see if Mute is turned to Off</p> <hr/> <p>Check to make sure the headphone connection is secure.</p> <hr/> <p>Check within the Windows Device Manager application to ensure the sound device is enabled and that the device is properly working.</p> <p>For further information, please refer to "Troubleshooting in Windows" section of Windows Help and Support.</p>
Annoying sound is heard	<p>In this instance you may be experiencing feedback from either the internal microphone or an external microphone connected to the computer - please refer to Sound System in Chapter 4, Operating Basics for further information.</p> <p>Volume cannot be adjusted during Windows start up or shut down.</p> <p>If you are still unable to resolve the problem, contact your reseller, dealer or service provider.</p>

Volume control dial

Problem	Procedure
No sound is heard	<p>Adjust the volume control dial.</p> <p>To increase the volume move the volume control dial to the right, and to decrease it move the volume control dial to the left.</p> <p>Turn the volume control dial while verifying the volume in order to adjust.</p>
Annoying sound is heard	<p>Volume cannot be adjusted during Windows start up or shut down.</p> <p>If you are still unable to resolve the problem, contact your reseller, dealer or service provider.</p>

External monitor

Please also refer to Chapter 3, *Hardware, Utilities and Options*, and to the documentation supplied with your monitor for further information.

Problem	Procedure
Monitor does not turn on	<p>After confirming that the monitor's power switch is on, you should check the connections to make sure that the power cord/adaptor is firmly connected to the monitor and to a working power outlet.</p>
No display	<p>Try adjusting the contrast and brightness controls on the external monitor.</p> <hr/> <p>Press the FN + F5 hot key in order to change the display priority and ensure that it is not set for the internal display only.</p> <hr/> <p>Check to see if the external monitor is connected.</p> <p>When the external monitor is set as the primary display device in extended desktop mode, it will not display when the computer wakes up from Sleep Mode if the external monitor has been disconnected while in Sleep Mode.</p> <p>To keep this from happening, do not disconnect the external monitor while the computer is in Sleep or Hibernation Mode.</p> <p>Remember to turn off the computer before disconnecting the external monitor.</p>

Problem	Procedure
	When the display panel and an external monitor are set to clone mode and they are turned off by the timer, the display panel or the external monitor may not display when turned on again. If this occurs, press FN + F5 to re-set the display panel and external monitor to clone mode.
Display error occurs	Check that the cable connecting the external monitor to the computer is firmly attached. If you are still unable to resolve the problem, contact your reseller, dealer or service provider.

i.LINK (IEEE1394) device

Problem	Procedure
i.LINK device does not function	Make sure the cable is securely connected to the computer and to the device. Make sure the device's power is turned on. Reinstall the drivers. Open the Windows Control Panel and double-click the Add Hardware icon. Follow the on-screen directions. Restart Windows. If problems persist, contact your dealer.

Modem



This information is applicable to the models equipped with a built-in modem.

Problem	Procedure
Communication software can't initialize modem	Make sure the computer's internal modem settings are correct - please refer to the Phone and Modem Options link within the Windows Control Panel.
You can hear a dial tone but can't make a call	If the call is going through a Private Branch Exchange (PBX), take care to ensure that the communication application's tone dial detection feature is disabled.

Problem	Procedure
You place a call, but a connection can't be made	Make sure that the settings are correct within your communication application.
After making a call you can't hear a ring	Ensure that the communication application's tone or pulse dialling selection feature is set correctly.
Communication is cut off unexpectedly	The computer will automatically cut off communication when connection with the carrier is not successful for a set time interval - try lengthening this time interval within your communication application.
A CONNECT display is quickly replaced by NO CARRIER	Ensure that the communication application's error control feature is set correctly.
Character display becomes garbled during a communication	When transmitting data you should ensure that the parity bit and stop bit settings correspond with those of the remote computer - you should check the flow control and communication protocol settings within your communication application.
You cannot receive an incoming call	Ensure that the communication application's rings before auto answer feature is set correctly. If you are still unable to resolve the problem, contact your reseller, dealer or service provider.

LAN

Problem	Procedure
Cannot access LAN	Check for a firm cable connection between the LAN jack and the LAN hub.
Wake-up on LAN does not work	Make sure the AC adaptor is connected. The Wake-up on LAN function consumes power even when the system is off. If problems persist, consult your LAN administrator.

Wireless LAN

If the following procedures do not restore LAN access, consult your LAN administrator. For more information on wireless communication, refer to Chapter 4, *Operating Basics*.

Problem	Procedure
Cannot access Wireless LAN	Make sure the computer's Wireless communication switch is set to on. If problems persist, contact your LAN administrator.

Bluetooth

For further information on Bluetooth wireless communication, please refer to Chapter 4, *Operating Basics*.

Problem	Procedure
Cannot access Bluetooth device	Check to ensure the computer's Wireless Communication Switch is set to on.
	Check to ensure the Bluetooth Manager application is running on the computer and that power to the external Bluetooth device is turned on.
	Check to ensure that no optional Bluetooth Adaptor is installed in the computer - the built-in Bluetooth hardware cannot operate simultaneously with another Bluetooth controller. If you are still unable to resolve the problem, contact your reseller, dealer or service provider.

Recovery Discs

Problem	Procedure
<p>The following message appears when executing Recovery Media Creator.</p> <p>"The Recovery Media Creator can not be launched because there is no recovery partition."</p>	<p>You will see this message if you have previously chosen to remove the partition and are trying to create "Recovery Media".</p> <p>When there is no recovery partition, the Recovery Media Creator cannot make Recovery Media.</p> <p>However, if you have already created a "Recovery Media", you can use it to restore the recovery partition.</p> <p>Simply follow the instructions in <i>Restoring the pre-installed software from your created Recovery Media</i> section in Chapter 1, Getting Started.</p> <p>You will be directed to select "Restore Original Factory Image" from the drop-down menu.</p> <p>If you have not created "Recovery Media", please contact TOSHIBA support for assistance.</p>

Using Windows® XP Mode on your Windows® 7 computer (available on certain models)

Your computer supports virtualization technology that enables you to run Windows XP-compatible applications on your Windows 7 computer. This gives you the flexibility to continue using legacy applications while still benefiting from Windows 7 improvements.

Virtual Windows XP Mode is supported only on systems running Windows 7 Professional and Windows 7 Ultimate.

To take advantage of virtual Windows XP Mode, you may need to enable the Virtualization Technology setting in your computer's BIOS (Basic Input/Output System). To check this setting and enable it if necessary, do the following:

1. Start or restart your computer while pressing the **ESC** key. The BIOS settings screen displays.
2. Press the **F1** key.
3. Set "Virtualization Technology" to **Enable**.
4. Restart the computer.

Some models are equipped with a "Virtualization Technology".

For more information on running Windows XP Mode on your Windows 7 system, please visit Microsoft's Web site at www.microsoft.com/windows/virtual-pc.

TOSHIBA support

If you require any additional help using your computer or if you are having problems operating the computer, you may need to contact TOSHIBA for additional technical assistance.

Before you call

Some problems you experience may be related to software or the operating system so it is important that you investigate other sources of assistance first. Before contacting TOSHIBA, try the following:

- Review troubleshooting sections in the documentation supplied with your software and/or peripheral devices.
- If a problem occurs when you are running software applications, consult the software documentation for troubleshooting suggestions and consider calling the software company's technical support department for assistance.
- Consult the reseller or dealer from where you purchased your computer and/or software - they are your best resource for current information and support.

Where to write

If you are still unable to solve the problem and suspect that it is hardware related, write to TOSHIBA at the nearest location listed below:

Outside of Europe	In Europe
<p>Australia TOSHIBA Australia Pty. Ltd. Information Systems Division Building C, 12-24 Talavera Rd, North Ryde, 2113, NSW, Australia.</p>	<p>Germany & Austria TOSHIBA Europe (I.E.) GmbH Geschäftsbereich, Deutschland-Österreich Hammfelddamm 8, D-41460 Neuss, Germany</p>
<p>Canada TOSHIBA of Canada Ltd. 191 McNabb Street, Markham, Ontario L3R 8H2</p>	<p>France TOSHIBA Systèmes France S.A. 7, Rue Ampère B.P. 131, 92804 Puteaux Cedex</p>
<p>China TOSHIBA Personal Computer & Network (Shanghai) Co., Ltd. 10F, BEA Finance Tower, No.66 Hua Yuan Shi Qiao Road, Pudong, Shanghai, P.R.China 200120</p>	<p>Netherlands TOSHIBA Information Systems, Benelux B.V. Rivium Boulevard 41 2909 LK Capelle a/d IJssel</p>

Outside of Europe	In Europe
<p>Singapore TOSHIBA Singapore Pte. Ltd. 438B Alexandra Road #06-01 Alexandra Technopark Singapore 119968</p>	<p>Spain TOSHIBA Information Systems, ESPAÑA Parque Empresarial San Fernando Edificio Europa, 1a Planta, Escalera A 28830 Madrid España</p>
<p>United States of America TOSHIBA America Information Systems, Inc. 9740 Irvine Boulevard Irvine, California 92618 USA</p>	<p>United Kingdom TOSHIBA Information Systems (U.K.) Ltd. TOSHIBA Court Weybridge Business Park Addlestone Road Weybridge, Surrey KT15 2UL</p>
<p>India TOSHIBA India Pvt Ltd. PC Division 6th Floor, DR Gopal Das Bhawan Barakhamba Road, Delhi- 110001, India</p>	<p>The Rest of Europe TOSHIBA Europe (I.E.) GmbH Geschäftsbereich, Deutschland- Österreich Hammfelddamm 8, D- 41460 Neuss, Germany</p>

Appendix A

Specifications

This appendix summarizes the computer's technical specifications.

Physical Dimensions

Refer to User Information Guide about Size.

Environmental Requirements

Conditions	Ambient temperature	Relative humidity
Operating	5°C (41°F) to 35°C (95°F)	20% to 80% (noncondensing)
Non-operating	-20°C (-4°F) to 65°C (149°F)	10% to 90% (noncondensing)
Wet-bulb temperature	26°C maximum	
Conditions	Altitude (from sea level)	
Operating	-60 to 3,000 meters	
Non-operating	-60 to 10,000 meters maximum	

Power Requirements

AC adaptor	100-240 volts AC 50 or 60 hertz (cycles per second)
Computer	15 V DC 5.0 amperes

Built-in Modem



This information is applicable to the models equipped with a built-in modem.

Network control unit (NCU)

Type of NCU	AA
Type of line	Telephone line (analog only)
Type of dialing	Pulse Tone
Control command	AT commands EIA-578 commands
Monitor function	Computer's speaker

Communication specifications

Communication system	Data:	Full duplex
	Fax:	Half duplex
Communication protocol	Data	
	ITU-T-Rec (Former CCITT)	V.21/V.22/V.22bis/V.32/V.32 bis/V.34/V.90
	Bell	103/212A
	Fax	
	ITU-T-Rec (Former CCITT)	V.17/V.29/V.27ter/V.21 ch2

Communication speed	Data transmission and reception 300/1200/2400/4800/7200/9600/12000/14400/16800/19200/21600/24000/26400/28800/31200/33600 bps Data reception only with V.90 28000/29333/30666/32000/33333/34666/36000/37333/38666/40000/41333/42666/44000/45333/46666/48000/49333/50666/52000/53333/54666/56000 bps Fax 2400/4800/7200/9600/12000/14400 bps
Transmitting level	-10 dBm
Receiving level	-10 to -40 dBm
Input/output impedance	600 ohms \pm 30%
Error correcting	MNP class 4 and ITU-T V.42
Data compression	MNP class 5 and ITU-T V.42bis
Power supply	+3.3V (supplied by computer)

Appendix B

Display Controller and Video mode

Display controller

The display controller interprets software commands into hardware commands that turn particular parts on the screen on or off.



Due to the display panel's increased resolution, lines may appear broken in when displaying images in full-screen text mode.

The display controller also controls the video mode and uses industry standard rules to govern the screen resolution and the maximum number of colors that can be displayed at any one time. Therefore, software written for a given video mode will run on any computer that supports that mode.

Video mode

Video mode settings are configured via the **Display Properties** dialog. To open the **Display Properties** dialog, click **Start -> Control Panel -> Appearance and Personalization -> Display**.



If you are running some applications (for example a 3D application or video playback and so on), you may see some disturbance, flickering or frame dropping on your screen.

If that occurs, adjust the resolution of display, lowering it until the screen is displayed properly.

Disabling Windows Aero™ may also help correct this issue.

Appendix C

Wireless LAN

This appendix is intended to help you get your Wireless LAN network up and running, with a minimum of parameters.

Card Specifications

Form Factor	PCI Express Mini Card
Compatibility	<ul style="list-style-type: none">■ IEEE 802.11 Standard for Wireless LANs■ Wi-Fi (Wireless Fidelity) certified by the Wi-Fi Alliance. The 'Wi-Fi CERTIFIED' logo is a certification mark of the Wi-Fi Alliance.
Network Operating System	<ul style="list-style-type: none">■ Microsoft Windows Networking
Media Access Protocol	<ul style="list-style-type: none">■ CSMA/CA (Collision Avoidance) with Acknowledgment (ACK)

Radio Characteristics

Radio Characteristics of Wireless LAN module may vary according to:

- Country/region where the product was purchased
- Type of product

Wireless communication is often subject to local radio regulations. Although Wireless LAN wireless networking products have been designed for operation in the license-free 2.4GHz and 5GHz band, local radio regulations may impose a number of limitations to the use of wireless communication equipment.



Refer to the "Information sheet" for regulatory information that may apply in your country/region.

Radio Frequency

- Band 5GHz (5150-5850 MHz) (Revision a and n draft 2.0)
- Band 2.4GHz (2400-2483.5 MHz) (Revision b/g and n draft 2.0)

The range of the wireless signal is related to the transmit rate of the wireless communication. Communications at lower transmit range may travel larger distances.

- The range of your wireless devices can be affected when the antennas are placed near metal surfaces and solid high-density materials.
- Range is also impacted due to "obstacles" in the signal path of the radio that may either absorb or reflect the radio signal.

Supported Frequency Sub-bands

Subject to the radio regulations that apply in the countries/regions, your Wireless LAN module may support a different set of 5 GHz/2.4 GHz channels. Consult your Authorized Wireless LAN or TOSHIBA Sales office for information about the radio regulations that apply in the countries/regions.

2.4GHz Band Channels Sets (Wireless IEEE 802.11 Revision b, g and n draft 2.0)

Frequency Range Channel ID	2400-2483.5 MHz
1	2412
2	2417
3	2422
4	2427
5	2432
6	2437
7	2442
8	2447
9	2452
10	2457*1
11	2462
12	2467*2
13	2472*2

*1 Factory-set default channels

*2 The band width and the channel which can be used depends on the installed wireless LAN module. And the approved channels on using are different at each country or region. When using these channels in any country or region, refer to the addendum sheet which is *Approved Countries/Regions for use*. The channel configuration is managed as follows:

- For wireless clients that operate in a Wireless LAN Infrastructure, the Wireless LAN module will automatically start operation at the channel identified by the Wireless LAN Access Point. When roaming between different access points the station can dynamically switch to another channel if required.

- For Wireless LAN modules installed in wireless clients that operating in a peer-to-peer mode, the module will use the default channel 10.
- In a Wireless LAN Access Point, the Wireless LAN module will use the factory-set default channel (printed in bold), unless the LAN Administrator selected a different channel when configuring the Wireless LAN Access Point device.

5GHz Band Channels Sets (Wireless IEEE 802.11 Revision a and draft 2.0)

Frequency Range Channel ID	5150-5850 MHz
34	5170 *2
36	5180 *2
38	5190 *2
40	5200 *2
42	5210 *2
44	5220 *2
46	5230 *2
48	5240 *2
52	5260 *2
56	5280 *2
60	5300 *2
64	5320 *2
100	5500 *2
104	5520 *2
108	5540 *2
112	5560 *2
116	5580 *2
120	5600 *2
124	5620 *2
128	5640 *2
132	5660 *2
136	5680 *2
140	5700 *2
149	5745 *2

153	5765 *2
157	5785 *2
161	5805 *2
165	5825 *2

*1 Factory-set default channels

*2 The channel which can be used depends on the installed wireless LAN module. And the approved channels on using are different at each country or region. When using these channels in any country or region, refer to the addendum sheet which is *Approved Countries/Regions for use*. The channel configuration is managed as follows:

- For wireless clients that operate in a Wireless LAN Infrastructure, the Wireless LAN module will automatically start operation at the channel identified by the Wireless LAN Access Point. When roaming between different access points the station can dynamically switch to another channel if required.
- For Wireless LAN modules installed in wireless clients that operating in a peer-to-peer mode, the module will use the default channel 10.
- In a Wireless LAN Access Point, the Wireless LAN module will use the factory-set default channel (printed in bold), unless the LAN Administrator selected a different channel when configuring the Wireless LAN Access Point device.

Appendix D

Bluetooth wireless technology Interoperability

Bluetooth Adaptor from TOSHIBA are designed to be interoperable with any product with Bluetooth wireless technology that is based on Frequency Hopping Spread Spectrum (FHSS) radio technology, and is compliant to:

- Bluetooth Specification Ver. 2.1+EDR, as defined and approved by The Bluetooth Special Interest Group.
- Logo certification with Bluetooth wireless technology as defined by The Bluetooth Special interest Group.



- *When you use Bluetooth Adaptor from TOSHIBA close to 2.4 GHz Wireless LAN devices, Bluetooth transmissions might slow down or cause errors. If you detect certain interference while you use Bluetooth Adaptor from TOSHIBA, always change the frequency, move your computer to the area outside of the interference range of 2.4 GHz Wireless LAN devices (40 meters/43.74 yards or more) or stop transmitting from your computer. Please visit the following TOSHIBA PC product support website.*
- *Bluetooth and Wireless LAN devices operate within the same radio frequency range and may interfere with one another. If you use Bluetooth and Wireless LAN devices simultaneously, you may occasionally experience a less than optimal network performance or even lose your network connection. If you should experience any such problem, immediately turn off either one of your Bluetooth or Wireless LAN. Please visit the following TOSHIBA PC product support website.*

TOSHIBA PC product support website.

In Europe visit

<http://www.toshiba-europe.com/computers/tnt/bluetooth.htm>

In the United States visit

<http://www.pc.support.global.toshiba.com>

Bluetooth wireless technology and your Health

The products with Bluetooth wireless technology, like other radio devices, emit radio frequency electromagnetic energy. The level of energy emitted by devices with Bluetooth wireless technology however is far much less than the electromagnetic energy emitted by wireless devices like for example mobile phones.

Because products with Bluetooth wireless technology operate within the guidelines found in radio frequency safety standards and recommendations, TOSHIBA believes Bluetooth wireless technology is safe for use by consumers. These standards and recommendations reflect the consensus of the scientific community and result from deliberations of panels and committees of scientists who continually review and interpret the extensive research literature.

In some situations or environments, the use of Bluetooth wireless technology may be restricted by the proprietor of the building or responsible representatives of the organization. These situations may for example include:

- Using the equipment with Bluetooth wireless technology on board of airplanes, or
- In any other environment where the risk of interference to other devices or services is perceived or identified as harmful.

If you are uncertain of the policy that applies on the use of wireless devices in a specific organization or environment (e.g. airports), you are encouraged to ask for authorization to use the device with Bluetooth wireless technology prior to turning on the equipment.

Regulatory statements

General

This product complies with any mandatory product specification in any country/region where the product is sold. In addition, the product complies with the following.

European Union (EU) and EFTA

This equipment complies with the R&TTE directive 1999/5/EC and has been provided with the CE mark accordingly.

Canada - Industry Canada (IC)

This device complies with RSS 210 of Industry Canada.

Operation is subject to the following two conditions: (1) this device may not cause interference, and (2) this device must accept any interference, including interference that may cause undesired operation of this device.

The term "IC" before the equipment certification number only signifies that the Industry Canada technical specifications were met.

USA-Federal Communications Commission (FCC)

This equipment has been tested and found to comply with the limits for a Class B digital device, pursuant to Part 15 of FCC Rules. These limits are designed to provide reasonable protection against harmful interference in a residential installation. This equipment generates, uses, and can radiate radio frequency energy. If not installed and used in accordance with the instructions, it may cause harmful interference to radio communications. However, there is no guarantee that interference will not occur in a particular installation.

If this equipment does cause harmful interference to radio or television reception, which can be determined by tuning the equipment off and on, the user is encouraged to try and correct the interference by one or more of the following measures:

- Reorient or relocate the receiving antenna
- Increase the distance between the equipment and the receiver.
- Connect the equipment to outlet on a circuit different from that to which the receiver is connected.
- Consult the dealer or an experienced radio/TV technician for help.

TOSHIBA is not responsible for any radio or television interference caused by unauthorized modification of the devices included with this Bluetooth Adaptor from TOSHIBA, or the substitution or attachment of connecting cables and equipment other than specified by TOSHIBA.

The correction of interference caused by such unauthorized modification, substitution or attachment will be the responsibility of the user.

Caution: Exposure to Radio Frequency Radiation

The radiated output power of the Bluetooth Adaptor from TOSHIBA is far below the FCC radio frequency exposure limits. Nevertheless, the Bluetooth Adaptor from TOSHIBA shall be used in such a manner that the potential for human contact during normal operation is minimized.

The installer of this radio equipment must ensure that the antenna is located or pointed such that it does not emit RF field in excess of Health Canada limits for the general population; consult Safety Code 6, obtainable from Health Canada's website www.hc-sc.gc.ca/rpb.

Taiwan

- Article 12 Without permission granted by the DGT or NCC, any company, enterprise, or user is not allowed to change frequency, enhance transmitting power or alter original characteristic as well as performance to an approved low power radio-frequency devices.
- Article 14 The low power radio-frequency devices shall not influence aircraft security and interfere legal communications; If found, the user shall cease operating immediately until no interference is achieved.
- The said legal communications means radio communications is operated in compliance with the Telecommunications Act.
- The low power radio-frequency devices must be susceptible with the interference from legal communications or ISM radio wave radiated devices.

Using Bluetooth Adaptor from TOSHIBA equipment in Japan

In Japan, the frequency bandwidth of 2,400 - 2,483.5 MHz for second generation low-power data communication systems such as this equipment overlaps that of mobile object identification systems (premises radio station and specified low-power radio station).

1. Sticker

Please put the following sticker on computer incorporating this product.

The frequency bandwidth of this equipment may operate within the same range as industrial devices, scientific devices, medical devices, microwave ovens, licensed radio stations and non-licensed specified low-power radio stations for mobile object identification systems (RFID) used in factory production lines (Other Radio Stations).

1. Before using this equipment, ensure that it does not interfere with any of the equipment listed above.
2. If this equipment causes RF interference to other radio stations, promptly change the frequency being used, change the location of use, or turn off the source of emissions.
3. Contact TOSHIBA Direct PC if you have problems with interference caused by this product to Other Radio Stations.

2. Indication

The indication shown below appears on this equipment.

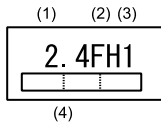

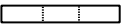
- (1) 2.4 : This equipment uses a frequency of 2.4 GHz.
 (2) FH : This equipment uses FH-SS modulation.
 (3) 1: The interference range of this equipment is less than 10 m.
 (4)  This equipment uses a frequency bandwidth from 2,400 MHz to 2,483.5 MHz.
 It is impossible to avoid the band of mobile object identification systems.

3. TOSHIBA Direct PC

Monday - Friday : 10:00-17:00
 Toll Free Tel : 0120-15-1048
 Direct Dial : 03-3457-4850
 FAX : 03-3457-4868

Device Authorization

This device obtains the Technical Conditions Compliance Approval, and it belongs to the device class of radio equipment of low-power data communication system radio station stipulated in the Telecommunications Business Law.

The Name of the radio equipment: EYTFXCS

JAPAN APPROVALS INSTITUTE FOR TELECOMMUNICATIONS
 EQUIPMENT

Approval Number: D07-0040001

The following restrictions apply:

Do not disassemble or modify the device.

Do not install the embedded wireless module into other device.

Appendix E

AC Power Cord and Connectors

The power cord's AC input plug must be compatible with the various international AC power outlets and the cord must meet the standards for the country/region in which it is used. All cords must meet the following specifications:

Length:	Minimum 1.7 meters
Wire size:	Minimum 0.75 mm ²
Current rating:	Minimum 2.5 amperes
Voltage rating:	125 or 250 VAC (depending on country/region's power standards)

Certification agencies

U.S. and Canada:	UL listed and CSA certified No. 18 AWG, Type SVT or SPT-2		
Australia:	AS		
Japan:	DENANHO		
<i>Europe:</i>			
Austria:	OVE	Italy:	IMQ
Belgium:	CEBEC	The Netherlands:	KEMA
Denmark:	DEMKO	Norway:	NEMKO

Finland:	FIMKO	Sweden:	SEMKO
France:	LCIE	Switzerland:	SEV
Germany:	VDE	United Kingdom:	BSI

In Europe, two conductors power cord must be VDE type, H05VVH2-F or H03VVH2-F and for three conductors power cord must be VDE type, H05VV-F.

For the United States and Canada, two pin plug configuration must be a 2-15P (250V) or 1-15P (125V) and three pin plug configuration must be 6-15P (250V) or 5-15P (125V) as designated in the U.S. National Electrical code handbook and the Canadian Electrical Code Part II.

The following illustrations show the plug shapes for the U.S.A. and Canada, the United Kingdom, Australia and Europe.

USA

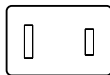

UL approved

Australia

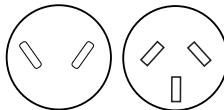

AS approved

Canada

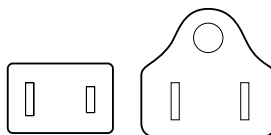

CSA approved

United Kingdom

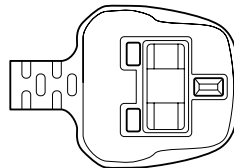

BS approved

Europe

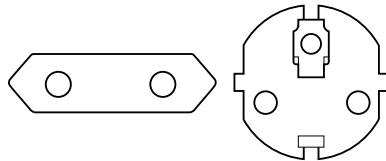

Approved by the appropriate agency

Appendix F

TOSHIBA Anti-theft Protection Timer

This feature allows you to set up a timer-activated BIOS password that will prevent unauthorised system access in the event of theft.

When the time limit is exceeded, you are required to provide the Password or fingerprint authentication for the BIOS and Hard Disk Drive to gain access to the system.

To set permissions and limits for the TOSHIBA Anti-theft Protection Timer please use the TOSHIBA Password Utility.

The settings can only be activated or modified by a user with supervisor authority. If the supervisor password is not set, click on the **Set** button in **Supervisor Password** from the supervisor tab in TOSHIBA Password Utility and set the password on the dialog screen that appears.

Then, click on the **Set** button in TOSHIBA Anti-theft Protection Timer.

Take the following action if the set limit is exceeded.

- If the Supervisor Password is registered but the User Password is not, enter the Supervisor Password to boot the computer.
- If both the Supervisor Password and the User Password are registered, enter either the Supervisor Password, the User Password or the fingerprint authentication to boot the computer.



- *The limit counts the number of days from the last time Windows is logged on till the next time the computer is booted up. The range can be set from 1 to 28 days.*
- *Authentication is required if the computer's clock is significantly modified.*
- *If the Supervisor Password is deleted, this function becomes disabled.*

Appendix G

TOSHIBA PC Health Monitor

The TOSHIBA PC Health Monitor application proactively monitors a number of system functions such as power consumption, battery health and the system cooling, informing you of significant system conditions. This application recognizes the system and individual component serial numbers, and will track specific activities related to the computer and their usage.

The collected information includes device operation time and number of actuations or status changes (i.e.: number of power button and **FN** key combination uses, AC adaptor, battery, LCD, fan, HDD, sound volume, wireless communication switch, TOSHIBA Express Port Replicator and USB information), date of initial system use, and also computer and device usage (i.e.: power settings, battery temperature and recharging, CPU, memory, backlight illumination time, and temperatures for various devices). The stored data uses a very small portion of the total hard disk capacity, approximately 3MB or less per year.

This information is used to identify and provide a notification of system conditions which may effect the performance of your Toshiba computer. It may also be used to help diagnose problems should the computer require service by Toshiba or Toshiba's authorized service providers. Additionally, Toshiba may also use this information for quality assurance analysis.

Subject to the use restrictions above, the HDD data logged may be transferred to entities located outside of your country or region of residence (e.g., European Union). Those countries may or may not have the same data protection laws or data protection levels as required by your home country or region.

Once enabled, you may disable the TOSHIBA PC Health Monitor at any time by uninstalling the software via **Uninstall a program** in the **Control Panel**. Doing so will automatically delete all collected information from the HDD.

The TOSHIBA PC Health Monitor software does not extend or modify Toshiba's obligations under its standard limited warranty in any way. Toshiba's standard limited warranty terms and limitations apply.

Starting the TOSHIBA PC Health Monitor

The TOSHIBA PC Health Monitor can be started using the following methods:

- Click **Start -> All Programs -> TOSHIBA -> Utilities -> PC Health Monitor**.
- Click the icon () in the notification area, then click the "**Enable PC Health Monitor...**" message the first time you run the application and "**Run PC Health Monitor...**" every time thereafter.

No matter which method is used, the TOSHIBA PC Health Monitor explanation screen will be displayed.

Clicking **Next** will display the **PC Health Monitor Software Notice & Acceptance** screen. Please carefully read the information displayed. Selecting **ACCEPT** and clicking **OK** will enable the program. By enabling the TOSHIBA PC Health Monitor software, you agree with these terms and conditions and to the use and sharing of the collected information. Once the program is enabled, the TOSHIBA PC Health Monitor screen is displayed, and the program will begin monitoring system functions and collecting information.

If a TOSHIBA PC Health Monitor message is displayed.

A message will be displayed if any changes which may interfere with the operation of the program are detected. Follow the instructions displayed on screen in the message. However, if the following special message is displayed, carry out the procedures listed below.

If the "It is possible that the PC cooling performance has decreased. Please click [OK] to run the TOSHIBA Cooling Performance Diagnostic Tool to check the cooling performance of your PC." message is displayed.

1. Click **"OK"** to start the "TOSHIBA Cooling Performance Diagnostic Tool".
2. If the "It is possible that the PC cooling performance has decreased. Please clean the cooling module according to the instructions in your PC User's Guide." message is displayed after running the "TOSHIBA Cooling Performance Diagnostic Tool", the cooling module requires cleaning. Refer to the [Cleaning the cooling module](#) section, in this chapter.

3. After cleaning the cooling module, run the "TOSHIBA Cooling Performance Diagnostic Tool" again.
Click **Start -> All Programs -> TOSHIBA -> Utilities -> TOSHIBA Cooling Performance Diagnostic Tool**.
4. If the "Please click [OK] to run the TOSHIBA Cooling Performance Diagnostic Tool to check the cooling performance of your PC." message is still displayed after running the "TOSHIBA Cooling Performance Diagnostic Tool" in step 3, it is recommended you turn off the computer and contact TOSHIBA support.

Cleaning the cooling module

This section explains how to clean the cooling module.



If you use the computer for a long period, the inside of the computer may become hot. Always allow the computer to cool to room temperature before you clean the cooling module.

To clean the cooling module, follow the steps detailed below:

1. Shut down the computer - make sure the **Power** indicator is off (refer to the [Turning off the power](#) section in Chapter 1, Getting Started if required).
2. Remove the AC adaptor and all cables and peripherals connected to the computer.
3. Close the display panel and turn the computer upside down.
4. Remove the battery pack (refer to the [Replacing the battery pack](#) section in Chapter 6, Power and Power-Up Modes, if required).
5. Using a thin-tipped tool, push on the hole in the edge of the Cooling module cover and slide it in the direction of the arrow to remove.

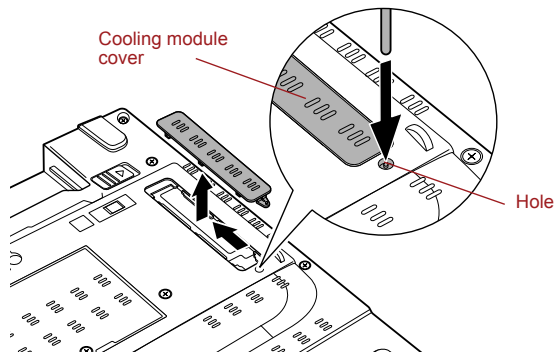

Figure G-1 Removing the cooling module cover

6. Lift the plastic film and clean the cooling module using a vacuum cleaner or other cleaning tool.



Do not use a ball pen, cotton swap or similar to remove dust. If these touch the inside of the computer, it could be damaged or become clogged, leading to further problems.

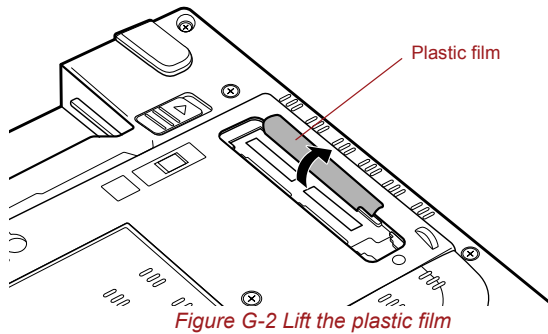

Figure G-2 Lift the plastic film

7. Slide the Cooling module cover back into place on the computer to reattach.
8. Install the battery pack (refer to the [Replacing the battery pack](#) section in Chapter 6, Power and Power-Up Modes, if required).
9. Turn your computer over.

Appendix H

Legal Footnotes

This chapter states the Legal Footnotes information applicable to TOSHIBA computers. In the text in this manual, *XX is used to show which Legal Footnotes description is related to TOSHIBA computers.

Description(s) related to this computer are marked with a blue *XX in this manual. Clicking on *XX will display the related description.

Non-applicable Icons*1

Certain computer chassis are designed to accommodate all possible configurations for an entire product series. Therefore, please be aware that your selected model may not have all the features and specifications corresponding to all of the icons or switches shown on the computer chassis.

CPU*2

Central Processing Unit ("CPU") Performance Legal Footnotes.

CPU performance in your computer product may vary from specifications under the following conditions:

- use of certain external peripheral products
- use of battery power instead of AC power
- use of certain multimedia, computer generated graphics or video applications
- use of standard telephone lines or low speed network connections
- use of complex modeling software, such as high end computer aided design applications
- use of several applications or functionalities simultaneously
- use of computer in areas with low air pressure (high altitude >1,000 meters or >3,280 feet above sea level)

- use of computer at temperatures outside the range of 5°C to 30°C (41°F to 86°F) or >25°C (77°F) at high altitude (all temperature references are approximate and may vary depending on the specific computer model - please refer to your computer documentation or visit the Toshiba website at www.pcsupport.toshiba.com for details).

CPU performance may also vary from specifications due to design configuration.

Under some conditions, your computer product may automatically shut-down. This is a normal protective feature designed to reduce the risk of lost data or damage to the product when used outside recommended conditions. To avoid risk of lost data, always make back-up copies of data by periodically storing it on an external storage medium. For optimum performance, use your computer product only under recommended conditions. Read additional restrictions in your product documentation. Contact Toshiba technical service and support, refer to [TOSHIBA support](#) section in Chapter 8 Troubleshooting for more information.

64-Bit Computing

64-bit processors are designed to take advantage of 32 and 64 bit computing.

64-bit computing requires that the following hardware and software requirements are met:

- 64-bit Operating System
- 64-bit CPU, Chipset and BIOS (Basic Input/Output System)
- 64-bit Device drivers
- 64-bit applications

Certain device drivers and/or applications may not be compatible with a 64-bit CPU and therefore may not function properly. A 32-bit version of the operating system is preinstalled on your computer unless explicitly stated that the operating system is 64-bit.

Memory (Main System)*3

Part of the main system memory may be used by the graphics system for graphics performance and therefore reduce the amount of main system memory available for other computing activities. The amount of main system memory allocated to support graphics may vary depending on the graphics system, applications utilized, system memory size and other factors. For computer's configured with 4 GB of system memory, the full system memory space for computing activities will be considerably less and will vary by model and system configuration.

Battery Life*4

Battery life may vary considerably depending on product model, configuration, applications, power management settings and features utilized, as well as the natural performance variations produced by the design of individual components. Published battery life numbers are achieved on select models and configurations tested by Toshiba at the time of publication. Recharge time varies depending on usage. Battery may not charge while computer is consuming full power.

After going through many charge and discharge cycles, the battery will lose its ability to perform at maximum capacity and will need to be replaced. This is a normal phenomenon for all batteries. To purchase a new battery pack, see the accessories information that is shipped with your computer.

Hard Disk Drive (HDD) Capacity*5

1 Gigabyte (GB) means $10^9 = 1,000,000,000$ bytes using powers of 10. The computer operating system, however, reports storage capacity using powers of 2 for the definition of $1 \text{ GB} = 2^{30} = 1,073,741,824$ bytes, and therefore shows less storage capacity. Available storage capacity will also be less if the product includes one or more pre-installed operating systems, such as Microsoft Operating System and/or pre-installed software applications, or media content. Actual formatted capacity may vary.

LCD*6

Over a period of time, and depending on the usage of the computer, the brightness of the LCD screen will deteriorate. This is an intrinsic characteristic of LCD technology.

Maximum brightness is only available when operating in AC power mode. Screen will dim when the computer is operated on battery power and you may not be able to increase the brightness of the screen.

Graphics Processor Unit ("GPU")*7

Graphics processor unit ("GPU") performance may vary depending on product model, design configuration, applications, power management settings and features utilized. GPU performance is only optimized when operating in AC power mode and may decrease considerably when operating in battery power mode.

Total Available Graphics Memory is the total of, as applicable, Dedicated Video Memory, System Video Memory and Shared System Memory. Shared System Memory will vary depending on system memory size and other factors.

Wireless LAN*8

The transmission speed over the wireless LAN and the distance over which wireless LAN can reach may vary depending on surrounding electromagnetic environment, obstacles, access point design and configuration, and client design and software/hardware configurations.

The actual transmission speed will be lower than the theoretical maximum speed.

The wireless adapter is based on a draft 2.0 release version of the IEEE 802.11n specification and; may not be full compatible with, or support some feature (e.g., security) of, certain Wi-Fi equipment.

Copy Protection*9

Applicable copy protection standards included in certain media may prevent or limit recording or viewing of the media.

Images*10

All images are simulated for purposes of illustration.

Glossary

The terms in this glossary cover topics related to this manual. Alternate naming is included for reference.

Abbreviations

AC: Alternating current

ACPI: Advanced Configuration and Power Interface

AMT: Intel Active Management Technology

ASCII: American Standard Code for Information Interchange

BIOS: basic input/output system

bps: bits per second

CD: compact disc

CD-ROM: Compact Disc Read-Only Memory

CD-RW: Compact Disc-ReWritable

CMOS: complementary metal-oxide semiconductor

CPU: central processing unit

CRT: cathode ray tube

DC: direct current

DDC: display data channel

DDR: double data rate

DIMM: dual inline memory module

DVD: digital versatile disc

DVD-R: Digital Versatile Disc-Recordable

DVD-RAM: Digital Versatile Disc-Random Access Memory

DVD-R (Dual Layer): Digital Versatile Disc Recordable Dual Layer

DVD-ROM: Digital Versatile Disc-Read Only Memory

DVD-RW: Digital Versatile Disc-ReWritable

DVD+R (Double Layer): Digital Versatile Disc Recordable Double Layer

eSATA: external Serial ATA

FDD: floppy diskette drive

FIR: fast infrared

GB: gigabyte

HDD: hard disk drive

IDE: integrated drive electronics

IEEE: Institute of Electrical and Electronics Engineers
IMSM: Intel Matrix Storage Manager
I/O: input/output
IRQ: interrupt request
KB: kilobyte
LAN: local area network
LCD: liquid crystal display
LED: light emitting diode
MB: megabyte
MMC: multi media card
OCR: optical character recognition (reader)
PC: personal computer
PCI: peripheral component interconnect
RAM: random access memory
RGB: red, green, and blue
ROM: read only memory
RTC: real time clock
S/P DIF: Sony/Philips Digital Interface Format
SDRAM: synchronous dynamic random access memory
SLI: Scalable Link Interface
SO-DIMM: small-outline dual in line memory module
SSD: Solid state drive
TFT: thin-film transistor
USB: Universal Serial Bus
UXGA: ultra extended graphics array
VGA: video graphics array
WAN: wide area network
WSXGA: wide super extended graphics array
WSXGA+: wide super extended graphics array plus
WUXGA: Wide Ultra Extended Graphics Array
WXGA: wide extended graphics array
WXGA+: wide extended graphics array plus
XGA: extended graphics array

A

AccuPoint: A pointing device integrated into the TOSHIBA computer keyboard.

- adaptor:** A device that provides a compatible connection between two units. For example, the computer's internal display adapter receives information from the software and translates it into images on the screen. An adapter can take a number of forms, from a microprocessor to a simple connector: An intelligent adapter (one that is capable of doing some processing) may also be called a controller.
- alphanumeric:** Keyboard characters including letters, numbers and other symbols, such as punctuation marks or mathematical symbols.
- alternating current (AC):** Electric current that reverses its direction of flow at regular intervals.
- analog signal:** A signal whose characteristics such as amplitude and frequency vary in proportion to (are an analog of) the value to be transmitted. Voice communications are analog signals.
- application:** A group of programs that together are used for a specific task such as accounting, financial planning, spreadsheets, word processing and games.
- ASCII:** American Standard Code for Information Interchange. ASCII code is a set of 256 binary codes that represent the most commonly used letters, numbers, and symbols.
- asynchronous:** Lacking regular time relationship. As applied to computer communications, asynchronous refers to the method of transmitting data that does not require a steady stream of bits to be transmitted at regular time intervals.

B

- backup:** A copy of a file, usually on a removable disk, kept in case the original file is lost or damaged.
- binary:** The base two number system composed of zeros and ones (off or on), used by most digital computers. The right-most digit of a binary number has a value of 1, the next a value of 2, then 4, 8, 16, and so on. For example, the binary number 101 has a value of 5. *See also* ASCII.
- BIOS:** Basic Input/Output System. The firmware that controls data flow within the computer. *See also* firmware.
- bit:** Derived from "binary digit," the basic unit of information used by the computer. It is either zero or one. Eight bits is one byte. *See also* byte.
- Bluetooth:** A short-range radio technology designed to simplify wireless communication among computers, communication devices and the Internet.
- board:** A circuit board. An internal card containing electronic components, called chips, which perform a specific function or increase the capabilities of the system.

- boot:** Short for bootstrap. A program that starts or restarts the computer. The program reads instructions from a storage device into the computer's memory.
- boot disk:** See system disk.
- bootable disk:** See system disk.
- bps:** Bits per second. Typically used to describe the data transmission speed of a modem.
- buffer:** The portion of the computer's memory where data is temporarily stored. Buffers often compensate for differences in the rate of flow from one device to another.
- bus:** An interface for transmission of signals, data or electric power.
- byte:** The representation of a single character. A sequence of eight bits treated as a single unit; also the smallest addressable unit within the system.

C

- cache memory:** A section of very fast memory in which frequently used information is duplicated for quick access. Accessing data from cache is faster than accessing it from the computer's main memory. See also L1 cache, L2 cache.
- capacity:** The amount of data that can be stored on a magnetic storage device such as a floppy diskette or hard disk drive. It is usually described in terms of kilobytes (KB), where one KB = 1024 bytes, megabytes (MB), where one MB = 1024 KB and gigabytes (GB), where one GB = 1024 MB.
- CardBus:** An industry standard bus for 32-bit PC Cards.
- CD:** An individual compact disc. See also CD-ROM.
- CD-R:** A Compact Disc-Recordable disc can be written once and read many times. See also CD-ROM.
- CD-ROM:** A Compact Disc Read-Only Memory is a high capacity disc that can be read from but not written to. The CD-ROM drive uses a laser, rather than magnetic heads, to read data from the disc.
- CD-RW:** A Compact Disc-ReWritable disc can be rewritten many times. See also CD-ROM.
- character:** Any letter, number, punctuation mark, or symbol used by the computer. Also synonymous with byte.
- chassis:** The frame containing the computer.
- chip:** A small semiconductor containing computer logic and circuitry for processing, memory, input/output functions and controlling other chips.
- click:** To press and release the pointing device's primary button without moving the pointing device. In the Windows operating system, this refers to the pointing device's left button, unless otherwise stated. See also double-click.

CMOS: Complementary Metal-Oxide Semiconductor. An electronic circuit fabricated on a silicon wafer that requires very little power. Integrated circuits implemented in CMOS technology can be tightly packaged and are highly reliable.

cold start: Starting a computer that is currently off (turning on the power).

COM1, COM2, COM3 and COM4: The names assigned to the serial and communication ports.

commands: Instructions you enter at the terminal keyboard that direct the actions of the computer or its peripheral devices.

compatibility: 1) The ability of one computer to accept and process data in the same manner as another computer without modifying the data or the media upon which it is being transferred.

2) the ability of one device to connect to or communicate with another system or component.

components: Elements or parts (of a system) which make up the whole (system).

computer program: A set of instructions written for a computer that enable it to achieve a desired result.

computer system: A combination of hardware, software, firmware, and peripheral components assembled to process data into useful information.

configuration: The specific components in your system (such as the terminal, printer, and disk drives) and the settings that define how your system works. You use the HW Setup program to control your system configuration.

controller: Built-in hardware and software that controls the functions of a specific internal or peripheral device (e.g. keyboard controller).

CPU: Central Processing Unit. The portion of the computer that interprets and executes instructions.

CRT: Cathode Ray Tube. A vacuum tube in which beams projected on a fluorescent screen-producing luminous spots. An example is the television set.

cursor: A small, blinking rectangle or line that indicates the current position on the display screen.

D

data: Information that is factual, measurable or statistical that a computer can process, store, or retrieve.

data bits: A data communications parameter controlling the number of bits (binary digits) used to make up a byte. If data bits = 7 the computer can generate 128 unique characters. If data bits = 8 the computer can generate 256 unique characters.

DC: Direct Current. Electric current that flows in one direction. This type of power is usually supplied by batteries.

- default:** The parameter value automatically selected by the system when you or the program do not provide instructions. Also called a preset value.
- delete:** To remove data from a disk or other data storage device. Synonymous with erase.
- device driver:** A program (called a "driver") that permits a computer to communicate with a device.
- dialog box:** A window that accepts user input to make system settings or record other information.
- disable:** To turn a computer option off. See also enable.
- disk drive:** The device that randomly accesses information on a disk and copies it to the computer's memory. It also writes data from memory to the disk. To accomplish these tasks, the unit physically rotates the disk at high speed past a read-write head.
- disk storage:** Storing data on magnetic disk. Data is arranged on concentric tracks much like a phonograph record.
- display:** A CRT, LCD, or other image producing device used to view computer output.
- documentation:** The set of manuals and/or other instructions written for the users of a computer system or application. Computer system documentation typically includes procedural and tutorial information as well as system functions.
- double click:** To press and release the pointing device's primary button rapidly twice without moving the pointing device. In the Windows operating system, this refers to the pointing device's left button, unless otherwise stated.
- driver:** A software program, generally part of the operating system, that controls a specific piece of hardware (frequently a peripheral device such as a printer or mouse).
- DVD:** An individual digital versatile (or video) disc. See also DVD-ROM.
- DVD-R (+R, -R):** A Digital Versatile Disc-Recordable disk can be written once and read many times. The DVD-R drive uses a laser to read data from the disc.
- DVD-RAM:** A Digital Versatile Disc-Random Access Memory is a high-capacity, high performance disc that lets you store large volumes of data. The DVD-ROM drive uses a laser to read data from the disc.
- DVD-ROM:** A Digital Versatile Disc-Read Only Memory is a high capacity, high performance disc suitable for play back of video and other high-density files. The DVD-ROM drive uses a laser to read data from the disc.
- DVD-RW (+RW, -RW):** A Digital Versatile Disc-ReWritable disc can be rewritten many times.

E

echo: To send back a reflection of the transmitted data to the sending device. You can display the information on the screen, or output it to the printer, or both. When a computer receives back data it transmitted to a CRT (or other peripheral device) and then transmits the data to printer, the printer is said to echo the CRT.

enable: To turn on a computer option. See also disable.

erase: See delete.

escape: 1) A code (ASCII code 27), signaling the computer that what follows are commands; used with peripheral devices such as printers and modems.

2) A means of aborting the task currently in progress.

escape guard time: A time before and after an escape code is sent to the modem which distinguishes between escapes that are part of the transmitted data, and escapes that are intended as a command to the modem.

execute: To interpret and execute an instruction.

F

fast infrared: An industry standard that enables cableless infrared serial data transfer at speeds of up to 4 Mbps.

file: A collection of related information; a file can contain data, programs, or both.

fingerprint sensor: The fingerprint sensor compares and analyzes the unique characteristics in a fingerprint.

firmware: A set of instructions built into the hardware which controls and directs a microprocessor's activities.

flash memory: Non-volatile memory that can be written to as well as read. Information in flash memory remains whether or not the computer is receiving power. This type of memory is used to retain your fingerprint data. See also memory. Compare RAM and ROM.

floppy diskette: A removable disk that stores magnetically encoded data.

floppy diskette drive (FDD): An electromechanical device that reads and writes to floppy diskettes.

folder: An icon in Windows used to store documents or other folders.

format: The process of readying a blank disk for its first use. Formatting establishes the structure of the disk that the operating system expects before it writes files or programs onto the disk.

function keys: The keys labeled **F1** through **F12** that tell the computer to perform certain functions.

G

gigabyte (GB): A unit of data storage equal to 1024 megabytes. *See also* megabyte.

graphics: Drawings, pictures, or other images, such as charts or graphs, to present information.

H

hard disk: A storage device composed of a rigid platter or platters that can be magnetically coded with data. Hard disks hold much more information than diskettes and are used for long-term storage of programs and data. The primary (or only) hard disk in a computer is usually fixed, but some computers have secondary hard disks that are removable. By default, the hard disk is referred to as drive C.

hard disk drive (HDD): An electromechanical device that reads and writes a hard disk. *See also* hard disk.

hardware: The physical electronic and mechanical components of a computer system: typically, the computer itself, external disk drives, etc. *See also* software and firmware.

hertz: A unit of wave frequency that equals one cycle per second.

host computer: The computer that controls, regulates, and transmits information to a device or another computer.

hot key: The computer's feature in which certain keys in combination with the extended function key, **FN**, can be used to set system parameters, such as speaker volume.

HW Setup: A TOSHIBA utility that lets you set the parameters for various hardware components.

I

icon: A small graphic image displayed on the screen or in the indicator panel. In Windows, an icon represents an object that the user can manipulate.

i.LINK (IEEE1394): This port enables high-speed data transfer directly from external devices such as digital video cameras.

input: The data or instructions you provide to a computer, communication device or other peripheral device from the keyboard or external or internal storage devices. The data sent (or output) by the sending computer is input for the receiving computer.

instruction: Statements or commands that specify how to perform a particular task.

interface: 1) Hardware and/or software components of a system used specifically to connect one system or device to another.
2) To physically connect one system or device to another to exchange information.
3) The point of contact between user, the computer, and the program, for example, the keyboard or a menu.

interrupt request: A signal that gives a component access to the processor.

I/O: Input/output. Refers to acceptance and transfer of data to and from a computer.

I/O devices: Equipment used to communicate with the computer and transfer data to and from it.

K

K: Taken from the Greek word kilo, meaning 1000; often used as equivalent to 1024, or 2 raised to the 10th power. *See also* byte and kilobyte.

keyboard: An input device containing switches that are activated by manually pressing marked keys. Each keystroke activates a switch that transmits a specific code to the computer. For each key, the transmitted code is, in turn, representative of the (ASCII) character marked on the key.

kilobyte (KB): A unit of data storage equal to 1024 bytes. *See also* byte and megabyte.

L

L1 cache: Level one cache. Memory cache built into the processor to help improve processing speed. *See also* cache memory, L2 cache.

L2 cache: Memory cache installed on the motherboard to help improve processing speed. It is slower than L1 cache and faster than main memory. *See also* cache memory, L1 cache.

LAN: A group of computers or other devices dispersed over a relatively limited area and connected by a communications link that enables any device to interact with any other on the network.

Light Emitting Diode (LED): A semiconductor device that emits light when a current is applied.

Liquid Crystal Display (LCD): Liquid crystal sealed between two sheets of glass coated with transparent conducting material. The viewing-side coating is etched into character forming segments with leads that extend to the edge of the glass. Applying a voltage between the glass sheets alters the brightness of the liquid crystal.

M

main board: *See* motherboard.

- megabyte (MB):** A unit of data storage equal to 1024 kilobytes. *See also* kilobyte.
- megahertz:** A unit of wave frequency that equals 1 million cycles per second. *See also* hertz.
- memory:** Typically refers to the computer's main memory, where programs are run and data is temporarily stored and processed. Memory can be volatile and hold data temporarily, such as RAM, or it can be nonvolatile and hold data permanently, such as ROM. A computer's main memory is RAM. *See* RAM, ROM.
- menu:** A software interface that displays a list of options on the screen. Also called a screen.
- microprocessor:** A hardware component contained in a single integrated circuit that carries out instructions. Also called the central processing unit (CPU), one of the main parts of the computer.
- mode:** A method of operation, for example, the Shut Down Mode, Sleep Mode or the Hibernation Mode.
- modem:** Derived from modulator/demodulator, a device that converts (modulates) digital data for transmission over telephone lines and then converts modulated data (demodulates) to digital format where received.
- monitor:** A device that uses rows and columns of pixels to display alphanumeric characters or graphic images. *See also* CRT.
- motherboard:** A name sometimes used to refer to the main printed circuit board in processing equipment. It usually contains integrated circuits that perform the processor's basic functions and provides connectors for adding other boards that perform special functions.
- MP3:** An audio compression standard that enables high-quality transmission and real-time playback of sound files.

N

- network:** A collection of computers and associated devices that are connected by communications facilities. A network allows you to share data and peripheral devices, such as printers, with other users and to exchange electronic mail.
- non-system disk:** A disk for storing programs and data that cannot be used to start the computer. Compare system disk.
- nonvolatile memory:** Memory that is capable of permanently storing information. Turning the computer's power off does not alter data stored in nonvolatile memory.
- numeric keypad overlay:** A feature that allows you to use certain keys on the keyboard to perform numeric entry, or to control cursor and page movement.

O

OCR: Optical Character Recognition (reader). A technique or device that uses laser or visible light to identify characters and input them into a storage device.

online state: A functional state of a peripheral device when it is ready to receive or transmit data.

operating system: A group of programs that controls the basic operation of a computer. Operating system functions include interpreting programs, creating data files, and controlling the transmission and receipt (input/output) of data to and from memory and peripheral device.

output: The results of a computer operation. Output commonly indicates data.

1) printed on paper, 2) displayed at a terminal, 3) sent through the serial port of internal modem, or 4) stored on some magnetic media.

P

parallel: Processes that occur simultaneously. In communications, it means the transmission of more than one bit of information at a time. On your computer, the parallel port provides a parallel communications interface between the computer and an appropriate device. Compare serial.

parity: 1) The symmetrical relationship between two parameter values (integers) both of which are either on or off; odd or even; 0 or 1.
2) In serial communications, an error detection bit that is added to a group of data bits making the sum of the bits even or odd. Parity can be set to none, odd, or even.

password: A unique string of characters used to identify a specific user. The computer provides various levels of password protection such as user and supervisor.

PC card: A credit-card-sized expansion card designed to increase the capabilities of notebook computers. PC Cards provide functions such as modem, fax/modem, hard disk drive, network adapter, sound card, or SCSI adapter.

PCI: Peripheral Component Interconnect. An industry standard 32-bit bus.

peripheral: Any device, such as a printer or joystick, that is attached to the computer and controlled by the computer's CPU.

pixel: A picture element. The smallest dot that can be made on a display or printer. Also called a pel.

plug and play: A capability with Windows that enables the system to automatically recognize connections of external devices and make the necessary configurations in the computer.

pointing device: Any device, such as the Touch Pad or a mouse, that enables you to move the cursor on the screen.

port: The electrical connection through which the computer sends and receives data to and from devices or other computers.

Power Saver: A TOSHIBA utility that lets you set the parameters for various power-saving functions.

program: A set of instructions a computer can execute that enables it to achieve a desired result. *See also* application.

prompt: A message the computer provides indicating it is ready for or requires information or an action from you.

R

Radio frequency interference (RFI) shield: A metal shield enclosing the printed circuit boards of the printer or computer to prevent radio and TV interference. All computer equipment generates radio frequency signals. The FCC regulates the amount of signals a computing device can allow past its shielding. A Class A device is sufficient for office use. Class B provides a more stringent classification for home equipment use. TOSHIBA portable computers comply with Class B computing device regulations.

Random Access Memory (RAM): Volatile memory that can be written to as well as read. Volatile here means that information in RAM is lost when you turn off your computer. This type of memory is used for your computer's main memory. *See also* memory. Compare ROM.

resolution: A measure of the sharpness of the images that can be produced by a printer or displayed on a screen. For a printer, resolution is expressed in dots per inch (dpi). For a screen, it is expressed as the number of pixels available horizontally and vertically.

restart: Resetting a computer without turning it off (also called "warm boot", "soft reset" or "reboot"). *See also* boot.

RGB: Red, green, and blue. A device that uses three input signals, each activating an electron gun for a primary additive color (red, green, and blue) or port for using such a device. *See also* CRT.

RJ45: A modular LAN jack.

Read Only Memory (ROM): Non-volatile memory that can be read but not written to. Non-volatile here means that information in ROM remains whether or not the computer is receiving power. This type of memory is used to store your computer's BIOS, which is essential instructions the computer reads when you start it up. *See also* BIOS, memory. Compare RAM.

S

S/P DIF: A standard of digital interface for audio.

SCSI: Small Computer System Interface is an industry standard interface for connection of a variety of peripheral devices.

- SD/SDHC Card:** Secure Digital cards are flash memory widely used in a variety of digital devices such as digital cameras and Personal Digital Assistants.
- serial:** Processes that occur one at a time. In communications, it means the transmission of one bit at a time sequentially over a single channel. On your computer, the serial port provides a serial interface between the computer and an appropriate device. Compare parallel.
- SIO:** Serial Input/Output. The electronic methodology used in serial data transmission.
- soft key:** Key combinations that emulate keys on the IBM keyboard, change some configuration options, stop program execution, and access the numeric keypad overlay.
- software:** The set of programs, procedures and related documentation associated with a computer system. Specifically refers to computer programs that direct and control the computer system's activities. See *also* hardware.
- stop bit:** One or more bits of a byte that follow the transmitted character or group codes in asynchronous serial communications.
- synchronous:** Having a constant time interval between successive bits, characters or events.
- system disk:** A diskette that contains the operating system files needed to start the computer. Any diskette can be formatted as a system disk. A system disk is also called a "bootable disk", "boot disk" or a "startup disk." Compare non-system disk.

T

- terminal:** A typewriter-like keyboard and CRT display screen connected to the computer for data input/output.
- TFT display:** A liquid crystal display (LCD) made from an array of liquid crystal cells using active-matrix technology with thin film transistor (TFT) to drive each cell.
- Touch Pad:** A pointing device integrated into the TOSHIBA computer palm rest.

U

- USB:** Universal Serial Bus. This serial interface lets you communicate with several devices connected in a chain to a single port on the computer.

V

- VGA:** Video Graphics Array is an industry standard video adaptor that lets you run any popular software.

volatile memory: Random access memory (RAM) that stores information as long as power is supplied to the computer.

W

warm start: Restarting or resetting a computer without turning it off.

Wi-Fi: A registered trademark term of the Wi-Fi Alliance that stands for Wireless Fidelity, and is another term for the communication protocol to permit an Ethernet connection using wireless communication components.

window: A portion of the screen that can display its own application, document or dialog box. Often used to mean a Microsoft Windows window.

Wireless LAN: Local Area Network (LAN) through wireless communication.

Wireless WAN: Wide Area Network (WAN) through wireless communication.

write protection: A method for protecting a floppy diskette from accidental erasure.

Index

A

- AC adaptor 3-3
 - DC IN 15V jack 2-6
 - additional 3-39
 - connecting 1-4
- ASCII characters 5-7

B

- Battery
 - charging 6-5
 - extending life 6-7
 - indicator 2-12, 6-2
 - monitoring capacity 6-6
 - real time clock 3-3, 6-4
 - save mode 3-8
 - types 6-3
- Battery pack 2-8, 3-2
 - additional 6-1
 - replacing 6-8
- Bluetooth 3-6, 4-35
 - Bluetooth Stack for Windows by Toshiba 3-12
 - problems 8-27
- Boot Priority 7-3
- Bridge media slot 2-4, 3-22
 - indicator 2-12
 - using 3-22

C

- Cleaning the computer 4-39
- Cooling vents 2-2

D

- DC IN indicator 2-12, 6-3
- DVD Super Multi drive
 - problems 8-12

- using 4-14
 - writing 4-20
- DVD-ROM drive
 - problems 8-9
 - using 4-14
- DVD-ROM&CD-R/RW drive
 - problems 8-10
 - using 4-14
 - writing 4-18
- Display 3-4
 - automatic power off 3-7
 - brightness down 5-4
 - brightness up 5-4
 - controller B-1
 - hinges 2-9
 - opening 1-6
 - screen 2-9
- Docking port 2-7
- Documentation list 1-1
- Dual Pointing Device
 - AccuPoint 2-10, 4-2
 - AccuPoint control buttons 2-10
 - Touch Pad 2-10, 4-1, 8-16
 - Touch Pad control buttons 2-10, 4-1
 - Touch Pad location 2-9
 - using 4-1

E

- Equipment checklist 1-1
- eSATA device 3-33
 - eSATA/USB combo port 2-3
 - problems 8-22
- ExpressCard 3-16
 - inserting 3-16
 - removing 3-17

External monitor 2-6, 3-31
problems 8-24

F

FN + 1 (TOSHIBA Zooming Utility reduce) 5-5
FN + 2 (TOSHIBA Zooming Utility enlarge) 5-5
FN + ESC (Mute) 5-3
FN + Enter 5-3
FN + F1 (Lock) 5-3
FN + F10 (Arrow mode) 5-3
FN + F11 (Numeric mode) 5-3
FN + F12 (ScrLock) 5-3
FN + F2 (Power Plan) 5-3
FN + F3 (Sleep) 5-4
FN + F4 (Hibernate) 5-4
FN + F5 (Output) 5-4
FN + F6 (Brightness Down) 5-4
FN + F7 (Brightness Up) 5-4
FN + F8 (Wireless) 5-4
FN + F9 (Touch Pad) 5-4
FN + space (Zoom) 5-5
Fingerprint Sensor
location 2-9
problems 8-19
using 4-3
Floppy diskette care 4-27
Function keys 5-2

G

Graphics controller 3-5

H

HDD Protection 4-40
HW Setup
Boot priority 7-3
CPU 7-6
LAN 7-6
USB 7-7
accessing 7-1
device config 7-7
display 7-2
general 7-2
keyboard 7-5
window 7-1
Hard Disk Drive/Optical Disc Drive

indicator 2-12
Hard disk drive 3-3
automatic power off 3-7
Heat dispersal 3-8, 4-44
Hibernation Mode 3-9
Hot keys 3-7
Brightness Down 5-4
Brightness Up 5-4
Hibernate 5-4
Lock 5-3
Mute 5-3
Output 5-4
Power Plan 5-3
Sleep 5-4
TOSHIBA Zooming Utility (enlarge) 5-5
TOSHIBA Zooming Utility (reduce) 5-5
Touch Pad 5-4
Wireless 5-4
Zoom 5-5

I

i.LINK 2-4
connecting 3-35
disconnecting 3-36
precautions 3-34
problems 8-25
Indicators 2-12

K

Keyboard 5-1
FN Sticky key 5-5
Function keys F1...F12 5-2
Hot keys 5-3
Windows special keys 5-5
emulating enhanced keyboard 5-2
problems 8-7
typewriter keys 5-1
Keypad overlay 3-7
Arrow mode 5-6
Numeric mode 5-6
temporarily using normal keyboard (overlay on) 5-7
temporarily using overlay (overlay off) 5-7

turning on the overlays 5-6

L

LAN 3-6, 4-37

Link indicator 2-6
active indicator 2-6
cable types 4-37
connecting 4-37
disconnecting 4-38
jack 2-6
problems 8-26

M

Media care 4-26

CD/DVDs 4-26
Card care 3-24
Floppy diskettes 4-27
Memory card care 3-24

Memory 3-2

additional 3-39
installing 3-27
problems 8-22
removing 3-29

Memory Stick 3-22

inserting 3-24
problems 8-15
removing 3-25

Modem 3-6

connecting 4-32
disconnecting 4-33
jack 2-5
problems 8-25
properties menu 4-31
region selection 4-30

Moving the computer 4-39

MultiMediaCard 3-22

inserting 3-24
problems 8-16
removing 3-25

P

PC Card 3-18

inserting 3-18
problems 8-13
removing 3-19

Password

Starting the computer by 6-12

Supervisor 6-12

power on 3-7
problems 8-7
user 6-10

Power

Hibernation Mode 1-10
Shut Down mode (Boot Mode)
1-7
Sleep Mode 1-8
System Auto Off 6-13
button location 2-9
conditions 6-1
indicators 6-2
panel on/off 3-8, 6-13
turning off 1-7
turning on 1-7

Problems

AC power 8-5
Additional memory module 8-22
Analyzing the problem 8-2
Battery 8-6
Bluetooth 8-27
DVD Super Multi drive 8-12
DVD-ROM drive 8-9
DVD-ROM&CD-R/RW drive 8-10
Dual Pointing device 8-16
External monitor 8-24
Fingerprint Sensor 8-19
Hard disk drive 8-8
Hardware and system checklist 8-3
Internal display panel 8-8
Keyboard 8-7
LAN 8-26
Memory Stick 8-15
MultiMediaCard 8-16
Overheating power down 8-5
PC Card 8-13
Password 8-7
Power 8-4
Real Time Clock 8-7
Recovery Media 8-28
SD/SDHC Card 8-14
Self test 8-4
Smart Card 8-14

- Sound system 8-23
- System start-up 8-4
- TOSHIBA support 8-29
- Touch Pad 8-16
- USB device 8-20
- USB floppy diskette drive 8-13
- USB mouse 8-18
- Wireless LAN 8-27
- eSATA device 8-22
- i.LINK (IEEE1394) device 8-25
- xD picture card 8-15

Processor 3-1

R

- Recovery Media 1-15
 - problems 8-28
- Recovery hard disk drive 1-14
- Restarting the computer 1-11

S

- SD/SDHC Card
 - formatting 3-23
 - inserting 3-24
 - note 3-23
 - problems 8-14
 - removing 3-25
- Security lock 3-38
 - location 2-4
- Serial port 3-36
- Sleep Mode
 - System automatic 3-7
 - setting 1-8
- Smart Card 3-20
 - inserting 3-20
 - problems 8-14
 - removing 3-21
- Soft keys
 - ENTER 5-3
 - ScrLock 5-3
 - enhanced keyboard 5-2
- Sound system
 - Stereo speakers 2-10
 - headphone jack 2-2
 - microphone 2-2
 - microphone jack 2-2
 - problems 8-23
 - volume control dial 2-2

T

- TOSHIBA Assist 3-13
- TOSHIBA Assist button 3-7
- TOSHIBA ConfigFree 3-13
- TOSHIBA DVD-RAM Utility 3-14
- TOSHIBA Disc Creator 3-13, 4-25
- TOSHIBA Express Port Replicator 3-39
- TOSHIBA HDD Protection 3-8
- TOSHIBA HDD/SSD Alert Utility 3-14
- TOSHIBA Mic Effect 3-13
- TOSHIBA PC Diagnostic Tool 3-10
- TOSHIBA Presentation button 3-7
- TOSHIBA SD Memory Boot Utility 3-12
- TOSHIBA SD Memory Card Format 3-13
- TOSHIBA Service Station 3-14
- TOSHIBA Value Added Package 3-10
- TOSHIBA Zooming Utility 3-10

U

- USB FDD Kit 3-32
- USB device
 - problems 8-20
- USB floppy diskette drive
 - problems 8-13

V

- Video RAM 3-2
- Video mode B-1
- Volume control dial 2-2
 - problems 8-24

W

- Web Camera 2-10, 3-5, 4-10
- Windows Mobility Center 3-15
- Wireless LAN 3-6, 4-34
 - problems 8-27
- Wireless communication 4-33
 - indicator 2-13, 4-36
- Wireless communication switch 2-3, 4-36

X

- xD picture card 3-22
 - inserting 3-24
 - problems 8-15
 - removing 3-25

Free Manuals Download Website

<http://myh66.com>

<http://usermanuals.us>

<http://www.somanuals.com>

<http://www.4manuals.cc>

<http://www.manual-lib.com>

<http://www.404manual.com>

<http://www.luxmanual.com>

<http://aubethermostatmanual.com>

Golf course search by state

<http://golfingnear.com>

Email search by domain

<http://emailbydomain.com>

Auto manuals search

<http://auto.somanuals.com>

TV manuals search

<http://tv.somanuals.com>