

PROGRAMMABLE CONTROLLER
PROSEC T3

ANALOG INPUT MODULE
AD368
USER'S MANUAL

[Contents](#)

Toshiba Corporation

Important information

Misuse of this equipment can result in property damage or human injury. Because controlled system applications vary widely, you should satisfy yourself as to the acceptability of this equipment for your intended purpose.

In no event will Toshiba Corporation be responsible or liable for either indirect or consequential damage or injury that may result from the use of this equipment.

No patent liability is assumed by Toshiba Corporation with respect to the use of information, illustrations, circuits, equipment, or examples of applications in this publication.

Toshiba Corporation reserves the right to make changes and improvements to this publication and/or related products at any time without notice. No obligation shall be incurred, except as noted in this publication.

This publication is protected by copyright and contains proprietary material. No part of this book may be reproduced, stored in a retrieval system, or transmitted in any form or by any means—electrical, mechanical, by photocopying, recording or otherwise—without obtaining prior written permission from Toshiba.

Copyright 1994 by Toshiba Corporation
Tokyo, Japan

Publication number: UM-TS03***E016
1st edition July 1994.

Before reading this manual

Introduction This manual explains the specification and operation of Toshiba's 8-channel analog input module AD368 for PROSEC T3 programmable controllers. Read this manual carefully before using the AD368.

Besides this manual, read the following manuals and descriptions before operation, if necessary, for your better understanding.

Related manuals The following related manuals are available for the T3.

T3 User's Manual - Hardware

This manual covers the T3's main body and basic I/O - their specifications, handling, maintenance and services.

T3 User's Manual - Functions

This document explains the functions of the T3 and how to use them. The necessary information to create user program is covered in this volume.

T-series Instruction Set

This manual provides the detailed specifications of instructions for Toshiba's T-series Programmable Controllers.

T-PDS Basic Operation Manual

This manual explains how to install the T-series program development system (T-PDS) into your personal computer and provides basic programming operations.

T-PDS Command Reference Manual

This manual explains each command of the T-series program development system (T-PDS) in detail.

T-series Computer Link Function

This manual explains the specification and handling method of the T-series Programmable Controller's Computer Link function.

Precautions

- Use your AD368 only on the rack of the T3.
- Do not touch the internal components on the AD368's printed circuit board. It may cause damage to the module.
- Read the precautions of this manual and the T3 manuals before installing and wiring the AD368.

Before reading this manual

Note and caution symbols Users of this manual should pay attention to information preceded by the following symbols.

NOTE  Calls the reader's attention to information considered important for full understanding of the procedures and/or operation of the equipment.

CAUTION  Calls the reader's attention to conditions or practices that could damage the equipment or render it temporarily inoperative.

Terminology	CPU	Central Processing Unit
	EEPROM	Electrically Erasable Programmable Read Only Memory
	Hex.	Hexadecimal
	I/O	Input/Output
	LED	Light Emitting Diode
	ms	millisecond
	RAM	Random Access Memory
	Vac	ac voltage
Vdc	dc voltage	

Contents	1. Overview of the AD368	5
	1.1 Overview	5
	1.2 Names and functions	6
	1.3 Internal block diagram.....	9
	2. Settings.....	10
	2.1 Settings for input signal ranges	10
	3. Installing and Wiring	11
	3.1 Installing the module	11
	3.2 Wiring.....	12
	3.2.1 Terminal arrangement.....	12
	3.3.2 How to wire	13
	3.3 Application precautions	15
	3.3.1 Installing environment	15
	3.3.2 Wiring precautions	16
	4. Register Configuration	17
	4.1 I/O registers and buffer memory	17
	4.2 Data format	20
	4.2.1 Analog input data	20
	4.2.2 Status 1.....	22
	4.2.3 Offset calibration data	23
	4.2.4 Gain calibration data	23
	Appendix	24
	A. Specification.....	24
	B. Operation flow	25
	C. How to calibrate	26
	D. How to use +10 V reference voltage	28
	E. Details of the READ instruction	29
	F. AD318/AD328/AD338	31

1. Overview of the AD368

1.1 Overview

Toshiba's 8-channel analog input module AD368 will convert the external analog signal (voltage or current) into digital data which can be handled in the T3. The AD368 has the following features:

1. 8 channels of analog input per module
 2. 12-bit high resolution per channel
 3. Selectable input ranges (1 range per module)
 4. Gain and offset calibration function for each channel
 5. +10Vdc output for reference voltage
- The maximum 8 channels of analog signals can be input. 8 words of T3's input register (XW) are assigned to the AD368.
 - The AD368 converts the 8 analog signals into the 8 words of digital data every 20 ms. The converted data will be written into the corresponding buffer memory of the module.
 - The data written in the buffer memory will be read by the T3 in the T3's batch I/O processing or in the execution of user programmed instruction (I/O or READ).

The following analog signals can be input by setting the internal jumper plugs of the module.

Voltage input	Bipolar	$\pm 5\text{ V}$ $\pm 10\text{ V}$
	Unipolar	0 to 5 V 0 to 10 V 1 to 5 V
Current input	Bipolar	$\pm 20\text{ mA}$
	Unipolar	0 to 20 mA 4 to 20 mA

1. Overview of the AD368

1.2 Names and functions

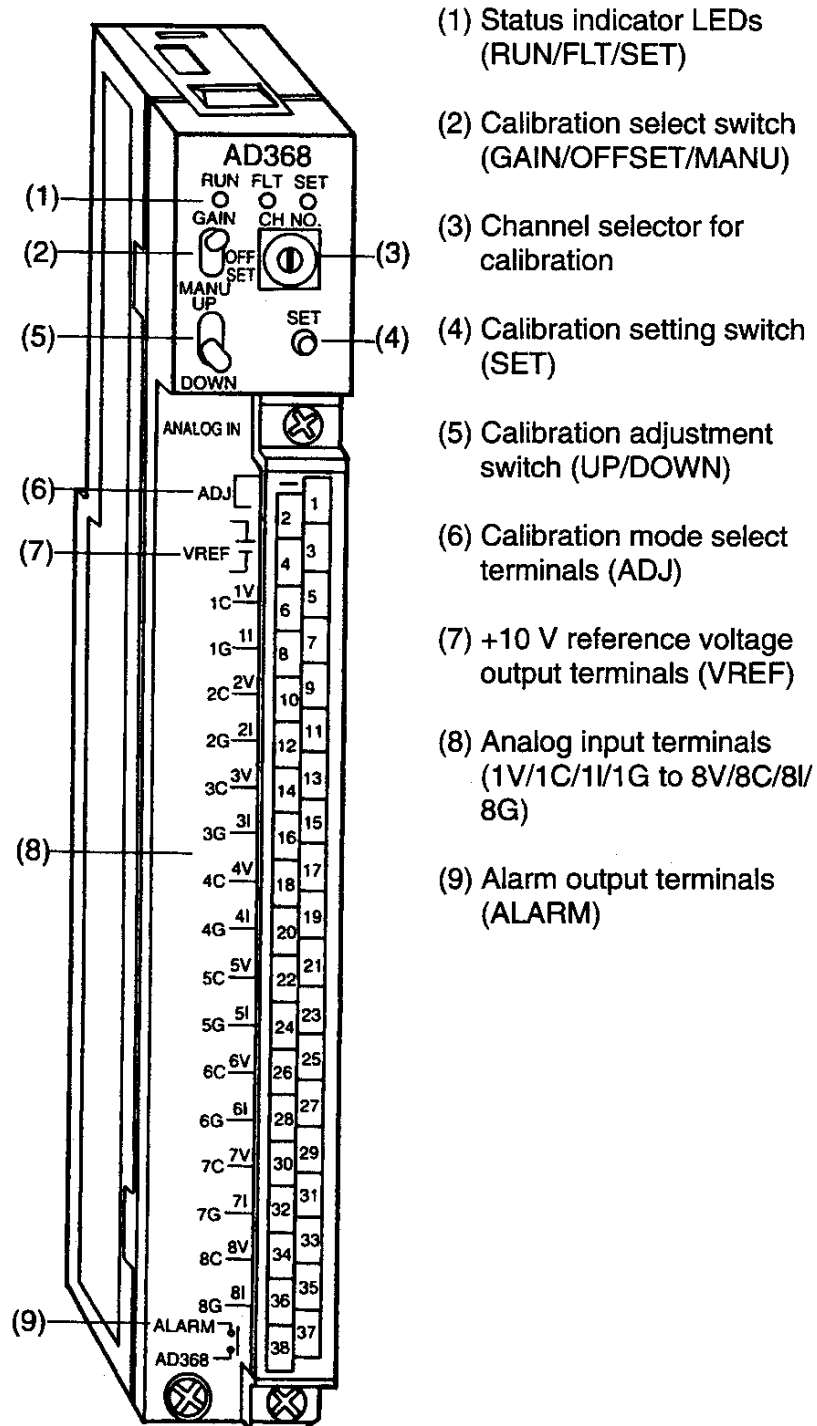

1. Overview of the AD368

(1) Status indicator LEDs

1) RUN

RUN will be lit in normal state of the module, and will not be lit in abnormal state.

2) FLT

FLT will be lit if an error has occurred in the module.

3) SET

When the calibration setting switch is pressed, SET will be lit during write, and will go out when the write ends.

Name	Lit ●	Not lit ○	Blinking ●
RUN	Normal state	Abnormal state	Calibration mode
FLT	Error occurred	Normal state	—
SET	Calibration data being written	Normal state	—

(2) Calibration select switch (GAIN/OFFSET/MANU)

In calibration mode, setting items can be selected either GAIN or OFFSET by this switch.

Adjust gain with this switch in GAIN position, and adjust offset with this switch in OFFSET position. The MANU position is unused.

Name	Function
GAIN	Gain adjustment
OFFSET	Offset adjustment
MANU	Unused

(3) Channel selector for calibration

This rotary switch changes over channels in calibration.

Numbers 1 to 8 of the rotary switch correspond to CH 1 to CH 8, respectively. Numbers 0 and 9 of the rotary switch are unused.

Switch position	Corresponding channel
0	—
1	Channel 1
2	Channel 2
3	Channel 3
4	Channel 4
5	Channel 5
6	Channel 6
7	Channel 7
8	Channel 8
9	—

1. Overview of the AD368

- (4) Calibration setting switch (SET)
Pressing this switch will write the calibration data into the EEPROM built in the AD368.
- (5) Calibration adjustment switch (UP/DOWN)
Every time when you turn this switch to UP side, the content of the calibration data will be increased by one. When you keep turning the switch for a few seconds, the data will be increased continuously. When you turn this switch to DOWN side, the calibration data will be decreased by one. When you keep turning the switch for a few seconds, the data will be decreased continuously.
- (6) Calibration mode select terminals (ADJ)
When these terminals are shorted, calibration becomes available. Normally, these terminals should be open.
- (7) +10 V reference voltage output terminals (VREF)
These terminals output +10 Vdc (max. 5 mA) as reference voltage. Refer to Appendix D.
- (8) Analog input terminals (1V/1C/1I/1G to 8V/8C/8I/8G)
These terminals will be connected with external analog signals. For detailed wiring, see Section 3.2.
- (9) Alarm output terminals (ALARM)
While FLT is lit (module error), the built-in relay will be opened. While FLT is not lit, the relay will be closed. The maximum load capacity of the relay is 30 Vdc / 0.5 A. Use a protective fuse of 1 A externally.

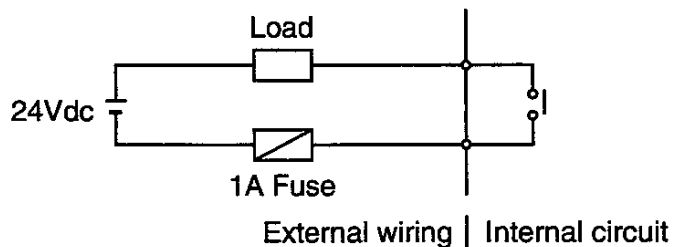

1. Overview of the AD368

1.3

Internal block diagram The internal block diagram of the AD368 is shown below.

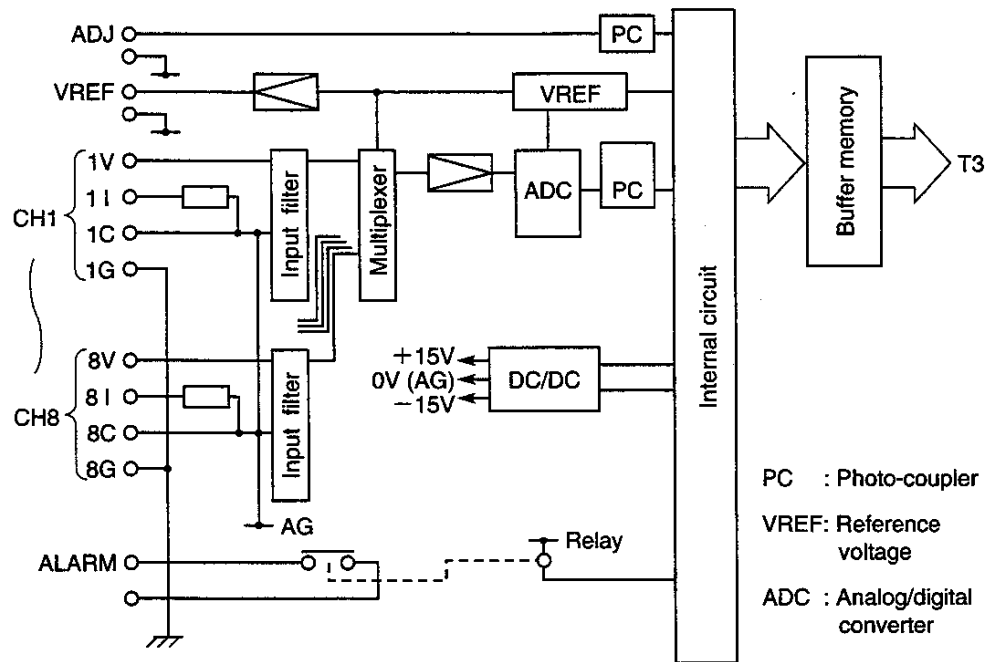

The details of the input filter is as follows.

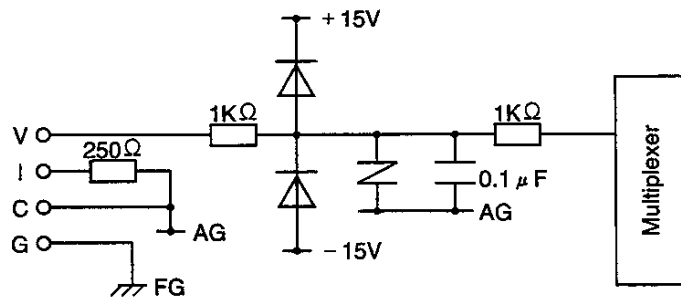

AG : Analog ground

2. Settings

2.1 Settings for input signal ranges

Set the jumper plugs according to the input analog signal.

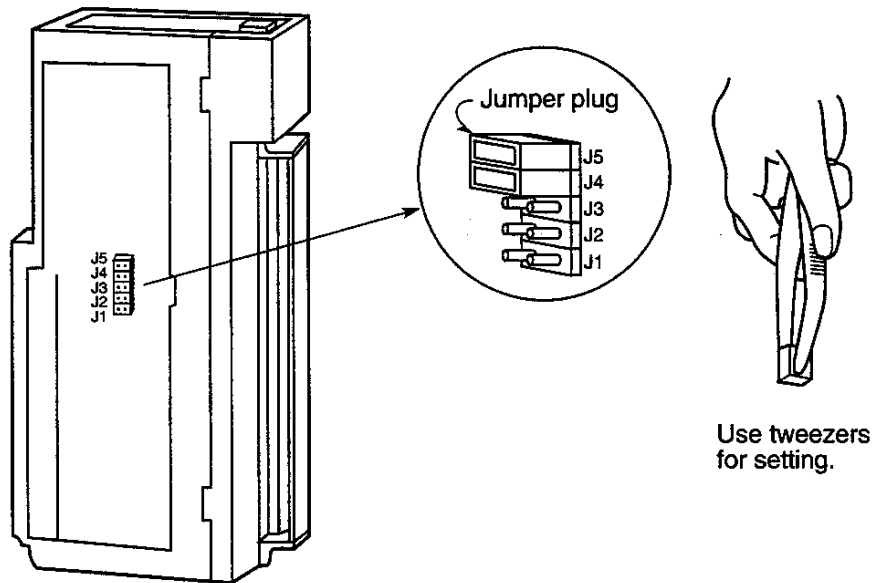

Use tweezers for setting.

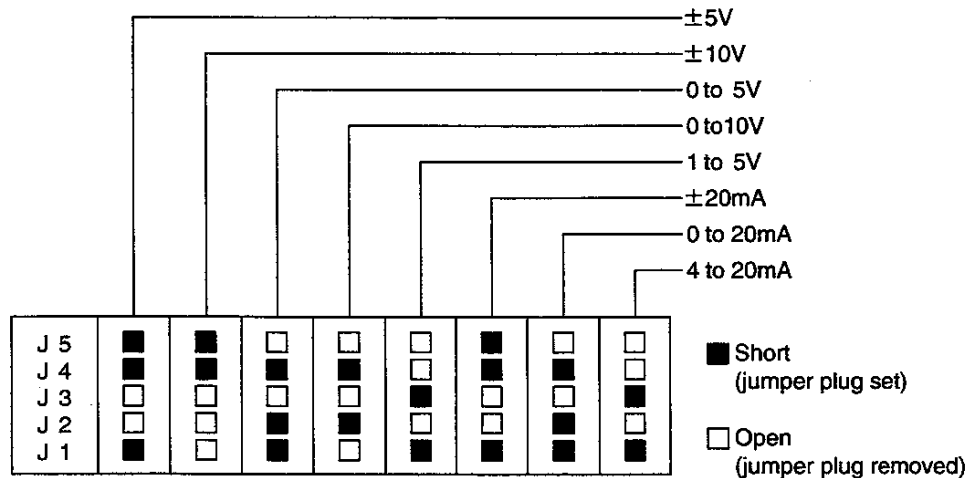

NOTE

- Changing the input ranges with the jumper plugs will initialize the calibration data.
- Remove the AD368 from the rack before setting.
- Do not touch other components on the printed circuit board of the module.
- The factory setting is $\pm 10V$ range.
- Note that the AD368 will not work correctly if the jumper plugs are set other than above.
- Keep the extra jumper plugs, which may be needed to change the input range in the future.

3. Installing and Wiring

3.1 Installing the module

Install the module in the following procedure.

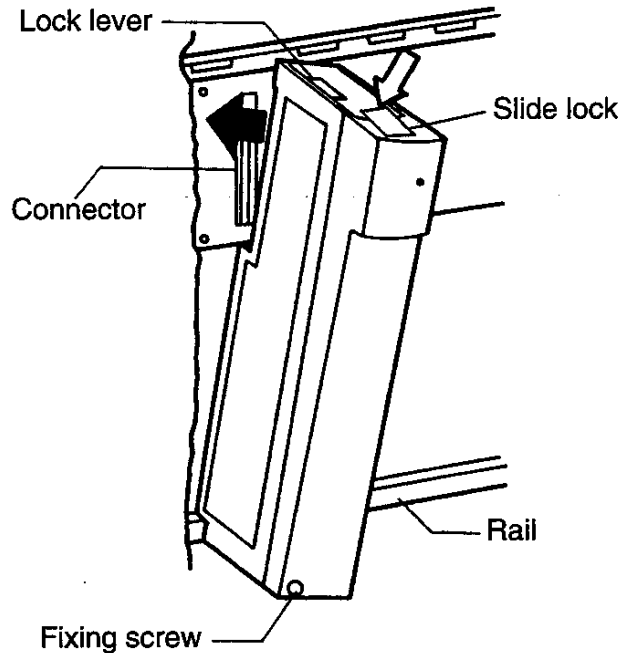

- (1) Slide back the slide lock on the top of the module and release the lock lever.
- (2) Hook the bottom end of the module with the rail, and push up the lock lever.
- (3) While setting the bottom of the module as the supporting point, install the module in the slot to fit the connector.
- (4) Release the lock lever and lock the module in the rack. Slide forward the slide lock and fix the lock lever.
- (5) Tighten the fixing screw with the module.

CAUTION • Be sure that the screws of the module, CPU, and power supply are tightened firmly.



3. Installing and Wiring

3.2 Wiring

3.2.1 Terminal arrangement

Terminal No.	Terminal name	Function
1	ADJ	Open : normal mode Short : calibration mode
2		
3	VREF	+10V reference voltage 0V
4		
5	1V	Analog input channel 1
6	1C	
7	1I	
8	1G	
9	2V	Analog input channel 2
10	2C	
11	2I	
12	2G	
13	3V	Analog input channel 3
14	3C	
15	3I	
16	3G	
17	4V	Analog input channel 4
18	4C	
19	4I	
20	4G	
21	5V	Analog input channel 5
22	5C	
23	5I	
24	5G	
25	6V	Analog input channel 6
26	6C	
27	6I	
28	6G	
29	7V	Analog input channel 7
30	7C	
31	7I	
32	7G	
33	8V	Analog input channel 8
34	8C	
35	8I	
36	8G	
37	ALARM	Opened when error or power off Shorted when normal
38		

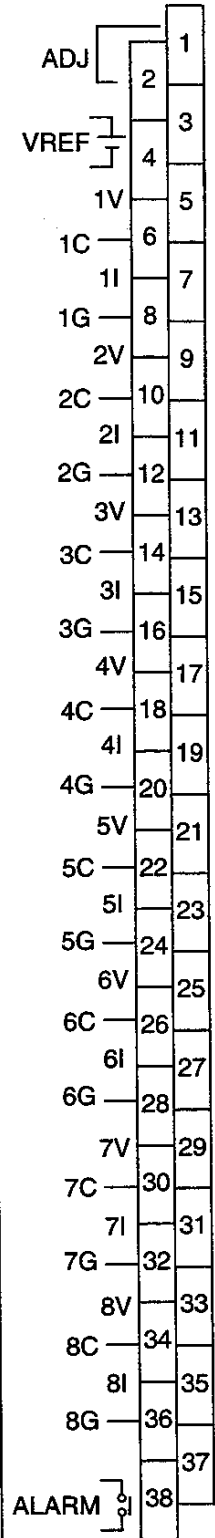

3. Installing and Wiring

3.2.2 How to wire (1) Voltage input

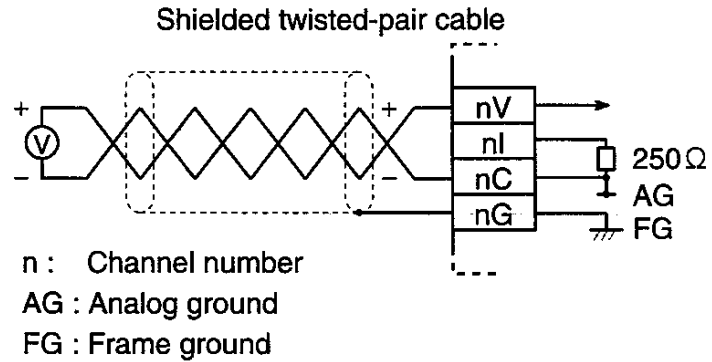

(2) Current input

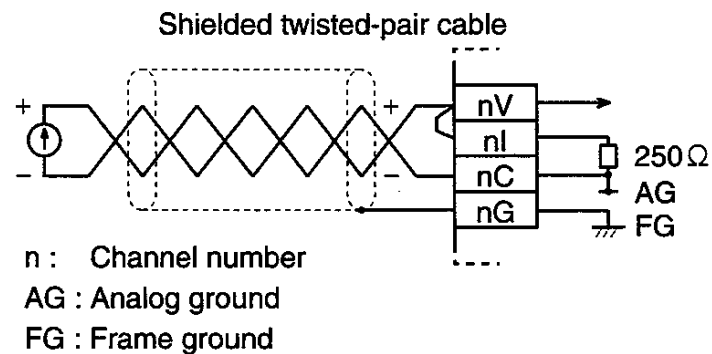

CAUTION For current input, short between nV and nI on the terminal block. Be sure the terminals to be shorted are fixed firmly.

3. Installing and Wiring

Wiring precautions:

- Be sure that the screw of the terminal is tightened firmly. If the contact resistance value is large, measurement values will be incorrect.
- In the AD368, the nC terminals of each channel are connected internally. If electric potential difference occurs between the sensors (common voltages different), insert the isolator to each sensor.

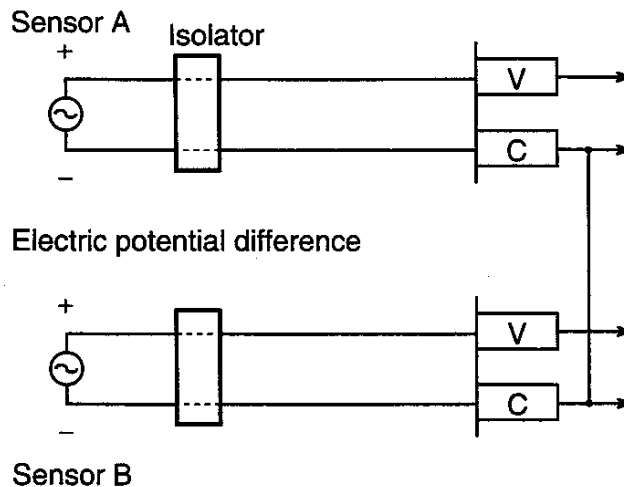

- If measurement values are unstable due to noise influences, change the grounding for the shield in the following order for stable measurement.

(1)

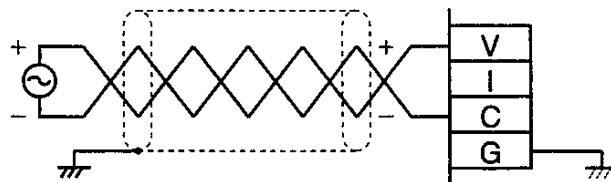

(2)

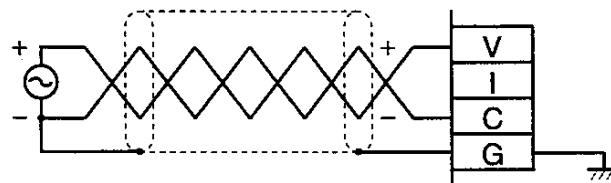

3.3 Application precautions

3.3.1 Installing environment

Do not install the AD368 in the following locations:

- Where the ambient temperature drops below 0 °C (32° F) or exceeds 55 °C (131° F);
- Where the relative humidity drops below 20% or exceeds 90%;
- Where there is condensation due to sudden temperature changes;
- In locations subject to vibrations that exceed tolerance;
- In locations subject to shocks that exceed tolerance;
- Where there are corrosive or inflammable gases;
- In locations subject to dust, machining debris or other particles; and
- In locations exposed to direct sunlight.

Also, observe the following precautions when installing an enclosure in which the T3 will be mounted.

- Provide the maximum possible distance between high-voltage or power panels. The distance must be at least 200 mm (8 inches).
- When installing an enclosure in the vicinity of high-frequency equipment, be sure to correctly ground the enclosure.
- When sharing the channel base with other panels, check for leakage current from the other panels or equipment.

3. Installing and Wiring

3.3.2 Wiring precautions

Observe the precautions below when installing and wiring the I/O modules.

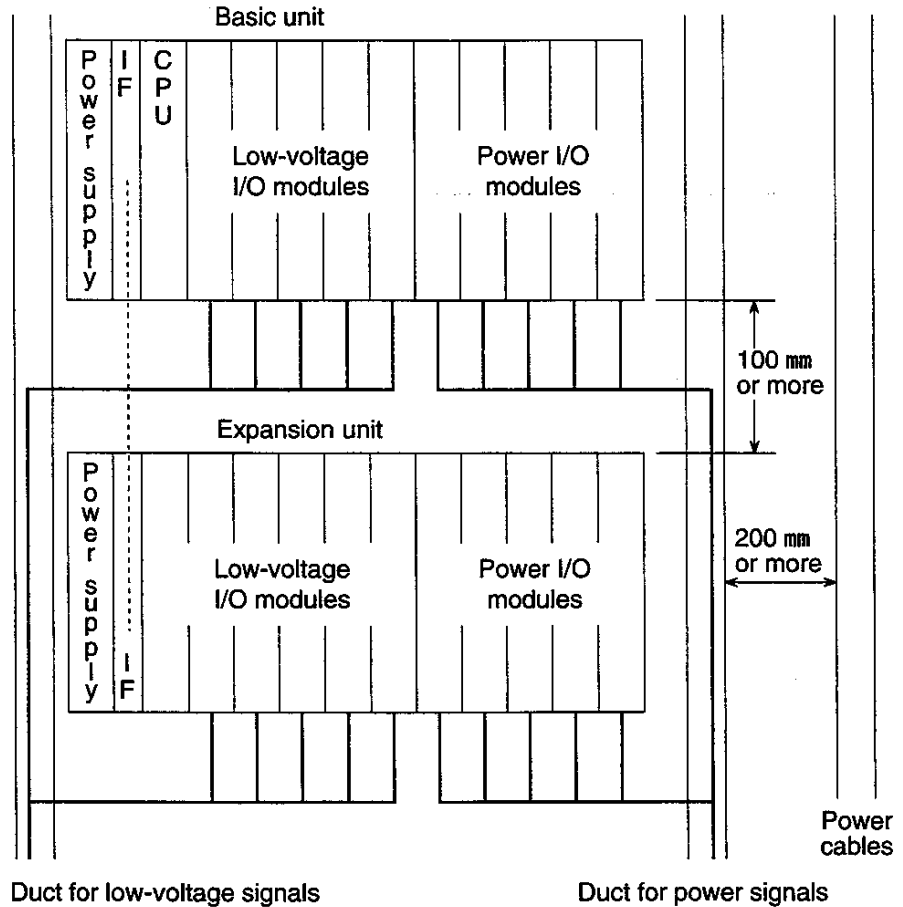

Low-voltage I/O modules
DC input module
Analog input module
Analog output module
Pulse input module
ASCII module
Transmission module

Power I/O modules
AC input module
DC output module
AC output module
Contact output module

- 1) Separate the low-voltage I/O modules (left side) and power I/O modules (right side) in layout and wiring.
- 2) keep a distance of 100 mm or more between the units for maintenance work and ventilation.
- 3) Keep the modules away from power cables and power equipment. The distance between them must be 200 mm or more, or use a steel plate to shield between them. (Ground the steel plate.)

4. Register Configuration

4.1 I/O registers and buffer memory

8 words of the input register (XW) are assigned to the AD368. As normal input, analog conversion data will be stored in the corresponding XW registers. This module also has 32 words internal memory (called a "buffer memory") containing analog conversion data, status data, and calibration data. For reading the buffer memory, use the READ instruction.

(1) Module type

The AD368 has the following module type for I/O allocation.
X 8W (8 words input)

(2) Register configuration

The analog conversion data of each channel will be allocated into the following I/O registers (XW), and read into the XW registers with batch I/O processing, as same as normal discrete inputs.

T3's I/O registers

XWn	Analog input value channel 1
XWn + 1	Analog input value channel 2
XWn + 2	Analog input value channel 3
XWn + 3	Analog input value channel 4
XWn + 4	Analog input value channel 5
XWn + 5	Analog input value channel 6
XWn + 6	Analog input value channel 7
XWn + 7	Analog input value channel 8

n = 0, 1, 2, . . .

(Sample program)

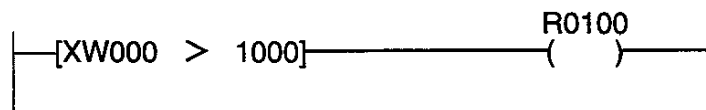

XW000 : Analog input value

R0100 is turned ON when the data of XW000 is greater than the constant value 1000.

4. Register Configuration

(3) The configuration of the AD368's buffer memory is as follows:

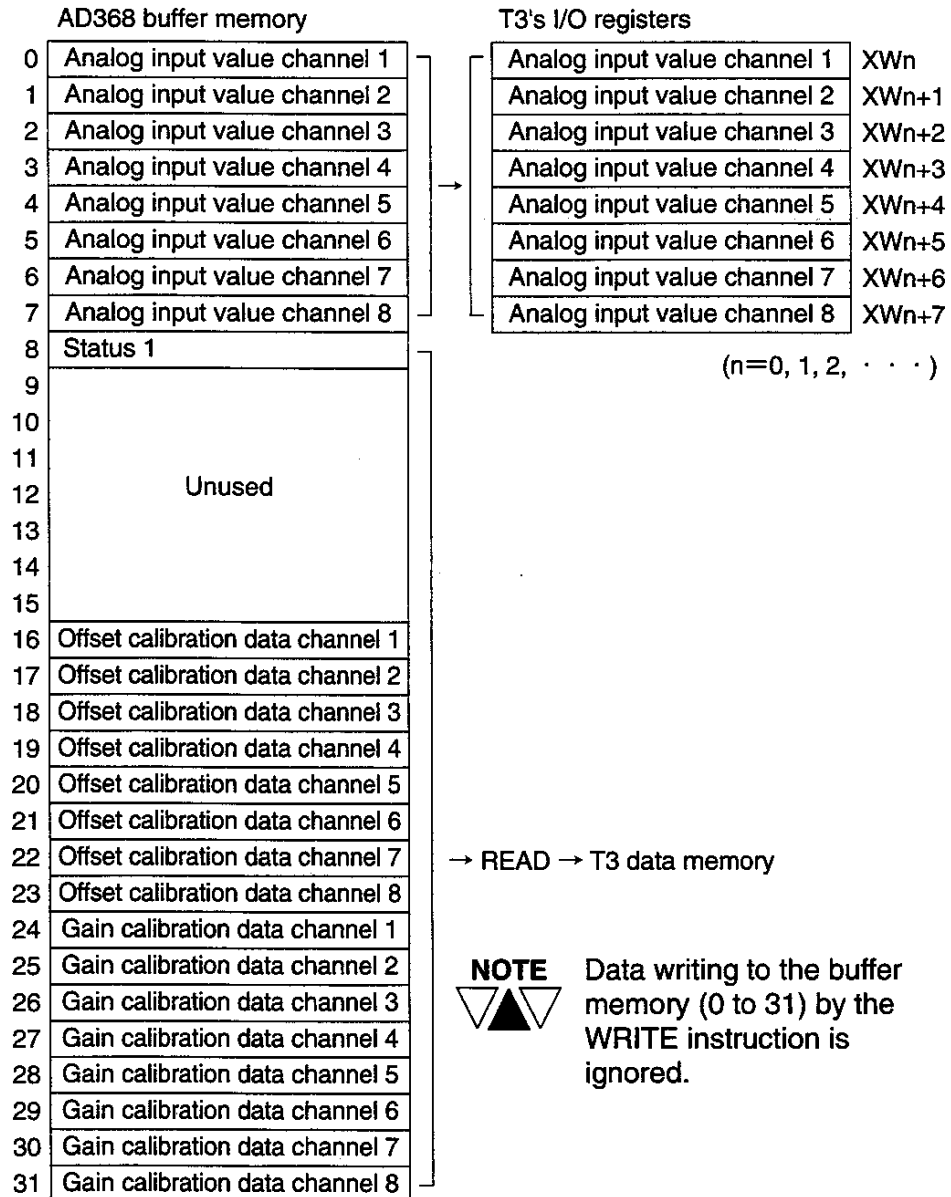

- Analog input value (converted data) will be read into the corresponding XW register of the T3.
- To monitor the status 1, offset calibration data, and gain calibration data, read the buffer memory contents into the T3's data memory by using the READ instruction. For details, see programming example on the next page.
- Analog conversion data of each channel will also be stored into the buffer memory (0 to 7). These values can be read by the READ instruction or by the I/O (direct input/output) instruction.

4. Register Configuration

(4) Reading the buffer memory

Normally, the analog conversion data are read into the XW registers through T3's batch I/O processing.

On the other hand, the buffer memory contents of the AD368 can be read into the desired registers by executing the READ instruction.

(Sample program)

In the case that XW000 to XW007 are assigned to the AD368, the following program reads the buffer memory of the AD368.

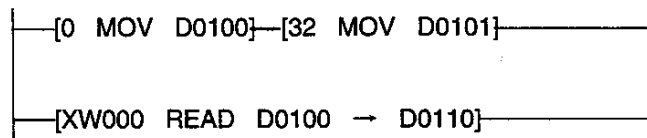

XW000: Starting register assigned to the module

D0100: Starting address of buffer memory to be read

D0101: Number of words to be read

D0110: Starting register of destination

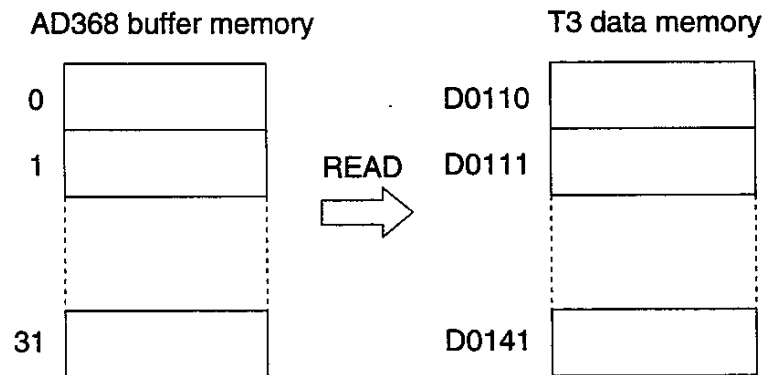

4. Register Configuration

4.2 Data format

4.2.1 Analog input data

(1) Bipolar mode ($\pm 5V$, ± 10 , ± 20 mA)

The range of digital values converted from analog input values is from -2000 to 2000 corresponding to the analog input range. Minus data will be expressed using the two's complement. A 0.5% margin is set to the upper and lower limits to cope with fluctuations near full-scale input values.

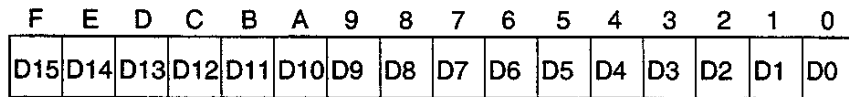

	Analog value			Digital value	
	$\pm 10V$	$\pm 5V$	$\pm 20mA$	Hex.	Integer
Upper limit	+ 10.050	+ 5.025	+ 20.100	H07DA	2010
Full-scale (+)	+ 10.000	+ 5.000	+ 20.000	H07D0	2000
0	0.000	0.000	0.000	H0000	0
Full-scale (-)	- 10.000	- 5.000	- 20.000	HF830	- 2000
Lower limit	- 10.050	- 5.025	- 20.100	HF826	- 2010

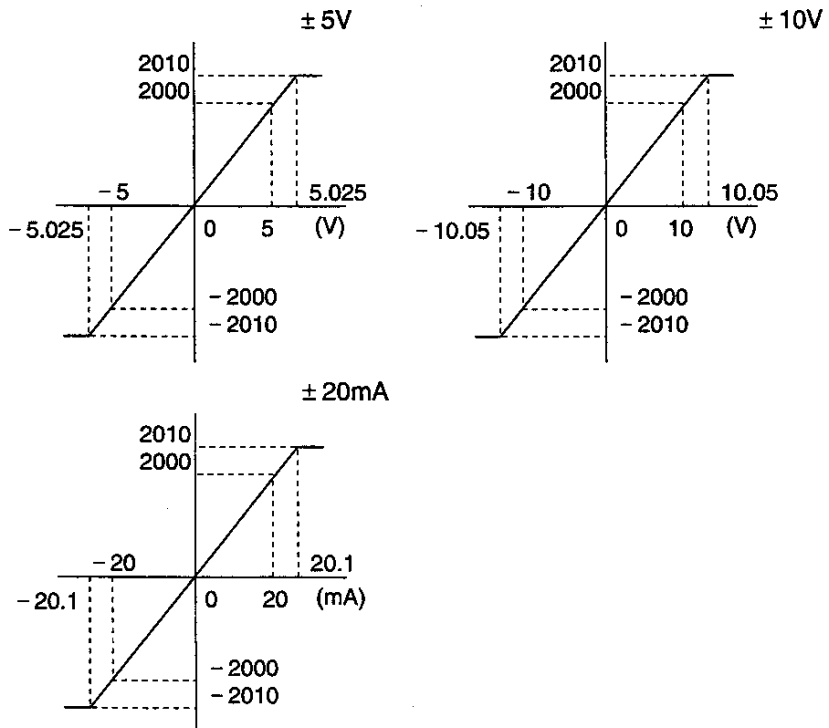

4. Register Configuration

(2) Unipolar mode (0 to 5 V, 0 to 10 V, 1 to 5 V)
(0 to 20 mA, 4 to 20 mA)

The range of digital values converted from analog input values is from 0 to 4000 corresponding to the analog input range. A 0.5% margin is set to the upper limit to cope with fluctuations near full-scale values.

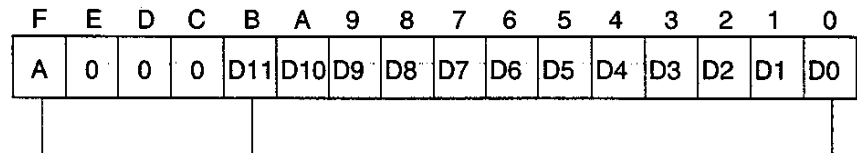

Wire break detection	
1: Breakage	0: Normal

(4 to 20 mA mode only)

	Analog value					Digital value	
	0 - 5 V	0 - 10 V	1 - 5 V	0 - 20 mA	4 - 20 mA	Hex.	Integer
Upper limit	5.025	10.050	5.020	20.100	20.080	H0FB4	4020
Full-scale	5.000	10.000	5.000	20.000	20.000	H0FA0	4000
0	0	0	1	0	4	H0000	0

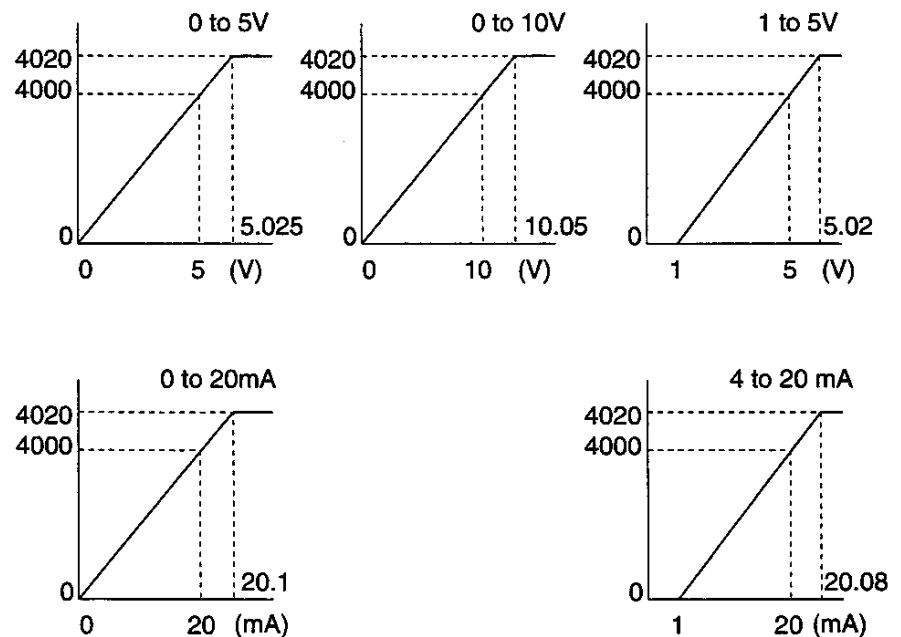

4. Register Configuration

4.2.2 Status 1

Status 1 (address 8 of buffer memory) shows the input mode and error information.

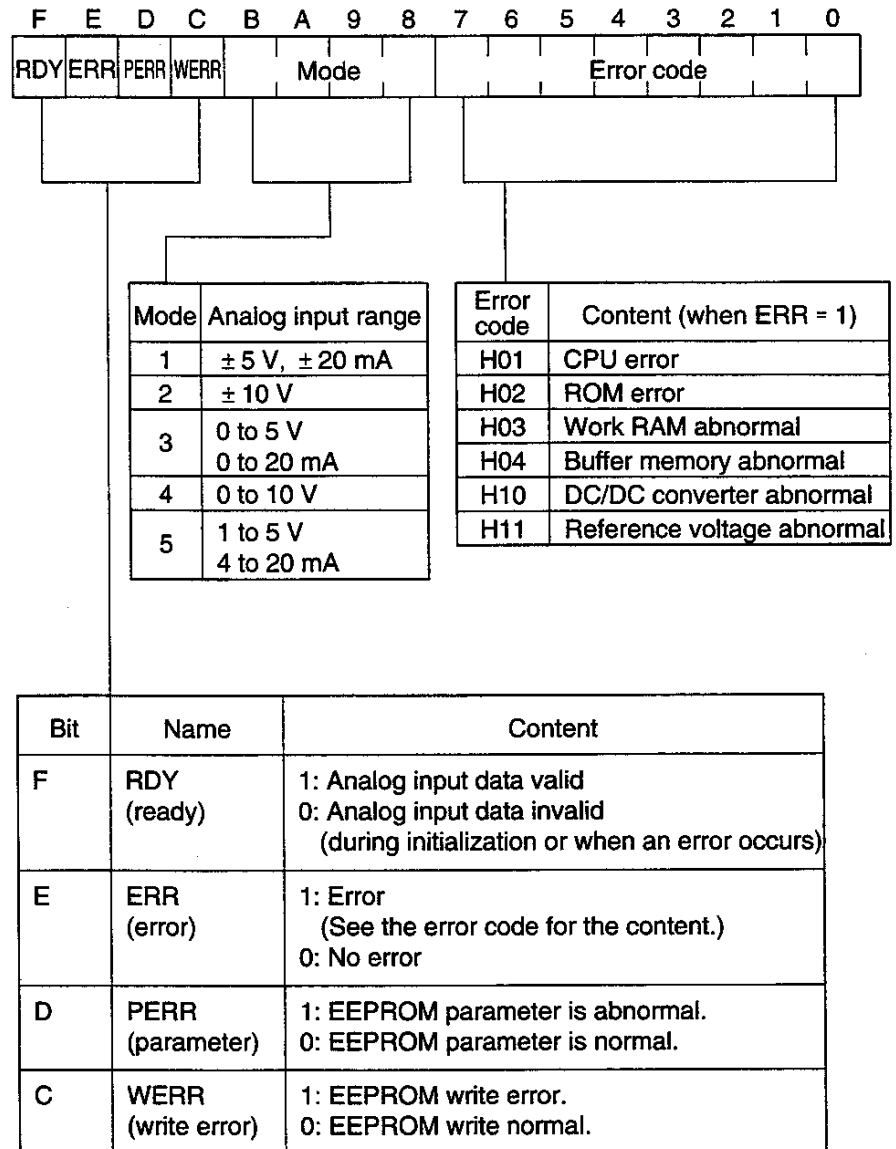

- NOTE**
- When an error has occurred, turn off/on power to the T3.
 - If the reference voltage abnormal has occurred, check the input range setting (jumper plugs setting).

4. Register Configuration

4.2.3 Offset Calibration data

The offset calibration data are stored in addresses 16 to 23 of buffer memory for each channel.

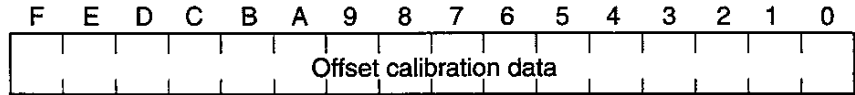

Mode	Valid range		
	Minimum value	No setting	Maximum value
$\pm 5\text{ V}$, $\pm 10\text{ V}$, $\pm 20\text{ mA}$ (bipolar)	-200	0	200
0 to 5 V, 0 to 10 V, 1 to 5 V 0 to 20 mA, 4 to 20 mA (unipolar)	-400	0	400

NOTE  • Initial value is 0.
• Refer to Appendix C.

4.2.4 Gain calibration data

The gain calibration data are stored in addresses 24 to 31 of buffer memory for each channel.

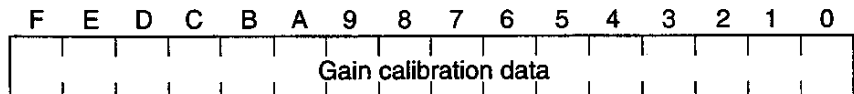

Mode	Range valid		
	Minimum value	No setting	Maximum value
$\pm 5\text{ V}$, $\pm 10\text{ V}$, $\pm 20\text{ mA}$ (bipolar)	1800	2000	2200
0 to 5 V, 0 to 10 V, 1 to 5 V 0 to 20 mA, 4 to 20 mA (unipolar)	3600	4000	4400

NOTE  • Initial value is the no setting value in the above table.
• Refer to Appendix C.

Appendix

A Specification

Item	Specification		Remarks	
Analog input	Voltage input	Bipolar	$\pm 5V$	Set the mode by switching the jumper plug.
			$\pm 10V$	
		Unipolar	0 to 5 V	
			0 to 10 V	
	1 to 5 V			
	Current input	Bipolar	$\pm 20\text{ mA}$	
Unipolar			0 to 20 mA	
			4 to 20 mA	
Input channel	8 channels / module (X 8 W)			
Resolution	12 bits / 0.025%			
Input impedance	Voltage input	1 M Ω or more		
	Current input	250 Ω		
Overall accuracy	$\pm 0.2\%$ (at 25 °C)			
Temperature drift	$\pm 100\text{ppm} / ^\circ\text{C}$			
Conversion rate	20 ms / 8 channels		2.5 ms / 1 ch	
Max. input voltage/ current	Voltage input: Max. 13 V Current input: Max. 30 mA			
Insulation	Photo-coupler insulation (not isolated between the channels)			
Withstand voltage	500 Vac / 1 minute			
+10 V reference voltage output	10.000 V $\pm 10\text{ mV}$ at 25 °C Max. load current: 5 mA			
Alarm output	Contact output: 24 Vdc, 0.5 A			
Consumed current	450 mA (5 Vdc)			
Weight	500 g			

B Operation flow

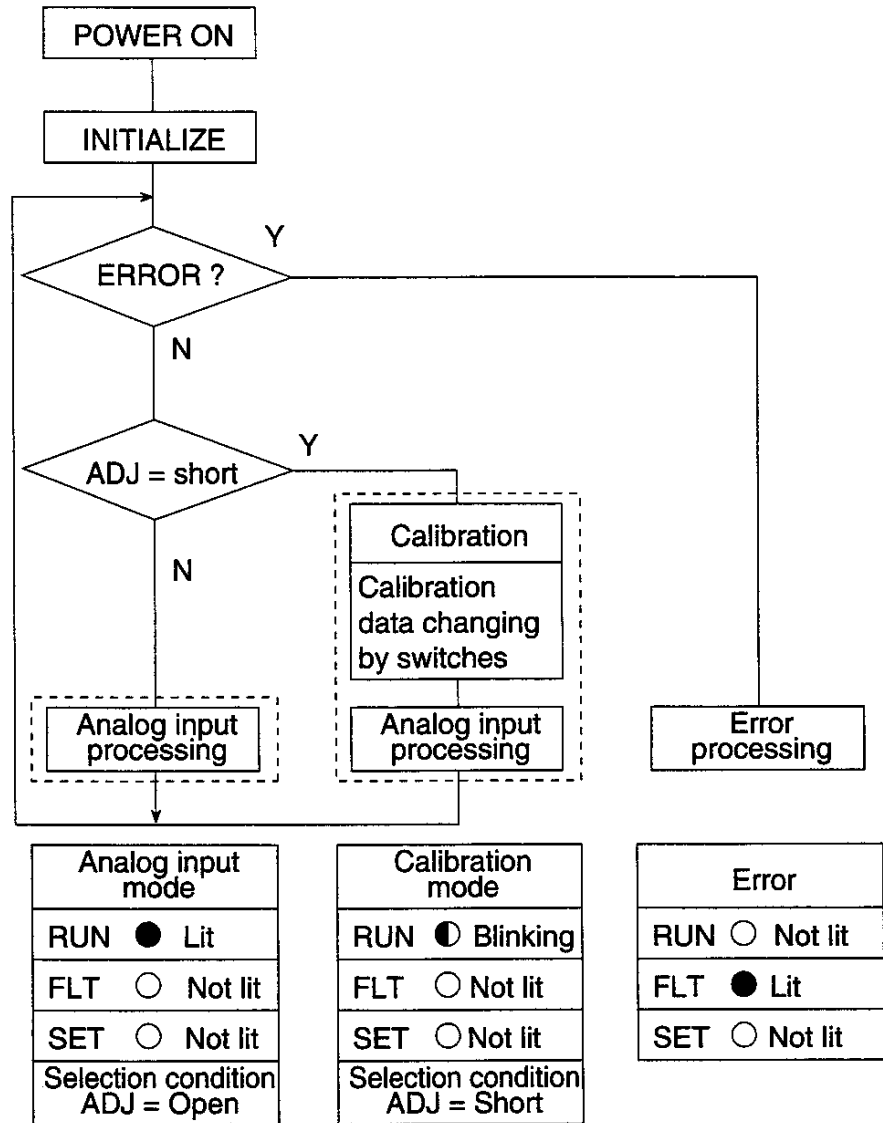

Analog input mode	
RUN	● Lit
FLT	○ Not lit
SET	○ Not lit
Selection condition ADJ = Open	

Calibration mode	
RUN	● Blinking
FLT	○ Not lit
SET	○ Not lit
Selection condition ADJ = Short	

Error	
RUN	○ Not lit
FLT	● Lit
SET	○ Not lit

Note: SET will be lit during write.

C How to calibrate

Performing gain and/or offset calibrations for input values will enable to adjust the environment for more accurate measurement. In the AD368, input data correction is carried out by using the gain and the offset calibration data as follows.

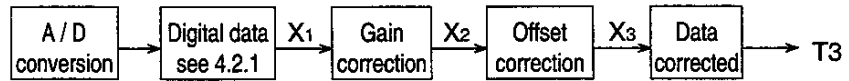

$$X_2 = X_1 \times \frac{G}{FS} \quad X_3 = X_2 + O$$

- X₁ : Analog input data (converted digital data)
- X₂ : Data after correcting gains
- X₃ : Data after correcting gains and offsets
- FS : Full-scale value
- G : Gain calibration value
- O : Offset calibration value

Example: In case that full-scale value = 4000 (0 to 10 V),
gain calibration value = 4200,
offset calibration value = - 100,
the correction will be as follows:

Input data (before correction)

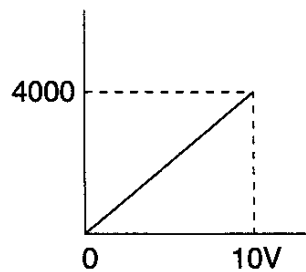

$$\rightarrow X_1 \times \frac{4200}{4000}$$

After gain correction

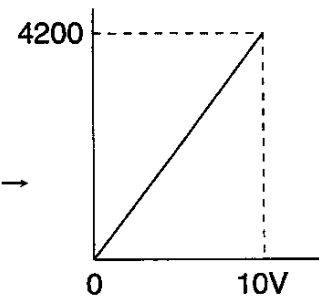

$$X_2 - 100$$

After offset correction

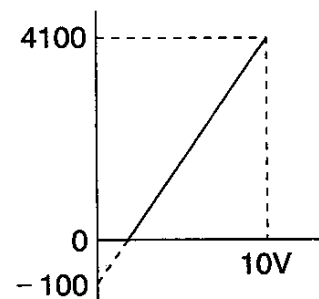

- As shown in the above unipolar example, if data after correction become minus, the limit value will be set to 0.

Actual calibration procedure is shown below.

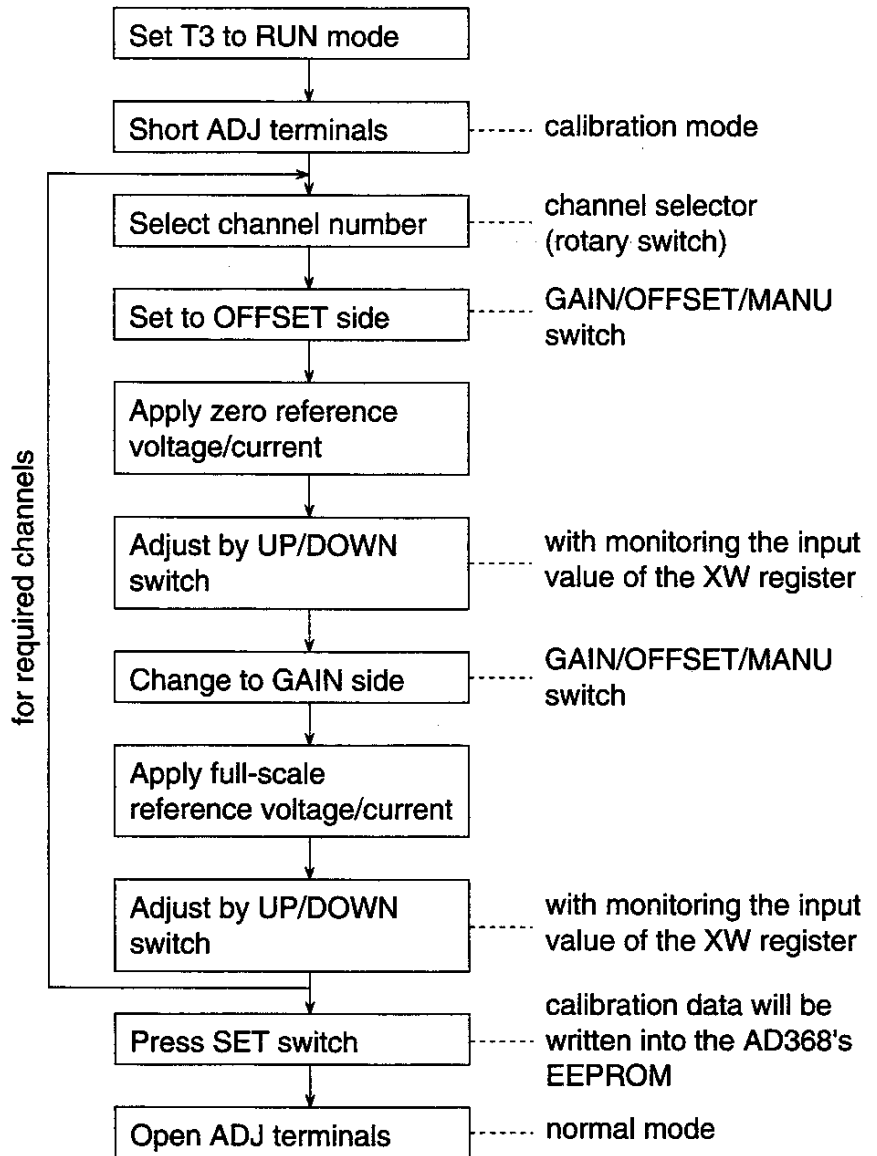

- NOTE**
- (1) The calibration data will be initialized when the input range is changed by the jumper plugs.
 - (2) This function is for adjusting within 10%. It is not a scaling function.

Appendix

D How to use +10 V reference voltage

Calibration is also possible with using the +10 V reference voltage. Use the following circuit.

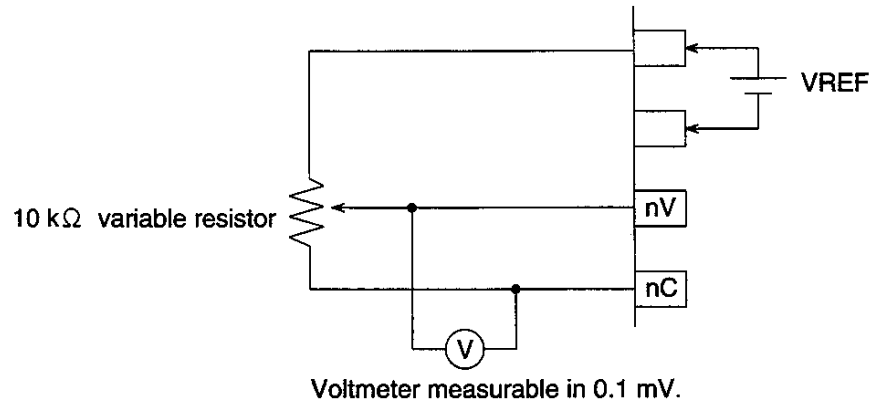

- The maximum load current for +10 V reference voltage output is 5 mA.
- Make the wiring as short as possible for correct adjustment.
- Remove the adjustment wiring before starting normal operation.
- This adjustment cannot be applied to current input.

E Details of the READ instruction

FUN 237 Special module data read (READ)	
Will read data from the special module.	Related instruction Special module data write (WRITE)

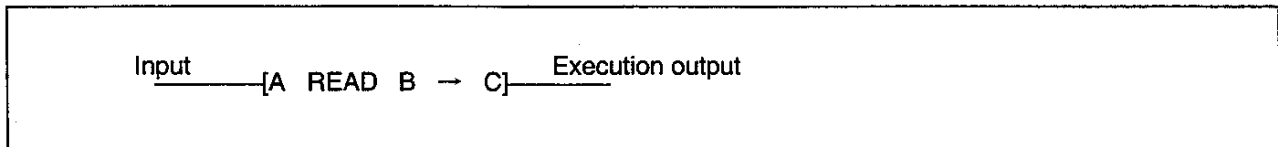

Function

- Will transfer data from buffer memory of the special module into the T3's registers.

Input	Action	Output	ERF
OFF	Not executed	OFF	
ON	Execution: in normal operation	ON	
	Not executed: in error (*2)	ON	ON

Operand

opr	Name	Device												Register												Constant	Index	
		X	Y	S	L	R	Z	T	C	I	O	XW	YW	SW	LW	RW	W	T	C	D	F	IW	OW	I	J			K
		A	slot/register												<input type="checkbox"/>	<input type="checkbox"/>												
B	Transfer parameter												<input type="checkbox"/>	<input type="checkbox"/>	<input type="checkbox"/>	<input type="checkbox"/>	<input type="checkbox"/>	<input type="checkbox"/>	<input type="checkbox"/>	<input type="checkbox"/>								
C	Top register of destination														<input type="checkbox"/>	<input type="checkbox"/>	<input type="checkbox"/>	<input type="checkbox"/>	<input type="checkbox"/>	<input type="checkbox"/>								<input type="checkbox"/>

Program example

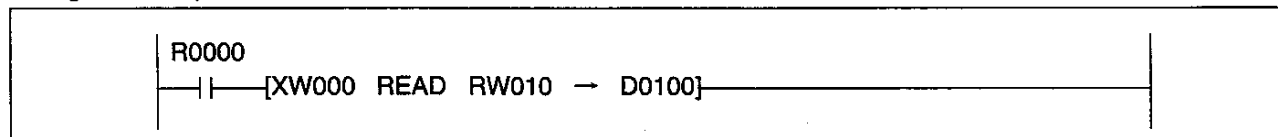

Operation

- When R0000 is ON, the buffer memory data of the size indicated by RW011, starting with the address indicated by RW010 of the special module allocated to XW000, are read and stored in D0100 and after.
- The maximum number of words to be read is 256 words.

Buffer memory area (special module of XW000)
(word address)

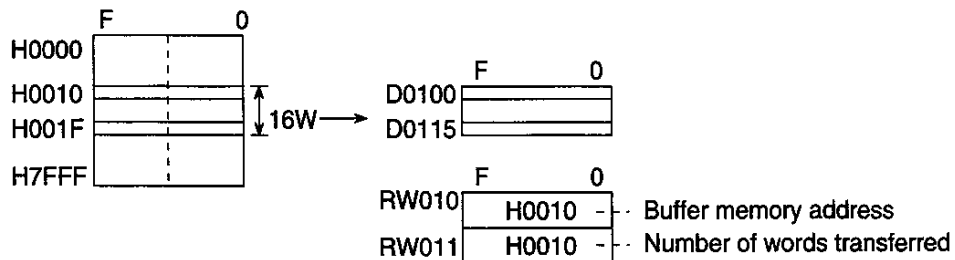

When a constant is used for the operand A, refer to the setting method on the next page. (*1)

Appendix

*** 1) Specifying the module by a constant.**

The special module can be specified by a constant data as follows.

$$(\text{Unit number}) \times 256 + (\text{Slot number})$$

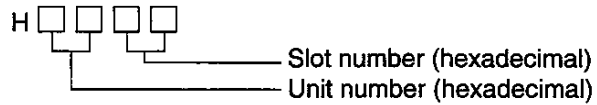

Unit number	Hexadecimal
0	00H
1	01H
2	02H
3	03H

Slot number	Hexadecimal
0	00H
1	01H
2	02H
3	03H
4	04H
5	05H
6	06H
7	07H
8	08H
9	09H
10	0AH

*** 2) The READ instruction will become an error in the following cases (setting S0051). No data will be transferred in error.**

- When the operand A is other than a constant or XW/YW register.
- When the specified module has been disconnected.
- When the no answer error occurs with the specified module.
- When the number of words transferred exceeds 256 words.
- When the source of transfer is out of the range specified.
(address + size exceeds the limit)
- When the destination of transfer is out of the range specified.
(address + size exceeds the limit)

F AD318/AD328/AD338

F.1 Overview

The AD318/AD328/AD338 are 8-channel analog input modules for T3/T3H.

They have the following features.

- 8 channels per module
- 12-bit resolution
- High-speed conversion (2.45 ms/8 channels)
- Isolated each channel

Type	Input range
AD318	Voltage input 0 to 5 V
AD328	Current input 0 to 20 mA
AD338	Voltage input -10 to 10 V

F.2 Specifications

Item	AD318	AD328	AD338
Input range	0 to 5 V	0 to 20 mA	-10 to 10 V
Input impedance	500 k Ω or more	250 Ω	500 k Ω or more
Input channels	8 channels (X 8W)		
Isolation	Isolated between each channel by transformer		
Conversion cycle	2.45 ms / 8 channels		
Converted data	0 to 4000	0 to 4000	-2000 to 2000
Resolution	12-bit (0.025 %)		
Allowable input	Within ± 13 V	Less than 30 mA	Within ± 13 V
Accuracy	± 0.2 % (at 25 $^{\circ}$ C)		
Temperature drift	± 100 ppm/ $^{\circ}$ C		
Withstand voltage	500 Vac for 1 minute		
Consumed current	600 mA (5 Vdc)		

Appendix

F.3 Input terminals

No.	Symbol	Function
1	SH1	Input channel 1
2	P1	
3	(IC)	
4	N1	
5	SH2	Input channel 2
6	P2	
7	(IC)	
8	N2	
9	(NC)	
10	(NC)	
11	SH3	Input channel 3
12	P3	
13	(IC)	
14	N3	
15	SH4	Input channel 4
16	P4	
17	(IC)	
18	N4	
19	(NC)	
20	(NC)	
21	SH5	Input channel 5
22	P5	
23	(IC)	
24	N5	
25	SH6	Input channel 6
26	P6	
27	(IC)	
28	N6	
29	(NC)	
30	(NC)	
31	SH7	Input channel 7
32	P7	
33	(IC)	
34	N7	
35	SH8	Input channel 8
36	P8	
37	(IC)	
38	N8	

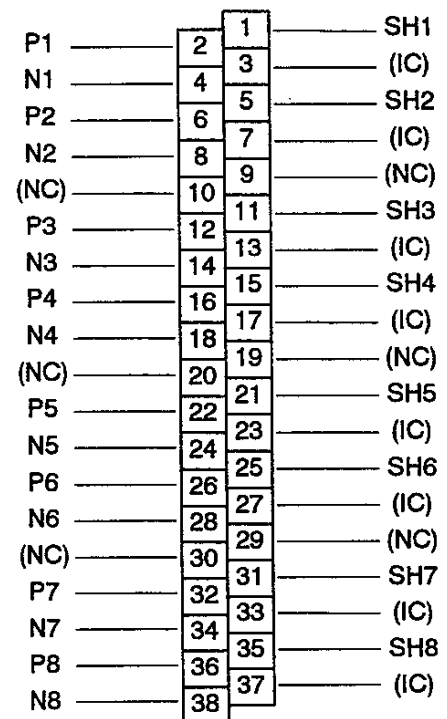

SH_n : Shield of channel *n*
P_n : Positive input of channel *n*
N_n : Negative input of channel *n*
(IC) : Internally connected (do not connect any wire)
(NC) : No connection (do not connect any wire)

F.4 Wiring

(1) Voltage input (AD318/AD338)

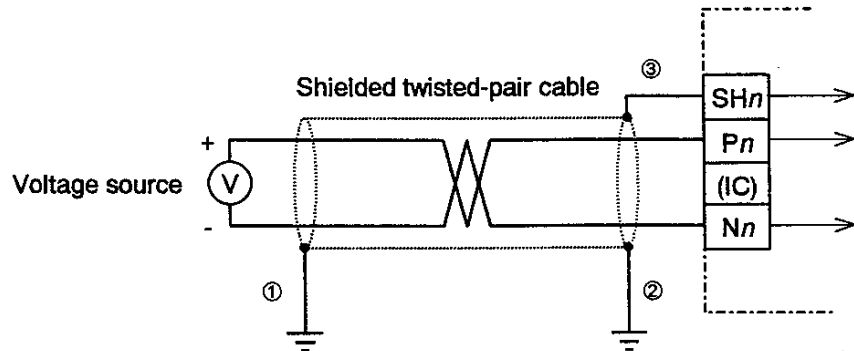

(2) Current input (AD328)

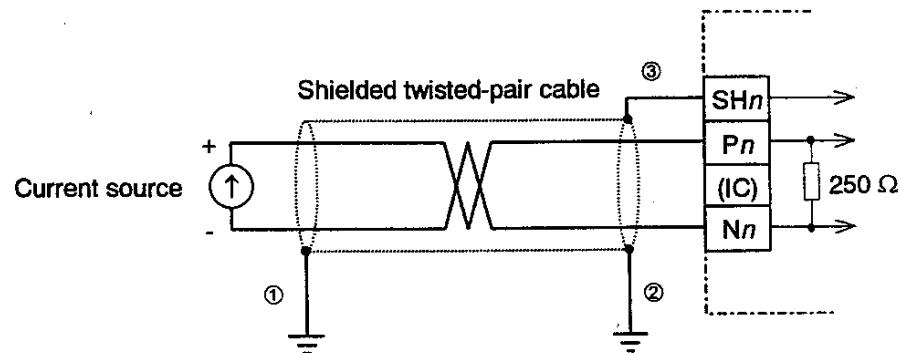

The cable shield should be connected to ground as above ①, ② or ③, or combination of them for stability of input signal.

Appendix

F.5 Register assignment and Converted data

Module type for I/O allocation is "X 8W". Eight (8) input registers (XW) are assigned to the module.

- XW_n ... Channel 1
- XW_{n+1} ... Channel 2
- XW_{n+2} ... Channel 3
- XW_{n+3} ... Channel 4
- XW_{n+4} ... Channel 5
- XW_{n+5} ... Channel 6
- XW_{n+6} ... Channel 7
- XW_{n+7} ... Channel 8

Data format (AD318/AD328):

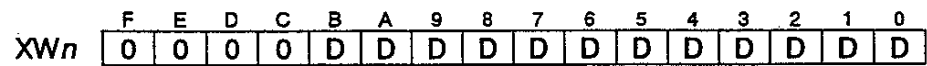

D: data bit

Analog input		Converted digital value	Remarks
AD318 (V)	AD328 (mA)		
5.02500	20.100	4020	Upper limit
:	:	:	
5.00000	20.000	4000	Full scale
4.99875	19.995	3999	
:	:	:	
0.00125	0.005	1	
0	0	0	

Data format (AD338):

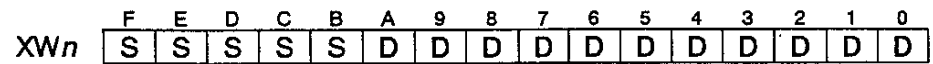

D: data bit

S: sign bit (0 when positive, 1 when negative)

Analog input AD338 (V)	Converted digital value	Remarks
10.050	2010	Upper limit
:	:	
10.000	2000	Full scale
9.995	1999	
:	:	
0.005	1	
0	0	
-0.005	-1	
:	:	
-9.995	-1999	
-10.000	-2000	
:	:	
10.050	2010	Lower limit

TOSHIBA

TOSHIBA INTERNATIONAL (EUROPE) LTD.

1 Roundwood Avenue
Stockley Park, Uxbridge
Middlesex UB11 1AR, ENGLAND
Tel: 081 848 4466 Fax: 081 848 4969
Tlx: 265062 TSB LDN G Cable: Toshibaic London.

TOSHIBA INTERNATIONAL CORPORATION

Industrial Equipment Division
13131 West Little York Road
Houston, Texas 77041, U.S.A.
Tel: 713-466-0277 1-800-231-1412 Telex: 762078

TOSHIBA INTERNATIONAL CORPORATION PTY. LTD.

Unit 1,9 Orion Road, Lane Cove
N.S.W. 2066, AUSTRALIA
Tel: 02-428-2077 Telex: AA25192

TOSHIBA CORPORATION

Industrial Equipment Department
1-1, Shibaura 1-chome, Minato-ku, Tokyo 105, Japan
Tel: (03)3457-4900
Cable: TOSHIBA TOKYO

Free Manuals Download Website

<http://myh66.com>

<http://usermanuals.us>

<http://www.somanuals.com>

<http://www.4manuals.cc>

<http://www.manual-lib.com>

<http://www.404manual.com>

<http://www.luxmanual.com>

<http://aubethermostatmanual.com>

Golf course search by state

<http://golfingnear.com>

Email search by domain

<http://emailbydomain.com>

Auto manuals search

<http://auto.somanuals.com>

TV manuals search

<http://tv.somanuals.com>