

# APG001Z Interface Card Option Addendum

This document is an addendum to the **APOGEE® FLN Option Unit Instruction Manual #E6581541**. Because the VF-PS1 is built on the same platform as the **Q9 ASD**, it is recommended that this document be used in conjunction with the **Toshiba Q9 ASD Installation and Operation Manual (P/N 59445)**. *The Q9 ASD Installation and Operation Manual* may be acquired from the **Toshiba.com/ind** web site (click Drives\Q9 LV Variable Torque HVAC\Manuals).

For safety and application-specific reasons, some ASD installations will warrant that the operator not be in the vicinity during ASD operation or that the ASD control be executed remotely. The **APG001Z** interface card is an optional circuit board that is mounted internal to the ASD and is used to facilitate communication with the host via the **Floor Level Network (FLN)** protocol.

Using the **APG001Z** interface card the **Q9 ASD** may be monitored and controlled remotely. The **APG001Z** interface card has a built-in FLN communication driver and point database which allows the **Q9 ASD** to communicate over the **APOGEE®** network with other FLN devices.

The **APG001Z** is simple to install and is ideally suited for use in fan and pump control applications, and in similar equipment.

## Installation/Operation Precautions

Install the **Q9 ASD** securely in a well ventilated area that is out of direct sunlight. The control interface ambient operating temperature is 14° – 104° F (-10° – 40° C).

Installation instructions for the **APG001Z** interface card is described in the **APOGEE® FLN Instruction Manual #E6581541**.

- Installation is to be performed by **Qualified Personnel** only as defined in the *Q9 ASD Installation and Operation Manual*.
- Setup parameters require that the Direct Access function be used to access the setup parameters and that the **Unknown Numbers** feature of the ASD be set to **Enabled**.
- Ensure that the **Q9 ASD** mounting location is easily accessible by the user.
- Avoid installation in areas where vibration, heat, humidity, dust, metal particles, or high levels of electrical noise (EMI) are present.
- Do not install the system where it may be exposed to flammable chemicals or gasses, water, solvents, or other fluids.
- Turn the power on to the **Q9 ASD** only after securing the **APG001Z** and the ASD front cover.

## Contact Information

Toshiba's Customer Support Center can be contacted to obtain help in resolving any Adjustable Speed Drive system problem that you may experience or to provide application information.

The center is open from 8 a.m. to 5 p.m. (CST), Monday through Friday. The Support Center's toll free number is US (800) 231-1412/Fax (713) 937-9349 — Canada (800) 527-1204.

You may also contact Toshiba by writing to:

Toshiba International Corporation  
13131 West Little York Road  
Houston, Texas 77041-9990  
Attn: ASD Product Manager.

**TOSVERT VF-PS1 series**

---

**APOGEE® FLN option unit Instruction Manual**

---

**APG001Z**

---

**NOTICE**



1. Make sure that this instruction manual is delivered to the end user of APOGEE® FLN option unit.
2. Read this manual before installing or operating the APOGEE® FLN option unit. Keep it in a safe place for reference.
3. All information contained in this manual are subject to change without notice. Please confirm the latest information on our web site "[www.inverter.co.jp](http://www.inverter.co.jp)".

## Safety precautions

On the inverter and in its instruction manual, important information is contained for preventing injuries to users, damages to assets, and for proper use of the device.

Read the instruction manual attached to the inverter along with this instruction manual to completely understand the safety precautions, the symbols and indications shown below. Please adhere to the contents of these manuals at all times.





### Explanation of markings

Marking	Meaning of marking
 Danger	Indicates that errors in operation may lead to death or serious injury.
 Warning	Indicates that errors in operation may lead to injury (*1) to people or that these errors may cause damage to physical property. (*2)

(\*1) Such things as injury, burns or shock that will not require hospitalization or long periods of outpatient treatment.

(\*2) Physical property damage refers to wide-ranging damage to assets and materials.



### Meanings of symbols

Marking	Meaning of marking
	Indicates prohibition (Do not do it). What is prohibited will be described in or near the symbol in either text or picture form.
	Indicates something mandatory (must be done). What is mandatory will be described in or near the symbol in either text or picture form.
	Indicates danger. What is dangerous will be described in or near the symbol in either text or picture form.
	Indicates warning. What the warning should be applied to will be described in or near the symbol in either text or picture form.

■ Limitation of use



<b>⚠ Safety precaution</b>	
▼ Never use this unit with any device other than TOSVERT VF-PS1 series inverters. Doing so may cause an accident.	

■ Handling in general



<b>⚠ Danger</b>	
 Never Disassemble	▼ Never disassemble, modify or repair the product. Disassembling the product may cause electric shocks, fire or injuries. For repairs, call your sales/repair agency.
 Prohibited	▼ Do not open the front cover on the inverter while the inverter power is on. It may lead to electric shocks. ▼ Do not remove this option from VF-PS1 while the power is on. It may lead to electric shocks. ▼ Do not put or insert foreign objects such as waste cable, bars or wires into the product. It may lead to electric shocks or fire. ▼ Do not splash water over the product, and do not wipe the body with a wet cloth. It may lead to electric shocks or fire.
 Mandatory	▼ Turn off the power immediately in case of any abnormalities such as smoke, smell or abnormal noise. Neglect of these conditions may lead to fire. For repairs, call your sales/repair agency. ▼ Do not touch the sharp portions (such as leads of parts on the board, the corner of board, or etc.) on this option. It may lead to injuries.

<b>⚠ Warning</b>	
 Mandatory	▼ This option is an electrostatic discharge sensitive device. Handle it, where the environment is protected against electrostatic electricity. Otherwise, permanent damage to device will result.



■ Transportation and installation



<b>⚠ Danger</b>	
 Prohibited	▼ Do not apply a dropping shock or other physical shocks. Otherwise, damage or malfunction will result. ▼ Do not install or operate the inverter if it is damaged or any part of it is missing. Operating a defective inverter may lead to electric shocks or fire. For repairs, call your sales/repair agency. ▼ Do not put any flammable material near the product. It may catch fire due to the product sparking in the case of a malfunction.
 Mandatory	▼ Use this product under the environmental conditions prescribed in the instruction manual. Usage it under any other conditions may result in malfunction. ▼ An emergency stop device must be installed that fits with system specifications (e.g. shut off input power then engage mechanical brake). Operation cannot be stopped immediately by the inverter or this unit alone, thus risking an accident or injuries. ▼ Install this option into VF-PS1 and secure it by tightening the terminal board fixing screws to the specified torque. Otherwise, it may cause the product falling, the damage, or malfunctions. ▼ Install insulated sheet (attached) under this option. Otherwise, permanent damage to device will result.

■ **Wiring**



 <b>Warning</b>	
 Mandatory	<ul style="list-style-type: none"> <li>▼ Electrical construction work must be done by a qualified expert. Connection of input power by someone who does not have expert knowledge may result in electric shocks or fire.</li> <li>▼ Turn off input power before wiring. Wait at least 15 minutes and make sure that the charge lamp (on the inverter unit) is no longer lit. Otherwise, it may lead to electric shocks.</li> <li>▼ Tighten the screws on the terminal blocks to the specified torque when connecting cables to terminal blocks. Otherwise, it may lead to fire.</li> </ul>

■ **Operations**

 <b>Danger</b>	
 Prohibited	<ul style="list-style-type: none"> <li>▼ Do not pull on the cable and connector. It may cause damage or malfunctions.</li> </ul>
 Mandatory	<ul style="list-style-type: none"> <li>▼ Use this option under the environment specified in the instruction manual. Usage under the environment other than them may cause damages or malfunctions or an accident.</li> <li>▼ Use an additional safety device with your inverter or system to prevent a serious accident due to the unit malfunctions. Usage without an additional safety device may cause an accident.</li> </ul>

 <b>Warning</b>	
 Mandatory	<ul style="list-style-type: none"> <li>▼ Set up "Communication error trip function (see below)" to stop the inverter when the option unit is deactivated by an unusual event such as an operating error, power outage, failure, etc.                             <ul style="list-style-type: none"> <li>- Network time-out (F832)</li> </ul>                             (See the VF-PS1 APOGEE® FLN Communication Function Manual for details.)                              Deactivated option unit may cause an accident, if the "Communication error trip function" is not properly set up.                         </li> <li>▼ Make sure that the operation signals are STOP before resetting inverter's fault. The motor may suddenly start and that may result in injuries.</li> </ul>

■ **Disposal**

 <b>Warning</b>	
 Mandatory	<ul style="list-style-type: none"> <li>▼ If you dispose off this unit, have it done by a specialist in industrial waste disposal*. Improper disposal may result in explosion of capacitors or produce noxious gases, resulting in injuries.                              (*) Persons who specialize in the processing of waste and known as "Industrial Waste Product Collectors and Transporters" or "Industrial Waste Disposal Persons." If the collection, transport and disposal of industrial waste is done by someone who is not licensed for that job, it is a punishable violation of the law (Laws in regard to cleaning and processing of waste materials).</li> </ul>

■ **Notes on operation**

<b>Notes</b>	
	<ul style="list-style-type: none"> <li>▼ Avoid installing in a place where ambient temperature or/and humidity change sharply.</li> <li>▼ Keep the transmission cable separate from the power cable of the inverter to prevent the inverter from malfunctioning due to electromagnetic noise.</li> <li>▼ Ground of SCR terminal on this option at the grounding terminal separated from those of inverters and motors. It may cause malfunction due to noise.</li> </ul>

Preface

Thank you for purchasing the "APOGEE® FLN option (APG001Z)" for TOSVERT VF-PS1 inverter. By installing this board into the VF-PS1, data communication can be made with a host computer or other device via APOGEE® FLN network.

Before using this unit, carefully read this instruction manual in order to completely and correctly utilize excellent performance of this unit. Besides this instruction manual, the "APOGEE® FLN option Function Manual" which includes the contents to install into APOGEE® FLN network is prepared. If it is required, please contact with our branch offices, sales offices or web site "www.inverter.co.jp".

("APOGEE® FLN option Function Manual": E6581542)

After reading this instruction manual, please keep it handy for future reference.

\* APOGEE® FLN is a registered trademark of Siemens Building Technologies, Inc.

- Part numbering

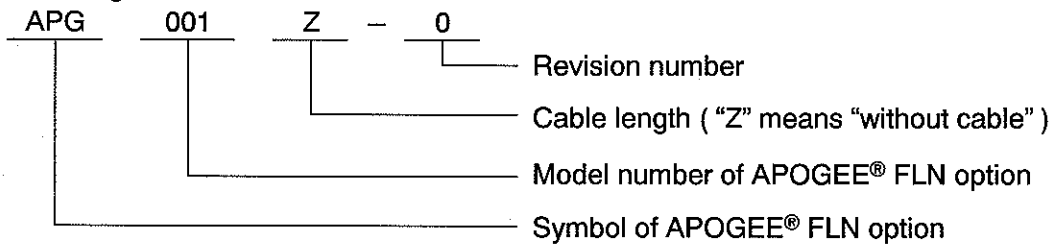

- Accessory check list

APOGEE® FLN communication option is shipped together with the following accessories. On opening the packing case, check to see if the following accessories are contained or not.

- (1) APOGEE® FLN option (APG001Z)..... 1 board

Connector: MSTB2.5/4-STF-5.08

Manufactured by PHOENIX CONTACT

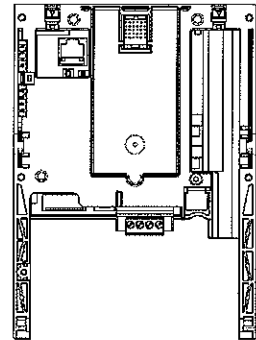

- (3) Instruction manual for the VF-PS1 APOGEE® FLN option .....1 copy

( English: E6581541  
 (This manual)



- (4) LED name label

1 sheet



---

**Table of Contents**

---

1. Overview .....	6
2. Names and functions .....	6
2.1. Outline .....	6
2.2. APOGEE® FLN Connector .....	6
2.3. LED indicator .....	7
3. Installing the APG001Z .....	8
3.1. Case of installing two options .....	9
3.2. Network cable connection .....	9
3.3. Network configuration .....	10
4. Parameters .....	11
4.1. Communication parameters .....	11
5. Command & Setpoint selection (Local/Remote) .....	12
6. Specifications .....	14
7. Warranty .....	14

# 1. Overview

The APOGEE® FLN interface (APG001Z) allows the VF-PS1 inverter to be connected into a APOGEE® FLN network.

# 2. Names and functions

The drawing below shows names and functions of main parts.

## 2.1. Outline

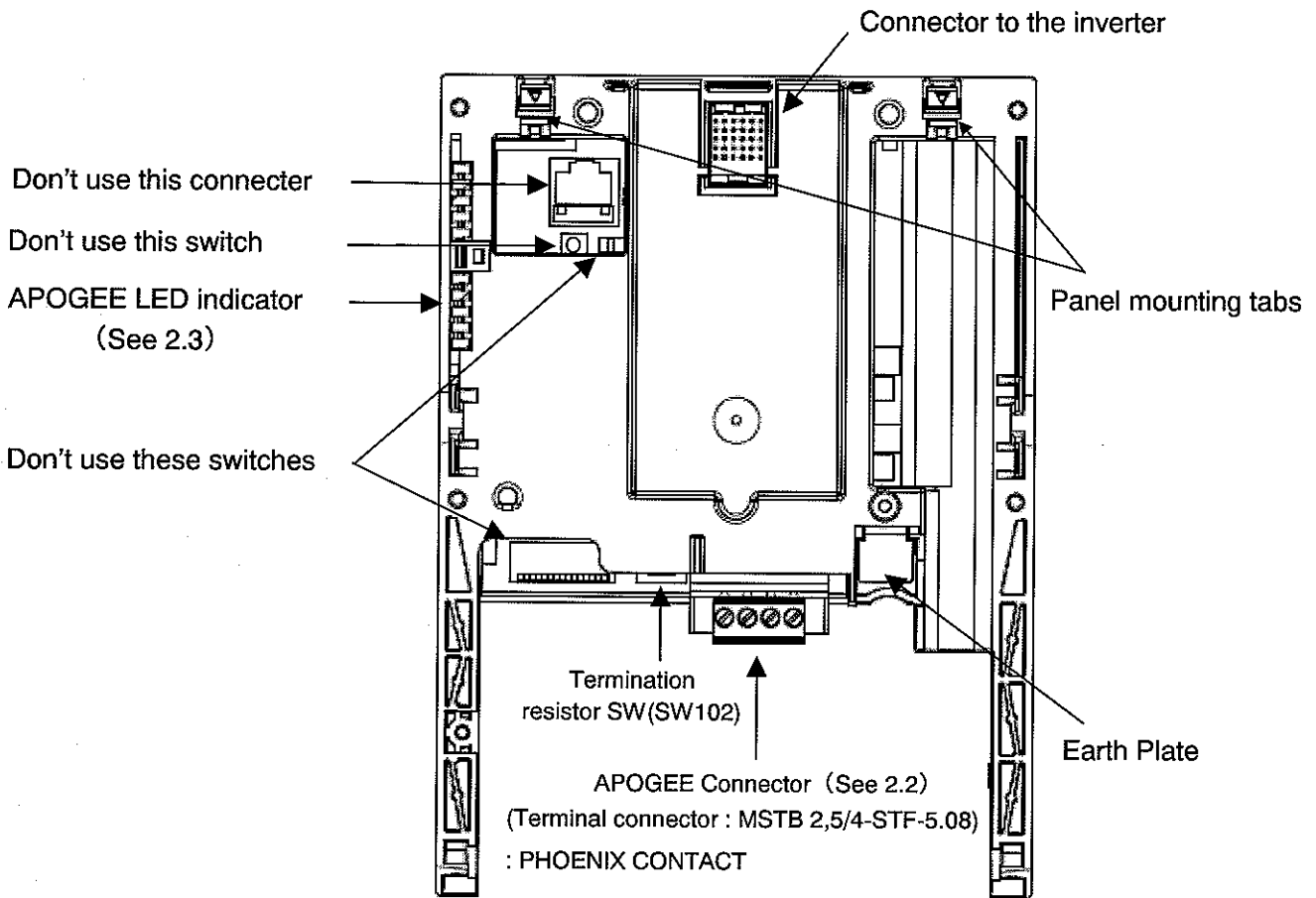

## 2.2. APOGEE® FLN Connector

Terminal symbol	Function	Electrical specifications	Internal circuits
B	APOGEE® FLN communication signal EIA-485	Communication signal (+)	
A		Communication signal (-)	
GND		Signal common	
SCR		Shield terminal.	



2.3. LED indicator

The LED shows the present status of the network and error.

Layout of LED

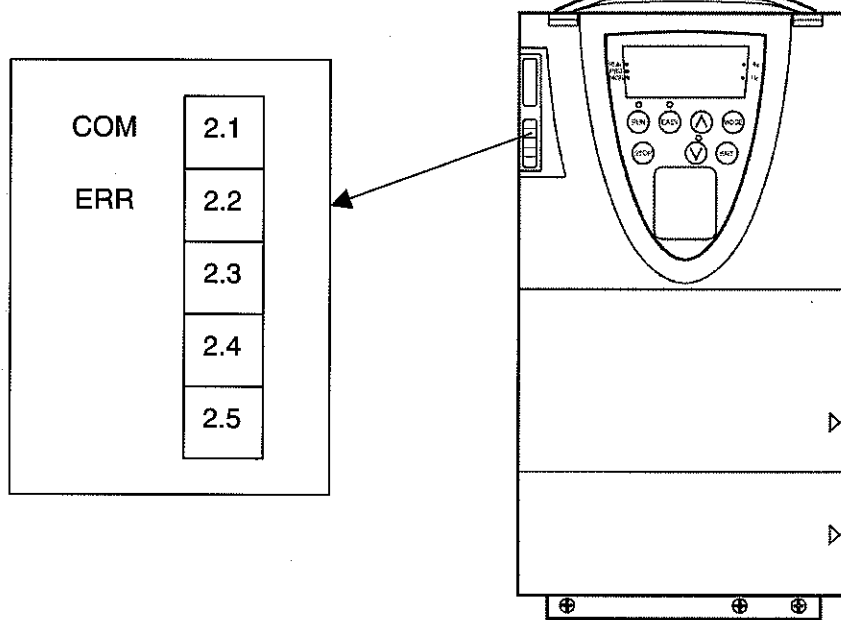

The option has two LEDs. Those function are below table.

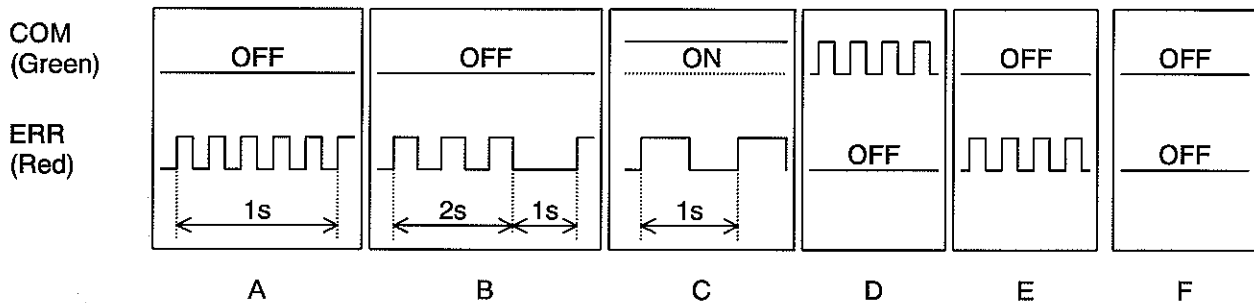

State	LEDs	Comment
A	COM LED: OFF ERR LED: Flashing 5 times in 1 second	APG001Z failure.
B	COM LED: OFF ERR LED: 3 times in 2 seconds, Off for 1 second	Communication loss was detected. Confirm the network condition and connection of the cable.
C	COM LED: ON ERR LED: OFF 0.5s, ON 0.5s	Invalid configuration was detected. (Note)When inverter occurred in E-23 or E-24, the LED becomes this state.
D	COM LED: Flashing ERR LED: -	Valid message was received for this node
E	COM LED: - ERR LED: Flashing	Invalid message was received (any node)
F	COM LED: OFF ERR LED: OFF	No communication Confirm the network condition and connection of the cable.

### 3. Installing the APG001Z

Install the APOGEE® FLN option to VF-PS1 as follows.



Mandatory

Turn off the input power of VF-PS1 and wait for at least 15 minutes and then check that the CHARGE lamp on VF-PS1 is no longer lit.

- (1) Turn off input power of VF-PS1 and wait for at least 15 minutes and then check that the CHARGE lamp on VF-PS1 is no longer lit.
- (2) Securing the option to the inverter
  - a) Insert a flat-blade screwdriver in each of the two holes at the upper part of the front panel, release the panel mounting tab by pushing the screwdriver down and remove the front panel cover.
  - b) Install the option in the inverter by fitting the tabs on the lower side the option into the slots at the lower part of the inverter front panel.
  - c) Make sure the option is securely attached to the inverter. Then check whether the plastic bosses on the inverter case have fitted in the holes at the upper and lower parts of the option.
  - d) Insert the tabs at the lower part of the front cover into the slots at the lower part of the inverter to attach the front cover to the inverter.
  - e) Stuck the enclosed "LED name label" in the option LED display part of a front cover.

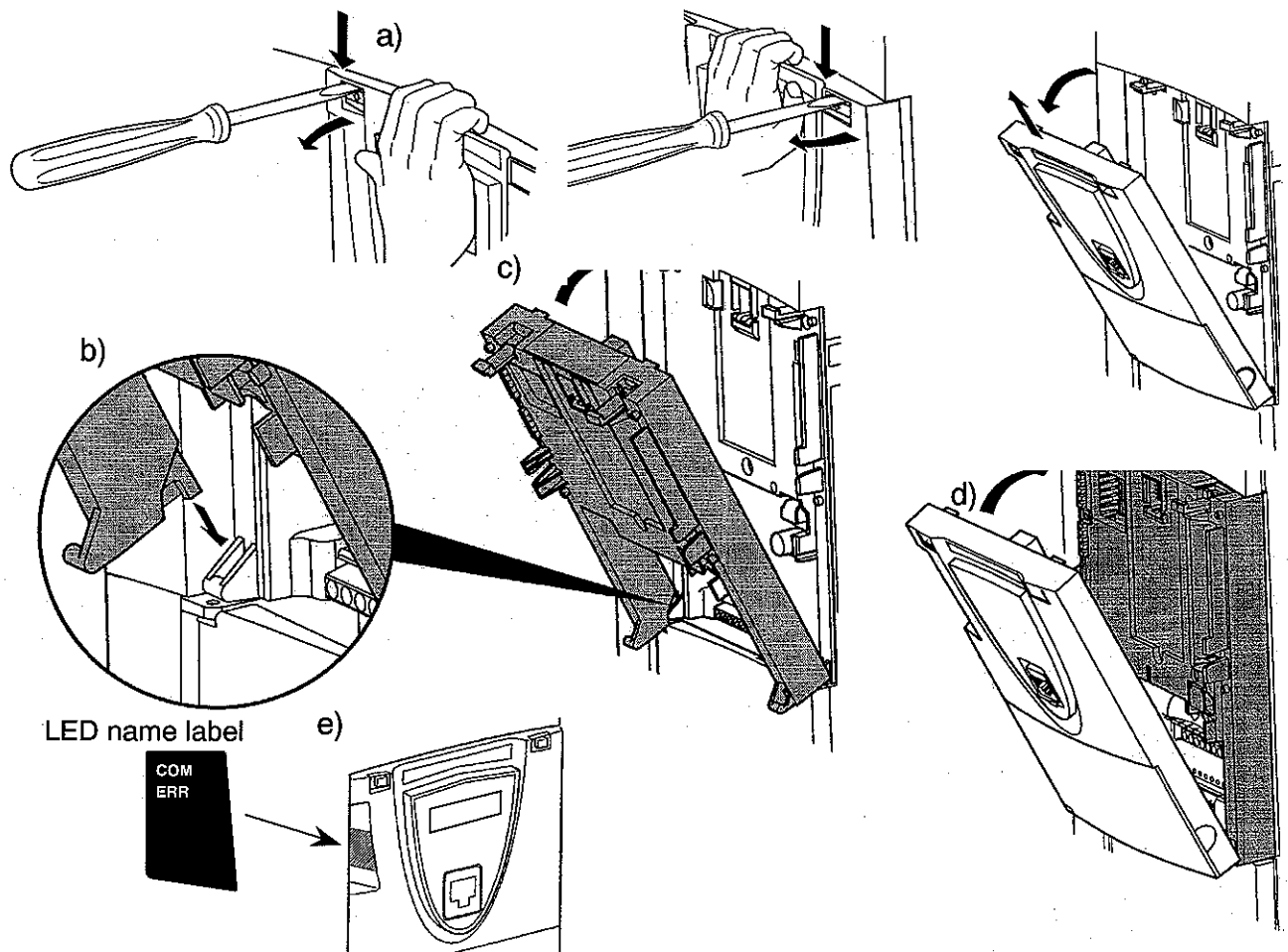

**3.1. Case of installing two options**

Please install this option (APG001Z) on the top of options when you install two options.  
Do not install under the another option.

**3.2. Network cable connection**

Connect the APOGEE® FLN network cable to communication option as follows.

Title	Description
Wire type	Shielded twisted cable
Characteristic impedance	Between 100 and 130 ohm
Distributed impedance between conductors	Less than 100pF per meter
Distributed impedance between conductors and shield	Less than 200pF per meter Foil or braided shield are acceptable.
Length of a segment	1200 meters with AWG18 (0.8mm <sup>2</sup> )

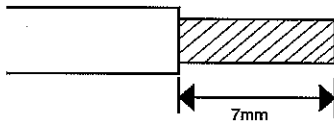

Cable sheath should be peeled off by about 7mm.

For wiring work, use a flat blade screwdriver with a 0.6mm thick and 3.5mm width blade.

Tightening torque for the terminal block is 0.5Nm.

\* Fix a cable so that a communication connector may be not taken the weight of wire.

### 3.3. Network configuration

Make up the network as follows.

- Transmission/reception signals (A, B)

Make up the communication path by connecting all transmission/reception data cables.

- Signal common (GND)

GND is the signal common.

- Grounding the shield of cable (SCR)

Connect the all shield lines of network cable. The shield shall be grounded at one end only prevent currents from being created.

- Termination resistor

A termination resistance of 120 ohms plus or minus 5% shall be connected at each of the two ends of the segment medium. This option has a termination resistor, so if use, set up the termination resistor SW. (Refer to 2.1 Outline)

\* It is recommended that the Siemens Building Automation FLN Trunk Terminator (PN: 538-664) be used and that the network termination switch on the APG001Z, SW102, be set to OFF.

At least one set, and no more than two sets, of network bias resistors shall exist for each segment.

This option has local bias resistors.

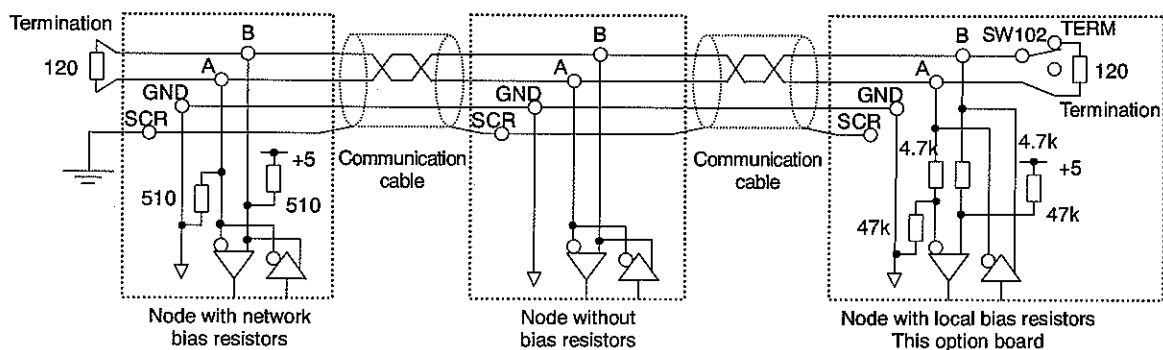

**N.B.:** Do not connect the SCR terminal to the power ground of inverters or other units.

Keep the network cables 20cm or more separate from the power cables to prevent from malfunctioning due to electromagnetic noise.

## 4. Parameters

### 4.1. Communication parameters

Set up the inverter parameters as follows. To update, reset of inverter. If these parameters are not set to correct value, this unit can not work normally.

Title	Communication No.	Function	Description	Factory setting
<i>F831</i>	0831	Network Baudrate (*1)	0: 9600bps,1: 4800bps,2: 9600bps 3: 19200bps,4: 38400bps, 5: 57600bps,6: 76800bps Over 7 is 9600bps.	0000
<i>F832</i>	0832	Network Time-Out (*1)	0: No action Unit 0.1 sec, Setting range: 1 – 1000 Over 1000 is 100.0s.	0000
<i>F833</i>	0833	Factory setting (*1)	Except ACh : Reset to factory setting ACh : Finished with reset to factory setting	0000 (ACh)
<i>F834</i>	0834	Station address	1-99 The range outside is converted into 99	0000
<i>F851</i>	0851	Operation at communication error by disconnection	0: Inverter stop, communication command, frequency mode open (by <i>CNOd</i> , <i>FNOd</i> ) 1: None (continued operation) 2: Deceleration stop 3: Coast stop 4: Network error ( <i>ErrB</i> trip) 5: Preset speed operation (by <i>F852</i> setting)	0
<i>F852</i>	0852	Preset speed operation selection	0:None 1~15:Preset speed operation (by parameter setting)	0
<i>F853</i>	0853	Communication option station address monitor (Read Only)	Real station address monitor If a value of <i>F834</i> is out of a range, the value of <i>F853</i> becomes 99.	—
<i>F899</i>	0899	Network option reset setting	0:None 1:Reset option circuit board and inverter	0
—	FE66	Add-on option 1 CPU version(Under side option)	High byte is version. Low byte is version. For example, When version number 1, and revision number 2 is, panel indication becomes with 1.02. The version of the option with it has equipped can be checked by using the function of <i>F710</i> to <i>F718</i> (standard monitor display selection).	—
—	FE67	Add-on option 2 CPU version(Panel side)	*For details, refer to the inverter instruction manual.	—

\* When *FNOd* or *CNOd* is set to "Communication option input", VF-PS1 drives without FLN LOC REF (LDO point #69) or FLN LOC CTL (LDO point #68) at each Objects.

(\*1): This parameter is effective by reset. Please reset (power supply reset or *F899*= 1) after changing a set point.

## 5. Command & Setpoint selection (Local/Remote)

Indication to display Local/Remote mode is on the inverter unit (Refer to the inverter instruction manual for details). APOGEE® FLN option command and setpoint are activated on Remote mode.

Inverters have some switches to select the command and setpoint location. Following figure shows the diagram. Refer to the inverter instruction manual for the parameter in detail.

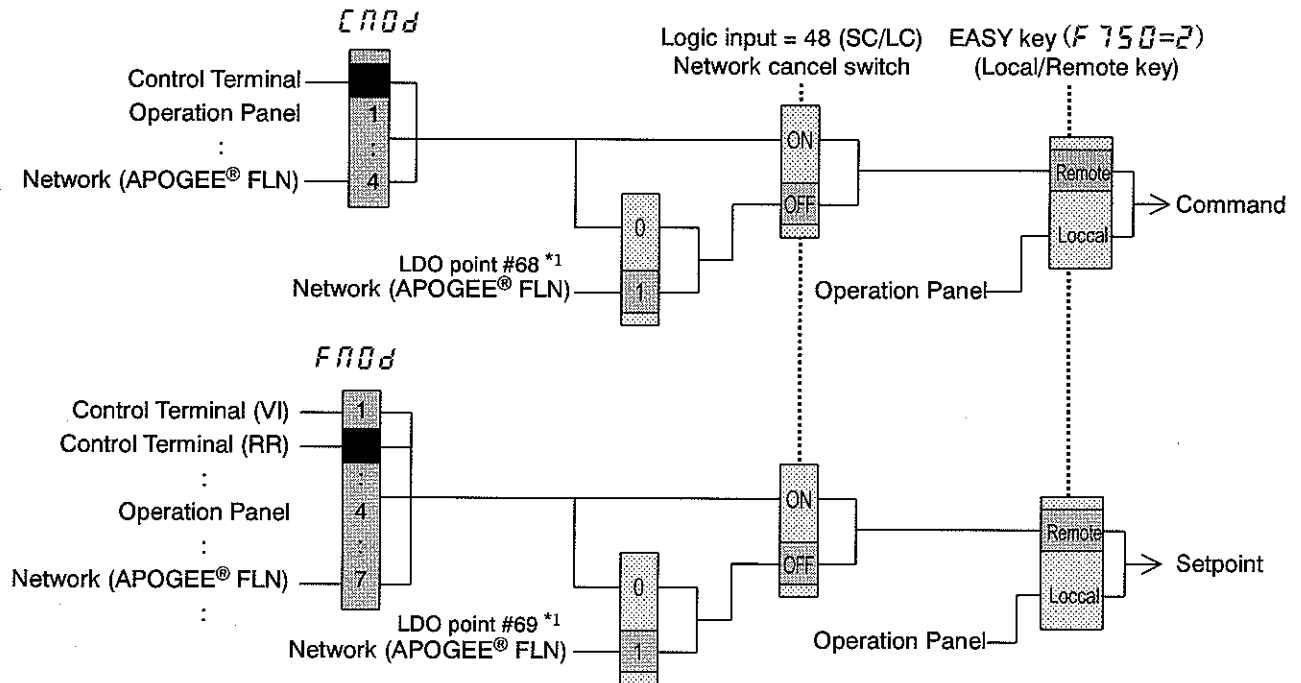

\*1 Be careful that **CPOd** command and **FPOd** setpoint are activated for a short time just after the inverter power turned on. Set **CPOd** and **FPOd** to "network" to prevent this problem.

<Example>

The example below shows how to configure the VF-PS1 for local/remote operation.

- F terminal ..... Operating command
- R terminal ..... The APOGEE® FLN local/remote (Terminal in this example) switching
- RR/S4 terminal ..... Operation frequency command

<Wiring>

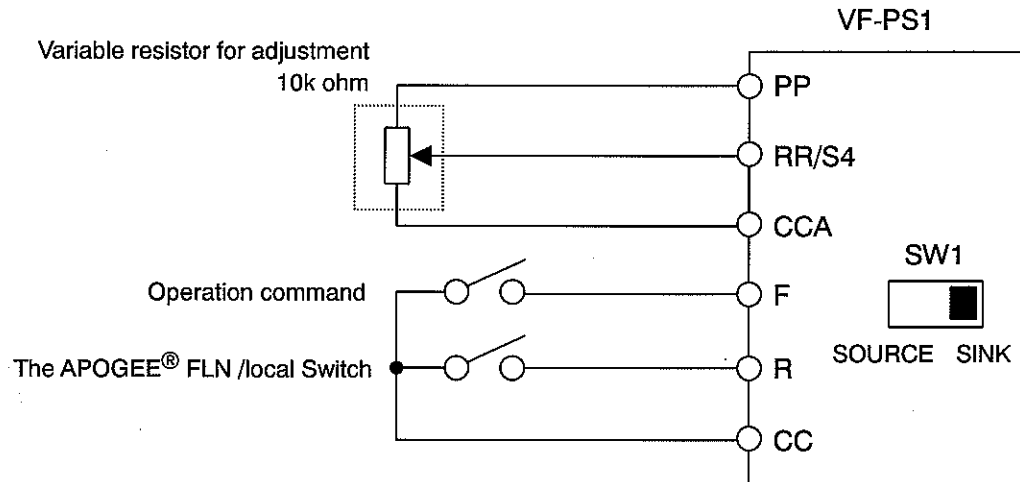

<Parameter setting>

- $CMD$  (Command mode selection) = 0 (Terminal board)
- $FMD$  (Frequency setting mode selection 1) = 2 (RR/S4)
- $F12$  (Input terminal selection 2 (R)) = 48 (Remote/Local control)

<Operation>

- R-CC terminal open: VF-PS1 is controlled as a slave device of The APOGEE® FLN.
- R-CC terminal closed:
  - F-CC terminal short to RUN
  - F-CC terminal short to STOP
  - Output frequency is set up by the RR/S4 signal input.

(Note)

When the local(HAND) / remote key ( $F750=2$ ) is chosen as EASY key selection and the EASY key lamp of an inverter front panel is on, priority is most given to operation by a panel. (Refer to the inverter instruction manual for details).  
 Note that the HAND mode of the panel has priority over FLN local control.

## 6. Specifications

### < Environmental specification >

Item	Specification
Model number	APG001Z
Service environment	Conforms to VF-PS1
Ambient temperature	Conforms to VF-PS1
Storage temperature	Conforms to VF-PS1
Relative humidity	Conforms to VF-PS1
Vibration	Conforms to VF-PS1
Power supply	24VDC supplied from the inverter

### <APG001Z network specification >

Item	Specification
Station type	Remote device station
Number of occupied stations	1 station occupied by 1 unit
Maximum FLN device	32 FLN devices to each FLN port of the Field Cabinet.
Communication baud rate	4800, 9600, 19200, 38400, 57600, 76800bps
Bias resistor and termination	Local bias resistors are mounted. Termination resistor (120 ohm) can be select by SW.
Terminal block	Detachable terminal block 4-pole (5.08mm pitch) Manufacturer: PHOENIX CONTACT Type-Form : MSTB 2,5/4-STF-5.08

## 7. Warranty

Any part of APOGEE® FLN communication option that is proved to be defective will be repaired free of charge under the following conditions:

1. This product will be repaired free of charge, if problem/fault occurs under normal handling within one year of delivery and is caused obviously by a design or manufacturing defect.
2. The warranty applies only to the delivered product.
3. For the following kinds of failure or damage, the repair cost shall be borne by the customer even within the warranty period.
  - i) Failure or damage caused by improper or incorrect use or handling, or unauthorized repair or modification of the inverter.
  - ii) Failure or damage caused by the unit falling or an accident during transportation after the purchase.
  - iii) Failure or damage caused by fire, salty water or wind, corrosive gas, earthquake, storm or flood, lightning, abnormal voltage supply, or other natural disasters.
  - iv) Damage due to the use of APOGEE® FLN communication option for non-intended purposes.
4. If an additional warranty is provided then those conditions will also apply.



## Free Manuals Download Website

<http://myh66.com>

<http://usermanuals.us>

<http://www.somanuals.com>

<http://www.4manuals.cc>

<http://www.manual-lib.com>

<http://www.404manual.com>

<http://www.luxmanual.com>

<http://aubethermostatmanual.com>

Golf course search by state

<http://golfingnear.com>

Email search by domain

<http://emailbydomain.com>

Auto manuals search

<http://auto.somanuals.com>

TV manuals search

<http://tv.somanuals.com>