

**TOSVERT VF-AS1/PS1**

---

*DeviceNet* Option Instruction Manual

---

DEV002Z-1

---

**NOTICE**



1. Make sure that this instruction manual is delivered to the end user of the DeviceNet option for the VF-AS1/PS1.
2. Read this manual before installing or operating the DeviceNet option for the VF-AS1/PS1. And keep it in a safe place for reference.

\* The data given in this manual are subject to change without notice.

## Safety precautions

On the inverter and in its instruction manual, important information is contained for preventing injuries to users and damages to assets and for proper use of the device. Read the instruction manual attached to VF-AS1/PS1 along with this instruction manual for completely understanding the safety precautions and adhere to the contents of these manuals.





### Explanation of markings

Marking	Meaning of marking
 Danger	Indicates that errors in operation may lead to death or serious injury.
 Warning	Indicates that errors in operation may lead to injury (*1) to people or that these errors may cause damage to physical property. (*2)





(\*1) Such things as injury, burns or shock that will not require hospitalization or long periods of outpatient treatment.

(\*2) Physical property damage refers to wide-ranging damage to assets and materials.



### Meanings of symbols

Marking	Meaning of marking
	Indicates prohibition (Don't do it). What is prohibited will be described in or near the symbol in either text or picture form.
	Indicates something mandatory (must be done). What is mandatory will be described in or near the symbol in either text or picture form.
	Indicates danger. What is dangerous will be described in or near the symbol in either text or picture form.
	Indicates warning. What the warning should be applied to will be described in or near the symbol in either text or picture form.



## ■ General Operation

 <b>Danger</b>	
 Disassembly prohibited	<ul style="list-style-type: none"> <li>▼ Never disassemble, modify or repair. Doing so could result in electric shock, fire and injury. For repairs, call your sales agency.</li> </ul>
 Prohibited	<ul style="list-style-type: none"> <li>▼ Do not attach this option to any inverter other than the VF-AS1/PS1. Doing so could result in electric shock or fire.</li> <li>▼ When the inverter is energized, never detach the this option from the VF-AS1/PS1. Doing so could result in electric shock.</li> <li>▼ Don't place or insert any kind of object into the DEV002Z (electrical wire cuttings, rods, wires). Doing so could result in electric shock or fire.</li> <li>▼ Do not allow water or any other fluid to come in contact with the DEV002Z. Doing so could result in electric shock or fire.</li> </ul>
 Mandatory	<ul style="list-style-type: none"> <li>▼ Turn off the VF-AS1/PS1 when installing and wiring this option.</li> <li>▼ If the inverter begins to emit smoke or an unusual odor, or unusual sounds, immediately turn power off. If the equipment is continued in operation in such a state, the result may be fire. Call your local sales agency for repairs.</li> </ul>



## ■ Transportation & installation

 <b>Danger</b>	
 Prohibited	<ul style="list-style-type: none"> <li>▼ Do not operate the inverter if it is damaged or any component is missing. Doing so could result in electric shock or fire. Call your local sales agency for repairs.</li> <li>▼ Do not place any inflammable substances near the VF-AS1/PS1 Inverter. If an accident occurs in which flame is emitted, this could lead to fire.</li> <li>▼ Do not install in any location where the inverter could come into contact with water or other fluids. Doing so could result in electric shock or fire.</li> <li>▼ When installing this option, be careful not to touch the leads from parts on the reverse side of its circuit board. Doing so could result in injury.</li> </ul>
 Mandatory	<ul style="list-style-type: none"> <li>▼ Operate under the environmental conditions prescribed in the instruction manual. Operations under any other conditions may result in malfunction.</li> </ul>



## ■ Wiring

 <b>Danger</b>	
 Mandatory	<ul style="list-style-type: none"> <li>▼ Shut off power when installing and wiring this option. Wait at least 15 minutes and check to make sure that the charge lamp (VF-AS1/PS1) is no longer lit.</li> <li>▼ Tighten the screws on the terminal block to the specified torque (Refer to Section 4.1). If the screws are not tightened to the specified torque, it may lead to fire.</li> <li>▼ Electrical construction work must be done by a qualified expert. Installation or connection of input power by someone who does not have that expert knowledge may result in fire or electric shock.</li> </ul>

## ■ Operations

 <b>Danger</b>	
 Prohibited	<ul style="list-style-type: none"> <li>▼ Do not touch switches when the hands are wet and do not try to clean the inverter with a damp cloth. Doing so could result in electric shock.</li> <li>▼ Do not pull on any cable itself. Doing so could result in damage or malfunction.</li> </ul>

## ■ Disposal

 <b>Warning</b>	
 Mandatory	<ul style="list-style-type: none"> <li>▼ For safety's sake, do not dispose of the disused inverter yourself but ask an industrial waste disposal agent (*). If the collection, transport and disposal of industrial waste is done by someone who is not licensed for that job, it is a punishable violation of the law. (Laws in regard to cleaning and processing of waste materials) (* ) Persons who specialize in the processing of waste and known as "industrial waste product collectors and transporters" or "industrial waste disposal persons."</li> </ul>

## Notes on use

<b>Notes</b>	
	<ul style="list-style-type: none"> <li>▼ Do not install the inverter where the temperature or the humidity will change rapidly.</li> <li>▼ Keep a distance of 20cm or more between the inverter's power cable and the data transmission cable. Or the inverter might malfunction because of noise.</li> <li>▼ Insert a magnetic contactor or similar device between the inverter and the power supply to ensure that power is turned off if an emergency stop command is entered through the network.</li> </ul>

## Introduction

Thank you for purchasing a “VF-AS1/PS1 DeviceNet Option (DEV002Z),” for TOSVERT VF-AS1/PS1 inverter. Installing this option in the VF-AS1/PS1 and using it together, data communication can be made with a host computer or other device via DeviceNet. Please read the entire manual carefully before attempting to control your inverter via DeviceNet connection.

Besides this instruction manual, the “DEV002Z Function Manual” is required to develop software communicating with VF-AS1/PS1. In such a case, please get in touch with our branch offices or sales offices. (“DEV002Z Function Manual”: E6581281).

This manual is also aimed at the operator using “VF-AS1/PS1 DeviceNet option”, so please use it for future maintenance and inspection.

### ■ Explanation of model number of DeviceNet™ option

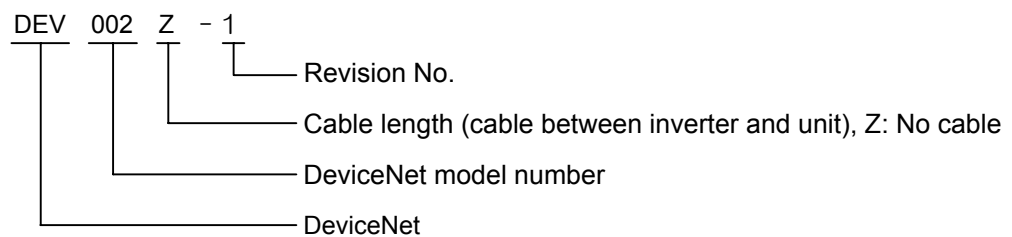

### ■ Check of accessories

DeviceNet option is shipped together with the following items in the package. Contact your sales agency if any of these is missing.

- VF-AS1/PS1 DeviceNet option ..... 1 board  
(DEV002Z)
- DeviceNet open connector ..... 1 pcs.  
(Connected to the DEV002Z)

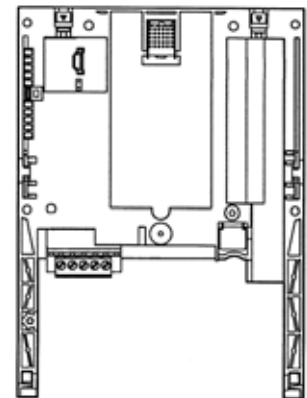

- Instruction manual for the VF-AS1/PS1 DeviceNet option (this manual) ..... 1 copy  
(E6581295)

- LED name label ..... 1 pcs.

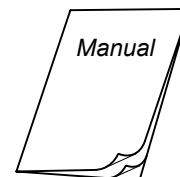
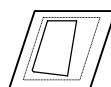

# Contents

---

1. OVERVIEW .....	6
2. EXTERIOR FEATURES.....	7
2.1. DeviceNet connector.....	7
2.2. DeviceNet indicator .....	8
3. INSTALLING THE DEV002Z.....	9
4. CONNECTING TO THE NETWORK .....	10
4.1. Installation method .....	10
4.2. Network Grounding .....	11
4.3. Setting a MAC ID number and a network baud rate .....	12
5. COMMUNICATIONS-RELATED PARAMETERS.....	13
5.1. <i>F851</i> : Communication Loss Action Setting (Network breaks).....	14
5.2. <i>F852</i> : Preset speed operation selection.....	14
5.3. <i>F830</i> : Assembly Object Setting .....	15
6. DEVICENET LOCAL/REMOTE OPERATION .....	18
7. SPECIFICATIONS .....	19
8. WARRANTY .....	19

# 1. Overview

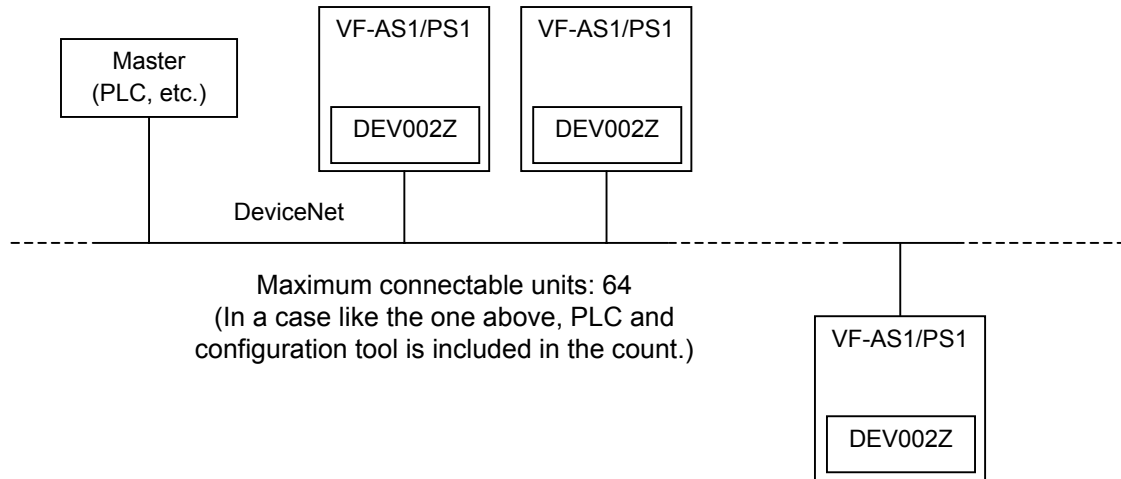

The DEV002Z interface allows the VF-AS1/PS1 inverter to be connected into a DeviceNet network. DeviceNet supports a maximum of 64 nodes, allowing for the Master unit and the configuration tool a maximum of 62 devices can be connected to the network.

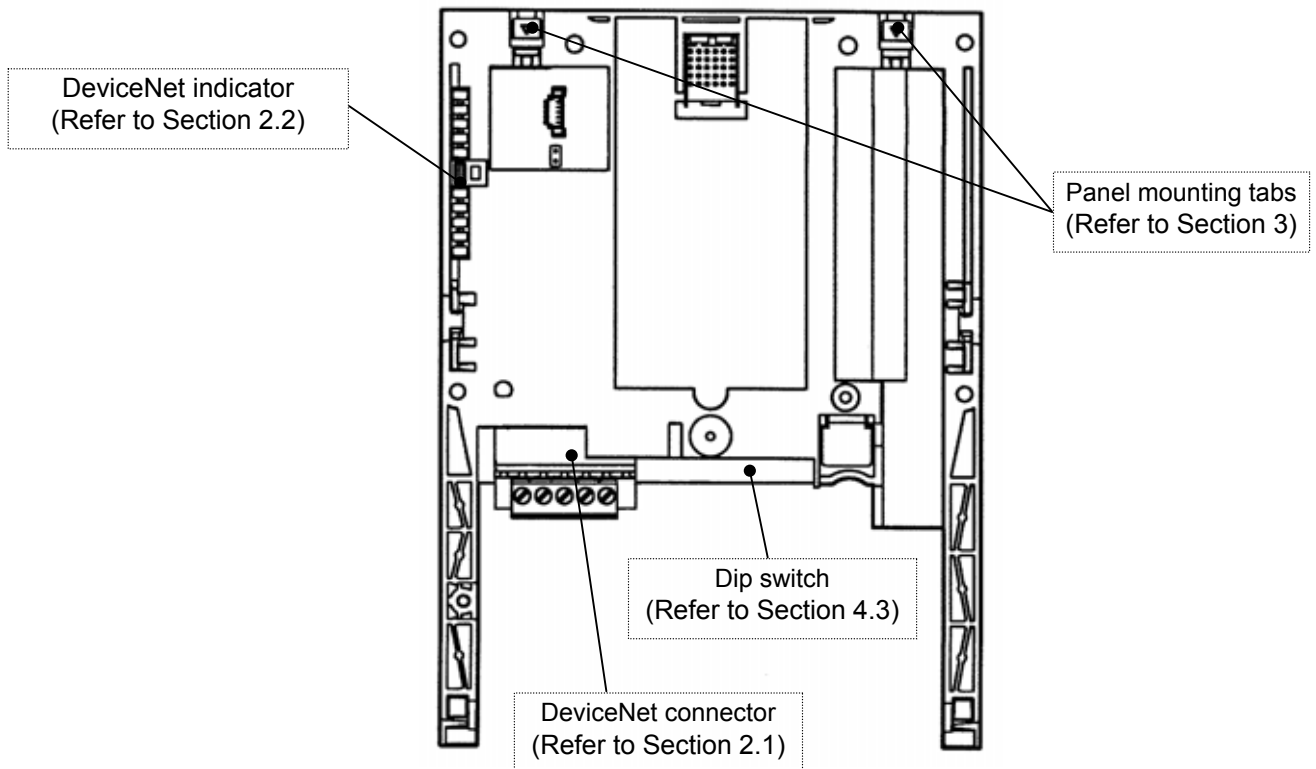

## 2. Exterior features

The external view of this option and the name of each part are shown below:



 <b>Danger</b>	
 Prohibited	<p>▼ Do not change the switch setting when the power is on. It could lead to electric shocks, or the option might break down or get damaged.</p>

### 2.1. DeviceNet connector

Used to connect DeviceNet network cables. The terminal is a plug-type and the signal of each terminal is as follows.



Size of connectable wire: 0.3 to 1.5mm<sup>2</sup> (AWG 22 to 16), Strip-off length: 7mm

Tightening torque: 0.5 to 0.6 N·m

Recommended screwdriver: Small flat-blade screwdriver (blade thickness: 0.6mm, blade width: 3.5mm or less)



## 2.2. DeviceNet indicator

The DEV002Z option has a two-color (red and green) LED as a means of indicating the MNS (module/network status), which works basically in accordance with DeviceNet specifications.

LED	Status	Item displayed
Off	Not Powered/Not On-line	Device is not on-line. - The DEV002Z has not completed the Dup_MAC_ID test yet. - The DEV002Z may not be powered.
Lights green.	Device Operational AND On-line, Connected	The DEV002Z is operating in a normal condition and the DEV002Z is on-line with connections in the established state.
Flashes green.	Device Operational AND On-line, Not Connected or Device On-line AND Device needs commissioning	The DEV002Z is operating in a normal condition and the DEV002Z is on-line with no connections in the established state. - The DEV002Z has passed the Dup_MAC_ID test, is on-line, but has no established connections to other nodes. - Configuration missing, incomplete or incorrect.
Flashes red.	Minor Fault and/or Connection Time-Out	Recoverable fault and/or one or more I/O Connections are in the Timed-Out state.
Lights red.	Critical Fault or Critical Link Failure	The DEV002Z has an unrecoverable fault; may need replacing. Failed communication device. The DEV002Z has detected an error that has rendered it incapable of communicating on the network (Duplicate MAC ID, or Bus-off).
Flashes red and green alternately.	Communication Faulted and Received an Identify Comm Fault Request - Long Protocol	A specific Communication Faulted device. The DEV002Z has detected a Network Access error and is in the Communication Faulted state. The DEV002Z has subsequently received and accepted an Identify Communication Faulted Request - Long Protocol message.

### 3. Installing the DEV002Z

Install the DeviceNet option to VF-AS1/PS1 as follows:

\* When this option is used together with the IO card option, attach this option to the front panel side.

- (1) Turn off input power of VF-AS1/PS1 and wait for at least 15 minutes and then check that the CHARGE lamp on VF-AS1/PS1 is no longer lit.
- (2) Securing the option to the inverter
  - a) Insert a flat-blade screwdriver in each of the two holes at the upper part of the front panel, release the panel mounting tab by pushing the screwdriver down, and remove the front panel cover.
  - b) Install the option in the inverter by fitting the tabs on the lower side of the option into the slots at the lower part of the inverter front panel.
  - c) Make sure the option is securely attached to the inverter. Then, check whether the plastic bosses on the inverter case have fitted in the holes at the upper and lower parts of the option.
  - d) Insert the tabs at the lower part of the front cover into the slots at the lower part of the inverter to attach the front cover to the inverter.
  - e) Stuck the enclosed "LED name label" on the option LED display part of a front cover.

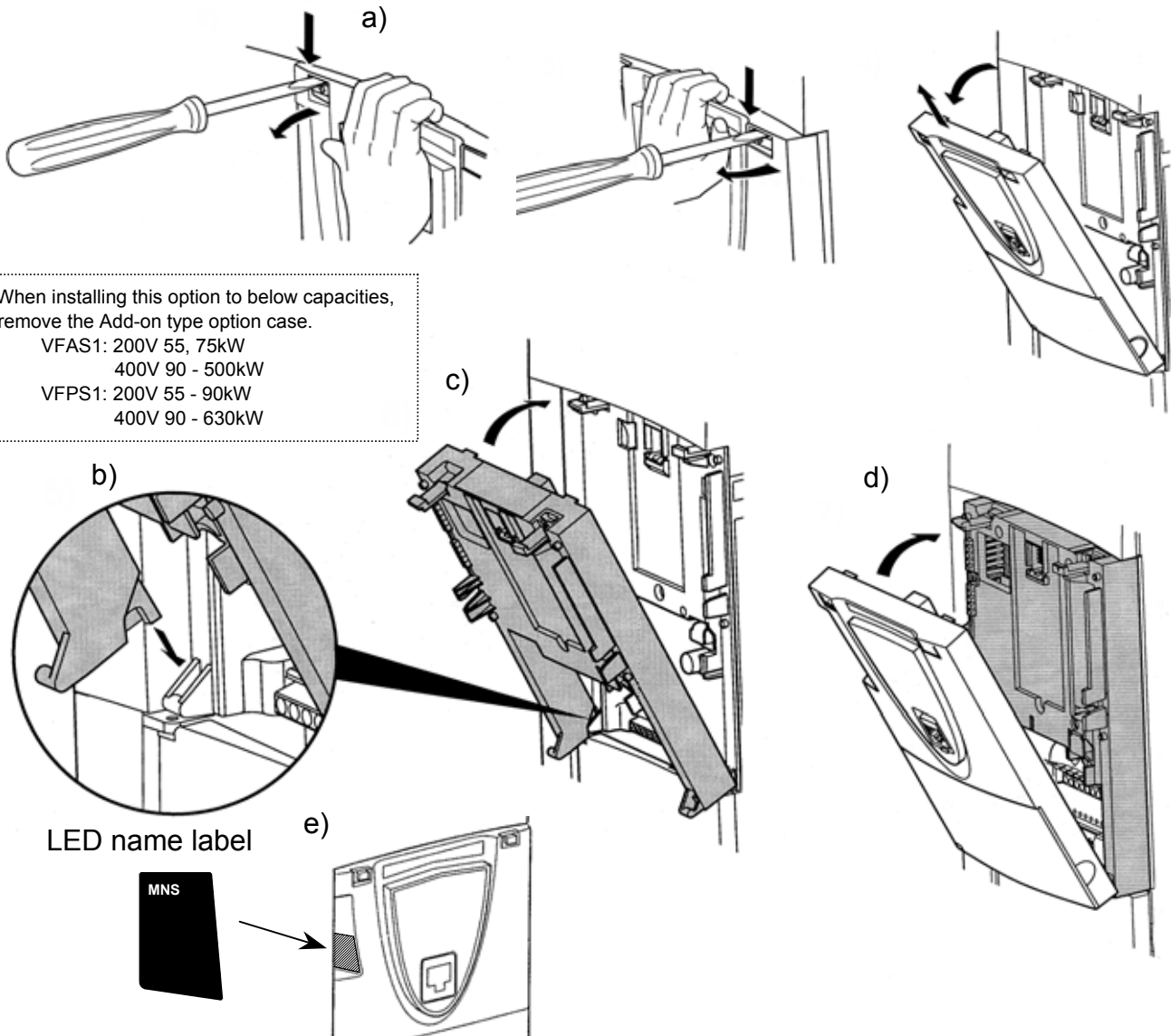

\* When installing this option to below capacities, remove the Add-on type option case.

VFAS1: 200V 55, 75kW  
400V 90 - 500kW  
VFPS1: 200V 55 - 90kW  
400V 90 - 630kW

---

## 4. Connecting to the network

---

---

### 4.1. Installation method

---

- (1) Attach DeviceNet cable to DeviceNet connector. (Refer to Section 2.1).  
(Be careful not to short-circuit adjacent terminals on DeviceNet connector).  
  
<Recommended cable>  
Thin branch cables: DeviceNet-specific thin cable.  
<Tightening torque>  
0.5 - 0.6 N·m  
Recommended screwdriver: Small flat-blade screwdriver (blade thickness: 0.6mm, blade length: 3.5mm or less)
- (2) Please set the terminating resistance if needed.  
<Terminating resistance specification>  
1/4 W - 121 ohm, 1% Metal Film
- (3) Using the DIP switch on the DeviceNet option, set a MAC ID number and a baud rate.  
(Refer to Section 4.3).
- (4) Once all the parameters are set, the power must be cycled to the VF-AS1/PS1 for these changes to take effect. (Refer to Section 5.)

## 4.2. Network Grounding

Please note the following points regarding the grounding of a DeviceNet network.

- Do not connect the G/E terminal to a power ground or any other potential noise-producing ground connection (such as a drive's "E" terminal). Connect to a close, clean ground to provide RF termination of the DeviceNet cable.
- Do not make connections to unstable grounds (paint-coated screw heads, grounds that are subjected to inductive noise, etc.)

To prevent ground loops, the DeviceNet network should be earth grounded in only one location. No significant current flow between V- and earth ground may occur via any device other than a power supply under normal operating conditions.

(From the ODVA DeviceNet specification)

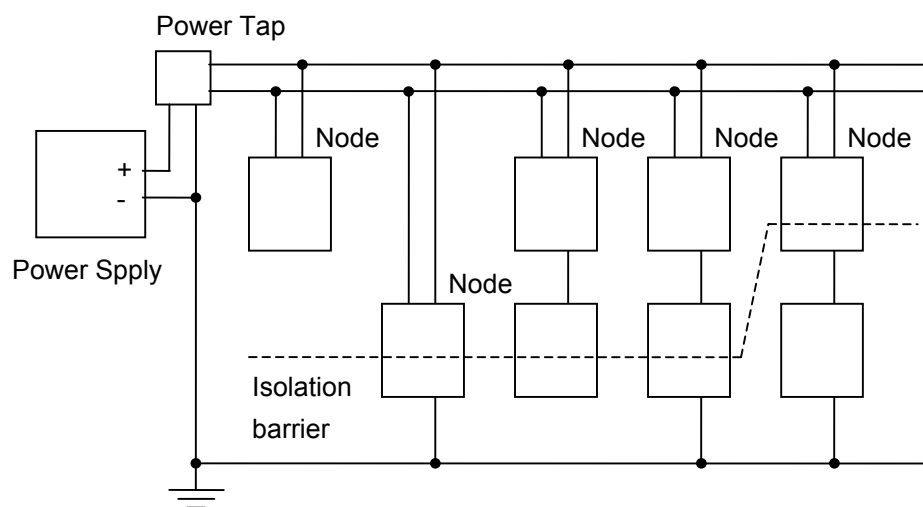

### 4.3. Setting a MAC ID number and a network baud rate

Configure MAC ID and network baud rate by the dip switch on the DeviceNet option.

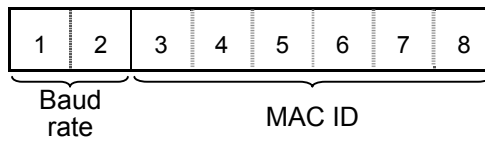

<Default setting>

MAC ID = 1

Baud rate = 125kbps

- MAC ID configuration

The MAC ID must be unique and not match any other device on the network.

SW ID	3	4	5	6	7	8
MAC ID						
0	OFF	OFF	OFF	OFF	OFF	OFF
1	OFF	OFF	OFF	OFF	OFF	ON
2	OFF	OFF	OFF	OFF	ON	OFF
3	OFF	OFF	OFF	OFF	ON	ON
4	OFF	OFF	OFF	ON	OFF	OFF
5	OFF	OFF	OFF	ON	OFF	ON
6	OFF	OFF	OFF	ON	ON	OFF
7	OFF	OFF	OFF	ON	ON	ON
8	OFF	OFF	ON	OFF	OFF	OFF
9	OFF	OFF	ON	OFF	OFF	ON
10	OFF	OFF	ON	OFF	ON	OFF
11	OFF	OFF	ON	OFF	ON	ON
12	OFF	OFF	ON	ON	OFF	OFF
13	OFF	OFF	ON	ON	OFF	ON
14	OFF	OFF	ON	ON	ON	OFF
15	OFF	OFF	ON	ON	ON	ON
16	OFF	ON	OFF	OFF	OFF	OFF
17	OFF	ON	OFF	OFF	OFF	ON
18	OFF	ON	OFF	OFF	ON	OFF
19	OFF	ON	OFF	OFF	ON	ON
20	OFF	ON	OFF	ON	OFF	OFF
21	OFF	ON	OFF	ON	OFF	ON
22	OFF	ON	OFF	ON	ON	OFF
23	OFF	ON	OFF	ON	ON	ON
24	OFF	ON	ON	OFF	OFF	OFF
25	OFF	ON	ON	OFF	OFF	ON
26	OFF	ON	ON	OFF	ON	OFF
27	OFF	ON	ON	OFF	ON	ON
28	OFF	ON	ON	ON	OFF	OFF
29	OFF	ON	ON	ON	OFF	ON
30	OFF	ON	ON	ON	ON	OFF
31	OFF	ON	ON	ON	ON	ON

SW ID	3	4	5	6	7	8
MAC ID						
32	ON	OFF	OFF	OFF	OFF	OFF
33	ON	OFF	OFF	OFF	OFF	ON
34	ON	OFF	OFF	OFF	ON	OFF
35	ON	OFF	OFF	OFF	ON	ON
36	ON	OFF	OFF	ON	OFF	OFF
37	ON	OFF	OFF	ON	OFF	ON
38	ON	OFF	OFF	ON	ON	OFF
39	ON	OFF	OFF	ON	ON	ON
40	ON	OFF	ON	OFF	OFF	OFF
41	ON	OFF	ON	OFF	OFF	ON
42	ON	OFF	ON	OFF	ON	OFF
43	ON	OFF	ON	OFF	ON	ON
44	ON	OFF	ON	ON	OFF	OFF
45	ON	OFF	ON	ON	OFF	ON
46	ON	OFF	ON	ON	ON	OFF
47	ON	OFF	ON	ON	ON	ON
48	ON	ON	OFF	OFF	OFF	OFF
49	ON	ON	OFF	OFF	OFF	ON
50	ON	ON	OFF	OFF	ON	OFF
51	ON	ON	OFF	OFF	ON	ON
52	ON	ON	OFF	ON	OFF	OFF
53	ON	ON	OFF	ON	OFF	ON
54	ON	ON	OFF	ON	ON	OFF
55	ON	ON	OFF	ON	ON	ON
56	ON	ON	ON	OFF	OFF	OFF
57	ON	ON	ON	OFF	OFF	ON
58	ON	ON	ON	OFF	ON	OFF
59	ON	ON	ON	OFF	ON	ON
60	ON	ON	ON	ON	OFF	OFF
61	ON	ON	ON	ON	OFF	ON
62	ON	ON	ON	ON	ON	OFF
63	ON	ON	ON	ON	ON	ON

- Baud rate configuration

SW kbps	Baud rate	
	1	2
125	OFF	OFF
250	OFF	ON
500	ON	OFF

Maximum length of main line

..... 500m (1640 ft.)

..... 250m (820 ft.)

..... 100m (328 ft.)

## 5. Communications-related parameters

On the network, the VF-AS1/PS1 (including the DEV002Z) serves as a slave device. Using the parameters listed below, set the slave device on the network and its mode of operation.

These settings can also be made by the use of configuration tools and the EDS file. The EDS file can be downloaded from the following web site.

[http://www.inverter.co.jp/product/inv/vfas1/dev/index\\_i.htm](http://www.inverter.co.jp/product/inv/vfas1/dev/index_i.htm)

Parameter	Function	Adjustment range	Default setting
<i>F830*</i>	Communication option setting 1 〔 Assembly 〕 〔 Object 〕	0: Instance 20/70 1: Instance 21/71 2: Instance 100/150 3: Instance 101/151 4: Instance 102/152	0
<i>F851</i>	Inverter operation at the communications loss action (Network wire breaks)	0: Stop and Communication release 1: None 2: Deceleration stop 3: Coast stop 4: Emergency stop 5: Preset speed operation command (Operating at the preset speed operation frequency set with <i>F852</i> )	0
<i>F852</i>	Preset speed operation selection	0: None 1 to 15:Preset speed	0
<i>F853</i>	Monitoring of communication device station address	Displays the MAC ID number assigned using the DIP switch. 0 to 63	1
<i>F854</i>	Monitoring of communications device's baud rate	Displays the network communication speed set with the DIP switch. 0: 125kbps 1: 250kbps 2: 500kbps	0
<i>F899</i>	Network option reset setting	0: None 1: Resetting the DEV002Z and the inverter	0

\* When the parameters are changed, the power must be cycled (or set *F899* to 1) to the VF-AS1/PS1 for the changes to take effect.

## 5.1. *F851*: Communication Loss Action Setting (Network breaks)

This parameter sets up the VF-AS1/PS1 response to a loss of communications with the DeviceNet network.

### 0: Stop and Communication release

The inverter decelerates the motor to a stop and gives an  $\mathcal{L}$  alarm (the leftmost LED  $\mathcal{L}$  flashes). Commands entered through the network are canceled, and the commands set with parameters  $\mathcal{C}n0d$  and  $Fn0d$  become effective.

When communications are restored, the  $\mathcal{L}$  alarm is turned off.

### 1: None

The inverter remains in the state where it was when the problem arose, and it gives an  $\mathcal{L}$  alarm.

### 2: Deceleration stop

The inverter decelerates the motor to a stop and gives an  $\mathcal{L}$  alarm. Commands entered through the network are not canceled.

### 3: Coast stop

The inverter issues a command for a frequency of 0Hz and gives an  $\mathcal{L}$  alarm.

Commands entered through the network are not canceled.

### 4: Emergency stop

The error message  $\mathcal{E}rrB$  is displayed. Commands entered through the network are not canceled.

When communications are restored, the inverter is not restored to working order and the error message  $\mathcal{E}rrB$  does not disappear until the inverter is reset.

### 5: Preset speed operation command

Refer to Section 5.2

## 5.2. *F852*: Preset speed operation selection

If the communication loss action (parameter *F851*) is set to 5 (preset speed command), the VF-AS1/PS1 will run at a preset speed as set up by this parameter in the case of a communication loss (with  $\mathcal{L}$  alarm). Commands entered through the network are not canceled.

For example,

If the inverter is set as described below,

*F851* = 5 (preset speed operation command)

*F852* = 8 (preset speed operation frequency 8)

*F287* (preset speed operation frequency 8) = 10 (10Hz)

Operation is carried out as follows.

Network	Operation of the VF-AS1/PS1
Normal conditions .....	Operates according to commands entered through the network.
↓	↓
communications loss .....	Operates at 10Hz.
↓	↓
Restoration.....	Operates according to commands entered through the network.

### 5.3. *F830*: Assembly Object Setting

The Input/Output Instance of DEV002Z is set up by this parameter.

The DEV002Z supports both the standard DeviceNet AC Drive profile Instances 20/70, 21/71 and user defined Instances 100/150, 101/151, 102/152.

\* For an explanation of *F830* = 0 (Instance 20/70), 1 (Instance 21/71), 3 (Instance 101/151) and 4 (Instance 102/152), refer to the function manual (E6581281).

*F830*=2 (Instance 100/150)

Byte	bit7	bit6	bit5	bit4	bit3	bit2	bit1	bit0
0	DC braking	Acc./Dec. #1/#2	PI control	Motor #1/#2	Preset Speed 4	Preset Speed 3	Preset Speed 2	Preset Speed 1
1	Command link	Frequency link	Reset trip	Emerg. stop	Free run (ST)	Run/Stop	Forward/Reverse	Jog
2	Drive Reference Speed Hz (Low byte)							
3	Drive Reference Speed Hz (High byte)							

Output Instance 100 format

Byte	bit7	bit6	bit5	bit4	bit3	bit2	bit1	bit0
0	DC braking	Acc./Dec. #1/#2	PI control	Motor #1/#2	(Reserved)	ALARM ( <i>F L G I</i> )	Fault	Fault FL
1	(Reserved)	READY without ST/RUN	READY with ST/ RUN	Emerg. stop	Free run (ST)	Run/Stop	Forward/Reverse	Jog
2	Drive Actual Speed Hz (Low byte)							
3	Drive Actual Speed Hz (High byte)							

Input Instance 150 format

\* Drive Reference Speed command value

A frequency should be specified in hexadecimal notation in units of 0.01Hz.

For example, to set the frequency at 60Hz, since the minimum unit of frequency is 0.01Hz, you have to enter the following number.

$60 \div 0.01 = 6000 = 0x1770$  (hexadecimal)



## Data composition of output instance 100

Byte	bit	Specifications	0	1	Supplement
0	0	Preset speed #1* <sup>1</sup>	Preset speed OFF: 0000, Preset speed #1-#15: 0001 to 1111		A combination of 4 different bits is used to select a preset speed from among preset speed operation OFF and preset speed #1 to #15.
0	1	Preset speed #2* <sup>1</sup>			
0	2	Preset speed #3* <sup>1</sup>			
0	3	Preset speed #4* <sup>1</sup>			
0	4	Motor #1/#2 (THR2 selection)	Motor #1 (THR1)	Motor #2 (THR2)	Used to select a motor electronic-thermal protection level. 0: Protection level #1 ( $\underline{t}Hr$ ) 1: Protection level #2 ( $F173$ )
0	5	PI control	Normal operation	PI control off	-
0	6	Acceleration/Deceleration #1/#2 selection (AD2 selection)	Acceleration/Deceleration #1 (AD1)	Acceleration/Deceleration #2 (AD2)	Used to select acceleration/deceleration time. 0: $ACC, DEC$ 1: $F500, F501$
0	7	DC braking	OFF	Forced DC braking	If "1" is specified, $db$ is displayed.
1	0	JOG run* <sup>2</sup>	OFF	JOG run	If "1" is specified, operation is performed at the frequency specified with $F250$ (jog run frequency).
1	1	Forward run/Reverse run	Forward run	Reverse run	-
1	2	Run/Stop	Stop	Run	-
1	3	Coast stop	Ready for operation	Coasting	-
1	4	Emergency stop	OFF	Emergency stop	If "1" is specified, $E$ tripping can occur.
1	5	Reset	OFF	Reset	Enabled only in the event of tripping
1	6	Frequency link	OFF	Priority	Enabled regardless of the setting of $FND$
1	7	Command link	OFF	Priority	Enabled regardless of the setting of $CND$

\*1: Preset speed operation can be performed at up to 15 different frequencies (preset speed operation frequencies #1 to #15) specified by combining preset speed 1 to preset speed 4. To perform preset speed operation, the "Command priority" option and the "Run/Stop" bit must be set to 1.

Example: To run the motor in the reverse direction at preset speed operation frequency #7 ( $5r7$ )

"10000110 00000111" = 0x8607 (hexadecimal)

If one of the bits for "Preset speed #1" to "Preset speed #4" is set to 1, priority is given to preset speed operation even though the "Frequency link" bit is set to 1, and therefore operation is not performed by "Frequency link".

\*2: Jog operation has higher priority than preset speed operation. If the operation frequency is higher than the jog run frequency, however, jog operation is not carried out.

## Data composition of output instance 150

Byte	bit	Specifications	0	1	Supplement
0	0	Fault FL	No output	Output	-
0	1	Fault	No trip	Tripped	The <i>r t r y</i> status and the trip retention status are also regarded as tripped statuses.
0	2	Alarm	No alarm	Alarm issued	-
0	3	(Reserved)	-	-	-
0	4	Motor #1/#2 (THR2 selection)	Motor #1 (THR1)	Motor #2 (THR2)	Indicates the motor electronic-thermal protection level selected. 0: Protection level #1 ( <i>t H r</i> ) 1: Protection level #2 ( <i>F 1 7 3</i> )
0	5	PI control	PI control permission	PI control prohibition	-
0	6	Acceleration/Deceleration #1/#2 selection (AD2 selection)	Acceleration/Deceleration #1 (AD1)	Acceleration/Deceleration #2 (AD2)	Indicates the acceleration/deceleration time selected. 0: <i>A C C, d E C</i> 1: <i>F 5 0 0, F 5 0 1</i>
0	7	DC braking	OFF	Forced DC braking	-
1	0	JOG run	OFF	JOG run	-
1	1	Forward run/Reverse run	Forward run	Reverse run	-
1	2	Run/Stop	Stop	Run	-
1	3	Coasting (ST off)	ST=ON	ST=OFF	-
1	4	Emergency stop	No emergency stop	Emergency stop	-
1	5	Ready for operation ST=ON	Getting ready for operation	Ready for operation	ST=ON and RUN=ON in addition to "ready for operation"*
1	6	Ready for operation	Getting ready for operation	Ready for operation *	-
1	7 **	Local/Remote	Remote	Local	-

\* Ready for operation: Initialization completed, not a stop due to a failure, no alarm issued, not moff, not a forced stop due to II, not a forced stop due to a momentary power failure.

\*\* It is reserved in VF-AS1.

## 6. DeviceNet Local/Remote Operation

The example below shows how to configure the VF-AS1/PS1 for local / remote operation.

### <Terminal function>

- F terminal ..... Operating command
- R terminal..... DeviceNet/Local (Terminal in this example) switching
- RR/S4 terminal.... Operation frequency command

### <Wiring>

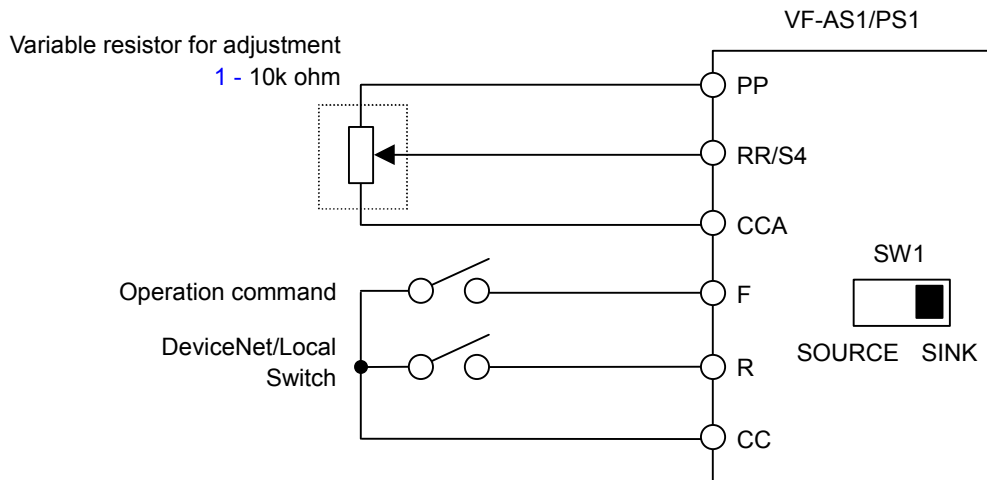

### <Parameter setting>

- $CMD$  (Command mode selection) = 0 (Terminal board)
- $FMD$  (Frequency setting mode selection 1) = 2 (RR/S4)
- $F12$  (Input terminal selection 2 (R)) = 48 (Remote/Local control)

### <Operation>

R-CC terminal open:

VF-AS1/PS1 is controlled as slave device of DeviceNet.

R-CC terminal closed:

F-CC terminal short to RUN

F-CC terminal open to STOP

Output frequency is set up by the RR/S4 signal input.

## 7. Specifications

Item	Specifications
Model number	DEV002Z
DeviceNet	Device type: AC drive Connector: Plug type Indicator: MNS (Module / Network status) MAC ID setup: DIP switch Baud-rate setup: DIP switch Baud-rate: 125kbps, 250kbps, 500kbps
Use environments	Indoors, an altitude of 3,000m or less, where the product will not be exposed to direct sunlight, corrosive or explosive gases, vapor, coarse particulates including dust, and where there is no grinding fluid or grinding oil nearby
Ambient temperature	-10 to +60°C
Storage temperature	-25 to +65°C
Relative humidity	20 to 93% (no condensation and absence of vapor)
Vibration	5.9m/s <sup>2</sup> {0.6G} or less (10 - 55Hz)

DEV002Z has been self-tested and found to comply with ODVA Conformance Test Software Version A-17.

## 8. Warranty

Any part of the inverter that proves defective will be repaired free of charge under the following conditions:

1. If and when a trouble occurs on the option unit properly installed and handled within one year of delivery, and if the trouble is clearly attributable to defects inherent in our design and manufacture, the product will be repaired free of charge.
2. This warranty applies only to the option unit.
3. For the following kinds of failure or damage, the repair cost shall be borne by the customer even within the warranty period.
  - 1) Failure or damage caused by improper or incorrect use or handling, or unauthorized repair or modification of the option.
  - 2) Failure or damage caused by the option falling or an accident during transportation after the purchase.
  - 3) Failure or damage caused by fire, salty water or wind, corrosive gas, earthquake, storm or flood, lightning, abnormal voltage supply, or other natural disasters.
  - 4) Damage sustained as a result of the fact that the product was used for any application other than that designated for the DeviceNet option (circuit board) for the VF-AS1/PS1.
4. If terms and conditions of warranty are otherwise specified, priority is given to them.

## Free Manuals Download Website

<http://myh66.com>

<http://usermanuals.us>

<http://www.somanuals.com>

<http://www.4manuals.cc>

<http://www.manual-lib.com>

<http://www.404manual.com>

<http://www.luxmanual.com>

<http://aubethermostatmanual.com>

Golf course search by state

<http://golfingnear.com>

Email search by domain

<http://emailbydomain.com>

Auto manuals search

<http://auto.somanuals.com>

TV manuals search

<http://tv.somanuals.com>