

TOSHIBA

MULTIFUNCTIONAL DIGITAL COLOR SYSTEMS

Operator's Manual for Wireless LAN Adapter

GN-1010

HANDLING PRECAUTIONS



Caution

Take the following precautions when handling this product.

- Do not attempt to modify this device. The manufacturer will bear no responsibility, whatsoever for the device if it has been modified.
- Do not store this device in high temperature or low temperature surroundings or expose it to rapid temperature changes.
(Operating temperature range: 0 to 50°C)
- Do not use or store this device where it is exposed to direct sunlight or near stoves or other sources of heat.
- Do not use or store this device where it is exposed to dust or high humidity.
(Operating humidity range: 10 to 90%RH, without condensation)
- This product contains precision electronic elements and must not be used in locations subject to physical shock or strong vibration.
- Do not use or store this device near strong magnetic fields or devices emitting electromagnetic radiation.
- If abnormal smells or heat are noticed, disconnect the power supply immediately.
- In case of abnormal operation or failure, contact TOSHIBA authorized dealer or service engineer.

PRECAUTIONS FOR USE

This product is classified as "wireless equipment for stations of low-power data transmissions systems" under the Wireless Telegraphy Act, and does not require a radio transmission license. The law prohibits modification of the interior of this product.

ABOUT TOSHIBA WIRELESS SOLUTION

Wireless LAN Adapter Types

The Wireless LAN Adapter is a wireless network adapter that complies with the IEEE 802.11 standard on wireless LANs (Revision B). The Wireless LAN Adapter supports data rates up to 11 Mbit/s.



- Wi-Fi (Wireless Fidelity) certified by the Wi-Fi Alliance. This means that your Wireless hardware will communicate with other vendors' IEEE 802.11 compliant wireless LAN product.
- Fully compatible with any of other wireless LAN system based on Direct Sequence Spread Spectrum (DSSS) radio technology that complies with the IEEE 802.11 standard on wireless LANs (Revision B).

Wireless LAN Adapters

The Wireless LAN Adapter supports the following wireless LAN features:

- Automatic Transmit Rate Select mechanism in the transmit range of 11, 5.5, 2 and 1 Mbit/s.
- Frequent Channel Selection (2.4 GHz).
- Roaming over multiple channels.

Wireless Interoperability

The TOSHIBA Wireless LAN Adapter products are designed to be interoperable with any Wireless LAN products that is based on Direct Sequence Spread Spectrum (DSSS) radio technology, and is compliant to:

- The IEEE 802.11 Standard on Wireless LANs (Revision B), as defined and approved by the Institute of Electrical and Electronics Engineers.
- The Wireless Fidelity (Wi-Fi) certification as defined by the Wi-Fi Alliance.

Wireless LAN and your Health

Wireless LAN products, like other radio devices, emit radio frequency electromagnetic energy. The level of energy emitted by Wireless LAN devices however is far much less than the electromagnetic energy emitted by wireless devices like for example mobile phones.

Because Wireless LAN products operate within the guidelines found in radio frequency safety standards and recommendations, TOSHIBA believes Wireless LAN is safe for use by consumers. These standards and recommendations reflect the consensus of the scientific community and result from deliberations of panels and committees of scientists who continually review and interpret the extensive research literature.

In some situations or environments, the use of Wireless LAN may be restricted by the proprietor of the building or responsible representatives of the organisation. These situations may for example include:

- Using the Wireless LAN equipment on board of aeroplanes, or
- In any other environment where the risk of interference to other devices or services is perceived or identified as harmful.

If you are uncertain of the policy that applies on the use of wireless devices in a specific organisation or environment (e.g. airports), you are encouraged to ask for authorisation to use the Wireless LAN device prior to turning on the equipment.

Safety Instruction for Wireless Products

If your computer has wireless function, all safety instructions must be read carefully and must be fully understood, before attempting to use our Wireless Products.

This manual contains the safety instructions that must be observed in order to avoid potential hazards that could result in personal injuries or could damage your Wireless Products.

Limitation of Liability

For damage occurring due to an earthquake or thunder, fire beyond our responsibility, action by third party, other accident, intentional or accidental mistakes by a user, misuse, use under abnormal conditions, we do not take any responsibility.

For incidental damage (loss of business profit, business interruption, etc.) occurring due to use or disability of the product, we do not take any responsibility.

For damage occurring due to non observance of the contents described in the instruction manual, we do not take any responsibility.

For damage occurring due to erroneous operation or hang up caused by use in combination with products not related to our company, we do not take any responsibility.

Usage Restrictions

Do not use the Wireless Products for controlling equipment:

- Equipment directly linked with human life corresponds to the following.
 - Medical equipment such as life support systems, equipment used in operation, etc.
 - Exhaust systems for gases such as poisonous gas etc. and exhaust systems for smoke.
 - Equipment that must be set up in compliance with various laws such as the Fire Services Act, the Construction Standard Act, etc.
 - Equipment corresponding to that mentioned above.
- Equipment linked with human safety or having a serious influence on the safe maintenance of public function, etc., because it is not designed or manufactured for this type of use.
 - Traffic control equipment for air, railroad, road, marine transport, etc.
 - Equipment used in atomic power plants etc.
 - Equipment corresponding to that mentioned above.

WARNING



Keep this product away from a cardiac pacemaker at least 22 cm.

Radio waves can potentially affect cardiac pacemaker operation, thereby causing respiratory troubles.

Do not use the product inside a medical facility or near medical electric equipment.

Radio waves can potentially affect medical electric equipment, thereby causing an accident due to malfunction.

Do not use the product near an automatic door, fire alarm or other automatic control equipment.

Radio waves can potentially affect automatic control equipment, thereby causing an accident due to malfunction.

Monitor possible radio interference or other troubles to other equipment while the product is used. If any effect is caused, do not use the product.

Otherwise, radio waves can potentially affect other equipment, thereby causing an accident due to malfunction.

NOTE

Do not use the product in the following places:

Places near a microwave oven where a magnetic field generates and places where static electricity or radio interference generates.

Depending on environment, radio waves can not reach to the product.

Regulatory Information

The TOSHIBA Wireless LAN Adapter must be installed and used in strict accordance with the manufacturer's instructions as described in the user documentation that comes with the product. This device complies with the following radio frequency and safety standards.

Canada - Industry Canada (IC)

This device complies with RSS 210 of Industry Canada.

Operation is subject to the following two conditions: (1) this device may not cause interference, and (2) this device must accept any interference, including interference that may cause undesired operation of this device.

L'utilisation de ce dispositif est autorisée seulement aux conditions suivantes: (1) il ne doit pas produire de brouillage et (2) l'utilisateur du dispositif doit être prêt à accepter tout brouillage radioélectrique reçu, même si ce brouillage est susceptible de compromettre le fonctionnement du dispositif.

Europe - EU Declaration of Conformity

This device complies with the essential requirements of the R&TTE Directive 1999/5/EC with essential test suites as per standards:

- EN 60950 Safety of Information Technology equipment
- ETS 300 328 Technical requirements for radio equipment
- ETS 300 826 General EMC requirements for radio equipment

Hereby, TOSHIBA TEC, declares that this FX-DS110-APL (GN-1010) is in compliance with the essential requirements and other relevant provisions of Directive 1999/5/EC.
TOSHIBA TEC vakuuttaa täten että FX-DS110-APL (GN-1010) tyypinen laite on direktiivin 1999/5/EY oleellisten vaatimusten ja sitä koskevien direktiivin muiden ehtojen mukainen.
Hierbij verklaart TOSHIBA TEC dat het toestel FX-DS110-APL (GN-1010) in overeenstemming is met de essentiële eisen en de andere relevante bepalingen van richtlijn 1999/5/EG
Bij deze verklaart TOSHIBA TEC dat deze FX-DS110-APL (GN-1010) voldoet aan de essentiële eisen en aan de overige relevante bepalingen van Richtlijn 1999/5/EC.
Par la présente TOSHIBA TEC déclare que l'appareil FX-DS110-APL (GN-1010) est conforme aux exigences essentielles et aux autres dispositions pertinentes de la directive 1999/5/CE
Par la présente, TOSHIBA TEC déclare que ce FX-DS110-APL (GN-1010) est conforme aux exigences essentielles et aux autres dispositions de la directive 1999/5/CE qui lui sont applicables
Härmed intygar TOSHIBA TEC att denna FX-DS110-APL (GN-1010) står i överensstämmelse med de väsentliga egenskapskrav och övriga relevanta bestämmelser som framgår av direktiv 1999/5/EG.
Undertegnede TOSHIBA TEC erklærer herved, at følgende udstyr FX-DS110-APL (GN-1010) overholder de væsentlige krav og øvrige relevante krav i direktiv 1999/5/EF

Hiermit erklärt TOSHIBA TEC, dass sich <i>dieser/diese/dieses</i> FX-DS110-APL (GN-1010) in Übereinstimmung mit den grundlegenden Anforderungen und den anderen relevanten Vorschriften der Richtlinie 1999/5/EG befindet". (BMW)
Hiermit erklärt TOSHIBA TEC die Übereinstimmung des Gerätes FX-DS110-APL (GN-1010) mit den grundlegenden Anforderungen und den anderen relevanten Festlegungen der Richtlinie 1999/5/EG. (Wien)
ΜΕ ΤΗΝ ΠΑΡΟΥΣΑ ΤΟSHIBA TEC ΔΗΛΩΝΕΙ ΟΤΙ FX-DS110-APL (GN-1010) ΣΥΜΜΟΡΦΩΝΕΤΑΙ ΠΡΟΣ ΤΙΣ ΟΥΣΙΩΔΕΙΣ ΑΠΑΙΤΗΣΕΙΣ ΚΑΙ ΤΙΣ ΛΟΙΠΕΣ ΣΧΕΤΙΚΕΣ ΔΙΑΤΑΞΕΙΣ ΤΗΣ ΟΔΗΓΙΑΣ 1999/5/ΕΚ
Η ΤΟSHIBA TEC δηλώνει με το παρόν ότι το μοντέλο FX-DS110-APL (GN-1010) ασύρματου προσαρμογέα LAN συμμορφώνεται με τις βασικές απαιτήσεις και τις λοιπές σχετικές διατάξεις της Οδηγίας 1999/5/ΕΚ
Con la presente TOSHIBA TEC dichiara che questo FX-DS110-APL (GN-1010) è conforme ai requisiti essenziali ed alle altre disposizioni pertinenti stabilite dalla direttiva 1999/5/CE.
Por medio de la presente TOSHIBA TEC declara que el FX-DS110-APL (GN-1010) cumple con los requisitos esenciales y cualesquiera otras disposiciones aplicables o exigibles de la Directiva 1999/5/CE
TOSHIBA TEC declara que este FX-DS110-APL (GN-1010) está conforme com os requisitos essenciais e outras disposições da Directiva 1999/5/CE.
TOSHIBA TEC, FX-DS110-APL(GN-1010) model Kablosuz LAN Adaptörünün 1999/5/EC Tüzüğü'nün temel gereksinimlerine ve diğer ilgili uygulamalara uyduğunu beyan eder.

USA-Federal Communications Commission (FCC)

This device complies with Part 15 of the FCC Rules. Operation is subject to the following two conditions : (1) this device may not cause harmful interference, and (2) this device must accept any interference received, including interference that may cause undesired operation.

This equipment complies with part 15 of the FCC rules. Any changes or modifications not expressly approved by the manufacturer could void the user's authority to operate the equipment.

CAUTION: To comply with FCC RF exposure compliance requirements, a separation distance of at least 5 cm must be maintained between this device and all persons.

PRECAUTIONS RELATED TO SERVICE

Clean the GN-1010 by wiping lightly with a soft cloth moistened with water or a cleaning solution.

Take care to avoid the use of benzene, thinners or other volatile solutions which may cause deformation or discoloration.

NOTES!

- The unauthorized reproduction of this document, in whole or in part, is prohibited.
- The specifications, designs, and other contents of this document are subject to change without notice.
- The contents of this document are believed to be accurate, however if any discrepancies noted should be brought to the attention of TOSHIBA authorized dealer or service engineer.
- Notwithstanding the foregoing, the manufacturer is unable to accept any claims for losses or lost profits, etc. Resulting from the use of this product.
- TOSHIBA TEC will not guarantee the machine performance if you perform any setting other than specified in this manual.
- MS, Microsoft, Windows, Windows NT, and MS-DOS are registered trademarks or trademarks of Microsoft Corporation in the U.S.A. and other countries. Other names of companies and products used in this document are trademarks or registered trademarks of the related companies. This document does not use the symbols "™", "®", "©" etc.

BEFORE USING PRODUCT

Product Configuration

The configuration of this product is shown below. Check the contents to make sure that you have everything listed below. If you do not have all the items, contact your TOSHIBA authorized dealer or service engineer.

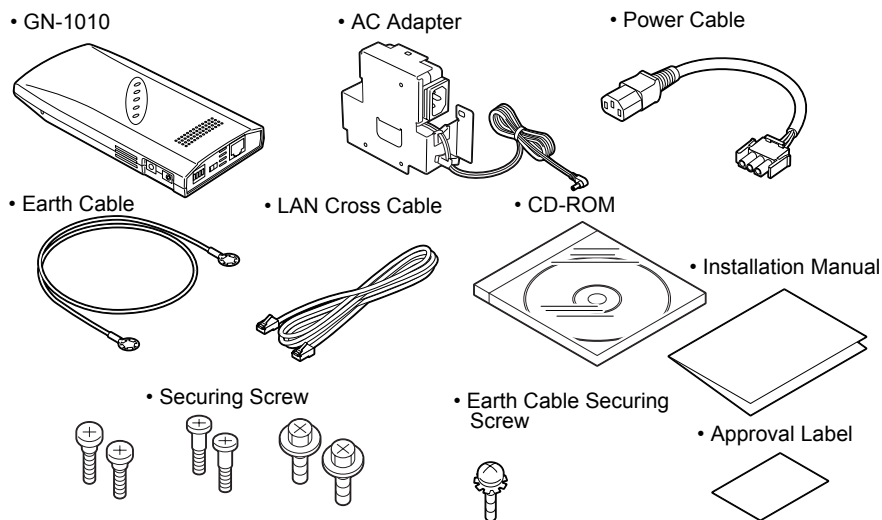

Configuration List

- GN-1010..... 1 pc.
- AC Adapter (1.8m)..... 1 pc.
- Power Cable (0.3m)..... 1 pc.
- LAN Cross Cable (0.75m)..... 1 pc.
- Earth Cable (0.44m)..... 1 pc.
- Securing Screw..... 2 pcs. / 2 pcs. / 2 pcs.
(Used to secure the GN-1010 on the Multifunctional Digital System. / Used to secure the recommended hub on the Multifunctional Digital System. / Used to secure the AC adapter bracket.)
- Earth Cable Securing Screw..... 1 pc.
(Used to secure the earth cable on the GN-1010.)
- CD-ROM..... 1 pc.
(Contains the utility software and the .pdf version of this manual.)
- Installation Manual..... 1 pc.
(Explains the unpacking and installation procedures.)
- Approval Label..... 1 pc.
(Affixes the approval label to the body, which is applied to each country.)

Note

- Adobe Acrobat Reader is required to view or print the manual contained in this CD-ROM. Adobe Acrobat Reader may be downloaded as free software from the home page of Adobe Systems Incorporated. (www.adobe.com)

INTRODUCTION

Thank you for purchasing the GN-1010 Wireless LAN Adapter.

This product is a wireless LAN adapter using the 2.4 GHz spectrum diffusion system, and is compatible with IEEE Standard 802.11b for wireless LAN.

The GN-1010 is designed for use as an access point, as well as a station (Ethernet ↔ wireless converter).

It is independent from operating systems or protocols, meaning it can be connected by LAN cable to any Ethernet-compatible Multifunctional Digital System for immediate wireless LAN use.

- * This manual explains how to use the GN-1010.
- * Be sure to read it carefully, so you can use the product correctly.

Features

- It can be installed on the Multifunctional Digital System for space saving.
- Operates as an access point or a LAN station.
- Uses compact, lightweight AC adapter.
- Full range of functions (roaming, 11-channel support).
- Automatic transmission speed (wireless) switching.
Automatically switches transmission speeds from 11Mbps to 5.5Mbps, 2Mbps, 1Mbps according to conditions.

Note

- The following terms and abbreviations are used in this manual for convenience.
GN-1010 Adapter
GN-1010 or a device containing the above Wireless terminal, User unit
Personal computer..... PC
Access point AP
Station..... ST

TABLE OF CONTENTS

HANDLING PRECAUTIONS	1
PRECAUTIONS FOR USE.....	1
ABOUT TOSHIBA WIRELESS SOLUTION	1
Wireless LAN Adapter Types	1
Wireless LAN Adapters	2
Wireless Interoperability	2
Wireless LAN and your Health	2
Safety Instruction for Wireless Products.....	2
Limitation of Liability	3
Usage Restrictions	3
WARNING	4
NOTE.....	4
Regulatory Information	5
Canada - Industry Canada (IC)	5
Europe - EU Declaration of Conformity	5
USA-Federal Communications Commission (FCC).....	6
PRECAUTIONS RELATED TO SERVICE	7
NOTES!	7
BEFORE USING PRODUCT	8
Product Configuration.....	8
Configuration List.....	8
INTRODUCTION	9
Features	9
TABLE OF CONTENTS.....	10
OVERVIEW	12
Component Locations.....	12
LED Indicators	13
DIP Switches	14
Multi-channel Operations.....	15
OPERATING MODE.....	16
Infrastructure (Wi-Fi Mode).....	16
Station (ST)	16
Access Point (AP).....	16
USING THE UTILITY SOFTWARE	18
Connecting between the GN-1010 and PC	18
Connection with Cross Cable	18
Connection with Hub	18
Preparing the Utility Software	19
Node Registration	20
Configuration	22

FUNCTIONS OF THE UTILITY SOFTWARE	24
Main Menu Screen	24
Node Registration	25
Configuration	26
Configuration Screen	26
Base	27
Wireless	29
Filter	33
SNMP	42
Spanning Tree	42
File Management	43
Status	44
Common Items	44
Environment	45
Interfaces	46
Wireless Node	48
Bridge	49
Spanning Tree	50
Wireless Counter	51
TROUBLESHOOTING	52
When Communications Fails	52
Check Software	52
Check Peripheral Environment or Installation Location	52
When Device Cannot Be Detected Automatically By Node Registration	53
When Device Does Not Start	53
Check Power LED	53
APPENDIX	54
Product Specifications	54
External Dimensions	54
Physical Specifications	54
Software Specification	55
Installation Environment Conditions (Environment Specifications)	55
Input/Output Interface	55
Glossary	56

OVERVIEW

Component Locations

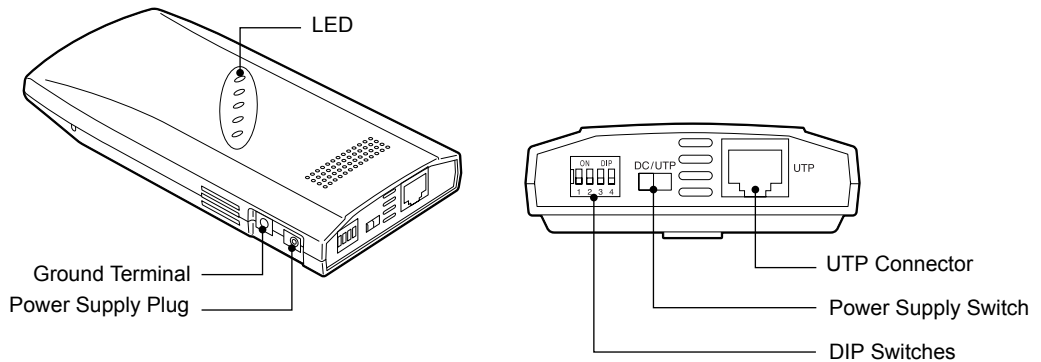

Caution

Do not obstruct the ventilation slots.
This can cause heat buildup, which can lead to damage or failure.

- LED
The five LED indicators indicate the sending /receiving status of the wireless or wired LAN, power supply, LAN connection status, etc.
- DIP Switches
The DIP switches are used for initialization and operating mode selection.
- Power Supply Switch
Always select power supply from the AC adapter ("DC" side).
- UTP Connector
The UTP connector is used to connect the LAN cable.

LED Indicators

The five LED indicators indicate the sending /receiving status of the wireless or wired LAN, power supply, LAN connection status, etc. as follows.

Name	Status	Description
POWER	Flashing	Startup, or startup error
	Illuminates	Operating
	Flashing 2 times	Initializing error
	Flashing 3 times	Firmware writing error
WLINK	Illuminates	Wireless LAN is connected normally.
WRX	Flashing	Receiving wireless LAN data
LINK	Illuminates	Wired LAN is connected normally.
RX	Flashing	Receiving wired LAN data
POWER WLINK WRX	All flashing simultaneously	Firmware writing in progress

DIP Switches

The DIP switches are used to make device settings.

— DIP Switch Default Setting (Factory Setting)

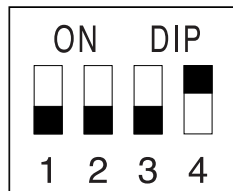

* Default Setting: 1to 3=OFF / 4=ON

— Function of DIP Switch

No.	ON	OFF	Description
1	INIT	< - >	Used to initialize the GN-1010. 1. Turn the power of the GN-1010 ON. 2. LED indicators (POWER, WLNK, WRX) begin to flash. 3. While they are flashing (approx. 3 seconds), turn the DIP switch 1 OFF. • Before restarting or turning the power off, wait until the LED indicators (POWER, WLNK, WRX) stop flashing and the GN-1010 returns to the status prior to initializing.
2	-	-	This switch is always at "OFF".
3	-	-	This switch is not used.
4	<INFRA>	-	This switch is always at "ON". • Used in the infrastructure (Wi-Fi mode).

Note

- The default setting for this device gives priority to the utility software.
- The GN-1010 operates as a station in default.
When the device connection is completed, the GN-1010 can operate as a station. Launch the utility software, then set the same ESS ID as that of the access point. When the WEP function is used, the WEP key setting is also required.

Multi-channel Operation

By changing channels on adjacent access points, it is possible to obtain higher throughput per wireless terminal, than when channels are not changed, even when the number of wireless terminals are increased.

The 2.4G ISM band (2400 to 2472 MHz) in which this product operates is subdivided into 11 channels, numbered 1 to 11, by IEEE standard 802.11, because each frequency has sidebands around its central frequency, sidebands on adjacent channels overlap. Overlapping frequencies can adversely affect communications by interference with each other's transmissions.

- Refer to the figure below when selecting channels, to ensure the frequency bands do not overlap.
- The maximum number of channels which can be used simultaneously without interference is three. By using a combination of channels 1, 6, 11. Channel numbers can be set from 1 to 11 using utility software.
- Channel numbers can be set from 1 to 11 using the utility software. Even on the same network, the wireless terminals which have different channels cannot communicate with each other.

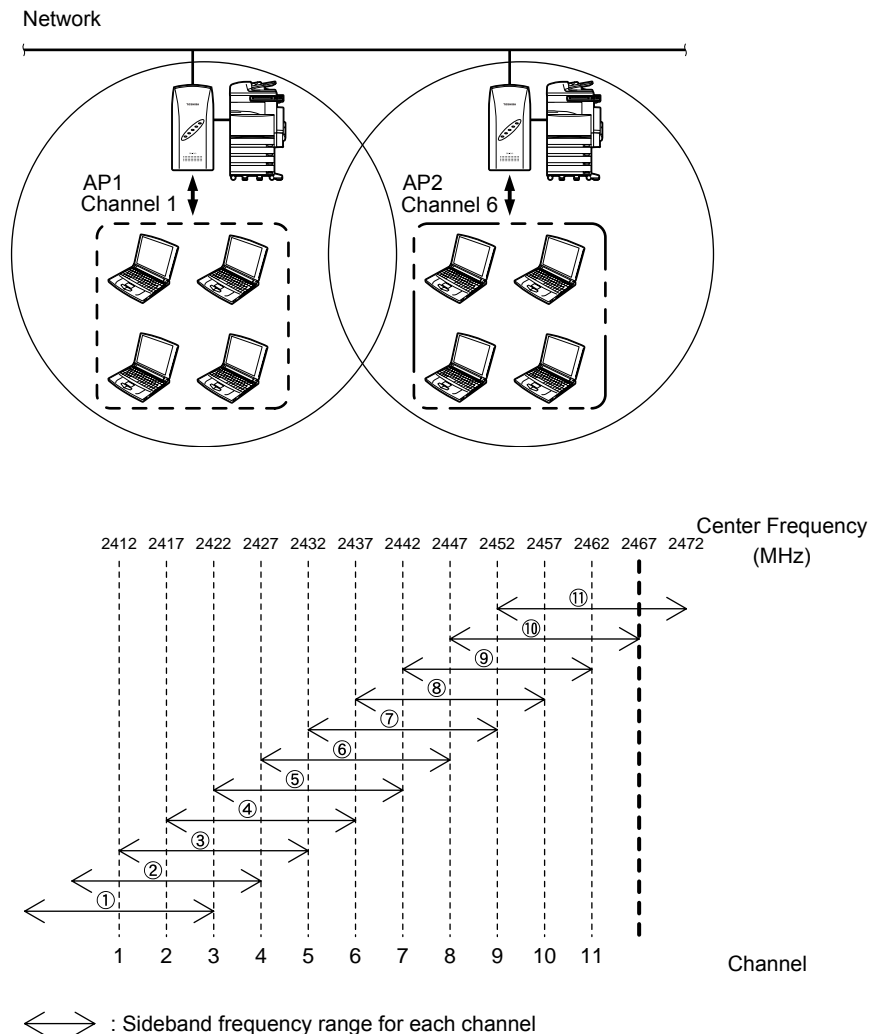

OPERATING MODE

Infrastructure (Wi-Fi Mode)

Station (ST)

When connecting to another access point, the GN-1010 can communicate with as a station.

The GN-1010 can be connected to the network via the access point.

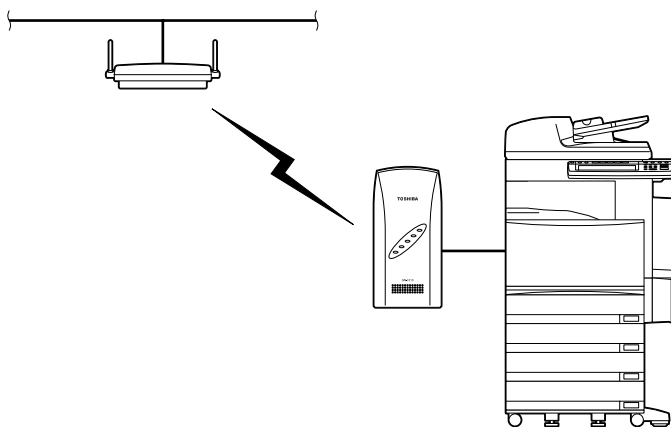

Access Point (AP)

The GN-1010 operates as an access point, and can receive communication from another wireless terminal.

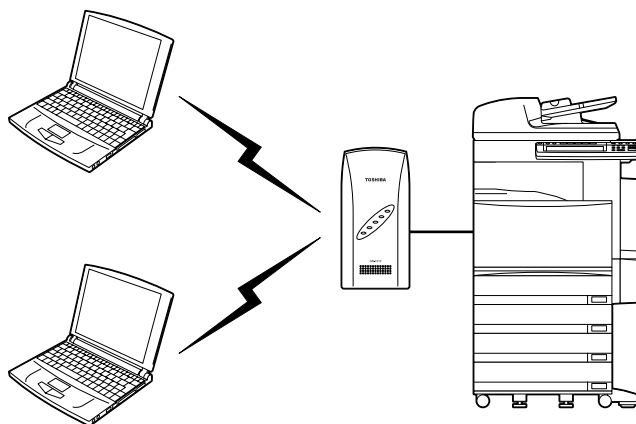

— Using the GN-1010 as an access point on the existing LAN environment

The wireless LAN environment can be newly added to the existing LAN environment.

The GN-1010 can communicate with a wireless client and a wired client.

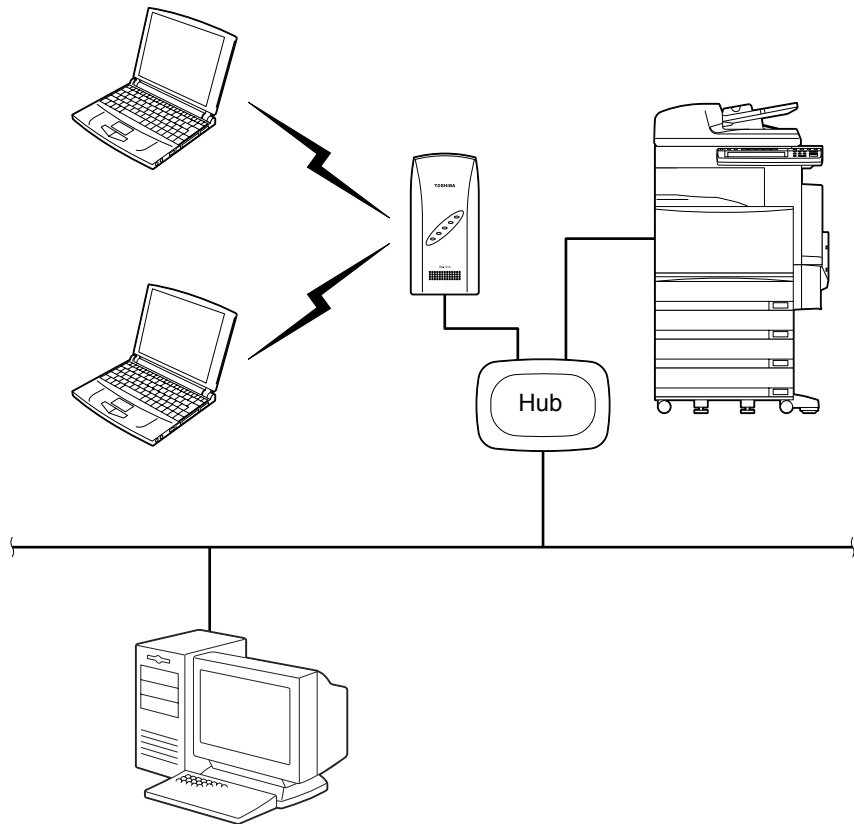

Note

- Purchase the hub (recommended model) separately.
- Use a straight cable which connects between the hub and the GN-1010. The straight cable is not included with this product.
- The recommended hub can be directly attached to the Multifunction Digital System. For details, contact your TOSHIBA authorized dealer or service engineer.
- In the infrastructure (Wi-Fi mode), all the wireless terminals perform communications via the access point. Since the roaming function is supported, log-in to any access point where the radio waves are accessible.

USING THE UTILITY SOFTWARE

Connecting between the GN-1010 and PC

To set the GN-1010 using the utility software, one Windows PC is required.

Note

- Ensure that the DIP switch 2 is "OFF".

Connection with Cross Cable

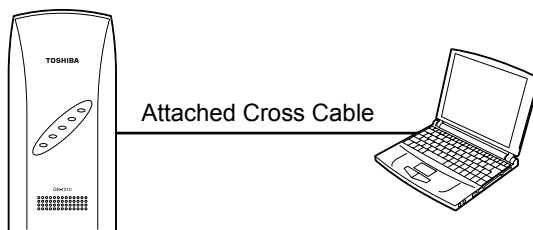

DIP Switch			
1	2	3	4
OFF	OFF	OFF	ON

Connection with Hub

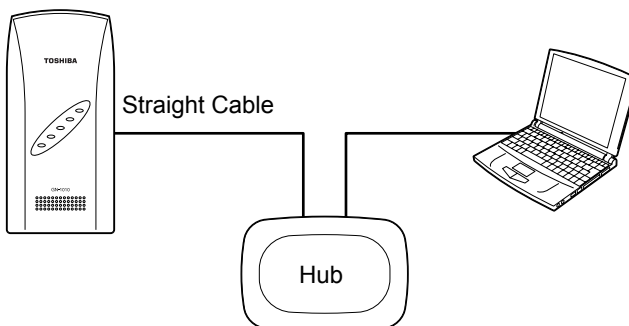

DIP Switch			
1	2	3	4
OFF	OFF	OFF	ON

Preparing the Utility Software

1. Insert the **CD-ROM** in the **CD-ROM** drive of the computer.
2. Use **Windows Explorer** to copy the file "**APUTIL.EXE**" in the "**Utility**" holder from the **CD-ROM** to the appropriate directory.
 - Example: C:\WLANUTIL\
3. **Double click** the **APUTIL.EXE** file to open the **Access Point Maintenance Utility**.
4. **You will see the following main menu.**

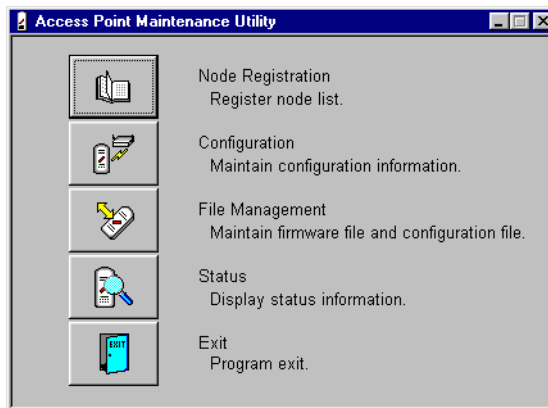

Node Registration

The first time you use the GN-1010, you must perform the “Node Registration”, which automatically detects and registers the GN-1010.

Once the “Node Registration” detects the GN-1010 installed on the network, its information will be stored in a file. Therefore, it is not required to perform “Node Registration” each time you start the utility.

- 1. Launch the utility software.**
- 2. Click [Node Registration] from the main menu.**

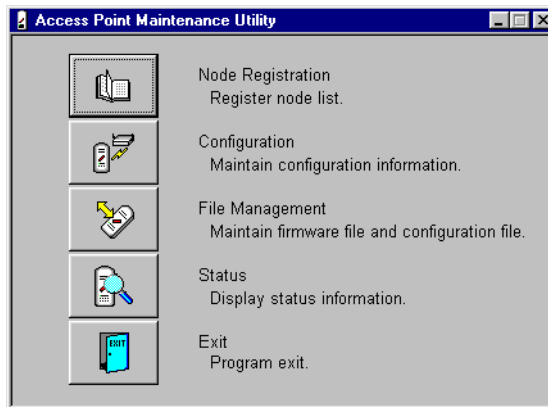

- 3. Click [Search] to detect an access point.**
 - MAC address and IP address for each access point detected are displayed in the Access Point List.
- 4. From the list, double-click an access point of which the name is registered.**

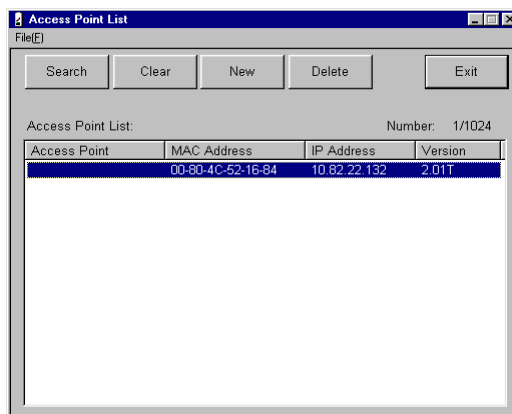

Note

- When an access point cannot be detected, close the utility software. Then, launch it again to detect it. Furthermore, if the access point cannot be detected after repeating the steps above, see the section "Troubleshooting" (P.52).

5. Enter the access point name and click [OK].

- Up to 32 characters are allowed. Also, a maximum of 1024 devices can be registered.

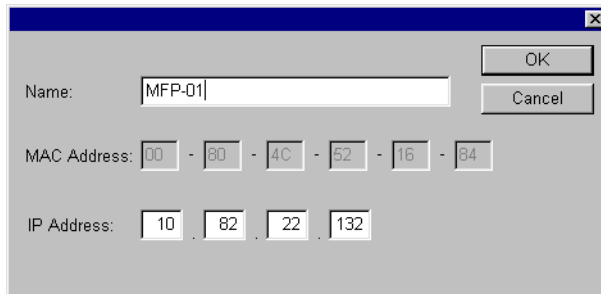

Name:

MAC Address: - - - - -

IP Address: . . .

6. Click [Exit] to complete the detection.

- Program returns to the main menu.

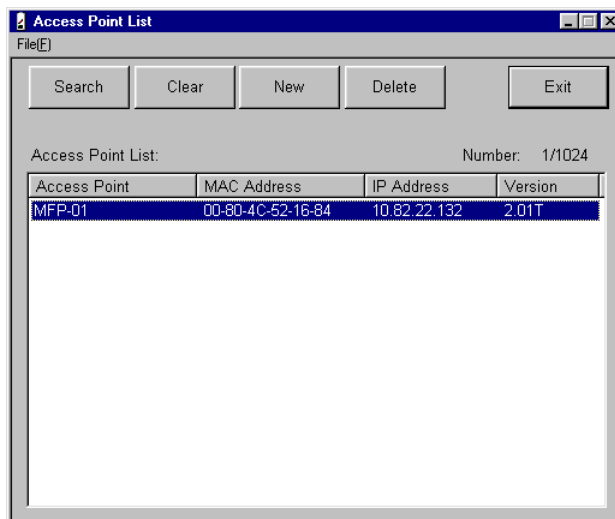

Access Point List

File[F]

Access Point List: Number: 1/1024

Access Point	MAC Address	IP Address	Version
MFP-01	00-80-4C-52-16-84	10.82.22.132	2.01T

Configuration

The utility software allows you to set the GN-1010. This section explains the basic operation flow for configuration.

For the detailed information on setting parameters, see the section "Functions of the Utility Software" (P.24).

Parameters in the configuration dialog box displayed when you click [Configuration] in step 2 are those for the utility software default setting. Therefore, you must register an appropriate name for this device to the "Name" field as described in the preceding section "Node Registration" and click [Read] to load the current setting before performing the setting operation.

- 1. Launch the utility software.**
- 2. Click [Configuration] from the main menu.**

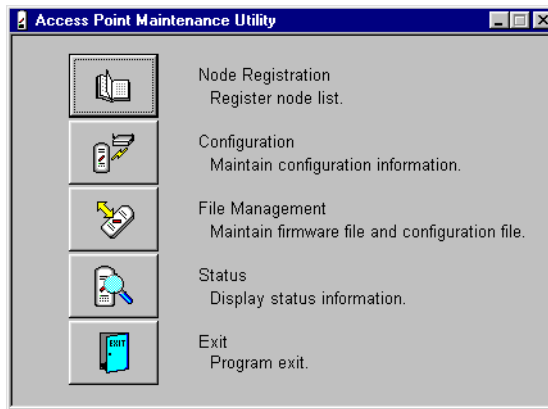

- 3. Click the Access Point drop-down list and select the access point you want to set or edit.**

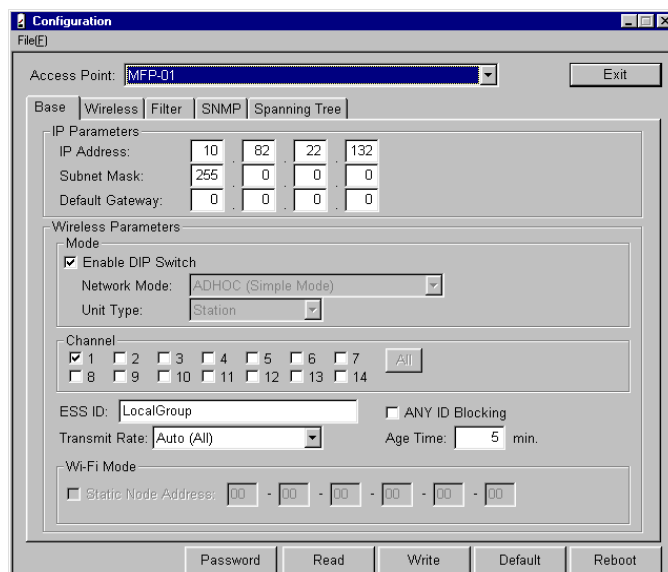

4. Click [Read] to load the setting of the device.

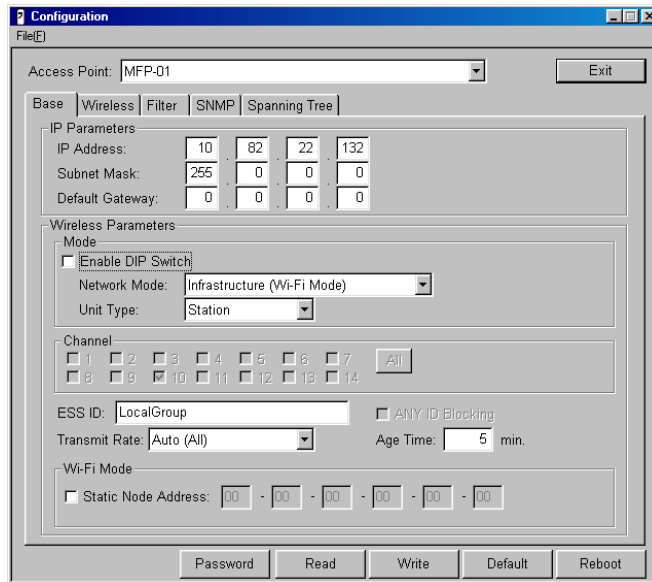

5. Click [OK].

- When the password has been set for the selected device, enter it and click [OK].

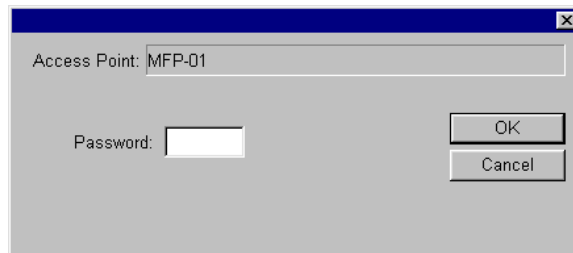

6. Click the appropriate tab and edit the parameters.

- For detailed information of the configuration menu, refer to the section "Configuration" (P.26).

7. After the setting is completed, click [Write].

8. Click [Reboot] to restart the GN-1010.

- After restarting the GN-1010, the setting becomes effective.
- Click [Read] to check whether the setting becomes effective.

FUNCTIONS OF THE UTILITY SOFTWARE

This section explains each function of the utility software.

Main Menu Screen

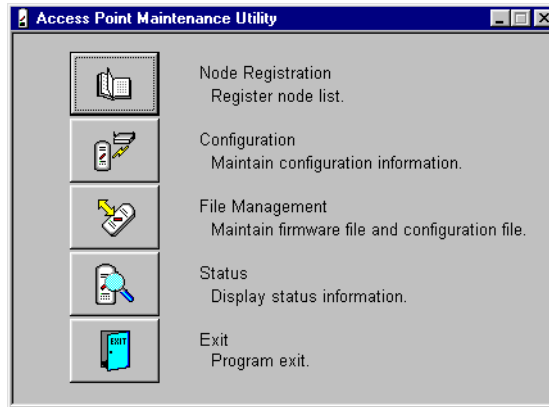

Button	Description
Node Registration	Registers data for the devices on the network. This function can detect a device on the network, and add or edit the device information. To maintain a device, its information must be registered.
Configuration	Configures a device selected in the Access Point drop-down list. This function can read and write the configuration information of the selected device. Also, it can save the current configuration information as a text-format file, and load the saved file.
File Management	Manages configuration file and firmware. This function can update the firmware version for the selected device. Also, it can read and write the configuration information. The information is treated as a text-format file.
Status	Displays information of the selected device. This function displays information such as device operating environment and sending/receiving counters.
Exit	Exits the program.

Node Registration

This function registers information of which devices exist on the network.

Since the maintenance operation such as parameter setting and firmware upgrading is performed on the basis of information entered here, you must register the appropriate information.

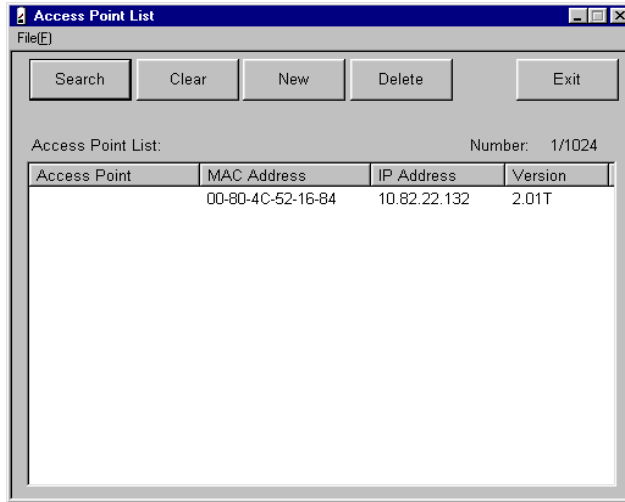

Button	Description
Search	This function automatically detects and registers all devices connected to the same network group. If you want to manage devices located on the far side of an IP router, click [New] to register each device directly.
Clear	Deletes all registered data.
New	Registers data for a new device to be managed.
Delete	Deletes data of the device selected in the Access Point List.
Exit	Returns to the main menu.

Note

- Assigning names to the devices found by the automatic search makes it easier to identify the devices on the network.
Up to 32 characters are allowed for each name. A maximum of 1024 devices can be registered.
- To modify the data displayed in the Access Point List, double-click the access point you want to modify to open the edit window.
- You can also use the "File Management" menu to save the current Access Point List data on the hard disk or load a previously saved file.

Configuration

This function sets the basic parameters such as the operating mode as well as the wireless parameters.

Configuration Screen

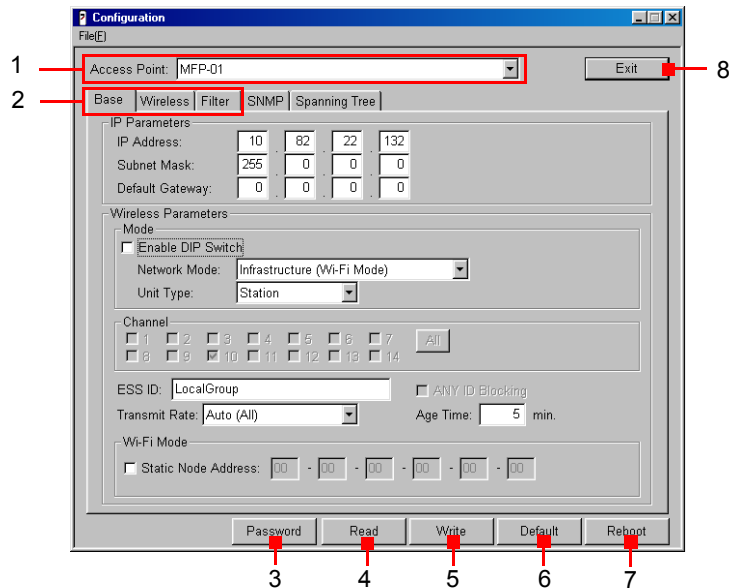

1. Access Point..... Selects the desired access point.
2. Configuration Tab Configuration menus are organized into each tab.
 - “SNMP” and “Spanning Tree” tabs are not used.
3. [Password]..... Changes the password for the selected device.
 - Up to 6 alphanumeric characters can be entered and is case-sensitive.
 - To change the password, enter the current password and new one.
 - To make the new password effective, the reboot operation is required.
4. [Read] Reads the configuration for the selected device.
5. [Write] Writes the currently displayed configuration to the selected device.
 - To make the configuration effective, the reboot operation is required.
6. [Default] Restores the factory default setting.
 - To apply the setting, write the configuration to the device and reboot it.
7. [Reboot] Reboots the selected device.
8. [Exit] Returns to the main menu.

Note

- Password entry is required for [Password], [Read], [Write], [Reboot] commands. The factory default setting has no password. In this case, you need not enter anything.
- Executing the command “[File] - [Save]” can save the currently displayed configuration on the hard disk and “[File] - [Open]” can load a previously saved file.

Base

This tab sets the IP parameters, wireless parameters and other basic operating settings for the device.

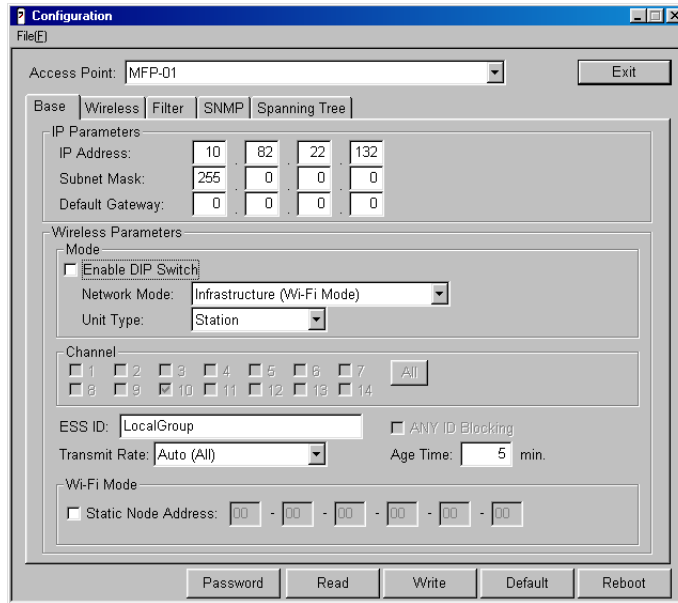

<Entry Item>

Classification	Parameter	Default Value	Description
IP Parameters	IP Address (*2)	10.xxx.xxx.xx (*1)	Enters the IP address assigned by the network administrator.
	Subnet Mask (*2)	255.0.0.0	Enters the subnet mask assigned by the network administrator.
	Default Gateway (*2)	0.0.0.0	Enters the IP address of the default gateway.
Wireless Parameters	Enable DIP Switch	Disabled	Determines whether or not the DIP switch is used. <ul style="list-style-type: none"> • Enabled/Disabled
	Network Mode	Infrastructure (Wi-Fi Mode)	Selects the wireless operating mode. <ul style="list-style-type: none"> • ADHOC (Simple Mode) • Infrastructure (Standard Mode) • Infrastructure (Wi-Fi Mode) • Infrastructure (Advanced Mode) * The GN-1010 supports "Infrastructure (Wi-Fi Mode)" only.
	Unit Type	Station	Determines the unit type. <ul style="list-style-type: none"> * Effective only when "Infrastructure" is selected in "Network Mode". <ul style="list-style-type: none"> • Station : Operates as a station (wireless terminal). • Access Point : Operates as an access point.

Classification	Parameter	Default Value	Description									
Wireless Parameters	Channel	Setting is not allowed. (10)	<p>Selects the number of wireless channels. The channels of 12 to 14 cannot be used even if selected.</p> <ul style="list-style-type: none"> • 1 to 11 <p>* Setting method differs depending on "Extended Roaming" setting.</p> <table border="1"> <thead> <tr> <th>Extended Roaming</th> <th>Station</th> <th>Access Point</th> </tr> </thead> <tbody> <tr> <td>Disabled</td> <td>Auto</td> <td>One channel only</td> </tr> <tr> <td>Enabled</td> <td>Multi-channel is allowed.</td> <td>One channel only</td> </tr> </tbody> </table>	Extended Roaming	Station	Access Point	Disabled	Auto	One channel only	Enabled	Multi-channel is allowed.	One channel only
	Extended Roaming	Station	Access Point									
	Disabled	Auto	One channel only									
	Enabled	Multi-channel is allowed.	One channel only									
	ESS ID	LocalGroup	<p>Enters the name of wireless LAN network on which the device belongs.</p> <ul style="list-style-type: none"> • Up to 32 alphanumeric (case-sensitive) <p>* Communication between the wireless devices with different names is not possible. Network can be split by changing the name.</p>									
	ANY ID Blocking	Disabled	<p>Determines whether or not the log-in from a station which has no ESS ID is refused.</p> <ul style="list-style-type: none"> • Enabled/Disabled <p>* When "Enable" is set, the log-in from a device which has no ESS ID will be refused.</p>									
Transmit Rate	Auto (All)	<p>Selects transmit speed of the wireless transmission side.</p> <ul style="list-style-type: none"> • 1Mb/s • 2Mb/s • Auto (1Mb/s, 2Mb/s) • 5.5Mb/s • 11Mb/s • Auto (All) 										
Age Time	5 min.	<p>Selects time (minutes) to keep the wireless device information (for AP only) and the MAC address information of the bridge, which are internally managed.</p> <ul style="list-style-type: none"> • 3 to 65535 <p>* If no communication occurs within the time set here, the information will be deleted.</p>										
Static Node Address	Setting is not allowed.	<p>Sets the MAC address of PC connected to Ethernet side. (For a station of "Infrastructure (Wi-Fi Mode)")</p> <ul style="list-style-type: none"> • Without MAC Address Designation • With MAC Address Designation <p>* If the MAC address is not designated, it will be automatically obtained from the communication data on Ethernet.</p>										

(*1): Factory default setting for IP address
Unique value is set by using the lower 3 bytes in 6 bytes of Ethernet address.

Ex.: Ethernet Address IP Address
00-80-4C-01-02-03 → 10.1.2.3
00-80-4C-0D-0E-0F → 10.13.14.15
The first portion "10" is the same.

(*2): When you use only the GN-1010 as a wireless device, the setting is not required. However, when using the GN-1010 together with other wireless devices or using it on the far side of an IP router, you must set these items.

Wireless

This tab sets the wireless parameters for the device.

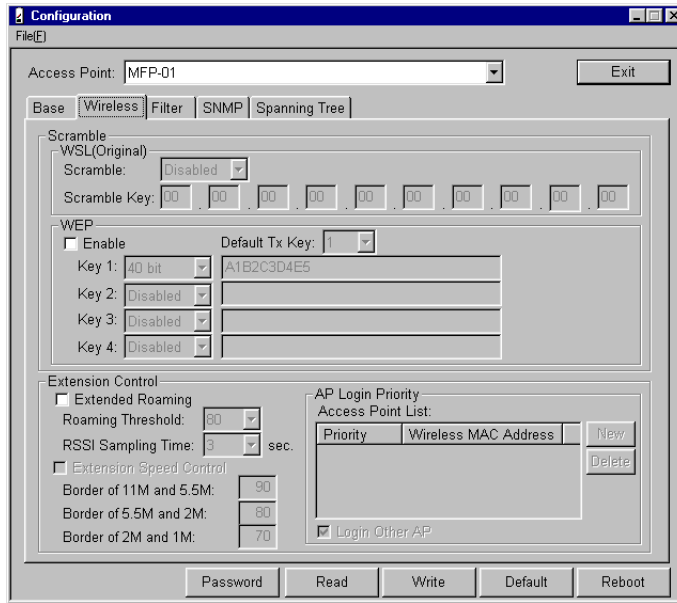

<Entry Item>

Classification	Parameter	Default Value	Description
WSL (Original)	WSL Scramble	Disabled	This function is not supported.
	WSL Scramble Key	0 to all	
WEP	WEP	Disabled	Determines whether or not the WEP function is used.
	Default Tx Key	Setting is not allowed. (1)	Selects the WEP key number to use for data transmission. <ul style="list-style-type: none"> • 1 to 4
	Key 1	Setting is not allowed. (A1B2C3D4E5 40 bits)	Sets the WEP key for WEP encryption. <ul style="list-style-type: none"> • Hexadecimal value (0 to 9, A to F) * To perform communications using the WEP function, the key placed in the default send key number used for transmission must be the same as that placed in the same location on the receiver.
	Key 2 to 4	Disabled	
Extension Control	Extended Roaming (*1)	Disabled	Sets the AP roaming method. <ul style="list-style-type: none"> • Enabled/Disabled * When enabled, "AP Login Priority" setting is allowed.
	Roaming Threshold (*2)	Setting is not allowed. (80)	Selects the threshold value to initiate roaming. <ul style="list-style-type: none"> • 50 to 150 * Roaming is performed when the average RSSI value during the RSSI sampling time is less than this value.
	RSSI Sampling Time (*2)	Setting is not allowed. (3 sec.)	Selects the sampling time (sec.) to obtain the RSSI value to initiate roaming. <ul style="list-style-type: none"> • 1 to 10

Classification	Parameter	Default Value	Description
Extension Control	Extension Speed Control	Disabled	When "Extended Roaming" is enabled, the setting is allowed. • Enabled/Disabled
	Border of 11M and 5.5M	Setting is not allowed. (90)	Sets the RSSI value as the threshold value, which is applied when the extension speed is changed from 11 Mbps to 5.5 Mbps, or vice versa in "Extension Speed Control". When "Extension Speed Control" is enabled, the setting is allowed.
	Border of 5.5M and 2M	Setting is not allowed. (80)	Sets the RSSI value as the threshold value, which is applied when the extension speed is changed from 5.5 Mbps to 2 Mbps, or vice versa in "Extension Speed Control". When "Extension Speed Control" is enabled, the setting is allowed.
	Border of 2M and 1M	Setting is not allowed. (70)	Sets the RSSI value as the threshold value, which is applied when the extension speed is changed from 2 Mbps to 1 Mbps, or vice versa in "Extension Speed Control". When "Extension Speed Control" is enabled, the setting is allowed.
	AP Login Priority (*2)	Setting is not allowed. (no registration)	Sets the preferred APs to login. * Up to 5 APs can be registered. APs in smaller numbered positions have higher priority.
	Login Other AP (*2)	Setting is not allowed. (Login)	Determines whether or not the log-in operation is permitted to non-registered APs.

(*1): Applied only to "station".

(*2): Allowed when "Extended Roaming" is enabled.

— Extended Roaming

When using the GN-1010 as a station, you can use “Extended Roaming“ function.

Extended roaming is the function which enhances the normal roaming. This allows you to specify the roaming threshold and the preferred APs to login.

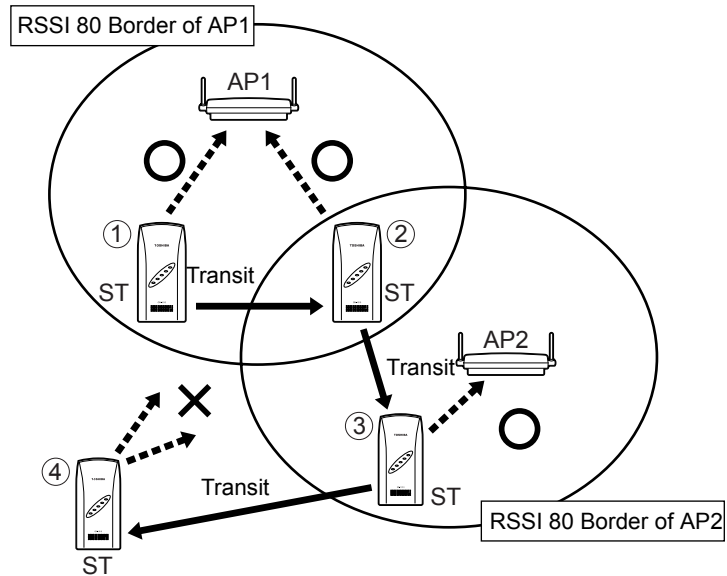

When Extended Roaming is enabled and Roaming Threshold is set to 80

- When ST transfers from 1 to 2, ST can connect with AP1 using the connection of AP1 and RSSI 80.
- When ST transfers from 2 to 3, the connection of AP1 and RSSI 80 cannot be used. Therefore, log-out is performed from AP1, then the roaming is performed to AP2 to login.
- When ST transfers from 3 to 4, the connection of AP2 and RSSI 80 cannot be used. Therefore, log-out is performed from AP2, however in this case, the wireless connection is disconnected because of lack of AP which is allowed to login.

Roaming is performed after the transfer, the following occurs if there are two or more APs which are allowed to login.

- When “AP Login Priority“ is not specified, log-in will be performed to the AP which has a higher RSSI value.
- When “AP Login Priority“ is specified, log-in will be performed to the AP which has a higher priority.

Also, when “Login Other AP“ is disabled, log-in will be allowed to only the preferred APs registered, even when there are other APs which are allowed to login.

— Extension Speed Control

“Extension Speed Control” is the function which automatically changes the transmission speed according to the RSSI value.

This lowers the speed when the RSSI value becomes low, and heighten the speed when the RSSI value becomes high.

When using the GN-1010 as a station, you can use this function.

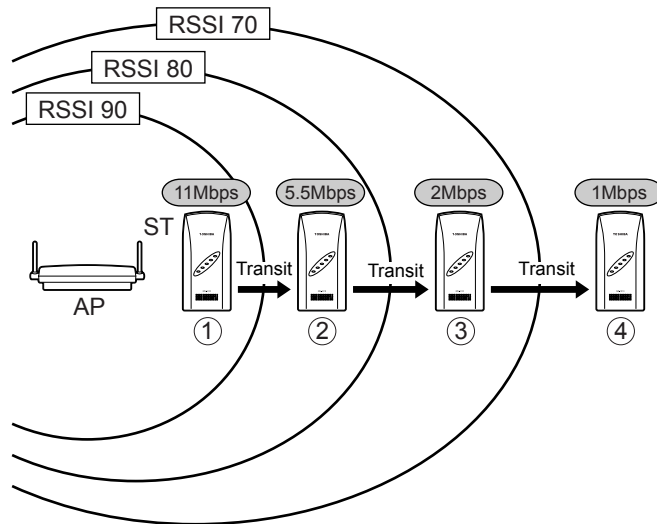

- There is a station logged in to AP at 1, with the transmission speed 11Mbps. RSSI value is retained at 90 or more.
- When the station transfers to 2 (RSSI 90 or below and RSSI 80 or more), “Extension Speed Control” function will be activated and the transmission speed will be changed to 5.5Mbps.
- When it transfers to 3 or 4, the speed will be changed to 2Mbps or 1Mbps respectively.

Filter

This tab performs the filter setting regarding MAC address and protocol.

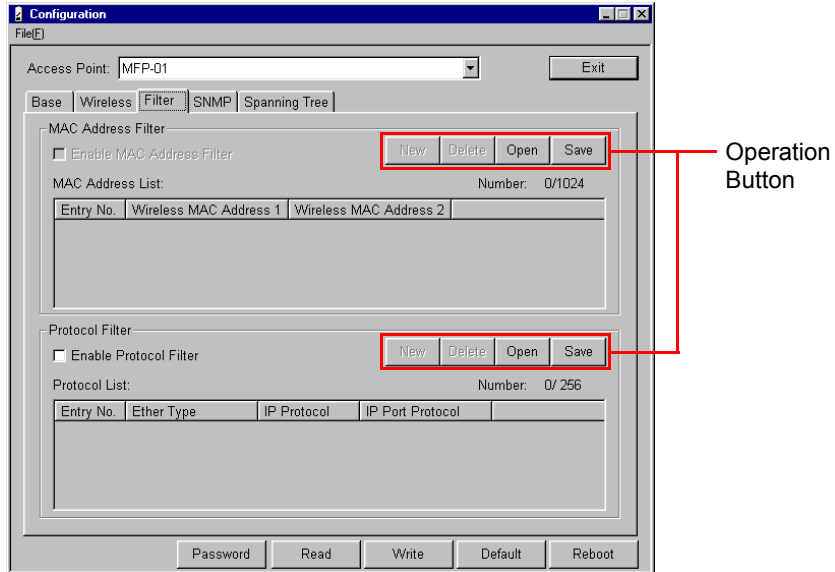

<Operation Button>

- [New]..... Creates new list.
- [Delete]..... Deletes the list previously set.
- [Open] Opens the saved list file.
- [Save]..... Saves created list.

<Display Item>

Classification	Parameter	Default Value	Description
MAC Address Filter	Enable MAC Address Filter (*1)	Disabled	Determines whether or not the MAC address filter is used. <ul style="list-style-type: none"> • Enabled/Disabled * When enabled, connection to another AP other than the clients which has the permitted MAC address is refused.
	MAC Address List (*1)	-	Displays the permitted MAC address list when “MAC Address Filter” is enabled. You can register or delete MAC address, one by one, by [New] or [Delete] command. You can also load the batch list from the list file, and save a list as the list file. Up to 1024 addresses can be registered.
Protocol Filter	Enable Protocol Filter	Disabled	Determines whether or not the protocol filter is used. <ul style="list-style-type: none"> • Enabled/Disabled * When enabled, transmission of the packet other than protocol is refused.
	Protocol List	-	Displays the permitted protocol list when “Protocol Filter” is enabled. You can register or delete protocol, one by one, by [New] or [Delete] command. You can also load the batch list from the list file, and save a list as the list file. Up to 256 protocols can be registered.

(*1) : Applied only to “access point”.

— MAC Address Filter

"MAC Address Filter" is the function to permit only user units which have MAC addresses registered in APs to login. This can refuse log-in to APs to unknown user units which have not registered.

When MAC addresses of UU1 and UU2 are registered in the MAC address filter list and the address of UU3 is not, UU1 and UU2 can login to AP, however UU3 cannot login. To permit UU3 to login to AP, the AP administrator must add MAC address of UU3 to the MAC address filter list.

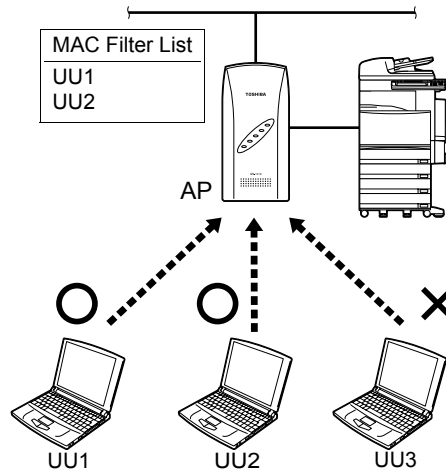

— MAC Address Filter List File

Reading the list file previously prepared allows you to register MAC addresses in "MAC Address List" in one operation.

<Regarding MAC Address Filter List File>

- File Name
LOGFLIST
- Size Specification
 - 512byte or below/Line (including space, comment, code regarding line feed)
 - 65,536byte (64Kbyte) or below/File (Approx. 1200 lines when each line contains 51byte)
- Restriction
 - You must enter the line feed command at the end of each line.
 - Addresses registered after the number reaches 1024 are all ignored.
- Comment
 - Characters following the "#" are considered as comment.
 - When entering comment after the setting contents, you must enter one or more spaces between the contents and "#".
- Line Format to specify MAC Address
 - Specified by range
NodeAddress=(Start MAC Address),(End MAC Address)
 - Specified individually
NodeAddress=(MAC Address)

<Example of LOGFLIST>

```
[AP Login Filter Tables]           # First Line Not omissible
APLoginFilter=Enabled             # Not omissible
                                   (Enabled/Disabled)
NodeAddress=00-80-4C-00-00-00,00-80-4C-FF-FF-FF
                                   #T Company (Specified by range)
NodeAddress=00-80-11-00-00-03     #A Person (Specified individually)
NodeAddress=00-80-21-00-00-04     #B Person (Specified individually)
```

For entry number, 1 is assigned to the first line of the MAC address specifying lines, then the next lines 2, 3,... are successively assigned. Note, the entry order of MAC addresses has no relationship with function.

For the value of "NodeAddress", delimit MAC address with "-" (hyphen) every 2bytes. You can specify multiple MAC addresses by range as well as specify individually. In this case, delimit between the start address and the end address with "," (comma). In the example above, all the MAC addresses in 00-80-4C-00-00-00 to 00-80-4C-FF-FF-FF are specified.

— Protocol Filter

"Protocol Filter" is the function to pass (bridge) only packets of the protocols registered in AP.

This can interrupt traffic of a protocol which is not usually used, and reduce unnecessary use of the wireless bands.

When protocol A is registered in the protocol filter list owned by AP and other protocols such as B are not, packet of protocol A can pass (bridge) through AP, however packet of protocol B is discarded when passing through AP.

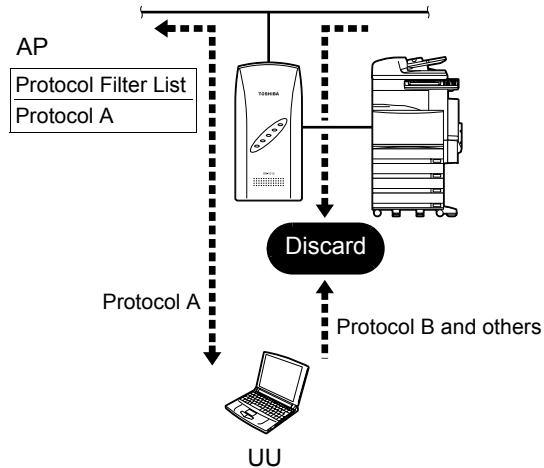

— Protocol Filter List File

Reading the list file previously prepared allows you to register protocols in "Protocol List" in one operation.

<Regarding Protocol Filter List File>

- File Name
PRTFLIST
- Size Specification
 - 512byte or below/Line (including space, comment, code regarding line feed)
 - 65,536byte (64Kbyte) or below/File (Approx. 1200 lines when each line contains 51byte)
- Restriction
 - You must enter the line feed command at the end of each line.
 - Protocols registered after the number reaches 256 are all ignored.
- Comment
 - Characters following the "#" are considered as comment.
 - When entering comment after the setting contents, you must enter one or more spaces between the contents and "#".
- Line Format to specify Protocol
 - Specified by range
ProtocolType=(Ethernet Type),(IP Protocol),
(Start Port Number),(End Port Number)
 - Specified individually
ProtocolType=(Ethernet Type),(IP Protocol),(Port Number)
 - Special Format
ProtocolType=IP,, ← Permits all the IP protocols
ProtocolType=IP,TCP, ← Permits all the TCP (Port 0 to 65535)
ProtocolType=IP,UDP, ← Permits all the UDP (Port 0 to 65535)

<Example of PRTFLIST>

[Protocol Filter Table]	# First Line Not omissible
ProtocolFilter=Enabled	# Not omissible (Enabled/Disabled)
ProtocolType=ARP,,	Permits #ARP
ProtocolType=IP,ICMP,	Permits #ICMP
ProtocolType=IP,UDP,53	Permits #DNS (UDP, Port 53)
ProtocolType=IP,TCP,80	Permits #HTTP (TCP, Port 80)
ProtocolType=IP,TCP,20	Permits #FTP-DATA (TCP, Port 20)
ProtocolType=IP,TCP,21	Permits #FTP (TCP, Port 21)
ProtocolType=IP,TCP,25	Permits #SMTP (TCP, Port 25)
ProtocolType=IP,TCP,110	Permits #POP3 (TCP, Port 110)
ProtocolType=IP,TCP,1352	Permits #Notes (TCP, Port 1352)

For entry number, 1 is assigned to the first line of the protocol specifying lines, then the next lines 2, 3,... are successively assigned.

— **Registering the MAC Address Filter**
1. Check [Enable MAC Address Filter] box.

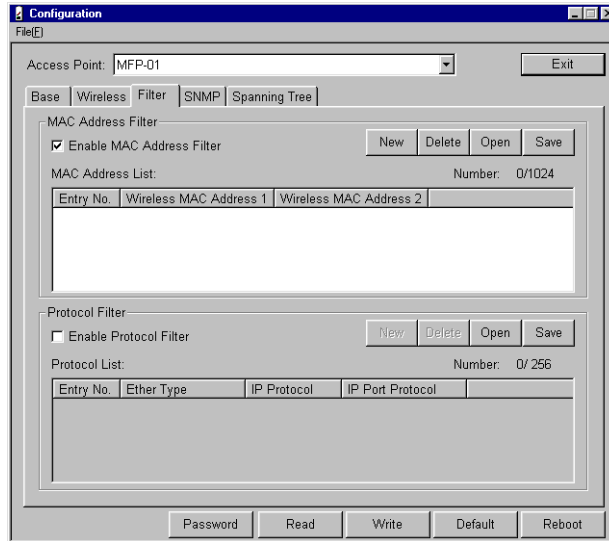

2. Click [New].

3. Enter address to [Wireless MAC Address 1].

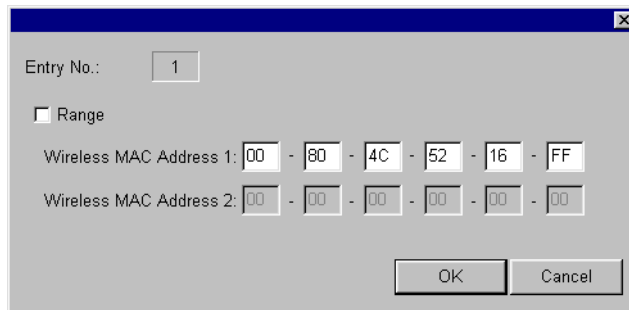

4. When specified by range, check [Range] box and enter address to [Wireless MAC Address 2].

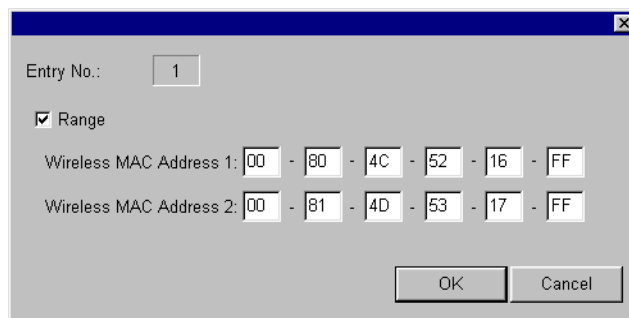

5. Click [OK].

6. Registered information is displayed on the MAC Address List.

Configuration

Access Point: MFP-01

Base | Wireless | Filter | SNMP | Spanning Tree

MAC Address Filter

Enable MAC Address Filter

New Delete Open Save

MAC Address List: Number: 1/1024

Entry No.	Wireless MAC Address 1	Wireless MAC Address 2
1	00-80-4C-52-16-FF	00-81-4D-53-17-FF

Protocol Filter

Enable Protocol Filter

New Delete Open Save

Protocol List: Number: 0/256

Entry No.	Ether Type	IP Protocol	IP Port Protocol
-----------	------------	-------------	------------------

Password Read Write Default Reboot

— Registering the Protocol Filter

1. Check [Enable Protocol Filter] box.

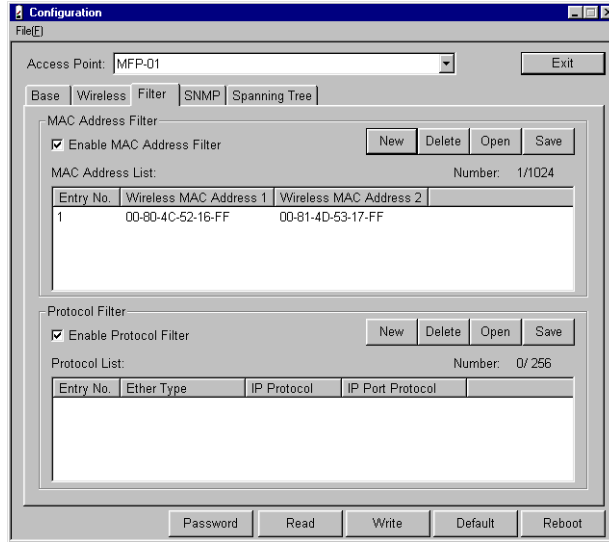

2. Click [New].

3. Select Ethernet from [Ethernet Type] drop-down list.

4. Set [IP Protocol] and [IP Port Protocol] as required.

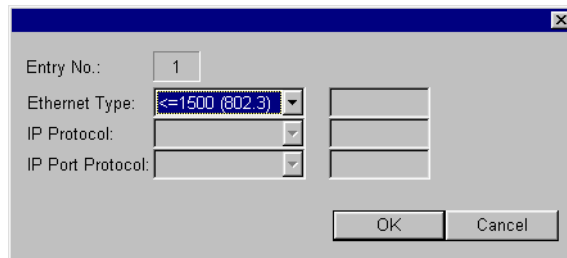

5. Click [OK].

6. Registered information is displayed on the Protocol List.

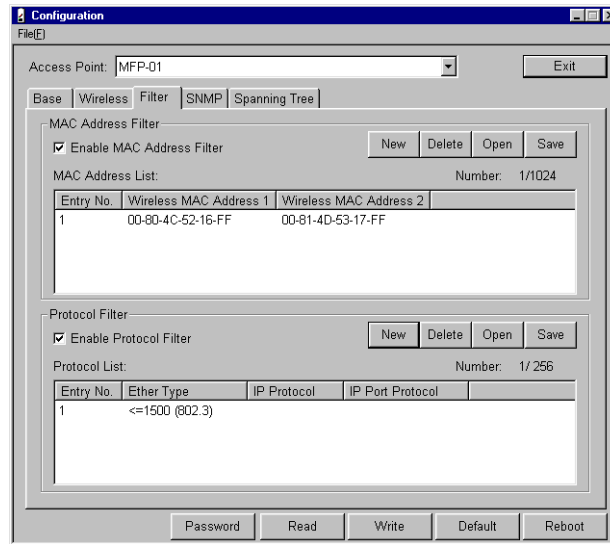

SNMP

This function is excluded from support.

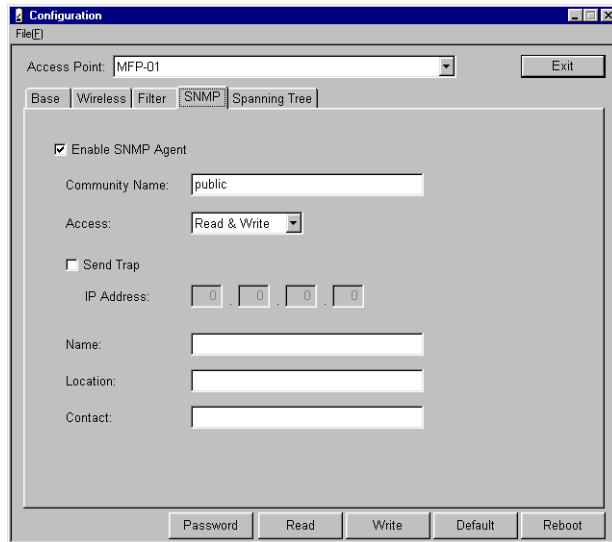

The screenshot shows the 'Configuration' window with the 'SNMP' tab selected. The 'Access Point' is set to 'MFP-01'. The 'Enable SNMP Agent' checkbox is checked. The 'Community Name' is 'public' and the 'Access' is 'Read & Write'. The 'Send Trap' checkbox is unchecked, and the 'IP Address' is '0.0.0.0'. There are empty text boxes for 'Name', 'Location', and 'Contact'. At the bottom, there are buttons for 'Password', 'Read', 'Write', 'Default', and 'Reboot'.

Spanning Tree

This function is excluded from support.

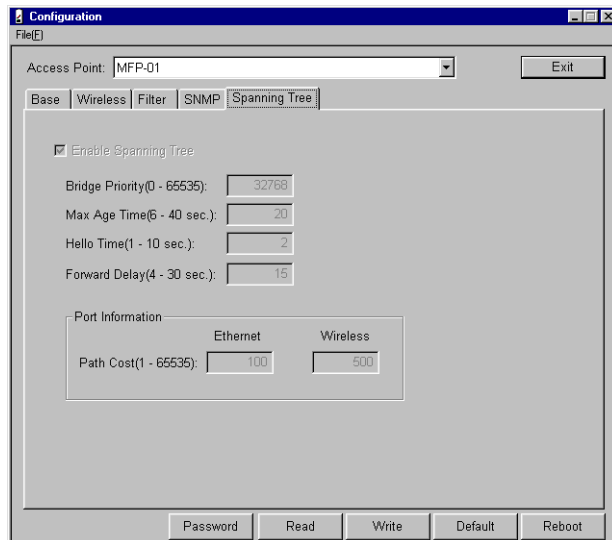

The screenshot shows the 'Configuration' window with the 'Spanning Tree' tab selected. The 'Access Point' is set to 'MFP-01'. The 'Enable Spanning Tree' checkbox is checked. The 'Bridge Priority(0 - 65535)' is '32768', 'Max Age Time(6 - 40 sec.)' is '20', 'Hello Time(1 - 10 sec.)' is '2', and 'Forward Delay(4 - 30 sec.)' is '15'. The 'Port Information' section has 'Ethernet' and 'Wireless' sub-sections. The 'Path Cost(1 - 65535)' is '100' for Ethernet and '500' for Wireless. At the bottom, there are buttons for 'Password', 'Read', 'Write', 'Default', and 'Reboot'.

File Management

This function is used to obtain the version numbers of the devices connected to the network and to upgrade the firmware or read/write the settings file for the device selected on the "Access Point List".

If upgrading the firmware is attempted using the files other than specified, performance will not be guaranteed. Ensure that you use only the specified file.

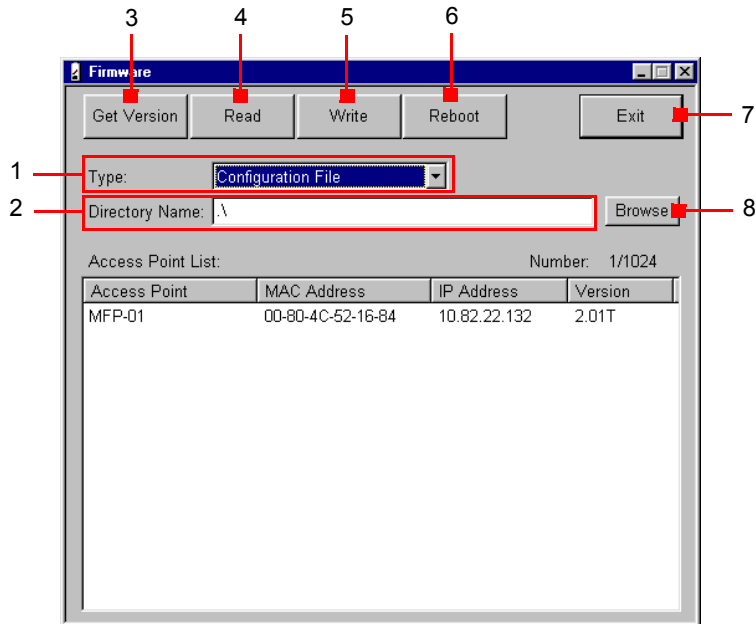

1. [Type]..... Selects setting file.
Firmware/Configuration File/Firmware (Wireless Card)/
MAC Address Filter File/Protocol Filter File
2. [Directory Name] Selects file name or directory name.
3. [Get Version]..... Obtains the version information.
 - This obtains the version information from all the devices connected to the same network group, or from only the designated device.
 - To obtain data from a device which exists beyond the IP router, always select the device first. In this case, the IP parameter must be set correctly.
4. [Read] (*1) Reads the firmware and setting file, then saves them on the hard disk.
5. [Write] (*1) Writes the firmware and setting file saved on the hard disk to the selected device.
6. [Reboot]..... Reboots the selected device.
7. [Exit] Returns to the main menu.
8. [Browse] Browses file name or directory name.

(*1): The file name contains the lower 3 bytes of MAC address of the selected device.
(Ex.) [00-80-4C-4D-20-5E] → [4D205E.TXT]

Status

This function periodically reads operational data including send and receive counters from the device specified in "Access Point" and displays it on the screen.

Common Items

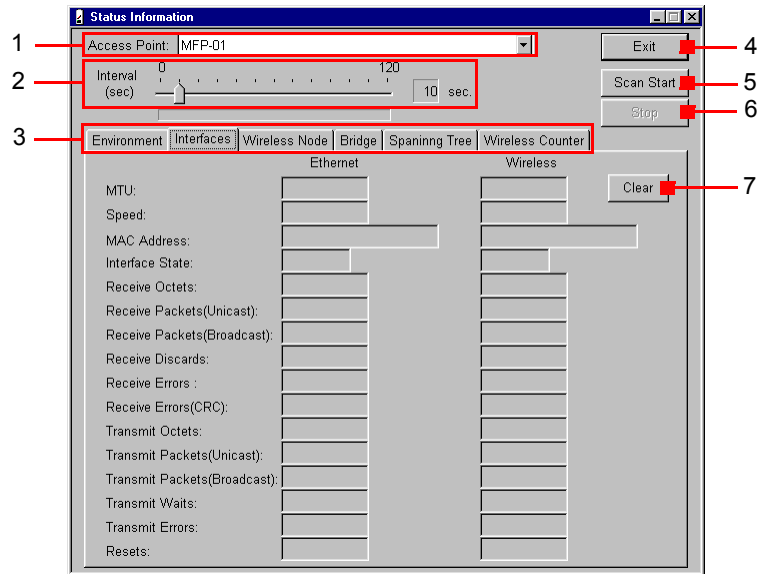

1. Access Point..... Selects access point to obtain the status information.
2. Interval..... Sets the refresh interval to read information. (0 to 120 sec.)
3. Information Tab..... Status information items are organized into each tab.
4. [Exit] Returns to the main menu.
5. [Scan Start]..... Periodically reads and displays information (the refresh interval is specified in "Interval").
 - * When "Interval" is "0", information is read only once.
6. [Stop]..... Stops reading information. (Scan Stop)
7. [Clear]..... Clears the displayed information.
 - * You can operate this when scanning is stopped.
 - * For the items without displaying [Clear], you cannot clear information corresponding to them.

Environment

This tab displays device information including operating mode, version number, and IP address.

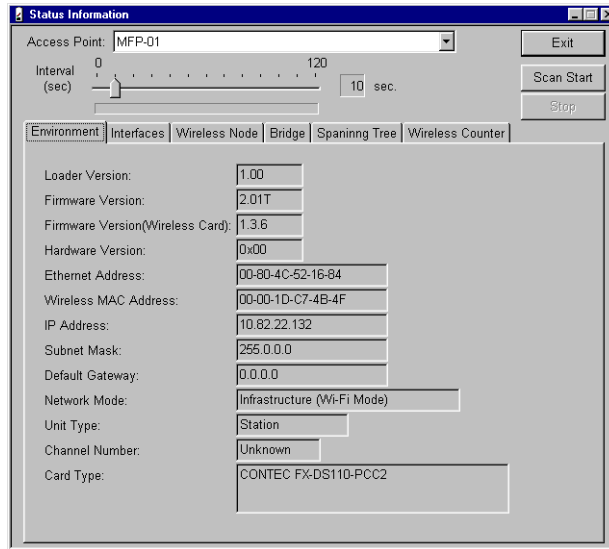

<Display Item>

Parameter	Description
Loader Version	Version number of program to execute firmware
Firmware Version	Version number of firmware
Firmware Version (Wireless Card)	Version number of wireless card firmware
Hardware Version	Version number of hardware
Ethernet Address	Ethernet address assigned to this device
Wireless MAC Address	Wireless MAC address assigned to this device
IP Address	Current IP address of this device
Subnet Mask	Current subnet mask
Default Gateway	Current default gateway IP address
Network Mode	Current operating mode
Unit Type	Current unit type
Channel Number	Current wireless channel number
Card Type	Wireless card type

Interfaces

This tab displays data such as send and receive counters for the device's Ethernet and wireless interfaces.

The screenshot shows a window titled "Status Information" with a tabbed interface. The "Interfaces" tab is selected. At the top, there is a dropdown menu for "Access Point" set to "MFP-01", an "Interval (sec)" slider set to 10, and buttons for "Exit", "Scan Start", and "Stop". Below the tabs, there are two columns of statistics: "Ethernet" and "Wireless". Each column has a "Clear" button. The statistics include MTU, Speed, MAC Address, Interface State, Receive Octets, Receive Packets (Unicast/Broadcast), Receive Discards, Receive Errors, Transmit Octets, Transmit Packets (Unicast/Broadcast), Transmit Waits, Transmit Errors, and Resets.

	Ethernet	Wireless
MTU:	1500	1500
Speed:	10000000	11000000
MAC Address:	00-80-4C-52-16-B4	00-00-1D-C7-4B-4F
Interface State:	up	down
Receive Octets:	5140510	0
Receive Packets(Unicast):	0	0
Receive Packets(Broadcast):	78249	0
Receive Discards:	0	0
Receive Errors:	0	0
Receive Errors(CRC):	0	0
Transmit Octets:	137262	481500
Transmit Packets(Unicast):	0	0
Transmit Packets(Broadcast):	115	8025
Transmit Waits:	0	0
Transmit Errors:	0	8025
Resets:	0	243

Note

- Interface information can be cleared when scanning is stopped.

<Display Item>

Parameter	Description						
MTU	Maximum data size transmittable						
Speed	Transmission speed of data to be sent						
MAC Address	MAC address assigned to this interface						
Interface State	Interface operating state <table border="1" style="margin-left: 20px;"> <thead> <tr> <th>State</th> <th>Description</th> </tr> </thead> <tbody> <tr> <td>up</td> <td>Operating</td> </tr> <tr> <td>down</td> <td>Not operating or not linked</td> </tr> </tbody> </table>	State	Description	up	Operating	down	Not operating or not linked
State	Description						
up	Operating						
down	Not operating or not linked						
Receive Octets	Number of bytes received						
Receive Packets	Number of packets received						
Receive Discards	Number of packets discarded due to insufficient memory						
Receive Errors	Number of packets with receive errors						
Receive Errors (CRC)	Number of packets received with CRC error * If this error occurs frequently on the wireless interface, this may indicate that communication is performed with a device which has a different encryption setting.						
Transmit Octets	Number of bytes transmitted						
Transmit Packets	Number of packets transmitted						

Parameter	Description
Transmit Waits	Number of packets waiting to be transmitted
Transmit Errors	Number of packets with transmit errors
Resets	Number of times for which this interface has been reset

Wireless Node

This tab displays a list of logged-in wireless devices and associated data such as link quality.

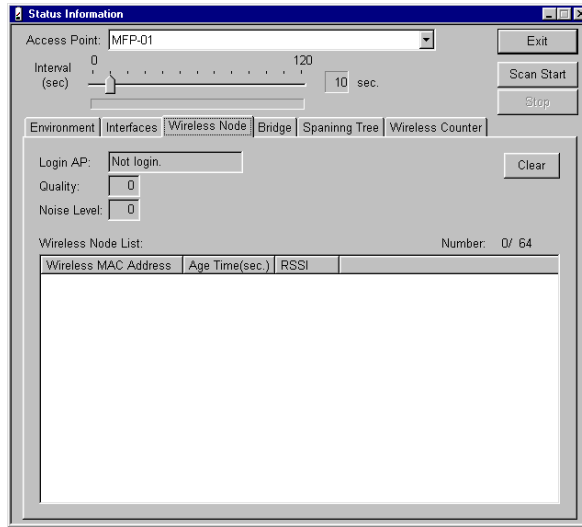

Note

- “Wireless Node List” can be cleared when scanning is stopped.

<Display Item>

Parameter	Description
Login AP (*1)	MAC address of currently logged-in AP
Quality (*1)	Link quality between this device and logged-in AP
Noise Level (*1)	Noise level on station side
Wireless Node List	<ul style="list-style-type: none"> • Unit type: station: Information of logged-in AP • Unit type: AP: Information of wireless device
Wireless MAC Address	MAC address of wireless device
State	Login state; applicable when infrastructure mode is set.
Age Time	Time to retain device information (sec.) * It is retained while the device is communicating. When the time reaches "0", it will be deleted.
RSSI	Reception level for device (Max. 150) * Higher values indicate higher reception sensitivity.

(*1) Applicable when a device operates as a station.

Bridge

This tab displays the MAC address information managed by this device.

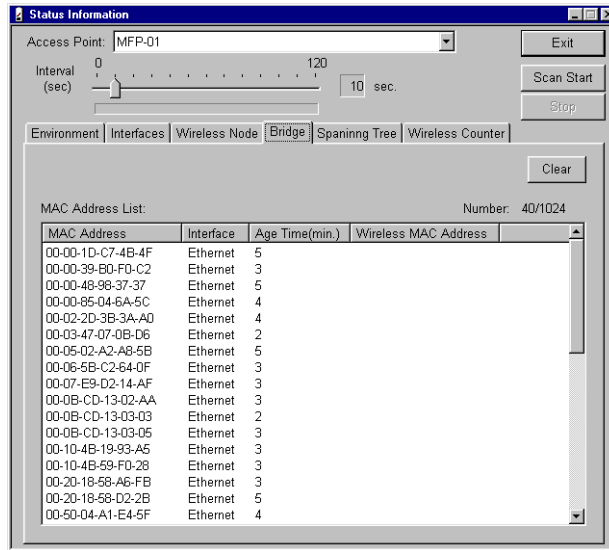

Note

- "MAC Address List" can be cleared when scanning is stopped.

<Display Item>

Parameter	Description
MAC Address	MAC addresses of devices connected to the network
Interface	Displays the device is on either Ethernet side or wireless side. <ul style="list-style-type: none"> • Ethernet/Wireless
Age Time	Time for which this device information is retained. (minute) * Retained while this device is communicating. When the time reaches "0", it will be deleted.
Wireless MAC Address	MAC addresses of logged-in wireless devices * Displayed when device is on wireless side.

Spanning Tree

Information of this tab is excluded from support.

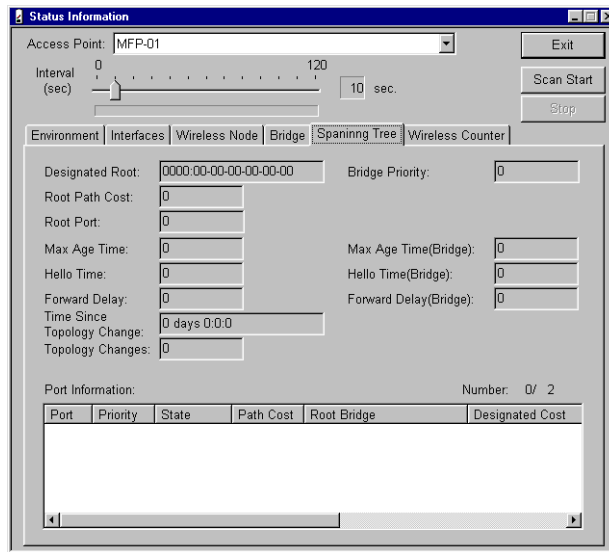

Wireless Counter

This tab displays the number of packets, errors received or transmitted on wireless communication.

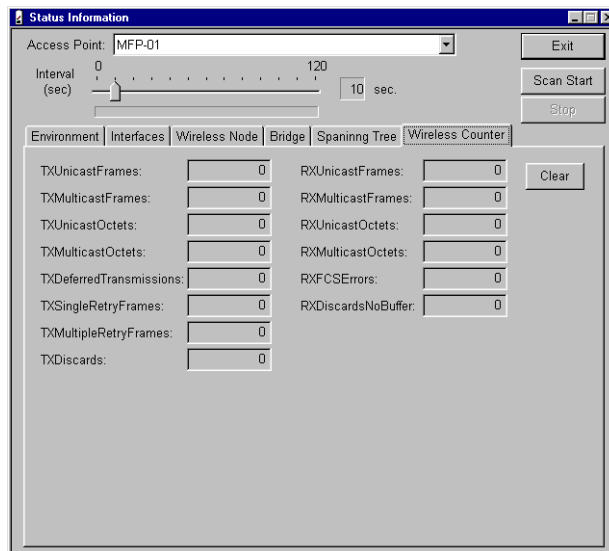

Note

- Wireless counter information can be cleared when scanning is stopped.

<Display Item>

Parameter	Description
TX Unicast Frames	Number of packets transmitted by another station using unicast address
TX Multicast Frames	Number of packets transmitted by another station using multicast address
TX Unicast Octets	Number of data bytes transmitted by another station using unicast address
TX Multicast Octets	Number of data bytes transmitted by another station using multicast address
TX Deferred Transmissions	Number of packets for which the transmission is delayed
TX Single Retry Frames	Number of packets retransmitted only once
TX Multiple Retry Frames	Number of packets retransmitted multiple times
TX Discards	Number of packets discarded
RX Unicast Frames	Number of packets received by another station using unicast address
RX Multicast Frames	Number of packets received by another station using multicast address
RX Unicast Octets	Number of data bytes received by another station using unicast address
RX Multicast Octets	Number of data bytes received by another station using multicast address
RX FCS Errors	Number of packets with FCS (Frame Check Sequence) errors
Rx Discard No Buffer	Number of packets with buffer errors

TROUBLESHOOTING

This chapter describes common problems which may occur with this product and how to handle them.

If any problems other than described here occur, check to confirm the re-occurrence. Then, contact TOSHIBA authorized dealer or service engineer.

When Communication Fails

Check Software

- Check if the LAN cables are connected correctly.
- Check if the DIP switch is set correctly.
- Check if the terminals which cannot communicate with each other have the same ESS ID. Two terminals with different ESS ID cannot communicate with each other.
- Check if the IP address and subnet settings have been entered.
- Check if the operating mode setting has been correctly entered.
- Check whether or not communication is restricted by security functions.
- Check whether or not the WEP key setting is the same as that of the recipient device.

If the key placed in the default send key number used for transmission is different from that placed in the same location on the recipient device, communication will not be performed.

- Check if the channel setting has been correctly entered.
- Check if the communication speed setting has been correctly entered.

Check Peripheral Environment or Installation Location

- A nearby source of electromagnetic interference can prevent communication. In general locations (excluding factories) the following may be sources of electromagnetic emissions.
 - 2.4GHz band wireless networks not compatible with IEEE 802.11b.
 - Microwave ovens
 - Security gates
 - Elevator motors
- Sometimes communication is hindered by attenuation of electric waves. Attenuation occurs naturally as distance from the source of transmission increases, but may also be caused by objects in the path of the transmission. The objects primarily responsible for attenuation are the following.
 - Concrete walls
 - Metallic surfaces around antennas

Note

- Most electromagnetic sources other than wireless networks are local and not continuous, and therefore by moving the location of the unit and waiting briefly, communication may be possible. Also, do not place wireless devices too close together. A distance of at least 1m should be allowed.
- Stable transmission at 11Mbps requires an RSSI value of at least 80. The RSSI value can be verified on the Wireless Device Information tab on the Status screen using the utility software.

When Device Cannot Be Detected Automatically By Node Registration

When the utility software cannot automatically detect the device, check the following.

- Check the connection between the device and PC which executes the utility software, referring to the section "Connecting between the GN-1010 and PC" (P.18).
- Check the DIP switch setting.
- When the PC which executes the utility software is the DHCP client, exit the software. When approx. 1 minute has passed, open the software again.

When Device Does Not Start

Check Power LED

- Check that the power LED is on.
<When extinguished>
 - Check if the AC adapter is correctly plugged into the power supply connector and an outlet.
 - Check if the power supply switch is in "DC" side.
- Check whether or not the power LED is flashing.

<When flashing>

If the power LED is still flashing more than 10 minutes after the power is turned on, the problem may be a device firmware failure. Use the utility software to upgrade the firmware version.

APPENDIX

Product Specifications

External Dimensions

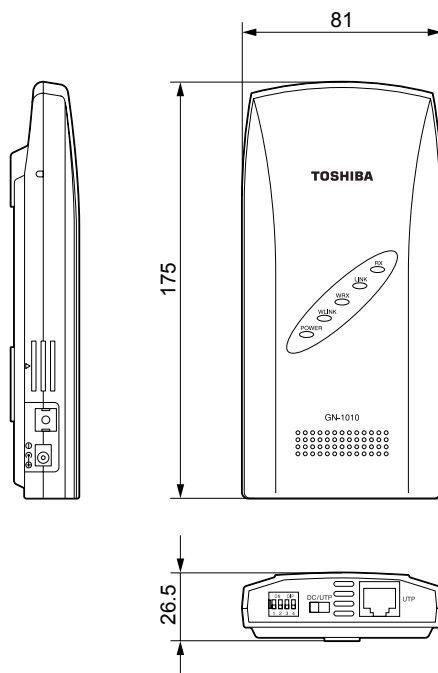

[Unit: mm]

Physical Specifications

Item	Description	
Wired LAN Unit	Ethernet Standard	IEEE 802.3
	Data Transmission Speed	10Mbps
	Access Method	CSMA/CD
Wireless LAN Unit	Transmission Format	IEEE 1802.11b standard DS spectrum diffusion
	Data Transmission Speed	11, 5.5, 2, 1Mbps (fixed/automatic)
	Access Method	CSMA/CA + ACK (RTS/CTS)
	Transmission Packet	IEEE 802.11b frame
	Wireless Category	Low-power data transmission system (2400 to 2472MHz)
	Aerial Power	10mW/MHz or below
	Security	WEP
Operating Mode		Infrastructure/access point settings available
External Dimensions (mm)		81 (W) x 26.5 (D) x 175 (H)
Weight		0.2kg

Software Specification

Item	Description
Protocols	IP (RFC 791), ICMP (RFC 792), UDP (RFC 768), ARP (RFC 826), SNMP (RFC 1157), MIB II (RFC 1213)

Installation Environment Conditions (Environment Specifications)

Item	Description
Supply Voltage	5.5 to 7.0 VDC (using AC adapter)
Consumption Current	0.6A (Max.)
Operating Temperature	0 to 50°C (main unit), 0 to 40°C (AC adapter)
Operating Humidity	10 to 90% (without condensation)
Airborne dust	Not extreme
Corrosive Gas	None
Other	Do not obstruct ventilation slits. Leave 5 cm open space in all directions.

Input/Output Interface

- UTP Port Pin Assignments

Pin No.	Signal
1	TD+
2	TD-
3	RD+
4	Unused (VCC) *1
5	Unused (GND) *1
6	RD-
7	Unused (VCC) *1
8	Unused (GND) *1

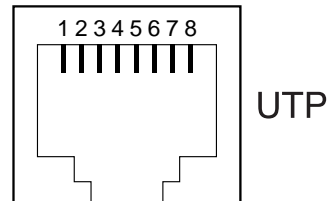

*1: When power is supplied from 10BASE-T

Glossary

AP (Access Point)

Access points serve as the bridge between wired networks and wireless networks, as well as providing bridge functions between segments and IP tunnel functions indispensable to the building of versatile, large-scale networks.

CSMA/CA (Carrier Sense Multiple Access with Collision Avoidance)

CSMA is a method of avoiding collision by which wireless terminals listen before transmitting and do not transmit if they can hear transmissions from other wireless terminals. CSMA/CA is CSMA plus additional collision avoidance functions.

DS (Direct Sequence)

A type of spectrum diffusion signal using narrow band modulation with phase modulation, in which the diffusion is by means of phase modulation using a broad band diffusion signal (pseudo random strings).

ESS ID (Extended Service Set ID)

In the GN-1010 series, the ESS ID is similar to a name assigned to the wireless LAN network to which a unit belongs. Communication between wireless terminals which have different names cannot be performed.

Wireless network can be partitioned by using different ESS ID names.

IEEE (Institute of Electrical Electronics Engineers)

"I-triple-E," involved in a wide range of fields from communications and computer to medicine and biology, with primary activities related to publishing articles and sponsoring conferences, but also recommending and setting of standards.

The organization sponsoring Committee 802 which is responsible for LAN related matters.

IEEE 802.11/IEEE 802.11b

The wireless LAN standard established by the IEEE.

LAN (Local Area Network)

A network configured from mutual connections between computers within a limited area.

Also called an "intranet" or "business or regional data communications network."

RSSI (Receive Signal Strength Indication)

A numeric indicator of incoming signal strength.

RTS (Request To Send)

In communication via AP, transmission is controlled by CSMA/CA plus RTS. In RTS, a wireless terminal asks the AP if it is able to transmit, and only transmits after an OK-to-send acknowledgement signal is returned. This serves to avoid unnecessary collisions when hidden terminals exist because hidden terminals cannot transmit.

Infrastructure

System to integrate wireless LAN with wired LAN

Spectrum Diffusion Transmission

A method of transmission in which signals that are normally transmitted over a given limited frequency band undergo narrow band modulation (primary modulation), then again diffuse modulation (secondary modulation) to intentionally diffuse the signal over a broad frequency spectrum.

Channel

This term has the same meaning as a television or radio channel. In the 2.400 to 2.472GHz ISM band used by this product, the IEEE 802.11 standard provides for division into 11 channels numbered 1 to 11. Even on the same network, wireless devices operating on different channels cannot communicate with each other.

Bridge

A device for relaying between LAN's. The bridge determines whether to relay data based on the address of the computer to which the data is being sent. It can be used to connect networks having different protocols, or when data for broadcast to all computers is received, can send this to all connected networks.

Router

A device for relaying between LAN's. The router determines data addresses by the combination of a network address assigned to the network and an individual computer address. Used particularly in medium-scale and larger LAN systems with very large number of clients, to reduce traffic (congestion) on communication lines.

Roaming

This term has the same meaning as roaming for a portable phone or PHS. The AP is in the role commonly called the "antenna/base station" for the phone or PHS, and the user unit is in the role of the phone itself.

EU Declaration of Conformity

Application of Council Directive: R&TTE Directive 1999/5/EC
 EMC:89/336/EEC
 Low Voltage:73/23/EEC
 As last amended by EEC Directive:93/68/EEC

Standards to which
 Conformity is Declared: *[Radio]*
 EN300 328-2:2000
[EMC]
 EN55022:1994(Class B)
 EN61000-3-2:1995/A1:1998/A2:1998
 EN61000-3-3:1995
 EN301 489-17 v.1.2.1
 EN55024:1998
 EN61000-4-2:1995[contact: level2(± 4 kV), air: level3(± 8 kV)]
 EN61000-4-3:1995[level2(3V/m)]
 EN61000-4-4:1995
 [power lines: level2(± 1 kV), signal lines: level2(± 0.5 kV)]
 EN61000-4-5:1995[power lines: class3]
 EN61000-4-6:1995[level2(3V)]
 EN61000-4-11:1994
[Low Voltage]
 EN60950:2000

Manufacturer's Name : CONTEC CO.,LTD.

Manufacturer's Address : 3-9-31, Himesato, Nishiyodogawa-Ku, Osaka 555-0025, JAPAN

Type of Equipment : Wireless LAN Accesspoint

Model Number: FX-DS110-APL

Certificate No: Project No. 200134180

Document No: TCF No. A-40-598 (TECHNICAL CONSTRUCTION FILE)

Date : August 8, 2003

Signature : Takao Kanemaru

Full Name : TAKAO KANEMARU

Position : DIRECTOR PRODUCT DEPT.

MEGFELELŐSÉGI NYILATKOZAT

(Rádióberendezések és távközlő végberendezések (RTTE) forgalomba hozatala¹ esetén)

Technotrade Informatikai Rt.

Mi,

(a magyarországi gyártó, -képviselő vagy -importáló neve)

1147 Budapest Őv u. 185 ; 01-10-043145

(székhelye és a cégbejegyzés/vállalkozói igazolvány száma)

egyedül, saját felelősségünkre kijelentjük, hogy az alábbi termék

Wireless LAN Adapter(Wireless Converter for Digital Copier Machine) Model: FX-DS110-APL

(termék típusa, modellje, rendeltetése, egyedi berendezésnél a gyártási száma)

CONTEC CO., LTD

3-9-31, Himesato, Nishiyodogawa-ku, Osaka 555-0025, JAPAN

(a termék eredete, a gyártó neve, címe)

amelyre e nyilatkozat vonatkozik, megfelel a rádióberendezésekről és a távközlő végberendezésekről, valamint megfelelőségük elismeréséről szóló 3/2001 (I. 31.) MeHVM rendelet 3. §-ában foglalt alapvető követelményeknek, valamint az alábbi távközlési (rádiótávközlési), villamos biztonságtechnikai és elektromágneses összeférhetőségi követelményeket tartalmazó szabványoknak, illetőleg egyéb normatív dokumentumoknak:

EN 300 328-2:2000

(távközlési)

EN 60950:2000

(biztonsági)

EN 55022:1994, EN 55024:1998, EN 61000-3-2:1995+A1:1998+A2:1998,

EN 61000-3-3:1995, ETS 300 826:1997

(EMC)

(az európai harmonizált, vagy a magyar nemzeti szabványok, illetőleg normatív dokumentumok pontos megjelölése).

Rádióberendezés², illetőleg nem szabványos termék esetén a tanúsító szerv neve, száma, a tanúsítvány száma:

Notified Body: Nemko (NB ID: 0470)



MULTIFUNCTIONAL DIGITAL COLOR SYSTEMS
Operator's Manual for Wireless LAN Adapter

GN-1010

TOSHIBA TEC CORPORATION

1-1, KANDA NISHIKI-CHO, CHIYODA-KU, TOKYO, 101-8442, JAPAN

Free Manuals Download Website

<http://myh66.com>

<http://usermanuals.us>

<http://www.somanuals.com>

<http://www.4manuals.cc>

<http://www.manual-lib.com>

<http://www.404manual.com>

<http://www.luxmanual.com>

<http://aubethermostatmanual.com>

Golf course search by state

<http://golfingnear.com>

Email search by domain

<http://emailbydomain.com>

Auto manuals search

<http://auto.somanuals.com>

TV manuals search

<http://tv.somanuals.com>