

TOSHIBA



**TOSHIBA AMERICA INFORMATION SYSTEMS
STORAGE DEVICE DIVISION
IRVINE, CALIFORNIA**

**SD-M1502
DVD-ROM DRIVE
USER MANUAL**

CONTENTS

Introduction.....	1
Setup	3
Using the DVD-ROM Drive	6
Troubleshooting.....	8
Specifications	9
Drive Connectors.....	13

INTRODUCTION – SD-M1502 DVD-ROM Drive

General Features

Tray Loading Mechanism

3-way Disc Eject (eject button, software, emergency eject hole)

Average Random Access Time

CD-ROM	85ms
DVD	115ms

DAE (Digital Audio Extraction) Audio Capability

MPC3 Compatibility

Multi-Read Capability

Regionalization (RPC2 compliance) (DVD)

ATAPI BUS Interface

Drive Speed

DVD	16X Single Layer
	10X Dual Layer
CD	48X

Types of Disc Formats Supported

DVD

- DVD-ROM
 - DVD-5 - Single-sided/Single Layer
 - DVD-9 - Single-sided/Dual Layer
 - DVD-10 - Double-sided/Single Layer
 - DVD-18 - Double-sided/Dual Layer
- DVD-R

CD

- CD-DA
- CD+(E)G
- CD-MIDI
- CD-TEXT
- CD-ROM
- CD-ROM-XA
- CD-I Bridge (Photo-CD, Video CD)
- CD-I
- Multi-session (Photo-CD, CD Extra, CD-RW, CD-R)
- CD-R (Read)
- CD-RW (Read)

Front Panel

Figure 1.SD-M1502 DVD-ROM Drive Front Panel

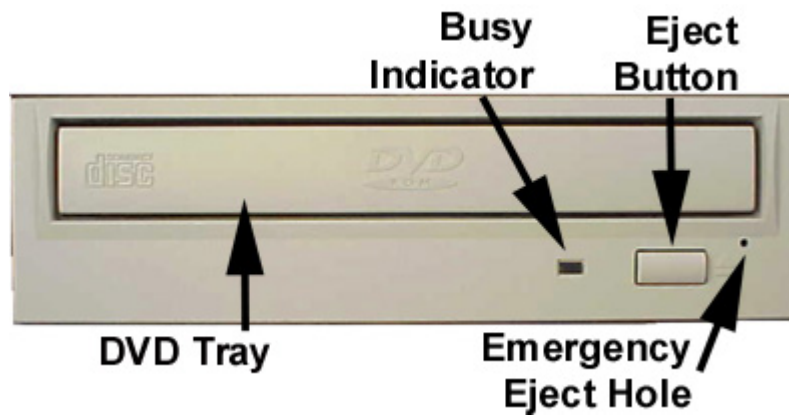

Loading Tray Load disc using tray.

Busy Indicator When you install a disc into the DVD-ROM drive, the BUSY light flashes slowly as it attempts to locate the disc. One of the following will occur:

- BUSY light goes out. The DVD-ROM drive is ready to read data from the disc.
- BUSY light flashes slowly. The disc may be dirty.
- BUSY light remains ON. The DVD-ROM is accessing data.
- BUSY light remains ON indefinitely. The DVD-ROM is experiencing an error

Eject Button The Eject button is used to open the disc tray so you can install or remove a disc.

Emergency Eject Hole The emergency eject hole is to be used only when the Loading Tray will not open when Eject button is pressed.

SETUP – SD-M1502 DVD-ROM

The following steps must be performed to properly install your drive:

- Set Drive Jumper Settings
- Connect Audio Cable (*optional*)
- Attach IDE BUS Cable
- Attach Power Cable
- Mount Drive

Jumper Settings

The mode select jumpers are 6 straight angle pins located on the rear of the DVD-ROM drive. By placing a jumper on the pins, you can select the following functions:

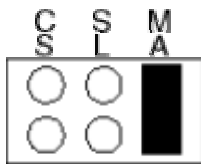

- CS Drive is configured using host interface signal CSEL
- SL Configures drive as Slave
- MA Configures drive as Master (default mode)

Figure 1. Mode Select Jumper

In most installations, jumper should remain in the MA position (factory default). It is recommended that you install your DVD-ROM drive only on the secondary IDE BUS. If you are installing on primary IDE BUS, your hard drive would then be the Master, and you should set your DVD-ROM drive to the Slave position (SL)

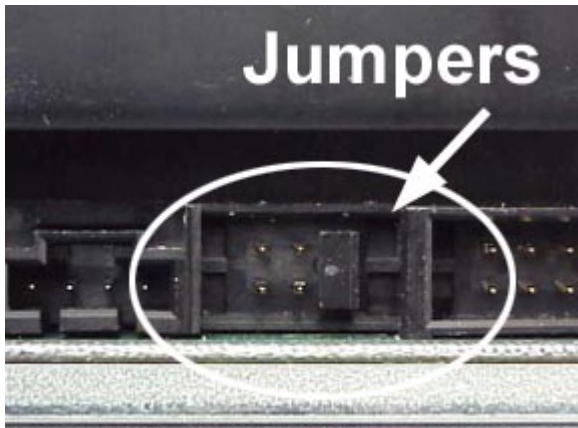



Figure 2. Jumper Locations

Placing DVD-ROM Drive inside your Computer

Now that you have set the jumpers, you are ready to install your DVD-ROM drive inside your computer.

 **Important Note: Disconnect power from your computer system before beginning installation.**

Remove computer cover and faceplate if required. Refer to your computer systems manual for removal information. If the DVD-ROM drive is replacing a CD-ROM or DVD-ROM, remove drive presently installed in your system.

Your Toshiba DVD-ROM drive can be placed in any free half-height drive slot at the front of your computer. (It can be mounted horizontally or vertically.)

Carefully start sliding the DVD-ROM drive into the opening with the disc tray facing the front of the computer. Before you push the drive all the way in you will need to connect the IDE BUS cable, Audio cable and the Power cable on the back of the drive.

Connecting Cables

IDE BUS Cable (not supplied with drive) - Your computer system should have a primary and secondary IDE BUS, cable with your Hard Drive most likely being the Master on the primary BUS. Connect BUS cable as follows, assuring that pin 1 of cable (side with red stripe) is connected to pin 1 of the DVD-ROM drive's interface connector:

If you are replacing your CD-ROM or DVD:
connect DVD-ROM drive to the BUS Cable connector that the CD-ROM or DVD was connected to.

If DVD-ROM drive is not replacing a CD-ROM/DVD or is an addition to a CD-ROM/DVD:
connect DVD-ROM drive to an open connector on the secondary IDE BUS cable (not supplied with drive).

If DVD-ROM drive is to be slave on Primary BUS:
connect DVD-ROM drive to open connector on the primary IDE BUS cable (not supplied with drive).

Figure 3. Installing BUS Cable



Power Cable - Connect an internal computer power supply cable to the power socket at the back of the DVD-ROM drive. One side of the plug has chamfered edges, so the power connector fits only one way. Push plug completely into the socket making sure the plug fits correctly.

Figure 4. Installing Power Cable



Audio Cable (optional) - If you have a sound card and speakers, and would like to play audio CDs on your computer, you will need to install a CD/DVD audio cable. Toshiba's DVD-ROM drives use a standard 4-pin audio cable that can be purchased from most local computer suppliers. The sound cable connects to your sound card at one end and the other end connects to the digital audio connector at the left rear of the DVD-ROM drive (see DVD-ROM drive Back Panel photo for location). Refer to the instructions that came with your sound card for details on any sound-driver software required.

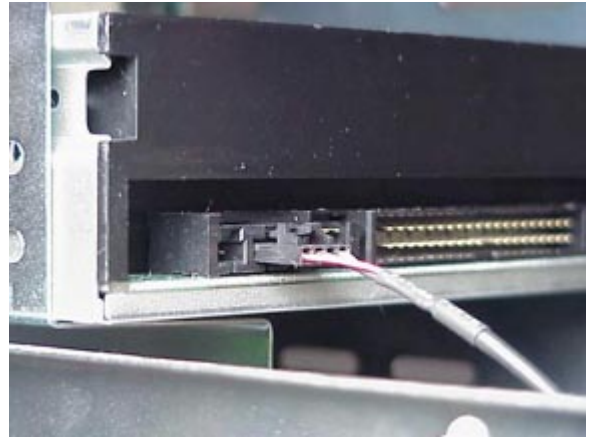

Figure 5. Installing Audio Cable

Completing Installation

After you have connected all the necessary cables, push the DVD-ROM drive completely into the computers drive slot. Mount drive per your computers instructions. The screw length should not exceed 30.5mm (measured from outside surface of side or bottom of drive to tip of screw). Replace computer cover and all outer screws.

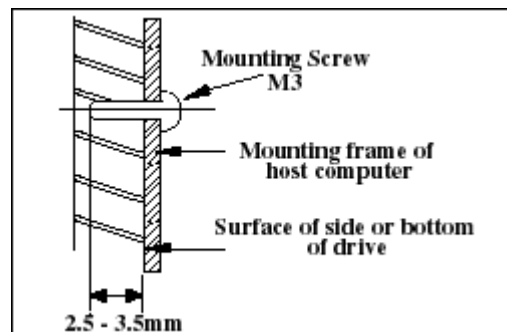

Figure 6. Mounting Illustration

Software Driver - Toshiba's optical drives do not require any unique device drivers for Windows '95/'98/2000/Me/XP/NT. After installing your drive and re-booting, your system should recognize your drive. Windows '95/'98/2000/Me/XP/NT Operating Systems support all Toshiba optical drives natively. If you prefer using DOS, download the DOS ATAPI driver from our web site.

USING THE DVD DVD-ROM Drive – SD-M1502

Drive Operation

Inserting a Disc - Horizontally

To insert a disc into a drive that is mounted horizontally, perform the following steps:

Figure 1. Inserting Disc



1. Open the drive's Loading tray by pressing the Eject Button.
2. Place disc into drive's Loading tray
3. Press Eject button again or gently push on the open disc tray. Tray will automatically close.

Inserting a Disc - Vertically

To insert a disc in a drive that is mounted vertically, perform the following steps:

1. Locate sliding disc holders (4 locations) on drive's Loading Tray.
2. Position the disc behind the disc holders
3. Close the drive by gently pushing in the tray or pressing the eject button.

Figure 2. Inserting Disc Vertically



Removing a Disc

To remove a disc from the DVD-ROM drive, perform the following steps:

1. Open the Loading Tray by pressing the Eject Button.
2. Grasp disc by edges, and lift out of loading tray.
3. Press Eject Button again to close Loading Tray.

Usage Guidelines

- Keep the disc tray closed when not using the DVD-ROM Drive.
- Do not press down on the disc tray when opening or closing it.
- Do not place objects on the disc tray.
- Never use a damaged, broken, or deformed disc.
- Do not press the Open/Close button while the drive is playing a DVD movie or accessing a disc. To stop a DVD movie, click Stop button in the DVD player application program.



NOTE: High-speed drives spin the disc at a high rotational speed. If a disc has printing on only half of the disc, or if there is a slight imbalance in the disc, the imbalance is greatly magnified by the high speed, causing the drive to vibrate or produce a fan-like noise. These effects are inherent in the high-speed technology and do not indicate a problem with the drive.

Emergency Ejection



CAUTION: The following procedure is intended only as a last resort when pressing the eject button fails to open the Loading Tray

1. Turn computer power OFF by properly shutting down system.
2. Insert a solid bar (i.e. large paper clip) into Emergency Eject hole and push as shown in the picture below
3. DVD tray will open/eject.

Figure 3.Using Emergency Eject



This procedure cannot be repeated without cycling the DVD-ROMs (computer's) power. After the media is removed and the loading tray is closed, the tray will not reopen without first turning the power ON/OFF.



NOTE: Use a bar that is less than 1.5 mm in diameter. Do not insert more than 50mm in depth. Inserting more than 50mm may damage the DVD-ROM drive.

Handling Media

DVD media is sensitive to dust and fingerprints. Carefully handle media by its edges only. If a DVD movie skips or hangs during playback, clean the media. Most DVD video playback issues are media-related and can be remedied by proper handling and care of media.

Cleaning Media

Try to avoid touching the read area (underside) of the disc as dirt and smears will degrade the disc accessing speed.

If the disc becomes dirty wipe it with a damp soft cloth. Avoid cleaning in a circular motion, but rather from the inner side outward.

TROUBLESHOOTING – SD-M1502

Problem	Solution
Disc tray cannot be opened	<ul style="list-style-type: none"> • Check that there is power to drive. • Use Emergency Eject instructions to open tray.
Drive is not recognized by system	<ul style="list-style-type: none"> • Is the drive connected properly? Are all cables plugged in properly (e.g. Power Cable, Interface Cable and Audio Cables). • Are the drive configuration jumpers on the DVD-ROM drive set properly? • Is the software driver loaded? On a step-by-step (F8) Boot of the system is the DVD-ROM drive recognized? (BIOS / DOS reports "device driver not found" or "no valid drivers selected."). If not, Contact Technical Support. • Has the DVD-ROM drive software driver been corrupted by a virus. Run a Virus Scan program and repair if possible. Contact Technical Support if the Virus renders the DVD-ROM drive software drivers not useable.
Drive is not recognized by system during Boot process, but is recognized by the Operating System (i.e. XP, Win2000, Win98, Win NT, etc.)	<ul style="list-style-type: none"> • Is the DVD-ROM drive software driver loaded? On a step-by-step (F8) Boot of the system is the DVD-ROM drive recognized? (BIOS / DOS reports "device driver not found or no valid DVD drivers selected."). If not, Contact Technical Support. • Has the Windows DVD-ROM drive software driver program been corrupted by a virus. Run a Virus Scan program and repair if possible. Contact Technical Support if the Virus renders the software drivers not useable.
BUSY Indicator LED flashes slowly	<ul style="list-style-type: none"> • The disc may be dirty Clean it with a soft damp cloth. Avoid cleaning the disc using a circular motion. The disc should be wiped in a radial direction. That is, from the inner side outward. • The laser lens may have become cloudy or blocked by particulate matter. Please contact Technical Support.
BUSY Indicator LED is constantly ON	<ul style="list-style-type: none"> • Possible Hardware Problem. Please contact Technical Support.
DVD-ROM can not play a DVD in the drive or certain types of CD media (i.e. CD-plus, etc.)	<ul style="list-style-type: none"> • Is the DVD-ROM drive driver loaded • Is the DVD disc the correct format for the type of system that you are using? (i.e. on a PC an ISO9660 IBM compatible PC format as opposed to Apple/Mac HFS disc or UNIX disc formats which will not function). • Do you have the correct software applications program/drivers installed to run a DVD disc? • Has the Windows DVD-ROM drive software driver program been corrupted by a virus. Run a Virus Scan program and repair if possible. Contact Technical Support if the Virus renders the software drivers not useable.

SPECIFICATIONS – SD-M1502

General

Interface ATAPI

Compatible DVD-ROM Standards

DVD	DVD-ROM (DVD-5, DVD-9, DVD-10, DVD-18) DVD (Read)
CD	CD-DA CD-ROM CD-I Bridge (Photo-CD, Video CD) Multi-session (Photo-CD, CD Extra, CD-RW, CD-R) CD-MINI CD-TEXT CD+(E)G CD-ROM-XA CD-I CD-R (Read) CD-RW (Read)

Storage Capacities

DVD	4.377GB (DVD-5) 7.959GB (DVD-9) 8.754GB (DVD-10) 15.917GB (DVD-18)
CD	656.5MB (mode 1) 748.8MB (mode 2)

Performance

Rotational Speed

DVD-ROM	
(6.0X - 16X) single layer	9,200rpm
(4.1X - 10X) dual layer	6,300rpm
DVD-R (2X)	1,100 – 2,800rpm
CD-ROM, CD-R (20.7 - 48X)	9,500rpm
CD-RW (8.6 - 20X)	4,300rpm
CD Audio/Video CD (4X – 5.7X)	1,200 – 2,000rpm

Data Transfer Rate	
DVD (Single)	8,910 - 21,600 KBytes/s
CD (mode 1)	3,105 – 7,200 KBytes/s
CD-(mode 2)	3,541 – 8,212 KBytes/s
Burst Rate	16.7 Mbyte/s (PIO Mode 4) 16.7 Mbyte/s (multiple word DMA transfer mode 2) 33.3 MByte/s (Ultra DMA)
Random Access Time	
CD	95ms
DVD	115ms
Data Error Rate	
DVD	10^{-15} Max
CD	10^{-15} Max (Mode 1) 10^{-12} Max (Mode 2)
Spin-up Time	
DVD	1.5s Typ
CD	1.4s Typ
Data Buffer	128Kbytes
Reliability	
MTBF	100,000 hours
Power ON Hours	5,436 hours/year
ON/OFF Cycles	313 cycles/yea
Number of Access	600,000 accesses/year
Operating Duty Cycle	20% of Power ON time (Reading/Seeking)
MTTR	0.5 hours
Audio	
Number of Channels	2
Frequency Response	20Hz to 20,000 Hz
Distortion	-80 dB (at 1kHz JIS A-weighted)
Output Levels	
Headphone	0.97V (rms Typ)
Analog Line Out	0.86 V (rms Typ)
Digital Line Out	0.65 V (p-p)

Environmental

Ambient Temperature

Operating	5° to 50° C (41° to 122° F)
Storage	-10° to 60° C (-14° to 140° F)
Shipping	-40° to 65° C (-40° to 149° F)

Temperature Gradient

Operating	11° C/hour (max)
Storage/Shipping	20° C/hour (max)

Relative Humidity

Operating	8% to 85%
Storage/Shipping	5% to 95% (wet bulb 27°C max)

Vibration

Operating	no hard error: 10 to 500 Hz 2.45 m/s ² [0.25G] (O-P) (excludes resonance point)
Non-operating	no damage: 5 - 10Hz 5mm (P-P) 10 - 500Hz 9.8m/s ² [1G] (O-P)

Shock (Non-operating) 490 m/s² [50G] (Half sine wave 11ms)

Acoustical Noise 45dB (IEC 179 A-weighted at 1m)

Power

DC Voltage and Current Requirements 5V ±5%, 12V ±5%

	<u>+5V</u>	<u>+12V</u>
Sleep	280mA	0mA
Standby	300mA	0mA
Idle	580mA (DVD) 600mA (CD)	50mA (DVD) 50mA (CD)
Random Access (average)	930mA (DVD) 850mA (CD)	710mA (DVD) 870mA (CD)

Physical

Height	5.75" (146mm)
Width	1.6" (41.5mm)
Depth	7.6" (193mm)
Weight	2.14lbs (.97kg)

Connectors

DC input	AMP 1-480424-0
IDE Interface Connector	40 Pin ATAPI Standard
Analog Audio Line Output Connector	4 Pin ATAPI Standard (70066 Series, C Version)
Digital Audio Line Output Connector	4 Pin ATAPI Standard (70066 Series, C Version)

Lasers

CD Laser

Type

Semiconductor Laser and 3-beam System

Wave Length

770 - 795 nm

DVD Laser

Type

Semiconductor Laser and 1-beam System

Wave Length

770 - 650 nm

Regulatory

The SD-M1502 DVD-ROM drive has been certified by the following regulatory agencies:

- UL 1950
- CSA C22.2 No. 950
- TUV (EN60950I)
- CE standard
- CB
- DHHS 21 CFR Sub-Chapter J

DRIVE CONNECTORS –SD-M1502

Figure 1. SD-M1502 DVD-ROM Drive Rear Panel - Connectors

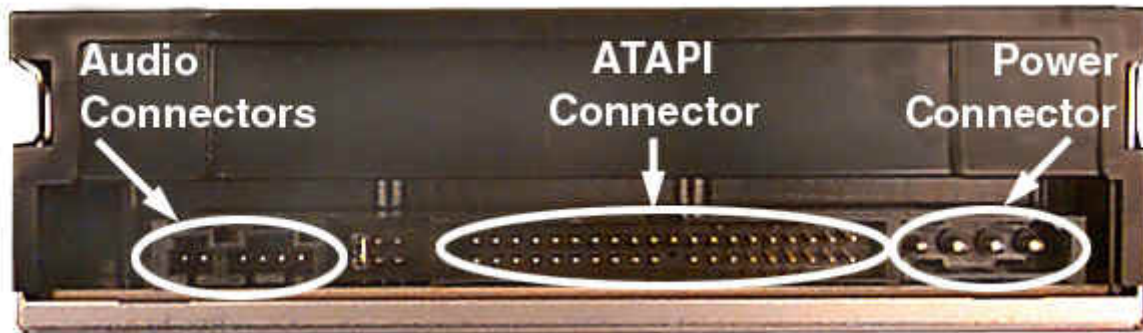

Power Connector Power is supplied to your DVD-ROM drive by the connection with your computer's +5V/+12V power cable to the power socket at the back of drive. One side of the plug has chamfered edges, so the power connector fits only one way



CAUTION: Severe damage to the Drive circuits may occur if power cable is plugged in upside-down with power ON.

Audio Connectors Supplies Analog and Digital sound to your system

ATAPI Connector The SD-M1502 DVD drive is connected to your computer system through the ATAPI connector.

Table 1.Interface Pin Assignments

INTERFACE PIN ASSIGNMENT							
PIN NO.	I/O	SIGNAL NAME	HOST SIGNAL NAME	PIN NO.	I/O	SIGNAL NAME	HOST SIGNAL NAME
1	I	Reset	Host Reset	21	O	HDRQ	DMA Request
2	-	GND		22	-	GND	
3	I/O	HD7	Host Data Bus BIT 7	23	I	HWR-,STOP	Host I/O Write
4	I/O	HD8	Host Data Bus BIT 8	24	-	GND	
5	I/O	HD6	Host Data Bus BIT 6	25	I	HRD-, HDMARDY, - HSTROBE	Host I/O Read
6	I/O	HD9	Host Data Bus BIT 9	26	-	GND	
7	I/O	HD5	Host Data Bus BIT 5	27	O	IORDY, DDMARDY,- DSTROBE	I/O Channel Ready
8	I/O	HD10	Host Data Bus Bit 10	28	-	CSEL	Cable Select
9	I/O	HD4	Host Data Bus BIT 4	29	I	HDAK-	DMA Acknowledge
10	I/O	HD11	Host Data Bus BIT 11	30	-	GND	
11	I/O	HD3	Host Data Bus BIT 3	31	O	INTRQ	Host Interrupt Request
12	I/O	HD12	Host Data Bus BIT 12	32	O	IOCS16-	Host 16 BIT I/O
13	I/O	HD2	Host Data Bus BIT 2	33	I	HA1	Host Address Bus BIT 1
14	I/O	HD13	Host Data Bus BIT 13	34	I/O	PDIAG-	Passed Diagnostics
15	I/O	HD1	Host Data Bus BIT 1	35	I	HA0	Host Address Bus BIT 0
16	I/O	HD14	Host Data Bus BIT 14	36	I	HA2	Host Address Bus BIT 2
17	I/O	HD0	Host Data Bus BIT 0	37	I	HCS1	Host CHIP Select 0
18	I/O	HD15	Host Data Bus BIT 15	38	I	HCS3	Host CHIP Select 1
19	-	GND		39	I/O	DASP-	Drive Active/Drive 1 Present
20	-	(KEYPIN)		40	-	GND	

Free Manuals Download Website

<http://myh66.com>

<http://usermanuals.us>

<http://www.somanuals.com>

<http://www.4manuals.cc>

<http://www.manual-lib.com>

<http://www.404manual.com>

<http://www.luxmanual.com>

<http://aubethermostatmanual.com>

Golf course search by state

<http://golfingnear.com>

Email search by domain

<http://emailbydomain.com>

Auto manuals search

<http://auto.somanuals.com>

TV manuals search

<http://tv.somanuals.com>