

USB-to-Serial Conversion Unit Instruction Manual

USB001Z

Contents

1. Exterior features	4
2. Installing the device driver	5
2.1. Windows 2000 or Windows XP	5
2.2. Windows 98 SE	9
2.3. Uninstalling the device driver	11
3. Checking the COM port number	12
4. Connecting and starting the USB001Z unit	14
5. Outline drawing	15
6. Specifications	16
7. Warranty	16

NOTICE

1. Make sure that this instruction manual is delivered to the end user of USB-to-serial conversion unit.
2. Read this manual before installing or operating the USB-to-serial conversion unit. Keep it in a safe place for reference.
3. All information contained in this manual are subject to change without notice. Please confirm the latest information on our web site "www.inverter.co.jp".

Introduction

Thank you for purchasing a "USB-to-serial conversion unit (USB001Z unit)," an optional device for the TOSVERT series inverters.

The USB-to-serial conversion unit makes it possible to use a USB port on your computer as a COM port for connecting it to an inverter for data communications.

This instruction manual explains how to connect the USB-to-serial conversion unit, and for correct use of the USB-to-serial conversion unit. Please read this manual carefully along with the instruction manual for your inverter and the communication function manual.

When using the USB-to-serial conversion unit, keep this manual handy for future maintenance and inspections.

[Explanation about the type of the USB-to-serial conversion unit]

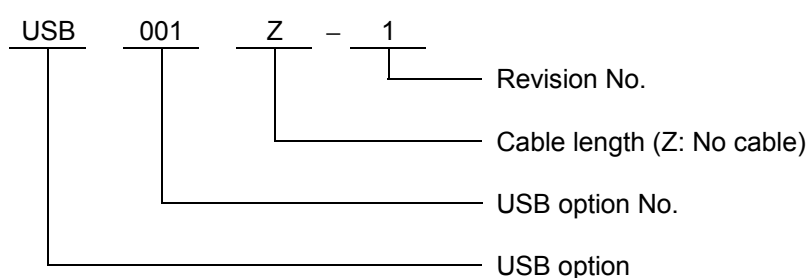

[Accessories check]

The USB-to-serial conversion unit is composed of the items listed below.

Unpack the product and check for missing or damaged components.

(1) USB-to-serial conversion unit 1
(USB001Z)

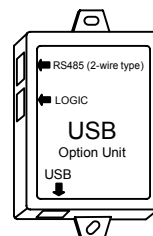

(2) USB-to-serial Conversion Unit Instruction Manual..... 1
(E6581282)

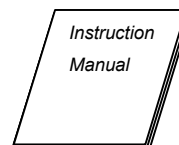

(3) Floppy disk..... 1
- Device driver
- Instruction Manual (Detailed version) This manual
(E6581299)

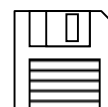

[Note]

This unit does not include an inverter-unit connection cable or a personal computer-unit connection cable. Purchase these cables separately. (Refer to page 4.)

Read first

Safety precautions





This instruction manual and the inverter unit contain important information to avoid endangering actual operators and other persons and damaging properties and to ensure the proper and safe product usage.

Before reading this manual, fully understand the safety precautions in the instruction manual accompanying your inverter. Also, strictly observe the precautions described in this manual.



■ Limits in purpose

Never use the USB-to-serial conversion unit with any device other than a TOSVERT series inverter, or it could cause an accident.



■ General Operation

 Danger	
 Disassembly prohibited	<ul style="list-style-type: none"> ▼ Never disassemble, modify or repair. This can result in electric shock, fire and injury. For repairs, call your sales agency.
 Prohibited	<ul style="list-style-type: none"> ▼ Don't place or insert any kind of object into the inverter (electrical wire cuttings, rods, wires). This can result in electric shock or fire. That may result in electric shock or fire. ▼ Do not allow water or any other fluid to come in contact with this unit. Do not wipe this unit with a wet cloth. That may result in electric shock or fire.
 Mandatory	<ul style="list-style-type: none"> ▼ Before attempting any wiring steps, power off your inverter and make sure that the inverter charge lamp is no longer lit. ▼ If this unit begins to emit smoke or an unusual odor, or unusual sounds, immediately turn power off. If the equipment is continued in operation in such a state, the result may be fire. Call your local sales agency for repairs.



■ Transportation & installation

 Danger	
 Prohibited	<ul style="list-style-type: none"> ▼ Do not place any inflammable substances near this unit. If an accident occurs in which flame is emitted, this could lead to fire. ▼ Do not connect a LAN cable or modular cable for telephones to the conversion unit. Doing so could cause a failure or accident. ▼ Do not connect more than one conversion unit to one host device (computer). Doing so could cause a failure or accident.
 Mandatory	<ul style="list-style-type: none"> ▼ Operate under the environmental conditions prescribed in the instruction manual. Operations under any other conditions may result in malfunction. ▼ Provide your inverter or other equipment with safety devices to prevent a serious accident from resulting even if the unit malfunctions or fails to operate. Usage without a safety device can result in an accident. ▼ Use the Toshiba-specified cable for connecting this optional unit. (Refer to page 4.) The use of any other option may result in an accident.

■ Operations

 Danger	
 Prohibited	<ul style="list-style-type: none"> ▼ Do not apply a dropping shock or other physical shocks. Otherwise, damage or malfunction will result. ▼ Do not yank the interconnect cable. Otherwise, damage or malfunction will result. ▼ Even if this product is deactivated by the occurrence of an event such as an abnormality, when power is supplied to the inverter, do not bring any regions of your body into contact with the inverter terminals. Contact during the power-on status of the inverter can result in electric shock.

■ Disposal

 Warning	
 Mandatory	<ul style="list-style-type: none"> ▼ If you throw away this unit, have it done by a specialist in industry waste disposal*. If you throw away the inverter by yourself, this can result in explosion of capacitor or produce noxious gases, resulting in injury. (*) Persons who specialize in the processing of waste and known as “industrial waste product collectors and transporters” or “industrial waste disposal persons.” If the collection, transport and disposal of industrial waste is done by someone who is not licensed for that job, it is a punishable violation of the law. (Laws in regard to cleaning and processing of waste materials)

■ Cautions in using the unit

Notes	
	<ul style="list-style-type: none"> ▼ Do not install the unit where it will be exposed to abrupt changes in temperature or humidity. ▼ Leave space between the interconnect cable (between the inverter and the USB device) and the power cable from the inverter. Or the inverter could malfunction because of noise. ▼ Do not connect the conversion unit to more than one inverter. Connect the conversion unit to either the “RS485 (2-wire type)” port or the “LOGIC” port on your inverter, depending on the type of the inverter. ▼ Do not disconnect the USB cable during communication with the inverter. ▼ Avoid connecting the conversion unit to a USB hub or extended USB port (e.g., PCMCIA card). Or else the conversion unit may become unstable, depending on the environment in which it is used. ▼ To allow an emergency stop by means of an external device, insert a magnetic contact or similar device between the inverter and the power supply.

■ Caution in creating a software program

Notes	
	<ul style="list-style-type: none"> ▼ The communications software created based on the instruction manual for each TOSVERT series communication function can be used as-is, if the COM port number is changed properly. The conversion unit may, however, be detached from the operating system as a result of a transmission error due to noise, and therefore the occurrence of transmission timeout errors should be monitored using the software, and if they occur in succession, open the port again.

1. Exterior features

- (1) Here are the names and functions of the exterior components of the USB001Z unit.

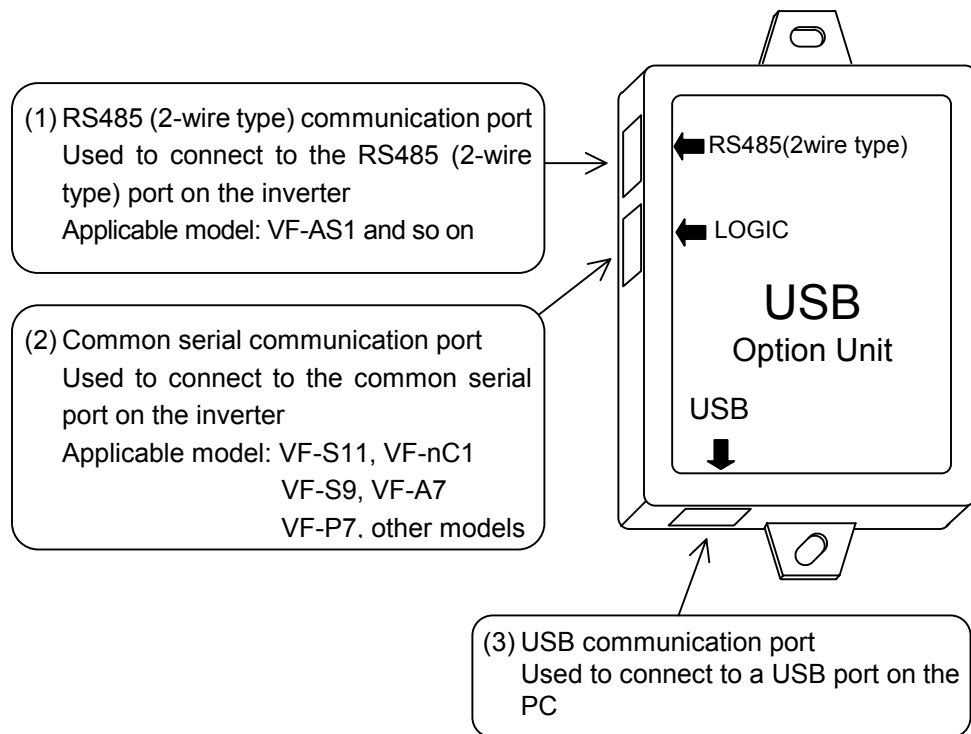

- (2) Interconnect cables (No cables are included with this converter unit.)

- Inverter side (Point of connection: Either (1) or (2) in the above figure)

Use one of the optionally available Toshiba-specified cables listed below.

Inverter-to-unit interconnect cable	Cable length
CAB0011	1.2m
CAB0013	3.6m
CAB0015	4.8m

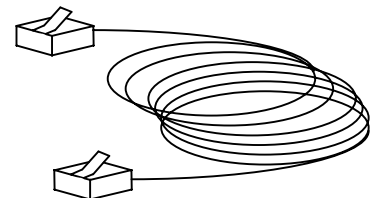

- USB device side (Point of connection: (3) in the above figure)

Use a commercially available USB cable.

(Compliant with USB 1.1/2.0, A-B connection type)

Recommended cable length: 1 m or less

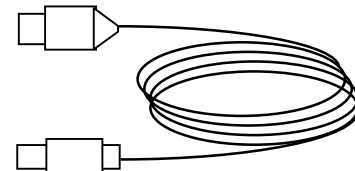

2. Installing the device driver

When using the USB001Z unit for the first time, you have to install its driver on your computer. Since the steps to be followed to install the driver vary depending on the operation system used, refer to the section that corresponds to the operating system used.

These steps do not need to be performed from the next time onward.

Note: Unless otherwise specified, the term “click” means “left-click” (default setting) in the following chapters.

2.1. Windows 2000 or Windows XP

* In this example, Windows XP SP1 is used.

(1) Turn on your computer and start Windows.

Note: Log on to Windows as a computer administrator.

(2) Connect the USB001Z unit to the computer with a USB cable.

* At this time, do not connect the USB001Z unit to the inverter.

The message “@Found New hardware” appears on the screen of your computer monitor, and the “@Found New Hardware Wizard” appears after a short while, as shown in the figure below.

Click the checkbox for “@Install from a list or specific location (Advanced)” in the window, make sure a check mark is put in the checkbox, and then click [Next].

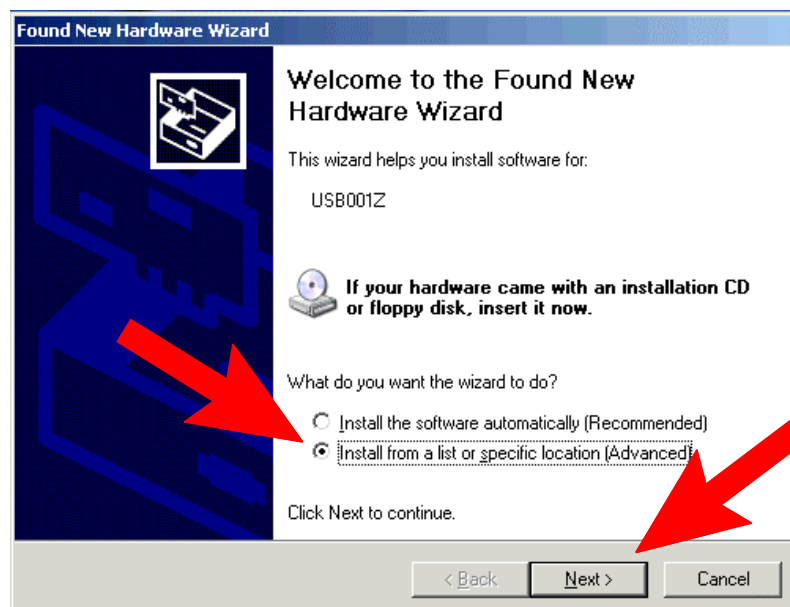

(3) Insert the supplied floppy disk in the floppy disk drive.

(4) Specify the path to the device driver.

In the “@Found New Hardware Wizard” window, click the checkbox for “@Search the best driver in these locations” click the checkbox for “@Search removable media (floppy, CD-ROM...)” to select it, and then click [Next]. (In the case of Windows 2000, the message displayed here is slightly different from the above, but select “@Floppy disk” anyway)

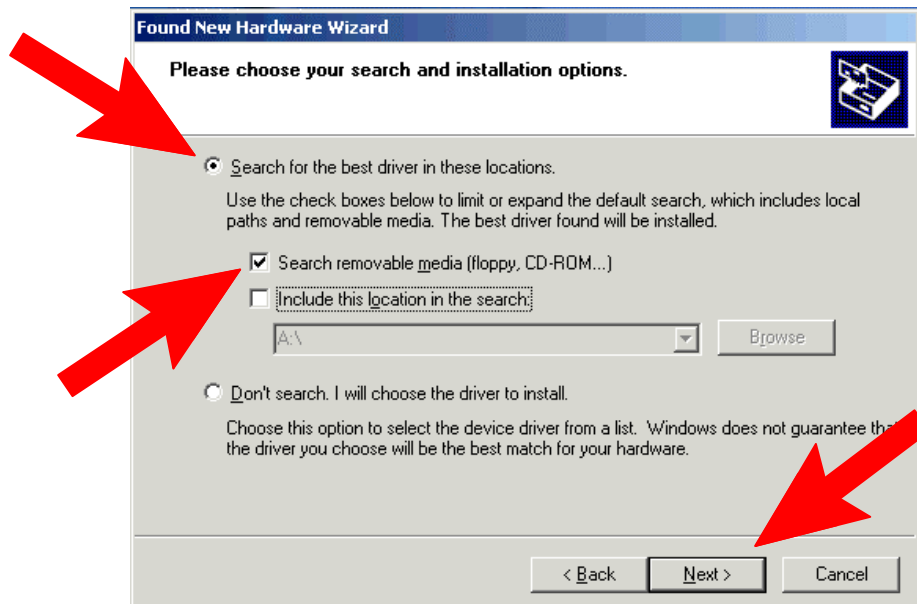

(5) The installation of the device driver starts.

* If the message “USB001Z has not passed Windows Logo testing to verify its compatibility with Windows XP.” appears during installation, click [Continue Anyway].

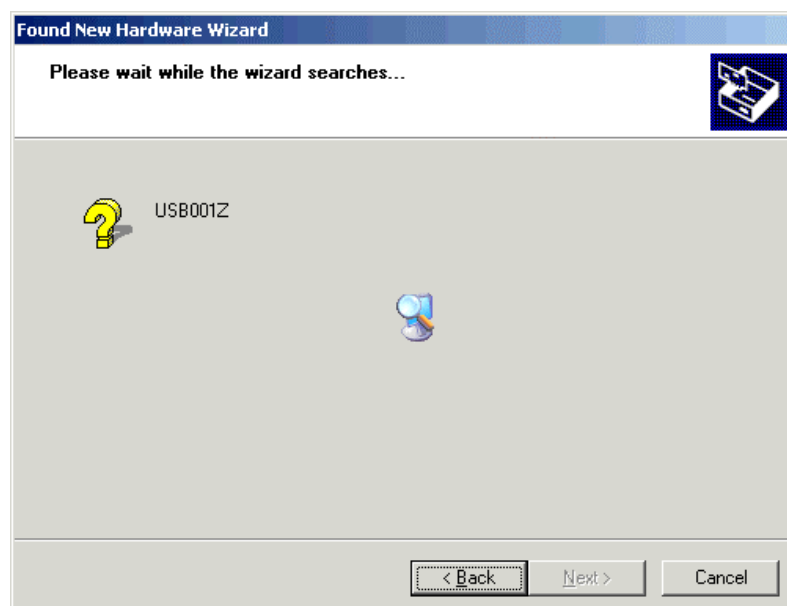

(6) The installation of the device driver is now complete.

On completion of the installation, the window shown below appears. Then, click [Finish].

The floppy disk is also used in step (7), so do not eject it yet.

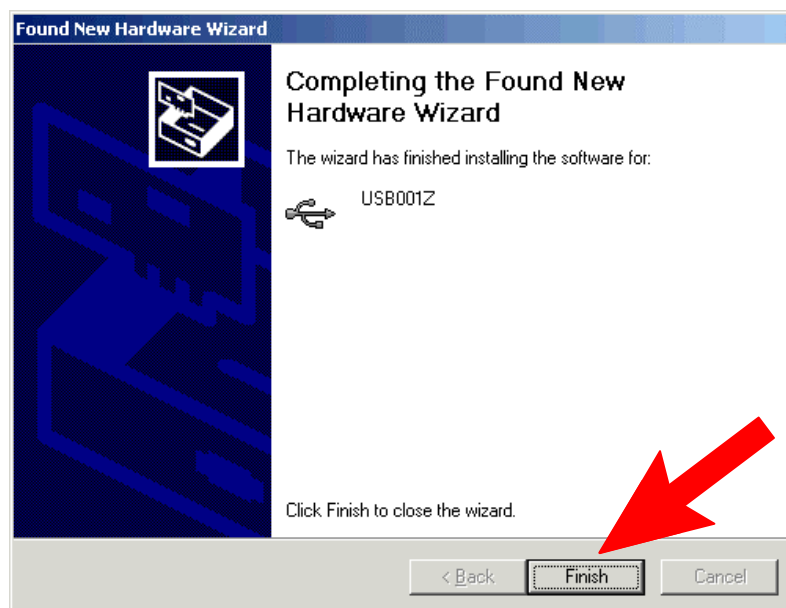

(7) Then, the installation of the USB port driver starts.

The "@Found New Hardware Wizard" appears again.

The USB port driver is also contained on the supplied floppy disk. So, perform steps (3) through (6) again.



(8) Complete the installation.

When a window appears, telling you that the driver has been installed successfully, click [Finish] to complete the installation. Eject the floppy disk, put it in its case, and store it along with this instruction manual.

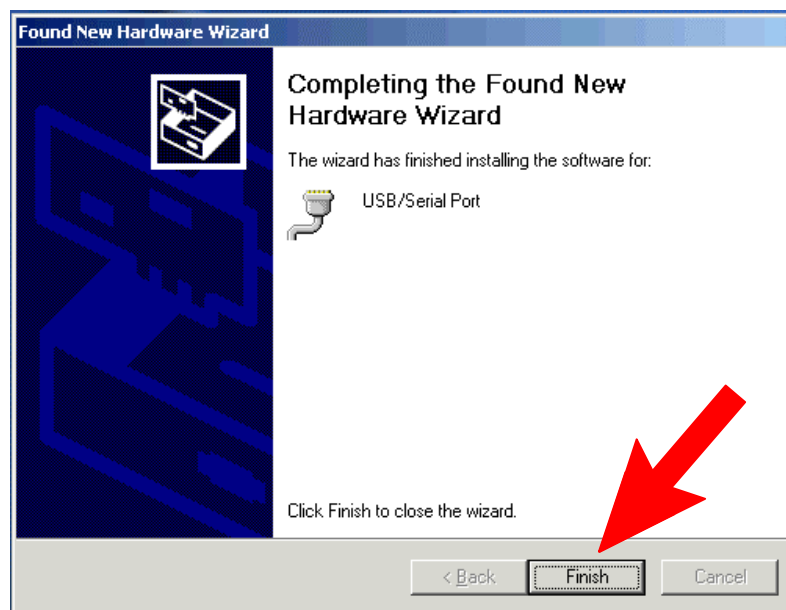

The COM port number is needed for communications with the inverter. So, check on the COM number, following the steps described in section 3.

2.2. Windows 98 SE

- (1) Turn on your computer and start Windows.
- (2) Connect the USB001Z unit to the computer with a USB cable.

* At this time, do not connect the USB001Z unit to the inverter.

After a while, the “@Add New Hardware Wizard” appears on the screen of your computer monitor, as shown in the figure below. Then, click [Next].



- (3) Specify a way to search for the driver.

Click the checkbox for “@Search for the best driver for your device (Recommended)” in the window, make sure a check mark is put in the checkbox, and then click [Next].



(4) Insert the supplied floppy disk in the floppy disk drive.

After inserting the floppy disk, click the checkbox for “Floppy disk drives” in the window, make sure a check mark is put in the checkbox, and then click [Next].



(5) A search for the driver file is made automatically.

Click [Next].



(6) The installation of the device driver starts.

On completion of the installation, the window shown below appears. Then, click [Finish].

Do not eject the floppy disk yet, because the USB port driver will be installed next.

**(7) Then, the USB port driver is installed automatically and the installation of all necessary drivers is completed.**

The COM port number is needed for communications with the inverter. So, check on the COM port number, following the same steps described in chapter 3.

2.3. Uninstalling the device driver

* To uninstall the device driver, click "Start" button on Windows, click "Control Panel" in start menu and turn on "Add/Remove Programs". In the program list that appeared, select "USB Serial Converter Driver" and then click [Change/Remove].

When the uninstaller starts, check to make sure that the conversion unit is not connected, and then click "Continue."

⚠ Warning	
! Mandatory	<p>▼ Do not uninstall a device driver where this option is connected with your computer. Otherwise, abnormalities may be caused to your computer.</p>

3. Checking the COM port number

The COM port number is needed for communications with the inverter. So, follow these steps to check on it.

The COM port number is recognized automatically when the installation of the device driver is completed. COM port numbers vary depending on how your computer is set up.

* Perform this check with the USB001Z unit connected to your computer, or else the port number cannot be checked.

- (1) Click “Start” button on Windows, RIGHT-click “My Computer,” and select “Properties” from the menu that appears.

(In the case of Windows 2000 and Windows 98 SE, the “My Computer” folder is placed on the desktop.)

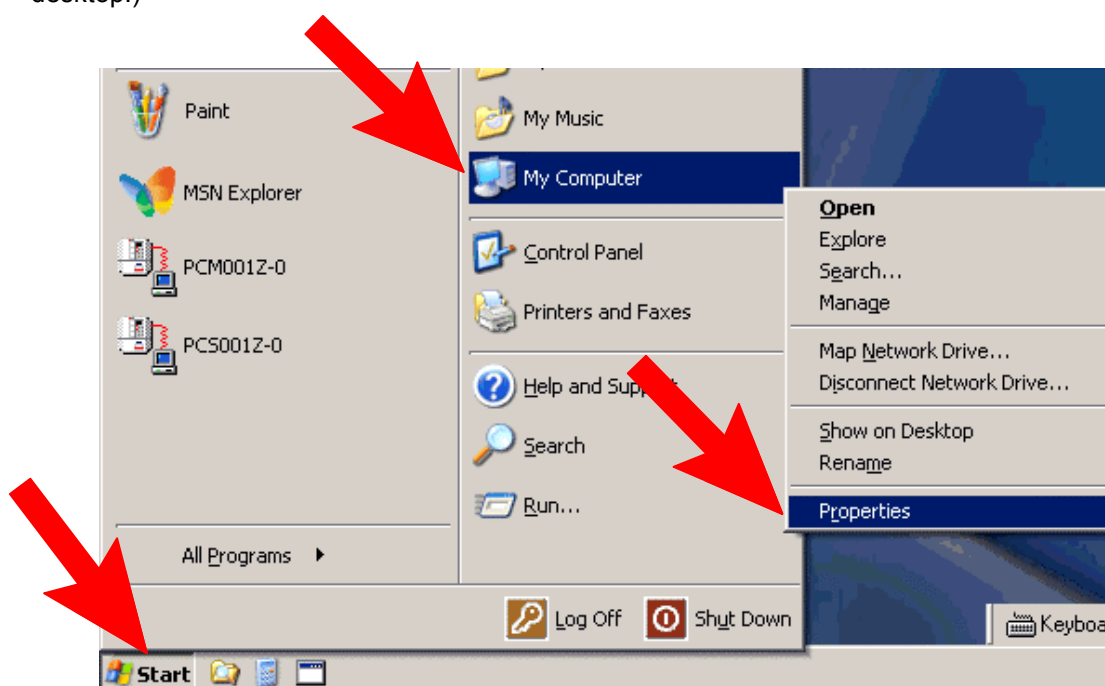

- (2) Click the “Hardware” tab of the “System Properties” dialog box.

(If you are using Windows 98 SE, click the “Device Manager” tab and go to step (4).)



- (3) Click the “Device manager” button in the “Hardware” menu.

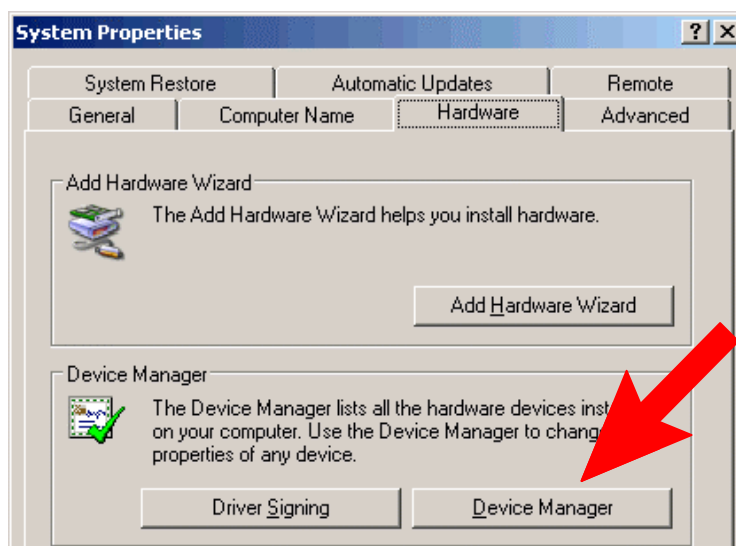

- (4) Click the [+] sign on the left side of “@Port (COM/LPT).”

The number in parentheses next to “USB/Serial Port” refers to the COM port number. (In the example shown below, the COM port number is “COM3.”)

(If the USB001Z unit is not connected, no COM port number is shown.)

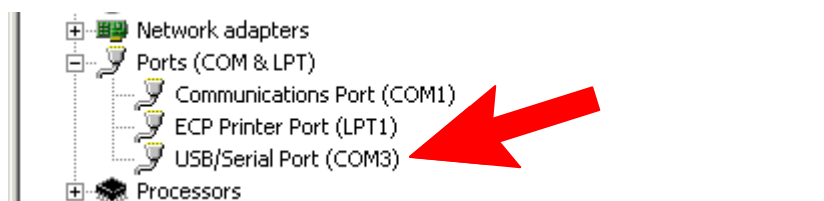

4. Connecting and starting the USB001Z unit

To connect the USB001Z unit to your computer, follow these steps:

- 1) Turn off the input power to the inverter, and after waiting for at least 15 minutes, make sure that the charge lamp on the inverter is no longer lit. (Your personal computer can remain powered on.)
- 2) Connect a USB cable to the USB port on the USB001Z unit and to a USB port on your computer.

When connecting the USB001Z unit to your computer for the first time, you have to install its driver. Refer to Section 2.

- 3) Connect an inverter-unit connection cable (optional) between the communication connector of the USB001Z and that of the inverter. At this time, be careful not to apply force to the connectors. (Refer to the instruction manual of the inverter for connection to the connection port of the inverter.)

RS 485 (2-wire type) side: Connectable to such an RS485 (2-wire type) interface port as that of the VF-AS1.

LOGIC side: Connectable to such a common serial interface port as that of the VF-nC1, S9, S11, A7, or P7.

* Connect the cable only to either RS485 or LOGIC.

- 4) Turn on the power to the inverter, and set communication parameters.

* Before disconnecting the USB communication unit, also perform above step 1) beforehand.

■ Example of connection (In the case of the VF-AS1)

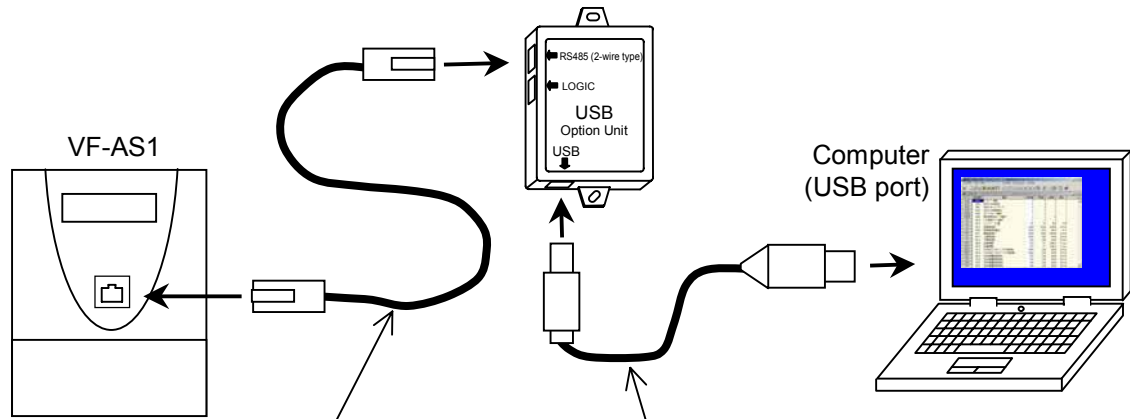

- Inverter-unit connection cable (Optional)

Model number	Cable length
CAB0011	1.2m
CAB0013	3.6m
CAB0015	4.8m

- USB cable (A-B connection type)
Use a commercially available USB cable.
(Compliant with USB 1.1/2.0)
Recommended cable length: 1m

⚠ Warning



▼ Do not disconnect the USB cable during communication with the inverter.

5. Outline drawing

Here is an outline drawing of the USB001Z unit. (Unit: mm)

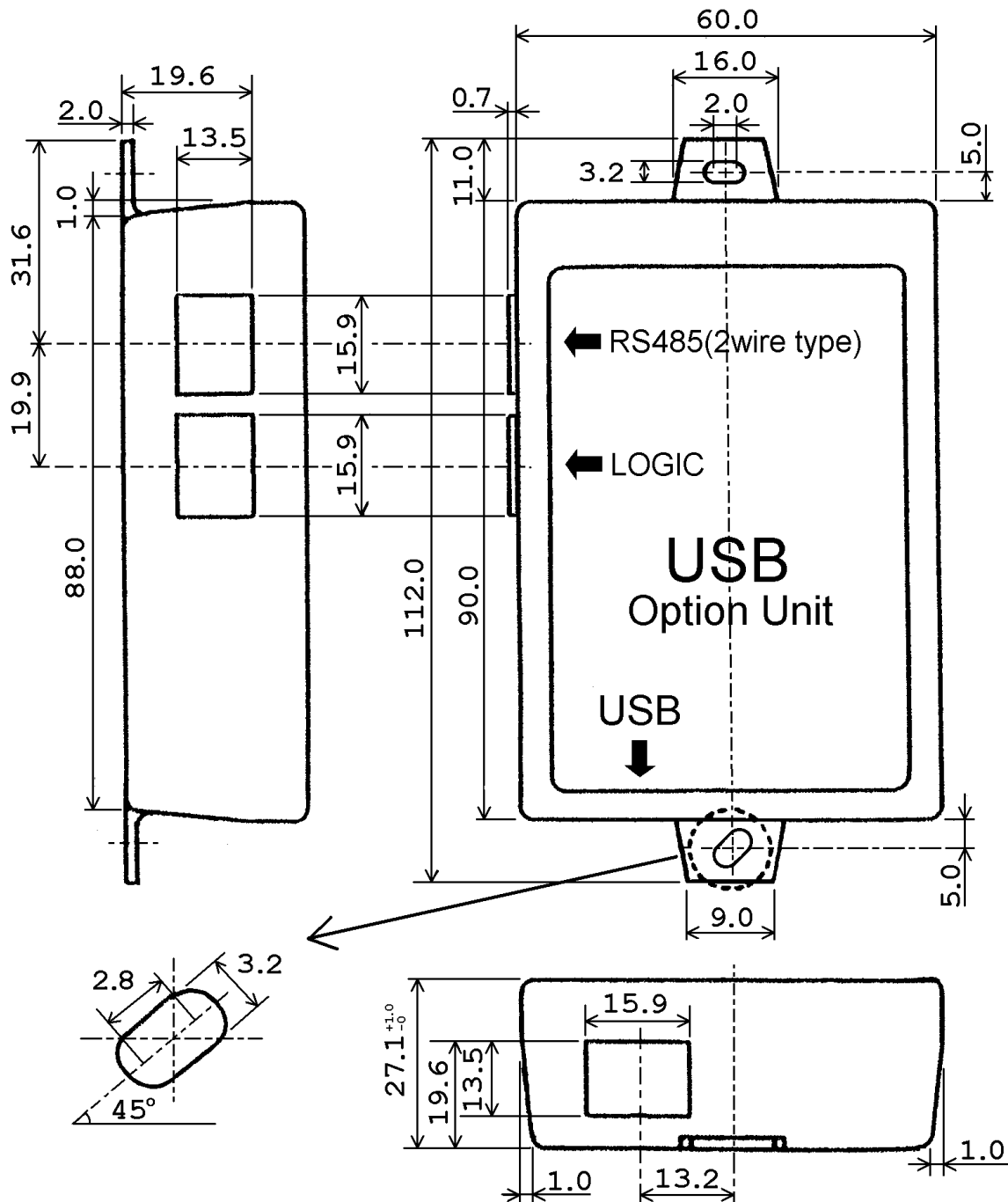

General tolerance : ± 0.5

6. Specifications

Item	Specifications
Model number	USB001Z
Applicable model	Model with either an RS485 (2-wire type) connector or a common serial connector (optional). Usable applications: PCM001Z (V013 or successor), PCS001Z (V001 or successor)
Applicable OS	Windows 98 SE , Windows 2000, Windows XP SP1 ^{*1} However, the personal computer ^{*2} must have a USB port (series A).
Use environments	Indoor operation at an altitude of 1,000m or less and free from direct sunlight, potentially corrosive or explosive gases, steam, dust particles, dust/dirt, and machining fluids (grinding liquid, coolant, included)
Ambient temperature	0 to +50°C
Storage temperature	-25 to +65°C
Relative humidity	20 to 93% (free from condensation and vapor)
Vibration	5.9m/s ² (0.6G) or less (10 to 55Hz) (Compliant with JIS C 0040)
Cooling method	Self-cooling

*1: Windows[®] is listed above as the abbreviation for a Microsoft[®] Windows[®] operating system. Microsoft[®] and Windows[®] are registered trademarks or trademarks of the US Microsoft Corporation in the USA and other countries.

*2: No warranty as to the suitability of this product for any computer and any peripheral equipment is either made or implied.

7. Warranty

Any part of the unit that proves defective will be repaired free of charge under the following conditions:

1. This product will be repaired free of charge, if some trouble occurs under normal handling within one year of delivery and is caused obviously by a defect in design or workmanship.
2. The warranty applies only to the delivered unit.
3. For the following kinds of failure or damage, the repair cost shall be borne by the customer even within the warranty period.
 - 1) Failure or damage caused by improper or incorrect use or handling, or unauthorized repair or modification of the inverter
 - 2) Failure or damage caused by the unit falling or an accident during transportation after the purchase
 - 3) Failure or damage caused by fire, salty water or wind, corrosive gas, earthquake, storm or flood, lightning, abnormal voltage supply, or other natural disasters
 - 4) Damage due to the use of the USB-serial communication conversion unit for non-intended purposes.
4. If there are any warranty conditions otherwise provided for, those conditions will govern.

Free Manuals Download Website

<http://myh66.com>

<http://usermanuals.us>

<http://www.somanuals.com>

<http://www.4manuals.cc>

<http://www.manual-lib.com>

<http://www.404manual.com>

<http://www.luxmanual.com>

<http://aubethermostatmanual.com>

Golf course search by state

<http://golfingnear.com>

Email search by domain

<http://emailbydomain.com>

Auto manuals search

<http://auto.somanuals.com>

TV manuals search

<http://tv.somanuals.com>