

TOSHIBA

Instruction Manual

The new generation Compact inverter TOSVERT VF-S9

1-phase 200V class	0.2 ~ 2.2kW
3-phase 200V class	0.2 ~ 15kW
3-phase 400V class	0.75 ~ 15kW

TOSHIBA INDUSTRIAL PRODUCTS MANUFACTURING CORPORATION

NOTICE

1. Make sure that this instruction manual is delivered to the end user of the inverter unit.
2. Read this manual before installing or operating the inverter unit, and store it in a safe place for reference.

E6580757①



Safety precautions	I
Introduction	II
Contents	
Read first	1
Connecting equipment	2
Operations	3
Basic VF-S9 operations	4
Basic parameters	5
Extended parameters	6
Applied operation	7
Monitoring the operation status	8
Taking measures to satisfy the CE/UL directive	9
Peripheral devices	10
Table of parameters and data	11
Specifications	12
Before making a service call - Tip information and remedies	13
Inspection and maintenance	14
Warranty	15
Disposal of the inverter	16

2000 Ver. 101

I. Safety precautions

The items described in these instructions and on the inverter itself are very important so that you can use the inverter safely prevent injury to yourself and other people around you as well as prevent damage to property in the area. Thoroughly familiarize yourself with the symbols and indications shown below and then continue to read the manual. Make sure that you observe all warnings given.





Explanation of markings

Marking	Meaning of marking
 Danger	Indicates that errors in operation may lead to death or serious injury.
 Warning	Indicates that errors in operation may lead to injury (*1) to people or that these errors may cause damage to physical property. (*2)

(*1) Such things as injury, burns or shock that will not require hospitalization or long periods of outpatient treatment.

(*2) Physical property damage refers to wide-ranging damage to assets and materials.

Meanings of symbols

Symbol	Meaning of Symbol
	Indicates prohibition (Don't do it). What is prohibited will be described in or near the symbol in either text or picture form.
	Indicates something mandatory (must be done). What is mandatory will be described in or near the symbol in either text or picture form.
	Indicates danger. What is dangerous will be described in or near the symbol in either text or picture form.
	Indicates warning. What the warning should be applied to will be described in or near the symbol in either text or picture form.





■ Limits in purpose



This inverter is used for controlling speeds of three-phase induction motors in general industrial use.

Safety precautions

- ▼ The inverter cannot be used in any device that would present danger to the human body or from which malfunction or error in operation would present a direct threat to human life (nuclear power control device, aviation and space flight control device, traffic device, life support or operation system, safety device, etc.). If the inverter is to be used for any special purpose, first get in touch with the people in charge of sales.
- ▼ This product was manufactured under the strictest quality controls but if it is to be used in critical equipment, for example, equipment in which errors in malfunctioning signal output system would cause a major accident, safety devices must be installed on the equipment.
- ▼ Do not use the inverter for loads other than those of properly applied three-phase induction motors in general industrial use. (Use in other than properly applied three-phase induction motors may cause an accident.)



■ General operation



 Danger		See item
 Disassembly prohibited	<ul style="list-style-type: none"> Never disassemble, modify or repair. This can result in electric shock, fire and injury. For repairs, call your sales agency. 	2.
 Prohibited	<ul style="list-style-type: none"> Never remove the front cover when power is on or open door if enclosed in a cabinet. The unit contains many high voltage parts and contact with them will result in electric shock. Don't stick your fingers into openings such as cable wiring hole and cooling fan covers. This can result in electric shock or other injury. Don't place or insert any kind of object into the inverter (electrical wire cuttings, rods, wires). This can result in electric shock or fire. Do not allow water or any other fluid to come in contact with the inverter. This can result in electric shock or fire. 	2.1 2 2. 2.
 Mandatory	<ul style="list-style-type: none"> Turn power on only after attaching the front cover or closing door if enclosed in a cabinet. If power is turned on without the front cover attached or closing door if enclosed in a cabinet. This can result in electric shock or other injury. If the inverter begins to emit smoke or an unusual odor, or unusual sounds, immediately turn power off. If the equipment is continued in operation in such a state, the result may be fire. Call your local sales agency for repairs. Always turn power off if the inverter is not used for long periods of time since there is a possibility of malfunction caused by leaks, dust and other material. If power is left on with the inverter in that state, it may result in fire. 	2.1 3. 3.

 Warning		See item																							
 Prohibited contact	<ul style="list-style-type: none"> Do not touch heat radiating fins or discharge resistors. These device are hot, and you'll get burned if you touch them. 	3.																							
 Prohibited	<ul style="list-style-type: none"> Avoid operation in any location where there is direct spraying of the following solvents or other chemicals. The plastic parts may be damaged to a certain degree depending on their shape, and there is a possibility of the plastic covers coming off and the plastic units being dropped. If the chemical or solvent is anything other than those shown below, please contact us in advance. <div style="display: flex; justify-content: space-between;"> <div style="width: 48%;"> <p>(Table 1) Examples of applicable chemicals and solvents</p> <table border="1" style="width: 100%; border-collapse: collapse;"> <thead> <tr> <th style="text-align: center;">Chemical</th> <th style="text-align: center;">Solvent</th> </tr> </thead> <tbody> <tr> <td>Hydrochloric acid (density of 10% or less)</td> <td>Methanol</td> </tr> <tr> <td>Sulfuric acid (density of 10% or less)</td> <td>Ethanol</td> </tr> <tr> <td>Nitric acid (density of 10% or less)</td> <td>Triol</td> </tr> <tr> <td>Caustic soda</td> <td>Mesopropanol</td> </tr> <tr> <td>Ammonia</td> <td>Glycerin</td> </tr> <tr> <td>Sodium chloride (salt)</td> <td></td> </tr> </tbody> </table> </div> <div style="width: 48%;"> <p>(Table 2) Examples of unapplicable chemicals and solvents</p> <table border="1" style="width: 100%; border-collapse: collapse;"> <thead> <tr> <th style="text-align: center;">Chemical</th> <th style="text-align: center;">Solvent</th> </tr> </thead> <tbody> <tr> <td>Phenol</td> <td>Gasoline, kerosene, light oil</td> </tr> <tr> <td rowspan="2">Benzenesulfonic acid</td> <td>Turpentine oil</td> </tr> <tr> <td>Benzol</td> </tr> <tr> <td></td> <td>Thinner</td> </tr> </tbody> </table> </div> </div>	Chemical	Solvent	Hydrochloric acid (density of 10% or less)	Methanol	Sulfuric acid (density of 10% or less)	Ethanol	Nitric acid (density of 10% or less)	Triol	Caustic soda	Mesopropanol	Ammonia	Glycerin	Sodium chloride (salt)		Chemical	Solvent	Phenol	Gasoline, kerosene, light oil	Benzenesulfonic acid	Turpentine oil	Benzol		Thinner	1.4.4
Chemical	Solvent																								
Hydrochloric acid (density of 10% or less)	Methanol																								
Sulfuric acid (density of 10% or less)	Ethanol																								
Nitric acid (density of 10% or less)	Triol																								
Caustic soda	Mesopropanol																								
Ammonia	Glycerin																								
Sodium chloride (salt)																									
Chemical	Solvent																								
Phenol	Gasoline, kerosene, light oil																								
Benzenesulfonic acid	Turpentine oil																								
	Benzol																								
	Thinner																								



■ Transportation · Installation







 Danger		See item
 Prohibited	<ul style="list-style-type: none"> Do not install or operate the inverter if it is damaged or any component is missing. This can result in electric shock or fire. Please consult your local sales agency for repairs. Do not place any inflammable objects nearby. If a flame is emitted due to malfunction, it may result in a fire. Do not install in any location where the inverter could come into contact with water or other fluids. This can result in electric shock or fire. 	1.4.4 1.4.4 2.
 Mandatory	<ul style="list-style-type: none"> Must be used in the environmental conditions prescribed in the instruction manual. Use under any other conditions may result in malfunction. Must be installed in non-inflammables such as metals. The rear panel gets very hot. If installation is in an inflammable object, this can result in fire. Do not operate with the front panel cover removed. This can result in electric shock. An emergency stop device must be installed that fits with system specifications (e.g. shut off input power then engage mechanical brake). Operation cannot be stopped immediately by the inverter alone, thus risking an accident or injury. All options used must be those specified by Toshiba. The use of any other option may result in an accident. 	1.4.4 1.4.4 1.4.4 1.4.4 1.4.4

 Warning		See item
 Prohibited	<ul style="list-style-type: none"> When transporting or carrying, do not hold by the front panel covers. The covers may come off and the unit will drop out resulting in injury. Do not install in any area where the unit would be subject to large amounts of vibration. That could result in the unit falling, resulting in injury. 	2. 1.4.4
 Mandatory	<ul style="list-style-type: none"> The main unit must be installed on a base that can bear the unit's weight. If the unit is installed on a base that cannot withstand that weight, the unit may fall resulting in injury. If braking is necessary (to hold motor shaft), install a mechanical brake. The brake on the inverter will not function as a mechanical hold, and if used for that purpose, injury may result. 	1.4.4 1.4.4



■ Wiring



 Danger		See item
 Prohibited	<ul style="list-style-type: none"> Do not connect input power to the output (motor side) terminals (U/T1,V/T2,W/T3). That will destroy the inverter and may result in fire. Do not connect resistors to the DC terminals (across PA-PC or PO-PC). That may cause a fire. Connect resistors as directed by the instructions for "Installing separate braking resistors." Within ten minutes after turning off input power, do not touch wires of devices (MCCB) connected to the input side of the inverter. That could result in electric shock. 	2.2 2.2 2.2

 Danger		See item
 Mandatory	<ul style="list-style-type: none"> Electrical construction work must be done by a qualified expert. Connection of input power by someone who does not have that expert knowledge may result in fire or electric shock. 	2.1
	<ul style="list-style-type: none"> Connect output terminals (motor side) correctly. If the phase sequence is incorrect, the motor will operate in reverse and that may result in injury. 	2.1
	<ul style="list-style-type: none"> Wiring must be done after installation. If wiring is done prior to installation that may result in injury or electric shock. 	2.1
	<ul style="list-style-type: none"> The following steps must be performed before wiring. <ol style="list-style-type: none"> Turn off all input power. Wait at least ten minutes and check to make sure that the charge lamp is no longer lit. Use a tester that can measure DC voltage (800VDC or more), and check to make sure that the voltage to the DC main circuits (across PA-PC) is 45V or less. If these steps are not properly performed, the wiring will cause electric shock. 	2.1
	<ul style="list-style-type: none"> Tighten the screws on the terminal board to specified torque. If the screws are not tightened to the specified torque, it may lead to fire. Check to make sure that the input power voltage is +10%, -15% of the rated power voltage written on the rating label ($\pm 10\%$ when the load is 100% in continuous operation) If the input power voltage is not +10%, -15% of the rated power voltage ($\pm 10\%$ when the load is 100% in continuous operation) this may result in fire. 	2.1 1.4.4
 Be Grounded	<ul style="list-style-type: none"> Ground must be connected securely. If the ground is not securely connected, it could lead to electric shock or fire when a malfunction or current leak occurs. 	2.1 2.2



 Warning		See item
 Prohibited	<ul style="list-style-type: none"> Do not attach equipment (such as noise filters or surge absorbers) that have built-in capacitors to the output (motor side) terminals. That could result in a fire. 	2.1

■ Operations



 Danger		See item
 Prohibited	<ul style="list-style-type: none"> Do not touch inverter terminals when electrical power is going to the inverter even if the motor is stopped. Touching the inverter terminals while power is connected to it may result in electric shock. Do not touch switches when the hands are wet and do not try to clean the inverter with a damp cloth. Such practices may result in electric shock. Do not go near the motor in alarm-stop status when the retry function is selected. The motor may suddenly restart and that could result in injury. Take measures for safety, e.g. attaching a cover to the motor, against accidents when the motor unexpectedly restarts. 	3. 3. 3.
 Mandatory	<ul style="list-style-type: none"> Turn input power on after attaching the front cover. When storing inside the cabinet and using with the front cover removed, always close the cabinet doors first and then turn power on. If the power is turned on with the front cover or the cabinet doors open, it may result in electric shock. Make sure that operation signals are off before resetting the inverter after malfunction. If the inverter is reset before turning off the operating signal, the motor may restart suddenly causing injury. 	3. 3.

 Warning		See item
 Prohibited	<ul style="list-style-type: none"> Observe all permissible operating ranges of motors and mechanical equipment. (Refer to the motor's instruction manual.) Not observing these ranges may result in injury. 	3.



When sequence for restart after a momentary power failure is selected (inverter)

 Warning		See item
 Mandatory	<ul style="list-style-type: none"> Stand clear of motors and mechanical equipment If the motor stops due to a momentary power failure, the equipment will start suddenly after power recovers. This could result in unexpected injury. Attach warnings about sudden restart after a momentary power failure on inverters, motors and equipment for prevention of accidents in advance. 	6.12.1 6.12.1



When retry function is selected (inverter)

 Warning		See item
 Mandatory	<ul style="list-style-type: none"> Stand clear of motors and equipment. If the motor and equipment stop when the alarm is given, selection of the retry function will restart them suddenly after the specified time has elapsed. This could result in unexpected injury. Attach warnings about sudden restart in retry function on inverters, motors and equipment for prevention of accidents in advance. 	6.12.3 6.12.3

Maintenance and inspection

 Danger		See item
 Prohibited	<ul style="list-style-type: none"> Do not replace parts. This could be a cause of electric shock, fire and bodily injury. To replace parts, call the local sales agency. 	14.2
 Mandatory	<ul style="list-style-type: none"> The equipment must be inspected every day. If the equipment is not inspected and maintained, errors and malfunctions may not be discovered and that could result in accidents. Before inspection, perform the following steps. <ol style="list-style-type: none"> Turn off all input power to the inverter. Wait for at least ten minutes and check to make sure that the charge lamp is no longer lit. Use a tester that can measure DC voltages (800VDC or more), and check to make sure that the voltage to the DC main circuits (across PA-PC) is 45V or less. If inspection is performed without performing these steps first, it could lead to electric shock. 	14. 14.

Disposal

 Warning	
 Mandatory	<ul style="list-style-type: none"> • If you throw away the inverter, have it done by a specialist in industry waste disposal". • If you throw away the inverter by yourself, this can result in explosion of capacitor or produce noxious gases, resulting in injury. <p>(*) Persons who specialize in the processing of waste and known as "industrial waste product collectors and transporters" or "industrial waste disposal persons."</p> <p>If the collection, transport and disposal of industrial waste is done by someone who is not licensed for that job, it is a punishable violation of the law. (laws in regard to cleaning and processing of waste materials)</p>

Attach warning labels

Shown here are examples of warning labels to prevent, in advance, accidents in relation to inverters, motors and other equipment.

If the inverter has been programmed for auto-restart function after momentary power failure or retry function, place warning labels in a place where they can be easily seen and read.

If the inverter has been programmed for restart sequence of momentary power failure, place warning labels in a place where they can be easily seen and read.
(Example of warning label)

	Warning (Functions programmed for restart)
Do not go near motors and equipment. Motors and equipment that have stopped temporarily after momentary power failure will restart suddenly after recovery.	

If the retry function has been selected, place warning labels in a location where they can be easily seen and read.
(Example of warning label)

	Warning (Functions programmed for retry)
Do not go near motors and equipment. Motors and equipment that have stopped temporarily after an alarm will restart suddenly after the specified time has elapsed.	

II. Introduction

Thank you for your purchase of the Toshiba "TOSVERT VF-S9" industrial inverter

This is the Ver.101 CPU version inverter.
Please be informed that this version will be frequently upgraded.

■ Features

1. Built-in noise filter

- 1) All models in both the 200V and 400V series have a noise filter inside.
- 2) These models conform to European CE markings and United States UL standards.
- 3) Reduces space requirements and cuts down on time and labor needed in wiring.

2. Simple operation

- 1) Automatic functions (torque boost acceleration/deceleration time, function programming, environment programming)
Just by wiring the motor to the power supply allows instant operation without the need to program parameters.
- 2) Switches and potentiometer dial on the front panel allow immediate and easy operation.

3. Superior basic performance

- 1) Torque from low frequency to 150% and higher
- 2) Smooth operation : Reduced rotation ripple through the use of Toshiba's unique dead-band compensation.
- 3) Built-in current surge suppression circuit : Can be safely connected even if power load is low.
- 4) Maximum 400Hz high frequency output : Optimum for use with high speed motors such as those in lumber machinery and milling machines.
- 5) Maximum carrier frequency: 16.5kHz quiet operation
Toshiba's unique PWM control reduces noise at low carrier.

4. Globally compatible

- 1) Compatible with 240V and 500V power supplies
- 2) Conforms to CE marking and with UL, CUL and C-Tick.
- 3) Sink/source switching of control input/output.

5. Options allow use with a wide variety of applications

- Communication functions (RS485/RS232C)
- Extension panel/Parameter writer
- DIN rail kit (For 200V class 0.2 to 0.75 kW)
- Foot-mounted type noise reduction filter (EMC directive: For class A and class B)
- Other options are common to all models

— Contents —

I	Safety precautions	1
II	Introduction	7
1.	Read first	A-1
1.1	Check product purchase	A-1
1.2	Contents of the product code	A-2
1.3	Names and functions	A-3
1.4	Notes on the application	A-10
2.	Connection equipment	B-1
2.1	Cautions on wiring	B-1
2.2	Standard connections	B-3
2.3	Description of terminals	B-6
3.	Operations	C-1
3.1	How to operate the VF-S9	C-2
3.2	Simplified Operation of the VF-S9	C-6
4.	Basic VF-S9 operations	D-1
4.1	How to set parameters	D-2
5.	Basic parameters	E-1
5.1	Setting acceleration/deceleration time	E-1
5.2	Increasing starting torque	E-3
5.3	Setting environmental protection	E-5
5.4	Setting parameters by operating method	E-5
5.5	Selection of operation mode	E-7
5.6	Meter setting and adjustment	E-8
5.7	Standard default setting	E-10
5.8	Selecting forward and reverse runs (operation panel only)	E-11
5.9	Maximum frequency	E-12
5.10	Upper limit and lower limit frequencies	E-12
5.11	Base frequency	E-13
5.12	Selecting control mode	E-14
5.13	Manual torque boost-increasing torque at low speeds	E-18
5.14	Setting the electronic thermal	E-18
5.15	Preset-speed operation (speed in 15 steps)	E-22
6.	Extended parameters	F-1
6.1	Input/output parameters	F-1

6.2	Input signal selection.....	F-4
6.3	Terminal function selection.....	F-6
6.4	Basic parameters 2.....	F-10
6.5	Frequency priority selection.....	F-11
6.6	Operation frequency.....	F-17
6.7	DC braking.....	F-18
6.8	Jog run mode.....	F-19
6.9	Jump frequency-jumping resonant frequencies.....	F-21
6.10	Preset-speed operation frequency 8 to 15.....	F-22
6.11	PWM carrier frequency.....	F-22
6.12	Trip-less intensification.....	F-23
6.13	Setting motor constants.....	F-36
6.14	Acceleration/deceleration patterns and acceleration/deceleration 2.....	F-39
6.15	Protection functions.....	F-42
6.16	Operation panel parameter.....	F-50
6.17	Communication function (Common serial).....	F-54
7.	Applied operation.....	G-1
7.1	Setting the operation frequency.....	G-1
7.2	Setting the operation mode.....	G-5
8.	Monitoring the operation status.....	H-1
8.1	Status monitor mode.....	H-1
8.2	Display of trip information.....	H-3
9.	Taking measures to satisfy the CE/UL directive.....	I-1
9.1	How to cope with the CE directive.....	I-1
10.	Peripheral devices.....	J-1
10.1	Selection of wiring materials and devices.....	J-1
10.2	Installation of a magnetic contactor.....	J-3
10.3	Installation of an overload relay.....	J-4
10.4	Optional external devices.....	J-4
11.	Table of parameters and data.....	K-1
11.1	User parameters.....	K-1
11.2	Basic parameters.....	K-1
11.3	Extended parameters.....	K-2
12.	Specifications.....	L-1
12.1	Models and their standard specifications.....	L-1
12.2	Outside dimensions and mass.....	L-3

13. Before making a service call-Trip information and remedies	M-1
13.1 Trip causes/warnings and remedies	M-1
13.2 Restoring the inverter from a trip	M-5
13.3 If the motor does not run while no trip message is displayed.....	M-6
13.4 How to determine the causes of other problems.....	M-7
14. Inspection and maintenance	N-1
14.1 Regular inspection	N-1
14.2 Periodical inspection.....	N-2
14.3 Making a call for servicing	N-4
14.4 Keeping the inverter in storage	N-4
15. Warranty	O-1
16. Disposal of the inverter	P-1

1. Read first

1.1 Check product purchase

Before using the product you have purchased, check to make sure that it is exactly what you ordered.

Warning	
 Mandatory	Use an inverter that conforms to the specifications of power supply and three-phase induction motor being used. If the inverter being used does not conform to those specifications, not only will the three-phase induction motor not rotate correctly, but it may cause serious accidents through overheating and fire.

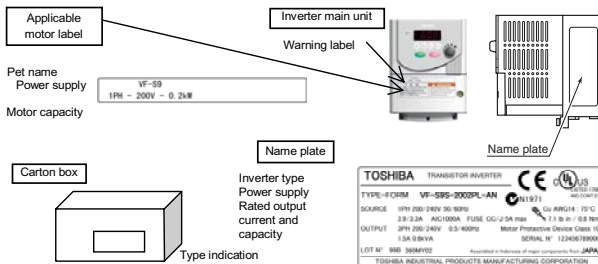

1.2 Contents of the product code

Here is explained the type and form written on the label

1

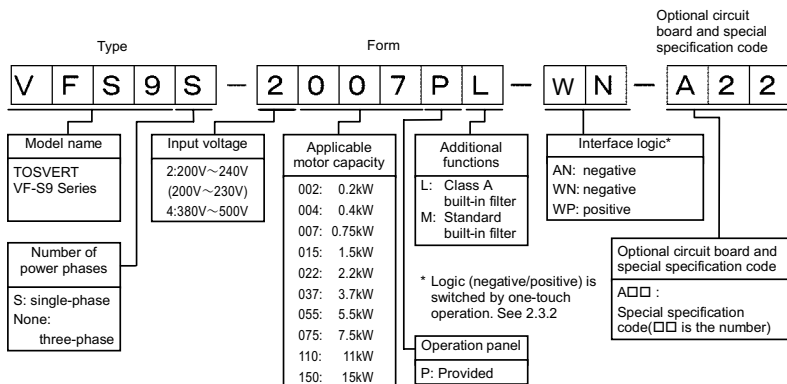

Warning: Always shut power off first then check the ratings label of inverter held in a cabinet.

1.3 Names and functions

1.3.1 Outside view

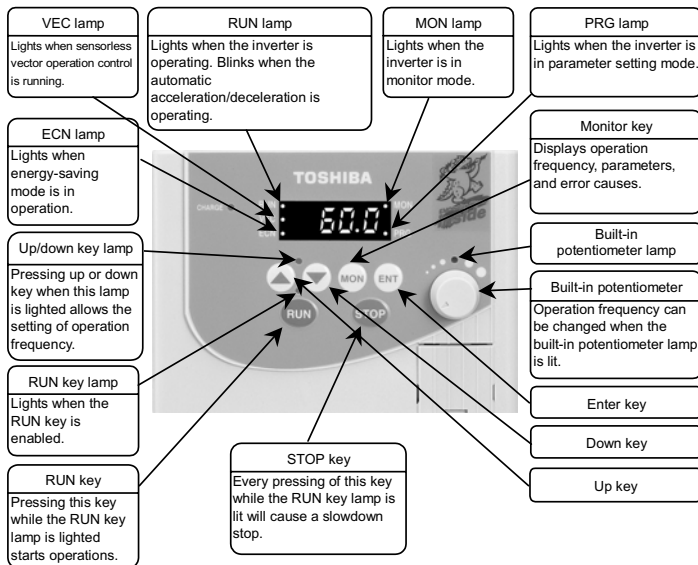

[Front panel 1]

1

1

Charge lamp
Indicates that high voltage is still present within the inverter. Do not open the terminal board cover while this is lit.

Connector cover for common serial option
Slide this cover to the right to use the connectors for options.
• Parameter writer
• Extension panel
• RS485/RS232C

Terminal board cover
Covers the terminal board. Always shut tight before operation so that the terminal board is not touched accidentally.

Terminal board cover lock screws



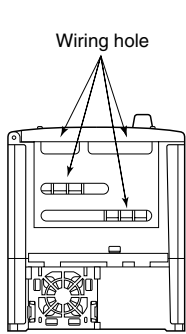

[Bottom]

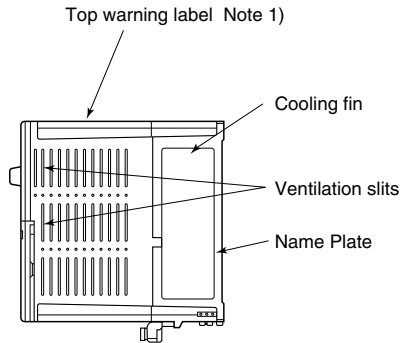

[Side]

Note 1) If ambient temperature is high, peel off this label.
 Removing label invalidates NEMA 1 rating unless enclosed in a cabinet.

Example of the label.

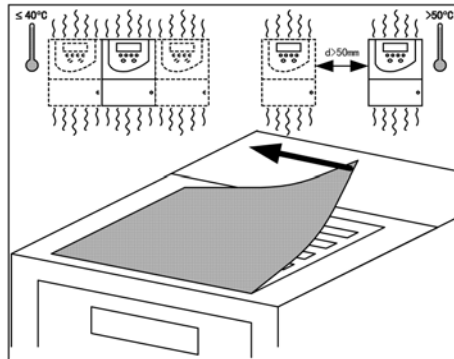

1.3.2 Main circuit and control circuit terminal boards

1) Main circuit terminal board

In case of the lug connector, cover the lug connector with insulated tube, or use the insulated lug connector.

Screw size	tightening torque
M3 screw	0.8N • m
M4 screw	1.2N • m
M5 screw	2.8N • m
M6 screw	5.0N • m

VFS9S-2002PL ~ 2022PL

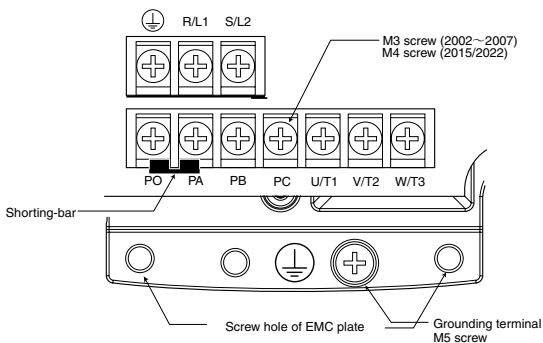

VFS9S-2002PM ~ 2015PM

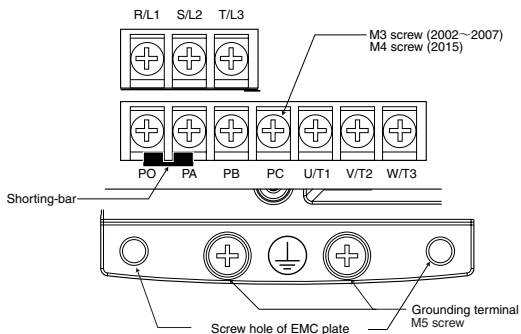

VFS9-2022PM/2037PM
VFS9-4007PL ~ 4037PL

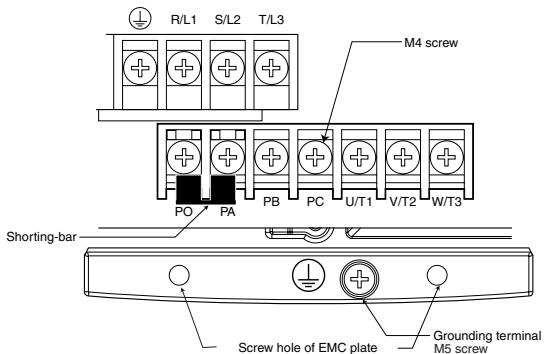

1

VFS9-2055PL/2075PL
4055PL/4075PL

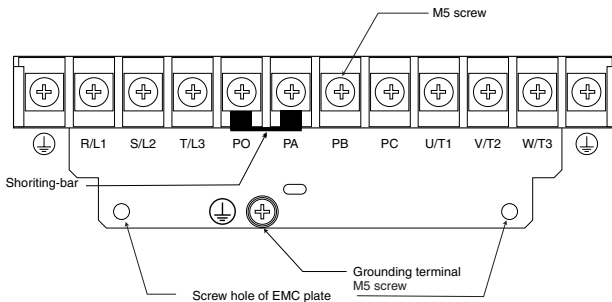

VFS9-2110PM/2150PM
4110PL/4150PL

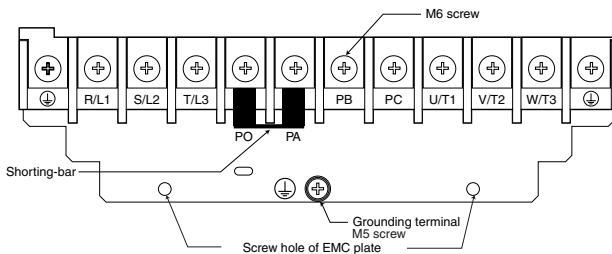

In case of the lug connector, cover the lug connector with insulated tube, or use the insulated lug connector.

- 2) Control circuit terminal board
 The control circuit terminal board is common to all equipment.

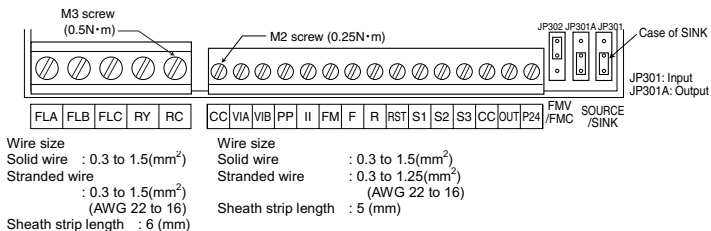

See 2.3.2 for details on all terminal functions.

1.3.3 How to open the front (terminal board) cover

To wire the terminal board, remove the front lower cover in line with the steps given below

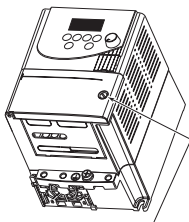

Remove the screw at the right hand side of the front cover.

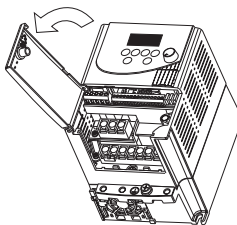



Pull and lift the front (terminal board) cover out toward you.

1.4 Notes on the application

1.4.1 Motors

When the VF-S9 and the motor are used in conjunction, pay attention to the following items.

 Warning	
 Mandatory	Use an inverter that conforms to the specifications of the three-phase induction motor and power supply being used. If the inverter being used does not conform to those specifications, not only will the three-phase induction motor not rotate correctly, but it may cause serious accidents through overheating and fire.

Comparisons with commercial power operation.

The VF-S9 Inverter employs the sinusoidal PWM system. However, the output voltage and output current do not assume a precise sine wave, they have a distorted wave that is close to sinusoidal waveform. This is why compared to operation with a commercial power there will be a slight increase in motor temperature, noise and vibration.

Operation in the low-speed area

When running continuously at low speed in conjunction with a general purpose motor, there may be a decline in that motor's cooling effect. If this happens, operate with the output decreased from rated load.

If you want to run continuously low speed operations at rated torque, please use the VF motor made especially for Toshiba inverter. When operating in conjunction with a VF motor, you must change the inverter's motor overload protection level to "VF motor use (OL₂)".

Adjusting the overload protection level

The VF-S9 Inverter protects against overloads with its overload detection circuits (electronic thermal). The electronic thermal's reference current is set to the inverter's rated current, so that it must be adjusted in line with the rated current of the general purpose motor being used in combination.

High speed operation at and above 60Hz

Operating at frequencies greater than 60Hz will increase noise and vibration. There is also a possibility that such operation will exceed the motor's mechanical strength limits and the bearing limits so that you should inquire to the motor's manufacturer about such operation.

Method of lubricating load mechanisms.

Operating an oil-lubricated reduction gear and gear motor in the low-speed areas will worsen the lubricating effect. Check with the manufacturer of the reduction gear to find out about operable gearing area.

Extremely low loads and low inertia loads

The motor may demonstrate instability such as abnormal vibrations or overcurrent trips at light loads of 50 percent or under of the load percentage, or when the load's inertia moment is extremely small. If that happens reduce the carrier frequency.

Occurrence of instability

Unstable phenomena may occur under the load and motor combinations shown below.

- Combined with a motor that exceeds applicable motor ratings recommended for the inverter
- Combined with special motors such as explosion-proof motors

To deal with the above lower the settings of inverter carrier frequency.

(Do not set to 2.2kHz or lower during vector control).

- Combined with couplings between load devices and motors with high backlash
- In this case, set the S-pattern acceleration/deceleration function and adjust the response time (inertial moment setting) during vector control or switch to V/f control.

- Combined with loads that have sharp fluctuations in rotation such as piston movements

In this case, adjust the response time (inertial moment setting) during vector control or switch to V/f control.

Braking a motor when cutting off power supply

A motor with its power cut off goes into free-run, and does not stop immediately. To stop the motor quickly as soon as the power is cut off install an auxiliary brake. There are different kinds of brake devices, both electrical and mechanical. Select the brake that is best for the system.

Loads that generate negative torque

When combined with loads that generate negative torque the protection for overvoltage and overcurrent on the inverter will go into operation and may cause a trip. For this kind of situation, you must install a dynamic braking resistor, etc. that complies with the load conditions.

Motor with brake

If a motor with brake is connected directly to the output side of the inverter, the brake will not release because voltage at startup is low. Wire the brake circuit separately from the motor's main circuits.

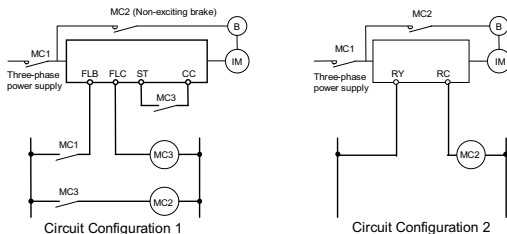

In circuit configuration 1, the brake is turned on and off through MC2 and MC3. If the circuit is config-

ured in some other way, the overcurrent trip may be activated because of the locked rotor current when the brake goes into operation. Circuit configuration 2 uses low-speed signal RY to turn on and off the brake. Turning the brake on and off with a low-speed signal may be better in such applications as elevators. Please confer with us before designing the system.

1.4.2 Inverters

Protecting inverters from overcurrent

The inverter has an overcurrent protection function. However because the programmed current level is set to the inverter's maximum applicable motor, if the motor is one of small capacity and it is in operation, the overcurrent level and the electronic thermal protection must be readjusted. If adjustment is necessary, see 5-14 in Chapter 5, and make adjustments as directed.

Inverter capacity

Do not operate a large capacity motor with a small capacity (kVA) inverter even with light loads. Current ripple will raise the output peak current making it easier to set off the overcurrent trip.

Power factor improving capacitors

Power factor improving capacitors cannot be installed on the output side of the inverter. When a motor is run that has a power factor improving capacitor attached to it, remove the capacitors. This can cause inverter malfunction trips and capacitor destruction.

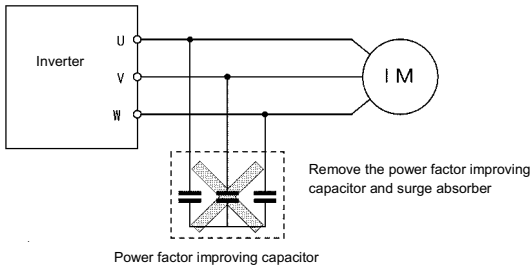

Operating at other than rated voltage

Connections to voltages other than the rated voltage described in the rating label cannot be made. If a connection must be made to a power supply other than one with rated voltage, use a transformer to raise or lower the voltage to the rated voltage.

Circuit interrupting when two or more inverters are used on the same power line.

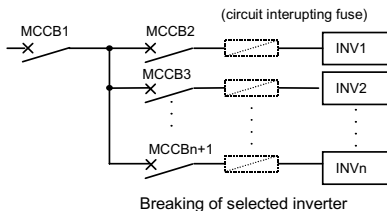

There is no fuse in the inverter's main circuit. Thus, as the diagram above shows, when more than one inverter is used on the same power line, you must select interrupting characteristics so that only the MCCB2 will trip and the MCCB1 will not trip when a short occurs in the inverter (INV1). When you cannot select the proper characteristics install a circuit interrupting fuse between the MCCB2 and the INV1.

■ Disposal

If an inverter is no longer usable, dispose of it as industrial waste.

1.4.3 What to do about leak current

⚠ Warning

Current may leak through the inverter's input/output wires because of insufficient electrostatic capacity on the motor with bad effects on peripheral equipment. The leak current's value is affected by the carrier frequency and the length of the input/output wires. Test and adopt the following remedies against leak current.

(1) Effects of leak current across ground

Leak current may flow not just through the inverter system but also through ground wires to other systems. Leak current will cause earth leakage breakers, leak current relays, ground relays, fire alarms and sensors to operate improperly, and it will cause superimposed noise on the CRT screen or display of incorrect current amounts during current detection with the CT.

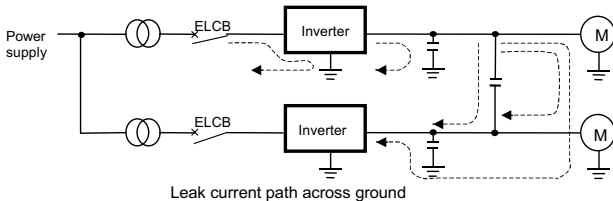

Remedies:

- 1.Reduce PWM carrier frequency.

The setting of PWM carrier frequency is done with the parameter **F300**.

- 2.Use high frequency remedial products (Schneider Toshiba electric corporation: Esper Mighty Series) for earth leakage breakers. If you use equipment like this, there is no need to reduce the PWM carrier frequency.
- 3.If the sensors and CRT are affected, it can be remedied using the reduction of PWM carrier frequency described in 1 above, but if this cannot be remedied since there is an increase in the motor's magnetic noise, please consult with Toshiba.

(2)Affects of leak current across lines

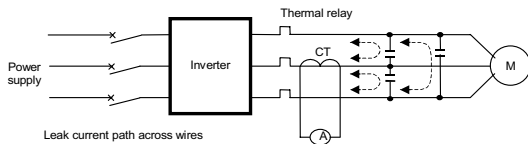

- (1) Thermal relays

The high frequency component of current leaking into electrostatic capacity between inverter output wires will increase the effective current values and make externally connected thermal relays operate improperly. If the wires are more than 50 meters long, it will be easy for the external thermal relay to operate improperly with models having motors of low rated current (several A(ampere) or less), especially the 400V class low capacity (3.7kW or less) models, because the leak current will increase in proportion to the motor rating.

Remedies:

1. Use the electronic thermal built into the inverter.
The setting of the electronic thermal is done using parameter $\text{OLN,THR} (F600)$.
2. Reduce the inverter's PWM carrier frequency. However, that will increase the motor's magnetic noise. Use parameter $F300$ for setting the PWM carrier frequency.
3. This can be improved by installing $0.1\mu\text{F}$ – $0.5\mu\text{F}$ -1000V film capacitor to the input/output terminals of each phase in the thermal relay.

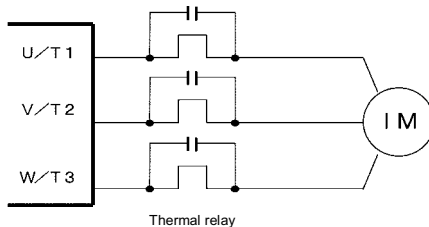

(2) CT and ammeter

If a CT and ammeter are connected externally to detect inverter output current, the leak current's high frequency component may destroy the ammeter. If the wires are more than 50 meters long, it will be easy for the high frequency component to pass through the externally connected CT and be superimposed on and burn the ammeter with models having motors of low rated current (several A(ampere) or less), especially the 400V class low capacity (3.7kW or less) models, because the leak current will increase in proportion to the motor's rated current.



Remedies:



1. Use a meter output terminal in the inverter control circuit.
The output current can be output on the meter output terminal (FM). If the meter is connected, use an ammeter of 1mAdc full scale or a voltmeter of 7.5V-1mA full scale.
2. Use the monitor functions built into the inverter.
Use the monitor functions on the panel built into the inverter to check current values.



1.4.4 Installation

■ Installation environment

The VF-S9 Inverter is an electronic control instrument. Take full consideration to installing it in the proper operating environment.

 Danger	
 Prohibited	<ul style="list-style-type: none"> Do not place any inflammable substances near the VF-S9 Inverter. If an accident occurs in which flame is emitted, this could lead to fire.
 Mandatory	<ul style="list-style-type: none"> Operate under the environmental conditions prescribed in the instruction manual. Operations under any other conditions may result in malfunction.

 Warning	
 Prohibited	<ul style="list-style-type: none"> Do not install the VF-S9 Inverter in any location subject to large amounts of vibration. This could cause the unit to fall, resulting in bodily injury.
 Mandatory	<ul style="list-style-type: none"> Check to make sure that the input power voltage is +10%, -15% of the rated power voltage written on the rating label ($\pm 10\%$ when the load is 100% in continuous operation) If the input power voltage is not +10%, -15% of the rated power voltage ($\pm 10\%$ when the load is 100% in continuous operation) this may result in fire.

 Warning																									
 Prohibited	<ul style="list-style-type: none"> Avoid operation in any location where there is direct spraying of the following solvents or other chemicals. The plastic parts may be damaged to a certain degree depending on their shape, and there is a possibility of the plastic covers coming off and the plastic units being dropped. If the chemical or solvent is anything other than those shown below, please contact us in advance. <div style="display: flex; justify-content: space-between;"> <div style="width: 48%;"> <p>(Table 1) Examples of applicable chemicals and solvents</p> <table border="1" style="width: 100%; border-collapse: collapse;"> <thead> <tr> <th style="width: 50%;">Chemical</th> <th style="width: 50%;">Solvent</th> </tr> </thead> <tbody> <tr> <td>Hydrochloric acid (density of 10% or less)</td> <td>Methanol</td> </tr> <tr> <td>Sulfuric acid (density of 10% or less)</td> <td>Ethanol</td> </tr> <tr> <td>Nitric acid (density of 10% or less)</td> <td>Triol</td> </tr> <tr> <td>Caustic soda</td> <td>Mesopropanol</td> </tr> <tr> <td>Ammonia</td> <td>Glycerin</td> </tr> <tr> <td>Sodium chloride (salt)</td> <td></td> </tr> </tbody> </table> </div> <div style="width: 48%;"> <p>(Table 2) Examples of unapplicable chemicals and solvents</p> <table border="1" style="width: 100%; border-collapse: collapse;"> <thead> <tr> <th style="width: 50%;">Chemical</th> <th style="width: 50%;">Solvent</th> </tr> </thead> <tbody> <tr> <td>Phenol</td> <td>Gasoline, kerosene, light oil</td> </tr> <tr> <td>Benzenesulfonic acid</td> <td>Turpentine oil</td> </tr> <tr> <td></td> <td>Benzol</td> </tr> <tr> <td></td> <td>Thinner</td> </tr> </tbody> </table> </div> </div>	Chemical	Solvent	Hydrochloric acid (density of 10% or less)	Methanol	Sulfuric acid (density of 10% or less)	Ethanol	Nitric acid (density of 10% or less)	Triol	Caustic soda	Mesopropanol	Ammonia	Glycerin	Sodium chloride (salt)		Chemical	Solvent	Phenol	Gasoline, kerosene, light oil	Benzenesulfonic acid	Turpentine oil		Benzol		Thinner
Chemical	Solvent																								
Hydrochloric acid (density of 10% or less)	Methanol																								
Sulfuric acid (density of 10% or less)	Ethanol																								
Nitric acid (density of 10% or less)	Triol																								
Caustic soda	Mesopropanol																								
Ammonia	Glycerin																								
Sodium chloride (salt)																									
Chemical	Solvent																								
Phenol	Gasoline, kerosene, light oil																								
Benzenesulfonic acid	Turpentine oil																								
	Benzol																								
	Thinner																								

Note: The plastic cover has resistance to deformation by the above applicable solvents. They are not examples for resistance to fire or explosion.



- Do not install in any location of high temperature, high humidity, moisture condensation and freezing and avoid locations where there is exposure to water and/or where there may be large amounts of dust, metallic fragments and oilmist.
- Do not install in any location where corrosive gases or grinding fluids are present.
- Operate in areas where ambient temperature ranges from -10°C to 60°C. (Operation over 40°C is allowed when peel off the top warning label. And operation over 50°C is allowed when reduce to 70°C or less of rated current.)

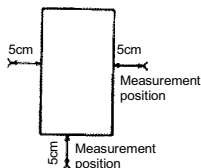
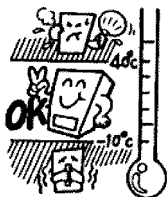

Note: The inverter is a heat-emitting body. Make sure to provide proper space and ventilation when installing in the cabinet. When installing inside a cabinet, we recommend peel of the top seal although 40°C or less.

- Do not install in any location that is subject to large amounts of vibration.





Note: If the VF-S9 Inverter is installed in a location that is subject to vibration, anti-vibration measures are required. Please consult with Toshiba about these measures.

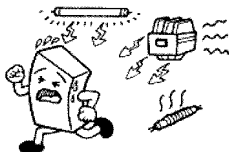

- If the VF-S9 Inverter is installed near any of the equipment listed below, provide measures to insure against errors in operation.



- | | |
|----------------------|-------------------------------------|
| Solenoids: | Attach surge suppressor on coil. |
| Brakes: | Attach surge suppressor on coil. |
| Magnetic contactors: | Attach surge suppressor on coil. |
| Fluorescent lights: | Attach surge suppressor on coil. |
| Resistors: | Place far away from VF-S9 Inverter. |

■ How to install

 Danger	
 Prohibited	<ul style="list-style-type: none"> Do not install and operate the inverter if it is damaged or any component is missing. This can result in electric shock or fire. Please consult your local agency for repairs.
 Mandatory	<ul style="list-style-type: none"> Must be installed in nonflammables such as metals. The rear panel gets very hot so that if installation is in an inflammable object, this can result in fire. Do not operate with the front panel cover removed. This can result in electric shock. An emergency stop device must be installed that fits with system specifications (e.g. cuts off input power then engages mechanical brakes). Operation cannot be stopped immediately by the inverter alone, thus risking an accident or injury. All options used must be those specified by Toshiba. The use of any other option may result in an accident.

 Warning	
 Mandatory	<ul style="list-style-type: none"> The main unit must be installed on a base that can bear the unit's weight. If the unit is installed on a base that cannot withstand that weight, the unit may fall resulting in injury. If braking is necessary (to hold motor shaft), install a mechanical brake. The brake on the inverter will not function as a mechanical hold, and if used for that purpose, injury may result.

■ Installation location

Select a location with good indoor ventilation, place lengthwise in the vertical direction and attach to a metal wall surface.

If you are installing more than one inverter, the separation between inverters should be at least 5 centimeters, and they should be arranged in horizontal rows.

If the inverters are horizontally arranged with no space between them (side-by-side installation), peel of the ventilation seals on top of the inverters and operate at 40°C or less (model of 3.7kW or less). Operate at 50°C or less (model of 5.5kW or more).

• Standard installation

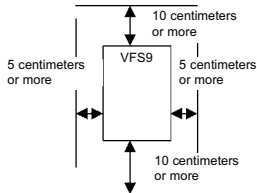

• Horizontal installation (side-by-side installation)

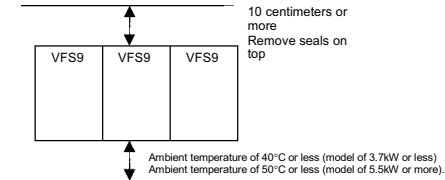

The space shown in the diagram is the minimum allowable space. Because air cooled equipment has cooling fans built in on the top or bottom surfaces, make the space on top and bottom as large as possible to allow for air passage.

Note: Do not install in any location where there is high humidity or high temperatures and where there are large amounts of dust, metallic fragments and oilmist. If you are going to install the equipment in any area that presents a potential problem, please consult with Toshiba before doing so.

■ Calorific values of the inverter and the required ventilation

The energy loss when the inverter converts power from AC to DC and then back to AC is about 5 percent. In order to suppress the rise in temperature inside the cabinet when this loss becomes heat loss, the interior of the cabinet must be ventilated and cooled.

The amount of forcible air cooling ventilation required and the necessary heat discharge surface quantity when operating in a sealed cabinet according to motor capacity are as follows.

Voltage Class	Operating motor capacity (kW)	Inverter Type	Calorific Values		Amount of forcible air cooling ventilation required (m ³ /min)	Heat discharge surface area required for sealed storage cabinet(m ²)	
			Carrier frequency 4kHz	Carrier frequency 12kHz			
Single-Phase 200V Class	0.2	VFSSS-	2002PL	23	29	0.23	0.8
	0.4		2004PL	47	60	0.29	1.0
	0.75		2007PL	74	88	0.40	1.4
	1.5		2015PL	142	169	0.60	2.1
	2.2		2022PL	239	270	0.80	2.8
Single-Phase 200V Class	0.2	VFSS-	2002PM	21	26	0.23	0.8
	0.4		2004PM	43	54	0.29	1.0
	0.75		2007PM	67	79	0.40	1.4
	1.5		2015PM	131	150	0.60	2.1
	2.2		2022PM	168	195	0.80	2.8
	3.7		2037PM	330	374	1.2	4.3
	5.5		2055PL	450	510	1.7	6.1
	7.5		2075PL	576	635	2.3	8.1
	11		2110PM	750	820	3.4	12.0
	15		2150PM	942	1035	4.6	16.0
Three-Phase 400V Class	0.75	VFSS-	2007PL	44	57	0.40	1.4
	1.5		2015PL	77	99	0.60	2.1
	2.2		2022PL	103	134	0.80	2.8
	3.7		2037PL	189	240	1.2	4.3
	5.5		2055PL	264	354	1.7	6.1
	7.5		2075PL	358	477	2.3	8.1
	11		2110PL	490	650	3.4	12.0
	15		2150PL	602	808	4.6	16.0

Notes

- 1) The heat loss for the optional external devices (input reactor, DC reactor, radio noise reduction filters, etc.) is not included in the calorific values in the table.
- 2) Case of 100% Load Continuation operation.

■ Panel designing taking into consideration the effects of noise.

The inverter generates high frequency noise. When designing the control panel setup, consideration must be given to that noise. Examples of measures are given below.

- Wire so that the main circuit wires and the control circuit wires are separated. Do not place them in the same conduit, do not run them parallel, and do not bundle them.
- Provide shielding and twisted wire for control circuit wiring.
- Separate the input (power) and output (motor) wires of the main circuit. Do not place them in the same conduit, do not run them parallel, and do not bundle them.
- Ground the inverter ground terminals (⏚).
- Install surge suppressor on any magnetic contactor and relay coils used around the inverter.

- Install noise filters if necessary.
- Install EMC plate (attached as standard) and shielded wires fit with the EMC plate.

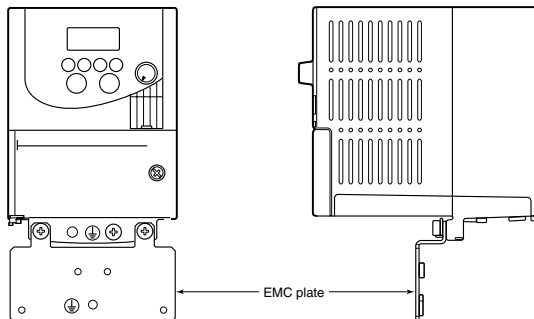



■ Installing more than one unit in a cabinet

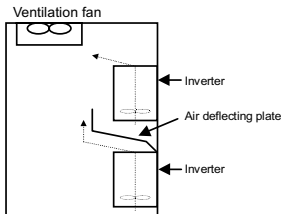

If you are installing two or more inverters in one cabinet, pay attention to the following.

- Ensure a space of at least 5 centimeters on the left and right sides of the inverters.
 - * If the inverters are horizontally arranged with no space between them (side-by-side installation), remove the ventilation seals on top of the inverters and operate at 40°C or less (model of 3.7kW or less) or 50°C (model of 5.5kW or more).
- Ensure a space of at least 20 centimeters on the top and bottom of the inverters.
- Install an air deflecting plate so that the heat rising up from the inverter on the bottom does not affect the inverter on the top.







2. Connection equipment



 Danger	
 Disassembly prohibited	<ul style="list-style-type: none"> Never disassemble, modify or repair. This can result in electric shock, fire and injury. For repairs, call your sales agency.
 Prohibited	<ul style="list-style-type: none"> Don't stick your fingers into openings such as cable wiring hole and cooling fan covers. This can result in electric shock or other injury. Don't place or insert any kind of object into the inverter (electrical wire cuttings, rods, wires). This can result in electric shock or fire. Do not allow water or any other fluid to come in contact with the inverter. That may result in electric shock or fire.

 Warning	
 Prohibited	<ul style="list-style-type: none"> When transporting or carrying, do not hold by the front panel covers. The covers may come off and the unit will drop out resulting in injury.

2.1 Cautions on wiring

 Danger	
 Prohibited	<ul style="list-style-type: none"> Never remove the front cover when power is on or open door if enclosed in a cabinet. The unit contains many high voltage parts and contact with them will result in electric shock.
 Mandatory	<ul style="list-style-type: none"> Turn power on only after attaching the front cover or closing door if enclosed in a cabinet. If power is turned on without the front cover attached or closing door if enclosed in a cabinet. This can result in electric shock or other injury. Electrical construction work must be done by a qualified expert. Connection of input power by someone who does not have that expert knowledge may result in fire or electric shock. Connect output terminals (motor side) correctly. If the phase sequence is incorrect, the motor will operate in reverse and that may result in injury. Wiring must be done after installation. If wiring is done prior to installation that may result in injury or electric shock. The following steps must be performed before wiring. <ol style="list-style-type: none"> Shut off all input power. Wait at least ten minutes and check to make sure that the charge lamp is no longer lit. Use a tester that can measure DC voltage (800VDC or more), and check to make sure that the voltage to the DC main circuits (across PA-PC) is 45V or less. If these steps are not properly performed, the wiring will cause electric shock. Tighten the screws on the terminal board to specified torque. If the screws are not tightened to the specified torque, it may lead to fire.

 Danger	
 Be Grounded	<ul style="list-style-type: none"> Ground must be connected securely. If the ground is not securely connected, it could lead to electric shock or fire when a malfunction or current leak occurs.

 Warning	
 Prohibited	<ul style="list-style-type: none"> Do not attach devices with built-in capacitors (such as noise filters or surge absorber) to the output (motor side) terminal. This could cause a fire.

2

■ Preventing radio noise

To prevent electrical interference such as radio noise, separately bundle wires to the main circuit's power terminals (R/L1, S/L2, T/L3) and wires to the motor terminals (U/T1, V/T2, W/T3).



■ Control and main power supply

The control power supply and the main circuit power supply for the VFS9 are the same. If a malfunction or trip causes the main circuit to be shut off, control power will also be shut off. When checking the cause of the malfunction or the trip, use the trip holding retention selection parameter.

■ Wiring

- Because the space between the main circuit terminals is small use sleeved pressure terminals for the connections. Connect the terminals so that adjacent terminals do not touch each other.
- For ground terminal  use wires of the size that is equivalent to or larger than those given in table 10.1 and always ground the inverter (200V voltage class: D type ground [former type 3 ground]; 400V class: C type ground [former special type 3 ground]).
Use as large and short a ground wire as possible and wire it as close as possible to the inverter.
- See the table in 9-1 for wire sizes.
- The length of the main circuit wire in 10-1 should be no longer than 30 meters. If the wire is longer than 30 meters, the wire size (diameter) must be increased.

2.2 Standard connections

 Danger	
 Prohibited	<ul style="list-style-type: none"> • Do not connect input power to the output (motor side) terminals (U/T1, V/T2, W/T3). Connecting input power to the output could destroy the inverter or cause a fire. • Do not connect resistors to DC terminals (across PA-PC or across PO-PC). It could cause a fire. Connect resistors as directed in the instructions for "Installing separate braking resistors." • First shut off input power and wait at least 10 minutes before touching wires on equipment (MCCB) that is connected to inverter power side. <u>Touching the wires before that time could result in electric shock.</u>
 Always connect to ground	<ul style="list-style-type: none"> • Securely connect to ground with a ground wire. If a secure connection to ground is not made, this could cause electric shock or fire when a malfunction or leak current occurs.

2.2.1 Standard connection diagram 1 - sink (common: CC)

This diagram shows a standard wiring of the main circuit.

Main circuit power supply
 200V class: single-phase 200 ~ 240V-50/60Hz
 three-phase 200 ~ 230V-50/60Hz
 400V class: three-phase 380 ~ 500V-50/60Hz

2



*1 1-phase series don't have T/L3 terminal.
 *2 The PQ-FA terminals are inserted by a bar when shipped from the factory. Before installing the DC reactor (DCL), remove the bar.

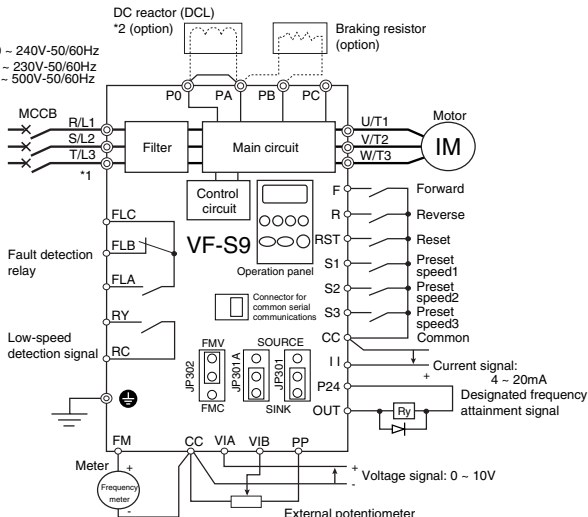

External potentiometer (or input voltage signal across VIA-CC terminals: 0 ~ 10V)

*The VIA terminal and I1 terminal cannot be used at the same time.

2.2.2 Standard connection diagram 2 - source (common: P24)

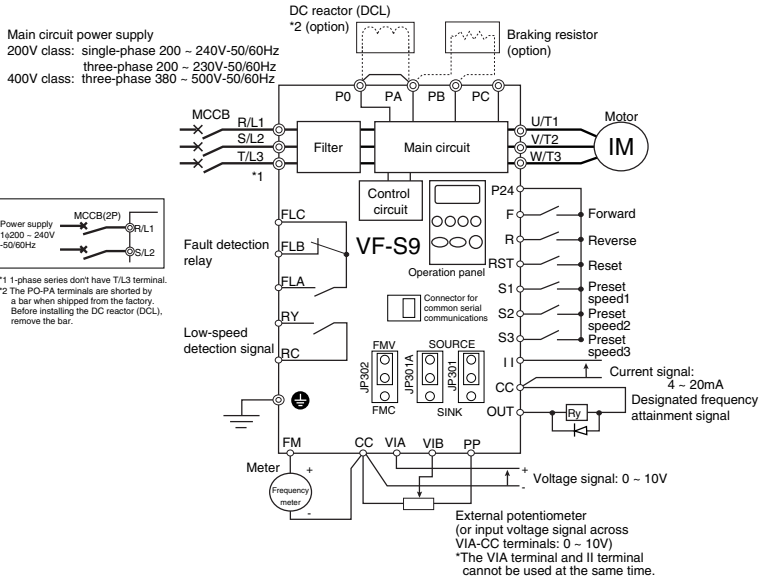

2

2.3 Description of terminals

2.3.1 Main circuit terminals

This diagram shows an example of wiring of the main circuit. Use options if necessary.

■ Power supply and motor connections

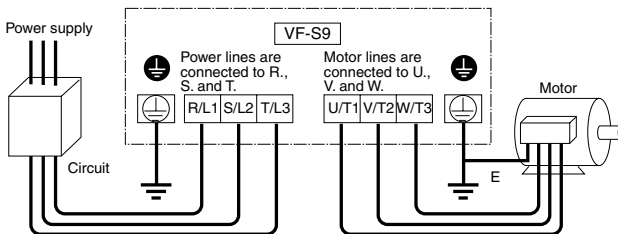

Note) Model of 3-phase 200V-0.2, 0.4, 0.75kW don't have grounding terminal.

Ground connecting to flame of inverter.

⊕ : Flame grounding

■ Connections with peripheral equipment

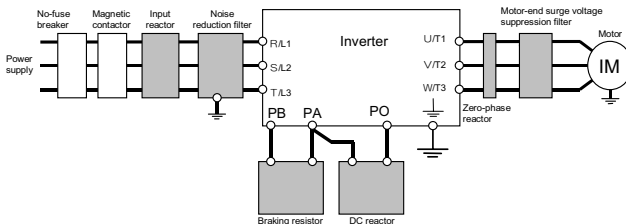

■ Main circuit

Terminal symbol	Terminal function
	Grounding terminal for connecting inverter case.
R/L1,S/L2,T/L3	200V class: single-phase 200~240V-50/60Hz three-phase 200~230V-50/60Hz 400V class: three-phase 380~500V-50/60Hz * Single - phase series don't have T/L3 terminal.
U/T1,V/T2,W/T3	Connect to a (three-phase induction) motor.
PA,PB	Connect to braking resistors Change parameters F 304 , F 305 and F 308 if necessary.
PC	This is a negative potential terminal in the internal DC main circuit. DC common power can be input across the PA terminals (positive potential).
PO,PA	Terminals for connecting a DC reactor (DCL: optional external device). Shorted by a short bar when shipped from the factory. Before installing DCL, remove the short bar.

2

2.3.2 Control circuit terminals (sink logic)

The control circuit terminal board is the same for all models.

Wire size : See 1.3.2.

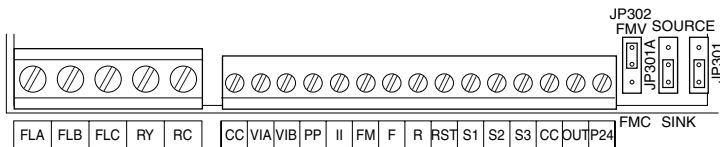

Terminal symbol	Input/output	Function	Electrical specifications	Inverter internal circuits	
F	Input	Multifunction programmable/contact input	No voltage contact input 24Vdc-5mA or less *Sink-source switchable (JP301)		
R	Input				Shorting across F-CC causes forward rotation; open causes slow-down and stop.
RST	Input				Shorting across R-CC causes reverse rotation; open causes slow-down and stop.
S1	Input				Shorting across RST-CC causes a held reset when the inverter protector function is operating. Note that when the inverter is operating normally, it will not operate even if there is a short across RST-CC.
S2	Input				Shorting across RST-CC causes a held reset when the inverter protector function is operating. Note that when the inverter is operating normally, it will not operate even if there is a short across RST-CC.
S3	Input	Shorting across S1-CC causes pre-set speed operation.	Shorting across S2-CC causes pre-set speed operation.	Shorting across S3-CC causes pre-set speed operation.	

Terminal symbol	Input/output	Function	Electrical specifications	Inverter internal circuits
CC	Common to Input/output	Control circuit's equipotential terminal		
PP	Output	Analog input setting power output	10Vdc (permissible load current: 10mAdc)	
I	Input	Multifunction programmable analog input. Standard default setting: 4(0)~20mAdc input and 0~50Hz (50Hz setting) or 0~60Hz (60Hz setting) frequency	4~20mA (internal impedance: 400Ω)	
VA	Input	Multifunction programmable analog input. Standard default setting: 0~10Vdc input and 0~80Hz frequency	10Vdc (internal impedance: 30kΩ)	
VIB	Input	Multifunction programmable analog input. Standard default setting: 0~10Vdc input and 0~50Hz(50Hz setting) or 0~60Hz(60Hz setting) frequency.	10Vdc (internal impedance: 30kΩ)	
FM	Output	Multifunction programmable analog output. Standard default setting: output current. Connect a 1mAdc full-scale ammeter or 7.5Vdc (10Vdc)-1mA full-scale voltmeter. Can change to 0~20mA (4~20mA) by jumper JP302 switching.	1mA full-scale DC ammeter or 7.5Vdc 1mA full-scale dc voltmeter 0~20mA (4~20mA) full scale DC ammeter	
CC	Common to Input/output	Control circuit's equipotential terminal		
P24	Output	24Vdc power output	24Vdc-100mA	

* The VIA terminal and II terminal cannot be used at the same time.

Terminal symbol	Input/output	Function	Electrical specifications	Inverter internal circuits
OUT	Output	Multifunction programmable open collector output. Standard default settings detect and output speed reach signal output frequencies.	Open collector output : 24Vdc-50mA *Sink-source switchable (JP301A)	
RC RY	Output	Multifunction programmable relay contact output. Contact ratings: 250Vac -2A (cos ϕ = 1), 30Vdc-1A, 250Vac-1A (cos ϕ = 0.4). Standard default settings detect and output low-speed signal output frequencies.	250Vac-2A (cos ϕ = 1) : at resistance load 30Vdc-1A : 250Vac-1A (cos ϕ = 0.4)	
FLA FLB FLC	Output	Multifunction programmable relay contact output. Contact ratings: 250Vac -2A (cos ϕ = 1), 30Vdc-1A, 250Vac-1A (cos ϕ = 0.4). Detects the operation of the inverter's protection function. Contact across FLA-FLC is closed and FLB-FLC is opened during protection function operation.	250Vac-2A (cos ϕ = 1) : at resistance load 30Vdc-1A : 250Vac-1A (cos ϕ = 0.4)	

■ Sink logic (negative common)/source logic (positive common)
logic switching of input output terminals

Current flowing out turns control input terminals on. These are called sink logic terminals (The end of Type - form : AN / WN). The general used method in Europe is source logic in which current flowing into the input terminal turns it on(The end of Type - form : WP).

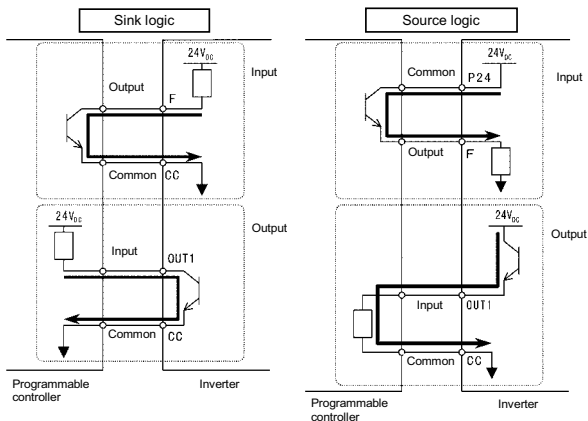

2

■ Logic switching/voltage-current output switching (jumper)

(1) Logic switching

JP301 : Input, JP301A : Output

Switch logic before wiring to inverter and without supplying power. If sink and source are switched when power is supplied first after logic switching or while power is being input to the inverter, that will destroy the inverter. First check to make sure that switching is correct and then supply power.

(2) Voltage-current output switching



JP302

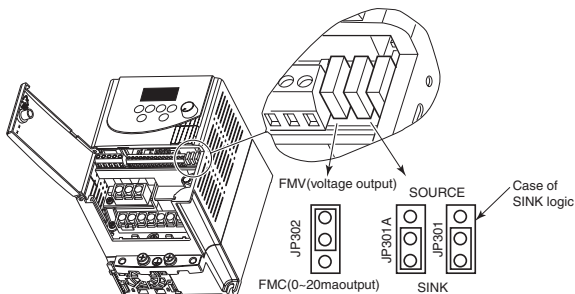

Switch the Fm terminal's voltage-current output before wiring to inverter and without supplying power.



* After switching sink-source logic make sure that switching again switching cannot be done easily.

3. Operations

 Danger	
 Prohibited	<ul style="list-style-type: none"> Do not touch inverter terminals when electrical power is connected to the inverter even if the motor is stopped. Touching the inverter terminals while power is connected to it may result in electric shock. Do not touch switches when the hands are wet and do not try to clean the inverter with a damp cloth. Such practices may result in electric shock. Do not go near the motor in alarm-stop status when the retry function is selected. The motor may suddenly restart and that could result in injury. Take measures for safety, e.g. attaching a cover to the motor, against accidents when the motor unexpectedly restarts.
 Mandatory	<ul style="list-style-type: none"> Turn power on only after attaching the front cover or closing door if enclosed in a cabinet. If power is turned on without the front cover attached or closing door if enclosed in a cabinet, that may result in electric shock or other injury. If the inverter begins to emit smoke or an unusual odor, or unusual sounds, immediately turn power off. If the equipment is continued in operation in such a state, the result may be fire. Call your local sales agency for repairs. Always turn power off if the inverter is not used for long periods of time. Turn input power on after attaching the front cover. When enclosed inside a cabinet and using with the front cover removed, always close the cabinet doors first and then turn power on. If the power is turned on with the front cover or the cabinet doors open, it may result in electric shock. Make sure that operation signals are off before resetting the inverter after malfunction. If the inverter is reset before turning off the operating signal, the motor may restart suddenly causing injury.

 Warning	
 Contact prohibited	<ul style="list-style-type: none"> Do not touch heat radiating fins or discharge resistors. These device are hot, and you'll get burned if you touch them.
 Prohibited	<ul style="list-style-type: none"> Always observe the permissible operating ranges of motors and other equipment (see the instruction manual for the motor). If these ranges are not observed, it could result in injury.

3.1 How to operate the VF-S9

Overview of how to operate the inverter with simple examples.

Example 1 Setting the operation frequency using built-in potentiometer and running and stopping using the operation panel.

(1) Wiring

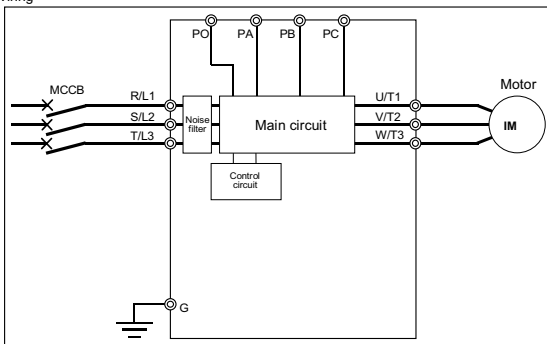

(2) Parameter setting (default setting)

Title	Function	Programmed value
\overline{ENd}	Command mode selection	1
\overline{FRd}	Frequency setting mode selection	2

(3) Operation

Run/stop: Press the RUN and STOP keys on the panel.

Frequency setting: Set adjusting position of notches on the potentiometer.

Example 2 Setting the operation frequency using the operation panel and running and stopping using the operation panel.

(1) Wiring

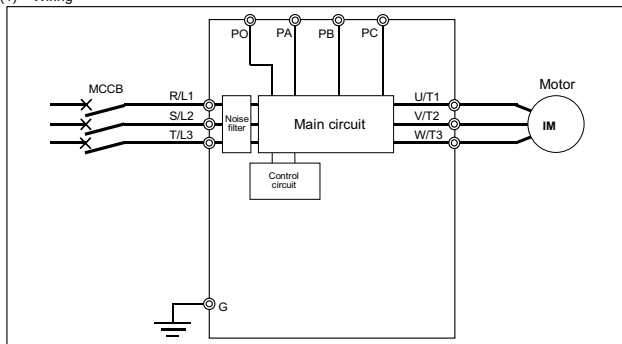

(2) Setting parameters

Title	Function	Programmed value
<i>F_{ROd}</i>	Command mode selection	1
<i>F_{RD}</i>	Frequency setting mode selection	1

(3) Operation

Run/stop: Press the **(RUN)** and **(STOP)** keys on the panel.

Frequency setting: Set with the **(▲)** **(▼)** keys on the operation panel.

To store the set frequencies in memory, press the **(ENT)** key.

F_{CL} and the set frequency will flash on and off alternately.

Example 3 Setting the operation frequency using built-in potentiometer and running and stopping using external signals.

(1) Wiring

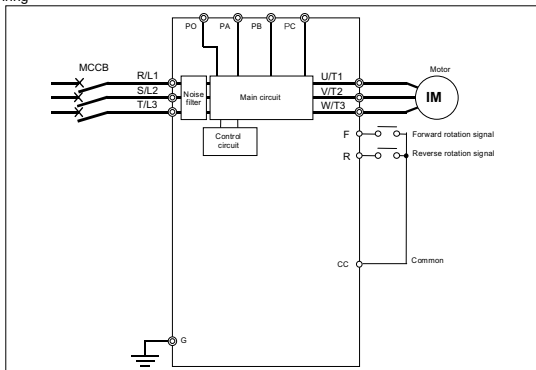

(2) Parameter setting (default setting)

Title	Function	Programmed value
<i>CR0d</i>	Command mode selection	0
<i>FR0d</i>	Frequency setting mode selection	2

(3) Operation

Run/stop: ON/OFF input to F-CC and R-CC. (Set JP301 to Sink logic)

Frequency setting: Set adjusting position of notches on the potentiometer.

3

Example 4 Operation frequency setting, running and stopping using external signals.

(1) Wiring

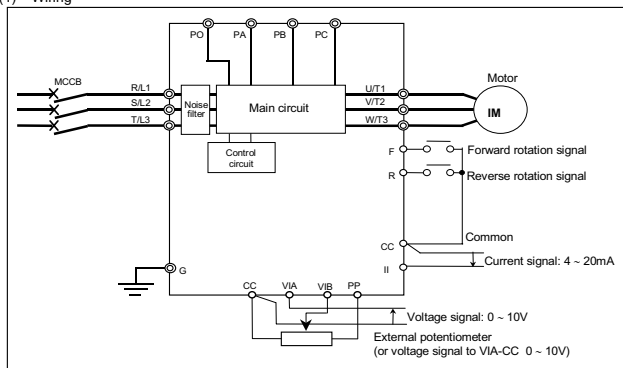

(2) Parameter setting

Title	Function	Programmed value
F004	Command mode selection	0
F005	Frequency setting mode selection	0

(3) Operation

Run/stop: ON/OFF input to F-CC and R-CC. (Set JP301 to Sink logic.)

Frequency setting: VIA and VIB: 0-10Vdc (external potentiometer)

II : Input 4-20mA dc.

Note) The VIA terminal and II terminal cannot be used at the same time.

3.2 Simplified Operation of the VF-S9

The procedures for setting operation frequency and the methods of operation can be selected from the following.

Run / stop

- :
- (1) Run and stop using external signals to the terminal board
 - (2) Run and stop from the operation panel

Frequency setting

- :
- (1) Setting using external signals to the terminal board (0-10Vdc, 4-20mA dc)
 - (2) Setting using the operation panel
 - (3) Setting using the potentiometer on the inverter main unit

Use the basic parameters $Cn0d$ (command mode selection) and $Fn0d$ (frequency setting mode selection) for selecting.

Title	Function	Adjustment range	Default setting
$Cn0d$	Command mode selection	0: Terminal board; 1: Operation panel	1
$Fn0d$	Frequency setting mode selection	0: Terminal board; 1: Operation panel; 2: Internal potentiometer	2

[Steps in setting parameters]

Key operated	LED display	Operation
	0.0	Displays the operation frequency (operation stopped). (When standard monitor display selection $F710$ is set to 0 (Operation frequency))
(MON)	RU!	Press the MON key to display the first basic parameter RU! (automatic acceleration/deceleration).
(▲) (▼)	$Cn0d$	Press either the ▲ key or the ▼ key to select " $Cn0d$."
(ENT)	i	Press the ENTER key to display the parameter setting. (Standard default setting: i)
(▲) (▼)	0	Change the parameter to 0 (Terminal board) by pressing the ▲ key.
(ENT)	0 \leftrightarrow $Cn0d$	Press the ENTER key to save the changed parameter. $Cn0d$ and the parameter set value are displayed alternately.
(▲) (▼)	$Fn0d$	Press either the ▲ key or the ▼ key to select " $Fn0d$."
(ENT)	2	Press the ENTER key to display the parameter setting. (Standard default setting: 2)
(▲) (▼)	i	Change the parameter to i (Operation panel) by pressing the ▲ key
(ENT)	i \leftrightarrow $Fn0d$	Press the ENTER key to save the changed parameter. $Fn0d$ and the parameter set value are displayed alternately.

* Pressing the MON key twice returns the display to standard monitor mode (displaying operation frequency).

3.2.1 How to start and stop

(1) Start and stop using the operation panel keys (CR0d : 1)

Use the **RUN** and **STOP** keys on the operation panel to start and stop the motor.

RUN: Motor starts.

STOP: Motor stops (slowdown stop).

(2) Start and stop using external signals to the terminal board (CR0d : 0)

Use external signals to the inverter terminal board to start and stop the motor. (Set JP301 to sink logic)

Short **F** and **CC** terminals:
run forward

Open **F** and **CC** terminals:
slow down and stop

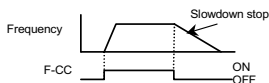

* Coast stop

The standard default setting is for slowdown stop. To make a coast stop, assign an ST terminal function to an idle terminal using the programmable terminal function. And set the F ST signal selection. For coast stop, open the ST-CC when stopping the motor in the state described at left. The monitor on the inverter at this time will display **OFF**.

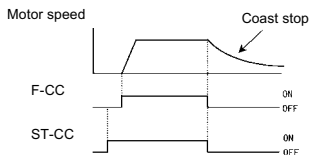

3.2.2 How to set the frequency

(1) Setting the frequency using the potentiometer on the inverter main unit (FR0d : 2)

Set the frequency with the notches on the potentiometer.

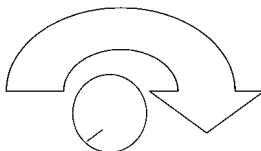

Move clockwise through the higher notches for the higher frequencies.





(2) Setting the frequency using the operation panel (*FREQ* : 1)

Set the frequency from the operation panel.

 : Moves the frequency up

 : Moves the frequency down

■ Example of operating a run from the panel

Key operated	LED display	Operation
	0.0	Displays the operation frequency. (When standard monitor display selection F 7 : 0 is set to 0 [operation frequency])
 	50.0	Set the operation frequency.
	50.0 ↔ F 0	Press the ENT key to save the operation frequency. F 0 and the set frequency are displayed alternately.
 	60.0	Pressing the Δ key or the ∇ key will change the operation frequency even during operation.

(3) Setting the frequency using external signals to the terminal board (*FREQ* : 0)

■ Frequency setting

- 1) Setting the frequency using external potentiometer

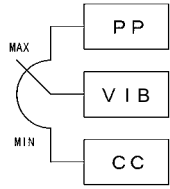

Setting frequency using the potentiometer

* Potentiometer control
Set frequency using the potentiometer (1~10kΩ-1/4W)
For more detailed information on adjustments, see 6.5.

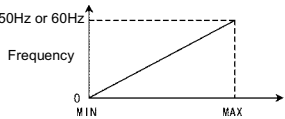

Frequency

* The input terminal VIB can be used in the same way and VIA and VIB are automatically switched by the default settings. Set parameters to specify priority. For more details, see 6.5.

Note: The VIA terminal and II terminal cannot be used at the same time.

2) Setting the frequency using input voltage (0~10V)

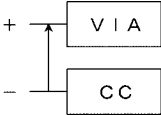

* voltage signal
 Setting frequency using voltage signals (0~10V). For more detailed information on adjustments, see 6.5.

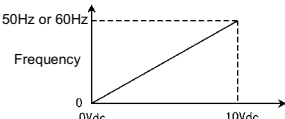

* The input terminal VIB can be used in the same way. VIA and VIB are automatically switched by the default settings. Set parameters to specify priority. For more details, see 6.5.
 Note: The VIA terminal and II terminal cannot be used at the same time.

3) Setting the frequency using current input (4~20mA)

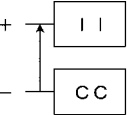

* Current signal
 Setting frequency using current signals (4~20mA). For more detailed information on adjustments, see 6.5.

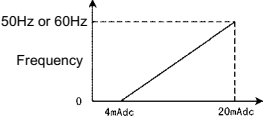

* Setting of parameters also allow 0~20mA dc.
 Note: The VIA terminal and II terminal cannot be used at the same time.

4. Basic VF-S9 operations

The VF-S9 has the following three monitor modes.

Standard monitor mode

: The standard inverter mode. This mode is enabled when inverter power goes on.

This mode is for monitoring the output frequency and setting the frequency designated value. In it is also displayed information about status alarms during running and trips.

- Setting frequency designated values - see 3.2.2
- Status alarm

If there is an error in the inverter, the alarm signal and the frequency will flash alternately in the LED display.

□ : When a current flows at or higher than the overcurrent stall level.

P : When a voltage is generated at or higher than the over voltage stall level.

L : When a load reaches 50% or higher of the overload trip value.

H : When temperature inside the inverter rises to the overheating protection alarm level.

Model of 3.7kW or less : about 115°C.

Model of 5.5kW or more : about 92°C

Setting monitor mode

: The mode for setting inverter parameters.

For more on how to set parameters, see 4.1.

Status monitor mode

: The mode for monitoring all inverter status.

Allows monitoring of set frequencies, output current/voltage and terminal information.

For more on how to use the monitor, see 8.1.

Pressing the **MON** key will move the inverter through each of the modes.

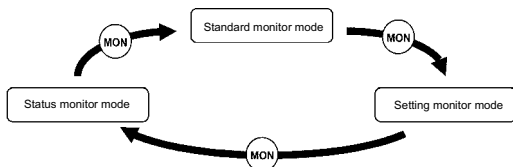

4.1 How to set parameters

Setting monitor mode

The standard default parameters are programmed before the unit is shipped from the factory. Parameters can be divided into three major categories. Select the parameter to be changed or to be searched and retrieved.

Basic parameters

: The basic parameters that must be programmed before the first use.

Extended parameters

: The parameters for detailed and special setting.

User parameters

(automatic edit function)

: Indicates parameters that are different from the standard default setting parameters. Use them to check after setting and to change setting.
(Parameter title: \square \square \square)

Setup parameters

: When the standard setting (\square \square \square = \square) is entered, this parameter is displayed.

* Adjustment range of parameters

H : An attempt has been made to assign a value that is higher than the programmable range. Or, as a result of changing other parameters, the programmed value of the parameter that is now selected exceeds the upper limit.

L : An attempt has been made to assign a value that is lower than the programmable range. Or, as a result of changing other parameters, the programmed value of the parameter that is now selected exceeds the lower limit.

If the above alarm is flashing on and off, no setting can be done of values that are equal to or greater than H ! or equal to or lower than L !.

While these codes are flashing on and off, no change can be made to any parameter.

4.1.1 How to set the basic parameters

Basic parameters





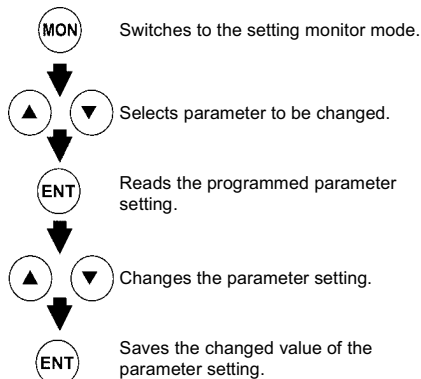













All of the basic parameters can be set by the same step procedures.

[Steps in key entry for basic parameters]



- * The inverters are shipped from the factory with set parameters by default.
- * Select the parameter to be changed from "Table of parameters".
- * If there is something that you do not understand during the operation, press the MON key to return to the  indication.

Steps in setting are as follows (the example shown is one of changing the maximum frequency from 80Hz to 60Hz).

Key operated	LED display	Operation
		Displays the operation frequency (operation stopped). (When standard monitor display selection  is set to 0 [operation frequency]).
		Press the MON key to display the first basic parameter  (automatic acceleration/deceleration).
		Press either the  key or the  key to select "FH".
		Pressing the ENTER key reads the maximum frequency.
		Press the  key to change the maximum frequency to 60Hz.
		Press the ENTER key to save the changed maximum frequency. FH and frequency are displayed alternately.
After this, 	→Displays the same programmed parameter.	
		→Switches to the display in the status monitor mode.
		
		→Displays names of other parameters.

4.1.2 How to set extended parameters

The VF-S9 has extended parameters to allow you to make full use of its functions. All extended parameters are expressed with F and three digits.

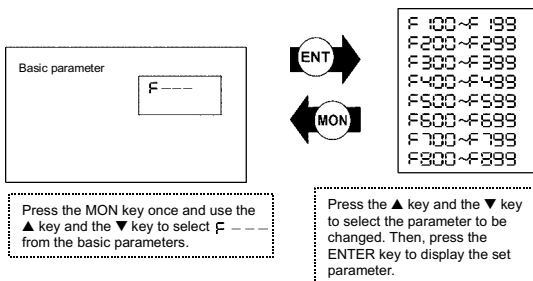

[Steps in key entry for extended parameters]

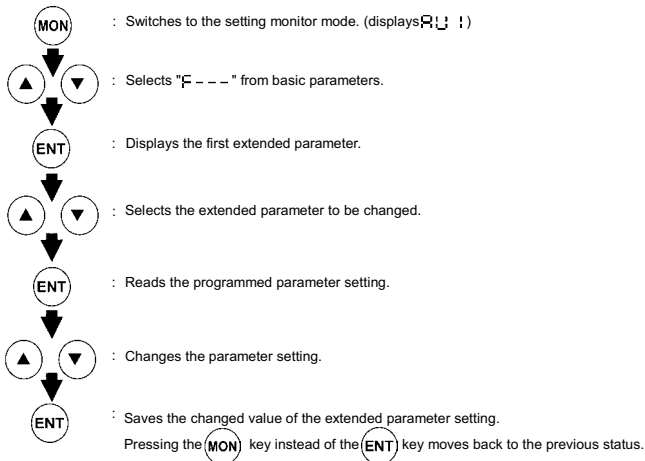

■ Example of parameter setting

The steps in setting are as follows.

Example of changing the dynamic braking selection F 304 from 0 to 1.

Key operated	LED display	Operation
	0. 0	Displays the operation frequency (operation stopped). (When standard monitor display selection F 1 0 is set to 0 [operation frequency])
(MON)	RU !	Press the MON key to display the first basic parameter RU ! (automatic acceleration/deceleration).
(▲) (▼)	F ---	Press either the ▲ key or the ▼ key to change to the parameter group F ---.
(ENT)	F 100	Press the ENTER key to display the first extended parameter F 100.
(▲) (▼)	F 304	Press the ▲ key to change to the dynamic braking selection F 304.
(ENT)	0	Pressing the ENTER key allows the reading of parameter setting.
(▲) (▼)	:	Press the ▲ key to change the dynamic braking selection from 0 to !.
(ENT)	! ⇄ F 304	Pressing the ENTER key alternately flashes on and off the parameter and changed value and allows the save of those values.

If there is anything you do not understand during this operation, press the MON key several times to start over from the step of RU ! display.

4.1.3 Search and resetting of changed parameters

Automatically searches for only those parameters that are programmed with values different from the standard default setting and displays them in the user parameter group C-U. Parameter setting can also be changed within this group.

Notes on operation

- When a value is reprogrammed that is the same as the standard value, there will be no display within C-U.
- The parameters programmed by the setup parameter are also displayed as changed parameters.

■ How to search and reprogram parameters

The operations of search and resetting of parameters are as follows.

Key operated	LED display	Operation
	0.0	Displays the operation frequency (operation stopped). (When standard monitor display selection F 7 : 0 is set to 0 [operation frequency])
(MON)	RU :	Press the MON key to display the first basic parameter RU : (automatic acceleration/deceleration).
(▲) (▼)	CrU	Press either the ▲ key or the ▼ key to select "CrU".
(ENT)	U---	Press the ENTER key to enable the user parameter automatic edit function.
(ENT) or (▲) (▼)	U--F (U--r) ↓ ACC	Searches for parameters that are different in value from the standard default setting and displays those parameters. Press the ENTER key or the ▲ key to change the parameter displayed. (Pressing the ▼ key moves the search in the reverse direction).
(ENT)	8.0	Press the ENTER key to display the set value.
(▲) (▼)	5.0	Press the ▲ key and ▼ key to change set value.
(ENT)	S.0 ↔ ACC	Press the ENTER key to save the changed value. The parameter name and the programmed value will flash on and off alternately.
(▲) (▼)	U--F (U--r)	Use the same steps as those given above to display parameters that you want to search for or change setting with the ▲ key and ▼ key.
(▲) (▼)	CrU	When CrU appears again, the search is ended.
(MON) (MON)	Parameter display ↓ F 0.0 ↓ 0.0	A search can be canceled by pressing the MON key. Press the MON key once while the search is underway to return to the display of parameter setting mode. After that you can press the MON key to return to the status monitor mode or the standard monitor mode (display of operation frequency).

If there is something that you do not understand during this operation, press the (MON) key several times and start over again from the step of RU : display.

4.1.4 How to program setup parameters

Setup parameters

When the standard parameter ω_{SP} is set to 3 (standard default setting), the setup parameter is displayed.



Setting the setup parameter enable to operate.

The setup parameter selects either 50Hz or 60Hz for the base motor frequency.

Set this in line with the specifications of the motor.

The setup parameters automatically program the base motor frequency and related parameters, but those parameters can be reprogrammed later.

The steps in setting are as follows

Key operated	LED display	Operation
	:50 :	Displays the base motor frequency.
 	:50 :	Press either the Δ key or the ∇ key to select 50Hz or 60Hz.
	in 10.	Press the ENTER key to set the base motor frequency and related parameters. in 10. will be displayed during the setting.
	0.0	Displays the operation frequency (while stopped)

Setting of the following parameters can be changed by the setup parameters.

They are displayed as changed parameters during ω_{RU} searches .

If select of 60Hz, ω_{L} and F_{10} are not displayed as changed parameters.

Setting value		50	60
Title	Function	Setting value	
ω_{L}	Upper limit frequency	50Hz	60Hz
ω_{1}	Base frequency 1	50Hz	60Hz (Standard)
F_{10}	Base frequency 2	50Hz	60Hz (Standard)
F_{204}	Frequency at VIA input point 2	50Hz	60Hz
F_{213}	Frequency at VIB input point 2	50Hz	60Hz

4.1.5 Parameters that cannot be changed while running

For reasons of safety, the following parameters have been set up so that they cannot be reprogrammed while the inverter is running.

Basic parameters

ⓂⓁ : (Automatic acceleration/deceleration)

ⓂⓁⓅ (Automatic torque boost)

ⓂⓁⓆ (Automatic environment setting)

ⓂⓁⓇ (Automatic function setting)

ⓎⓁⓁ (Command mode selection)

ⓎⓁⓂ (Frequency setting mode selection)

ⓎⓁⓃ (Maximum frequency)

ⓎⓁⓄ (Default setting)

ⓎⓁⓅ (V/F control mode selection)

ⓎⓁⓆ (Electronic thermal protection characteristics selection)

Extended parameters

ⓎⓁⓇ Supply voltage correction

ⓎⓁⓈ Auto-tuning

ⓎⓁⓉ Rated capacity ratio of motor to inverter

} Set **ⓎⓁⓁ**, and **ⓎⓁⓂ** and **ⓎⓁⓃ** can be changed while the inverter is running.

4

4.1.6 Returning all parameters to standard default setting

Setting the standard default setting parameter **ⓎⓁⓄ** to 3, all parameters can be returned to the those factory default settings. (Except for **ⓎⓁⓃ**)

When **ⓎⓁⓄ** is set to **Ⓝ**, the set up parameter is displayed. Setting the setup parameter enable to operate, See 4.1.4.

Note: For more details on the standard default setting parameter **ⓎⓁⓄ**, see 5.7.

Notes on operation

- We recommend that before this operation you write down on paper the values of those parameters, because when setting **ⓎⓁⓄ** to 3, all parameters with changed values will be returned to standard factory default setting.

■ Steps for returning all parameters to standard default setting

Key operated	LED display	Operation
	:60 :	Displays the operation frequency (perform during operation stopped).
(MON)	RU :	Press the MON key to display the first basic parameter RU : (automatic acceleration/deceleration).
(▲) (▼)	εYP	Press the Δ key or the ∇ key to change to εYP .
(ENT)	3.0	Pressing the ENTER key displays the programmed parameters. (εYP will always display zero "0" on the right, the previous setting on the left.)
(▲) (▼)	3.3	Press the Δ key or the ∇ key to change the set value. To return to standard factory default setting, change to "3".
(ENT)	in it.	Pressing the ENTER key displays "in it." while returning all parameters to factory default setting.
	:60 :	The monitor returns to the display of setup parameters. Set the setup parameters. See. 4.1.4.

If there is something that you do not understand during this operation, press the MON key several times and start over again from the step of RU : display.

5. Basic parameters

Before you operate the inverter, the parameters that you must first program are the basic parameters.

5.1 Setting acceleration/deceleration time

\overline{RUI} : Automatic acceleration/deceleration

\overline{ACC} : Acceleration time 1

\overline{DEC} : Deceleration time 1

• Function

- 1) For acceleration time \overline{ACC} program the time that it takes for the inverter output frequency to go from 0Hz to maximum frequency \overline{FH} .
- 2) For deceleration time \overline{DEC} program the time that it takes for the inverter output frequency to go from maximum frequency \overline{FH} to 0Hz.

5.1.1 Automatic acceleration/deceleration

This automatically adjusts acceleration and deceleration time in line with load size.

$\overline{RUI} = 1$

- * Automatically adjusts acceleration and deceleration time within the inverter rated current in a range that goes from 1/8 to infinity of programmed \overline{ACC} and \overline{DEC} time. It goes to the optimum value taking a marginal allowance into consideration.

$\overline{RUI} = 2$

- * Automatically adjusts to the shortest time within 120% of the inverter rated current. It is a value that is obtained attaching importance to acceleration/deceleration time.

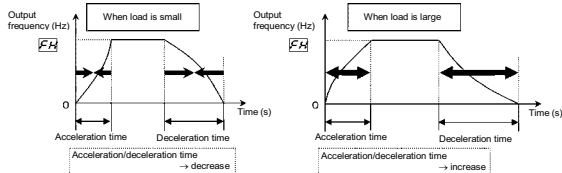

Set **\overline{RUI}** (automatic acceleration/deceleration) to **1** or **2**.

[Parameter setting]

Title	Function	Adjustment range	Default setting
RU :	Automatic acceleration/deceleration	0: Disabled (manual) 1: Optimum rate 2: Minimum rate	0

- ☆ When automatically setting acceleration/deceleration time, always change the acceleration/deceleration time so that it conforms with the load. For inverters that requires a fixed acceleration/deceleration time, use the manual settings (**ACC DEC**).
- ☆ Setting acceleration/deceleration time (**ACC DEC**) in conformance with mean load allows optimum setting that conforms to further changes in load.
- ☆ Use this parameter after actually connecting the motor.
- ☆ Acceleration may not be complete if the load is such that the inverter is operated in the rated current vicinity. If acceleration is incomplete, set acceleration/deceleration time manually (**RU := 0**).

Methods of setting automatic acceleration/deceleration

Key operated	LED display	Operation
	0.0	Displays the operation frequency. (When standard monitor display selection F 1 is set to 0 [operation frequency]).
(MON)	RU :	Press the MON key to display the first basic parameter RU : (automatic acceleration/deceleration).
(ENT)	0	Press the ENTER key to display the parameter setting.
(▲)	:	Press the Δ key to change the parameter to 1 or 2 .
(ENT)	1 RU :	Press the ENTER key to save the changed parameter. RU : and the parameter are displayed alternately.

5.1.2 Manually setting acceleration/deceleration time

Set acceleration time from 0Hz operation frequency to maximum frequency **F H** and deceleration time as the time when operation frequency goes from maximum frequency **F H** to 0Hz.

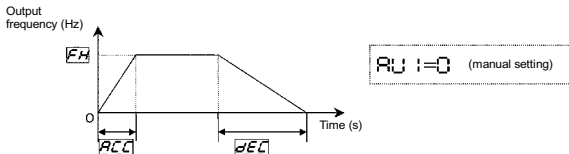

[Parameter setting]

Title	Function	Adjustment range	Default setting
ACC	Acceleration time 1	0.1-3600 seconds	10.0
DEC	Deceleration time 1	0.1-3600 seconds	10.0

- ☆ If the programmed value is shorter than the optimum acceleration/deceleration time determined by load conditions, overcurrent stall or overvoltage stall function may make the acceleration/deceleration time longer than the programmed time. If an even shorter acceleration/deceleration time is programmed, there may be an overcurrent trip or overvoltage trip for inverter protection. (for further details, see 13.1).

5.2 Increasing starting torque

RU2 : Automatic torque boost

- Function

Simultaneously switches inverter output (V/F) control and programs motor constants automatically (On-line automatic-tuning function) to improve torque generated by the motor. This parameter integrates the setting of special V/F control selection such as vector control.

Title	Function	Adjustment range	Default setting
RU2	Automatic torque boost	0: Disabled 1: Sensorless vector control + auto-tuning	0

Note: Parameter displays on the right always return to 0 after setting. The previous setting is displayed on the left.
Ex.

0 0

- When using vector control (increasing starting torque and high-precision operations)

Set the automatic control **RU2** to 1 (sensorless vector control + auto-tuning)

Setting automatic control **RU2** to 1 (sensorless vector control + auto-tuning) provides high starting torque bringing out the maximum in motor characteristics from the low-speed range. This suppresses changes in motor speed caused by fluctuations in load to provide high precision operation. This is an optimum feature for elevators and other load transporting machinery.

[Methods of setting]

Key operated	LED display	Operation
	0. 0	Displays the operation frequency. (Perform during operation stopped.) (When standard monitor display selection F7 : 03 is set to 03 (operation frequency))
(MON)	RU 1	Press the MON key to display the first basic parameter RU 1 (automatic acceleration/deceleration).
(▲)	RU 2	Press the ▲ key to change the parameter to RU 2 (automatic torque boost).
(ENT)	0 0	Press the ENTER key to display the parameter setting.

Key operated	LED display	Operation
		Press the Δ key to change the parameter to 1 (sensorless vector control + auto-tuning).
		Press the ENTER key to save the changed parameter. $R02$ and the parameter are alternately displayed.

Note 1: Setting V/F control selection $P\epsilon$ to 3 (sensorless vector control) provides the same characteristics as when $F400$ (auto-tuning) is set to 2. \Rightarrow See 5.12

Note 2: Setting $R02$ to 1 automatically programs $P\epsilon$ to 3.

If vector control cannot be programmed....

First read the precautions about vector control in 5.12, 6.

1) If the desired torque cannot be obtained, see 6.13, 3.

2) If auto-tuning error "E E n" appears, see 6.13, 3.

■ $R02$ (automatic torque boost) and $P\epsilon$ (V/F control mode selection)

Automatic torque boost is the parameter for setting V/F control mode selection ($P\epsilon$: 3) and auto-tuning ($F400$) together. That is why all parameters related to $R02$ change automatically when $R02$ is changed.

$R02$	Automatically programmed parameters	
	$P\epsilon$	$F400$
Displays after resetting	- Check the programmed value of $P\epsilon$. - (If $R02$ is not changed, it becomes 0 (V/F constant))	-
Sensorless vector control + auto-tuning	3 Sensorless vector control	Executed (after execution)

2) Increasing torque manually (V/F constant control)

The VF-S9 inverter is set to this control mode by factory default.

This is the setting of constant torque characteristics that are suited for such things as conveyors. It can also be used to manually increase starting torque.

If V/F constant control is programmed after changing $R02$,

Set V/F control mode selection $P\epsilon$ to 0 (V/F constant)

\Rightarrow See 5.12.

Note 1: If you want to increase torque further, raise the setting value of manual torque boost ωb .

How to set manual torque boost parameter ωb

\Rightarrow See 5.13.

Note 2: V/F control selection $P\epsilon$ to 1 (variable torque) is an effective setting for the load on such equipment as fans and pumps.

\Rightarrow See 5.12.

5.3 Setting environmental protection

RV3 : Automatic environment setting

- Function

This automatically programs all parameters related to inverter environmental protection (auto-restart or ride-through control after momentary power failure, supply voltage correction, acceleration/deceleration S-pattern).

This parameter is especially suitable for wind force or hydraulic machinery such as fans and pumps

Note: Do not use this parameter for equipment such as transporters, since it is dangerous to operate automatically such equipment after temporary stops.

[Parameter setting]

Title	Function	Adjustment range	Default setting
RV3	Automatic environment setting	0: Disabled 1: Automatic setting	0

Values of automatically programmed parameters

Title	Function	RV3 : !	Default setting
F301	Auto-restart control selection	1: At auto-restart after momentary stop	0: Disabled
F302	Regenerative power ride-through control	1: Enabled	0: Disabled
F307	Supply voltage correction	1: Supply voltage corrected, output voltage limited	1: Supply voltage corrected, output voltage limited
F502	Acceleration/deceleration 1 pattern	1: S-pattern 1	0: Linear

5.4 Setting parameters by operating method

RV4 : Automatic function setting

- Function

Automatically programs all parameters (parameters described below) related to the functions by selecting the inverter's operating method.

The major functions can be programmed simply.

[Parameter setting]

Title	Function	Adjustment range	Default setting
RV4	Automatic function setting	0: Disabled 1: Coast stop 2: 3-wire operation 3: External input UP/DOWN setting 4: 4-20mA current input operation	0

Automatically programmed functions and parameter set values

	Default setting	1: Coast stop	2: 3-wire operation	3: External input UP/DOWN setting	4: 4-20mA current input operation
F00d	2: Potentiometer	2: Potentiometer	2: Potentiometer	1: Operation panel	0: Terminal board
C00d	1: Operation panel	0: Terminal board	0: Terminal board	0: Terminal board	0: Terminal board
F111 (F)	2: F	2: F	2: F	2: F	2: F
F112 (R)	3: R	3: R	3: R	3: R	3: R
F113 (RST)	10: RST	10: RST	10: RST	10: RST	10: RST
F114 (S1)	6: SS1	6: SS1	6: SS1	41: UP	6: SS1
F115 (S2)	7: SS2	7: SS2	7: SS2	42: DOWN	38: FCHG
F116 (S3)	8: SS3	1: ST	49: HD	43: CLR	1: ST
F103 (ST)	1: Always active	0: Activated by turning ST on active	1: Always active	1: Always active	0: Activated by turning ST on active
F200	0: VIA/II	0: VIA/II	0: VIA/II	3: UP/DOWN	0: VIA/II
F201	-	-	-	-	20%
F202	-	-	-	-	-
F203	-	-	-	-	-
F204	-	-	-	-	-
F210	-	-	-	1	-
F211	-	-	-	0.1Hz	-
F212	-	-	-	1	-
F213	-	-	-	0.1Hz	-

Disabled (P14 : 0)

Input terminals and parameters are standards programmed at the factory.

Coast stop (P14 : 1)

Setting for coast stopping. ST (standby signal) is assigned to the S3 terminal and the operation is controlled by the on and off of the S3 terminal.

3-wire operation (P14 : 2)

Can be operated by a momentary push-button. HD (operation holding) is assigned to the terminal S3. A self-holding of operations is made in the inverter by connecting the stop switch (b-contact) to the S3 terminal and connecting the running switch (a-contact) to the F terminal or the R terminal.

External input UP/DOWN setting (P14 : 3)

Allows setting of frequency with the input from an external contact. Can be applied to changes of frequencies from several locations. UP (frequency up signal input from external contact) is assigned to the S1 ter-

minal, and DOWN (frequency down signal input from external contact) are assigned to the S2 and CLR (frequency up/down clear signal input from external contact) are assigned to the S3 terminals respectively.

Frequencies can be changed by input to the S1 and S2 terminals.

4-20mA current input operation
(P.14 : 4)

Used for setting frequencies with 4-20mA current input. Priority is given to current input and FCHG (frequency command forced switching) and ST (standby terminal) are assigned to the S2 and S3 terminals respectively. Remote/manual control (by different frequency commands) can be switched by input to the S2 terminal. The S3 terminal can also be used for coast stop.

5.5 Selection of operation mode

CNOd : Command mode selection

FNOd : Frequency setting mode selection

- Function

These parameters are to program which command to the inverter (from operation panel or terminal board) will be given priority in running/stopping the operation and in frequency setting (internal potentiometer, operation panel or terminal board).

<Command mode selection>

Title	Function	Adjustment range	Default setting
CNOd	Command mode selection	0: Terminal board 1: Operation panel	1

[Setting value]

: Terminal board operation ON and OFF of an external signal Runs and stops operation.











: Operation panel operation Press the **(RUN)** and **(STOP)** keys on the operation panel to Run and stop a run. Performs the Run and stop of a run when the optional expansion panel is used.

- * There are two types of function: the function that conforms to commands selected by **CNOd**, and the function that conforms only to commands from the terminal board. See the table of input terminal function selection in Chapter 11.
- * When priority is given to commands from a linked computer or terminal board, they have priority over the setting of **CNOd**.



<Frequency setting mode selection>

Title	Function	Adjustment range	Default setting
FNOd	Frequency setting mode selection	0: Terminal board 1: Operation panel 2: Internal potentiometer	2

[Setting values]

-  : Terminal board Frequency setting commands are entered by external signals. (VIA/VIB terminals: 0-10Vdc or II terminal: 4-20mAdc)
-  : Operation panel Press the  key or the  key on either the operation panel or the expansion panel (optional) to set frequency.
-  : Internal potentiometer The internal potentiometer to the inverter is used for setting frequencies. Turning the notches clockwise raises the frequency.
- ☆ No matter what value the command mode selection  and the frequency setting mode selection  are set to the control input terminal functions described below are always in operative state.
- Reset terminal (default setting: RST, valid only for tripping)
 - Standby terminal (when programmed by programmable input terminal functions).
 - External input trip stop terminal (when programmed by programmable input terminal functions)
- ☆ To make changes in the command mode selection  and the frequency setting mode selection , first stop the inverter temporarily. (Can be changed while in operation when  is set to .)

■ Preset-speed operation

- : Set to  (Terminal board).
- : Valid in all setting values.

5.6 Meter setting and adjustment

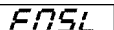
 : Meter selection

 : Meter adjustment

• Function

The signal output from the FM terminal is an analog voltage signal.

For the meter, use either a full-scale 0-1mAdc ammeter or full-scale 0-7.5Vdc (or 10Vdc) voltmeter.

Note that the jumper pin JP302 can be set to switch to 0-20mA (4-20mA) current output. Adjust to 4-20mA with  parameter (meter bias).

■ Adjustment scale with meter adjustment $F\Omega$ parameter

Connect meters as shown below.

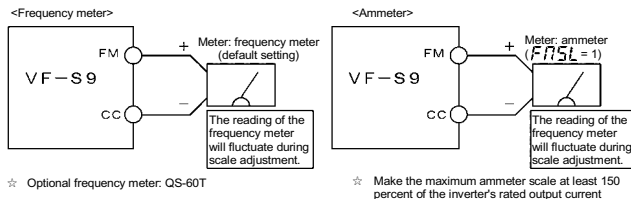

[Connected meter selection parameters]

Title	Function	Adjustment range	Default setting
$F\Omega SL$	Meter selection	0: Output frequency 1: Output current 2: Set frequency 3: For adjustment (current fixed at 100%) 4: Inverter load factor 5: Output power	0
$F\Omega$	Meter adjustment	-	-

■ Resolution

All FM terminals have a maximum of 1/256

■ Example of 4-20mA programmed output (for details, see 6.15.10)

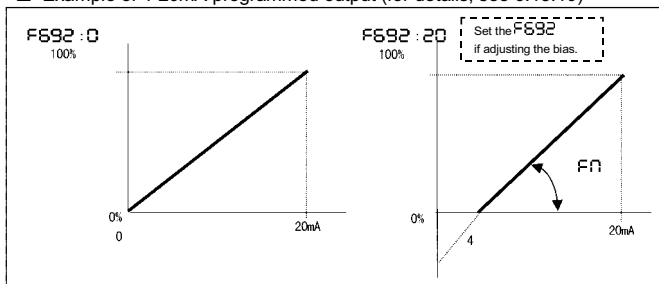

[Example of how to adjustment the FM terminal frequency meter]

* Use the meter's adjustment screw to pre-adjust zero-point.

Key operated	LED display	Operation
-	60.0	Displays the operation frequency. (When standard monitor display selection $F7 \downarrow \uparrow$ is set to 0 [operation frequency])
(MON)	RU1	Press the MON key to display the first basic parameter $R \downarrow \uparrow$ (automatic acceleration/deceleration).
(Δ) (∇)	F \downarrow	Press either the Δ key or the ∇ key to select "F \downarrow ".
(ENT)	60.0	Press the ENTER key to display the operation frequency.
(Δ) (∇)	60.0	Press the Δ key or the ∇ key to adjust the meter. The meter reading will change at this time but be careful because there will be no change in the inverter's digital LED (monitor) indication.  [Hint] It's easier to make the adjustment if you push and hold for several seconds.
(ENT)	600 \leftrightarrow F \downarrow	The adjustment is complete. F \downarrow and the frequency are displayed alternately.
(MON) (MON)	60.0	The display returns to its original indications (displaying the operation frequency). (When standard monitor display selection $F7 \downarrow \uparrow$ is set to 0 [operation frequency]).

■ Adjusting the meter in inverter stop state

If, when adjusting the meter for output current, there are large fluctuations in data during adjustment, making adjustment difficult, the meter can be adjusted in inverter stop state.

When setting $F \downarrow \uparrow$ to 3 for adjustment (100% fixed current), a signal of absolute values will be output (inverter's rated current = 100%). In this state, adjust the meter with the F \downarrow (Meter adjustment) parameter. After meter adjustment is ended, set $F \downarrow \uparrow$ to 1 (output current).

5.7 Standard default setting

64P : Default setting

- Function

Allows setting of all parameters to the standard default setting, etc. at one time.

Title	Function	Adjustment range	Default setting
64P	Standard setting mode selection	0 ~ 2 : - (invalid) 3: Default setting 4: Trip clear 5: Cumulative operation time clear 6: Initialize inverter type information	0

- ★ This function will be displayed as \square during reading on the right. This previous setting is displayed. Ex.

\square 30

- ★ \square cannot be set during the inverter operating. Always stop the inverter first and then program.

Setting values

Default setting ($\square = 3$)

- Setting \square to 3 will return all parameters to the standard values that were programmed at the factory.
- ☆ When 3 is programmed, \square will be displayed for a short time after setting and will then be erased and displayed the original indication (\square setup parameter). Trip history data will be cleared at this time. For setting setup parameters, see 4.1.4.

Trip clear ($\square = 4$)

- Setting \square to 4 initializes the past four sets of recorded error history data.
- ☆ (The parameter does not change.)

Cumulative operation time clear ($\square = 5$)

- Setting \square to 5 allows the initial resetting of the cumulative operation time monitor (0 [zero] time).

Initialize inverter type information ($\square = 6$)

- Setting \square to 6 clears the trips when an \square format error occurs. But if the \square displayed, call us.

5.8 Selecting forward and reverse runs (operation panel only)

\square : Forward/reverse run selection

- Function
Program the direction of rotation when the running and stopping are made using the RUN key and STOP key on the operation panel. Valid when \square (command mode) is set to 1 (operation panel).

Parameter setting

Title	Function	Adjustment range	Default setting
\square	Forward/reverse run selection	0: Forward run 1: Reverse run	0

- ★ Check the direction of rotation on the status monitor.
 \square : Forward run
 \square : Reverse run \Rightarrow For monitoring, see 8.1.
- ★ When the F and R terminals are used for switching between forward and reverse rotation from the terminal board, the \square forward/reverse run selection is rendered invalid.
Short across the F-CC terminals: forward rotation

Short across the R-CC terminals: reverse rotation

* Reverse rotation is valid if short across the F-CC terminals and R-CC terminals at the same time.

★ This function is valid only when $\overline{C10}$ is set to 1 (operation panel).

5.9 Maximum frequency

FH : Maximum frequency

• Function

- 1) Programs the range of frequencies output by the inverter (maximum output values).
- 2) This frequency is used as the reference for acceleration/deceleration time.

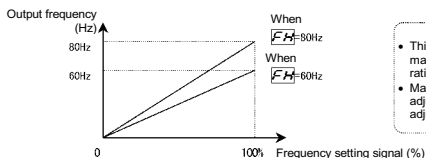

- This function determines the maximum value in line with the ratings of the motor and load.
- Maximum frequency cannot be adjusted during operation. To adjust, first stop the inverter.

★ If **FH** is increased, adjust the upper limit frequency \overline{UL} as necessary.

■ Parameter setting

Title	Function	Adjustment range	Default setting
FH	Maximum frequency	30.0 ~ 400 (Hz)	80.0

5.10 Upper limit and lower limit frequencies

UL : Upper limit frequency

LL : Lower limit frequency

• Function

Programs the lower limit frequency that determines the lower limit of the output frequency and the upper limit frequency that determines the upper limit of that frequency.

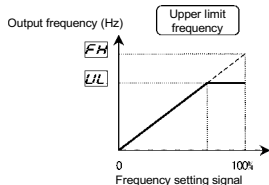

* Frequencies that go higher than \overline{UL} will not be output.

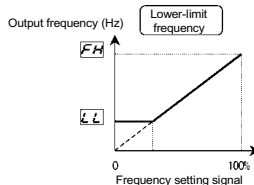

* The output frequency cannot be set at less than \overline{LL} .

■ Parameter setting

Title	Function	Adjustment range	Setting after setup
\overline{UL}	Upper limit frequency	0.5 ~ \overline{FH} (Hz)	50 or 60 *
\overline{LL}	Lower limit frequency	0.0 ~ \overline{LL} (Hz)	0.0

* Setting value depending on the end of Type – form.
AN, WN : 60Hz, WP : 50Hz

5.11 Base frequency

\overline{FL} : Base frequency 1

- Function
Sets the base frequency in conformance with load specifications or the motor's rated frequency.

Note: This is an important parameter that determines the constant torque control area.

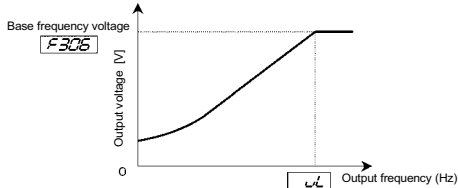

Title	Function	Adjustment range	Setting after setup
\overline{FL}	Base frequency 1	25 ~ 400 (Hz)	50 or 60 *

* Setting value depending on the end of Type – form.
AN, WN : 60Hz, WP : 50Hz

5.12 Selecting control mode

P_ε : V/F control mode selection

- Function

With VF-S9, the V/F controls shown below can be selected



- V/F constant
- Variable torque
- Automatic torque boost
- Sensorless vector control ^(*)
- Automatic energy-saving

(*) "Automatic torque boost R_U !" parameter can automatically set this parameter and auto-tuning at a time.

Parameter setting

Title	Function	Adjustment range	Default setting
P _ε	V/F control mode selection	0: V/F constant 1: Variable torque 2: Automatic torque boost 3: Sensorless vector control 4: Automatic energy-saving	0

[Setting V/F control mode selection to 3 (sensorless vector control)]

Key operated	LED display	Operation
	0.0	Displays the operation frequency. (When standard monitor display selection F ₇ :  is set to 0 [operation frequency])
(MON)	R _U !	Press the MON key to display the first basic parameter R _U ! (automatic acceleration/deceleration).
(▲)	P _ε	Press the ▲ key to change the parameter to P _ε (V/F control mode selection).
(ENT)	0	Press the ENTER key to display the parameter setting. (Standard default setting:  [V/F constant])
(▲)	3	Press the ▲ key to change the parameter to 3 (sensorless vector control).
(ENT)	3 ↔ P _ε	Press the ENTER key to save the changed parameter. P _ε and the parameter set value are displayed alternately.

1) Constant torque characteristics (general method of use)

Setting of V/F control mode selection P_{12} to \square (V/F constant)

This is applied to loads with equipment like conveyors and cranes that require the same torque at low speeds as at rated speeds.

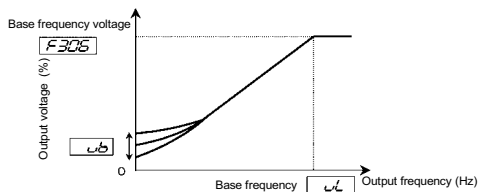

To increase the torque further, increase the setting value of the manual torque boost ω_b .

⇒ For more details, see 5.13.

2) Setting for fans and pumps

Setting of V/F control selection P_{12} to \square (variable torque)

This is appropriate for load characteristics of such things as fans, pumps and blowers in which the torque in relation to load rotation speed is proportional to its square.

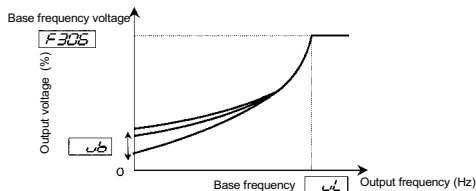

3) Increasing starting torque

Setting V/F control selection P_{12} to 2 (automatic torque boost)

Detects load current in all speed ranges and automatically adjusts voltage output (torque boost) from inverter. This gives steady torque for stable runs.

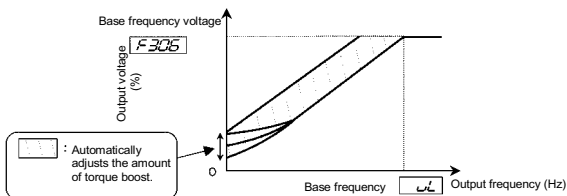

Note: This control system can oscillate and destabilize runs depending on the load. If that should happen, set V/F control mode selection P_{12} to 3 (V/F constant) and increase torque manually.

5

★ Motor constant must be set

If the motor you are using is a 4P Toshiba standard motor and if it has the same capacity as the inverter, there is basically no need to set the motor constant.

There are two procedures for setting the motor constant.

- 1) The motor constant can be set automatically (auto-tuning). Program the extended parameter F_{400} to 2 . \Rightarrow For details, see selection 2 in 6.13.
- 2) Each motor constant can be set individually. \Rightarrow For details, see selection 3 in 6.13.

4) Sensorless vector control--increasing starting torque and achieving high-precision operation.

Setting of V/F control mode selection P_{12} to 3 (Sensorless vector control)

Using sensorless vector control with a Toshiba standard motor will provide the highest torque at the lowest speed ranges. The effects obtained through the use of sensorless vector control are described below.

- (1) Provides large starting torque.
- (2) Effective when stable operation is required to move smoothly up from the lowest speeds.
- (3) Effective in elimination of load fluctuations caused by motor slippage.

★ Motor constant must be set

If the motor you are using is a 4P Toshiba standard motor and if it has the same capacity as the inverter, there is basically no need to set the motor constant.

There are three procedures for setting motor constants.

- 1) The sensorless vector control and motor constants (auto-tuning) can be set at a time. Set the basic parameter P_{12} to 3 . \Rightarrow For details, see 1 in 5.2.
- 2) The motor constant can be automatically set (auto-tuning). Set the extended parameter F_{400} to 2 . \Rightarrow For details, see selection 2 in 6.13.

- 3) Each motor constant can be set individually. ⇒ For details, see selection 3 in 6.13.

5) Energy-saving

Setting V/F control mode selection P_{12} to 4 (automatic energy-saving)

Energy can be saved in all speed areas by detecting load current and flowing the optimum current that fits the load.

★ Motor constant must be set

The motor you are using is a 4P Toshiba standard motor and if it has the same capacity as the inverter, there is basically no need to set the motor constant.

There are two procedures for setting the motor constant.

- 1) The motor constant can be set automatically (auto-tuning). Set the extended parameter F_{400} to 2 .
⇒ For details, see selection 2 in 6.13.
- 2) Each motor constant can be set individually.
⇒ For details, see selection 3 in 6.13.

6) Precautions on vector control

- 1) The sensorless vector control exerts its characteristics effectively in frequency areas below the base frequency (ω_L). The same characteristics will not be obtained in areas above the base frequency.
- 2) Set the base frequency to anywhere from 40 to 120Hz during sensorless vector control ($P_{12} = 3$).
- 3) Use a general purpose squirrel-cage motor with a capacity that is the same as the inverter's rated capacity or one rank below.
The minimum applicable motor capacity is 0.1kW.
- 4) Use a motor that has 2~8 P.
- 5) Always operate the motor in single operation (one inverter to one motor). Sensorless vector control cannot be used when one inverter is operated with more than one motor.
- 6) The maximum length of wires between the inverter and motor is 30 meters. If the wires are longer than 30 meters, set standard auto-tuning with the wires connected to improve low-speed torque during sensorless vector control.
However the effects of voltage drop cause motor-generated torque in the vicinity of rated frequency to be somewhat lower.
- 7) Connecting a reactor or surge voltage suppression filter between the inverter and the motor may reduce motor-generated torque. Setting auto-tuning may also cause a trip (E_{tr}) rendering sensorless vector control unusable.

5.13 Manual torque boost – increasing torque at low speeds

ub : Torque boost 1

- Function
If torque is inadequate at low speeds, increase torque by raising the torque boost rate with this parameter.

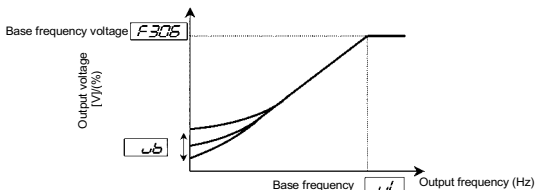

(Parameters)

Title	Function	Adjustment range	Default setting
ub	Torque boost 1	0 ~ 30 (%)	According to model (See section 11)

★ Valid for the standard default setting, $P_{\tau} = 0$ (V/F constant) and 1 (variable torque).

Note 1: The optimum value is programmed for each inverter capacity. Be careful not to increase the torque boost rate too much because it could cause an overcurrent trip at startup. If you are going to change the set values, keep them within $\pm 2\%$ of the standard default values.

5.14 Setting the electronic thermal

OLN : Electronic thermal protection characteristic selection

tHr : Motor electronic thermal protection level 1

F800

- Function
Selects the electronic thermal protection characteristics that fit with the ratings and characteristics of the motor. This is the same parameter as the extended parameter F800. The set values will be the same no matter which one is changed.

Parameter setting

Title	Function	Adjustment range			Default setting	
		Setting value		Overload protection		Overload stall
OLN	Electronic thermal protection characteristics selection	0	Standard motor	○	×	0
		1		○	○	
		2		×	×	
		3		×	○	
		4	VF motor (special motor)	○	×	
		5		○	○	
		6		×	×	
		7		×	○	
Err (F600)	Motor electronic thermal protection level 1	10 ~ 100 (%)			100	

○ : valid, × : invalid

- 1) Setting the electronic thermal protection characteristics selection **OLN** and motor electronic thermal protection level 1 **Err**

The electronic thermal protection characteristics selection **OLN** is used to enable or disable the motor overload trip function (**OL2**) and the overload stall function.

While the inverter overload trip (**OL1**) will be in constant detect operation, the motor overload trip (**OL2**) can be selected using the parameter **OLN**.

Explanation of terms

Overload stall: When the inverter detects an overload, this function automatically lowers the output frequency before the motor overload trip **OL2** is activated. The soft stall function allows the drive to run with balanced load current frequency without a trip. This is an optimum function for equipment such as fans, pumps and blowers with variable torque characteristics that the load current decreases as the operating speed decreases.

Note: Do not use the overload stall function with loads having constant torque characteristics (such as conveyor belts in which load current is fixed with no relation to speed).

[Using standard motors (other than motors intended for use with inverters)]

When a motor is used in the lower frequency range than the rated frequency, that will decrease the cooling effects for the motor. This speeds up the start of overload detection operations when a standard motor is used in order to prevent overheating.

■ Setting of electronic thermal protection characteristics selection OLn

Setting value	Overload protection	Overload stall
0	○	×
1	○	○
2	×	×
3	×	○

○ : valid, × : invalid

■ Setting of motor electronic thermal protection level 1 EHR

If the capacity of the motor is smaller than the capacity of the inverter, or the rated current of the motor is smaller than the rated current of the inverter, adjust the electronic thermal protection level EHR so that it fits the motor's rated current.

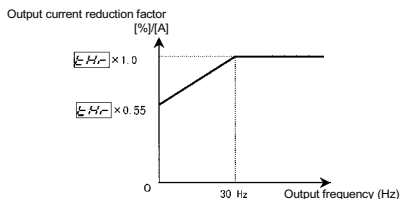

Note: The motor overload protection start level is fixed at 30Hz.

[Example of setting: When the VFS9-2007PM is running with a 0.4kW motor having 2A rated current]

Key operated	LED display	Operation
	0.0	Displays the operation frequency (perform during stop). (When standard monitor display selection F7 is set to 0 (operation frequency))
(MON)	RU1	Press the MON key to display the first basic parameter RU1 (automatic acceleration/deceleration).
(▲) (▼)	EHR	Press either the ▲ key or the ▼ key to change the parameter to EHR.
(ENT)	100	Press the ENTER key to display the parameter setting. (Standard default setting: 100%)
(▲) (▼)	417	Press the ▲ key to change the parameter to 417 (= motor rated current/inverter output rated current x 100 = 2.0/4.8 x 100). (When PWM carrier frequency E300 is set to 12kHz.)
(ENT)	417↔EHR	Press the ENTER key to save the changed parameter. EHR and the parameter set value are displayed alternately.

[Using a VF motor (motor for use with inverter)]

■ **Setting selection of electronic thermal protection characteristics**

Setting value	Overload protection	Overload stall
4	○	×
5	○	○
6	×	×
7	×	○

○ : valid, × : invalid

A VF motor (a motor for use with an inverter) can be used in lower frequency ranges than the general-purpose motor, but if that frequency is extremely low, the effects of cooling on the motor will deteriorate.

■ **Setting the motor electronic thermal protection level 1 $\frac{I_M}{I_r}$**

If the capacity of the motor being used is smaller than the capacity of the inverter, or the rated current of the motor is smaller than the rated current of the inverter, adjust the electronic thermal protection level 1 $\frac{I_M}{I_r}$ so that it fits the motor's rated current.

* If the indications are in percentages (%), then 100% equals the inverter's rated output current (A).

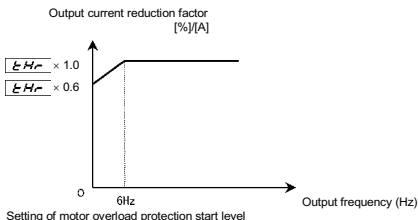

2) Inverter over load characteristics

Set to protect the inverter unit. Cannot be changed or turned off by parameter setting.

If the inverter overload trip function (OL!) is activated frequently, this can be improved by adjusting the stall operation level F50 downward or increasing the acceleration time R2C or deceleration time DEC.

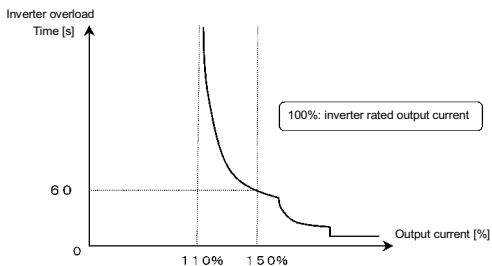

* To protect the inverter, overload trip may activate in a short period of time when output current reaches 150% or higher.

Inverter overload protection characteristics

5.15 Preset-speed operation (speeds in 15 steps)

Sr1 ~ Sr7 : Preset-speed operation frequencies 1~7

F280 ~ F286 : Same as Sr1 ~ Sr7

F287 ~ F294 : Preset-speed operation frequencies 8~15

- Function

A maximum of 15 speed steps can be selected just by switching an external contact signal. Multi-speed frequencies can be programmed anywhere from the lower limit frequency LL to the upper limit frequency UL.

[Setting method]

1) Run/stop

The starting and stopping control is done from the terminal board.

Title	Function	Adjustment range	Setting
Fn0	Command mode selection	0: Terminal board 1: Operation panel	1

Note: If speed commands (analog signal or digital input) are switched in line with preset-speed operations, select the terminal board using the frequency setting mode selection Fn0. ⇒ See 3) or 5.5

2) Preset-speed frequency setting

Set the speed (frequency) of the number of steps necessary.

Setting from speed 1 to speed 7

Title	Function	Adjustment range	Default setting
Sr1~Sr7 or F280~F286	Preset-speed operation frequencies 1~7	LL ~ UL (Hz)	0.0

Setting from speed 8 to speed 15

Title	Function	Adjustment range	Default setting
F287~F294	Preset-speed frequencies 8~15	LL ~ UL (Hz)	0.0

Examples of preset-speed contact input signals (JP301 set to sink logic)

O: ON -; OFF (Speed commands other than preset-speed commands are valid when all are OFF)

Terminal	Preset-speed														
	1	2	3	4	5	6	7	8	9	10	11	12	13	14	15
S1-CC	○	-	○	-	○	-	○	-	○	-	○	-	○	-	○
S2-CC	-	○	○	-	-	○	○	-	-	○	○	-	-	○	○
S3-CC	-	-	-	○	○	○	○	-	-	-	-	○	○	○	○
RST-CC	-	-	-	-	-	-	-	○	○	○	○	○	○	○	○

☆ Terminal functions are as follows.

Terminal S1..... Input terminal function selection 4 (S1) F : !4=6 (SS1)

Terminal S2..... Input terminal function selection 5 (S2) F : !5=7 (SS2)

Terminal S3..... Input terminal function selection 6 (S3) F : !6=8 (SS3)

Terminal RST..... Input terminal function selection 3 (RST) F : !3=9 (SS4)

☆ SS4 is not allocated to standard default setting. Use the input terminal function selection to allocate SS4 an idle terminal. In the above example the RST terminal is used for SS4.

Example of a connection diagram (JP301 set to sink logic)

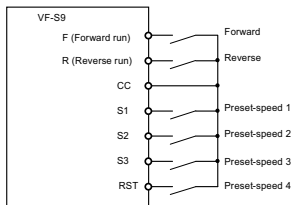

3) Using other speed commands with preset-speed command

Command mode selection \overline{CND}		0 : Terminal board			1 : Operation panel	
Frequency setting mode selection \overline{FND}		0 : Terminal board Analog signal	1 : Operation panel	2 : Potentiometer	0 : Terminal board Analog signal	1 : Operation panel 2 : Potentiometer
Preset - speed command	Entered	Preset - speed command Valid (Note)			Analog signal Valid	Operation panel Command Valid Potentiometer Valid
	Not entered	Analog signal Valid	Operation panel Command Valid	Potentiometer Valid	(The inverter doesn't accept Preset - speed command.)	

(Note) The preset-speed command is always given priority when other speed commands are input at the same time.

Below is an example of 7-step speed operation with standard default setting.

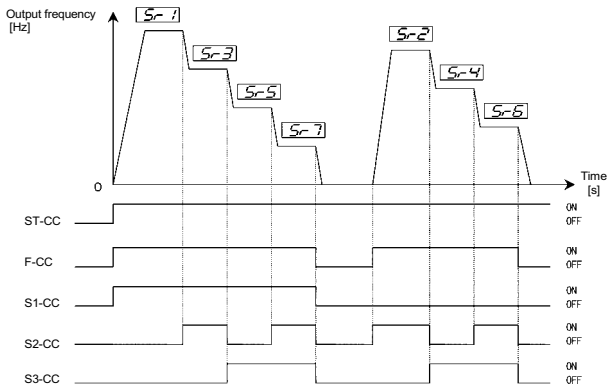

Example of 7-step speed operation

6. Extended parameters

Extended parameters are provided for sophisticated operation, fine adjustment and other special purposes. Modify parameter settings as required. See Section 11, Table of extended parameters.

6.1 Input/output parameters

6.1.1 Low-speed signal

F 100 : Low-speed signal output frequency

- Function

When the output frequency exceeds the setting of this parameter, an ON signal will be generated. This signal can be used as an electromagnetic brake excitation/release signal.

★ Relay output (250Vac-2A (cos ϕ = 1), 30Vdc-1A, 250Vac -1A (cos ϕ = 0.4) at RY-RC or FLA-FLC-FLB terminals (Default setting: RY-RC).

★ Open-collector output (24Vdc-50mA [maximum]) can also be set at OUT terminal.

[Parameter setting]

Title	Function	Adjustment range	Default setting
F 100	Low-speed signal output frequency	0.0 ~ F H (Hz)	0.0

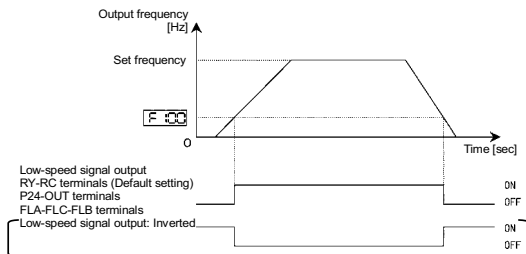

[Connection diagram for sink logic]

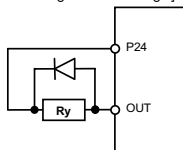

[Incase of relay]

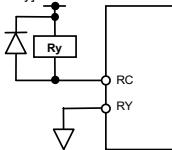

- Output terminal setting

Output of the low-speed signal (ON signal) between the RY and RC terminals is the factory default setting of the output terminal selection parameter. This setting must be changed to invert the polarity of the signal.

[Parameter setting]

Title	Function	Adjustment range	Setting
F : 30	Output terminal selection 1 (RC-RY)	0 ~ 29 (see section 11)	4 (ON signal) or 5 (OFF signal)

If the signal output from OUT terminal, set F : 31 to the value.

6

6.1.2 Output of designated frequency reach signal

F : 102 : Speed reach detection band

- Function

When the output frequency becomes equal to the designated frequency the setting of this F : 102 parameter, an ON or OFF signal is generated.

■ Parameter setting of designated frequency and detection band

Title	Function	Adjustment range	Default setting
F : 102	Speed reach detection band	0.0 ~ FH (Hz)	2.5

■ Parameter setting of output terminal selection

Title	Function	Adjustment range	Setting
F : 31	Output terminal selection 2 (OUT)	0 ~ 29 (See section 11)	6: RCH (Designated frequency - ON signal), or 7: RCH (Designated frequency - OFF signal)

Note: Select the F : 30 parameter to specify RY-RC terminal output, or the F : 32 parameter to specify FLA-FLC-FLB terminal output.

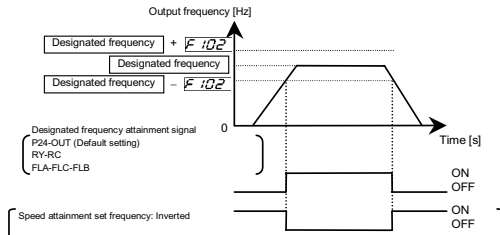

6.1.3 Output of set frequency speed reach signal

F101 : Speed reach setting frequency

F102 : Speed reach detection band

- Function

When the output frequency becomes equal to the setting of the **F101** parameter \pm the setting of the **F102** parameter, an ON or OFF signal is generated.

6

Parameter setting of set frequency and detection band

Title	Function	Adjustment range	Default setting
F101	Speed reach setting frequency	0.0 ~ F H (Hz)	0.0
F102	Speed reach detection band	0.0 ~ F H (Hz)	2.5

Parameter setting of output terminal selection

Title	Function	Adjustment range	Setting
F31	Output terminal selection 2 (OUT)	0 ~ 29 (See section 11)	6: RCH (Designated frequency - ON signal), or 7: RCH (Designated frequency - OFF signal)

Note: Select the **F30** parameter to specify RY-RC terminal output, or the **F32** parameter to specify FLA-FLC-FLB terminal output.

- 1) If the detection band value + the set frequency is less than the designated frequency

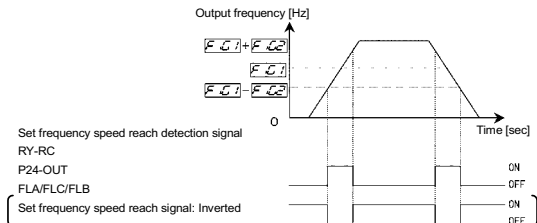

6.2 Input signal selection

6.2.1 Changing the standby signal function

F103: ST (standby) signal selection

- Function

The F103 parameter specifies standby function activation timing, depending on the particular status of the ST (standby) signal.

- Standby on only when ST is on (ST-CC on: Standby, ST-CC off: Gate off [Coast stop])
- Standby always on
- Synchronized with F/R (F/R-CC on: Forward/reverse run, F/R-CC off: Coast stop)
- Standby on only when ST is off (ST-CC off: Standby, ST-CC on: Gate off [Coast stop])

Parameter setting

Title	Function	Adjustment range	Default setting
F103	ST signal selection	0: Standby on when ST is on 1: Standby always on 2: Interlocked with F/R 3: Standby on when ST is off	1

1) Standby on when ST is on

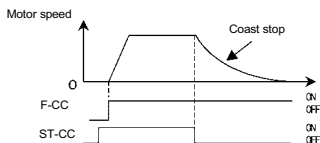

Use this setting if an ST (standby) terminal is required.

* The ST terminal is not assigned as standard default setting. Assign the ST function to an idle input terminal by the input terminal selection.

2) Standby always on (Default setting)

The inverter enters a standby status, irrespective of the ST signal status. Motor rotation stops according to the selected deceleration time at the set frequency.

3) Interlocked with F/R

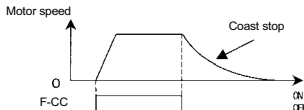

Turning the operation signal (F/R) off causes the motor to coast to a stop.

4) Standby on when ST is off

Inversion of item 1) above.

6.2.2 Setting the reset signal

F104: RST (reset) signal selection

- Function

The **F104** parameter specifies reset function activation timing, depending on the particular status of the RST (reset) signal.

- Standard setting (reset on when RST-CC on to off)
- Activated by turning RST off (reset on when RST-CC off to on)

- This parameter is available in the modifying input terminal functions (**F111** ~ **F115**) = 10 (RST).

- To reset the protective function on the parameter setting **F502** = 0, do any of the following.

- Turn off the power.
- Press the STOP key twice while the protection function is displayed.
- Turn on and off the error reset control input signal.

■ Parameter setting

Title	Function	Adjustment range	Default setting
F 104	RST signal selection	0: Standard setting (reset on when RST-CC on to off) 1: Activated by turning RST off (reset on when RST-CC off to on)	0

6.3 Terminal function selection

6.3.1 Keeping an input terminal function always active (ON)

F 110 : Always-active function selection

- Function
This parameter specifies an input terminal function that is always to be kept active (ON). (Only one function selectable)

■ Parameter setting

Title	Function	Adjustment range	Default setting
F 110	Always-active function selection	0 - 51 (See section 11)	0

6.3.2 Modifying input terminal functions

F 111 : Input terminal selection 1 (F)

F 112 : Input terminal selection 2 (R)

F 113 : Input terminal selection 3 (RST)

F 114 : Input terminal selection 4 (S1)

F 115 : Input terminal selection 5 (S2)

F 116 : Input terminal selection 6 (S3)

Use the above parameters to send signals from an external programmable controller to various control input terminals to operate and/or set the inverter.

The desired contact input terminal functions can be selected from 51 types. This gives system design flexibility.

■ Setting of contact input terminal function

Terminal symbol	Title	Function	Adjustment range	Default setting
-	F : 10	Always-active function selection	0-51 (See Section 11 table of input terminal functions)	0 (Without assigned function)
F	F : 11	Input terminal selection 1 (F)		2 (Forward run)
R	F : 12	Input terminal selection 2 (R)		3 (Reverse run)
RST	F : 13	Input terminal selection 3 (RST)		10 (Reset)
S1	F : 14	Input terminal selection 4 (S1)		6 (Preset-speed 1)
S2	F : 15	Input terminal selection 5 (S2)		7 (Preset-speed 2)
S3	F : 16	Input terminal selection 6 (S3)		8 (Preset-speed 3)

Note: The function that has been selected using F : 10 (always-active function selection parameter) is always activated.

■ Connection method

1) A-contact input (Sink logic)

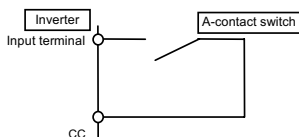

★ This function is activated when the input terminal and CC (common) are short-circuited. Use this function to specify forward/reverse run or a preset-speed operation.

2) Connection with transistor output

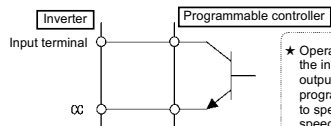

★ Operation can be controlled by connecting the input and CC (common) terminals to the output (no-contacts switch) of the programmable controller. Use this function to specify forward/reverse run or a preset-speed operation. Use a transistor that operates at 24Vdc/5mA.

* Interface between programmable controller and inverter

When operation is to be controlled using a programmable controller of the open-collector output type, if the programmable controller is turned off with the inverter on, the difference in control power potential will cause wrong signals to be sent to the inverter as shown in the diagram below. Be sure to provide an interlock so that the programmable controller cannot be turned off when the inverter is on.

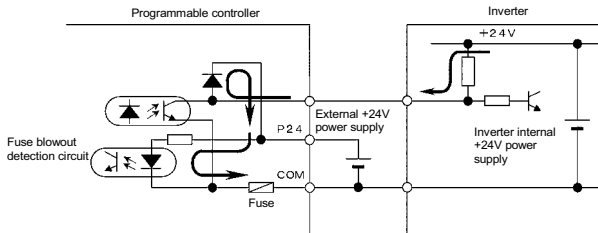

3) Sink logic/source logic input

Sink logic/source logic (input/output terminal logic) switching is possible.
See Section 2.3 for further details.

Example of application ... Three-wire operation

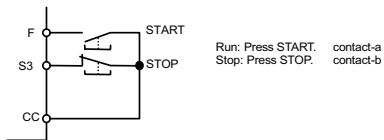

[Parameter setting]

Terminal symbol	Title	Function	Adjustment range	Setting
F	F : 1 1 1	Input terminal selection 1	0-51 (see Section 11)	2 (Forward running command)
S3	F : 1 5	Input terminal selection 6		49 (Operation holding)
	F : 0 3	ST signal selection	0-3	1 (Stand by always on)

In case of three-wire operation, F : 0 3 set to 1.

6.3.3 Modifying output terminal functions

F 130 : Output terminal selection 1 (RY-RC)

F 131 : Output terminal selection 2 (OUT)

F 132 : Output terminal selection 3 (FLA/B/C)

Use the above parameters to send various signals from the inverter to external equipment. Up to 30 functions can be used by setting special parameters for the RY-RC, OUT, and FL (FLA, FLB, FLC) terminals on the control terminal board.

■ Examples of application

Function of RY-RC:
Can be set using parameter **F 130**.

Function of OUT:
Can be set using parameter **F 131**.

Function of FLA/B/C:
Can be set using parameter **F 132**.

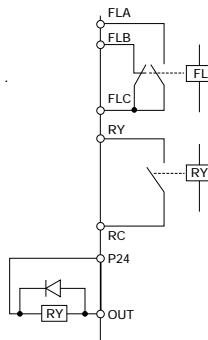

■ Setting of output terminal function

Terminal symbol	Title	Function	Adjustment range	Default setting
RY-RC	F 130	Output terminal selection 1	0~29 (see Section 11)	4 (Low-speed detection signal)
OUT	F 131	Output terminal selection 2		6 (Designated frequency reach)
FL	F 132	Output terminal selection 3		10 (Failure FL)

Sink logic/source logic output (OUT)
Sink logic/source logic (output terminal logic) switching is possible.
See Section 2.3 for further details.

6.4 Basic parameters 2

6.4.1 Switching motor characteristics via terminal input

F170 : Base frequency 2

F172 : Torque boost 2

F173 : Motor electronic-thermal protection level 2

- Function

Use the above parameters to switch the operation of two motors with a single inverter and to select motor V/F characteristics (two types) according to the particular needs or operation mode.

Note: The P_{tc} (V/F control mode selection) parameter is enabled only for motor 1. If motor 2 is selected, V/F control will be given constant torque characteristics.

Parameter setting

Title	Function	Adjustment range	Default setting
F170	Base frequency 2	25 ~ 400 (Hz)	50 or 60
F172	Torque boost 2	0.0 ~ 30.0 (%)	According to model (See section 11)
F173	Motor electronic-thermal protection level 2	10 ~ 100 (%)	100

*Setting value of F170 depending on the end of Type-form. AN, WN : 60Hz, WP : 50Hz

Setting of switching terminals

The terminal for switching to motor 2 needs to be set, since this function is not assigned under the default setting. Assign this function to an idle terminal.

The parameters to be switched depend on the particular identification number of the input terminal selection function.

Input terminal function number			Parameters to be used or switched
40:MCHG	39:THR2	5:AD2	
OFF	OFF	OFF	Parameters to be used P_{tc} , ω_{ub} , t_{hr} , RCC , dEC , $F502$
OFF	OFF	ON	Parameters to be switched $RCC \rightarrow F500$, $F502 \rightarrow F503$, $dEC \rightarrow F501$
OFF	ON	OFF	Parameters to be switched $P_{tc} \rightarrow 0$, $\omega_{ub} \rightarrow F170$, $\omega_{ub} \rightarrow F172$, $t_{hr} \rightarrow F173$
OFF	ON	ON	Parameters to be switched $P_{tc} \rightarrow 0$, $\omega_{ub} \rightarrow F170$, $RCC \rightarrow F500$, $F502 \rightarrow F503$ $dEC \rightarrow F501$, $\omega_{ub} \rightarrow F172$, $t_{hr} \rightarrow F173$
ON	-	-	Parameters to be switched $P_{tc} \rightarrow 0$, $\omega_{ub} \rightarrow F170$, $RCC \rightarrow F500$, $F502 \rightarrow F503$ $dEC \rightarrow F501$, $\omega_{ub} \rightarrow F172$, $t_{hr} \rightarrow F173$

6.5 Frequency priority selection

6.5.1 Using a frequency command according to the particular situation

F_{NO}d : Frequency setting mode selection

F₂₀₀ : Frequency priority selection

- Function

Use the above parameters to select the command to be used for frequency setting, and to assign priority to one of the two types of input frequency reference signals.

- Combination of the **F_{NO}d** and **F₂₀₀** parameters
- Switching via terminal board input

■ Parameter setting

Title	Function	Adjustment range	Default setting
F_{NO}d	Frequency setting mode selection	0: Terminal board 1: Operation panel 2: Internal potentiometer	2

■ Parameter setting

Title	Function	Adjustment range	Default setting
F₂₀₀	Frequency priority selection	0: VIA/II, VIB 1: VIB, VIA/II 2: External switching (FCHG enabled) 3: External contact UP/DOWN 4: External contact UP/DOWN (Setting retained even if the power is turned off) 5: VIA/II + VIB	0

The VIA terminal and II terminal cannot be used at the same time.

1) Automatic frequency switching 1

Frequency priority selection parameter **F₂₀₀** = 0 (Default setting)

F_{NO}d = 0: Terminal board is selected.

First priority is assigned to analog input terminals VIA/II, and second priority to analog input terminals VIB.

When the input to VIA/II with first priority becomes null, control will be switched automatically to VIB with second priority.

2) Automatic frequency switching 2

Frequency priority selection parameter $F200 = 1$

$F200 = 0$: Terminal board is selected.

First priority is assigned to analog input terminals VIB, and second priority to analog input terminals VIA/II.

When the input to VIB with first priority becomes null, control will be switched automatically to VIA/II with second priority.

3) External switching (FCHG enabled)

Frequency priority selection parameter $F200 = 2$

$F200 = 0$: Terminal board is selected.

Enter "38" (frequency command forced switching) as the input terminal function selection parameter to specify the analog input terminals to be used.

When the frequency command forced switching function is set OFF : VIA/II ON : VIB are selected, respectively, and this function is applicable to automatic/manual switching.

4) External contact UP/DOWN

Frequency priority selection parameter $F200 = 3$

$F200 = 1$: Operation panel is selected.

Set the $F200$ parameter to "1" (operation panel) when the frequency is to be adjusted with external contacts.

In this case, set the frequency priority selection parameter to "3" (External contact UP/DOWN).

Set the input terminal function selection parameter to "41/42" (External contact UP/DOWN) to select external contact input. See 6.5.2.

The set frequency is cleared automatically after power-off.

5) External contact UP/DOWN (Setting retained even if the power is turned off)

Frequency priority selection parameter $F200 = 4$

$F200 = 1$: Operation panel is selected.

Set the $F200$ parameter to "1" (operation panel) when the frequency is to be adjusted with external contacts.

In this case, set the frequency priority selection parameter to "4" (External contact UP/DOWN).

Set the input terminal function selection parameter to "41/42" (External contact UP/DOWN) to select external contact input. See 6.5.2.

The set frequency is stored automatically even if the power is turned off.

Next time the inverter is operated, the previous setting of the frequency becomes enabled.

6) VIA/II + VIB

Frequency priority selection parameter $F200 = 5$

$F200 = 0$: Terminal board is selected.

Analog input terminal data VIA/II and analog input terminal data VIB are added in this mode.

The override function can be executed with analog input terminal data VIA/II as the main data, and analog input terminal data VIB as correction data.

Note: This mode disabled during feedback operation based on PI control.

6.5.2 Setting frequency command characteristics

F201 : VIA/II input point 1 setting

F202 : VIA/II input point 1 frequency

F203 : VIA/II input point 2 setting

F204 : VIA/II input point 2 frequency

F210 : VIB input point 1 setting (Frequency UP response time)

F211 : VIB input point 1 frequency (Frequency UP step width)

F212 : VIB input point 2 setting (Frequency DOWN response time)

F213 : VIB input point 2 frequency (Frequency DOWN step width)

- Function

These parameters adjust the output frequency according to the externally applied analog signal (0-10V dc voltage, 4-20mA dc current) and the entered command for setting an external contact frequency.

Parameter setting

Title	Function	Adjustment range	Default setting
F201	VIA/II input point 1 setting	0 ~ 100 (%)	0
F202	VIA/II input point 1 frequency	0.0 ~ 400.0 (Hz)	0.0
F203	VIA/II input point 2 setting	0 ~ 100 (%)	100
F204	VIA/II input point 2 frequency	0.0 ~ 400.0 (Hz)	50 or 60 *1
F210	VIB input point 1 setting	0 ~ 100 (%)	0
	Frequency UP response time	0 ~ 100 (1: 0.1 s)	0
F211	VIB input point 1 frequency	0.0 ~ 400.0 (Hz)	0.0
	Frequency UP step width	0.0 ~ 400.0	0
F212	VIB input point 2 setting	0 ~ 100 (%)	100
	Frequency DOWN response time	0 ~ 100 (1: 0.1 s)	100
F213	VIB input point 2 frequency	0.0 ~ 400.0 (Hz)	50 or 60 *1
	Frequency DOWN step width	0.0 ~ 400.0	50 or 60 *1

Note1) Setting value of **F204** and **F213** depending on the end of Type form. AN, WN : 60Hz, WP: 50Hz.

Note2) **F210** - **F213** can be used as UP/DOWN function depend on the setting.

Note3) Don't set the same value between point 1 and point 2.

If set the same value, the **Err** is displayed.

1) 0-10Vdc voltage input adjustment (VIA, VIB)

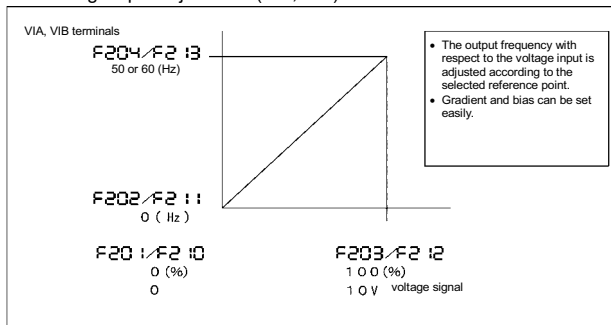

2) 4-20mA current input adjustment (II)

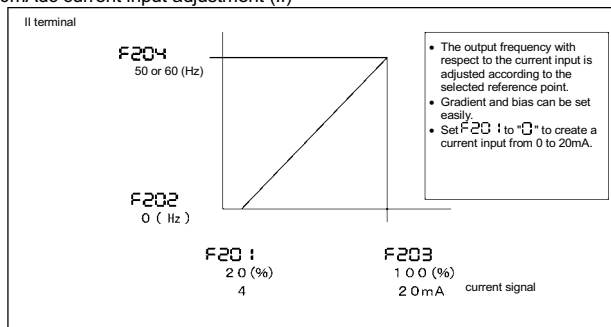
3) Setting frequency via external contact input
(only when $F20d = 1, F200 = 3$ or 4)

■ Adjustment with continuous signals (Parameter-setting example 1)

Set parameters as follows to adjust the output frequency up or down in proportion to the frequency adjustment signal input time:

Panel frequency incremental gradient = $F211/F210$ setting time

Panel frequency decremental gradient = $F213/F212$ setting time

Set parameters as follows to adjust the output frequency up or down almost in synchronization with the adjustment by the panel frequency command:

$$F2\ 10 = F2\ 12 = 1$$

$$FCC\ (\text{or}\ FSOQ) / F\ H \leq (F2\ 11 / F2\ 10)\ \text{setting time}$$

$$DEC\ (\text{or}\ FSOI) / F\ H \leq (F2\ 13 / F2\ 12)\ \text{setting time}$$

<<Sample sequence diagram 1: Adjustment with continuous signals>>

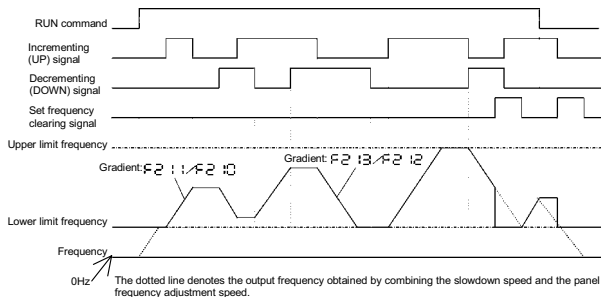

■ Adjustment with pulse signals (Parameter-setting example 2)

Set parameters as follows to adjust the frequency in steps of one pulse:

$$F2\ 10, F2\ 12 > \text{Pulse ON time} > 32\text{msec}$$

$$F2\ 11, F2\ 13 = \text{Frequency obtained with each pulse}$$

* If signal input time less than setting $F2\ 10, F2\ 12$ is not responded. 12ms or more of clearing signal is allowed.

<<Sample sequence diagram 2: Adjustment with pulse signals>>

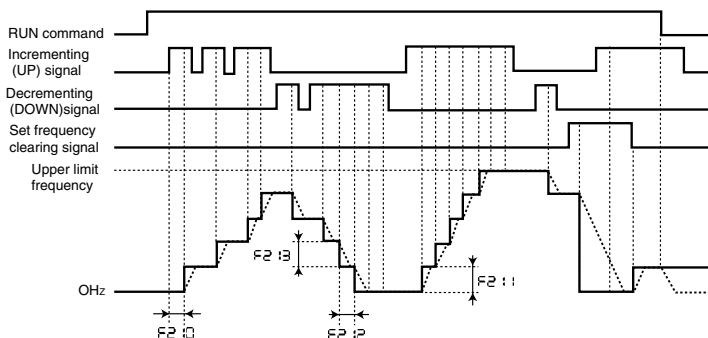

6

■ Simultaneous input

- If input clearing signal and decrementing signal at the same time, clearing signal is allowed.
- If input incrementing signal and decrementing signal at the same time, difference of both signal is responded.
Ex. If $F2:1 > F2:3$ frequency ($F2:1 - F2:3$) increase.

■ Storage of the set frequency

Set parameter $F2:0 = 4$ to select automatic storage of the frequency setting.

■ Frequency adjustment range

The frequency can be set from LL (lower limit frequency) to UL (upper limit frequency). The LL value will be set as soon as the set frequency clearing function (function number: 43, 44) is entered from the input terminal.

■ Minimum unit of frequency adjustment

If the unit selection parameter $F7:1 = 2$ (free unit selection enabled) and the free unit selection parameter $F7:2 = 1.00$, the output frequency can be adjusted in steps of 0.01Hz.

6.6 Operation frequency

6.6.1 Starting frequency

F240 : Starting frequency setting

- Function

The frequency set with the parameter **F240** is put out immediately on completion of frequency setting.

Use the **F240** parameter when a delay in response of starting torque according to the acceleration/deceleration time is probably affecting operation. Setting the starting frequency to a value from 0.5 to 2Hz (maximum: 5Hz) is recommended. The occurrence of an overcurrent can be suppressed by setting this frequency below the rated slippage of the motor.

[Parameter setting]

Title	Function	Adjustment range	Default setting
F240	Starting frequency setting	0.5 - 10.0 (Hz)	0.5

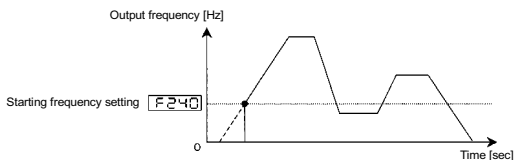

6.6.2 Run/stop control with frequency setting signals

F241 : Operation starting frequency

F242 : Operation starting frequency hysteresis

- Function

The Run/stop of operation can be controlled simply with frequency setting signals.

[Parameter setting]

Title	Function	Adjustment range	Default setting
F241	Operation starting frequency	0.0 ~ F_H (Hz)	0.0
F242	Operation starting frequency hysteresis	0.0 ~ F_H (Hz)	0.0

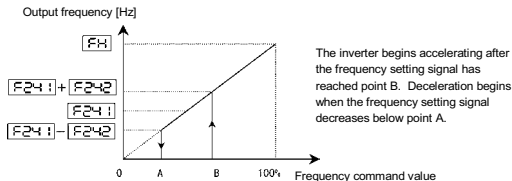

6.7 DC braking

6.7.1 DC braking

F250 : DC braking starting frequency

F251 : DC braking current

F252 : DC braking time

- Function

A large braking torque can be obtained by applying a direct current to the motor. These parameters set the direct current to be applied to the motor, the application time and the starting frequency.

[Parameter setting]

Title	Function	Adjustment range	Default setting
F250	DC braking starting frequency	0.0 ~ FH (Hz)	0.0
F251	DC braking current	0.0 ~ 100 (%)	30.0
F252	DC braking time	0.0 ~ 20.0 (sec)	1.0

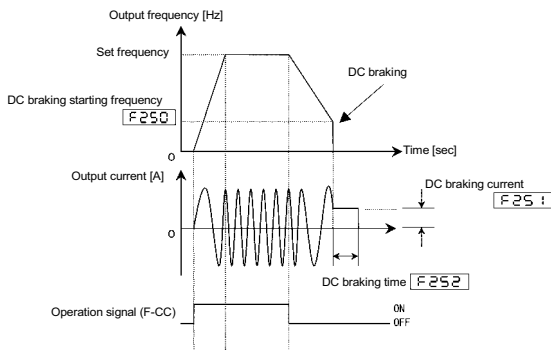

Note: During DC braking, the overload protection sensitivity of the inverter increases. The DC braking current may be adjusted automatically to prevent tripping.

6.8 Jog run mode

F260 : Jog run frequency

F261 : Jog run stopping pattern

- Function
Use the jog run parameters to operate the motor in jog mode. Input of a jog run signal generates a jog run frequency output at once, irrespective of the designated acceleration time.

The motor can be operated in jog mode while the jog run setting terminals are connected (RST-CC ON). (Setting F : 13 to 14)

[Parameter setting]

Title	Function	Adjustment range	Default setting
F250	Jog run frequency	0.0 ~ 20.0 (Hz)	0.0
F251	Jog run stopping pattern	0: Slowdown stop 1: Coast stop 2: DC braking	0

<Examples of jog run>

RST-CC (JOG) ON + F-CC ON: Forward jog run

RST-CC (JOG) ON + R-CC ON: Reverse jog run

(Normal operation frequency signal input + F-CC ON: Forward run)

(Normal operation frequency signal input + R-CC ON: Reverse run)

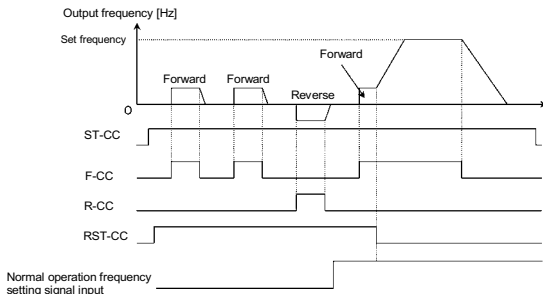

- The jog run setting terminal (RST-CC) is enabled when the operation frequency is below the jog run frequency. This connection does not function at an operation frequency exceeding the jog run frequency.
- The motor can be operated in jog mode while the jog run setting terminals are connected (RST-CC ON).
- Jog run has priority, even when a new operation command is given during operation.
- Even for F251 = 0 or 1, an emergency DC braking becomes enabled when setting F503 parameter to 2.

[Setting of jog run setting terminal (RST-CC)]

Assign control terminal RST (4: reset signal) in default setting) as the jog run setting terminal.

Title	Function	Adjustment range	Default setting
F113	Input terminal selection (RST)	0 ~ 51	4 (jog run setting terminal)

Note: During the jog run mode, there is LOW (low speed detection signal) output but no RCH (designated frequency reach signal) output, and PID control does not work.

6.9 Jump frequency - jumping resonant frequencies

F270 : Jump frequency 1

F271 : Jumping width 1

F272 : Jump frequency 2

F273 : Jumping width 2

F274 : Jump frequency 3

F275 : Jumping width 3

- Function

Resonance due to the natural frequency of the mechanical system can be avoided by jumping the resonant frequency during operation. During jumping, hysteresis characteristics with respect to the jump frequency are given to the motor.

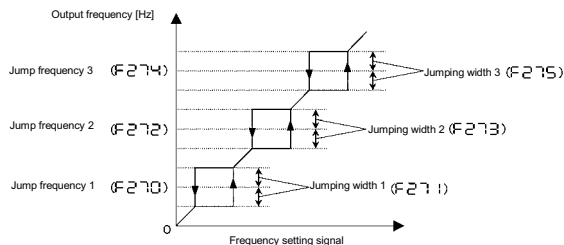

[Parameter setting]

Title	Function	Adjustment range	Setting
F270	Jump frequency 1	$\underline{\quad} \sim \underline{\quad}$ (Hz)	0.0
F271	Jumping width 1	0.0 ~ 30.0 (Hz)	0.0
F272	Jump frequency 2	$\underline{\quad} \sim \underline{\quad}$ (Hz)	0.0
F273	Jumping width 2	0.0 ~ 30.0 (Hz)	0.0
F274	Jump frequency 3	$\underline{\quad} \sim \underline{\quad}$ (Hz)	0.0
F275	Jumping width 3	0.0 ~ 30.0 (Hz)	0.0

☆ Do not set the jump parameters, if multiple jump frequency setting width overlap.

☆ During acceleration or deceleration, the jumping function is disabled for the operation frequency.

6.10 Preset-speed operation frequency 8 to 15

F287 ~ **F294** : Preset-speed operation frequency 8 to 15

See Section 5.15 for details.

6.11 PWM carrier frequency

F300 : PWM carrier frequency

F312 : Random mode

- Function

- The F300 parameter allows the tone of the magnetic noise from the motor to be changed by switching the PWM carrier frequency. This parameter is also effective in preventing the motor from resonating with its load machine or its fan cover.
- In addition, the F300 parameter reduces the electromagnetic noise generated by the inverter. Reduce the carrier frequency to reduce electromagnetic noise. Note: Although the electromagnetic noise level is reduced, the magnetic noise of the motor is increased.
- The random mode reduces motor electromagnetic noise by changing the pattern of the reduced carrier frequency. (Allowable operation frequency: 80Hz max.)

[Parameter setting]

Title	Function	Adjustment range	Default setting
F300	PWM carrier frequency	2.0 ~ 16.5 (kHz) *	12.0
F312	Random mode	0: Disabled, 1: Enabled	0

* Load reduction will be required if the PWM carrier frequency is modified for each applicable motor model.

Load reduction ratios required

[200V Class]

VFS9- VFS9S-	Carrier frequency			
	4kHz or less	12kHz	15kHz	16.5kHz
2002PL/M	1.5A	1.5A	1.5A	1.5A
2004PL/M	3.3A	3.3A	3.1A	3.0A
2007PL/M	4.8A	4.4A	4.2A	3.9A
2015PL/M	7.8A	7.5A	7.2A	7.1A
2022PL/M	11.0A	10.0A	9.1A	8.7A
2037PM	17.5A	16.5A	15.0A	14.3A
2055PL	27.5A	25.0A	25.0A	25.0A
2075PL	33.0A	33.0A	29.8A	28.2A
2110PM	54.0A	49.0A	49.0A	49.0A
2150PM	66.0A	60.0A	54.0A	51.0A

[400V Class]



VFS9-	480V or less				More than 480V			
	Carrier frequency				Carrier frequency			
	4kHz or less	12kHz	15kHz	16.5kHz	4kHz or less	12kHz	15kHz	16.5kHz
4007PL	2.3A	2.1A	2.1A	2.1A	2.1A	1.9A	1.9A	1.9A
4015PL	4.1A	3.7A	3.3A	3.1A	3.8A	3.4A	3.1A	3.0A
4022PL	5.5A	5.0A	4.5A	4.3A	5.1A	4.6A	4.2A	4.0A
4037PL	9.5A	8.6A	7.5A	7.0A	8.7A	7.9A	6.9A	6.4A
4055PL	14.3A	13.0A	13.0A	13.0A	13.2A	12.0A	12.0A	12.0A
4075PL	17.0A	17.0A	14.8A	13.7A	15.6A	14.2A	12.4A	12.0A
4110PL	27.7A	25.0A	25.0A	24.7A	25.5A	23.0A	23.0A	23.0A
4150PL	33.0A	30.0A	26.4A	24.9A	30.4A	27.6A	24.3A	23.0A

- Note:
Default setting of PWM carrier frequency is 12kHz, but rated output current of rating label display at 4kHz.

6.12 Trip-less intensification

6.12.1 Auto-restart (Restart during coasting)

F301 : Auto-restart control selection

 Caution	
 Mandatory	<ul style="list-style-type: none"> Stand clear of motors and mechanical equipment If the motor stops due to a momentary power failure, the equipment will start suddenly when power is restored. This could result in unexpected injury. Attach warnings about sudden restart after a momentary power failure on inverters, motors and equipment to prevent accidents in advance.

- Function
The F301 parameter detects the rotating speed and rotational direction of the motor during coasting in the event of momentary power failure, and then after power has been restored, restarts the motor smoothly (motor speed search function). This parameter also allows commercial power operation to be switched to inverter operation without stopping the motor.
During operation, "r ← r ←" is displayed.

Title	Function	Adjustment range	Default setting
F30	Auto-restart control selection	0: Disabled 1: At auto-restart after momentary stop 2: When turning ST-CC on or off 3: At auto-restart or when turning ST-CC on or off 4: Motion of DC braking at start-up (at auto-restart after momentary stop) 5: Motion of DC braking at start-up (when turning ST-CC on or off) 6: Motion of DC braking at start-up (at auto-restart or when turning ST-CC on or off)	0

* If the motor is restarted in retry mode, this function will operate, regardless of the setting of this parameter.

1) Auto-restart after momentary power failure (Auto-restart function)

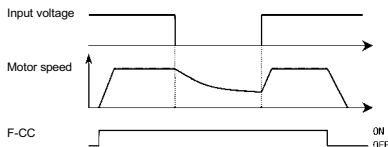

★ Setting F30 to 1 (A): This function operates after power has been restored following detection of an undervoltage by the main circuits and control power.

2) Restarting motor during coasting (Motor speed search function)

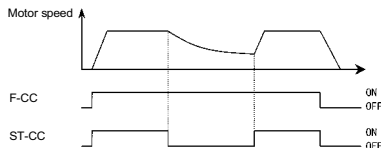

★ Setting F30 to 2 (B): This function operates after the ST-CC terminal connection has been opened first and then connected again.

3) DC braking during restart

If this parameter is set to either "4", "5", or "6", DC braking specified by parameter F25 or F252 will be conducted during the restart of the motor.

This function is effective when the motor is under a momentary power failure or coasting status and is reversing for some external reason.

Application!!

- A waiting time of 200 to 1,000msec is preset to allow the residual voltage in the motor to decrease to a certain level during restart. For this reason, the start-up takes more time than usual.
- Use this function when operating a system with one motor connected to one inverter. This function may not operate properly in a system configuration with multiple motors connected to one inverter.

Application to a crane or hoist

The crane or hoist may have its load moved downward during the above waiting time from input of the operation starting command to the restart of the motor. To apply the inverter to such machines, therefore, set the auto-restart control mode selection parameter to "0" (Disabled), and avoid using the retry function. If retry function is enabled the load could move downward causing damage and or injury.

6.12.2 Regenerative power ride-through control

F302 : Regenerative power ride-through control

• Function

Regenerative power ride-through control continues the operation of the motor by utilizing motor regenerative energy in the event of momentary power failure.

[Parameter setting]

Title	Function	Adjustment range	Default setting
F302	Regenerative power ride-through control	0: Disabled, 1: Enabled	0

Note: Even when this parameter is set, the particular load conditions may cause the motor to coast. In this case, use the auto-restart function along with this parameter function.

[When power is interrupted]

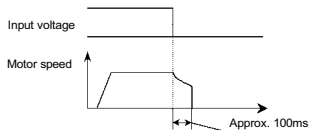

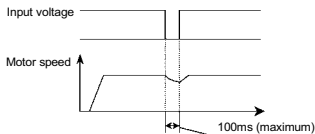

- ★ The time for which the operation of the motor can be continued depends on the machine inertia and load conditions. Before using this function, therefore, perform verification tests.
- ★ Use with the retry function allows the motor to be restarted automatically without being brought to an abnormal stop.
- ★ The operation continuing time is about 100ms when regenerative power ride-through control is enabled (F302 = 1).

[If momentary power failure occurs]



6.12.3 Retry function

F303 : Retry selection (Selecting the number of times the motor is to be restarted automatically)

 Warning	
 Mandatory	<ul style="list-style-type: none"> Do not go near the motor in alarm-stop status when the retry function is selected. The motor may suddenly restart, which could result in injury. Take measures for safety, e.g. attach a cover to the motor, to prevent accidents if the motor suddenly restarts.

- Function
This parameter resets the inverter automatically when the inverter gives an alarm. During the retry mode, the motor speed search function operates automatically as required and thus allows smooth motor restarting.

[Parameter setting]

Title	Function	Adjustment range	Default setting
F303	Retry selection	0: None, 1 ~ 10 times	0

The likely causes of tripping and the corresponding retry processes are listed below.

Cause of tripping	Retry process	Canceled conditions
Momentary power failure Overcurrent Overvoltage Overload	Up to 10 times in succession 1st retry: About 1 sec after tripping 2nd retry: About 2 sec after tripping 3rd retry: About 3 sec after tripping ... 10th retry: About 10 sec after tripping	The retry function will be canceled at once if tripping is caused by an unusual event other than: momentary power failure, overcurrent, overvoltage or overload. This function will also be canceled if retrying is not successful within the specified number of times.

★ The retry function is disabled in the following unusual events:

- | | |
|--|---------------------------------------|
| • OC R : Arm overcurrent at start-up | • Err 2 : Main unit RAM fault |
| • OC L : Overcurrent on the load side at start-up | • Err 3 : Main unit ROM fault |
| • OPH 0 : Output phase failure | • Err 4 : CPU fault trip |
| • OTH 2 : External thermal trip | • Err 5 : Remote control error |
| • OT : Overtorque trip | • EEP : EE PROM fault |
| • UC : Small-current operation trip | • Et n : Auto-tuning error |
| • E : External trip stop | |
| • UP : Undervoltage trip (main circuit) | • EF 2 : Ground fault trip |
| • EPH : Input phase failure | • Et yP : Inverter type error |

★ Protective operation detection relay signals (FLA, FLB, FLC terminal signals) are not sent during use of the retry function.

★ A virtual cooling time is provided for overload tripping (**OL 1**, **OL 2**, **OL r**). In this case, the retry function operates after the virtual cooling time and retry time.

★ In the event of over voltage tripping (**OP 1** ~ **OP 3**), re-tripping may result unless the DC voltage de-

creases below a predetermined level.

- ★ In the event of overheating-caused tripping (□H), re-tripping may result unless the internal temperature decreases below a predetermined level, since the internal temperature detection function of the inverter works.
- ★ Even when trip retention selection parameter F502 is set to "1", the retry function is enabled by F303 setting.
- ★ During retrying, the blinking display will alternate between "r-r-B" and the monitor display specified by status monitor display mode selection parameter F7:0.

6.12.4 Dynamic (regenerative) braking - For abrupt motor stop

F304 : Dynamic braking selection

F308 : Braking resistor operation rate

- Function

The VFS9 does not contain a braking resistor. Connect an external braking resistor in the following cases to enable dynamic braking:

- 1) when decelerating the motor abruptly or if overvoltage tripping (OP) occurs during deceleration stop
- 2) when a continuous regenerative status occurs during downward movement of a lift or the winding-out operation of a tension control machine
- 3) when the load fluctuates and a continuous regenerative status results even during constant speed operation of a machine such as a press

[Parameter setting]

Title	Function	Adjustment range	Default setting
F304	Dynamic braking selection	0: Dynamic braking disabled 1: Dynamic braking enabled, overload protection disabled 2: Dynamic braking enabled, overload protection enabled	0
F308	Braking resistor operation rate	1 ~ 100 (% ED)	3

1) Connecting an external braking resistor (optional)

Separate-type optional resistor (with thermal fuse)

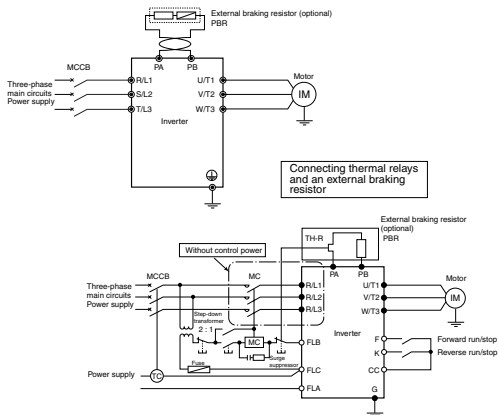

Connecting thermal relays and an external braking resistor

[Parameter setting]

Title	Function	Setting
F304	Dynamic braking selection	2
F308	Braking resistor operation rate	Any value
F305	Overvoltage limit operation	1

- ☆ Optional dynamic braking resistor capacities are selected for an operation rate of 3%ED.
- ☆ To connect a dynamic braking resistor, set the overvoltage limit operation parameter **F305** to "1" (Disabled).
- ☆ To use this inverter in applications that create a continuously regenerative status (such as downward movement of a lift, a press or a tension control machine), or in applications that require slowdown stopping of a machine with a significant load inertial moment, increase the dynamic braking resistor capacity according to the operation rate required.
- ☆ To connect an external dynamic braking resistor, select one with a resultant resistance value greater than the minimum allowable resistance value. Be sure to set the appropriate operation rate in **F308** to ensure overload protection.
- ☆ To use a braking resistor without a thermal fuse or to use a braking resistor in mode "1" of **F304**, connect thermal relays as shown in the diagram above, to make an operation circuit for stopping operation.

2) Setting the braking resistor operation rate

Calculate the braking resistor operation rate as follows:

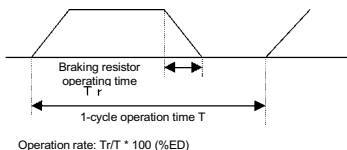

3) Optional dynamic braking resistors (Optional braking resistors for higher frequencies of regenerative braking are also available)

Optional dynamic braking resistors are listed below. All these resistors are 3%ED in operation rate.

Inverter model	Braking resistor/Braking unit	
	Model number	Rating
VFS9S-2002PL ~ 2007PL VFS9-2002PM ~ 2007PM	PBR-2007	120W- 200Ω
VFS9S-2015PL ~ 2022PL VFS9-2015PM ~ 2022PM	PBR-2022	120W- 75Ω
VFS9-2037PM	PBR-2037	120W- 40Ω
VFS9-2055PL	PBR3-2055	120W- 40Ω × 2P (240W- 20Ω)
VFS9-2075PL	PBR3-2075	220W- 30Ω × 2P (440W- 15Ω)
VFS9-2110PM	PBR3-2110	220W- 30Ω × 3P (660W- 10Ω)
VFS9-2150PM	PBR3-2150	220W- 30Ω × 4P (880W- 7.5Ω)
VFS9-4007PL ~ 4022PL	PBR-2007	120W- 200Ω
VFS9-4037PL	PBR-4037	120W-160Ω
VFS9-4055PL	PBR3-4055	120W-160Ω × 2P (240W- 80Ω)
VFS9-4075PL	PBR3-4075	220W-120Ω × 2P (440W- 60Ω)
VFS9-4110PL	PBR3-4110	220W-120Ω × 3P (660W- 40Ω)
VFS9-4150PL	PBR3-4150	220W-120Ω × 4P (880W- 30Ω)

Note: The data in parentheses above refer to the resultant resistance capacities (watts) and resultant resistance values (ohms) of standard braking resistors.

4) Minimum resistances of connectable braking resistors

The minimum allowable resistance values of the externally connectable braking resistors are listed in the table below.

Do not connect braking resistors with smaller resultant resistances than the listed minimum allowable resistance values.

Inverter rated output capacity (kW)	200V class		400V class	
	Resistance of standard option	Minimum allowable resistance	Resistance of standard option	Minimum allowable resistance
0.2	200Ω	63Ω	-	-
0.4	200Ω	63Ω	-	-
0.75	200Ω	42Ω	200Ω	99Ω
1.5	75Ω	30Ω	200Ω	99Ω
2.2	75Ω	30Ω	200Ω	73Ω
3.7	40Ω	24Ω	160Ω	73Ω
5.5	20Ω	10Ω	80Ω	44Ω
7.5	15Ω	10Ω	60Ω	44Ω
11	10Ω	7Ω	40Ω	22Ω
15	7.5Ω	7Ω	30Ω	22Ω

6.12.5 Avoiding overvoltage tripping

F305 : Overvoltage limit operation

- Function

This parameter keeps the output frequency constant or increases the frequency to prevent overvoltage tripping due to increases in DC voltage during deceleration or constant-speed operation. The deceleration time during overvoltage limit operation may increase above the designated time.

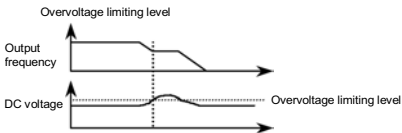

[Parameter setting]

Title	Function	Adjustment range	Default setting
F305	Overvoltage limit operation	0: Enabled 1: Prohibited	0

6.12.6 Output voltage adjustment/Supply voltage correction

F306 : Output voltage adjustment (Base frequency voltage)

F307 : Supply voltage correction

- Function

Output voltage adjustment (Base frequency voltage)

The **F306** parameter adjusts the voltage corresponding to the base frequency 1_{UL} so that no voltage exceeding the **F306** set value is put out. (This function is enabled only when **F307** is set to either "0", "1", or "2".)

Supply voltage correction

The **F307** parameter maintains a constant V/F ratio, even when the input voltage decreases. The torque during low-speed operation is prevented from decreasing.

Supply voltage correction Maintains a constant V/F ratio, even when the input voltage fluctuates.

Output voltage adjustment Limits the voltage at frequencies exceeding the base frequency. Applied when operating a special motor with low induced voltage.

[Parameter setting]

Title	Function	Adjustment range	Default setting
F306	Output voltage adjustment (Base frequency voltage)	0 ~ 250 (V), 0 ~ 500 (V)	200V/400V
F307	Supply voltage correction	0: Supply voltage uncorrected, output voltage limited 1: Supply voltage corrected, output voltage limited 2: Supply voltage corrected (off during slow-down), output voltage limited 3: Supply voltage uncorrected, output voltage unlimited 4: Supply voltage corrected, output voltage unlimited 5: Supply voltage corrected (off during deceleration), output voltage unlimited	1

☆ If **F307** is set to "0" or "3", the output voltage will change in proportion to the input voltage.

☆ Even if the base frequency voltage (**F306** parameter) is set above the input voltage, the output voltage will not exceed the input voltage.

☆ The rate of voltage to frequency can be adjusted according to the rated motor capacity. For example, setting **F307** to "1" or "2" prevents the output voltage from increasing, even if the input voltage changes when operation frequency exceeds the base frequency.

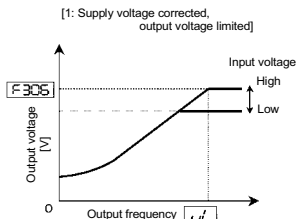
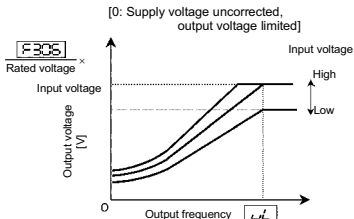

* The above applies when V/F control mode selection parameter P_{12} is set to "0" or "1".

F_{305} → 1
Rated voltage → the output voltage can be prevented from exceeding the input voltage.

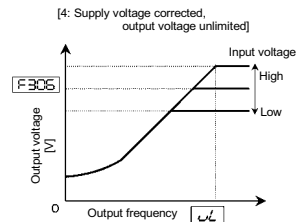
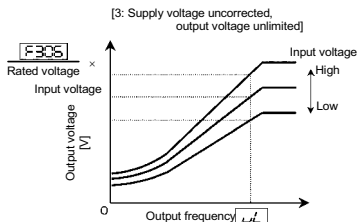

* The above applies when V/F control mode selection parameter P_{12} is set to "0" or "1".

F_{305} → 1
Rated voltage → the output voltage can be prevented from exceeding the input voltage.

* Even if F_{305} is set for an output voltage lower than the input voltage, the output voltage will exceed the voltage adjusted by F_{305} when the output frequency is higher than the base frequency ω_L .

The F_{307} settings to "2" and "5" [supply voltage corrected (off during deceleration)] mean the same operation as those to "1" and "4", respectively, except during deceleration. These settings prevent overvoltage during deceleration, while minimizing decreases in low-speed operating torque due to changes in voltage.

6

6.12.7 Conducting PI control

F360 : Proportional/integral control (PI control)

F362 : Proportional gain

F363 : Integral gain

- Function

These parameters provide various types of process control, such as maintaining constant air quantity, flow rates and pressures, by input of feedback signals from the detector.

[Parameter setting]

Title	Function	Adjustment range	Default setting
F360	PI control	0: Disabled 1: Enabled	0
F362	Proportional gain	0.01 ~ 100.0	0.30
F363	Integral gain	0.01 ~ 100.0	0.20

1) External connection

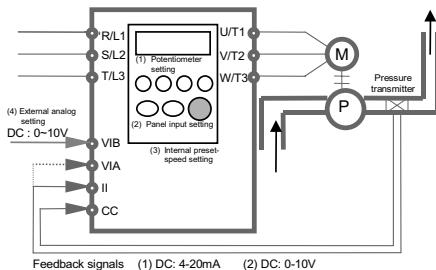

2) Types of PI control interfaces

Process quantity input data (frequency) and feedback input data can be combined as follows for the PI control of the VF-S9:

Process quantity input data (frequency setting)		Feedback input data
Setting method	Frequency setting mode $F\bar{7}\bar{0}\bar{3}$	
(1) Internal potentiometer setting	$\bar{2}$	External analog input (1)II(DC:4 ~ 20mA) (2)VI(DC:0 ~ 10V)
(2) Panel input setting	$\bar{1}$	
(3) Internal preset-speed setting	$\bar{0}$	
(4) External analog setting VIB (DC: 0-10V)	$\bar{0}$	

Note: When PI control is selected ($F\bar{3}\bar{6}\bar{0}$ = "1"), frequency priority selection ($F\bar{2}\bar{0}\bar{0}$) is disabled. In this case, therefore, since II or VIA is reserved for feedback signal input only, frequency setting by switching to VIB cannot be executed.

3) Setting PI control

Set "1" in the extended parameter $F\bar{3}\bar{6}\bar{0}$ (PI control).

- Set parameters $R\bar{C}\bar{C}$ (acceleration time) and $d\bar{E}\bar{C}$ (deceleration time) to their minimum values (0.1 sec).
- To limit the output frequency, set parameters $\bar{U}\bar{L}$ (upper limit frequency) and $\bar{L}\bar{L}$ (lower limit frequency). If process quantities are set from the operation panel, however, the process quantity setting range will be limited by the settings of $\bar{U}\bar{L}$ and $\bar{L}\bar{L}$.

4) Adjusting the PI control gain level

Adjust the PI control gain level according to the process quantities, the feedback signals and the object to be controlled.

The following parameters are provided for gain adjustment:

Parameter	Setting range	Default setting
$F\bar{3}\bar{6}\bar{2}$ (P-gain)	0.01 ~ 100.0	0.30
$F\bar{3}\bar{6}\bar{3}$ (I-gain)	0.01 ~ 100.0	0.20

$F\bar{3}\bar{6}\bar{2}$ (P-gain adjustment parameter)

This parameter adjusts the proportional gain level during PI control. A correction value proportional to the particular deviation (the difference between the set frequency and the feedback value) is obtained by multiplying this deviation by the parameter setting.

A larger P-gain adjustment value gives faster response. Too large an adjustment value, however, results in an unstable event such as hunting.

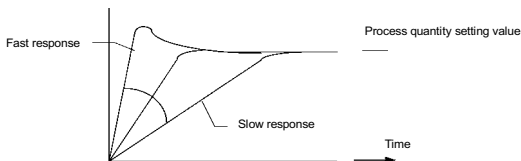

F353 (I-gain adjustment parameter)

This parameter adjusts the integral gain level during PI control. Any deviations remaining unremoved during proportional action are cleared to zero (residual deviation offset function).

A larger I-gain adjustment value reduces residual deviations. Too large an adjustment value, however, results in an unstable event such as hunting.

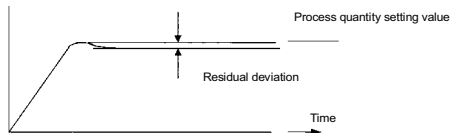

5) Adjusting analog command voltages

To use external analog setting (VIB) or feedback input (II/VIA), perform voltage-scaling adjustments as required. See Section 6.5.2 for further details.

If the feedback input data is too small, voltage-scaling adjustment data can also be used for gain adjustment.

Example of VIB terminal setting

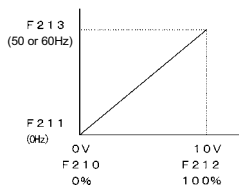

Example of VIA terminal setting

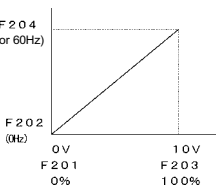

Example of II terminal setting

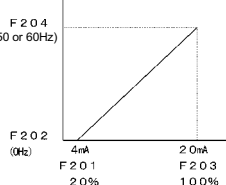

6.13 Setting motor constants

F400	: Auto-tuning
F401	: Slip frequency
F402	: Motor primary constant
F403	: Motor secondary constant
F404	: Motor excitation constant
F405	: Magnification of load inertial moment
F408	: Rated capacity ratio of motor to inverter

To use vector control, automatic torque boost and automatic energy-saving, motor constant setting (motor tuning) is required. The following three methods are available to set motor constants (for automatic torque boosting, however, two methods are available):

- Using the automatic torque boost (**P2**) for setting the V/F control mode selection (**P5**) and auto-tuning (**F400**) at the same time
 - Setting the V/F control mode selection (**P5**) and auto-tuning (**F400**) independently
 - Combining the V/F control mode selection (**P5**) and manual tuning
- Sensorless vector control may not operate properly if the motor capacity differs from the applicable rated capacity of the inverter by more than two grades.

[Selection 1: Setting by automatic torque boost]

This is the easiest of the available methods. It conducts vector control and auto-tuning at the same time.

Set the automatic torque boost parameter (**P2**) to "1"
(Sensorless vector control + auto-tuning).

See Section 5.2 for details of the setting method.

[Selection 2: Setting sensorless vector control and auto-tuning independently]

This method sets sensorless vector control or automatic torque boost, and auto-tuning independently.

Specify the control mode in the V/F control mode selection parameter ("**P5**") and then set auto-tuning.

Set the auto-tuning parameter (**F400**) to "2".

[Parameter setting]

Title	Function	Adjustment range	Default setting
F400	Auto-tuning	0: Auto-tuning disabled (Use of internal parameters) 1: Application of individual settings of F401 ~ F405 2: Auto tuning enabled (returns to "1" after auto-tuning)	0

Set F400 to "2".

Set F408 to "1" if the motor capacity is one size smaller than the applicable rated capacity of the inverter.

☆ Precautions on auto-tuning

- (1) Conduct auto-tuning only after the motor has been connected and operation completely stopped.
If auto-tuning is conducted immediately after operation stops, the presence of a residual voltage may result in abnormal tuning.
- (2) Voltage is applied to the motor during tuning even though it barely rotates.
- (3) Tuning is usually completed within three seconds. If it is aborted, the motor will trip with the display of "E L n" and no constants will be set for that motor.
- (4) High-speed motors, high-slip motors or other special motors cannot be auto-tuned. For these motors, perform manual tuning using Selection 3 described below.
- (5) Provide cranes and hoists with sufficient circuit protection such as mechanical braking. Without sufficient circuit protection, the resulting insufficient motor torque during tuning could create a risk of machine stalling/falling.
- (6) If auto-tuning is impossible or an "E L n" auto-tuning error is displayed, perform manual tuning with Selection 3.

[Selection 3: Setting vector control and manual tuning independently]

If an "E L n" tuning error is displayed during auto-tuning or when vector control characteristics are to be improved, independent motor constants can be set.

Title	Function	Adjustment range	Default setting
F400	Auto-tuning	0: Auto-tuning disabled (Use of internal parameters) 1: Application of individual settings of F401 ~ F405 2: Auto-tuning enabled (returns to "1" after auto-tuning)	0
F401	Slip frequency	0.0 ~ 10.0 (Hz)	*
F402	Motor primary constant	0 ~ 255	*
F403	Motor secondary constant	0 ~ 255	*
F404	Motor excitation constant	0 ~ 255	*
F405	Magnification of load inertia moment	0 ~ 200 (time)	0
F408	Rated capacity ratio of motor to inverter	0: Same capacity as inverter 1: One size smaller than inverter	0

* The default settings of the above parameters vary with capacity. See section 11.

Setting procedure

Adjust the following parameters:

- F400**: Select "1" to set the motor constant independently using the **F401** ~ **F405** parameters.
- F401**: Set the slip frequency for the motor. A higher slip frequency reduces motor slipping correspondingly. (The slip frequency can be set on the basis of test records of the motor.)
- F402**: Adjust the primary resistive component of the motor. Decreases in torque due to a possible voltage drop during low-speed operation can be suppressed by setting a large value in this parameter. (Perform adjustments according to the actual operation.)
- F403**: Adjust the secondary component of the motor. This parameter is enabled only when **F401** is set to "0". A larger adjustment value gives more slip correction. (Perform adjustments according to the actual operation.)
- F404**: Set the excitation inductance for the motor. A larger inductance creates a smaller no-load current. (Perform adjustments according to the actual operation.)
- F405**: Set a load inertia moment with a multiple of the motor inertia moment. A transient response can be adjusted. A larger adjustment value reduces inertial overshoot, and thus prevents the occurrence of an overcurrent and an overvoltage, correspondingly.
- F408**: Set "1" if the rated capacity of the motor is one size smaller than that of the inverter.
- * Sensorless vector control may not operate properly if the motor capacity differs from the applicable rated capacity of the inverter by more than two grades.

6.14 Acceleration/deceleration patterns and acceleration/deceleration 2

RCC	: Acceleration time 1
DEC	: Deceleration time 1
FSD0	: Acceleration time 2
FSD1	: Deceleration time 2
FSD2	: Acceleration/deceleration 1 pattern
FSD3	: Acceleration/deceleration 2 pattern
FSD4	: Acceleration/deceleration pattern selection (1 or 2)
FSD5	: Acceleration/deceleration 1 and 2 switching frequency

- Function
These parameters allow selection of the appropriate acceleration/deceleration pattern according to the particular needs.
Switching is also possible to the acceleration/deceleration pattern 2 using parameters, frequencies and external terminals.

Title	Function	Adjustment range	Default setting
RCC	Acceleration time 1	0.1 ~ 3600 (s)	10.0
DEC	Deceleration time 1	0.1 ~ 3600 (s)	10.0
FSD0	Acceleration time 2	0.1 ~ 3600 (s)	10.0
FSD1	Deceleration time 2	0.1 ~ 3600 (s)	10.0
FSD2	Acceleration/deceleration 1 pattern	0: Linear, 1: S-pattern 1, 2: S-pattern 2	0
FSD3	Acceleration/deceleration 2 pattern	0: Linear, 1: S-pattern 1, 2: S-pattern 2	0
FSD4	Acceleration/deceleration pattern selection (1 or 2)	0: Acceleration/deceleration 1, 1: Acceleration/deceleration 2	0
FSD5	Acceleration/deceleration 1 and 2 switching frequency	0 ~ 100 (Hz)	0.0

■ Acceleration/deceleration patterns

- 1) Linear acceleration/deceleration
A general acceleration/ deceleration pattern. This pattern can usually be used.

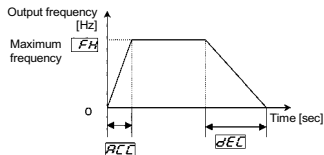

- 2) S-pattern acceleration/deceleration 1
Select this pattern to accelerate/decelerate the motor rapidly to a high-speed region with an output frequency of 60Hz or more or to minimize the shocks applied during acceleration/deceleration. This pattern is suitable for pneumatic transport machines.

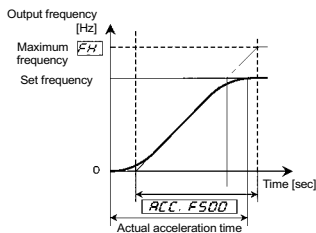

- 3) S-pattern acceleration/deceleration 2
Select this pattern to obtain slow acceleration in a demagnetizing region with a small motor acceleration torque. This pattern is suitable for high-speed spindle operation.

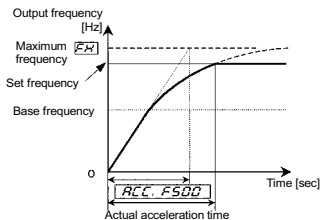

■ Switching to acceleration/deceleration

- 1) Selection using parameters

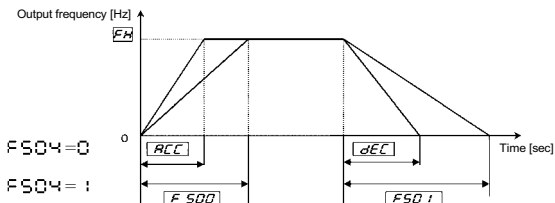

Acceleration/deceleration time 1 is initially set as the default. Acceleration/deceleration time 2 can be selected by changing the setting of the $F504$ parameter.

- 2) Switching by frequencies - Switching the acceleration/deceleration time automatically at the frequency setting of $F505$

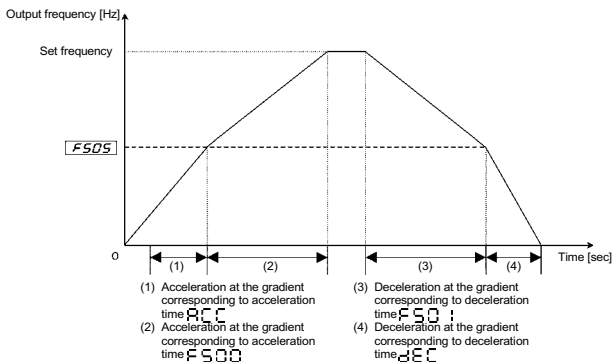

- 3) Switching using external terminals - Switching the acceleration/deceleration time via external terminals

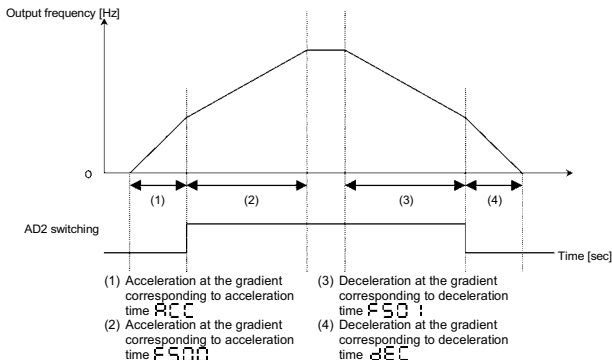

In this case, set " $CF03$ " to 0 (terminal board).

A switching signal for the acceleration/deceleration 2 is not set as the default.

Assign function number 5 ($R22$) to an idle terminal by specifying the input terminal function selection parameter.

6.15 Protection functions

6.15.1 Setting motor electronic thermal protection

F600: Motor electronic thermal protection level 1

- Function

This parameter allows selection of the appropriate electronic thermal protection characteristics according to the particular rating and characteristics of the motor.

The " CHR " parameter and extended parameter $F500$ have the same function. Modification of either parameter means that the same value is set for both parameters.

■ Parameter setting

Title	Function	Adjustment range	Default setting
CHR ($F500$)	Motor electronic thermal protection level 1	10 ~ 100 (%)	100

6.15.2 Setting current stall

F601 : Stall prevention level

- Function

This parameter reduces the output frequency by activating a current stall prevention function against a current exceeding the **F600** -specified level.

■ Parameter setting

Title	Function	Adjustment range	Default setting
F601	Stall prevention level	10 ~ 199 (%), 200: Disabled	150

[Display during an **OC** alarm status]

During an **OC** alarm status (that is, when there is a current flow in excess of the stall prevention level), the output frequency changes. At the same time, "C" is displayed flashing on and off.

Example of display

C SO

6.15.3 Inverter trip retention

F602 : Inverter trip retention selection

- Function

If the inverter trips, this parameter will retain the corresponding trip information. Trip information that has thus been stored into memory can be displayed, even after power has been reset.

[Parameter setting]

Title	Function	Adjustment range	Default setting
F602	Inverter trip retention selection	0: Not retained 1: Retained	0

★ Up to four sets of latest trip information displayed in status monitor mode can be stored into memory.

★ When power is turned back on, trip data in the status monitor mode (such as trip current and voltage) will not be stored.

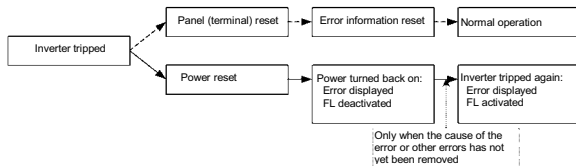

6.15.4 External input trip stop mode selection

F603 : External input trip stop mode selection

F604 : Emergency DC braking time

- Function

These parameters set the method of stopping the inverter in external trip stop mode. When the inverter is stopped, the trip detection function ("E" display) and the FL relay are activated. If **F603** is set to "2" (Emergency DC braking), also set **F251** (DC braking current) and **F604** (Emergency DC braking time).

1) External trip stop via terminals

The external trip stop function can be executed via the a-contact. Proceed as follows to assign an external stopping terminal and select the stopping method:

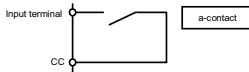

[Parameter setting]

Title	Function	Adjustment range	Default setting
F603	External input trip stop mode selection	0: Coast stop 1: Slowdown stop 2: Emergency DC braking	0
F604	Emergency DC braking time	0.0 ~ 20.0 (s)	1.0
F251	DC braking current	0 ~ 100 (%)	30

(Example of terminal assignment): Assigning the trip stop function to the RST terminal

Title	Function	Adjustment range	Setting
F113	Input terminal selection (RST)	0 ~ 51	11 (External trip stop)

Notes:

- Emergency stopping via the specified terminal is possible, even during panel operation.
- If **F603** is set to "2" (Emergency DC braking) and DC braking is not required for normal stopping, set the DC braking time (**F252**) to 0.0 (sec).

2) Emergency stopping from the operation panel

Emergency stopping from the operation panel is possible by pressing the STOP key on the panel twice while the inverter is not in the panel control mode.

- (1) Press the STOP key "E F F" will blink.
- (2) Press the STOP key once again Operation will come to a trip stop in accordance with the setting of the F603 parameter. After this, "E" will be displayed and a failure detection signal generated (FL relay deactivated).

6.15.5 Output phase failure detection

F605 : Output phase failure detection mode selection

- Function

This parameter detects inverter output Phase failure. If the Phase failure status persists for one second or more, the tripping function and the FL relay will be activated. At the same time, the trip information E P H will also be displayed.

Set F605 to "2" to control the opening of the inverter connection to the motor and connecting commercial power to the motor.

Detection errors may occur for special motors such as high-speed motors.

F605 = 0 (Disabled)

..... No tripping (FL relay deactivated).

F605 = 1 (Enabled during operation)

..... Phase failure detection is enabled during operation. The inverter will trip if the Phase failure status persists for one second or more. (FL relay activated.)

F605 = 2 (Enabled; Disabled during auto-restart)

..... This function, however, is disabled during auto-restart after momentary power failure. When phase failure detect decrease the output voltage, and restart.

Title	Function	Adjustment range	Default setting
F605	Output phase failure detection mode selection	0: Disabled 1: Enabled (during operation) 2: Enabled (Disabled during auto-restart)	0

6.15.6 Input phase failure detection

F603 : Input phase failure detection mode selection

- Function

This parameter detects inverter input Phase failure. If the abnormal voltage status of main circuit capacitor persists for few minutes or more, the tripping function and the FL relay will be activated. At the same time, the trip information **EPH** will also be displayed.

If the power capacity is larger than the inverter capacity (more than 200kVA or more than 10 times), detection errors may occur. If this actually happens, install an AC or DC reactor.

F603 = 0 (Disabled)..... No tripping (FL relay deactivated).

F603 = 1 (Enabled)..... Phase failure detection is enabled during operation. The inverter will trip if the abnormal voltage status of main circuit capacitor persists for ten minutes or more. (FL relay activated.)

Title	Function	Adjustment range	Default setting
F603	Input phase failure detection mode selection	0: Disabled, 1: Enabled	1

6

6.15.7 Control mode for small current

F610 : Small current trip selection

F611 : Small current (trip/alarm) detection current

F612 : Small current (trip/alarm) detection time

- Function

The **F610** parameter allows the inverter to be tripped if a current smaller than the

F611 -specified value flows for more than the **F612** -specified time. When tripping is selected, enter the detection time to tripping. Trip information is displayed as **UC**.

F610 = 0 (OFF)..... No tripping (FL relay deactivated).

A small current alarm can be put out by setting the output terminal function selection parameter.

F610 = 1 (ON)..... The inverter is tripped (FL relay activated) only after a small current has been detected for more than the **F612** -specified time during operation.

Title	Function	Adjustment range	Default setting
F6 10	Small current trip selection	0: Disabled 1: Enabled	0
F6 11	Small current (trip/alarm) detection current	0 ~ 100 (%)	0
F6 12	Small current (trip/alarm) detection time	0 ~ 255 (s)	0

6.15.8 Over-torque trip

F6 15 : Over-torque trip selection

F6 16 : Over-torque (trip/alarm) level

F6 18 : Over-torque (trip/alarm) detection time

F6 19 : Over-torque (trip/alarm) level hysteresis

- Function

Use the **F6 15** parameter to trip the inverter if a torque current exceeding the **F6 16**-specified level flows for more than the **F6 18**-specified time. Trip information is displayed as "O_t".

F6 15 = 0 (No trip)..... No tripping (FL relay deactivated).

An overtorque alarm can be put out to the output terminal by setting the output terminal function selection parameter.

F6 15 = 1 (Trip)..... The inverter is tripped (FL relay activated) only after a torque current exceeding the **F6 16**-specified level has been detected for more than the **F6 18**-specified time.

Title	Function	Adjustment range	Default setting
F6 15	Over-torque trip selection	0: Disabled 1: Enabled	0
F6 16	Over-torque (trip/alarm) level	0 ~ 250 (%)	150
F6 18	Over-torque (trip/alarm) detection time	0.00 ~ 10.0 (s)	0.5
F6 19	Over-torque (trip/alarm) level hysteresis	0 ~ 100 (%)	10

6.15.9 Undervoltage trip

F627 : Undervoltage trip selection

- Function

This parameter is used for selecting the control mode when an undervoltage is detected. Trip information is displayed as "UP!".

F627 = 0 (Disabled).....The inverter is stopped. However, it is not tripped (FL relay deactivated).

The inverter is stopped when the voltage does not exceed 70% or less of its rating.

F627 = 1 (Enabled).....The inverter is stopped. It is also tripped (FL relay activated), only after detection of a voltage not exceeding 70% or less of its rating.

F627 = 2 (Disabled).....The inverter is stopped. However, it is not tripped (FL relay deactivated).

The inverter stop (FL relay deactivated), only after detection of a voltage not exceeding 50% of its rating.

An input AC reactor must be used. See 10.4.

Title	Function	Adjustment range	Default setting
F627	Undervoltage trip selection	0: Disabled 1: Enabled (Trip at 70% or less) 2: Disabled (Stop(not trip) at 50% or less, optional)	0

6.15.10 4-20mA dc calibration

F692 : Meter bias

- Function

Output signals from FM terminals are analog voltage signals. Their standard setting range is from 0 to 1mAdc or from 0 to 7.5Vdc.

These standard setting ranges can be switched to 0-20mAdc by changing the position of the required jumper pin (JP302) in the inverter main unit. Calibration for 4-20mA dc output is possible by setting this parameter.

Title	Function	Adjustment range	Default setting
F692	Meter bias	0 ~ 50 (%)	0

Note: Use the jumper pin (JP302) to select FMC (0-20mA dc (4-20mA dc)) output.

■ Examples of setting

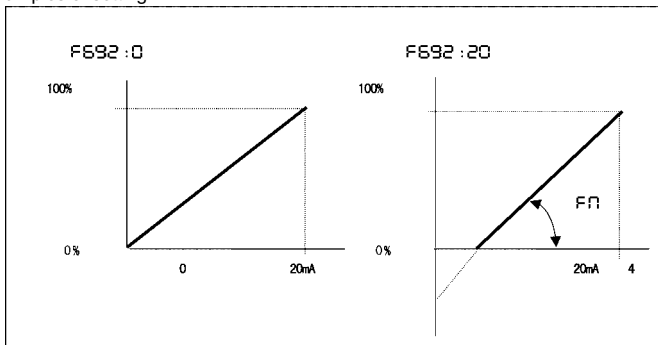

6

6.16 Operation panel parameter

6.16.1 Prohibition of change of parameter settings

F700 : Prohibition of change of parameter settings

• Function

This parameter specifies whether parameter setting is changeable or not.

■ Setting methods

- : Permitted _____ Modification of $Cn0d$ and $Fn0d$ during operation is prohibited (default setting).
Modification of $Ru2, Ru3, Ru4, Fh, P\&Yp, F307, F400, F408$ during operation is also prohibited.
- : Prohibited _____ All parameter read/write operations are prohibited.
- 2 : Permitted _____ Modification of $Cn0d, Fn0d$ during operation is enabled. Modification of $Ru2, Ru3, Ru4, Fh, P\&Yp, F307, F400, F408$ during operation, however, is prohibited.

[Parameter setting]			
Title	Function	Adjustment range	Default setting
F700	Prohibition of change of parameter settings	0: Permitted C n O d , F n O d cannot be modified during operation) 1: Prohibited 2: Permitted (C n O d , F n O d can be modified during operation)	0

■ Resetting method

Only the F700 parameter is designed so that its setting can be modified even if "1" (prohibited) is selected.

6.16.2 Changing the display unit to A/V/min⁻¹

F701 : Unit selection

F702 : Free unit selection

• Function

These parameters are used to change the unit of monitor display.

% ↔ A (ampere)/V (volt)

Frequency ↔ Motor speed or load speed

■ Parameter setting

Title	Function	Adjustment range	Default setting
F701	Unit selection	0: No change 1: % → A (ampere)/V (volt) 2: Free unit selection enabled (F702) 3: % → A (ampere)/V (volt) Free unit selection enabled (F702)	0
F702	Free unit selection	0.01 ~ 200.0	1.00

■ An example of setting for changing voltage/current percentage display to V/A unit display

Set F701 to either "1" or "3".

During the operation of the VFS9-2037PM (rated current: 17.5A) at the rated load (100% load), units are displayed as follows:

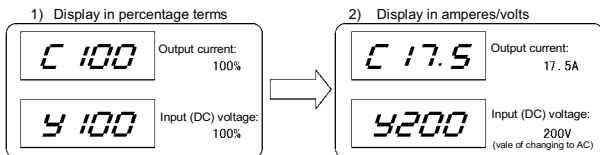

■ An example of setting for displaying the motor speed or load speed

Set F702 to either "2" or "3".

The value obtained by multiplying the displayed frequency by the F702-set value will be displayed as follows:

$$\text{Value displayed} = \text{Monitor-displayed or parameter-set frequency} \times \text{F702}$$

1) Displaying the motor speed

To switch the display mode from 60Hz (default setting) to 1800min-1 (the rotating speed of the 4P motor)

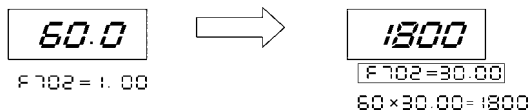

2) Displaying the speed of the loading unit

To switch the display mode from 60Hz (default setting) to 6m/min-1 (the speed of the conveyer)

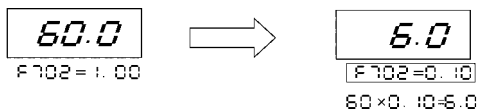

Note: This parameter displays the inverter output frequency as the value obtained by multiplying it by a positive number. Even when the actual speed of the motor changes according to the particular changes in load, the output frequency will always be displayed.

6.17 Communication function (Common serial)

F800 : Data transfer speed

F801 : Parity

F802 : Inverter number

F803 : Communication error trip time

Refer to the COMMUNICATIONS EQUIPMENT USER'S MANUAL for details.

- Function

The VFS9 Series allows a data communication network to be constructed for exchanging data between a host computer or controller (referred to collectively as the computer) and the inverter by connecting an optional RS232C or RS485 communication conversion unit.

<Computer-linking functions>

The following functions are enabled by data communication between the computer and inverter

- (1) Monitoring inverter status (such as the output frequency, current, and voltage)
- (2) Sending RUN, STOP and other control commands to the inverter
- (3) Reading, editing and writing inverter parameter settings

<RS232C communication>

Data can be exchanged between one computer and one inverter.

<RS485 communication>

Data can be exchanged between the computer and a maximum of 64 inverters.

☆ The following are available as common serial optional units:

- RS232C communications conversion unit (Model: RS2001Z)
Communications cable (Model: CAB0011, 1m long; CAB0013, 3m long; or CAB0015, 5m long)
- RS485 communication conversion unit with terminal board (Model: RS4001Z, RS4002Z)
Communication cable (Model: CAB0011, 1m long; CAB0013, 3m long; or CAB0015, 5m long)

Note 1.: Limit the distance between the common serial optional units and the inverter to 5m.

- 2.: Set Data transfer speed to 9600 bps or less if data exchange between the common serial optional units and the inverter.

■ Communication function parameters (Common serial options)

The data transfer speed, parity type, inverter number, and communication error trip time can be set/edited by operation panel operation or communication function.

Title	Function	Adjustment range	Default setting
F800	Data transfer speed	0: 1200bps 1: 2400bps 2: 4800bps 3: 9600bps 4: 19200bps	3
F801	Parity (Common serial)	0: NON (No parity) 1: EVEN (Even parity) 2: ODD (Odd parity)	1
F802	Inverter number	0 ~ 63	0
F803	Communication error trip time	0: Disabled * 1 ~ 100 (s)	0

* Disabled Indicates that the inverter will not be tripped even if a communication error occurs.

Trip The inverter trips when a communication time-over occurs. In this case a trip information "E r S" flashes on and off on the operation panel.

6.17.2 Using the RS232C/RS485

6

■ Setting the communication functions

Setting commands and frequencies by communications has priority over sending commands from the operation panel or the terminal board. Command/frequency setting by communications can therefore be enabled, irrespective of the setting in the command mode (C r d) or the frequency setting mode (F r d). However, when the input terminal function selection parameter is set to 48: SC/LC (Serial/Local selection), the inverter can be operated with the settings of the command mode (C r d) or the frequency setting mode (F r d) by external input.

■ Transmission specifications

Item	Specifications
Transmission scheme	Half-duplex
Connection scheme	Centralized control
Synchronization scheme	Asynchronous
Transmission rate	Default: 9600 baud (parameter setting) Option: Either 1200, 2400, 4800, 9600, or 19200 baud
Character transmission	ASCII code: JIS X 0201, 8-bit (fixed) Binary code: Binary, 8-bit (fixed)
Stop bit length	Inverter receiving: 1 bit, Inverter sending: 2 bits
Error detection	Parity: Even, Odd, or None selectable by parameter setting; check sum method
Character transmission format	Receiving: 11-bit, Sending: 12-bit
Order of bit transmission	Least significant bit first
Frame length	Variable to a maximum of 15 bytes

■ Example of connection for RS485-communication

<Example of connection>

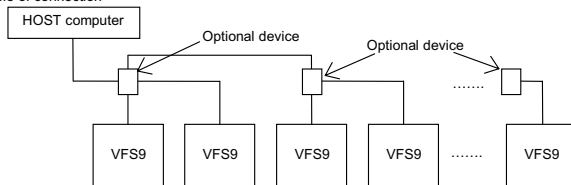

<Independent communication>

Perform computer-inverter connection as follows to send operation frequency commands from the host computer to inverter No. 3:

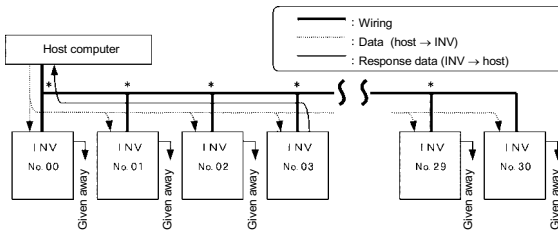

"Given away": Only the inverter with the selected inverter number conducts data processing. All other inverters, even if they have received the data, give it away and stand by to receive the next data.

* : Use the terminal board to branch the cable.

- (1) Data is sent from the host computer.
- (2) Data from the computer is received at each inverter and the inverter numbers are checked.
- (3) The command is decoded and processed only by the inverter with the selected inverter number.
- (4) The selected inverter responds by sending the processing results, together with its own inverter number, to the host computer.
- (5) As a result, only the selected inverter starts operating in accordance with the operation frequency command by communicating independently.

6

7. Applied operation

7.1 Setting the operation frequency

Applied operation can be performed by selecting the inverter frequency setting, using the basic parameter **F₀₀** (frequency setting mode selection) and the extended parameter **F₂₀** (frequency priority selection).

(1) Internal potentiometer setting

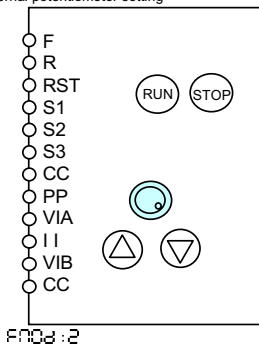

(2) Operation panel key setting

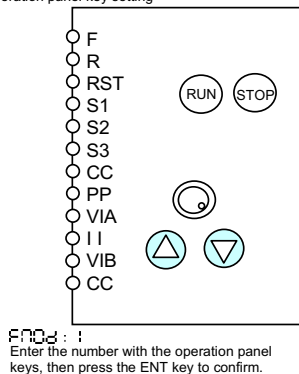

(3) External potentiometer setting

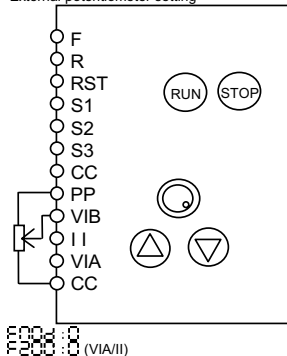

(4) Input voltage setting(0 to 10 Vdc)

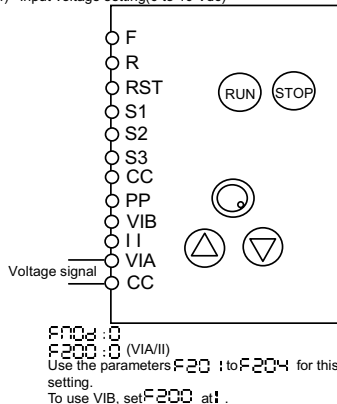

(5) Input current setting(4 to 20 mAcd)

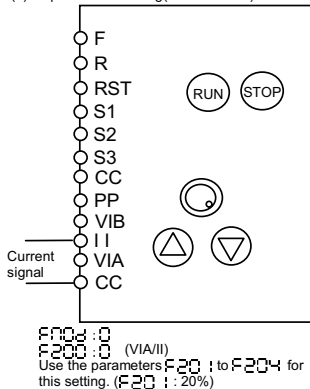

(6) External contact UP/DOWN

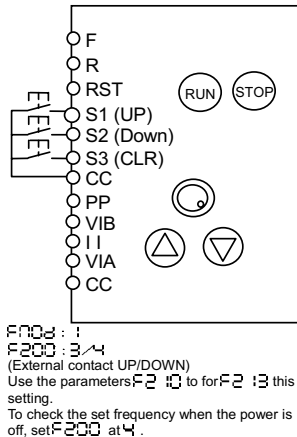

(7) Preset-speed setting

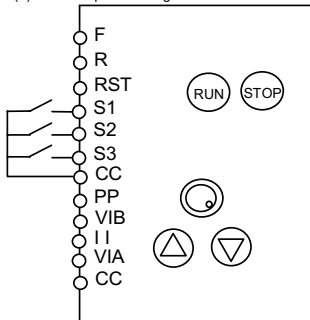

S₁ to S₃: 7-speed run
 F237 to F234: 8-speed run
 To select 7-speed run, use the terminals S1 to S3.
 To select 15-speed run, add the terminal S4.

(8) Voltage/current switching

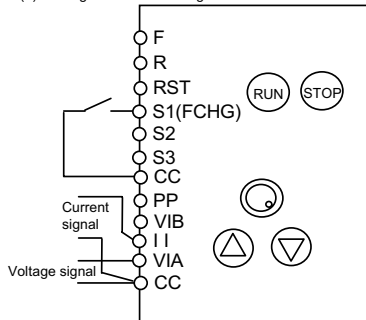

F200:0/1
 (Automatic switching)
 F200:2
 (Forced switching of FCHG. Enter "38" as the S1 terminal function selection. ON: VIB, OFF:VIA/I1)

(9) Analog addition setting

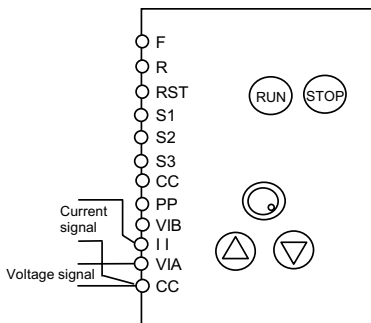

F200:5
 (VIA/I1+VIB)

(10) Switching between external contact UP/DOWN and VIA input

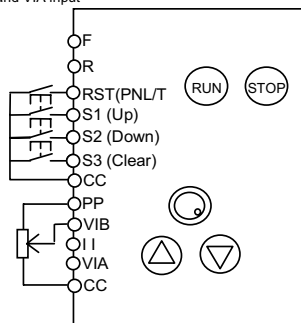

F200:1
 F200:3/4
 To switch to VIA/I1 setting, use the external PNL/TB.
 Operation panel key operation is enabled when the external contact UP/DOWN is disabled.

(11) Switching between analog setting and preset-speed setting

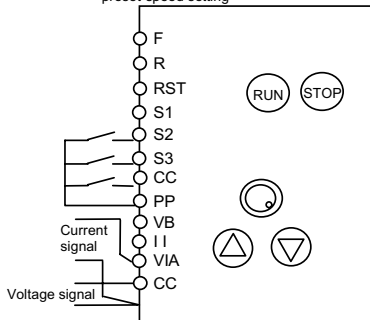

To switch to preset-speed setting, use the external terminals S1 to S4.

(12) Switching between analog setting and terminal setting from the operation panel

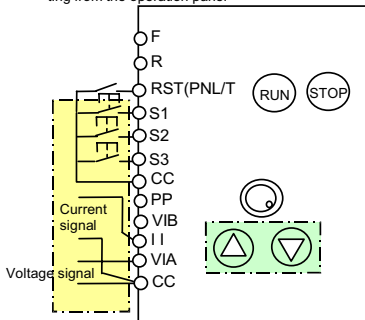

PNL/T :
To switch to VIA/I1 or VIB setting, use the external PNL/TB.

(13) Setting by means of a remote input device

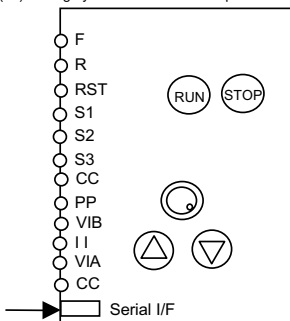

Priority is given to the remote input device when the remote command fa00h 14-bit is set at 1.

(14) Switching between remote control and local control

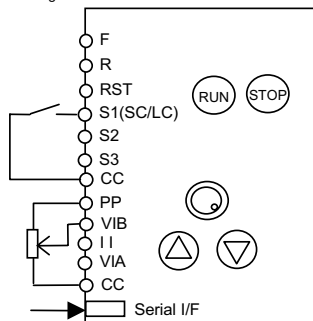

Remote control can be switched forcefully to local control from the external SC/LC by setting the remote command fa00h 14-bit at 1. The operation is controlled in accordance with the PNL/TB setting.

7.2 Setting the operation mode

Applied operation can be performed by selecting the operation mode. To set the operation mode, use the basic parameter $\square\square\square\square$ (command mode selection) and the input terminal selection parameter.

(1) Operation panel operation

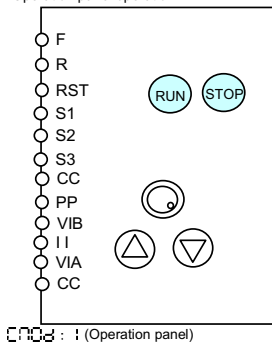

(2) Terminal board operation

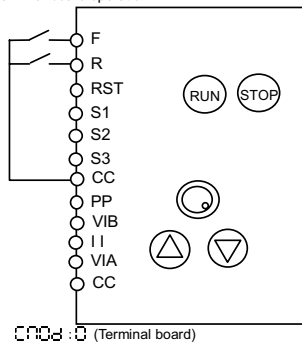

(3) Three-wire operation /
Self-holding of operation signal

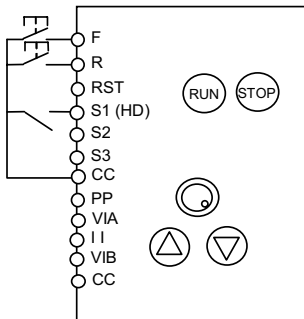

Note 1 : In case of three - wire operation, F and R set to HD and S1 set to HD.

Select one input terminal, and set to HD (operation holding).

Ex. F ; S1 (S1 terminal) set to HD.

Note 2 : Enable to turn the input terminal on at power on.

Note 3 : Enable to turn the terminal F and R on at HD : on.

Note 4 : If select Jog run command during three-wire operation, inverter stop.

Selecting HD (operation holding) with the input terminal selection parameter
Enable to run at HD : ON
Stop at HD : OFF

Output frequency

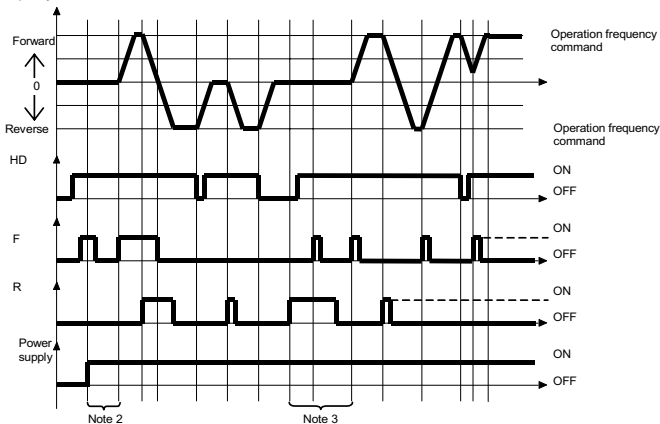

- (4) Operation from an external input device

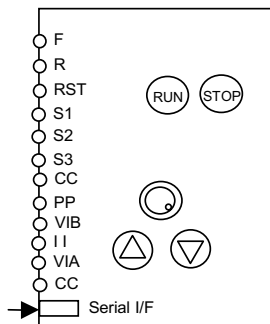

Priority is given to an external input device when the remote command fa00h 15-bit is set at 1.

- (5) Switching from an external input device to the terminal board

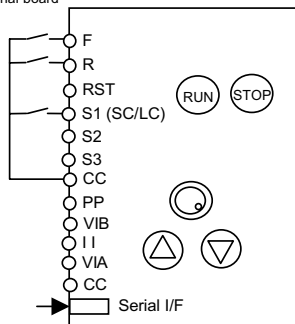

Remote control can be switched forcefully to local control from the external SC/LC by setting the remote command fa00h 15-bit at 1. Operation is controlled from the terminal board.

- (6) Switching from the operation panel to the terminal board

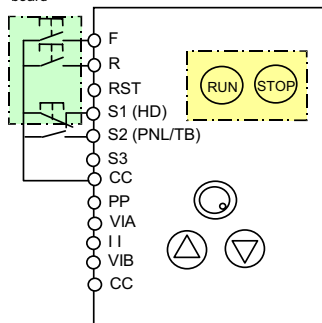

To switch to terminal board operation, use the external PNL/TB.

8. Monitoring the operation status

8.1 Status monitor mode

In this mode, you can monitor the operation status of the inverter.

To display the operation status during normal operation:

Press the **(MON)** key twice.

Setting procedure (eg. operation at 60Hz)

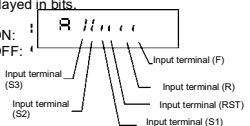
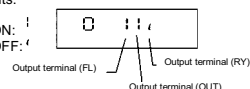
	Item displayed	Key operated	LED display	Communication No.	Description
Note 1			60.0		The operation frequency is displayed (during operation). (When the standard monitor display selection parameter F 7 ! 0 is set at 0 [operation frequency])
	Parameter setting mode	(MON)	RU !		The first basic parameter "Automatic acceleration/deceleration (R 1 !)" is displayed.
	Operation frequency	(MON)	F 60.0	FE00	The operation frequency is displayed (during operation).
	Direction of rotation	(▲)	F - - F	FE01	The direction of rotation is displayed. (F : forward run, - : reverse run)
	Operation frequency command	(▲)	F 60.0	FE02	The operation frequency command value is displayed.
Note 2	Load current	(▲)	C 8.0	FE03	The inverter output current (load current) is displayed. (Default setting : unit %)
Note 3	Input (DC) voltage	(▲)	U ! 0.0	FE04	The inverter input (DC) voltage is displayed. (Default setting: unit %)
	Output voltage	(▲)	P ! 0.0	FE05	The inverter output voltage is displayed. (Default setting: unit %)
	Input terminal	(▲)	R ! ! ! ! !	FE06	The ON/OFF status of each of the control signal input terminals (F, R, RST, S1, S2 and S3) is displayed in bits. 
	Output terminal	(▲)	C ! ! !	FE07	The ON/OFF status of each of the control signal output terminals (RY, OUT and FL) is displayed in bits. 

(Continued overleaf)

(Continued)

	Item displayed	Key operated	LED display	Communication No.	Description
	CPU version	▲	u !0 !	FE08	The version of the CPU is displayed.
	Memory version	▲	uE !00	FE09	The version of the memory mounted is displayed.
Note 4	Past trip 1	▲	0C3 ⇄ !	FE10	Past trip 1 (displayed alternately at 0.5-sec. intervals)
Note 4	Past trip 2	▲	0H ⇄ 2	FE11	Past trip 2 (displayed alternately at 0.5-sec. intervals)
Note 4	Past trip 3	▲	0P3 ⇄ 3	FE12	Past trip 3 (displayed alternately at 0.5-sec. intervals)
Note 4	Past trip 4	▲	0E r r ⇄ 4	FE13	Past trip 4 (displayed alternately at 0.5-sec. intervals)
Note 5	Cumulative operation time	▲	t 0 !0	FE14	The cumulative operation time is displayed. (0.01 corresponds to 1 hours.)
	Torque current	▲	t 80	FE20	The torque current is displayed in %.
	PI feedback	▲	d 50	FE22	The PI feedback value is displayed. (Unit: processed amount)
	Inverter load factor	▲	L 80	FE26	The inverter load factor is displayed in %.
	PBR overload factor	▲	r 80	FE28	The overload factor of the braking resistor is displayed in %.
	Output power	▲	H 3.7	FE30	The inverter output power is displayed in %.
	Default display mode	(MON)	500		The operation frequency is displayed (during operation).

Note 1: Press the ▲ or ▼ key to change items displayed in the status monitor mode.

Note 2: With the current unit selection parameter or voltage unit selection parameter, you can choose between percentage and ampere (A) for current or between percentage and volt (V) for voltage, respectively.

Note 3: The input (DC) voltage displayed is $1/\sqrt{2}$ times as large as the rectified d.c. input voltage.

Note 4: 0E r r is displayed to show the absence of error.

Note 5: The cumulative operation time increments only when the machine is in operation.

8.2 Display of trip information

If the inverter trips, an error code is displayed to suggest the cause. In the status monitor mode, all trip records are retained.

■ Display of trip information



Error code	Communication No.	Description
Err (*)	0000	No error
OC1	0001	Overcurrent during acceleration
OC2	0002	Overcurrent during deceleration
OC3	0003	Overcurrent during operation
OCL	0004	Load-side overcurrent during start-up
OCR	0005	Armature-side overcurrent during start-up
EPH1	0008	Input phase failure
EPHO	0009	Output phase failure
OP1	000A	Overvoltage during acceleration
OP2	000B	Overvoltage during deceleration
OP3	000C	Overvoltage during constant-speed operation
OL1	000D	Inverter overload trip
OL2	000E	Motor overload trip
OLr	000F	Dynamic braking register overload trip
OH	0010	Overheat trip
E	0011	Emergency stop
EEP1	0012	E ² PROM fault
Err2	0015	Inverter RAM fault
Err3	0016	Inverter ROM fault
Err4	0017	CPU fault trip
Err5	0018	Communication error
UC	001D	Small-current trip
UP1	001E	Undervoltage trip
Ot	0020	Over-torque trip
EF2	0022	Ground fault
Etn	0028	Auto-tuning error
EtsP	0029	Inverter type error

Error code	Communication No.	Description
OP2	002E	External thermal input

(Note) Past trip records (trip records retained or trips that occurred in the past) can be called up. (Refer to 8.1 "Status monitor mode" for the call-up procedure.)

(*) Strictly speaking, this code is not an error code; this code is displayed to show the absence of error when the past trip monitor mode is selected.

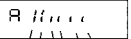
Example of call-up of trip information

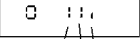
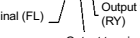
Item displayed	Key operated	LED display	Communication No.	Description
		OP2		Status monitor mode (The code blinks if a trip occurs.) The motor coasts and comes to a stop (coast stop).
Parameter setting mode	(MON)	RU :		The first basic parameter "Automatic acceleration/deceleration (RU :)" is displayed.
Operation frequency	(MON)	F 600	FE00	The operation frequency at the occurrence of a trip is displayed.
Direction of rotation	(▲)	F r -F	FE01	The direction of rotation at the occurrence of a trip is displayed. (F : forward run, r : reverse run)
Operation frequency command	(▲)	F 600	FE02	The operation frequency command value at the occurrence of a trip is displayed.
Load current	(▲)	C :30	FE03	The inverter output current at the occurrence of a trip is displayed. (Default setting: unit %)
Input (DC) voltage	(▲)	U :4 :	FE04	The inverter input (DC) voltage at the occurrence of a trip is displayed. (Default setting: unit %)
Output voltage	(▲)	P :00	FE05	The inverter output voltage at the occurrence of a trip is displayed. (Default setting: unit %)
Input terminal	(▲)	R !!!!!	FE06	The ON/OFF status of each of the control signal input terminals (F, R, RST, S1, S2 and S3) at the occurrence of a trip is displayed in bits. ON:  OFF:  Input terminal (S3) Input terminal (S2) Input terminal (R) Input terminal (RST) Input terminal (S1)
Output terminal	(▲)	0 : : :	FE07	The ON/OFF status of each of the control signal output terminals (RY, OUT and FL) at the occurrence of a trip is displayed in bits. ON:  OFF:  Output terminal (FL) Output terminal (RY) Output terminal (OUT)
CPU version	(▲)	v !00	FE08	The version of the CPU is displayed.

(Continued overleaf)

(Continued)

Item displayed	Key operated	LED display	Communication No.	Description
Memory version	▲	JE 100	FE09	The version of the memory mounted is displayed.
Past trip 1	▲	OP2 ⇄ 1	FE10	Past trip 1 (displayed alternately at 0.5-sec. intervals)
Past trip 2	▲	OP ⇄ 2	FE11	Past trip 2 (displayed alternately at 0.5-sec. intervals)
Past trip 3	▲	OP3 ⇄ 3	FE12	Past trip 3 (displayed alternately at 0.5-sec. intervals)
Past trip 4	▲	OP4 ⇄ 4	FE13	Past trip 4 (displayed alternately at 0.5-sec. intervals)
Cumulative operation time	▲	t 0.1	FE14	Cumulative operation time (0.01 corresponds to 1 hours.)
Torque current	▲	t 80	FE20	The torque current at the occurrence of a trip is displayed in %.
PI feedback	▲	d 50	FE22	The PI feedback value at the occurrence of a trip is displayed. (Unit: frequency)
Load factor	▲	L 80	FE26	The inverter load factor is displayed in %.
PBR overload factor	▲	r 80	FE28	The overload factor of the braking resistor at the occurrence of a trip is displayed in %.
Output power	▲	H 3.7	FE30	The output power of the inverter at the occurrence of a trip is displayed in %.
Default display mode	(MON) × 2	OP2		The cause of the trip is displayed.

Note 1: Press the ▲ or ▼ key to change items displayed in the status monitor mode.

Note 2: If trouble occurs while the CPU is being initialized after the inverter is turned on or reset, the trip recording retaining function does not record it but displays a status monitor item.

9. Taking measures to satisfy the CE/UL directive

9.1 How to cope with the CE directive

In Europe, the EMC directive and the low-voltage directive, which took effect in 1996 and 1997, respectively, make it obligatory to put the CE mark on every applicable product to prove that it complies with the directives. Inverters do not work alone but are designed to be installed in a control panel and always used in combination with other machines or systems which control them, so they themselves are not considered to be subject to the EMC directive.

However, the CE mark must be put on all inverters because they are subject to the low-voltage directive.

The CE mark must be put on all machines and systems with built-in inverters because such machines and systems are subject to the above directives. If they are "final" products, they might also be subject to machine-related directives. It is the responsibility of the manufacturers of such final products to put the CE mark on each one. In order to make machines and systems with built-in inverters compliant with the EMC directive and the low-voltage directive, this section explains how to install inverters and what measures should be taken to satisfy the EMC directive.

We have tested representative models with them installed as described later in this manual to check for conformity with the EMC directive. However, we cannot check all inverters for conformity because whether or not they conform to the EMC directive depends on how they are installed and connected. In other words, the application of the EMC directive varies depending on the composition of the control panel with a built-in inverter(s), the relationship with other built-in electrical components, the wiring condition, the layout condition, and so on. Therefore, please verify yourself whether your machine or system conforms to the EMC directive.

9.1.1 About the EMC directive

The CE mark must be put on every final product that includes an inverter(s) and a motor(s). The VF-S9 series of inverters complies with the EMC directive if an EMI filter recommended by Toshiba is connected to it and wiring is carried out correctly.

- EMC directive 89/336/EEC

The EMC standards are broadly divided into two categories; immunity- and emission-related standards, each of which is further categorized according to the operating environment of each individual machine. Since inverters are intended for use with industrial systems under industrial environments, they fall within the EMC categories listed in Table 1 below. The tests required for machines and systems as final products are almost the same as those required for inverters.

Table 1 EMC standards

Category	Subcategory	General standard	Test standard and level
Emission	Radiation noise	EN50081-2	EN 55011, Group 1, Class A
	Transmission noise		EN 55011, Group 1, Class A
Immunity	Static discharge	EN50082-2	EN 61000-4-2
	Radioactive radio-frequency magnetic contactor field		EN 61000-4-3
	First transient burst		EN 61000-4-4
	Lightning surge		IEC 1000-4-5
	Radio-frequency induction/transmission interference		IEC 1000-4-6

Emission standards other than the above are applied to inverters when used in a commercial environment but not an industrial environment.

Category	Subcategory	General standard	Test standard and level
Emission	Radiation noise	EN50081-2	EN 55011, Group 1, Class B
	Transmission noise		EN 55011, Group 1, Class B

9.1.2 Measures to satisfy the EMC directive

This subsection explains what measures must be taken to satisfy the EMC directive.

- (1) Insert a recommended EMI filter (Table 2) on the input side of the inverter to reduce radiation and transmission noises. In the combinations listed in Table 2, inverters were checked for conformity with the EMC directive. For inverters used in Japan, it is recommended to use the NF series of noise filters.

Table 2 lists noise filters recommended for the inverters.

* Dimensions of EMI filter : See 10.4 (Page J-11)

Table 2 Combinations of inverter and EMI filter

Three-phase 200V class			Three-phase 400V class		
Inverter	Combination of inverter and filter		Inverter	Combination of inverter and filter	
	Filter for class A compliance	Filter for class B compliance		Filter for class A compliance	Filter for class B compliance
VFS9-2002PM	EMF2011BZ	-	VFS9-4007PL	With a built-in filter	EMF4006CZ
VFS9-2004PM	EMF2011BZ	-	VFS9-4015PL	With a built-in filter	EMF4006CZ
VFS9-2007PM	EMF2011BZ	-	VFS9-4022PL	With a built-in filter	EMF4022DZ
VFS9-2015PM	EMF2011BZ	-	VFS9-4037PL	With a built-in filter	EMF4022DZ
VFS9-2022PM	EMF4022DZ	-	VFS9-4055PL	With a built-in filter	EMF4045EZ
VFS9-2037PM	EMF4022DZ	-	VFS9-4075PL	With a built-in filter	EMF4045EZ
VFS9-2055PL	With a built-in filter	EMF4045EZ	VFS9-4110PL	With a built-in filter	EMF4045FZ
VFS9-2075PL	With a built-in filter	EMF4045EZ	VFS9-4150PL	With a built-in filter	EMF4045FZ
VFS9-2110PM *	EMF2080GZ	-			
VFS9-2150PM *	EMF2080GZ	-			

* Wire grounding wire between the EMI filter and EMC plate in order to conform to class A.

Wire size : 6mm² or more (AWG 9 or more)

Wire length : 29cm or less

Single-phase 200V class

Combination of inverter and filter		
Inverter	Filter for class A compliance	Filter for class B compliance
VFS9S-2002PL	With a built-in filter	EMFS2010AZ
VFS9S-2004PL	With a built-in filter	EMFS2010AZ
VFS9S-2007PL	With a built-in filter	EMFS2010AZ
VFS9S-2015PL	With a built-in filter	EMFS2016CZ
VFS9S-2022PL	With a built-in filter	EMFS2025DZ

- (2) Use shielded cables for the power and control cables, including filter input cables and inverter output cables. Route the cables and wires so as to minimize their lengths. Keep a distance between the power cable and the control cable and between the input and output wires of the power cable. Do not route them in parallel or bind them together, instead cross at right angle.
- (3) Install the inverter and the filter on the same metal plate. It is more effective in limiting the radiation noise to install the inverter in a sealed steel cabinet. Using wires as thick and short as possible, earth the metal plate and the control panel securely with a distance kept between the earth cable and the power cable.
- (4) Route the EMI filter input and output wires apart from each other.
- (5) To limit the radiation noise from cables, earth each shielded cable to the metal plate. It is effective to earth shielded cables in the vicinity of the inverter, cabinet and filter (within a radius of 10cm from each of them). Inserting a ferrite core in a shielded cable is even more effective in limiting the radiation noise.
- (6) To further limit the radiation noise, insert a zero-phase reactor in the inverter output line and insert ferrite cores in the earth cables of the metal plate and cabinet.

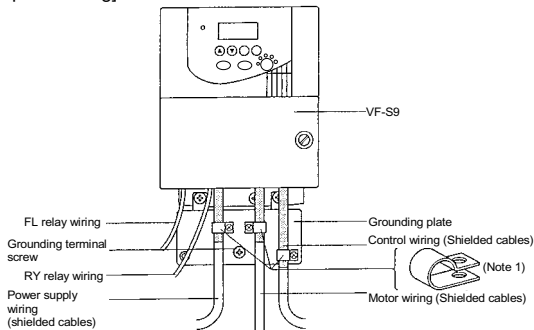
[Example of wiring]

Note 1: Strip and earth the shielded cable, following the example shown in Fig.

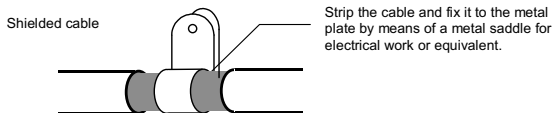

9.1.3 About the low-voltage directive

The low-voltage directive provides for the safety of machines and systems. All Toshiba inverters are CE-marked in accordance with the standard EN 50178 specified by the low-voltage directive, and can therefore be installed in machines or systems and imported without problem to European countries.

Applicable standard: EN 50178

Electronic equipment for use in power installations

Pollution level: 2 (5.2.15.2)

Overvoltage category: 3

200V class - 3.0mm (5.2.16.1)

400V class - 5.5mm (5.2.16.1)



EN 50178 applies to electrical equipment intended specially for use in power installations, and sets out the conditions to be observed for electric shock prevention when designing, testing, manufacturing and installing electronic equipment for use in power installations.

9.1.4 Measures to satisfy the low-voltage directive

When incorporating the inverter into a machine or system, it is necessary to take the following measures so that the inverter satisfies the low-voltage directive.

- (1) When installing the inverter outside the cabinet, provide a protective means for the inverter's wiring hole to prevent workers from putting their fingers through the hole and touching an electrically-charged part in the inverter.
- (2) Do not connect two or more wires to the main circuit earth terminal of the inverter. If necessary, install an additional earth terminal on the metal plate on which the inverter is installed and connect another cable to it. Or install the EMC plate (attached as standard) and another cable connect to earth terminal on the EMC plate. Refer to the table 10.1 for earth cable sizes.
- (3) Install a non-fuse circuit breaker on the input side of the inverter.

10. Peripheral devices

 Danger	
 Danger Mandatory	<ul style="list-style-type: none"> When using switchgear for the inverter, it must be installed in a cabinet. Failure to do so can lead to risk of electric shock and can result in death or serious injury.
 Be Grounded	<ul style="list-style-type: none"> Connect earth cables securely. Failure to do so can lead to risk of electric shock or fire in case of a failure, short-circuit or leak current.

10.1 Selection of wiring materials and devices

Voltage class	Capacity of applicable motor (kW)	Inverter model	Wire size			
			Main circuit (mm ²) (See Note 1.)	DC reactor (optional) (mm ²)	Braking resistor/Braking unit (optional) (mm ²)	Grounding cable (mm ²)
Single-phase 200V class	0.2	VFSSS-2002PL	2.0	1.25	1.25	3.5
	0.4	VFSSS-2004PL	2.0	1.25	1.25	3.5
	0.75	VFSSS-2007PL	2.0	2.0	1.25	3.5
	1.5	VFSSS-2015PL	3.5	2.0	1.25	3.5
	2.2	VFSSS-2022PL	5.5	2.0	2.0	5.5
Three-phase 200V class	0.2	VFSS-2002PM	2.0	1.25	1.25	3.5
	0.4	VFSS-2004PM	2.0	1.25	1.25	3.5
	0.75	VFSS-2007PM	2.0	2.0	1.25	3.5
	1.5	VFSS-2015PM	2.0	2.0	1.25	3.5
	2.2	VFSS-2022PM	2.0	2.0	2.0	3.5
	3.7	VFSS-2037PM	3.5	5.5	5.5	3.5
	5.5	VFSS-2055PL	8.0	5.5	5.5	8.0
	7.5	VFSS-2075PL	14	14	5.5	14
	11	VFSS-2110PM	14	14	5.5	14
	15	VFSS-2150PM	22	22	5.5	22
Three-phase 400V class	0.75	VFSS-4007PL	2.0	1.25	1.25	3.5
	1.5	VFSS-4015PL	2.0	1.25	1.25	3.5
	2.2	VFSS-4022PL	2.0	2.0	1.25	3.5
	3.7	VFSS-4037PL	2.0	2.0	1.25	3.5
	5.5	VFSS-4055PL	3.5	2.0	2.0	3.5
	7.5	VFSS-4075PL	3.5	3.5	2.0	5.5
	11	VFSS-4110PL	5.5	5.5	3.5	8.0
	15	VFSS-4150PL	8.0	8.0	3.5	8.0

Note 1: Sizes of the wires connected to the input terminals R, S and T and the output terminals U, V and W when the length of each wire does not exceed 30m.

Note 2: For the control circuit, use shielded wires 0.75 mm² or more in diameter.

Note 3: For grounding, use a cable with a size equal to or larger than the above.

■ Selection of wiring devices

Voltage class	Capacity of applicable motor (kW)	Inverter model	Non-fuse circuit breaker (MCCB)		Magnetic contactor (MC)		Overload relay (THR)		Earth leakage breaker (ELCB)	
			Rated current (A)	Type Note1)	Rated current (A)	Type Note1)	Adjusted current (A) (For reference)	Type Note1)	Rated current (A)	Type Note1)
Single-phase 200V class	0.2	VFS9S-2002PL	10	NJ30N	11	C11J	1.3	T13J	10	NJV50E
	0.4	VFS9S-2004PL	15	NJ30N	11	C11J	2.3	T13J	15	NJV50E
	0.75	VFS9S-2007PL	20	NJ30N	11	C11J	3.6	T13J	20	NJV50E
	1.5	VFS9S-2015PL	30	NJ30N	18	C20J	6.8	T13J	30	NJV50E
	2.2	VFS9S-2022PL	40	NJ50E	35	C35J	9.3	T13J	40	NJV50E
Three-phase 200V class	0.2	VFS9-2002PM	5	NJ30N	11	C11J	1.3	T13J	5	NJV50E
	0.4	VFS9-2004PM	5	NJ30N	11	C11J	2.3	T13J	5	NJV50E
	0.75	VFS9-2007PM	10	NJ30N	11	C11J	3.6	T13J	10	NJV50E
	1.5	VFS9-2015PM	15	NJ30N	11	C11J	6.8	T13J	15	NJV50E
	2.2	VFS9-2022PM	20	NJ30N	13	C13J	9.3	T13J	20	NJV50E
	3.7	VFS9-2037PM	30	NJ30N	26	C25J	15	T20J	30	NJV50E
	5.5	VFS9-2055PL	50	NJ50E	35	C35J	22	T35J	50	NJV50E
	7.5	VFS9-2075PL	60	NJ100F	50	C50J	28	T35J	60	NJV60F
	11	VFS9-2110PM	100	NJ100F	65	C65J	44	T65J	100	NJV100F
	15	VFS9-2150PM	125	NJ225F	80	C80A	57	T65J	125	NJV225F
Three-phase 400V class	0.75	VFS9-4007PL	5	NJ30N	9	C11J	1.6	T13J	5	NJV50E
	1.5	VFS9-4015PL	10	NJ30N	9	C11J	3.6	T13J	10	NJV50E
	2.2	VFS9-4022PL	15	NJ30N	9	C11J	5.0	T13J	15	NJV50E
	3.7	VFS9-4037PL	20	NJ30N	13	C13J	6.8	T13J	20	NJV50E
	5.5	VFS9-4055PL	30	NJ30N	17	C20J	11	T13J	30	NJV50E
	7.5	VFS9-4075PL	30	NJ30N	25	C25J	15	T20J	30	NJV50E
	11	VFS9-4110PL	50	NJ50E	33	C35J	22	T35J	50	NJV50E
	15	VFS9-4150PL	60	NJ100F	48	C50J	28	T35J	60	NJV100F

Note 1: Produced by Schneider Toshiba electric corporation.

Note 2: Be sure to attach a surge killer to the exciting coil of the relay and the magnetic contactor.

Selection of surge killers for Toshiba magnetic contactors

200V class: Surge absorbing units are optionally available for Toshiba C11J to C65J, or

Model SS-2 for C50J and C65J

400V class: For the operation and control circuits, regulate the voltage at 200V or less with a step-down transformer.

Note 3: When using the auxiliary contacts 2a of the magnetic contactor MC for the control circuit, connect the contacts 2a in parallel to increase reliability.

Of the wiring devices listed in the above table, the magnetic contactors (MC) and the overload relays (Th-Ry) are intended for use with the Mighty J series. When using the old series (ESPER Mighty series), refer to the table below showing the correspondence between the two series.

Magnetic contactor (MC)		Overload relay	
ESPER Mighty series	Mighty J series	ESPER Mighty series	Mighty J series
C12A	C13J	T11A	T13J
C20A	C20J	T20A	T20J
C35A	C35J	T35A	T35J
C50A	C50J	T65A	T65J
C65A	C65J		

10.2 Installation of a magnetic contactor

If using the inverter without installing a magnetic contactor (MC) in the primary circuit, use an MCCB (with a power cutoff device) to open the primary circuit when the inverter protective circuit is activated. If using a braking resistor or braking resistor unit, install a magnetic contactor (MC) or non-fuse circuit breaker with a power cutoff device to the power supply of the inverter, so that the power circuit opens when the failure detection relay (FL) in the inverter or the external overload relay is activated.

■ Magnetic contactor in the primary circuit

A magnetic contactor installed in the power supply circuit of the inverter cuts off the power supply to the circuit and prevents the inverter from restarting in case of a power failure, a trip of the overload relay (Th-Ry) or the activation of the inverter protective circuit.

In addition, if the FL contact of the failure detection relay in the VF-S9 is connected to the operation circuit of the magnetic contactor on the primary side, the magnetic contactor (MC) will be tripped when the inverter protective circuit is activated.

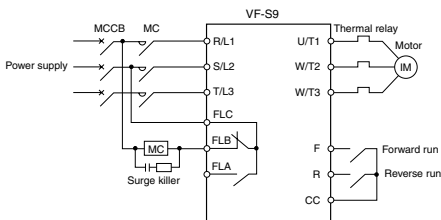

Example of connection of a magnetic contactor in the primary circuit

Notes on wiring

- When frequently switching between start and stop, do not use the magnetic contactor on the primary side as an on-off switch for the inverter. Instead, stop and start the inverter by using terminals F and CC (forward run) or R and CC (reverse run).
- Be sure to attach a surge killer to the exciting coil of the magnetic contactor (MC).

■ Magnetic contactor in the secondary circuit

A magnetic contactor may be installed on the secondary side to switch controlled motors or supply commercial power to the load when the inverter is out of operation.

Notes on wiring

- Be sure to interlock the magnetic contactor on the secondary side with the power supply to prevent commercial power from being applied to the inverter output terminals.
- When installing a magnetic contactor (MC) between the inverter and the motor, avoid turning the magnetic contactor on or off during operation. Turning the magnetic contactor on or off during operation causes a current to rush into the inverter which could lead to malfunction.

10.3 Installation of an overload relay

- 1) The VF-S9 inverter has an electronic-thermal overload protective function. In the following cases, however, the activation level of the electronic thermal protection unit must be adjusted and an overload relay suitable for the motor installed between the inverter and the motor.
 - When using a motor with a current rating different to that of the corresponding Toshiba general-purpose motor
 - When operating a single motor with an output smaller than that of the applicable standard motor or more than one motor simultaneously
- 2) When using the VF-S9 inverter to operate a constant-torque motor, such as the Toshiba VF motor, adjust the protection characteristic of the electronic thermal protection unit to the VF motor use.
- 3) It is recommended to use a motor with a thermal relay embedded in the motor coil to give sufficient protection to the motor, especially when it runs in a low-speed range.

10.4 Optional external devices

The following external devices are optionally available for the VF-S9 series of inverters.

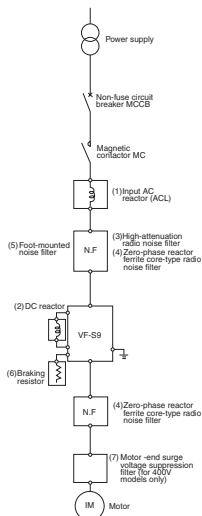

		Optional external devices																	
No.	Device	Function and purpose																	
(1)	Input AC reactor	<p>Used to improve the input power factor, reduce the harmonics, and suppress external surge on the inverter power source side. Install when the power capacity is 500 kVA or more and 10 times or more than the inverter capacity or when a distorted wave generation source such as a thyristor unit or a large-capacity inverter is connected in the same distribution system.</p> <table border="1" style="width: 100%; border-collapse: collapse;"> <thead> <tr> <th rowspan="2" style="text-align: center;">Reactor type</th> <th rowspan="2" style="text-align: center;">Power factor improvement</th> <th colspan="2" style="text-align: center;">Effect</th> <th rowspan="2" style="text-align: center;">External surge suppression</th> </tr> <tr> <th style="text-align: center;">200V-3.7kW or less</th> <th style="text-align: center;">Harmonics Suppression Other model</th> </tr> </thead> <tbody> <tr> <td style="text-align: center;">Input AC reactor</td> <td style="text-align: center;">○</td> <td style="text-align: center;">○</td> <td style="text-align: center;">○</td> <td style="text-align: center;">○</td> </tr> <tr> <td style="text-align: center;">DC reactor</td> <td style="text-align: center;">○ Large</td> <td style="text-align: center;">○</td> <td style="text-align: center;">○ Large</td> <td style="text-align: center;">×</td> </tr> </tbody> </table> <p>○ Large : Large effective. ○ : effective. × : ineffective</p>	Reactor type	Power factor improvement	Effect		External surge suppression	200V-3.7kW or less	Harmonics Suppression Other model	Input AC reactor	○	○	○	○	DC reactor	○ Large	○	○ Large	×
Reactor type	Power factor improvement	Effect			External surge suppression														
		200V-3.7kW or less	Harmonics Suppression Other model																
Input AC reactor	○	○	○	○															
DC reactor	○ Large	○	○ Large	×															
(2)	DC reactor	<p>Improves the power factor more than the input reactor. When the facility applying the inverter requires high reliability, it is recommended to use the DC reactor with an input reactor effective for external surge suppression.</p> <p>* An inverter unit of 200V-3.7kW or less is connected to a reactor selected on page J-8, 9 to conform "Guides of limits for harmonics current emissions on general purpose inverter having an input current up to and including 20A per phase" by the Japan Electrical Manufacturers' Association.</p>																	
(3)	Radio noise reduction filter	<p>High-attenuation filter (LC filter) NF type manufactured by Soshin Electric Co.</p> <p>These types of filters are not necessary because all single-phase 200V or 3-phase 400V models and 3-phase 200V, 5.5kW or 7.5kW models have a built-in EMI noise filter, conforming to Class A, as standard. But install these filters if necessarily of noise reduction move and more.</p> <ul style="list-style-type: none"> • Effective to prevent interference in audio equipment used near the inverter. • Install on the input side of the inverter. • Provided with wide-range attenuation characteristics from AM radio bands to near 10MHz. • Use when equipment readily affected by noise is installed in the peripheral area. 																	
(4)		<p>Zero-phase reactor (Inductive filter) Ferrite core type manufactured by Soshin Electric Co.</p> <ul style="list-style-type: none"> • Effective to prevent interference in audio equipment used near the inverter. • Effective in noise reduction on both input and output sides of the inverter. • Provided with attenuation characteristics of several dB in frequencies from AM radio bands to 10MHz. • For noise countermeasures, insert on the secondary side of the inverter. 																	
(5)		<p>Foot-mounted type noise reduction filter (Soon to be released)</p> <p>High-attenuation EMI noise filter requiring only small space; mounted on the rear side of the inverter. This filter can be installed to conform to the following classes of EMC standard EN5501 Group 1.</p> <p>3-phase 200V models excluding those of 5.5/7.5kW : Conform to Class A. All models other than above : Conform to Class B.</p>																	
(6)	Braking resistor	<p>Use when rapid deceleration or stop is frequently required or when it is desired to reduce the deceleration time with large load. This resistor consumes regenerative energy during power generation braking.</p> <ul style="list-style-type: none"> • Braking resistor – With (resistor + protective thermal relay) built in. 																	
(7)	Motor-end surge voltage suppression filter (400V class only)	Use an insulation-reinforced motor or install the surge voltage restraint filter to prevent degrading motor insulation caused by surge voltage generation depending on cable length and wiring method, or use of a 400V class motor driven with an inverter.																	
(8)	Conduit pipe kit (Soon to be released)	Attachment kit used for conformance to NEMA TYPE1.																	
(9)	IP43 enclosure kit (Soon to be released)	Attachment kit for making a panel conform to the IP43 structure.																	
(10)	DIN rail kit (Soon to be released)	Available for the 200V class models of 0.75kW or less. (Model: DIN001Z)																	

No.	Device	Function and purpose
(11)	Parameter writer	Use this unit for batch read, batch copy, and batch writing of setting parameters. (Model: PWU001Z)
(12)	Extension panel	Extended operation panel kit provided with LED indication section, RUN/STOP key, UP/DOWN key, Monitor key, and Enter key. (Model: RKP001Z)
(13)	RS485 communication converter unit	Use to connect a personal computer for data communication with up to 64 units. (Model: RS4001Z, RS4002Z)
(14)	RS232C communication converter unit	Use to connect a personal computer for data communication. (Model: RS2001Z)
(10)	Remote panel	Provided with built-in frequency indicator, frequency setting device, and RUN-STOP (forward/reverse) switch. (Model: CBVR-7B1)
(15)	Application control unit	AP Series is available to enable various types of application control functions when combined with an inverter. Contact your Toshiba representative for further information.

Table for selection of optional external devices

Voltage class	Capacity of applicable motor	Inverter model	Input AC reactor (Note 2)	DC reactor (Note 2)	Radio noise reduction filter	Core type (See Note 1.)	Braking resistor	Motor-end surge voltage suppression filter	Conduit pipe kit	Foot-mounted type noise reduction filter	DIN adapter
					High-attenuation type						
Single-phase 200V class	0.2	VF9S-200ZPL	PFL-2002S	DCL-2002	-	RC5078	PBR-2007	-	NEM010Z	EMF-S2010AZ	DIN001Z
	0.4	VF9S-2004PL	PFL-2005S	DCL-2007	-	RC5078	PBR-2007	-	NEM010Z	EMF-S2010AZ	DIN001Z
	0.75	VF9S-2007PL	PFL-2011S	DCL-2022	-	RC5078	PBR-2007	-	NEM010Z	EMF-S2010AZ	DIN001Z
	1.5	VF9S-2015PL	PFL-2018S	DCL-2037	-	RC5078	PBR-2022	-	NEM020Z	EMF-S2016CZ	-
	2.2	VF9S-2022PL	PFL-2018S	DCL-2037	-	RC5078	PBR-2022	-	NEM030Z	EMF-S20250Z	-
	0.2	VF9S-200ZPM	PFL-2001S	DCL-2002	-	RC5078	PBR-2007	-	NEM011Z	EMF-2011BZ	DIN001Z
Three-phase 200V class	0.4	VF9S-2004PM	PFL-2005S	DCL-2007	NF3005A-MU	RC5078	PBR-2007	-	NEM011Z	EMF-2011BZ	DIN001Z
	0.75	VF9S-2007PM	PFL-2005S	DCL-2007	NF3005A-MU	RC5078	PBR-2007	-	NEM011Z	EMF-2011BZ	DIN001Z
	1.5	VF9S-2015PM	PFL-2011S	DCL-2022	NF3015A-MU	RC5078	PBR-2022	-	NEM011Z	EMF-2011BZ	-
	2.2	VF9S-2022PM	PFL-2011S	DCL-2022	NF3015A-MU	RC5078	PBR-2022	-	NEM031Z	EMF-4022DZ	-
	3.7	VF9S-2037PM	PFL-2018S	DCL-2037	NF3020A-MU	RC5078	PBR-2037	-	NEM031Z	EMF-4022DZ	-
	5.5	VF9S-2055PL	PFL-2025S	DCL-2055	-	RC9129	PB3-2055	-	NEM040Z	EMF-4045EZ	-
Three-phase 400V class	7.5	VF9S-2075PL	PFL-2050S	DCL-2110	-	RC9129	PBR-2075	-	NEM040Z	EMF-4045EZ	-
	11	VF9S-2110PM	PFL-2050S	DCL-2110	NF3050A-MU	RC9129	PBR-2110	-	NEM050Z	EMF-2080GZ	-
	15	VF9S-2150PM	PFL-2100S	DCL-2220	NF3080A-MU	RC9129	PBR-2150	-	NEM050Z	EMF-2080GZ	-
	0.75	VF9S-4007PL	PFL-4012S	DCL-2007	-	RC5078	PBR-2007	MSF-4015Z	NEM020Z	EMF-4006CZ	-
	1.5	VF9S-4015PL	PFL-4012S	DCL-2007	-	RC5078	PBR-2007	MSF-4015Z	NEM020Z	EMF-4006CZ	-
	2.2	VF9S-4022PL	PFL-4012S	DCL-2022	-	RC5078	PBR-2007	MSF-4037Z	NEM030Z	EMF-4022DZ	-
	3.7	VF9S-4037PL	PFL-4012S	DCL-2022	-	RC5078	PBR-2007	MSF-4037Z	NEM030Z	EMF-4022DZ	-
	5.5	VF9S-4055PL	PFL-4025S	DCL-4110	-	RC9129	PBR3-4055	MSF-4075Z	NEM040Z	EMF-4045EZ	-
	7.5	VF9S-4075PL	PFL-4025S	DCL-4110	-	RC9129	PBR3-4075	MSF-4075Z	NEM040Z	EMF-4045EZ	-
	11	VF9S-4110PL	PFL-4025S	DCL-4110	-	RC9129	PBR3-4110	MSF-4150Z	NEM050Z	EMF-4045FZ	-
	15	VF9S-4150PL	PFL-4050S	DCL-4220	-	RC9129	PBR3-4150	MSF-4150Z	NEM050Z	EMF-4045FZ	-

Note 1: This filter is used wound around the input-side power line. (Number of turns: 4 or more) This filter can be installed on the output side, as well.

Note 2: Connecting this reactor to the inverter makes it compliant with the standard "General Inverter (input current of 20A or less) Harmonic Suppression Measures Execution Guidelines" set by the Japan Electric Industry Association.

Devices		External dimensions and connections										
Input AC reactor (ACL)												
Type	Rating	Inverter type	Dimensions (mm)							Drawing	Terminals	Approx. weight (kg)
			A	B	C	D	E	F	G			
PFLS2002S	1φ-230V-2.0A-50/60Hz	VFS9S-2002PL	80	55	115	63	45	5	45	A	M3.5	0.85
PFL2001S	3φ-230V-1.7A-50/60Hz	VFS9-2002PM	105	65	115	90	55	5	40		M3.5	1.0
PFL2005S	3φ-230V-5.5A-50/60Hz	VFS9-2004PM, 2007PM VFS9S-2004PL	105	65	115	90	55	5	40	A	M3.5	1.2
PFL2011S	3φ-230V-11A-50/60Hz	VFS9S-2007PL VFS9-2019PM, 2022PM	130	70	140	115	60	5	50		M4	2.3
PFL2018S	3φ-230V-18A-50/60Hz	VFS9-2037PM VFS9S-2015PL, VFS9S-2022PL	130	70	140	115	60	5	50	A	M4	2.5
PFL2025S	3φ-230V-25A-50/60Hz	VFS9-2055PL	125	100	130	50	83	7	-		M4	2.6
PFL2050S	3φ-230V-50A-50/60Hz	VFS9-2075PL, VFS9-2110PM	155	115	140	50	95	7	-	B	M6	3.4
PFL2100S	3φ-230V-100A-50/60Hz	VFS9-2150PM	230	150	210	50	90	8	-		M6	8.2
PFL4012S	3φ-460V-12.5A-50/60Hz	VFS9-4007PL, VFS9-4037PL	125	95	130	50	79	7	-	B	M4	2.3
PFL4025S	3φ-460V-25A-50/60Hz	VFS9-4055PL, VFS9-4110PL	155	110	155	50	94	7	-		M4	4.9
PFL4050S	3φ-460V-50A-50/60Hz	VFS9-4150PL	155	140	165	50	112	7	-	M6	6.6	

Note) PFL2002S has 4 terminals.

Devices
 DC reactor
 (DCL)

External dimensions and connections

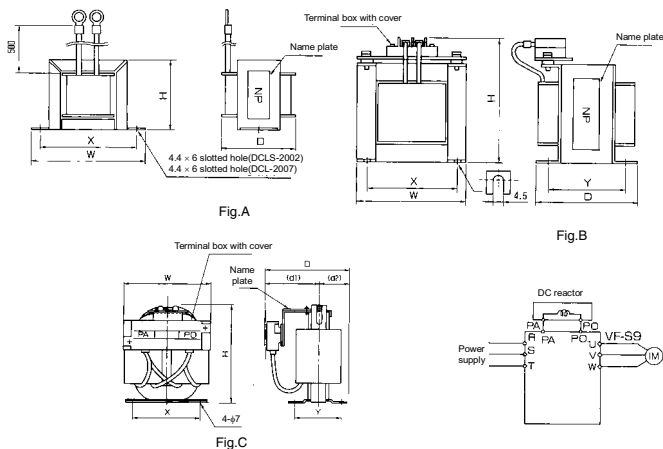

Type	Rated current (A)	Inverter type	Dimensions (mm)								Dimension	Terminals	Approx. weight (kg)
			W	H	D	X	Y	d1	d2				
DCLS-2002	2.5	VFS9S-2002PL, VFS9-2002PM	79	50	44	68	-	-	-	-	A	V1.25-3.5	0.6
DCL-2007	7	VFS9-2004PM, 2007PM VFS9S-2004PL VFS9-4007PL, 4015PL (Note)	92	65	70	82	-	-	-	-	A	V2-3.5	1.2
DCL-2022	14	VFS9-2015PM, 2022PM VFS9S-2007PL VFS9-4022PL, 4037PL (Note)	86	110	80	71	64	-	-	-	B	M4	2.2
DCL-2037	22.5	VFS9-2037PM VFS9S-2015PL, 2022PL	85	110	85	71	78	-	55	-	B	M4	2.5
DCL-2055	38	VFS9-2055PM	75	130	140	50	85	85	55	-	C	M5	1.9
DCL-2110	75	VFS9-2075PM - VFS9-2110PM	100	150	150	65	85	95	60	-	C	M5	2.4
DCL-2220	150	VFS9-2150PM	117	170	190	90	90	130	-	-	C	M5	4.3
DCL-4110	38	VFS9-4055PL - VFS9-4110PL	95	150	165	70	90	105	60	-	C	M5	3.0
DCL-4220	75	VFS9-4150PL	105	160	185	80	100	130	65	-	C	M5	3.7



(Note) VFS9-4007PL - 4037PL are used DC reactor for 200V class.

Devices	External dimensions and connections																																																																																														
High-attenuation radio noise reduction filter	<p>High-attenuation radio noise reduction filter</p> <p>Power supply</p> <p>High-attenuation filter</p> <p>Earth terminal</p> <p>VF-S9</p> <p>① Noise filter should be connected to the primary-side of inverter.</p> <p>② Output cable should be kept away from input cable.</p>																																																																																														
	<table border="1"> <thead> <tr> <th rowspan="2">Type</th> <th rowspan="2">Rated current (A)</th> <th rowspan="2">Inverter type</th> <th colspan="13">Dimensions (mm)</th> <th rowspan="2">Approx. weight (kg)</th> </tr> <tr> <th>A</th> <th>B</th> <th>C</th> <th>E</th> <th>F</th> <th>G</th> <th>H</th> <th>J</th> <th>K</th> <th>M</th> <th>N</th> <th>P</th> </tr> </thead> <tbody> <tr> <td>NF3005A-MJ</td> <td>5</td> <td>VFSS-2002PM - FS9-2007PM</td> <td>174.5</td> <td>160</td> <td>145</td> <td>110</td> <td>80</td> <td>32</td> <td>70</td> <td>20</td> <td>45</td> <td>65.5</td> <td>MM</td> <td>MM</td> <td>1.0</td> </tr> <tr> <td>NF3015A-MJ</td> <td>15</td> <td>VFSS-2015PM, VFSS-2022PM</td> <td>174.5</td> <td>160</td> <td>145</td> <td>110</td> <td>80</td> <td>32</td> <td>70</td> <td>20</td> <td>45</td> <td>65.5</td> <td>MM</td> <td>MM</td> <td>1.6</td> </tr> <tr> <td>NF3020A-MJ</td> <td>20</td> <td>VFSS-2037PM</td> <td>267.5</td> <td>250</td> <td>235</td> <td>170</td> <td>140</td> <td>44</td> <td>90</td> <td>30</td> <td>60</td> <td>66.5</td> <td>MB</td> <td>MB</td> <td>4.6</td> </tr> <tr> <td>NF3050A-MJ</td> <td>50</td> <td>VFSS-2110PM</td> <td>294.5</td> <td>280</td> <td>260</td> <td>170</td> <td>150</td> <td>37</td> <td>100</td> <td>30</td> <td>65</td> <td>66.5</td> <td>MB</td> <td>MB</td> <td>7.0</td> </tr> </tbody> </table>	Type	Rated current (A)	Inverter type	Dimensions (mm)													Approx. weight (kg)	A	B	C	E	F	G	H	J	K	M	N	P	NF3005A-MJ	5	VFSS-2002PM - FS9-2007PM	174.5	160	145	110	80	32	70	20	45	65.5	MM	MM	1.0	NF3015A-MJ	15	VFSS-2015PM, VFSS-2022PM	174.5	160	145	110	80	32	70	20	45	65.5	MM	MM	1.6	NF3020A-MJ	20	VFSS-2037PM	267.5	250	235	170	140	44	90	30	60	66.5	MB	MB	4.6	NF3050A-MJ	50	VFSS-2110PM	294.5	280	260	170	150	37	100	30	65	66.5	MB	MB	7.0	
Type	Rated current (A)				Inverter type	Dimensions (mm)													Approx. weight (kg)																																																																												
		A	B	C		E	F	G	H	J	K	M	N	P																																																																																	
NF3005A-MJ	5	VFSS-2002PM - FS9-2007PM	174.5	160	145	110	80	32	70	20	45	65.5	MM	MM	1.0																																																																																
NF3015A-MJ	15	VFSS-2015PM, VFSS-2022PM	174.5	160	145	110	80	32	70	20	45	65.5	MM	MM	1.6																																																																																
NF3020A-MJ	20	VFSS-2037PM	267.5	250	235	170	140	44	90	30	60	66.5	MB	MB	4.6																																																																																
NF3050A-MJ	50	VFSS-2110PM	294.5	280	260	170	150	37	100	30	65	66.5	MB	MB	7.0																																																																																
	Note) End of type of Inverter : -PL has a built-in the high-attenuation radio noise reduction filter																																																																																														
Zero-phase ferrite core-type radio noise reduction filter	<p>Zero-phase reactor</p> <p>Power supply</p> <p>VF-S9</p> <p>Input or output cable should be coiled over 4-times.</p>																																																																																														
	<p>Type : RC9123</p> <p>Type : RC5078</p> <p>Unit: mm</p>																																																																																														

Devices	External dimensions and connections																																																																																																																																																																																																
Foot-mounted noise filter																																																																																																																																																																																																	
	Type	Rated current (A)	Inverter type	Dimensions (mm)										Approx. weight (kg)	Remarks	W	H	D	W1	H1	D2	E	F	G	EMFS2010AZ	10	VF-S9S-2002PL - 2007PL	105	185											0.9	EMC : class B compliance	EMF2011BZ	11	VF-S9S-2002PM - 2015PM	105												1.2	EMC : class A compliance	EMFS2016GZ	16	VF-S9-2015PL	130	205		50	85	110	190						1.25	EMC : class B compliance	EMF4006FZ	6	VF-S9S-4007PL 4015PL	130							10	8.5	8.5			1.4	EMC : class B compliance	EMFS2025DZ	25	VF-S9S-2022PL	140	250											1.25	EMC : class A compliance	EMF4022DZ	22	VF-S9S-2022PM 2037PM	140			60		120	230						1.25	EMC : class A compliance			VF-S9S-4022PL 4037PL	200	351				160	330						3.6	EMC : class B compliance	EMF4045EZ	45	VF-S9S-2055PL 2075PL	200	351											5	EMC : class B compliance	EMF4045FZ	45	VF-S9S-4055PL 4075PL	200	351						11	9.5	5.5			5	EMC : class B compliance	EFM2080GZ	80	VF-S9S-2110PM 2150PM	245	372				205	360						5
Type				Rated current (A)	Inverter type	Dimensions (mm)										Approx. weight (kg)	Remarks																																																																																																																																																																																
	W	H	D			W1	H1	D2	E	F	G																																																																																																																																																																																						
EMFS2010AZ	10	VF-S9S-2002PL - 2007PL	105	185											0.9	EMC : class B compliance																																																																																																																																																																																	
EMF2011BZ	11	VF-S9S-2002PM - 2015PM	105												1.2	EMC : class A compliance																																																																																																																																																																																	
EMFS2016GZ	16	VF-S9-2015PL	130	205		50	85	110	190						1.25	EMC : class B compliance																																																																																																																																																																																	
EMF4006FZ	6	VF-S9S-4007PL 4015PL	130							10	8.5	8.5			1.4	EMC : class B compliance																																																																																																																																																																																	
EMFS2025DZ	25	VF-S9S-2022PL	140	250											1.25	EMC : class A compliance																																																																																																																																																																																	
EMF4022DZ	22	VF-S9S-2022PM 2037PM	140			60		120	230						1.25	EMC : class A compliance																																																																																																																																																																																	
		VF-S9S-4022PL 4037PL	200	351				160	330						3.6	EMC : class B compliance																																																																																																																																																																																	
EMF4045EZ	45	VF-S9S-2055PL 2075PL	200	351											5	EMC : class B compliance																																																																																																																																																																																	
EMF4045FZ	45	VF-S9S-4055PL 4075PL	200	351						11	9.5	5.5			5	EMC : class B compliance																																																																																																																																																																																	
EFM2080GZ	80	VF-S9S-2110PM 2150PM	245	372				205	360						5	EMC : class A compliance*																																																																																																																																																																																	
* Wire grounding wire between the EMI filter and EMC plate in order to conform to class A.													(EFM 2080GZ only)																																																																																																																																																																																				
Wire size : 6mm ² or more (AWG 9 or more)																																																																																																																																																																																																	
Wire length : 29cm or less																																																																																																																																																																																																	

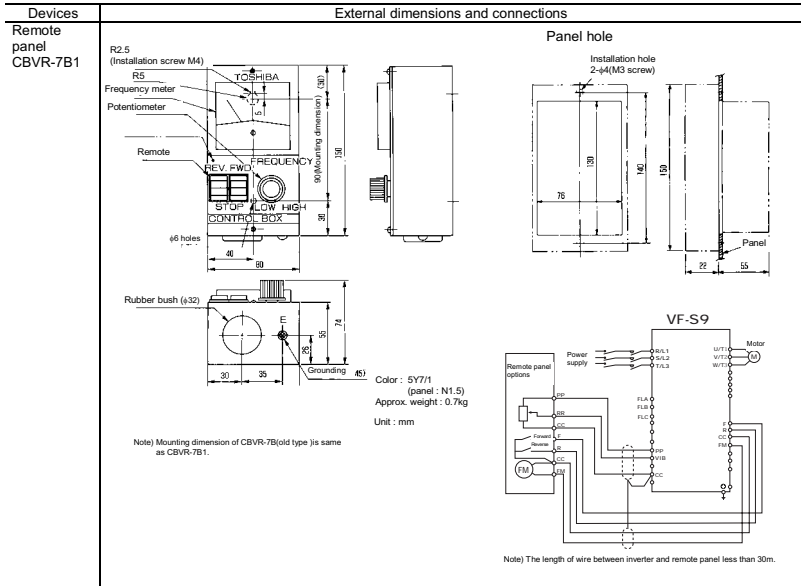
Devices		External dimensions and connections																																																																																																																																																																	
Braking resistor	<p>Fig. A</p>		<p>Fig. C</p>																																																																																																																																																																
	<p>Fig. B</p>		<p>Fig. D</p>																																																																																																																																																																
	<table border="1"> <thead> <tr> <th rowspan="2">Model</th> <th rowspan="2">Rating</th> <th rowspan="2">Inverter type</th> <th colspan="5">Dimensions (mm)</th> <th rowspan="2">Diagram Connection</th> <th rowspan="2">Approx. weight(kg)</th> </tr> <tr> <th>A</th> <th>B</th> <th>C</th> <th>D</th> <th>E</th> <th>G</th> </tr> </thead> <tbody> <tr> <td>PBR-2007</td> <td>120W-200V</td> <td>VF59-2002PM - VF59-2007PM VF59S-2002PL - VF59S-2007PL</td> <td>42</td> <td>182</td> <td>20</td> <td>4.2</td> <td>172</td> <td>-</td> <td>A&C</td> <td>0.28</td> </tr> <tr> <td>PBR-2022</td> <td>120W-75V</td> <td>VF59-2015PM - VF59-2022PM VF59S-2015PL-2022PL</td> <td></td> <td></td> <td></td> <td></td> <td></td> <td></td> <td></td> <td></td> </tr> <tr> <td>PBR-2037</td> <td>120W-40V</td> <td>VF59-2037PM</td> <td></td> <td></td> <td></td> <td></td> <td></td> <td></td> <td></td> <td></td> </tr> <tr> <td>PBR3-2055</td> <td>120W-40V x 2P(240W-20V)</td> <td>VF59-2055PL</td> <td></td> <td>320</td> <td>115</td> <td></td> <td></td> <td>50</td> <td></td> <td>4</td> </tr> <tr> <td>PBR3-2075</td> <td>220W-30V x 2P(440W-15V)</td> <td>VF59-2075PL</td> <td>120</td> <td>350</td> <td>190</td> <td>110</td> <td>230</td> <td>150</td> <td>B&D</td> <td>4.5</td> </tr> <tr> <td>PBR3-2110</td> <td>220W-30V x 3P(660W-10V)</td> <td>VF59-2110PM</td> <td></td> <td></td> <td></td> <td></td> <td></td> <td></td> <td></td> <td>6</td> </tr> <tr> <td>PBR3-2150</td> <td>220W-30V x 4P(880W-7.5V)</td> <td>VF59-2150PM</td> <td></td> <td></td> <td></td> <td></td> <td></td> <td></td> <td></td> <td>5.5</td> </tr> <tr> <td>PBR-2007</td> <td>120W-200V</td> <td>VF59-4007PL - VF59-4022PL (Note)</td> <td>42</td> <td>182</td> <td>20</td> <td>4.2</td> <td>172</td> <td>-</td> <td>A&C</td> <td>0.28</td> </tr> <tr> <td>PBR-4037</td> <td>120W-160V</td> <td>VF59-4037PL</td> <td></td> <td></td> <td></td> <td></td> <td></td> <td></td> <td></td> <td></td> </tr> <tr> <td>PBR3-4055</td> <td>120W-160V x 2P(240W-80V)</td> <td>VF59-4055PL</td> <td></td> <td>320</td> <td>115</td> <td></td> <td></td> <td>50</td> <td></td> <td>4</td> </tr> <tr> <td>PBR3-4075</td> <td>220W-120V x 2P(440W-60V)</td> <td>VF59-4075PL</td> <td>120</td> <td>350</td> <td>190</td> <td>110</td> <td>230</td> <td>150</td> <td>B&D</td> <td>4.5</td> </tr> <tr> <td>PBR3-4110</td> <td>220W-120V x 3P(660W-40V)</td> <td>VF59-4110PL</td> <td></td> <td></td> <td></td> <td></td> <td></td> <td></td> <td></td> <td>6</td> </tr> <tr> <td>PBR3-4150</td> <td>220W-120V x 4P(880W-30V)</td> <td>VF59-4150PL</td> <td></td> <td></td> <td></td> <td></td> <td></td> <td></td> <td></td> <td>5.5</td> </tr> </tbody> </table> <p>Note) VF59-4007PL - 4022PL are used braking resistor for 200V class.</p>		Model	Rating	Inverter type	Dimensions (mm)					Diagram Connection	Approx. weight(kg)	A	B	C	D	E	G	PBR-2007	120W-200V	VF59-2002PM - VF59-2007PM VF59S-2002PL - VF59S-2007PL	42	182	20	4.2	172	-	A&C	0.28	PBR-2022	120W-75V	VF59-2015PM - VF59-2022PM VF59S-2015PL-2022PL									PBR-2037	120W-40V	VF59-2037PM									PBR3-2055	120W-40V x 2P(240W-20V)	VF59-2055PL		320	115			50		4	PBR3-2075	220W-30V x 2P(440W-15V)	VF59-2075PL	120	350	190	110	230	150	B&D	4.5	PBR3-2110	220W-30V x 3P(660W-10V)	VF59-2110PM								6	PBR3-2150	220W-30V x 4P(880W-7.5V)	VF59-2150PM								5.5	PBR-2007	120W-200V	VF59-4007PL - VF59-4022PL (Note)	42	182	20	4.2	172	-	A&C	0.28	PBR-4037	120W-160V	VF59-4037PL									PBR3-4055	120W-160V x 2P(240W-80V)	VF59-4055PL		320	115			50		4	PBR3-4075	220W-120V x 2P(440W-60V)	VF59-4075PL	120	350	190	110	230	150	B&D	4.5	PBR3-4110	220W-120V x 3P(660W-40V)	VF59-4110PL								6	PBR3-4150	220W-120V x 4P(880W-30V)	VF59-4150PL								5.5		
	Model	Rating				Inverter type	Dimensions (mm)						Diagram Connection	Approx. weight(kg)																																																																																																																																																					
A			B	C	D		E	G																																																																																																																																																											
PBR-2007	120W-200V	VF59-2002PM - VF59-2007PM VF59S-2002PL - VF59S-2007PL	42	182	20	4.2	172	-	A&C	0.28																																																																																																																																																									
PBR-2022	120W-75V	VF59-2015PM - VF59-2022PM VF59S-2015PL-2022PL																																																																																																																																																																	
PBR-2037	120W-40V	VF59-2037PM																																																																																																																																																																	
PBR3-2055	120W-40V x 2P(240W-20V)	VF59-2055PL		320	115			50		4																																																																																																																																																									
PBR3-2075	220W-30V x 2P(440W-15V)	VF59-2075PL	120	350	190	110	230	150	B&D	4.5																																																																																																																																																									
PBR3-2110	220W-30V x 3P(660W-10V)	VF59-2110PM								6																																																																																																																																																									
PBR3-2150	220W-30V x 4P(880W-7.5V)	VF59-2150PM								5.5																																																																																																																																																									
PBR-2007	120W-200V	VF59-4007PL - VF59-4022PL (Note)	42	182	20	4.2	172	-	A&C	0.28																																																																																																																																																									
PBR-4037	120W-160V	VF59-4037PL																																																																																																																																																																	
PBR3-4055	120W-160V x 2P(240W-80V)	VF59-4055PL		320	115			50		4																																																																																																																																																									
PBR3-4075	220W-120V x 2P(440W-60V)	VF59-4075PL	120	350	190	110	230	150	B&D	4.5																																																																																																																																																									
PBR3-4110	220W-120V x 3P(660W-40V)	VF59-4110PL								6																																																																																																																																																									
PBR3-4150	220W-120V x 4P(880W-30V)	VF59-4150PL								5.5																																																																																																																																																									

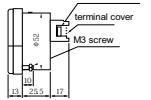
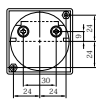

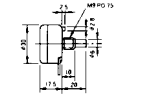
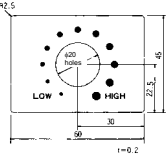
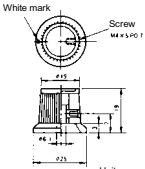
Devices	External dimensions and connections		
Frequency meter QS60T	Frequency meter(QS60T(80Hz-1mAdc)) <div style="display: flex; justify-content: space-around; align-items: flex-start; margin-top: 20px;"> <div style="text-align: center;">  <p>(Front)</p> </div> <div style="text-align: center;">  <p>(Side)</p> </div> <div style="text-align: center;">  <p>(Rear)</p> </div> <div style="text-align: center;"> <p>Panel cut dimensions</p>  <p>Color : Black Approx. weight : 75g 2-φ3.5 holes Unit : mm</p> </div> </div> <p style="margin-top: 20px;">Note) Dimension of QS60T is different from old type : QY-11.</p>		
FRH kit	Frequency setting resistor (RV30YN-20S-B302) <div style="text-align: center; margin-top: 20px;">  <p>φ3.2 holes φ10 holes</p> </div>	Frequency setting panel <div style="text-align: center; margin-top: 20px;">  <p>r=0.2</p> </div>	Frequency setting <div style="text-align: center; margin-top: 20px;">  <p>White mark Screw M3 x P 0.7 Unit : mm</p> </div>

11. Table of parameters and data

11.1 User parameters

*1: The end of type – form depend
AN – WN : 60Hz
WP : 50Hz

*2: Model depend (See section 11 page K-6)

Title	Function	Unit	Minimum setting unit	Adjustment range	Default setting	User setting	Reference
-	Applicable motor base frequency *3	Hz	-	60 50	*1		4.1
F _C	Operation frequency of operation panel	Hz	0.1	LL - UL	0.0		3.2

*3: When the standard setting (L_{SP}:3) is entered, this parameter displayed.

11.2 Basic parameters

• Four automatic functions

Title	Communication No.	Function	Unit	Minimum setting unit	Adjustment range	Default setting	User setting	Reference
R _{U1}	0000	Automatic acceleration/ deceleration	-	-	0: Disabled (manual) 1: Optimum rate 2: Minimum rate	0		5.1
R _{U2}	0001	Automatic torque boost	-	-	0: Disabled 1: Vector control + auto-tuning	0		5.2
R _{U3}	0002	Automatic environment setting	-	-	0: Disabled 1: Automatic setting	0		5.3
R _{U4}	0040	Automatic function setting	-	-	0: Disabled 1: Coast stop 2: 3-wire operation 3: External input UP/DOWN setting 4: 4-20 mA current input operation	0		5.4

• Other basic parameters

Title	Communication No.	Function	Unit	Minimum setting unit	Adjustment range	Default setting	User setting	Reference
C _{Mod}	0003	Command mode selection	-	-	0: Terminal board 1: Operation panel	1		5.5
F _{Mod}	0004	Frequency setting mode selection	-	-	0: Terminal board 1: Operation panel 2: Internal potentiometer	2		5.5
F _{FSL}	0005	Meter selection	-	-	0: Output frequency 1: Output current 2: Set frequency 3: For adjustment (current fixed at 100%) 4: Inverter load factor 5: Output power	0		5.6
F _A	0006	Meter adjustment	-	-		-		5.6
L _{SP}	0007	Standard setting mode selection	-	-	0 - 2: -(invalid) 3: Default setting 4: Trip clear 5: Cumulative operation time clear 6: Initialization of type information	0		5.7

Title	Communication No.	Function	Unit	Minimum setting unit	Adjustment range	Default setting	User setting	Reference																																
F_r	0008	Forward/reverse run selection (Operation panel)	-	-	0: Forward run 1: Reverse run	0	-	5.8																																
P_{CC}	0009	Acceleration time 1	s	0.1	0.1-3600	10.0	-	5.1																																
d_{EC}	0010	Deceleration time 1	s	0.1	0.1-3600	10.0	-	5.1																																
F_H	0011	Maximum frequency	Hz	0.1	30.0-400	80.0	-	5.9																																
U_L	0012	Upper limit frequency	Hz	0.1	0.5- F_H	*1	-	5.10																																
L_L	00013	lower limit frequency	Hz	0.1	0.0- L_L	0.0	-	5.10																																
U_L	0014	Base frequency 1	Hz	0.1	25-400	60.0 *1	-	5.11																																
P_{E}	0015	V/F control mode selection	-	-	0: V/F constant 1: Variable torque 2: Automatic torque boost 3: Sensorless Vector control 4: Automatic energy-saving	0	-	5.12																																
U_b	0016	Torque boost	%(V)	0.1	0.0-30.0	*2	-	5.13																																
E_{Hr}	0041	Motor electronic-thermal protection level 1	%(A)	1	10-100	100	-	5.14																																
Q_{r}	0017	Electronic-thermal protection characteristic selection *4	-	-	<table border="1"> <thead> <tr> <th>Setting</th> <th>type</th> <th>Overload protection</th> <th>OL stall</th> </tr> </thead> <tbody> <tr> <td>0</td> <td></td> <td>○</td> <td>×</td> </tr> <tr> <td>1</td> <td rowspan="3">Standards motor</td> <td>○</td> <td>○</td> </tr> <tr> <td>2</td> <td>×</td> <td>×</td> </tr> <tr> <td>3</td> <td>×</td> <td>○</td> </tr> <tr> <td>4</td> <td></td> <td>○</td> <td>×</td> </tr> <tr> <td>5</td> <td rowspan="3">V/F motor (special motor)</td> <td>○</td> <td>○</td> </tr> <tr> <td>6</td> <td>×</td> <td>×</td> </tr> <tr> <td>7</td> <td>×</td> <td>○</td> </tr> </tbody> </table>	Setting	type	Overload protection	OL stall	0		○	×	1	Standards motor	○	○	2	×	×	3	×	○	4		○	×	5	V/F motor (special motor)	○	○	6	×	×	7	×	○	0	-	5.14
Setting	type	Overload protection	OL stall																																					
0		○	×																																					
1	Standards motor	○	○																																					
2		×	×																																					
3		×	○																																					
4		○	×																																					
5	V/F motor (special motor)	○	○																																					
6		×	×																																					
7		×	○																																					
S_{r1} to S_{r7}	0018 to 0024	Preset-speed operation frequencies 1 to 7	Hz	0.1	L_L - L_L	0.0	-	5.15																																
F_{---	-	Extended parameter	-	-	-	-	-	4.1																																
G_U	-	Automatic edit function	-	-	-	-	-	4.1																																

*4 : ○ : valid, × : invalid

11.3 Extended parameters

• Input/output parameters

Title	Communication No.	Function	Unit	Minimum setting unit	Adjustment range	Default setting	User setting	Reference
F_{O0}	0100	Low-speed signal output frequency	Hz	0.1	0.0- F_H	0.0	-	6.1.1
F_{O1}	0101	Speed reach setting frequency	Hz	0.1	0.0- F_H	0.0	-	6.1.3
F_{O2}	0102	Speed reach detection band	Hz	0.1	0.0- F_H	2.5	-	6.1.2
F_{O3}	0103	ST signal selection	-	-	0: Stand by on when ST is on 1: Stand by always on 2: Interlocked with F/R 3: Stand by on when ST is off	1	-	6.2.1
F_{O4}	0104	RST signal selection	-	-	0: Default 1: Activated by turning RST off	0	-	6.2.2

Title	Communication No.	Function	Unit	Minimum setting unit	Adjustment range	Default setting	User setting	Reference
F 1 0	0110	Always-active function selection	-	-	0-51	0		6.3.1
F 1 1	0111	Input terminal selection 1 (F)	-	-	0-51 (F)	2		6.3.2
F 1 2	0112	Input terminal selection 2 (R)	-	-	0-51 (R)	3		6.3.2
F 1 3	0113	Input terminal selection 3 (RST)	-	-	0-51 (RST)	10		6.3.2
F 1 4	0114	Input terminal selection 4 (S1)	-	-	0-51 (SS1)	6		6.3.2
F 1 5	0115	Input terminal selection 5 (S2)	-	-	0-51 (SS2)	7		6.3.2
F 1 6	0116	Input terminal selection 6 (S3)	-	-	0-51 (SS3)	8		6.3.2
F 1 30	0130	Output terminal selection 1 (RY-RC)	-	-	0-29 (LOW)	4		6.3.3
F 1 31	0131	Output terminal selection 2 (OUT)	-	-	0-29 (RCH)	6		6.3.3
F 1 32	0132	Output terminal selection 3 (FL)	-	-	0-29 (FL)	10		6.3.3
F 1 70	0170	Base frequency 2	Hz	0.1	25-400	*1		6.4.1
F 1 72	0172	Torque boost 2	%(V)	0.1	0.0-30.0	*2		6.4.1
F 1 73	0173	Motor electronic-thermal protection level 2	%(A)	1	10-100	100		6.4.1

• Frequency parameters

Title	Communication No.	Function	Unit	Minimum setting unit	Adjustment range	Default setting	User setting	Reference
F 2 00	0200	Frequency priority selection	-	-	0: VIA/II, VIB 1: VIB, VIA/II 2: External switching (FCHG enabled) 3: External contact UP/DOWN *5 4: External contact UP/DOWN *5 (Setting retained even if the power is turned off) 5: VIA/II + VB	0		6.5.1
F 2 01	0201	VIA/II input point 1 setting	%	1	0-100	0		6.5.2
F 2 02	0202	VIA/II input point 1 frequency	Hz	0.1	0.0-400.0	0.0		6.5.2
F 2 03	0203	VIA/II input point 2 setting	%	1	0-100	100		6.5.2
F 2 04	0204	VIA/II input point 2 frequency	Hz	0.1	0.0-400.0	*1		6.5.2
F 2 10	0210	VIB input point 1 setting	%	1	0-100	0		6.5.2
F 2 11	0211	VIB input point 1 frequency	Hz	0.1	0.0-400.0	0.0		6.5.2
F 2 12	0212	VIB input point 2 setting	%	1	0-100	100		6.5.2
F 2 13	0213	VIB input point 2 frequency	Hz	0.1	0.0-400.0	0.0		6.5.2
F 2 14	0214	VIB input point 1 response time *5	(0.1s)	1	0-100	0		6.5.2
F 2 15	0215	VIB input point 2 response time *5	(0.1s)	1	0-100	100		6.5.2

*5 : Set the parameter F 2 00 to 3 or 4, function of F 2 10 ~ F 2 13 is bottom of paragraph.

Title	Communication No.	Function	Unit	Minimum setting unit	Adjustment range	Default setting	User setting	Reference
F213	0213	VIB input point 2 frequency Frequency DOWN step width *5	Hz	0.1 0.1	0-400 0.0-400.0	*1 *1		6.5.2
F240	0240	Starting frequency setting	Hz	0.1	0.5-10.0	0.5		6.6.1
F241	0241	Operation starting frequency	Hz	0.1	0.0- \overline{FH}	0.0		6.6.2
F242	0242	Operation starting frequency hysteresis	Hz	0.1	0.0- \overline{FH}	0.0		6.6.2
F250	0250	DC braking starting frequency	Hz	0.1	0.0- \overline{FH}	0.0		6.7.1
F251	0251	DC braking current	%(A)	1	0-100	30		6.7.1
F252	0252	DC braking time	s	0.1	0.0-20.0	1.0		6.7.1
F260	0260	Jog run stopping pattern	Hz	0.1	0.0-20.0	0.0		6.8
F261	0261	Jog run stoping pattern	-	-	0: Slowdown stop 1: Coast stop 2: DC braking	0		6.8
F270	0270	Jump frequency 1	Hz	0.1	$\overline{LL} - \overline{UL}$	0.0		6.9
F271	0271	Jumping width 1	Hz	0.1	0.0-30.0	0.0		6.9
F272	0272	Jump frequency 2	Hz	0.1	$\overline{LL} - \overline{UL}$	0.0		6.9
F273	0273	Jumping width 2	Hz	0.1	0.0-30.0	0.0		6.9
F274	0274	Jump frequency 3	Hz	0.1	$\overline{LL} - \overline{UL}$	0.0		6.9
F275	0275	Jumping width 3	Hz	0.1	0.0-30.0	0.0		6.9
F280	0280	Preset-speed operation frequencies 1	Hz	0.1	$\overline{LL} - \overline{UL}$	0.0		5.15
F281	0281	Preset-speed operation frequencies 2	Hz	0.1	$\overline{LL} - \overline{UL}$	0.0		
F282	0282	Preset-speed operation frequencies 3	Hz	0.1	$\overline{LL} - \overline{UL}$	0.0		
F283	0283	Preset-speed operation frequencies 4	Hz	0.1	$\overline{LL} - \overline{UL}$	0.0		
F284	0284	Preset-speed operation frequencies 5	Hz	0.1	$\overline{LL} - \overline{UL}$	0.0		
F285	0285	Preset-speed operation frequencies 6	Hz	0.1	$\overline{LL} - \overline{UL}$	0.0		
F286	0286	Preset-speed operation frequencies 7	Hz	0.1	$\overline{LL} - \overline{UL}$	0.0		
F287	0287	Preset-speed operation frequencies 8	Hz	0.1	$\overline{LL} - \overline{UL}$	0.0		
F288	0288	Preset-speed operation frequencies 9	Hz	0.1	$\overline{LL} - \overline{UL}$	0.0		
F289	0289	Preset-speed operation frequencies 10	Hz	0.1	$\overline{LL} - \overline{UL}$	0.0		
F290	0290	Preset-speed operation frequencies 11	Hz	0.1	$\overline{LL} - \overline{UL}$	0.0		
F291	0291	Preset-speed operation frequencies 12	Hz	0.1	$\overline{LL} - \overline{UL}$	0.0		
F292	0292	Preset-speed operation frequencies 13	Hz	0.1	$\overline{LL} - \overline{UL}$	0.0		
F293	0293	Preset-speed operation frequencies 14	Hz	0.1	$\overline{LL} - \overline{UL}$	0.0		
F294	0294	Preset-speed operation frequencies 15	Hz	0.1	$\overline{LL} - \overline{UL}$	0.0		

• Operation mode parameters

Title	Communication No.	Function	Unit	Minimum setting unit	Adjustment range	Default setting	User setting	Reference
F300	0300	PWM carrier frequency	kHz	0.1	2.0-16.5	12.0		6.11
F301	0301	Auto-restart control selection	-	-	0: Disabled 1: At auto-restart after momentary stop 2: When turning ST-CC on or off 3: At auto-restart or when turning ST-CC on or off 4: Motion of DC braking at start-up (at auto-restart after momentary stop) 5: Motion of DC braking at start-up (when turning ST-CC on or off) 6: Motion of DC braking at start-up (at auto-restart or when turning ST-CC on or off)	0		6.12.1
F302	0302	Regenerative power ride-through control	-	-	0: Disabled 1: Enabled	0		6.12.2
F303	0303	Retry selection (number of times)	Times	1	0-10	0		6.12.3
F304	0304	Dynamic braking selection	-	-	0: Dynamic braking disabled 1: Dynamic braking enabled, overload protection disabled 2: Dynamic braking enabled, overload protection enabled	0		6.12.4
F305	0305	Overvoltage limit operation	-	-	0: Enabled 1: Prohibited	0		6.12.5
F306	0306	Output voltage adjustment (Base frequency voltage)	V	1	0 to 250V, 0 to 500V	200V/400V		6.12.6
F307	0307	Supply voltage correction	-	-	0: Supply voltage uncorrected, output voltage limited 1: Supply voltage corrected, output voltage limited 2: Supply voltage corrected (off during deceleration), output voltage limited 3: Supply voltage uncorrected, output voltage unlimited 4: Supply voltage corrected, output voltage unlimited 5: Supply voltage corrected (off during deceleration), output voltage unlimited	1		6.12.6
F308	0308	Braking resistor operation rate	%ED	1	1-100	3		6.12.4
F312	0312	Random mode	-	-	0: Disabled 1: Enabled	0		6.11
F360	0360	PI control	-	-	0: Disabled 1: Enabled	0		6.12.7
F362	0362	Proportional gain	-	-	0.01-100.0	0.30		6.12.7
F363	0363	Integral gain	-	-	0.01-100.0	0.20		6.12.7

• Torque boost parameters

Title	Communication No.	Function	Unit	Minimum setting unit	Adjustment range	Default setting	User setting	Reference
F400	0400	Auto-tuning	-	-	0: Auto-tuning disabled (use of internal parameters) 1: Application of individual settings of F401 to F405 2: Auto-tuning enabled (returns to 1 after auto-tuning)	0		6.13
F401	0401	Slip frequency	Hz	-	0.0-10.0	*2		6.13
F402	0402	Motor primary constant	-	-	0-255	*2		6.13
F403	0403	Motor secondary constant	-	-	0-255	*2		6.13
F404	0404	Motor excitation constant	-	-	0-255	*2		6.13
F405	0405	Magnification of load inertial moment	Times	-	0-200	0		6.13
F408	0408	Rated capacity ratio of motor to inverter	-	-	0: Same capacity as inverter 1: One-size smaller than inverter	0		6.13

• Acceleration/deceleration time parameters

Title	Communication No.	Function	Unit	Minimum setting unit	Adjustment range	Default setting	User setting	Reference
F500	0500	Acceleration time 2	s	0.1	0.1-3600	10.0		6.14
F501	0501	Deceleration time 2	s	0.1	0.1-3600	10.0		6.14
F502	0502	Acceleration/deceleration 1 pattern	-	-	0: Linear 1: S-pattern 1 2: S-pattern 2	0		6.14
F503	0503	Acceleration/deceleration 2 pattern	-	-		0		6.14
F504	0504	Acceleration/deceleration pattern selection (1 or 2)	-	-	0: Acceleration/deceleration 1 1: Acceleration/deceleration 2	0		6.14
F505	0505	Acceleration/deceleration 1 and 2 switching frequency	Hz	0.1	0-1k	0.0		6.14

• Protection parameters

Title	Communication No.	Function	Unit	Minimum setting unit	Adjustment range	Default setting	User setting	Reference
F600	0600	Motor electronic-thermal protection level 1	%(A)	1	10-100	100		6.15.1
F601	0601	Stall prevention level	%(A)	1	10-199 200 (disabled)	150		6.15.2
F602	0602	Inverter trip retention selection	-	-	0: Not retained 1: Retained	0		6.15.3
F603	0603	External input trip stop mode selection	-	-	0: Coast stop 1: Slowdown stop 2: Emergency DC braking	0		6.15.4
F604	0604	Emergency DC braking time	s	0.1	0.0-20.0	1.0		6.15.4
F605	0605	Output phase failure detection mode selection	-	-	0: Disabled 1: Enabled (during operation) 2: Enabled (disabled during auto-restart)	0		6.15.5

Title	Communication No.	Function	Unit	Minimum setting unit	Adjustment range	Default setting	User setting	Reference
F608	0608	Input phase failure detection mode selection	-	-	0: Disabled 1: Enabled	1		6.15.6
F610	0610	Small current trip selection	-	-	0: Disabled 1: Enabled	0		6.15.7
F611	0611	Small current (trip/alarm) detection current	%	1	0-100	0		6.15.7
F612	0612	Small current (trip/alarm) detection time	s	1	0-255	0		6.15.7
F615	0615	Over-torque trip selection	-	-	0: Disabled 1: Enabled	0		6.15.8
F616	0616	Over-torque (trip/alarm) level	%	1	0-200	150		6.15.8
F618	0618	Over-torque detection time	s	0.1	0-10	0.5		6.15.8
F619	0619	Over-torque (trip alarm) level hysteresis	%	1	0-100	10		6.15.8
F627	0627	Undervoltage trip selection	-	-	0: Disabled 1: Enabled (Trip at 70% or less) 2: Disabled (Stop (not trip) at 50% or less)	0		6.15.9
F692	0692	Meter bias	%	1	0-50	0		6.15.10

• Operation panel parameters

Title	Communication No.	Function	Unit	Minimum setting unit	Adjustment range	Default setting	User setting	Reference
F700	0700	Prohibition of change of parameter settings	-	-	0: Permitted (F703 and F704 cannot be changed during operation.) 1: Prohibited 2: Permitted (F703 and F704 also can be changed during operation.)	0		6.16.1
F701	0701	Unit selection	-	-	0: No change 1: % → A (ampere)/V (volt) 2: Free unit selection enabled (F702) 3: % → A (ampere)/V (volt) Free unit selection enabled (F702)	0		6.16.2
F702	0702	Free unit selection	-	0.01	0.01-200.0	1.00		6.16.2
F710	0710	Standard monitor display selection	-	-	0: Operation frequency (Hz/free unit) 1: Output current (%A) 2: Frequency command (Hz/free unit) 3: Inverter rated current (A) 4: Inverter over load factor (%) 5: Output power (%)	0		6.16.3

• Communication parameters

Title	Communication No.	Function	Unit	Minimum setting unit	Adjustment range	Default setting	User setting	Reference
F800	0800	Communication band speed	-	-	0:1200bps, 1:2400bps, 2:4800bps 3:9600bps, 4:19200bps	3		6.17
F801	0801	Parity	-	-	0:NON, 1:EVEN, 2:ODD	1		6.17
F802	0802	Inverter number	-	1	0-63	0		6.17
F803	0803	Communication error trip time	s	1	0 (Disabled), 1-100	0		6.17

■ Default settings by inverter rating

Inverter model	Torque boost	Slip frequency	Motor primary constant	Motor secondary constant	Motor excitation constant
	U _b / F ₁ / r ₂	F ₄₀₁	F ₄₀₂	F ₄₀₃	F ₄₀₄
VFS9S-2002PL	6.0%	3.0Hz	33	35	35
VFS9S-2004PL	6.0%	3.0Hz	36	39	39
VFS9S-2007PL	6.0%	3.0Hz	36	28	44
VFS9S-2015PL	6.0%	2.7Hz	26	16	42
VFS9S-2022PL	5.0%	2.7Hz	28	17	44
VFS9-2002PM	6.0%	3.0Hz	33	35	35
VFS9-2004PM	6.0%	3.0Hz	36	39	39
VFS9-2007PM	6.0%	3.0Hz	36	28	44
VFS9-2015PM	6.0%	2.7Hz	26	16	42
VFS9-2022PM	5.0%	2.7Hz	28	17	44
VFS9-2037PM	5.0%	2.7Hz	27	15	37
VFS9-2055PL	4.0%	2.0Hz	17	11	37
VFS9-2075PL	3.0%	2.0Hz	13	12	36
VFS9-2110PM	2.0%	1.7Hz	13	11	42
VFS9-2150PM	2.0%	1.7Hz	9	11	37
VFS9-4007PL	6.0%	3.0Hz	27	15	38
VFS9-4015PL	6.0%	2.7Hz	28	16	39
VFS9-4022PL	5.0%	2.7Hz	28	39	39
VFS9-4037PL	5.0%	2.7Hz	28	26	41
VFS9-4055PL	4.0%	2.0Hz	17	11	43
VFS9-4075PL	3.0%	2.0Hz	13	12	37
VFS9-4110PL	2.0%	1.7Hz	13	11	42
VFS9-4150PL	2.0%	1.7Hz	9	11	37

■ Table of input terminal functions (1/3)

Function No.	Code	Function	Action
0	-	No function is assigned	Disabled
1	ST	Standby terminal	When F ₁ is set at <input type="checkbox"/> - ON: Gate on, OFF: Gate off (free-run) When F ₁ is set at <input type="checkbox"/> - OFF: Gate on, ON: Gate off (free-run)
2	F	Forward-run command	ON: Forward run OFF: Slowdown stop
3	R	Reverse-run command	ON: Reverse run OFF: Slowdown stop (Reverse run has priority.)
4	JOG	Jog run command	ON: Jog run, OFF: Jog run canceled
5	AD2	Acceleration/deceleration 2 pattern selection	ON: Acceleration/deceleration 2, OFF: Acceleration/deceleration 1
6	SS1	Preset-speed command 1	Selection of 15-speed with SS1 to SS4 (4 bits)
7	SS2	Preset-speed command 2	
8	SS3	Preset-speed command 3	
9	SS4	Preset-speed command 4	
10	RST	Reset command	ON → OFF: Trip reset
11	EXT	Trip stop command from external input device	ON: Trip stop
12	PNL/TB	Operation panel/terminal board switching	ON: Forced switching from panel control (Internal potentiometer)/terminal board control
13	DB	DC braking command	ON: DC braking
14	PI	Prohibition of PI control	ON: PI control prohibited OFF: PI control permitted
15	PWENE	Permission of parameter editing	ON: Parameter editing permitted, OFF: Parameter editing prohibited

■ Table of input terminal functions (2/3)

Function No.	Code	Function	Action
16	ST+RST	Combination of standby and reset commands	ON: Simultaneous input from ST and RST
17	ST+PNL/TB	Combination of standby and operation panel/terminal board switching	ON: Simultaneous input from ST and PNL/TB
18	F+JOG	Combination of forward run and jog run	ON: Simultaneous input from F and JOG
19	R+JOG	Combination of reverse run and jog run	ON: Simultaneous input from R and JOG
20	F+AD2	Combination of forward run and acceleration/deceleration 2	ON: Simultaneous input from F and AD2
21	R+AD2	Combination of reverse run and acceleration/deceleration 2	ON: Simultaneous input from R and AD2
22	F+SS1	Combination of forward run and preset-speed command 1	ON: Simultaneous input from F and SS1
23	R+SS1	Combination of reverse run and preset-speed command 1	ON: Simultaneous input from R and SS1
24	F+SS2	Combination of forward run and preset-speed command 2	ON: Simultaneous input from F and SS2
25	R+SS2	Combination of reverse run and preset-speed command 2	ON: Simultaneous input from R and SS2
26	F+SS3	Combination of forward run and preset-speed command 3	ON: Simultaneous input from F and SS3
27	R+SS3	Combination of reverse run and preset-speed command 3	ON: Simultaneous input from R and SS3
28	F+SS4	Combination of forward run and preset-speed command 4	ON: Simultaneous input from F and SS4
29	R+SS4	Combination of reverse run and preset-speed command 4	ON: Simultaneous input from R and SS4
30	F+SS1+AD2	Combination of forward run, preset-speed command 1 and acceleration/deceleration 2	ON: Simultaneous input from F, SS1 and AD2
31	R+SS1+AD2	Combination of reverse run, preset-speed command 1 and acceleration/deceleration 2	ON: Simultaneous input from R, SS1 and AD2
32	F+SS2+AD2	Combination of forward run, preset-speed command 2 and acceleration/deceleration 2	ON: Simultaneous input from F, SS2 and AD2
33	R+SS2+AD2	Combination of reverse run, preset-speed command 2 and acceleration/deceleration 2	ON: Simultaneous input from R, SS2 and AD2
34	F+SS3+AD2	Combination of forward run, preset-speed command 3 and acceleration/deceleration 2	ON: Simultaneous input from F, SS3 and AD2
35	R+SS3+AD2	Combination of reverse run, preset-speed command 3 and acceleration/deceleration 2	ON: Simultaneous input from R, SS3 and AD2
36	F+SS4+AD2	Combination of forward run, preset-speed command 4 and acceleration/deceleration 2	ON: Simultaneous input from F, SS4 and AD2
37	R+SS4+AD2	Combination of reverse run, preset-speed command 4 and acceleration/deceleration 2	ON: Simultaneous input from R, SS4 and AD2
38	FCHG	Frequency command forced switching	Enabled if F200:2 ON: VIB OFF: VIA/II
39	THR2	No. 2 thermal switching	ON: No. 2 thermal (Pc: 0, F 170, F 172, F 173) OFF: No. 1 thermal (Pc setting: u, ub, tHr)
40	MCHG	No. 2 motor switching	ON: No. 2 motor (Pc: 0, F 170, F 172, F 173, F500, F501, F503) OFF: No. 1 motor (Pc setting: u, ub, tHr, ACC, dEC, F502)
41	UP	Frequency UP signal input from external contacts	Enabled if F200:3,4 ON: Increase in frequency
42	DOWN	Frequency DOWN signal input from external contacts	Enabled if F200:3,4 ON: Decrease in frequency
43	CLR	Frequency UP/DOWN clear signal input from external contacts	Off→ON: Resetting of UP/DOWN frequency by means of external contacts
44	CLR+RST	Combination of frequency UP/DOWN clear and reset by means of external contacts	ON: Simultaneous input from CLR and RST

■ Table of input terminal functions (3/3)

Function No.	Code	Function	Action
45	EXTN	Inversion of trip stop command from external device	OFF: -trip stop
46	OH	Thermal trip stop signal input from external device	ON: trip stop
47	OHN	Inversion of thermal trip stop command from external device	OFF: trip stop
48	SC/LC	Remote/local control forced switching	Enabled when remote control is exercised ON: Local control (setting of and) OFF: Remote control
49	HD	Operation holding (stop of 3-wire operation)	ON: F (forward run)/R: (reverse run) held, 3-wire operation OFF: Slowdown stop
50	SDBF	Forward run after DC braking	ON: Forward run after DC braking OFF: Slowdown stop
51	SDBR	Reverse run after DC braking	ON: Reverse run after DC braking OFF: Slowdown stop

■ Table of output terminal functions (1/2)

Function No.	Code	Function	Action
0	LL	Frequency lower limit	ON: Output frequency is equal to or higher than L_L value. OFF: Output frequency is lower than L_L value.
1	LLN	Inversion of frequency lower limit	Inversion of LL setting
2	UL	Frequency upper limit	ON: Output frequency is equal to or higher than U_L value. OFF: Output frequency is lower than U_L value.
3	ULN	Inversion of frequency upper limit	Inversion of UL setting
4	LOW	Low-speed detection signal	ON: Output frequency is equal to or higher than F_{LO} set value. OFF: Output frequency is lower than F_{LO} set value.
5	LOWN	Inversion of low-speed detection signal	Inversion of LOW setting
6	RCH	Designated frequency reach signal (completion of acceleration/deceleration)	ON: Output frequency is within (input frequency $\pm F_{RCH}$ set frequency). OFF: Output frequency exceeds (input frequency $\pm F_{RCH}$ set frequency).
7	RCHN	Inversion of designated frequency reach signal (inversion of completion of acceleration/deceleration)	Inversion of RCH setting
8	RCHF	Set frequency reach signal	ON: Output frequency is within (F_{RCH} set frequency $\pm F_{RCHF}$ set frequency). OFF: Output frequency exceeds (F_{RCH} set frequency $\pm F_{RCHF}$ set frequency).
9	RCHFN	Inversion of set frequency reach signal	Inversion of RCHF setting
10	FL	Failure FL (trip output)	ON: When inverter is tripped OFF: When inverter is not tripped
11	FLN	Inversion of failure FL (inversion of trip output)	Inversion of FL setting
12	OT	Over-torque detection	ON: Torque current is equal to or larger than F_{OT} set value and longer than F_{OT} set time. OFF: Torque current is lower than F_{OT} set value.
13	OTN	Inversion of over-torque detection	Inversion of OT setting
14	RUN	RUN/STOP	ON: When operation frequency is output or during DC braking () OFF: Operation stopped

■ Table of output terminal functions (2/2)

Function No.	Code	Function	Action
15	RUNN	Inversion of RUN/STOP	Inversion of RUN setting
16	POL	OL pre-alarm	ON: 50% or more of calculated value of overload protection level OFF: Less than 50% of calculated value of overload protection level
17	POLN	Inversion of OL pre-alarm	Inversion of POL setting
18	POHR	Braking resistor overload pre-alarm	ON: 50% or more of calculated value of $F308$ set overload protection level OFF: Less than 50% of calculated value of $F308$ set overload protection level
19	POHRN	Inversion of braking resistor overload pre-alarm	Inversion of POHR setting
20	POT	Over-torque detection pre-alarm	ON: Torque current is equal to or larger than 70% of $F515$ set value. OFF: Torque current is smaller than 70% of $F515$ set value.
21	POTN	Inversion of over-torque detection pre-alarm	Inversion of POT setting
22	PAL	Pre-alarm	ON: When POL, POHR or POT is on, or $C1$, P or H issues an alarm OFF: When POL, POHR and POT are off, and $C1$, P and H issue no alarm
23	PALN	Inversion of pre-alarm	Inversion of PAL setting
24	UC	Low-current detection	ON: Output current is equal to or larger than $F512$ set value and longer than $F512$ set time. OFF: Output current is smaller than $F512$ set value.
25	UCN	Inversion of low-current detection	Inversion of UC setting
26	HFL	Hard fault	ON: Tripping ($OC1$, $OC2$, $OC3$, $OC4$, $OC5$, $EEPH1$, $EEPH2$, $EEPH3$, $EEPH4$, $EEPH5$, $OP1$, $OP2$, $OP3$, $OP4$, $OP5$, $OP6$, $OP7$, $OP8$, $OP9$, $OP10$, $OP11$, $OP12$, $OP13$, $OP14$, $OP15$, $OP16$, $OP17$, $OP18$, $OP19$, $OP20$, $OP21$, $OP22$, $OP23$, $OP24$, $OP25$, $OP26$, $OP27$, $OP28$, $OP29$, $OP30$, $OP31$, $OP32$, $OP33$, $OP34$, $OP35$, $OP36$, $OP37$, $OP38$, $OP39$, $OP40$, $OP41$, $OP42$, $OP43$, $OP44$, $OP45$, $OP46$, $OP47$, $OP48$, $OP49$, $OP50$, $OP51$, $OP52$, $OP53$, $OP54$, $OP55$, $OP56$, $OP57$, $OP58$, $OP59$, $OP60$, $OP61$, $OP62$, $OP63$, $OP64$, $OP65$, $OP66$, $OP67$, $OP68$, $OP69$, $OP70$, $OP71$, $OP72$, $OP73$, $OP74$, $OP75$, $OP76$, $OP77$, $OP78$, $OP79$, $OP80$, $OP81$, $OP82$, $OP83$, $OP84$, $OP85$, $OP86$, $OP87$, $OP88$, $OP89$, $OP90$, $OP91$, $OP92$, $OP93$, $OP94$, $OP95$, $OP96$, $OP97$, $OP98$, $OP99$, $OP100$) OFF: Failure other than the above
27	HFLN	Inversion of hard fault	Inversion of HFL setting
28	LFL	Soft fault	ON: Tripping ($OC1$, $OC2$, $OC3$, $OC4$, $OC5$, $EEPH1$, $EEPH2$, $EEPH3$, $EEPH4$, $EEPH5$, $OP1$, $OP2$, $OP3$, $OP4$, $OP5$, $OP6$, $OP7$, $OP8$, $OP9$, $OP10$, $OP11$, $OP12$, $OP13$, $OP14$, $OP15$, $OP16$, $OP17$, $OP18$, $OP19$, $OP20$, $OP21$, $OP22$, $OP23$, $OP24$, $OP25$, $OP26$, $OP27$, $OP28$, $OP29$, $OP30$, $OP31$, $OP32$, $OP33$, $OP34$, $OP35$, $OP36$, $OP37$, $OP38$, $OP39$, $OP40$, $OP41$, $OP42$, $OP43$, $OP44$, $OP45$, $OP46$, $OP47$, $OP48$, $OP49$, $OP50$, $OP51$, $OP52$, $OP53$, $OP54$, $OP55$, $OP56$, $OP57$, $OP58$, $OP59$, $OP60$, $OP61$, $OP62$, $OP63$, $OP64$, $OP65$, $OP66$, $OP67$, $OP68$, $OP69$, $OP70$, $OP71$, $OP72$, $OP73$, $OP74$, $OP75$, $OP76$, $OP77$, $OP78$, $OP79$, $OP80$, $OP81$, $OP82$, $OP83$, $OP84$, $OP85$, $OP86$, $OP87$, $OP88$, $OP89$, $OP90$, $OP91$, $OP92$, $OP93$, $OP94$, $OP95$, $OP96$, $OP97$, $OP98$, $OP99$, $OP100$) OFF: Failure other than the above
29	LFLN	Inversion of soft fault	Inversion of LFL setting

■ Order of precedence of combined functions

XX: Impossible combination, X: Invalid, +: Valid under some conditions, O: Valid, @: Priority

Function No. / Function	2	3	4	5	6-9	10	11	12	13	14	15	46	48	41/ 42	43	49	38	50/ 51	
2 Forward run command		X	O	O	O	O	X	O	X	O	O	X	O	O	O	O	O	O	+
3 Reverse run command	@		O	O	O	O	X	O	X	O	O	X	O	O	O	O	O	O	+
4 Jog run command (18/19)	+	+		@	+	O	X	O	X	@	O	X	O	+	O	XX	O	XX	
5 Acceleration/deceleration 2 selection	O	O	X		O	O	X	O	X	O	O	X	O	O	O	O	O	O	
6-9 Preset-speed run commands 1 to 4	O	O	X	O		O	X	O	X	O	O	X	O	O	O	O	O	O	
10 Reset command	O	O	O	O	O		X	O	O	O	O	X	O	O	O	O	O	O	
11 Trip stop command from external input device	@	@	@	@	@	@		O	@	@	O	X	O	@	O	@	O	@	
12 Operation panel/terminal board switching	O	O	O	O	O	O	O		O	O	O	O	O	O	O	O	O	O	
13 DC braking command	@	@	@	@	@	O	X	O		@	O	X	O	@	O	@	O	@	
14 PI control prohibition	O	O	X	O	O	O	X	O	X		O	X	O	XX	XX	O	O	O	
15 Permission of parameter editing	O	O	O	O	O	O	O	O	O	O		O	O	O	O	O	O	O	
46 Thermal trip stop command from external device	@	@	@	@	@	@	@	@	@	@	O		O	@	O	@	O	@	
48 Remote/local control forced switching	O	O	O	O	O	O	O	O	O	O	O	O		O	O	O	O	O	
41/ 42 Frequency UP/DOWN signal input from external contacts	O	O	X	O	O	O	X	O	X	XX	O	X	O		O	O	O	O	
43 Cleaning of UP/DOWN frequency with external contacts	O	O	O	O	O	O	O	O	O	XX	O	O	O	O		O	O	O	
49 Operation holding (cancellation of 3-wire operation)	O	O	XX	O	O	O	X	O	X	O	O	X	O	O	O		O	XX	
38 Frequency commands forced switching	O	O	O	O	O	O	O	O	O	O	O	O	O	O	O	O	O	O	
50/ 51 Operation command after DC braking	+	+	XX	O	O	O	X	O	X	O	O	X	O	O	O	XX	O		

* For the functions of combined terminals (combined functions), refer to the table of their respective functions.

12. Specifications

12.1 Models and their standard specifications

Standard specifications

Item		Specification									
Input voltage		3-phase 200V									
Applicable motor (kW)		0.2	0.4	0.75	1.5	2.2	3.7	5.5	7.5	11	15
Rating	Type	VFSS-									
	Form	2002PM	2004PM	2007PM	2015PM	2022PM	2037PM	2055PL	2075PL	2110PM	2150PM
	Capacity (kVA) Note 1)	0.6	1.3	1.8	3.0	4.2	6.7	10	13	21	25
	Rated output current (A) Note 2)	1.5	3.3	4.8	7.8	11.0	17.5	27.5	33	54	66
		(1.5)	(3.3)	(4.4)	(7.5)	(10.0)	(16.5)	25.0	(33)	(49)	(60)
Rated output voltage Note 3)		3-phase 200V to 230V									
Overload current rating		60 seconds at 150%, 0.5 seconds at 200%									
Power supply	Voltage-frequency	3-phase 200V to 230V – 50/60Hz									
	Allowable fluctuation	Voltage + 10%, -15% Note 4), frequency ±5%									
	Protective method	IP20 Enclosed type (JEM1030)									
Cooling method	Self cooling	Forced air-cooled									
Color	Munsel 5Y+8/0.5										
Built-in filter	Standard EMI filter					High-attenuation EMI filter			Standard EMI filter		

Item		Specification												
Input voltage		1-phase 200V					3-phase 400V							
Applicable motor (kW)		0.2	0.4	0.75	1.5	2.2	0.75	1.5	2.2	3.7	5.5	7.5	11	15
Rating	Type	VFSS-					VFSS-							
	Form	2002PL	2004PL	2007PL	2015PL	2022PL	4007PL	4015PL	4022PL	4037PL	4055PL	4075PL	4110PL	4150PL
	Capacity (kVA) Note 1)	0.6	1.3	1.8	3.0	4.2	1.8	3.1	4.2	7.2	11	13	21	25
	Rated output current (A) Note 2)	1.5	3.3	4.8	7.8	11.0	2.3	4.1	5.5	9.5	14.3	17.0	27.7	33
		(1.5)	(3.3)	(4.4)	(7.5)	(10.0)	(2.1)	(3.7)	(5.0)	(8.6)	(13.0)	(17.0)	(25.0)	(30)
Rated output voltage Note 3)		3-phase 200V to 240V					3-phase 380V to 500V							
Overload current rating		60 seconds at 150%, 0.5 seconds at 200%					60 seconds at 150%, 0.5 seconds at 200%							
Power supply	Voltage-frequency	3-phase 200V to 240V – 50/60Hz					3-phase 380V to 500V – 50/60Hz							
	Allowable fluctuation	Voltage +10%, -15% Note 4), frequency ±5%					Voltage +10%, -15% Note 4), frequency ±5%							
	Protective method	IP20 Enclosed type (JEM1030)					IP20 Enclosed type (JEM1030)							
Cooling method	Self cooling	Forced air-cooled				Forced air-cooled								
Color	Munsel 5Y+8/0.5					Munsel 5Y+8/0.5								
Built-in filter	High-attenuation EMI filter					High-attenuation EMI filter								

Note) 1. Capacity is calculated at 220V for the 200V models and at 440V for the 400V models.

Note) 2. Indicates rated output current setting when the PWM carrier frequency (parameter F300) is 4kHz or less.

When exceeding 4kHz, the rated output current setting is indicated in the parenthesis. When the input power voltage of the 400V class model exceeds 480V, it is necessary to further reduce the setting. The default setting of the PWM carrier frequency is 12kHz.

Note) 3. Maximum output voltage is the same as the input voltage.

Note) 4. ±10% when the inverter is used continuously (load of 100%).

	Item	Specification
Principal control functions	Control system	Sinusoidal PWM control
	Rated output voltage	Adjustable within a range of 100 to 120% of the corrected supply voltage (200/400V) (Unadjustable to any voltage higher than the input voltage).
	Output frequency range	0.5 to 400Hz, default setting: 0.5 to 80Hz, maximum frequency: 30 to 400Hz.
	Minimum setting steps of frequency	0.1Hz: operation panel setting, 0.2Hz: analog input (when the max. frequency is 100Hz).
	Frequency accuracy	Digital setting: within $\pm 0.01\%$ of the max. frequency (-10 to +50°C). Analog setting: within $\pm 0.5\%$ of the max. frequency (25°C $\pm 10^\circ\text{C}$).
	Voltage/frequency characteristics	V/f constant, variable torque, vector control, automatic torque boost, Base frequency and torque boost amount adjustable
Operation specifications	Frequency setting signal	Front potentiometer and external potentiometer (rated impedance of connectable potentiometer: 1 to 10k Ω), 0 to 10Vdc (input impedance: VIA=30.55k Ω , VB=30k Ω), 4 to 20mA dc (input impedance: 400 Ω). The characteristic can be set arbitrarily by two-point setting.
	Start-up frequency/frequency jump	Adjustable within a range of 0 to 10Hz / Up to 3 frequencies can be adjusted together with their widths.
	PWM carrier frequency (Note 1)	Adjustable within a range of 2.0 to 16.5Hz (default: 12kHz).
	Acceleration/deceleration time	0.1 to 3600 seconds, switchable between acceleration/deceleration time 1 and 2, selectable between S-pattern acceleration/deceleration 1 and 2.
	Retry operation	Restart after a check of the main circuit elements in case the protective function is activated: 10 times (Max.) (adjustable with a parameter).
	Dynamic braking DC braking	With a built-in dynamic braking circuit, external braking resistor available (optional). Braking start-up frequency: 0 to maximum frequency, braking rate: 0 to 100%, braking time: 0 to 20 seconds.
Protective function	Input terminal functions (selectable)	Forward/reverse run input signal, jog run input signal, standby signal, preset-speed operation input signal, reset input signal, etc./Switching between sink/source.
	Output terminal functions (selectable)	Frequency lower limit output signal, frequency upper limit output signal, low-speed detection output signal, specified speed attainment output signal, etc. Open collector, RY output.
	Failure detection signal	1c-contact output: 250vac/2A, $\cos\phi = 0.1$, 250vac/1A, $\cos\phi = 0.4$, 3Vdc/1A.
	Output for frequency meter/output for ammeter	Analog output: (1mA dc full-scale DC ammeter or 7.5Vdc full-scale DC ammeter / Rectifier-type AC voltmeter, 225% current Max. 1mA dc, 7.5Vdc full-scale), 4 to 20mA/0 to 20mA output.
	Protective function	Stall prevention, current limitation, over-current, output short circuit, over-voltage, over-voltage limitation, undervoltage, ground fault, power supply phase failure, output phase failure overload protection by electronic thermal function, armature over-load at start-up (5.5kW or larger), load-side over-torque at start, pre-alarm, overheat.
	Protection against momentary power failure	Auto-restart/non-stop control after momentary power failure.
Display function	Electronic thermal characteristic	Switching between standard motor/constant-torque VF motor, overload trip, overload stall selection.
	4-digit 7-segments LED	Frequency: inverter output frequency. Alarm: stall alarm "C", overvoltage alarm "P", overload alarm "L", overheat alarm "H". Status: inverter status (frequency, cause of activation of protective function, input/output voltage, output current, etc.) and parameter settings. Free-unit display: arbitrary unit (e.g. rotating speed) corresponding to output frequency.
	Indicator	Lamps indicating the inverter status by lighting, such as RUN lamp, MON lamp, PRG lamp, VEC lamp, ECN lamp, frequency setting potentiometer lamp, UP/DOWN key lamp and RUN key lamp. The charge lamp indicates that the main circuit capacitors are electrically charged.
Environments	Use environments	Indoor, altitude: 1000m (Max.), not exposed to direct sunlight, corrosive gas, explosive gas or vibration (less than 5.9m/s ²) (10 to 55Hz).
	Ambient temperature	-10 to +60°C (Note) 1,2,3
	Storage temperature	-20 to +65°C
	Relative humidity	20 to 93% (free from condensation and vapor).

Note) 1. Above 40°C : Remove the protective seal from the top of VF-S9.

Note) 2. Above 50°C : Remove the protective seal from the top of VF-S9, and derate the rated output current by 3% for every °C above 50°C.

Note) 3. Side-by-side installation

- Model of 3.7kW or less : from -10°C to 40°C (Remove the protective seal from the top of VF-S9).
- Model of 5.5kW or more : from -10°C to 50°C.

12.2 Outside dimensions and mass

■ Outside dimensions and mass

Input voltage	Applicable motor (kW)	Type	Dimensions (mm)						Drawing	Approx. weight (kg)						
			W	H	D	W1	H1	H2			D2					
1-phase 200V	0.2	VFS9S-2002PL									1.2					
	0.4	VFS9S-2004PL	105	130	140	93	118	14	8.5	A	1.3					
	0.75	VFS9S-2007PL									1.3					
	1.5	VFS9S-2015PL	130	150	150	118	138	1.8								
	2.2	VFS9S-2022PL	140	195	163	126	182	2.8								
0.2	VFS9-2002PM										1.1					
3-phase 200V	0.4	VFS9-2004PM	105	130	130	93	118	14	8.5	A	1.2					
	0.75	VFS9-2007PM													1.2	
	1.5	VFS9-2015PM									150	138	1.4			
	2.2	VFS9-2022PM	140	195	147	126	182				2.3					
	3.7	VFS9-2037PM					2.5									
	5.5	VFS9-2055PL	200	270	170	180	255			12	B	6.2				
	7.5	VFS9-2075PL														6.3
	11	VFS9-2110PM														9.8
	15	VFS9-2150PM	245	330	195	225	315			C	9.9					
	3-phase 400V	0.75	VFS9-4007PL	130	150	150	118			138	14	8.5	A	1.8		
		1.5	VFS9-4015PL													
2.2		VFS9-4022PL	140					195	163					126	182	2.7
3.7		VFS9-4037PL					2.9									
5.5		VFS9-4055PL	200	270	170	180	255	12	B	6.3						
7.5		VFS9-4075PL														6.3
11		VFS9-4110PL														9.8
15		VFS9-4150PL	245	330	195	225	315	C	9.8							

Note) Approx. weight of EMC plate

Drawing Fig.A : 0.1kg

Drawing Fig.B, C : 0.3kg

■ Outline drawing

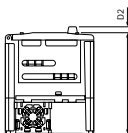
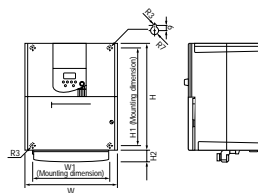
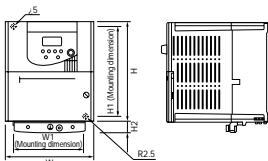

* VF-S9-2002PM and VF-S9S-2002PL don't have fan.

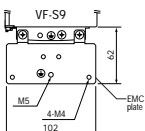

Fig. A

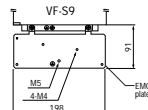
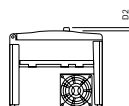

Fig. B

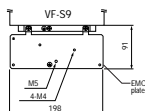
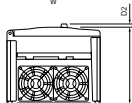
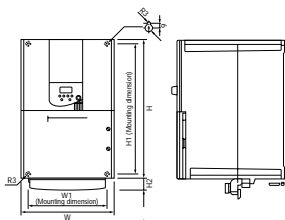

Fig. C

13. Before making a service call

- Trip information and remedies

13.1 Trip causes/warnings and remedies

When a problem arises, diagnose it in accordance with the following table. If it is found that replacement of parts is required or the problem cannot be solved by any remedy described in the table, contact your Toshiba dealer.

[Trip information]				
Error code	Communication No.	Problem	Possible causes	Remedies
OC1	0001	Overcurrent during acceleration	<ul style="list-style-type: none"> The acceleration time ACC is too short. The V/F setting is improper. A restart signal is input to the rotating motor after a momentary stop, etc. A special motor (e.g. motor with a small impedance) is used. 	<ul style="list-style-type: none"> Increase the acceleration time ACC. Check the V/F parameter. Use $F301$ (auto-restart) and $F302$ (ride-through control). Increase the carrier frequency $F303$.
OC2	0002	Overcurrent during deceleration	<ul style="list-style-type: none"> The deceleration time dEC is too short. (During deceleration) 	<ul style="list-style-type: none"> Increase the deceleration time dEC.
OC3	0003	Overcurrent during operation	<ul style="list-style-type: none"> The load fluctuates abruptly. The load is in an abnormal condition. 	<ul style="list-style-type: none"> Reduce the load fluctuation. Check the load (operated machine).
OC4	0005	Arm overcurrent at start-up	<ul style="list-style-type: none"> A main circuit element is defective. 	<ul style="list-style-type: none"> Make a service call.
OC5	0004	Overcurrent (An overcurrent on the load side at start-up)	<ul style="list-style-type: none"> The insulation of the output main circuit or motor is defective. The motor has too small impedance. 	<ul style="list-style-type: none"> Check the cables and wires for defective insulation.
OP1	000A	Overvoltage during acceleration	<ul style="list-style-type: none"> The input voltage fluctuates abnormally. (1) The power supply has a capacity of 200kVA or more. (2) A power factor improvement capacitor is opened or closed. (3) A system using a thyristor is connected to the same power distribution line. A restart signal is input to the rotating motor after a momentary stop, etc. 	<ul style="list-style-type: none"> Insert a suitable input reactor. Use $F301$ (auto-restart) and $F302$ (ride-through control).
OP2	000B	Overvoltage during deceleration	<ul style="list-style-type: none"> The deceleration time dEC is too short. (Regenerative energy is too large.) $F304$ (dynamic braking resistor activation) is off. $F305$ (overvoltage limit operation) is off. The input voltage fluctuates abnormally. (1) The power supply has a capacity of 200kVA or more. (2) A power factor improvement capacitor is opened or closed. (3) A system using a thyristor is connected to the same power distribution line. 	<ul style="list-style-type: none"> Increase the deceleration time dEC. Install a suitable dynamic braking resistor. Enable $F304$ (dynamic braking selection). Enable $F305$ (overvoltage limit operation). Insert a suitable input reactor.

(Continued overleaf)

(Continued)

Error code	Communication No.	Problem	Possible causes	Remedies
OP3	000C	Overvoltage during constant-speed operation	<ul style="list-style-type: none"> The input voltage fluctuates abnormally. (1) The power supply has a capacity of 200kVA or more. (2) A power factor improvement capacitor is opened or closed. (3) A system using a thyristor is connected to the same power distribution line. The motor is in a regenerative state because the load causes the motor to run at a frequency higher than the inverter output frequency. 	<ul style="list-style-type: none"> Insert a suitable input reactor. Install a dynamic braking resistor.
OL1	000D	Inverter overload	<ul style="list-style-type: none"> The acceleration time PCC is too short. The DC braking amount is too large. The V/F setting is improper. A restart signal is input to the rotating motor after a momentary stop, etc. The load is too large. 	<ul style="list-style-type: none"> Increase the acceleration time PCC. Reduce the DC braking amount $F252$ and the DC braking time $F252$. Check the V/F parameter setting. Use $F301$ (auto-restart) and $F302$ (ride-through control). Use an inverter with a larger rating.
OL2	000E	Motor overload	<ul style="list-style-type: none"> The V/F setting is improper. The motor is locked up. Low-speed operation is performed continuously. An excessive load is applied to the motor during operation. 	<ul style="list-style-type: none"> Check the V/F parameter setting. Check the load (operated machine). Adjust $OL1$ to the overload that the motor can withstand during operation in a low speed range.
*EPH0	0009	Output phase failure	<ul style="list-style-type: none"> A phase failure occurred in the output line of the main circuit. 	<ul style="list-style-type: none"> Check the main circuit output line, motor, etc., for phase failure. Enable $F605$ (Output phase failure detection).
*EPH1	0008	Input phase failure	<ul style="list-style-type: none"> A phase failure occurred in the input line of the main circuit. 	<ul style="list-style-type: none"> Check the main circuit input line for phase failure. Enable $F606$ (input phase failure detection).
OH2	002E	External thermal trip	<ul style="list-style-type: none"> A thermal trip command is entered from an external input device. 	<ul style="list-style-type: none"> Check the external input device.
*OT	0020	Over-torque trip	<ul style="list-style-type: none"> The load torque rises up to the over-torque detection level during operation 	<ul style="list-style-type: none"> Enable $F635$ (Over-torque trip selection) Check whether the system is in a normal condition.
OLr	000F	Dynamic braking resistor overload trip	<ul style="list-style-type: none"> The deceleration time is too short. The dynamic braking amount is too large. 	<ul style="list-style-type: none"> Increase the deceleration time dEC. Use a dynamic resistor with a larger capacity (W) and adjust $F303$ (PBR capacity parameter) accordingly.
OH	0010	Overheat	<ul style="list-style-type: none"> The cooling fan does not rotate. The ambient temperature is too high. The vent is blocked up. A heat generating device is installed close to the inverter. The thermistor in the unit is broken. 	<ul style="list-style-type: none"> Restart the operation by resetting the inverter after it has cooled down enough. The fan requires replacement if it does not rotate during operation. Secure sufficient space around the inverter. Do not place any heat-generating device near the inverter. Make a service call.
*UP1	001E	Undervoltage trip (main circuit)	<ul style="list-style-type: none"> The input voltage (in the main circuit) is too low. 	<ul style="list-style-type: none"> Check the input voltage. Enable $F627$ (undervoltage trip selection). To cope with a momentary stop due to undervoltage, enable $F302$ (ride-through control) and $F301$ (auto-restart).

* With a parameter, you can choose between trip-on and -off.

(Continued overleaf)

(Continued)

Error code	Communication No.	Problem	Possible causes	Remedies
U _C	001D	Small-current operation trip	<ul style="list-style-type: none"> The output current falls to the low-current detection level during operation. 	<ul style="list-style-type: none"> Enable F510 (low-current detection parameter). Check whether the detection level is set properly to the system. (F511 and F512.) If no error is found in the setting, make a service call.
E _{F2}	0022	Ground fault trip	<ul style="list-style-type: none"> A ground fault occurs in the output cable or the motor. 	<ul style="list-style-type: none"> Check the cable and the motor for ground faults.
E	0011	Emergency stop	<ul style="list-style-type: none"> During automatic operation or remote operation, a stop command is entered from the operation panel or a remote input device. 	<ul style="list-style-type: none"> Reset the inverter.
E _{r2}	0015	Main unit RAM fault	<ul style="list-style-type: none"> The control RAM is defective. 	<ul style="list-style-type: none"> Make a service call.
E _{r3}	0016	Main unit ROM fault	<ul style="list-style-type: none"> The control ROM is defective. 	<ul style="list-style-type: none"> Make a service call.
E _{r4}	0017	CPU fault trip	<ul style="list-style-type: none"> The control CPU is defective. 	<ul style="list-style-type: none"> Make a service call.
E _{r5}	0018	Remote control error	<ul style="list-style-type: none"> An error arises during remote operation. 	<ul style="list-style-type: none"> Check the remote control device, cables, etc.
E _{tyP}	0029	Inverter type error	<ul style="list-style-type: none"> The control circuit board (main circuit board or drive circuit board) is replaced. 	<ul style="list-style-type: none"> Make a service call.
E _{EP}	0012	EEPROM fault	<ul style="list-style-type: none"> A data writing error occurs. 	<ul style="list-style-type: none"> Turn off the inverter, then turn it on again. If it does not recover from the error, make a service call.
E _{tn}	0028	Auto-tuning error	<ul style="list-style-type: none"> Check the settings of the motor parameters F401 to F408. Check that the motor is not two or more sizes smaller in capacity than the inverter. Check that the inverter output cable is not too thin. Check that the motor is not running. Check that the motor is a three-phase inductive motor. 	

* With a parameter, you can choose between trip-on and -off.

[Alarm information] Each message in the table is displayed to give a warning but does not cause the inverter to trip.

Error code	Problem	Possible causes	Remedies
OFF (HOLD 1)	ST terminal OFF	<ul style="list-style-type: none"> The ST-CC circuit is opened. 	<ul style="list-style-type: none"> Close the ST-CC circuit.
UVFF	Undervoltage in main circuit	<ul style="list-style-type: none"> The supply voltage between R, S and T is under voltage. 	<ul style="list-style-type: none"> Measure the main circuit supply voltage. If the voltage is at a normal level, the inverter requires repairing.
RETRY	Retry in process	<ul style="list-style-type: none"> The inverter is in the process of retry. A momentary stop occurred. 	<ul style="list-style-type: none"> The inverter is normal if it restarts after several tens of seconds. The inverter restarts automatically. Be careful of the machine because it may suddenly restart.
E _{r1}	Frequency point setting error	<ul style="list-style-type: none"> The frequency setting signals at points 1 and 2 are set too close to each other. 	<ul style="list-style-type: none"> Set the frequency setting signals at points 1 and 2 apart from each other.
CLR	Clear command acceptable	<ul style="list-style-type: none"> This message is displayed when pressing the STOP key while an error code is displayed. 	<ul style="list-style-type: none"> Press the STOP key again to clear the trip.
E _{OFF}	Emergency stop command acceptable	<ul style="list-style-type: none"> The operation panel is used to stop the operation in automatic control or remote control mode. 	<ul style="list-style-type: none"> Press the STOP key for an emergency stop. To cancel the emergency stop, press any other key.
W _{ALD}	Setting error alarm / An error code and data are displayed alternately twice each.	<ul style="list-style-type: none"> An error is found in a setting when data is reading or writing. 	<ul style="list-style-type: none"> Check whether the setting is made correctly.

(Continued overleaf)

(Continued overleaf)

Error code	Problem	Possible causes	Remedies
db	DC braking	<ul style="list-style-type: none"> DC braking in process 	<ul style="list-style-type: none"> Normal if the message disappears after several tens of seconds. (See Note 2.)
in te	Parameters in the process of initialization	<ul style="list-style-type: none"> Parameters are being initialized to default values. 	<ul style="list-style-type: none"> Normal if the message disappears after a while (several seconds to several tens of seconds).
	Setup parameters in the process of being set	<ul style="list-style-type: none"> Setup parameters are in the process of being set. 	<ul style="list-style-type: none"> Normal if the message disappears after a while (several seconds to several tens of seconds).
Re n	Auto-tuning in process	<ul style="list-style-type: none"> Auto-tuning is in process. 	<ul style="list-style-type: none"> Normal if the message disappears after several seconds.

(Note 1) ST : Terminal of stand by function.

(Note 2) When the ON/OFF function is selected for DC braking (DB), using the input terminal selection parameter, you can judge the inverter to be normal if "db" disappears when opening the circuit between the terminal and CC.

[Alarms displayed during operation]

C	Overcurrent alarm	Same as CC (overcurrent)
P	Overvoltage alarm	Same as CP (overvoltage)
L	Overload alarm	Same as LL !/LL 2 (overload)
H	Overheat	Same as CH (overheat)

If two or more problems arise simultaneously, one of the following alarms appears and blinks.

CP, PL, CP

The blinking alarms C, P, L, H are displayed in this order from left to right.

13.2 Restoring the inverter from a trip

Do not reset the inverter when tripped because of a failure or error before eliminating the cause. Resetting the tripped inverter before eliminating the problem causes it to trip again.

The inverter can be restored from a trip by any of the following operations:

- (1) By turning off the power (Keep the inverter off until the LED turns off.)
Note Refer to 6.15.3 (inverter trip retention selection $F502$) for details.
- (2) By means of an external signal (Short-circuiting of control terminals RST and CC)
- (3) By operation panel operation
- (4) By inputting a trip clear signal from a remote input device
(Refer to the remote input device operating manual for details.)

To reset the inverter by operation panel operation, follow these steps.

1. Press the STOP key and make sure that OL is displayed.
 2. Pressing the STOP key again will reset the inverter if the cause of the trip has already been eliminated.
- ☆ When any overload function [$OL1$: inverter overload, $OL2$: motor overload, $OL3$: braking resistor overload] is active, the inverter cannot be reset by inputting a reset signal from an external device or by operation panel operation before the virtual cooling time has passed.

Virtual cooling time ... $OL1$: about 30 seconds after the occurrence of a trip
 $OL2$: about 120 seconds after the occurrence of a trip
 $OL3$: about 20 seconds after the occurrence of a trip

- ☆ In the case of a trip due to overheating (OT), the inverter checks the temperature within. Wait until the temperature in the inverter falls sufficiently before resetting the inverter.

[Caution]

Turning the inverter off then turning it on again resets the inverter immediately. You can use this mode of resetting if there is a need to reset the inverter immediately. Note, however, that this operation may damage the system or the motor if it is repeated frequently.

13.3 If the motor does not run while no trip message is displayed ...

If the motor does not run while no trip message is displayed, follow these steps to track down the cause.

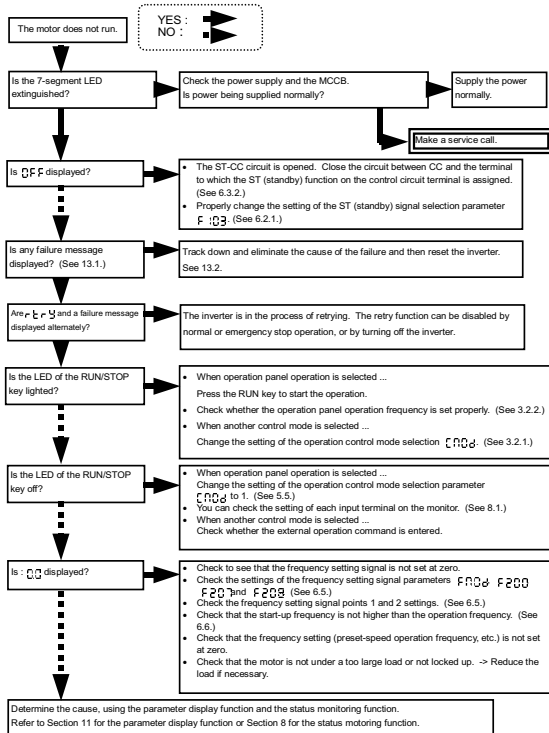

13.4 How to determine the causes of other problems



The following table provides a listing of other problems, their possible causes and remedies.

Problems	Causes and remedies
The motor runs in the wrong direction.	<ul style="list-style-type: none"> • Invert the phases of the output terminals U, V and W. • Invert the forward/reverse run-signal terminals of the external input device. (See 6.3 "Assignment of functions to control terminals".)
The motor runs but its speed does not change normally.	<ul style="list-style-type: none"> • The load is too heavy. Reduce the load. • The soft stall function is activated. Disable the soft stall function. (See 5.14.) • The maximum frequency f_H and the upper limit frequency f_{UL} are set too low. Increase the maximum frequency f_H and the upper limit frequency f_{UL}. • The frequency setting signal is too low. Check the signal set value, circuit, cables, etc. • Check the setting characteristics (point 1 and point 2 settings) of the frequency setting signal parameters. (See 6.5.) • If the motor runs at a low speed, check to see that the stall prevention function is activated because the torque boost amount is too large. Adjust the torque boost amount (U_b) and the acceleration time (R_{CC}). (See 5.12 and 5.1.)
The motor does not accelerate or decelerate smoothly.	<ul style="list-style-type: none"> • The acceleration time (R_{CC}) or the deceleration time (d_{EC}) is set too short. Increase the acceleration time (R_{CC}) or the deceleration time (d_{EC}).
A too large current flows into the motor.	<ul style="list-style-type: none"> • The load is too heavy. Reduce the load. • If the motor runs at a low speed, check whether the torque boost amount is too large. (See 5.13.)
The motor runs at a higher or lower speed than the specified one.	<ul style="list-style-type: none"> • The motor has an improper voltage rating. Use a motor with a proper voltage rating. • The motor terminal voltage is too low. Check the setting of the base frequency voltage parameter (F_{305}). (See 6.12.6.) Replace the cable with a cable larger in diameter. • The reduction gear ratio, etc., are not set properly. Adjust the reduction gear ratio, etc. • The output frequency is not set correctly. Check the output frequency range. • Adjust the base frequency. (See 5.11.)
The motor speed fluctuates during operation.	<ul style="list-style-type: none"> • The load is too heavy or too light. Reduce the load fluctuation. • The inverter or motor used does not have a rating large enough to drive the load. Use an inverter or motor with a rating large enough. • Check whether the frequency setting signal changes. • If the V/F control selection parameter P_{12} is set at 3, check the vector control setting, operation conditions, etc. (See 5.12.)
Parameter settings cannot be changed.	<ul style="list-style-type: none"> • Change the setting of the parameter F_{300} (prohibition of change of parameter setting) to 0 (permitted) if it is set at 1 (prohibited). For reasons of safety, some parameters cannot be reprogrammed while the inverter is running.

How to cope with parameter setting-related problems

If you forget parameters which have been reset	<ul style="list-style-type: none">• You can search for all reset parameters and change their settings. * Refer to 4.1.4 for details.
If you want to return all reset parameters to their respective default settings	<ul style="list-style-type: none">• You can return all parameters which have been reset to their default settings. * Refer to 4.1.6 for details.

14. Inspection and maintenance

 Danger	
 Danger Mandatory	<ul style="list-style-type: none"> • The equipment must be inspected every day. If the equipment is not inspected and maintained, errors and malfunctions may not be discovered which could lead to accidents. • Before inspection, perform the following steps. <ol style="list-style-type: none"> (1) Shut off all input power to the inverter. (2) Wait for at least ten minutes and check that the charge lamp is no longer lit. (3) Use a tester that can measure DC voltages (800V DC or more), and check that the voltage to the DC main circuits (across PA-PC) does not exceed 45V. Performing an inspection without carrying out these steps first could lead to electric shock. • When using switchgear for the inverter, it must be installed in a cabinet. Failure to do so can lead to risk of electric shock and can result in death or serious injury.

Be sure to inspect the inverter regularly and periodically to prevent it from breaking down because of the environment of use, such as temperature, humidity, dust and vibration, or deterioration of its components with aging.

14.1 Regular inspection

Since electronic parts are susceptible to heat, install the inverter in a cool, well-ventilated and dust-free place.

This is essential for increasing the service life.

The purpose of regular inspections is to maintain the correct environment of use and to find any sign of failure or malfunction by comparing current operation data with past operation records.

Subject of inspection	Inspection procedure			Criteria for judgement
	Inspection item	Inspection cycle	Inspection method	
1. Indoor environment	1) Dust, temperature and gas	Occasionally	1) Visual check, check by means of a thermometer, smell check	1) Improve the environment if it is found to be unfavorable. 2) Check for any trace of water condensation. 3) Max. temperature: 40°C (50°C inside the cabinet)
	2) Drops of water or other liquid	Occasionally	2) Visual check	
	3) Room temperature	Occasionally	3) Check by means of a thermometer	
2. Units and components	1) Vibration and noise	Occasionally	Tactile check of the cabinet	If something unusual is found, open the door and check the transformer, reactors, contactors, relays, cooling fan, etc., inside. If necessary, stop the operation.
3. Operation data (output side)	1) Load current	Occasionally	Moving-iron type AC ammeter	To be within the rated current, voltage and temperature. No significant difference from data collected in a normal state.
	2) Voltage (*)	Occasionally	Rectifier type AC voltmeter	
	3) Temperature	Occasionally	Thermometer	



*) The voltage measured may slightly vary from voltmeter to voltmeter. When measuring the voltage, always take readings from the same circuit tester or voltmeter.

■ Check points

1. Something unusual in the installation environment
2. Something unusual in the cooling system
3. Unusual vibration or noise
4. Overheating or discoloration
5. Unusual odor
6. Unusual motor vibration, noise or overheating

14.2 Periodical inspection

Make a periodical inspection at intervals of 3 or 6 months depending on the operating conditions.

 Danger	
 Mandatory	<ul style="list-style-type: none"> • Before inspection, perform the following steps. <ol style="list-style-type: none"> (1) Shut off all input power to the inverter. (2) Wait for at least ten minutes and check that the charge lamp is no longer lit. (3) Use a tester that can measure DC voltages (800V DC or more), and check that the voltage to the DC main circuits (across PA-PC) does not exceed 45V. <p>Performing an inspection without carrying out these steps first could lead to electric shock.</p>
 Prohibited	<ul style="list-style-type: none"> • Never replace any part. This could be a cause of electric shock, fire or bodily injury. To replace parts, call the local sales agency.

■ Check items

1. Check to see if all screwed terminals are tightened firmly. If any screw is found loose, tighten it again with a screwdriver.
2. Check to see if all crimped terminals are fixed properly. Check them visually to see that there is no trace of overheating around any of them.
3. Check visually all cables and wires for damage.
4. With a vacuum cleaner, remove dirt and dust, especially from the vents and the printed circuit boards. Always keep them clean to prevent an accident due to dirt or dust.
5. When leaving the inverter unused for a long time, check it for functioning once every 2 years or so by supplying it with electricity for at least 5 hours with the motor disconnected. It is advisable not to supply the commercial power directly to the inverter but to gradually increase the power supply voltage with a transformer.
6. If the need arises, conduct an insulation test on the main circuit terminal board only, using a 500V insulation tester. Never conduct an insulation test on control terminals other than terminals on the printed circuit board or on control terminals. When testing the motor for insulation performance, separate it from the inverter in advance by disconnecting the cables from the inverter output terminals U, V and W. When conducting an insulation test on peripheral circuits other than the motor circuit, disconnect all cables from the inverter so that no voltage is applied to the inverter during the test.

(Note) Before an insulation test, always disconnect all cables from the main circuit terminal board and test the inverter separately from other equipment.

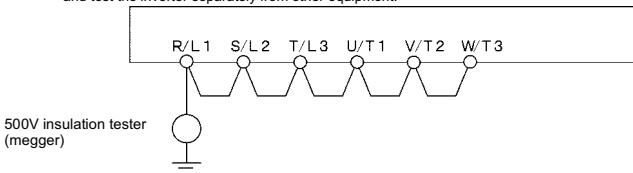

7. Never test the inverter for pressure. A pressure test may cause damage to its components.

8. Voltage and temperature check

Recommended voltmeter:

Input side ... Moving-iron type voltmeter 

Output side ... Rectifier type voltmeter 

It will be very helpful for detecting a defect if you always measure and record the ambient temperature before, during and after the operation.

■ Replacement of expendable parts

The inverter is composed of a large number of electronic parts including semiconductor devices. The following parts deteriorate with the passage of time because of their composition or physical properties. The use of aged or deteriorated parts leads to degradation in the performance or a breakdown of the inverter. To avoid such trouble, the inverter should be checked periodically.

(Note) Generally, the life of a part depends on the ambient temperature and the conditions of use. The life spans listed below are applicable to parts when used under normal environmental conditions.

1) Cooling fan

The fan, which cools down heat-generating parts, has a service life of about 30,000 hours (about 2 or 3 years of continuous operation). The fan also needs to be replaced if it makes a noise or vibrates abnormally.

2) Smoothing capacitor

The smoothing aluminum electrolytic capacitor in the main circuit DC section degrades in performance because of ripple currents, etc. It becomes necessary to replace the capacitor after it is used for about 5 years under normal conditions. If your inverter is intended for a 3.7kW or smaller motor, replace the smoothing capacitor together with the printed circuit board on which it is mounted.

<Criteria for appearance check>

- Absence of liquid leak
- Safety valve in the depressed position
- Measurement of electrostatic capacitance and insulation resistance

The operation time is helpful for roughly determining the time of replacement. For the replacement of parts, contact the service network or Toshiba branch office printed on the back cover of this instruction manual.

■ Standard replacement cycles of principal parts

The table below provides a listing of the replacement cycles of parts when used under normal conditions (average ambient temperature: 30°C, load factor: not more than 80%, operation time: 12 hours per day). The replacement cycle of each part does not mean its service life but the number of years over which its failure rate does not increase significantly.

Part name	Standard replacement cycle	Replacement mode and others
Cooling fan	2 to 3 years	Replacement with a new one
Smoothing capacitor	5 years	Replace with a new one (depending on the check results)
Circuit breaker and relays	-	Whether to replace or not depends on the check results
Timer	-	Whether to replace or not depends on the operation time
Fuse	10 years	Replacement with a new one
Aluminum capacitor on printed circuit board	5 years	Replace with a new circuit board (depending on the check results)

(Extract from "Guide to periodical inspections of general-purpose inverters" issued by the Japan Electric Industries Association.)

Note) The life of a part greatly varies depending on the environment of use.

14.3 Making a call for servicing

For the Toshiba service network, refer to the back cover of this instruction manual. If defective conditions are encountered, please contact the Toshiba service section in charge via your Toshiba dealer.

When making a call for servicing, please inform us of the contents of the rating label on the right panel of the inverter, the presence or absence of optional devices, etc., in addition to the details of the failure.

14.4 Keeping the inverter in storage

Take the following precautions when keeping the inverter in storage temporarily or for a long period of time.

1. Store the inverter in a well-ventilated place away from heat, damp, dust and metal powder.
2. If the printed circuit board in your inverter has an anti-static cover (black cover), do not leave it detached from the circuit board during storage, though the cover must be detached before turning on the inverter.
3. If no power is supplied to the inverter for a long time, the performance of its large-capacity electrolytic capacitor declines.

When leaving the inverter unused for a long time, supply it with electricity once every two years, for 5 hours or more each, to recover the performance of the large-capacity electrolytic capacitor and also to check the function of the inverter. It is advisable not to supply the commercial power directly to the inverter but to gradually increase the power supply voltage with a transformer, etc.



15. Warranty



Any part of the inverter that proves defective will be repaired and adjusted free of charge under the following conditions:

1. This warranty applies only to the inverter main unit.
2. Any part of the inverter which fails or is damaged under normal use within twelve months from the date of delivery shall be repaired free of charge.
3. For the following kinds of failure or damage, the repair cost shall be borne by the customer even within the warranty period.
 - Failure or damage caused by improper or incorrect use or handling, or unauthorized repair or modification of the inverter
 - Failure or damage caused by the inverter falling or an accident during transportation after the purchase
 - Failure or damage caused by fire, salty water or wind, corrosive gas, earthquake, storm or flood, lightning, abnormal voltage supply, or other natural disasters
 - Failure or damage caused by the use of the inverter for any purpose or application other than the intended one
4. All expenses incurred by Toshiba for on-site services shall be charged to the customer, unless a service contract is signed beforehand between the customer and Toshiba, in which case the service contract has priority over this warranty.

16. Disposal of the inverter

 Warning	
 Mandatory	<ul style="list-style-type: none">• If you throw away the inverter, have it done by a specialist in industry waste disposal*. If you throw away the inverter by yourself, this can result in explosion of capacitor or produce noxious gases, resulting in injury.(*) Persons who specialize in the processing of waste and known as "industrial waste product collectors and transporters" or "industrial waste disposal persons." If the collection, transport and disposal of industrial waste is done by someone who is not licensed for that job, it is a punishable violation of the law. (laws in regard to cleaning and processing of waste materials)

If you throw away the inverter, have it done by a specialist in industry waste disposal.

If you throw away the inverter by yourself, this can result in explosion of capacitor or produce noxious gases, resulting in injury.

Free Manuals Download Website

<http://myh66.com>

<http://usermanuals.us>

<http://www.somanuals.com>

<http://www.4manuals.cc>

<http://www.manual-lib.com>

<http://www.404manual.com>

<http://www.luxmanual.com>

<http://aubethermostatmanual.com>

Golf course search by state

<http://golfingnear.com>

Email search by domain

<http://emailbydomain.com>

Auto manuals search

<http://auto.somanuals.com>

TV manuals search

<http://tv.somanuals.com>