

# TOSHIBA

Leading Innovation >>>

## PX30 - A Series User's Guide

If you need assistance:

Technical support is available online at Toshiba's Web site at [support.toshiba.com](http://support.toshiba.com). At this Web site, you will find answers for many commonly asked technical questions plus many downloadable software drivers, BIOS updates, and other downloads.

For more information, see "If Something Goes Wrong" on [page 95](#) in this guide.

GMAD00357010  
06/13

---

## Model: PX30 - A Series

### Recordable and/or ReWritable Drive(s) and Associated Software Warranty

The computer system you purchased may include Recordable and/or ReWritable optical disc drive(s) and associated software, among the most advanced data storage technologies available. As with any new technology, you must read and follow all set-up and usage instructions in the applicable user guides and/or manuals enclosed or provided electronically. If you fail to do so, this product may not function properly and you may lose data or suffer other damage.

**TOSHIBA AMERICA INFORMATION SYSTEMS, INC. (“TOSHIBA”), ITS AFFILIATES AND SUPPLIERS DO NOT WARRANT THAT OPERATION OF THE PRODUCT WILL BE UNINTERRUPTED OR ERROR FREE. YOU AGREE THAT TOSHIBA, ITS AFFILIATES AND SUPPLIERS SHALL HAVE NO RESPONSIBILITY FOR DAMAGE TO OR LOSS OF ANY BUSINESS, PROFITS, PROGRAMS, DATA, NETWORK SYSTEMS OR REMOVABLE STORAGE MEDIA ARISING OUT OF OR RESULTING FROM THE USE OF THE PRODUCT, EVEN IF ADVISED OF THE POSSIBILITY THEREOF.**

### Protection of Stored Data

For your important data, please make periodic back-up copies of all the data stored on the hard disk or other storage devices as a precaution against possible failures, alteration, or loss of the data. **IF YOUR DATA IS ALTERED OR LOST DUE TO ANY TROUBLE, FAILURE OR MALFUNCTION OF THE HARD DISK DRIVE OR OTHER STORAGE DEVICES AND THE DATA CANNOT BE RECOVERED, TOSHIBA SHALL NOT BE LIABLE FOR ANY DAMAGE OR LOSS OF DATA, OR ANY OTHER DAMAGE RESULTING THEREFROM. WHEN COPYING OR TRANSFERRING YOUR DATA, PLEASE BE SURE TO CONFIRM WHETHER THE DATA HAS BEEN SUCCESSFULLY COPIED OR TRANSFERRED. TOSHIBA DISCLAIMS ANY LIABILITY FOR THE FAILURE TO COPY OR TRANSFER THE DATA CORRECTLY.**

### Critical Applications

The computer you have purchased is not designed for any “critical applications.” “Critical applications” means life support systems, medical applications, connections to implanted medical devices, commercial transportation, nuclear facilities or systems or any other applications where product failure could lead to injury to persons or loss of life or catastrophic property damage. **ACCORDINGLY,**

---

**TOSHIBA, ITS AFFILIATES AND SUPPLIERS DISCLAIM ANY AND ALL LIABILITY ARISING OUT OF THE USE OF THE COMPUTER PRODUCTS IN ANY CRITICAL APPLICATIONS. IF YOU USE THE COMPUTER PRODUCTS IN A CRITICAL APPLICATION, YOU, AND NOT TOSHIBA, ASSUME FULL RESPONSIBILITY FOR SUCH USE.**

## **FCC Notice “Declaration of Conformity Information”**

This equipment has been tested and found to comply with the limits for a Class B digital device, pursuant to Part 15 of the FCC rules. These limits are designed to provide reasonable protection against harmful interference in a residential installation.

This equipment generates, uses and can radiate radio frequency energy and, if not installed and used in accordance with the instructions, it may cause harmful interference to radio communications. However, there is no guarantee that interference will not occur in a particular installation. If this equipment does cause harmful interference to radio or television reception, which can be determined by turning the equipment off and on, the user is encouraged to try to correct the interference by one or more of the following measures:

- ❖ Reorient or relocate the receiving antenna.
- ❖ Increase the separation between the equipment and receiver.
- ❖ Connect the equipment to an outlet on a circuit different from that to which the receiver is connected.
- ❖ Consult the dealer or an experienced radio/TV technician for help.

---

### **NOTE**

Only Peripherals complying with the FCC Class B limits may be attached to this equipment. Operation with noncompliant peripherals or peripherals not recommended by Toshiba is likely to result in interference to radio and TV reception. Shielded cables must be used between the external devices and the computer's ports. Changes or modifications made to this equipment not expressly approved by Toshiba or parties authorized by Toshiba could void the user's authority to operate the equipment.

---

This device complies with Part 15 of the FCC Rules. Operation is subject to the following two conditions:

- ❖ This device may not cause harmful interference.

- ❖ This device must accept any interference received, including interference that may cause undesired operation.

Contact Toshiba's Support Website at [support.toshiba.com](http://support.toshiba.com).

## Bluetooth® Wireless Technology Interoperability

*Bluetooth*® Cards from TOSHIBA are designed to be interoperable with any product with *Bluetooth* wireless technology that is based on Frequency Hopping Spread Spectrum (FHSS) radio technology, and is compliant to:

- ❖ *Bluetooth* Specification as defined and approved by The *Bluetooth* Special Interest Group.
- ❖ Logo certification with *Bluetooth* wireless technology as defined by The *Bluetooth* Special Interest Group.

### CAUTION

Always use *Bluetooth* cards from TOSHIBA in order to enable wireless networks over two or more (up to a total of seven) TOSHIBA computers using these cards. Please contact TOSHIBA computer product support on Web site <http://www.toshiba-europe.com/computers/tnt/bluetooth.htm> in Europe or [support.toshiba.com](http://support.toshiba.com) in the United States for more information.

When you use *Bluetooth* cards from TOSHIBA close to 2.4 GHz Wireless LAN devices, *Bluetooth* transmissions might slow down or cause errors. If you detect certain interference while you use *Bluetooth* cards from TOSHIBA, always change the frequency, move your computer to the area outside of the interference range of 2.4 GHz Wireless LAN devices (40 meters/43.74 yards or more) or stop transmitting from your computer. Please contact TOSHIBA computer product support on Web site <http://www.toshiba-europe.com/computers/tnt/bluetooth.htm> in Europe or [support.toshiba.com](http://support.toshiba.com) in the United States for more information.

*Bluetooth* and Wireless LAN devices operate within the same radio frequency range and may interfere with one another. If you use *Bluetooth* and Wireless LAN devices simultaneously, you may occasionally experience a less than optimal network performance or even lose your network connection. If you should experience any such problem, immediately turn off either one of your *Bluetooth* or Wireless LAN. Please contact Toshiba computer product support on Web site <http://www.toshiba-europe.com/computers/tnt/bluetooth.htm> in Europe or [support.toshiba.com](http://support.toshiba.com) in the United States for more information.

---

## Bluetooth® Wireless Technology and Your Health

The products with *Bluetooth*® wireless technology, like other radio devices, emit radio frequency electromagnetic energy. The level of energy emitted by devices with *Bluetooth* wireless technology however is much less than the electromagnetic energy emitted by wireless devices such as mobile phones.

Because products with *Bluetooth* wireless technology operate within the guidelines found in radio frequency safety standards and recommendations, TOSHIBA believes *Bluetooth* wireless technology is safe for use by consumers. These standards and recommendations reflect the consensus of the scientific community and result from deliberations of panels and committees of scientists who continually review and interpret the extensive research literature.

In some situations or environments, the use of *Bluetooth* wireless technology may be restricted by the proprietor of the building or responsible representatives of the organization. These situations may, for example, include in any other environment where the risk of interference to other devices or services is perceived or identified as harmful.

If you are uncertain of the policy that applies on the use of wireless devices in a specific organization or environment (e.g. airports), you are encouraged to ask for authorization to use the device with *Bluetooth* wireless technology prior to turning on the equipment.

---

**CAUTION****Exposure to Radio Frequency Radiation**

The radiated output power of the *Bluetooth* Card from TOSHIBA is far below the FCC radio frequency exposure limits. Nevertheless, the *Bluetooth* Card from TOSHIBA shall be used in such a manner that the potential for human contact during normal operation is minimized.

---

## Wireless Interoperability

The TOSHIBA Wireless LAN Mini PCI Card products are designed to be interoperable with any wireless LAN product that is based on Direct Sequence Spread Spectrum (DSSS) radio technology, and is compliant to:

- ❖ The IEEE 802.11 Standard on Wireless LANs (Revision A/B/G), as defined and approved by the Institute of Electrical and Electronics Engineers.
- ❖ The Wireless Fidelity (Wi-Fi®) certification as defined by the Wi-Fi Alliance. The “Wi-Fi CERTIFIED” logo is a certification mark of the Wi-Fi Alliance.

---

## Wireless LAN and Your Health

Wireless LAN products, like other radio devices, emit radio frequency electromagnetic energy. The level of energy emitted by Wireless LAN devices however is far much less than the electromagnetic energy emitted by wireless devices like for example mobile phones.

Because Wireless LAN products operate within the guidelines found in radio frequency safety standards and recommendations, TOSHIBA believes Wireless LAN is safe for use by consumers. These standards and recommendations reflect the consensus of the scientific community and result from deliberations of panels and committees of scientists who continually review and interpret the extensive research literature.

In some situations or environments, the use of Wireless LAN may be restricted by the proprietor of the building or responsible representatives of the organization. These situations may for example include:

- ❖ Using the Wireless LAN equipment on board airplanes, or
- ❖ In any other environment where the risk of interference to other devices or services is perceived or identified as harmful.

If you are uncertain of the policy that applies on the use of wireless devices in a specific organization or environment (e.g. airports), you are encouraged to ask for authorization to use the Wireless LAN device prior to turning on the equipment.

---

**CAUTION****Exposure to Radio Frequency Radiation**

The radiated output power of the TOSHIBA Wireless LAN Mini PCI Card is far below the FCC radio frequency exposure limits. Nevertheless, the TOSHIBA Wireless LAN Mini PCI Card shall be used in such a manner that the potential for human contact during normal operation is minimized. The antenna(s) used for this transmitter must not be co-located or operating in conjunction with any other antenna or transmitter.

---

## Regulatory Information

The TOSHIBA Wireless LAN Mini PCI Card must be installed and used in strict accordance with the manufacturer's instructions as described in the user documentation that comes with the product. This device complies with the following radio frequency and safety standards.

## Regulatory statements

This product complies with any mandatory product specification in any country/region where the product is sold.

## Optical Disc Drive Safety Instructions

### **⚠ DANGER**

This appliance contains a laser system and is classified as a CLASS 1 LASER PRODUCT. To use this model properly, read the User's Guide carefully and keep it for your future reference.

Never attempt to disassemble, adjust or repair an optical disc drive. You could damage the drive. You would also be exposed to laser light or other safety hazards, resulting in serious injury. Always contact an authorized Toshiba service provider, if any repair or adjustment is required.

CLASS 1 LASER PRODUCT  
LASERKLASSE 1

## Location of the Required Label

(Sample shown below. Location of the label and manufacturing information may vary.)

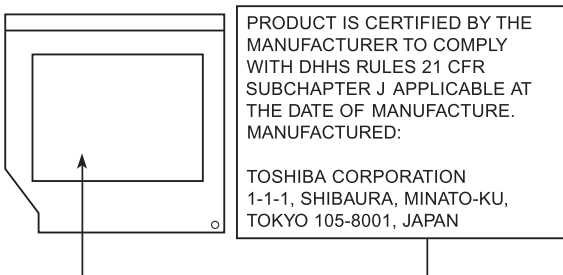

## Canada – Industry Canada (IC)

This Class B digital apparatus complies with Canadian ICES-003.

Cet appareil numérique de la classe B est conforme à la norme NMB-003 du Canada.

This device complies with RSS 210 of Industry Canada.

Cet appareil numérique est conforme à la norme CNR-210 du Canada.

---

---

**CAUTION** The installer of this radio equipment must ensure that the antenna is located or pointed such that it does not emit RF field in excess of Health Canada limits for the general population; consult Safety Code 6, obtainable from Health Canada's Web site [www.hc-sc.gc.ca/rpb](http://www.hc-sc.gc.ca/rpb). The RF device shall not be co-located with any other transmitter that has not been tested with this device.

---

Operation is subject to the following two conditions: (1) this device may not cause interference, and (2) this device must accept any interference, including interference that may cause undesired operation of this device.

L' utilisation de ce dispositif est soumis aux deux conditions suivantes: (1) il ne doit pas produire de brouillage et (2) l'utilisateur du dispositif doit être prêt à accepter tout brouillage radioélectrique reçu, même s'il est susceptible de compromettre son fonctionnement.

The term "IC" before the equipment certification number only signifies that the Industry Canada technical specifications were met.

To prevent radio interference to the licensed service, this device is intended to be operated indoors and away from windows to provide maximum shielding. Equipment (or its transmit antenna) that is installed outdoors is subject to licensing.

Pour empêcher que cet appareil cause du brouillage au service faisant l'objet d'une licence, il doit être utilisé à l'intérieur et devrait être placé loin des fenêtres afin de fournir un écran de blindage maximal. Si le matériel (ou son antenne d'émission) est installé à l'extérieur, il doit faire l'objet d'une licence.

---

**CAUTION** This device is restricted to indoor use due to its operation in the 5.15 GHz to 5.25 GHz frequency range. Industry Canada requires this product to be used indoors for frequency range 5.15 GHz to 5.25 GHz to reduce the potential for harmful interference to co-channel Mobile Satellite systems.

Please note that high-power radars are allocated as primary users of the 5.25 GHz to 5.35 GHz and 5.65 GHz to 5.85 GHz bands. These radar stations can cause interference with and/or damage this device.

---

Les dispositifs fonctionnant dans la bande 5150-5250 MHz sont réservés uniquement pour une utilisation à l'intérieur afin de réduire les risques de brouillage préjudiciable aux systèmes de satellites mobiles utilisant les mêmes canaux.



---

Veillez noter que les utilisateurs de radars de haute puissance sont désignés utilisateurs principaux (c.-à-d., qu'ils ont la priorité) pour les bandes 5250-5350 MHz et 5650-5850 MHz et que ces radars pourraient causer du brouillage et/ou des dommages aux dispositifs LAN-EL.

---

**NOTE** The above caution applies to products that operate with an 802.11a radio device.

---

## Copyright

This guide is copyrighted by Toshiba America Information Systems, Inc. with all rights reserved. Under the copyright laws, this guide cannot be reproduced in any form without the prior written permission of Toshiba. No patent liability is assumed, however, with respect to the use of the information contained herein.

©2013 by Toshiba America Information Systems, Inc. All rights reserved.

## Export Administration Regulation

This document contains technical data that may be controlled under the U.S. Export Administration Regulations, and may be subject to the approval of the U.S. Department of Commerce prior to export. Any export, directly or indirectly, in contravention of the U.S. Export Administration Regulations is prohibited.

## Notice

The information contained in this manual, including but not limited to any product specifications, is subject to change without notice.

**TOSHIBA CORPORATION AND TOSHIBA AMERICA INFORMATION SYSTEMS, INC. (TOSHIBA) PROVIDES NO WARRANTY WITH REGARD TO THIS MANUAL OR ANY OTHER INFORMATION CONTAINED HEREIN AND HEREBY EXPRESSLY DISCLAIMS ANY IMPLIED WARRANTIES OF MERCHANTABILITY OR FITNESS FOR ANY PARTICULAR PURPOSE WITH REGARD TO ANY OF THE FOREGOING. TOSHIBA ASSUMES NO LIABILITY FOR ANY DAMAGES INCURRED DIRECTLY OR INDIRECTLY FROM ANY TECHNICAL OR TYPOGRAPHICAL ERRORS OR OMISSIONS CONTAINED HEREIN OR FOR DISCREPANCIES BETWEEN THE PRODUCT AND THE MANUAL. IN NO EVENT SHALL TOSHIBA BE LIABLE FOR ANY INCIDENTAL, CONSEQUENTIAL, SPECIAL, OR EXEMPLARY DAMAGES, WHETHER BASED ON TORT, CONTRACT OR OTHERWISE, ARISING OUT OF OR IN CONNECTION WITH THIS MANUAL OR ANY OTHER INFORMATION CONTAINED HEREIN OR THE USE THEREOF.**

---

## Trademarks

eco Utility is a registered trademark of Toshiba America Information Systems, Inc. and/or Toshiba Corporation.

Adobe and Photoshop are either registered trademarks or trademarks of Adobe Systems Incorporated in the United States and/or other countries.

Atheros is a registered trademark of Atheros Communications, Inc.

Bluetooth word mark and logos are owned by the Bluetooth SIG, Inc. and any use of such marks by Toshiba is under license. Other trademarks and trade names are those of their respective owners.

The terms HDMI and HDMI High-Definition Multimedia Interface, and the HDMI logo are trademarks or registered trademarks of HDMI Licensing LLC in the United States and other countries.

Intel, Intel Core, Celeron, Centrino and Pentium are trademarks or registered trademarks of Intel Corporation or its subsidiaries in the United States and other countries.

Memory Stick, Memory Stick PRO, and Memory Stick PRO Duo are trademarks or registered trademarks of Sony Corporation.

Microsoft, Outlook, Windows, and Windows Media are either registered trademarks or trademarks of Microsoft Corporation in the United States and/or other countries.

MultiMediaCard and MMC are registered trademarks of MultiMediaCard Association.

Secure Digital and SD are trademarks of SD Card Association.

Wi-Fi is a registered trademark of the Wi-Fi Alliance.

All other brand and product names are trademarks or registered trademarks of their respective companies.

## Licenses

This Product is licensed under the AVC, the VC-1 and the MPEG-4 Part 2 Visual patent portfolio licenses for the personal and non-commercial use of a consumer to (i) encode video in compliance with the above standards (“Video Standards”) and/or (ii) decode AVC, VC-1 and MPEG-4 Part 2 Visual that was encoded by a consumer engaged in personal and non-commercial activity or was obtained from a video provider licensed to provide such video. None of the licenses extend to any other product regardless of whether such product is included with this product in a single article. No license is granted or shall be implied for any other use. Additional information may be obtained from MPEG LA, LLC.

See [www.mpegla.com](http://www.mpegla.com).

---

## Computer Recycling Information

As part of a commitment to people and the future, Toshiba promotes the efficient use of resources by working to achieve our zero-waste-to-landfill goal at all our production sites. In addition to our existing waste reduction and recycling policies, Toshiba is strongly committed to reducing electronic waste. In order to ensure efficient use of resources and appropriate treatment of hazardous substances, in accordance with recycling regulations in each state, country, and territory, Toshiba wants to make it easy for customers to recycle products at the end of the life cycle. To learn more about Toshiba's sustainability commitment, visit [us.toshiba.com/green](https://us.toshiba.com/green).

## Reuse, Donation, Recycling

Functional computers can be donated to a local charity or resold through other programs. Non working Toshiba computers can be mailed-back for free recycling. For additional details, please visit [us.toshiba.com/recycle](https://us.toshiba.com/recycle).

# Contents

---

Introduction.....	17
This guide .....	19
Safety icons .....	20
Other icons used.....	20
Your computer's features and specifications .....	21
Other documentation.....	21
Service options .....	21
Chapter 1: Getting Started.....	22
Setting up a work environment.....	22
Precautions .....	23
Important information on your computer's cooling fan.....	24
Setting up your computer .....	25
Connecting to a power source .....	25
Using the computer for the first time.....	27
Turning on the power .....	28
Initial setup.....	28
Setting up your software.....	28
Registering your computer with Toshiba.....	29
To Shut down your computer.....	29

---

To Restart your computer .....	30
To place your computer in Sleep mode.....	31
Adding optional external devices.....	31
Recovering the Internal Storage Drive .....	32
Creating recovery media.....	33
Restoring from recovery media.....	35
Refresh your PC (with user's data) .....	37
Reset your PC .....	39
Installing drivers and applications.....	41
Connecting an external device .....	42
Using external display devices .....	43
Using the HDMI™ In port.....	43
Using the HDMI™ Out port.....	43
Selecting video cables .....	44
Connecting an HDMI™-compatible television or display device .....	44
Customizing your computer's settings .....	44
Caring for your computer.....	45
Cleaning the computer.....	45
Moving the computer.....	45
Using a computer lock.....	46
<b>Chapter 2: Learning the Basics .....</b>	<b>47</b>
Computing tips .....	47
Using the wireless mouse.....	48
Replacing the battery .....	49
Using the wireless keyboard.....	50
Replacing the battery .....	50
Keyboard functions.....	51
Function keys.....	51
Special Windows® keys .....	52
Touch screen .....	52
Touch screen navigation.....	52
Starting an app .....	53
Starting an app from the Start screen .....	53
Saving your work .....	54
Backing up your work.....	54
Using the optical disc drive .....	55
Optical disc drive components .....	56

---

Inserting an optical disc .....	56
Playing optical media.....	58
Recording optical media.....	58
Removing a disc with the computer on .....	59
Removing a disc with the computer off .....	60
Toshiba's online resources .....	60
<b>Chapter 3: Computing.....</b>	<b>61</b>
Toshiba's energy-saver design.....	61
Power management.....	61
Charging the RTC battery .....	62
Power Plans .....	63
Using the eco power plan.....	64
<b>Chapter 4: Exploring Your Computer's Features....</b>	<b>65</b>
Exploring the Start screen .....	65
Charms.....	66
Tiles.....	67
Exploring the desktop.....	67
Finding your way around the desktop .....	67
Windows® Store.....	69
Setting up for communications.....	70
Connecting your computer to a network .....	70
Exploring audio features .....	71
Recording sounds.....	71
Using external speakers or headphones .....	72
Using the Web Camera.....	72
Using the Memory card reader .....	73
Inserting memory media .....	73
Removing memory media.....	74
<b>Chapter 5: Utilities.....</b>	<b>76</b>
Desktop Assist.....	77
Media & Entertainment .....	78
Tools & Utilities .....	79
Support & Recovery.....	80
eco Utility® .....	81
Password Utility.....	82
Using a supervisor password .....	82
Using a user password .....	84

---

Deleting a user password .....	85
System Settings .....	86
Sleep Utilities .....	88
USB Sleep and Charge .....	88
Enabling/Disabling USB Sleep and Charge .....	89
Power supply mode settings .....	90
Sleep and Music .....	90
TOSHIBA function key .....	92
Recovery Media Creator .....	93
Service Station .....	93
TOSHIBA Application Installer .....	94
<b>Chapter 6: If Something Goes Wrong .....</b>	<b>95</b>
Problems that are easy to fix .....	95
Problems when you turn on the computer .....	96
The Windows® operating system is not working .....	97
Using Startup options to fix problems .....	97
Internet problems .....	100
The Windows® operating system can help you .....	100
Fixing a problem with Device Manager .....	101
Checking device properties .....	101
Memory problems .....	102
Power and the battery .....	103
Keyboard problems .....	103
Display problems .....	103
Disk or storage drive problems .....	104
Error-checking .....	104
Optical disc drive problems .....	106
Sound system problems .....	108
Printer problems .....	108
Wireless networking problems .....	109
DVD operating problems .....	111
Develop good computing habits .....	112
Data and system configuration backup in the Windows® operating system .....	113

If you need further assistance.....	118
Contacting Toshiba.....	118
Other Toshiba Internet Web sites .....	118
Toshiba's worldwide offices .....	119
Appendix A: TOSHIBA Function Keys .....	120
Functions .....	120
Help file .....	121
Display brightness .....	121
Internet and Media Control buttons.....	122
Volume Mute.....	123
Disabling or enabling wireless devices .....	123
Keyboard Function keys .....	123
Zoom (Display resolution) .....	123
Appendix B: Power Cord/Cable Connectors .....	124
Glossary .....	125
Index .....	142



# Introduction

---

Welcome to the world of powerful, multimedia computing.



Your computer is ENERGY STAR® qualified.

Toshiba is a partner in the Environmental Protection Agency's (EPA) ENERGY STAR® Program and has designed this computer to meet the latest ENERGY STAR® guidelines for energy efficiency. Your computer ships with the power management options preset to a configuration that will provide the most stable operating environment and optimum system performance for both AC power and battery modes.

To conserve energy, your computer ships with default power settings that will turn off the display or enter low-power Sleep mode after a specific amount of inactivity. We recommend that you leave this and other energy saving features active, so that your computer will operate at its maximum energy efficiency. You can wake the computer from Sleep mode by pressing the power button. See the "Mobile Computing" section of the Toshiba User's Guide for more information on using power management settings to conserve computer energy.

When considering additions to your home office, purchase products that have earned the ENERGY STAR® for all your equipment needs, which can save you money, save energy, and help protect the climate.

Visit [www.energystar.gov](http://www.energystar.gov) or [www.energystar.gov/powermanagement](http://www.energystar.gov/powermanagement) for more information regarding the ENERGY STAR® Program

---

**NOTE** This computer is compatible with European Union Directive 2002/95/EC, Restriction of the use of certain Hazardous Substances in electrical and electronic equipment (RoHS), which restricts use of lead, cadmium, mercury, hexavalent chromium, PBB, and PBDE. Toshiba requires its computer component suppliers to meet RoHS requirements and verifies its suppliers' commitment to meeting RoHS requirements by conducting component sampling inspections during the product design approval process.

---

**NOTE** Certain Microsoft® software product(s) included with this computer may use technological measures for copy protection. IN SUCH EVENT, YOU WILL NOT BE ABLE TO USE THE PRODUCT IF YOU DO NOT FULLY COMPLY WITH THE PRODUCT ACTIVATION PROCEDURES. Product activation procedures and Microsoft's privacy policy will be detailed during initial launch of the product, or upon certain reinstallations of the software product(s) or reconfigurations of the computer, and may be completed by Internet or telephone (toll charges may apply).

Some software may differ from its retail version (if available), and may not include user manuals or all program functionality.

---

---

**NOTE**

The product specifications and configuration information are designed for a product Series. Your particular model may not have all the features and specifications listed or illustrated. For more detailed information about the features and specifications on your particular model, please visit Toshiba's Web site at [support.toshiba.com](http://support.toshiba.com).

While Toshiba has made every effort at the time of publication to ensure the accuracy of the information provided herein, product specifications, configurations, prices, system/component/options availability are all subject to change without notice. For the most up-to-date product information about your computer, or to stay current with the various computer software or hardware options, visit Toshiba's Web site at [support.toshiba.com](http://support.toshiba.com).

---

## This guide

This guide introduces the computer's features as well as some basic procedures needed to perform tasks in Windows 8.

You can:

- ❖ Read the entire guide from beginning to end.
- ❖ Skim through and stop when a topic interests you.
- ❖ Use the table of contents and the index to find specific information.

## Safety icons

This manual contains safety instructions that must be observed to avoid potential hazards that could result in personal injuries, damage to your equipment, or loss of data. These safety cautions have been classified according to the seriousness of the risk, and icons highlight these instructions as follows:

---

**▲ DANGER** Indicates an imminently hazardous situation which, if not avoided, will result in death or serious injury.

---

---

**▲ WARNING** Indicates a potentially hazardous situation which, if not avoided, could result in death or serious injury.

---

---

**▲ CAUTION** Indicates a potentially hazardous situation which, if not avoided, may result in minor or moderate injury.

---

---

**CAUTION** Indicates a potentially hazardous situation which, if not avoided, may result in property damage.

---

---

**NOTE** Provides important information.

---

## Other icons used

Additional icons highlight other helpful or educational information:



**TECHNICAL NOTE:** This icon indicates technical information about the computer.

---



**HINT:** This icon indicates helpful hints and tips.

---



**DEFINITION:** This icon indicates the definition of a term used in the text.

---

## Your computer's features and specifications

Certain computer chassis are designed to accommodate all possible configurations for an entire product Series. Your select model may not have all the features and specifications corresponding to all of the icons or switches shown on the computer chassis, unless you have selected all those features.

This information applies to all the features and icons described in this guide.

Below are examples of some of the many possible icons used on your computer:



*(Sample Illustration) System icons*

## Other documentation

Your computer comes with the following documentation:

- ❖ An electronic version of the User's Guide (this document)
- ❖ A Quick Start Document
- ❖ It may also include other documentation

For accessory information, visit Toshiba's Web site at [accessories.toshiba.com](http://accessories.toshiba.com).

## Service options

Toshiba offers a full line of service programs to complement its standard limited warranty. Toshiba's standard limited warranty, extended warranty, and service upgrade terms and conditions are available at [warranty.toshiba.com](http://warranty.toshiba.com).

To stay current on the most recent software and hardware options for your computer, and for other product information, be sure to regularly check the Toshiba Web site at [support.toshiba.com](http://support.toshiba.com).

If you have a problem or need to contact Toshiba, see "If Something Goes Wrong" on page 95.

# Chapter 1

## Getting Started

---

This chapter provides tips for using your computer effectively, summarizes how to connect components, and explains what to do the first time you use your computer.

Please read the safety instruction information on the Quick Start document (that shipped with your computer) carefully and make sure you fully understand the instructions before you attempt to use your computer in order to avoid potential hazards that could cause bodily injury, property damage, or damage the computer.

### Setting up a work environment

Place the computer on a hard flat surface that is large enough for the computer and any other items you are using, such as a printer. Leave enough space around the computer and other equipment to provide adequate ventilation.

To keep your computer in prime operating condition, protect your work area from:

- ❖ Dust, moisture, and direct sunlight.
- ❖ Equipment that generates a strong electromagnetic field, such as stereo speakers (other than speakers that are connected to the computer) or speakerphones.

- 
- ❖ Rapid changes in temperature or humidity and sources of temperature change such as air conditioner vents or heaters.
  - ❖ Extreme heat, cold, or humidity.
  - ❖ Liquids and corrosive chemicals.

## Precautions

Your computer is designed to provide optimum safety and ease of use. You should observe certain precautions to further reduce the risk of personal injury or damage to the computer.

---

**⚠ WARNING**

Never allow any liquids to spill into any part of your computer, and never expose the computer to rain, water, seawater or moisture. Exposure to liquid or moisture can cause electric shock or fire, resulting in damage or serious injury. If any of these eventualities should accidentally occur, immediately:

1. Turn off the computer.
2. Disconnect the AC adaptor from the power plug socket and computer.

Failure to follow these instructions could result in serious injury or permanent damage to the computer.

Do not turn on the power again until you have taken the computer to an authorized service center.

---

- ❖ Never turn off the computer if a drive light indicates a drive is active.

Turning off the computer while it is reading from or writing to a disk/disc or flash media may damage the disk/disc or flash media, the drive, or both.

- ❖ Keep the computer and disks away from objects that generate strong magnetic fields, such as large stereo speakers.

Information on some disks is stored magnetically. Placing a magnet too close to a disk can erase important files.

**CAUTION**

Handle discs carefully. Avoid touching the surface of the disc. Grasp it by its center hole and edge. If you handle the disc incorrectly, you could damage the disc and possibly lose data.

---

- ❖ Scan all new files for viruses.

This precaution is especially important for files you receive via email or download from the Internet. Occasionally, even new programs you buy from a supplier may contain a computer virus. You need a special program to check for viruses.

### Important information on your computer's cooling fan

Your computer may have a CPU cooling fan that cools the CPU by drawing outside air into the computer.

---

**WARNING**

Always make sure your computer and AC adaptor have adequate ventilation and are protected from overheating when the power is turned on or when an AC adaptor is connected to a power outlet (even if your computer is in Sleep mode). In this condition, observe the following:

Never cover your computer or AC adaptor with any object.

Never place your computer or AC adaptor near a heat source, such as an electric blanket or heater.

Never cover or block the air vents including those located on the back of the computer.

Always operate your computer on a hard flat surface.

Overheating your computer or AC adaptor could cause system failure, computer or AC adaptor damage or a fire, possibly resulting in serious injury.

---



---

## Setting up your computer

---



**TECHNICAL NOTE:** You must complete all setup steps up to and including “[Setting up your software](#)” on [page 28](#) before adding external or internal components to your computer. These components include, but are not limited to a printer and memory.

---

### NOTE

Please handle your computer carefully to avoid scratches and damage.

---

## Connecting to a power source

Your computer requires power to operate. Use the power cord/cable and AC adaptor to connect the computer to a live electrical outlet.

---

### ⚠ WARNING

Never pull on a power cord/cable to remove a plug from a socket. Always grasp the plug directly. Failure to follow this instruction may damage the cord/cable, and/or result in a fire or electric shock, possibly resulting in serious injury.

---

### ⚠ WARNING

Always confirm that the power plug (and extension cable plug if used) has been fully inserted into the socket, to ensure a secure electrical connection. Failure to do so may result in a fire or electric shock, possibly resulting in serious injury.

Be careful if you use a multiple connector. An overload on one socket could cause a fire or electric shock, possibly resulting in serious injury.

---

**⚠ WARNING**

Always use the TOSHIBA AC adaptor that was provided with your computer, or use AC adaptors specified by TOSHIBA to avoid any risk of fire or other damage to the computer. Use of an incompatible AC adaptor could cause fire or damage to the computer possibly resulting in serious injury. TOSHIBA assumes no liability for any damage caused by use of an incompatible adaptor.

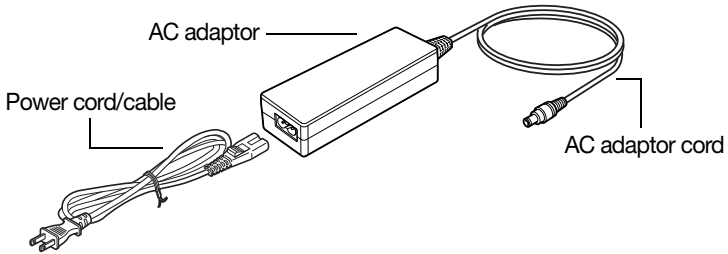

*(Sample Illustration) Power cord/cable and AC adaptor*

To connect AC power to the computer:

- 1 Connect the power cord/cable to the AC adaptor.

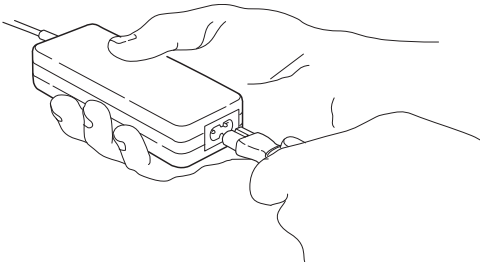

*(Sample Illustration) Connecting the power cord/cable to the AC adaptor*



- 2 Plug the AC adaptor cord into the DC-IN on the back of the computer.

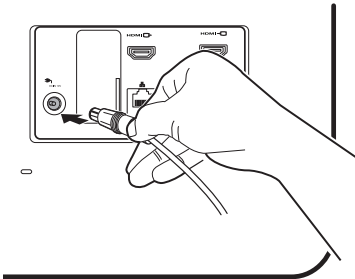

*(Sample Illustration) Connecting the AC adaptor cord to the computer*

- 3 Connect the power cord/cable to a live electrical outlet.

**⚠ WARNING**

Never attempt to connect or disconnect a power plug with wet hands. Failure to follow this instruction could result in an electric shock, possibly resulting in serious injury.

## Using the computer for the first time

The computer is now ready for you to turn it on and begin using it. See [“Exploring Your Computer’s Features” on page 65](#)

Adjust the display to a comfortable viewing angle.

Small bright dots may appear on your screen display when you turn on your computer. Your display contains an extremely large number of thin-film transistors (TFT) and is manufactured using high-precision technology. Any small bright dots that may appear on your display are an intrinsic characteristic of the TFT manufacturing technology. Over a period of time, and depending on the usage of the computer, the brightness of the screen will deteriorate. This is also an intrinsic characteristic of the screen technology.

---

## Turning on the power

To turn on the computer:

- 1 Make sure the power is properly connected and ready.
- 2 Check to ensure that all drives and slots are empty.  
Press and release the power button. The ON/OFF light glows white.

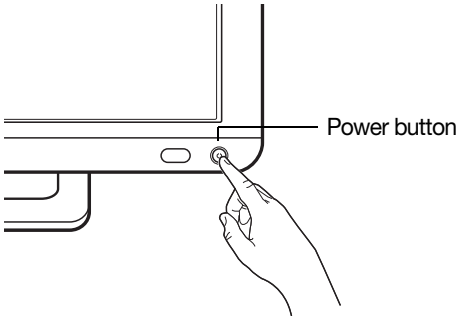

*(Sample Illustration) Turning on the power*

The pre-installed operating system will load automatically.

---

**CAUTION**

When you turn on the computer for the first time, do not turn off the power again until the operating system has loaded completely.

---

## Initial setup

The Windows 8 Startup screen is the first screen displayed when you turn on your computer for the first time. Follow the on-screen instructions on each screen in order to properly install the operating system and begin using your computer.

## Setting up your software

---

**NOTE**

The names of windows displayed, and the order in which windows appear, may vary according to your software setup choices.

---

The first time you turn on your computer, the setup guides you through steps to set up your software. Follow the on-screen instructions.

## Registering your computer with Toshiba

Product registration is strongly recommended, and allows Toshiba to send you periodic updates, announcements, and special offers applicable to your Product. Product registration can be completed by one of three methods:

- 1 From the Toshiba Web site at [register.toshiba.com](http://register.toshiba.com): Type in the requested information and complete the registration process.
- 2 From the Start screen: Type **Registration** while in the Start screen, locate and complete the registration process.
- 3 From the Desktop: Move your pointer to the upper-right corner of the screen or swipe in from the right edge. When the Windows® charms appear, click or touch the **Search** (🔍) charm and, in the Search field, type **Registration**. In the list that appears, click or touch **Registration** and complete the registration process.

Failure to complete Product Registration will not diminish your rights under the Toshiba Standard Limited Warranty.

---

**NOTE** To register online, an Internet connection is required.

---

## To Shut down your computer

- 1 From the Start or Desktop screen, move your pointer to the upper-right corner of the screen or swipe in from the right edge.
- 2 When the Windows® charms appear, click or touch the **Settings** (⚙️) charm.

---

**CAUTION**

Pressing the power button before shutting down the Windows® operating system could cause you to lose your work. Make sure the system indicator panel's storage drive light and the drive in-use light are off. If you turn off the power while a disk/disc is being accessed, you may lose data or damage the disk/disc and/or drive.

---

- 3 In the lower right of the screen click or touch the **Power** (⏻) icon.

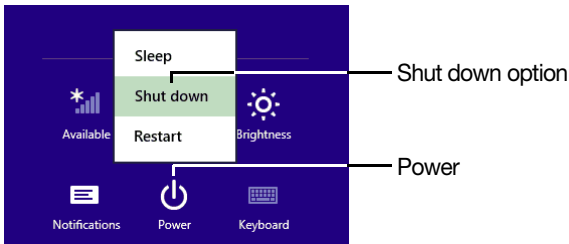

*(Sample Image) Shut down*

- 4 Highlight **Shut down** while holding the Shift key, and then click or touch the **Shut down** option.  
The computer closes all open applications, shuts down the operating system, and then turns off.

## To Restart your computer

- 1 From the Start or Desktop screen, move your pointer to the upper-right corner of the screen or swipe in from the right edge.
- 2 When the Windows® charms appear, click or touch the **Settings** (⚙️) charm.
- 3 In the lower right of the screen click or touch the **Power** (⏻) icon.

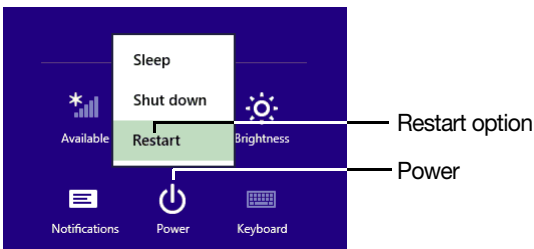

*(Sample Image) Restart*

- 4 Highlight **Restart**, and then click or touch the **Restart** option.  
The computer closes all open applications, and restarts the operating system.

## To place your computer in Sleep mode

- 1 From the Start or Desktop screen, move your pointer to the upper-right corner of the screen or swipe in from the right edge.
- 2 When the Windows® charms appear, click or touch the **Settings** (⚙️) charm.

**CAUTION**

Be sure to save your work first.

- 3 In the lower right of the screen click or touch the **Power** (⏻) icon.

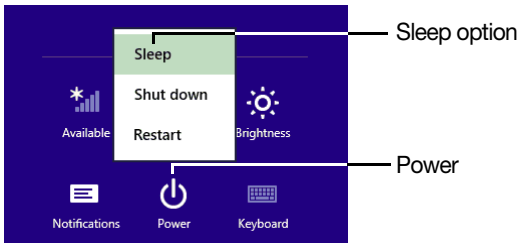

*(Sample Image) Sleep*

- 4 Highlight **Sleep**, and then click or touch the **Sleep** option.

Sleep mode saves the current state of the computer to memory so that, when you restart the computer, you can continue working from where you left off.

## Adding optional external devices

**NOTE**

Before adding external devices, Toshiba recommends first setting up the software.

After starting your computer for the first time you may want to connect any external devices you want to use, (see [“Connecting an external device” on page 42](#)).

## Recovering the Internal Storage Drive

Your computer includes recovery utilities to allow you to recover your internal storage drive if necessary.

The following internal storage drive recovery options are available:

<b>Recovery option</b>	<b>Description</b>
Creating recovery media	This option allows you to create the recovery media you will use to restore your computer. See <a href="#">“Creating recovery media” on page 33.</a>
Restoring from recovery media	This option allows you to restore your system from the recovery media you created. See <a href="#">“Restoring from recovery media” on page 35.</a>
Refresh your PC (with user’s data)	This option allows you to refresh your system without losing your data. See <a href="#">“Refresh your PC (with user’s data)” on page 37.</a>
Reset your PC	This option allows you to remove all data from your system and reinstall Windows®. See <a href="#">“Reset your PC” on page 39.</a>

A recovery image of your computer is stored on the internal storage drive, and the image can be restored by running the recovery utilities directly from your internal storage drive as described in the sections below. However, it is strongly recommended that you create recovery media. If the recovery files on your internal storage drive become corrupted or are deleted, you can restore your system from your recovery media. Also, if your original internal storage drive fails, you can restore your system to a new internal storage drive from your recovery media. It is strongly recommended that you create recovery media before using your system for the first time. See [“Creating recovery media” on page 33](#) and [“Restoring from recovery media” on page 35.](#)



**NOTE** When you restore your system, only the operating system files, applications, and drivers originally shipped with the computer are restored. Any files that you created are not restored during this process. Be sure to separately save the files you have created to external media using Windows® or another backup program. For more information, see [“Backing up your work” on page 54](#).

---

## Creating recovery media

It is strongly recommended that you create recovery media. If the recovery files on your internal storage drive become corrupted or are deleted, you can restore your system from your recovery media. Also, if your original internal storage drive fails, you can restore your system to a new internal storage drive from your recovery media.

**NOTE** When you create recovery media, only the operating system files, applications, and drivers originally shipped with the computer are backed up to the external media and can be restored from this media. Any files that you created are not backed up on the recovery media. You will need to separately back up the files you created; for more information, see [“Backing up your work” on page 54](#).

---

When you create recovery media, the system will prompt you to insert several blank DVDs or connect one or more USB flash drives of a certain minimum capacity to your computer. The amount of space required for storing the recovery files varies by computer model. Follow the procedure below to determine how much space you will need for storing your system's recovery files.

To create recovery media:

- 1 From the Start screen begin typing Recovery Media Creator and click or touch your selection. If you are in the Desktop, move your pointer to the upper-right corner of the screen or swipe in from the right edge. When the Windows® charms appear click or touch the **Search** (🔍) charm and, in the Search field, type **Recovery Media Creator**. In the list that appears, click or touch your selection.

The TOSHIBA Recovery Media Creator dialog box displays.



*(Sample Image) TOSHIBA Recovery Media Creator dialog box*

- 2 Select **DVD** or **USB Flash** from the drop-down list, depending on the type of external media you want to use.
- 3 Check the “Information” area of the dialog box to determine the number of DVDs you will need and/or the minimum amount of storage space required for copying your system’s recovery files to USB flash drive(s).

- 4 Do one of the following:
    - ❖ If you are copying files to DVD, insert a blank DVD into the optical disc drive.
    - ❖ If you are copying files to a USB flash drive, connect a USB flash drive of the required minimum capacity (as specified in the TOSHIBA Recovery Media Creator utility) to your computer.
- 

**CAUTION**

All information stored on your DVDs or USB flash drive(s) will be erased during the process of creating the recovery media. Be sure to save the information stored on your external media to another storage device before executing this procedure, or use blank media.

---

- 5 Click or touch the **Create** button in the TOSHIBA Recovery Media Creator utility dialog box.
  - 6 Follow the on-screen prompts to complete the copy process.
- 

**NOTE**

If you are copying the recovery files to DVDs, be sure to label each DVD in the set sequentially (for example, “1 of 3,” “2 of 3,” etc.), so that you will know in which order to insert the discs during recovery.

---

For information on using the Recovery media you have created with the preceding steps, see [“Restoring from recovery media” on page 35](#).

## Restoring from recovery media

---

**CAUTION**

The recovery process deletes information stored on the internal storage drive. Be sure to save your work to external media before executing the recovery (see [“Backing up your work” on page 54](#)).

---

If you have created recovery media for your system, you can restore your system from such media, if necessary. For example, if your original internal storage drive fails, you can restore your system to a new internal storage drive from your recovery media. For instructions on creating recovery media, see [“Creating recovery media” on page 33](#).

**NOTE** When you restore your system, only the operating system files, applications, and drivers originally shipped with the computer are restored. Any files that you created are not restored during this process. Be sure to separately save the files you have created to external media using Windows® or another backup program. For more information, see [“Backing up your work” on page 54.](#)

---

To recover your internal storage drive from recovery media:

- 1 Make sure your computer is turned off.
- 2 Do one of the following:
  - ❖ If your recovery files are on DVDs, insert the first recovery DVD into your optical disc drive.
  - ❖ If your recovery files are on a USB flash drive, connect the USB flash drive to your computer.
- 3 Press and hold the F12 key immediately after pressing the power button.

The Boot menu displays.
- 4 Using the arrow keys, select the **DVD** option or the **USB Flash** option, depending on which type of media you are using, and then press the ENTER key.
- 5 A warning screen appears, stating that when the recovery is executed all data on your internal storage drive will be deleted and rewritten. Click **Yes** to continue.
- 6 Follow the on-screen instructions to complete the recovery process.

When the process is complete, a message displays indicating that the drive has been recovered.
- 7 Click **Finish** to restart the computer.

## Refresh your PC (with user's data)

### CAUTION

Using “Refresh your PC” recovers your internal storage drive to factory default state and attempts to save your data. Toshiba does not guarantee successful data backup. Please make a complete back up of your data to external media before executing the recovery. For more information, see “[Backing up your work](#)” on page 54.

You can recover the factory default software (refresh your PC), while the computer will attempt to back up your data using the utilities stored on your computer's internal storage drive:



**TECHNICAL NOTE:** Your data will be copied into the backup folder. All of the data will be moved to this folder during the recovery process, however the current directory structure will be retained.

- 1 From the Start or Desktop screen, move your pointer to the upper-right corner of the screen or swipe in from the right edge.
- 2 When the Windows® charms appear click or touch the **Settings** (⚙️) charm.
- 3 Click or touch **Change PC Settings**.  
The PC settings window appears.

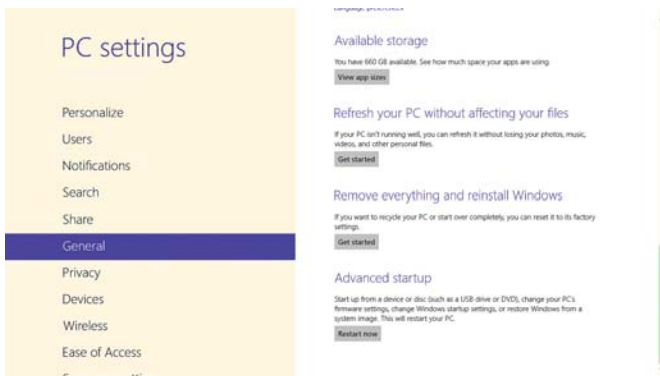

(Sample Image) PC settings screen

- 4 Click or touch **General**.

- 5 Scroll down to “Refresh your PC without affecting your files,” and click or touch **Get Started**.

The “Refresh your PC” screen appears.

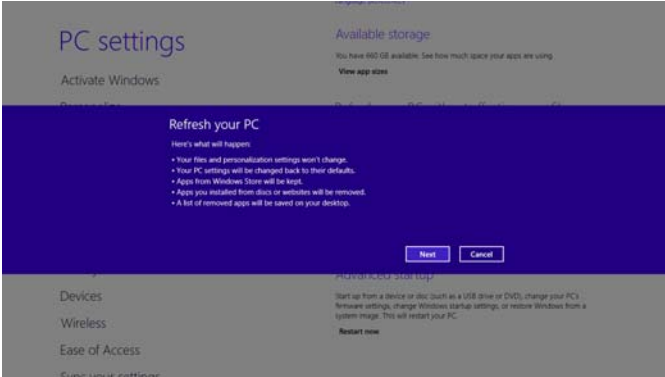

*(Sample Image) Refresh your PC screen*

### CAUTION

Toshiba does not guarantee successful data back up. Be sure to save your work to external media before executing the recovery (see “Backing up your work” on page 54).

- 6 Click or touch the **Next** button to begin.  
The “Ready to refresh your PC” screen appears.

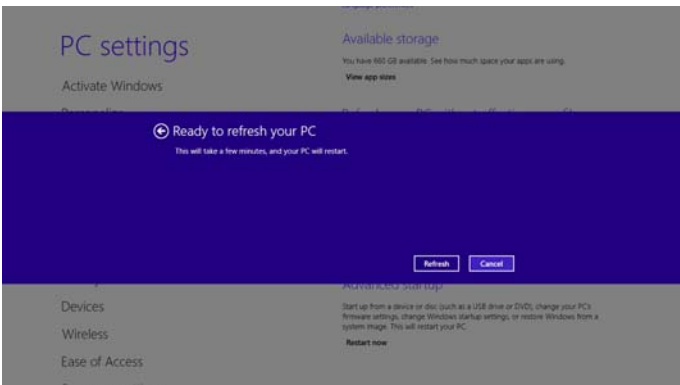

*(Sample Image) Ready to refresh your PC screen*

You will be prompted to refresh your system.

- 7 Click or touch the **Refresh** button.

- 8 Your system will restart.

The “Refreshing your PC” window appears. When the process is complete your system will reboot your Windows® operating system.

## Reset your PC

### CAUTION

The recovery process deletes information stored on the internal storage drive. Be sure to save your work to external media before executing the recovery (see “Backing up your work” on page 54).

- 1 From the Start or Desktop screen, move your pointer to the upper-right corner of the screen or swipe in from the right edge.
- 2 When the Windows® charms appear click or touch the **Settings** (⚙️) charm.
- 3 Click or touch **Change PC Settings**.  
The PC settings window appears.

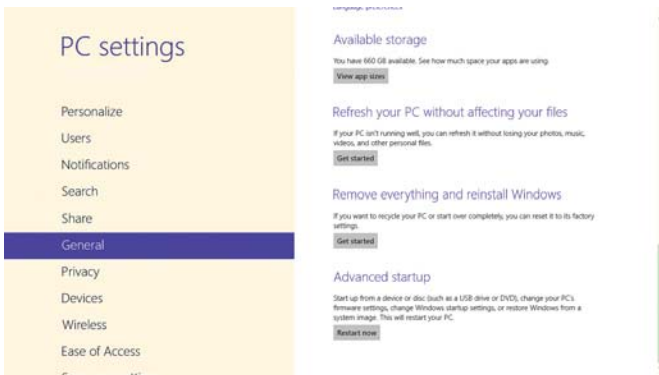

*(Sample Image) PC settings screen*

- 4 Click or touch **General**.

- 5 Scroll down to “Remove everything and reinstall Windows,” and click or touch **Get Started**.

The “Reset your PC” screen appears.

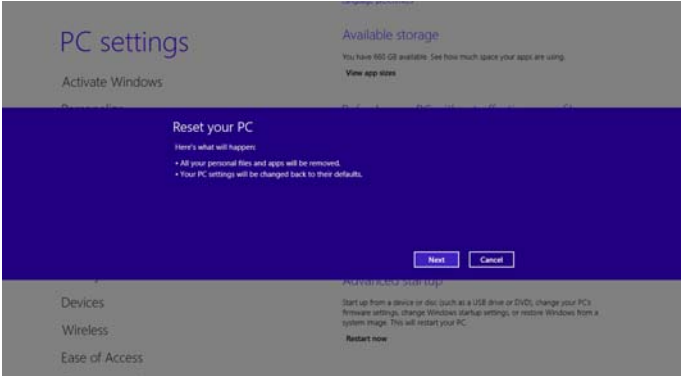

*(Sample Image) Reset your PC screen*

- 6 Click or touch the **Next** button.

The “Do you want to fully clean your drive” screen appears.

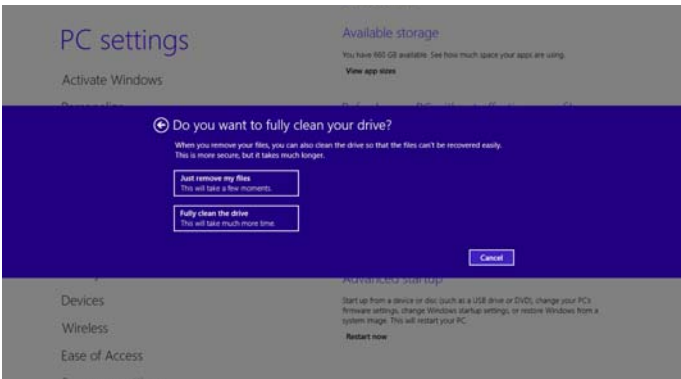

*(Sample Image) Do you want to fully clean your drive screen*



7 Select one of the following options:

❖ **Just remove my files**

❖ **Fully clean the drive**

The “Ready to reset your PC” screen appears.

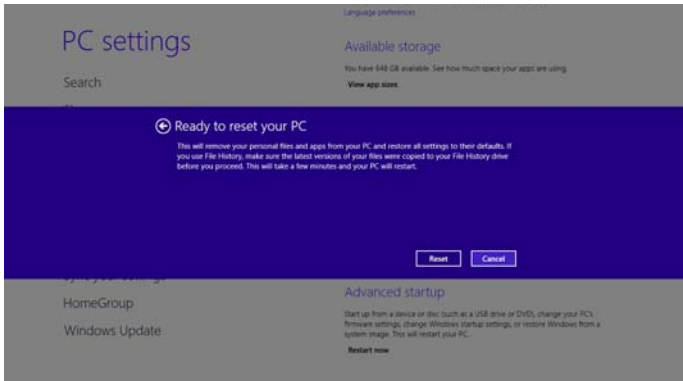

*(Sample Image) Ready to reset your PC screen*

8 Click or touch the **Reset** button.

The “Resetting your PC” window appears. When the process is complete your system will reboot your Windows® operating system.

**NOTE** Selecting the “Fully clean the drive” option may take several hours.

## Installing drivers and applications

The TOSHIBA Application Installer allows you to reinstall the drivers and applications that were originally bundled with your computer.

To reinstall drivers and applications:

1 From the Start screen begin typing **TOSHIBA Application Installer** and click or touch your selection. If you are in the Desktop, move your pointer to the upper-right corner of the screen or swipe in from the right edge. When the Windows® charms appear click or touch the **Search** (🔍) charm and, in the Search field,

type **TOSHIBA Application Installer**. In the list that appears, click or touch your selection.

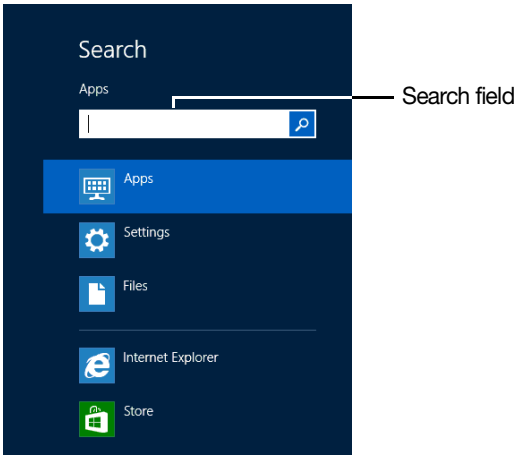

*(Sample Image) Installing drivers and applications*

- 2 Click or touch **Next**.
- 3 Click the item you want to install.
- 4 Click or touch **Install**.
- 5 Follow the on-screen prompts to complete the installation process, see [“TOSHIBA Application Installer” on page 94](#).

## Connecting an external device

You can easily attach an external device to your computer.

To do this:

- 1 Read the directions that came with the device to see if you first need to install new software.
- 2 Connect the device’s video or USB cable to the port on the computer and to the device.
- 3 Connect the device’s power cable to a live electrical outlet (if applicable).
- 4 Turn on the external device (if applicable).

Your computer may automatically detect the external device.

---

## Using external display devices

Your computer comes with a built-in display, but you can also connect the following types of external display devices to the video ports described below:



### Using the HDMI™ In port

Your computer comes with an HDMI™ In port, allowing you to connect to a video gaming console or DVD player.

---

**NOTE**

Locate the HDMI™ In port on the Quick Start Card that shipped with your computer.

---

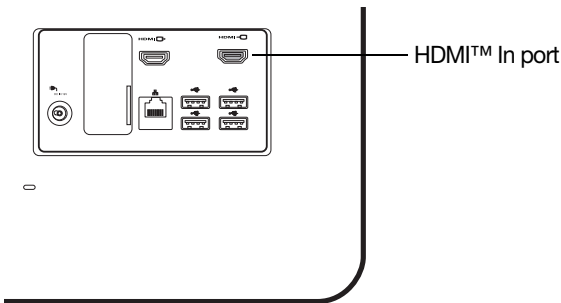

*(Sample Illustration) Video port on back of computer*



### Using the HDMI™ Out port

(Available on certain models.)

---

**NOTE**

Your computer may come with an HDMI™ Out port.

---

Your computer may come with an HDMI™ Out port, allowing you to connect to an HDMI™-compatible television or external display device.

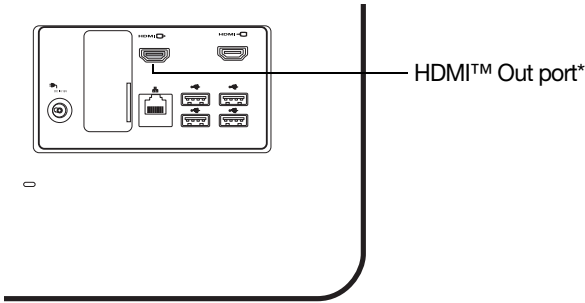

\*Available on certain models

*(Sample Illustration) HDMI™ Out port on back of computer*

## Selecting video cables

To connect a device to the HDMI™ Out port (available on certain models), you must purchase an HDMI™ cable.

## Connecting an HDMI™-compatible television or display device

**(Available on certain models.)**

To connect an HDMI™-compatible television or display device to the computer:

- ❖ Connect one end of an HDMI™ cable (not included with your computer) to the HDMI™ Out port on the back of your computer, and then connect the other end of the cable to your television or display device. Refer to the manual that came with the television or display device for more information.

Your computer will automatically detect the external display device.

## Customizing your computer's settings

There are several ways in which you can customize your computer to suit your particular requirements. You can go into your computer settings to make adjustments to your computer to suit your needs.

From the Start or Desktop screen, move your pointer to the upper-right corner of the screen or swipe in from the right edge. When the Windows® charms appear click or touch the **Settings** (⚙️) charm and then click or touch **Change PC Settings**. Then choose a category you wish to change. Refer to your operating system documentation or Help and Support for details.

---

You may also wish to customize your power usage settings. For more information, see [“Power Plans” on page 63](#). There are additional custom settings you can choose. See [“Utilities” on page 76](#).

## Caring for your computer

This section gives tips on cleaning and moving your computer.

---

**NOTE** Please handle your computer carefully to avoid scratches and damage.

---

## Cleaning the computer

---

**CAUTION** Keep liquids, including cleaning fluid, out of the computer’s keyboard, speaker, and other openings. Never spray cleaner directly onto the computer and/or display. Never use harsh or caustic chemical products to clean the computer.

---

To keep your computer clean, gently wipe with a lightly dampened cloth.

## Moving the computer

Before moving your computer to a new location, even across the room, make sure all drive activity has ended (the internal storage drive and optical disc drive indicator lights stop glowing) and all external peripheral cables are disconnected.

---

**WARNING** Before moving your computer, shut down the computer and disconnect the power cable/cord.

---

## Using a computer lock

You may want to secure your computer to a heavy object such as your desk. The easiest way to do this is to purchase an optional computer lock cable. For more information on purchasing a cable lock, visit [accessories.toshiba.com](http://accessories.toshiba.com).

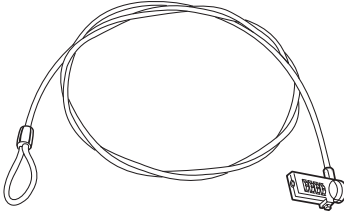

*(Sample Illustration) Computer lock cable*

To secure the computer:

- 1 Wrap the cable through or around some part of a heavy object.

Make sure there is no way for a potential thief to slip the cable off the object.

- 2 Pass the locking end through the loop.



- 3 Insert the cable's locking end into the security lock slot on your computer, then engage the locking device.

The computer is now securely locked.

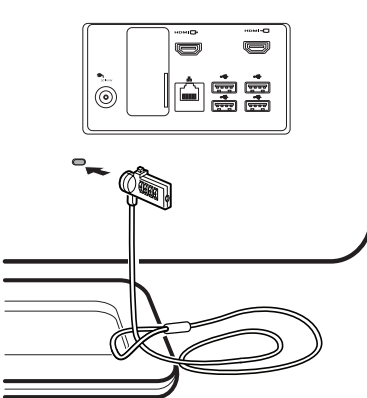

*(Sample Illustration) Attaching security lock cable*

# Chapter 2

## Learning the Basics

---

This chapter gives some computing tips and provides important information about basic features.

### Computing tips

- ❖ Save your work frequently.

Your work stays in the computer's temporary memory until you save it to the internal storage drive. If the network you are using goes down and you must restart your computer to reconnect, you will lose all work since you last saved.

See [“Saving your work” on page 54](#) for further information.



**HINT:** Some programs have an automatic save feature that can be activated. This feature saves your file to the internal storage drive at preset intervals. See your software documentation for details.

---

- ❖ Back up your files to external media on a regular basis. Label the backup copies clearly and store them in a safe place.

It is easy to put off backing up because it takes time. However, if your internal storage drive suddenly fails, you will lose all the data on it unless you have a separate backup copy. For more information, see [“Data and system configuration backup in the Windows® operating system”](#) on page 113.

- ❖ Use Error-checking and Disk Defragmenter regularly to check and optimize disk space and improve performance.
- ❖ Scan all new files for viruses.

This precaution is especially important for files you receive via external media, email, or download from the Internet.

- ❖ Take frequent breaks to avoid repetitive-motion injuries and eyestrain.
- ❖ Do not turn off the computer if a drive indicator light indicates a drive is active.

Turning off the computer while it is reading from or writing to a disk may damage the disk, the drive, or both.

**NOTE**

The Windows® operating system records information, such as your desktop setup, during its shutdown procedure. If you do not let the Windows® operating system shut down normally, details such as new icon positions may be lost.

## Using the wireless mouse

Your computer comes with a wireless mouse. The wireless receiver comes installed on your computer.

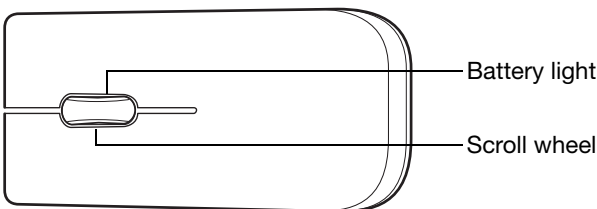

*(Sample Illustration) Mouse*



## Replacing the battery

A battery is required to power the wireless mouse. The battery light glows red when the battery power is low.

To replace the battery:

- 1 Save your work and turn the mouse upside down.

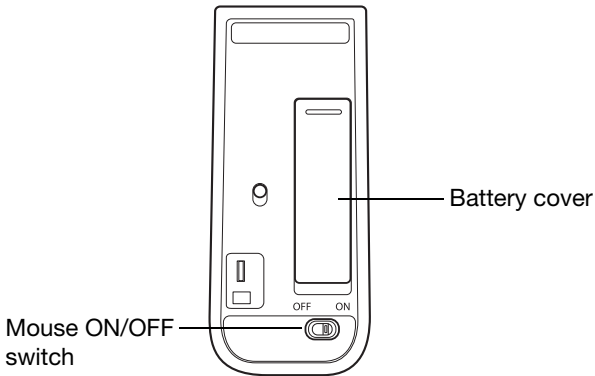

*(Sample Illustration) Mouse underside*

- 2 Slide the mouse ON/OFF switch on the underside to the OFF position.
- 3 Slide the Battery cover off.
- 4 Always replace the battery with a fresh one.
- 5 Replace the battery cover.
- 6 Slide the mouse ON/OFF switch to the ON position.

### **⚠ WARNING**

If a battery is leaking or its case is cracked, put on protective gloves to handle it, and discard it immediately. Always dispose of used batteries in compliance with all applicable laws and regulations. Put insulating tape, such as cellophane tape, on the electrode during transportation to avoid a possible short circuit, fire or electric shock. Failure to do so could possibly result in serious injury.

## Using the wireless keyboard

Your computer comes with a wireless keyboard. The wireless receiver comes installed on your computer.

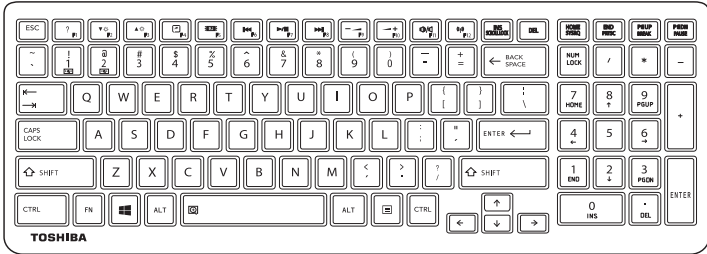

*(Sample Illustration) Keyboard*

## Replacing the battery

A battery is required to power the wireless keyboard. The battery light glows red when the battery power is low.

To replace the battery:

- 1 Save your work and turn the keyboard upside down.

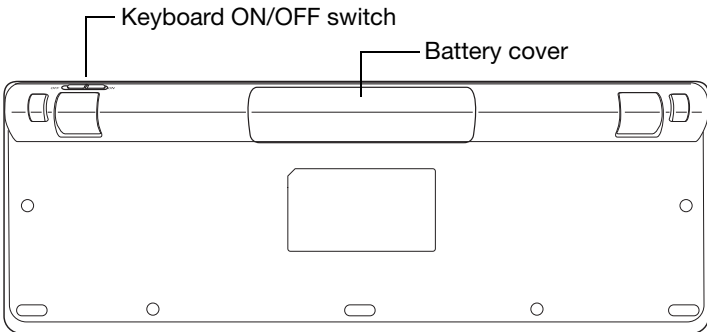

*(Sample Illustration) Keyboard underside*

- 2 Slide the keyboard ON/OFF switch on the underside to the OFF position.
- 3 Slide the Battery cover off.
- 4 Always replace the battery with a fresh one.

- 5 Replace the battery cover.
- 6 Slide the keyboard ON/OFF switch to the ON position.

**WARNING**

If a battery is leaking or its case is cracked, put on protective gloves to handle it, and discard it immediately. Always dispose of used batteries in compliance with all applicable laws and regulations. Put insulating tape, such as cellophane tape, on the electrode during transportation to avoid a possible short circuit, fire or electric shock. Failure to do so could possibly result in serious injury.

## Keyboard functions

Your computer's keyboard contains character keys, control keys, function keys, and special Windows® keys.

**NOTE**

To capture a print screen of the entire screen, press the Fn + PRTSC key.

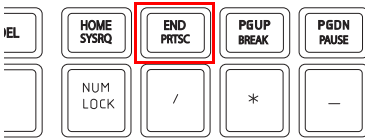

*(Sample Illustration) PRTSC key on the keyboard*

## Function keys

The function keys (not to be confused with the Fn key) are the 12 keys at the top of the keyboard.



*(Sample Illustration) Function keys*

## Special Windows® keys

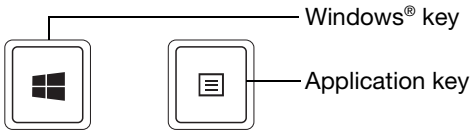

*(Sample Illustration) Special Windows® keys*

Your computer's keyboard has one key and one button that have special functions in Windows®:

- ❖ **Windows® key**—Toggles between the Desktop screen and the last app opened on the Start screen. For more information refer to the Help & Support, or see [“Exploring the Start screen” on page 65](#)
- ❖ **Application key**—Has a similar function as the secondary mouse button

## Touch screen

Your computer may come with a touch screen, enabling direct interaction with displayed apps and programs through simple or multi-touch gestures.

### Touch screen navigation

Use your finger to manipulate the on-screen icons, buttons, menu items, and other items on the touch screen. You can also change the screen's orientation.

---

**⚠ CAUTION** The screen is made of glass so avoid contact with sharp, rough, or abrasive objects or substances as screen may break or scratch if not handled properly. If you see a crack in the glass, discontinue use of the device to avoid injury.

---



**Touch**—Touch to activate items displayed on the screen, such as app and setting icons or on-screen buttons. Touch to type using the keyboard.



**Touch & hold**—Touch and hold an item on the screen by touching and holding the item in place until an action occurs.



**Drag**—Touch and hold an item for a moment and then, without lifting your finger, move the item until you reach the target position. For example, drag items on any app screen to reposition them.



**Swipe or slide**—To swipe or slide, quickly move your finger across the surface of the screen without pausing. For example, swipe your finger to the left from the right edge of the screen to display the Windows® charms.



**Double-tap**—Tap quickly twice to zoom in. For example, double-tap a section of a Web page to zoom in on that section. Double-tap again to zoom out.



**Pinch**—In some apps (such as Maps and Games), you can zoom in and out by placing two fingers on the screen at once and pinching them together (to zoom out) or spreading them apart (to zoom in).



**Rotate**—Place two or more fingers on an item and rotate your hand. The item rotates in the direction you turn your hand. (Not functional in all apps).

## Starting an app

To Start an app on the Start screen, move your pointer over the appropriate tile and click to open.

To Start an app from the Desktop, move your pointer to the upper-right corner of the screen or swipe in from the right edge. When the Windows® charms slide out from the right, click or touch the **Start** (■) charm.

## Starting an app from the Start screen

To Start an app on the Start screen, move your pointer over the appropriate tile and click or touch to open, or swipe your finger to the left from the right edge of the screen.

To Start an app using the Search function, move your pointer to the upper-right corner of the screen or swipe in from the right edge. When the Windows® charms slide out from the right, click or touch the **Search** (🔍) charm. The apps screen appears with the available system apps to choose from or you can enter your search in the search field.

Below is an example using the Search field to start an app:

- 1 Move your pointer to the upper-right corner of the screen or swipe in from the right edge. When the Windows® charms appear click or touch the **Search** (🔍) charm.

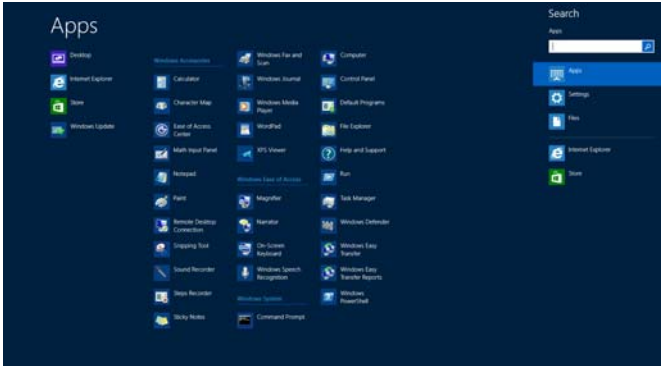

*(Sample Image) Searching for apps*

- 2 Start typing the app's name in the Search field.  
As you type, all matching files and apps are displayed.
- 3 Click the app you wish to open.

## Saving your work

Before you turn off the computer using the Shut down command, save your work on the internal storage drive, external media, flash media, or optical disc. This is one of the most important rules of computing.

Many applications offer a feature that saves documents at regular intervals. Check your program's documentation to see if it has an automatic save feature.

## Backing up your work

Back up all the files you create in case something happens to your computer. You can back up your files to different types of media such as CDs, DVDs, external storage media, or to a network, if available.

To back up several files at one time, use the Microsoft® Windows® file recovery program preinstalled on the computer's internal storage drive. Also see "[Backing up your data or your entire computer with the Windows® operating system](#)" on page 115.



**HINT:** Backing up all the files on your internal storage drive may take a considerable amount of time and multiple CDs/DVDs. You may prefer to use a high-capacity backup system, such as an external hard drive.

## Using the optical disc drive

Optical storage is a popular medium for software, music, and video. Digital versatile discs (DVDs) provide a significant increase in data storage and support features that were not available on previous video platforms. These features include wide-screen movies, multiple language tracks, digital surround sound, multiple camera angles, and interactive menus.



**TECHNICAL NOTE:** Your optical disc drive is set to play Region 1 (North America) DVD-ROMS. A DVD disc of a region other than the above mentioned cannot be played unless you manually change it in the Properties setting of the optical disc drive. The drive will allow you to change regions four times. On the fourth change, the region will be “locked in.” That is, the drive will only play DVDs from that last region. Note that changing from region 1 to region 2 and back to region 1 is counted as two changes.

**NOTE** For optimum DVD performance, it is recommended that you play DVDs while running the computer on AC power.

**NOTE** When viewing DVD movies use the DVD Player software that came with your computer.

## Optical disc drive components

The optical disc drive is located on the side of the computer.

Your optical disc drive may look like this:

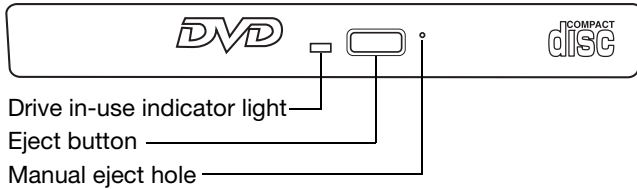

*(Sample Illustration) Optical disc drive*

**Drive in-use indicator light**—Indicates when the drive is in use.

**Eject button**—Press to release the disc tray.

### CAUTION

Do not press the eject button or turn off the computer while the drive in-use indicator light is glowing. Doing so could damage the disc or the drive.

When the disc tray is open, be careful not to touch the lens or the area around it. Doing so could cause the drive to malfunction.

**Manual eject hole**—Use if you need to release the disc tray when the power is off. Use a straightened paper clip or other narrow object to press the manual eject button located inside the hole.

### CAUTION

Never use a pencil to press the manual eject button. Pencil lead can break off inside the computer and damage it.

## Inserting an optical disc

To insert an optical disc into the drive:

- 1 Make sure the computer is turned on.  
The drive will not open if the computer's power is off.
- 2 Make sure the drive's in-use indicator light is off.
- 3 Press the drive's eject button.  
The disc tray slides partially out of the drive.



- 4 Grasp the tray and pull it fully open.

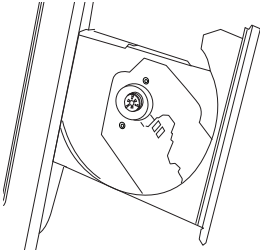

*(Sample Illustration) Drive tray fully extended*

- 5 Hold the disc by its edges and check that it is free of dust.  
If the disc is dusty, clean it with a clean dry cloth.
- 6 Place the disc carefully in the disc tray, label side out.

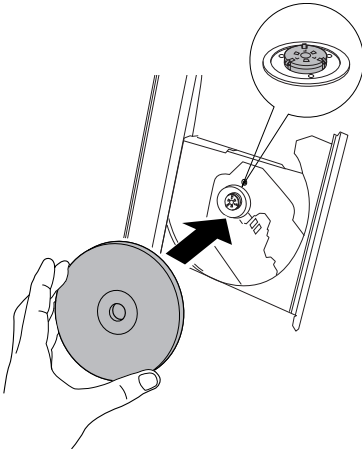

*(Sample Illustration) Positioning the disc in the drive*

- 7 Gently press the disc onto the center spindle until it clicks into place.

**CAUTION**

Handle DVDs and CDs carefully, making contact only with the center hole and edge. Do not touch the surface of the disc. Do not stack discs. If you incorrectly handle the discs, you could lose data.

- 
- 8 Make sure the disc is completely on the spindle and is lying flat against the tray.

---

**CAUTION** If you insert the disc incorrectly, it may jam the drive. If this happens, contact Toshiba support for assistance.

---

- 9 Push the disc tray in by pressing gently on the center of the tray until it clicks into place.

You are ready to use the disc.

## Playing optical media

If you insert an optical disc into the optical disc drive and the Auto-Run feature does not automatically start your disc, try launching the optical disc manually. To do this, follow these steps:

- 1 Press the (⊞) + E keys.
- 2 Double-click the optical disc drive icon.

The drive will run the optical disc.

If your disc does not run using this method, try using an application that is associated with the media on the disc. For example, if it is a music CD, open Windows Media® Player and use it to select and then play the CD. For other types of media, use the associated software to open the files on the disc.

## Recording optical media

Depending on the configuration, your computer may come with an optical disc drive that allows you to:

- ❖ Play pre-recorded and recorded optical media.
- ❖ Read/write data and multi-media files to recordable optical media.

For more information regarding supported optical media formats please refer to your computer's detailed specifications at [support.toshiba.com](http://support.toshiba.com).

**NOTE**

Due to manufacturing and quality variations in third party optical media (e.g., CD or DVD) or optical media players/recorders, in certain cases, your Toshiba optical disc drive may not record on certain optical media that bear the applicable logo, or play back optical media recorded by other computers or optical media recorders. Additionally, certain optical media recorded on your optical disc drive may not play back or operate properly on other computers or optical media players. These problems are not due to any defect in your Toshiba computer or optical disc drive. Please refer to your computer's product specification for listing of specific format compatibilities.

Copy protection technology may also prevent or limit recording or viewing of certain optical media.

For details on how to use the software, please refer to the respective Online Help menus.

**Removing a disc with the computer on**

To remove an optical disc with the computer turned on:

- 1 Press the eject button on the drive.

**CAUTION**

Do not press the eject button while the drive in-use indicator light is glowing. Doing so could damage the disc or the drive.

Also, if the disc is still spinning when you open the disc tray, wait for it to stop spinning before you remove it.

- 2 Pull the tray out until it is fully open, remove the disc, and place it in its protective cover.
- 3 Gently press the tray in to close it.

## Removing a disc with the computer off

To remove a disc with the computer turned off:

- 1 Insert a slender object, such as a straightened paper clip, into the manual eject hole.

The disc tray slides partially out of the drive.

---

**CAUTION**

Never use a pencil to press the manual eject button. Pencil lead can break off inside the computer and damage it.

---

- 2 Pull the tray out until it is fully open, remove the disc, and place it in its protective cover.
- 3 Gently press the tray in to close it.

## Toshiba's online resources

Toshiba maintains a number of online sites to which you can connect. These sites provide information about Toshiba products, give help with technical questions and keep you up to date with future upgrades. For more information, see ["Contacting Toshiba" on page 118](#).

# Chapter 3

## Computing

---

### Toshiba's energy-saver design

Your computer enters a low-power suspension mode when it is not being used, thereby conserving energy and saving money in the process. It has a number of other features that enhance its energy efficiency.

Many of these energy-saving features have been preset by Toshiba. We recommend you leave these features active, allowing your computer to operate at its maximum energy efficiency, so that you can use it for longer periods.

### Power management

Your computer ships with the power management options preset to a configuration that will provide the most stable operating environment and optimum system performance.

---

**CAUTION**

Changes to these settings may result in system performance or stability issues. Users who are not completely familiar with the power management component of the system should use the preset configuration. For assistance with setup changes, contact Toshiba's Customer Support Center.

---

---

## Charging the RTC battery

Your computer has an internal real-time clock (RTC) battery. The RTC battery powers the System Time Clock and BIOS memory used to store your computer's configuration settings. When fully charged, it maintains this information for up to a month when the computer is powered off.

The RTC battery may have become completely discharged while your computer was shipped, resulting in a CMOS error message during startup. The error message may vary by computer model.

---

**NOTE** Depending on your system, the RTC battery may only charge while the computer is turned on.

---

To recharge the RTC battery, plug the computer into a live electrical outlet and leave the computer powered on for 24 hours.

---

**NOTE** It is seldom necessary to charge the RTC battery because it charges while the computer is on. If the RTC battery is low, the real-time clock and calendar may display the incorrect time and date or stop working.

When Hibernation mode is enabled and the RTC battery is completely discharged, a warning prompts you to reset the real-time clock.

---

The computer can be used while the RTC battery is being charged, although the charging status of the RTC battery cannot be monitored.

## Power Plans

You can choose a predefined Power Plan or select your own combination of power options.

To do this:

- 1 While on the desktop, press the Windows® (⊞) key + X, then click or touch **Power Options**.

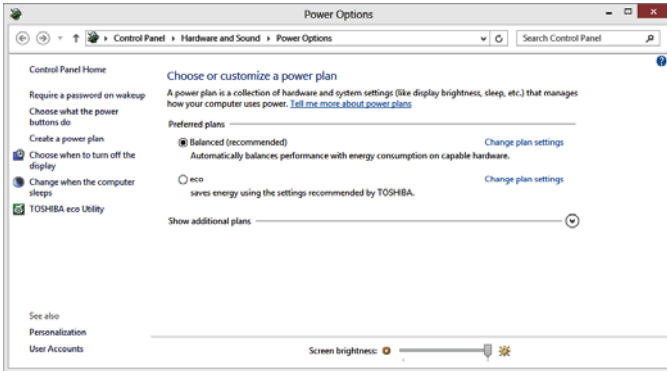

*(Sample Image) Windows® Power Options window*

- 2 Select an appropriate plan for your work environment or create your own custom plan.
- 3 Click or touch **Create a power plan** in the left pane to set up a new plan.

**NOTE** To edit a plan or to edit advanced settings, continue to the following steps.

- 4 Click or touch **Change plan settings** to choose the plan you want to edit.  
This screen allows you to change basic settings.
- 5 Click or touch **Change advanced power settings** to access settings for internal storage drive power save time, etc.  
You can click or touch the plus signs to expand each item and to see what settings are available for each item.
- 6 Click or touch **OK** to save the plan changes you have performed.

By default the two power plans eco and Balanced are satisfactory for most people and do not need to be edited.

## Using the eco power plan

This computer is equipped with the eco power plan. Operating the computer with this power plan enabled reduces electrical power consumption by slightly lowering system performance. For example, when this power plan is enabled, the brightness of the display is reduced and the interval before Sleep mode takes effect is shortened. To enable or disable the eco power plan, see [“Power Plans” on page 63](#).

The eco Utility<sup>®</sup> monitors your power savings from using the eco power plan by tracking real-time power consumption and accumulated savings over time. To learn how to access the utility, see [“eco Utility<sup>®</sup>” on page 81](#).

For more information on the TOSHIBA eco power plan, see the Help file in the eco Utility<sup>®</sup> window.



# Chapter 4

## Exploring Your Computer's Features

---

In this chapter, you will explore some of the special features of your computer.

### Exploring the Start screen

The Start screen is the launching pad for everything you can do in the Windows® operating system, providing new and easy ways to access everything from your favorite apps and Web sites to your contacts and other important information.

When you move your pointer to the upper-right corner of the screen or swipe in from the right edge, a list of Windows® charms will slide out from the right. These Windows® charms perform various commands, including basics tasks like turning off the power and advanced PC settings.

You can go to the Start screen by clicking or touching the **Start** charm (see “Charms” on page 66). You can also use the Windows® key (⊞) on your keyboard or on the LCD screen to go to Start screen. For detailed information, please refer to the Windows Help and Support.

By clicking on or touching the **Desktop** tile from the Start screen, you will find the Windows® settings and features you are most familiar with.

For detailed information on the new Windows 8 functionality, refer to the Windows® Help and Support.



App tiles

*(Sample Image) Windows® Start screen*

## Charms

Use the Windows® charms to start apps, find documents, set up system components, and perform most other computing tasks.

By swiping in from the right edge (only for touch screen models) or pointing the mouse pointer to the upper or lower right corner of your screen, you will find a list of charms:

**Search, Share, Start, Devices and Settings.**



**Search**—This charm allows you to search for most anything you need to locate on your computer. It can help you find apps, documents, photos, and your favorite music.



**Share**—This charm allows you to share music and photos with your favorite social Web sites.



**Start**—This charm allows you to view all of the available apps downloaded to your system.



**Devices**—This charm allows you to manage your hardware devices.



**Settings**—This charm allows you to manage your system settings.

## Tiles

Tiles can be accessed and launched from the Start screen.

Typical Start screen tiles are the Desktop tile and Mail tile, as well as tiles representing all other applications downloaded to your system.

## Exploring the desktop

You can use its features to start applications, find documents, set up system components, and perform most other computing tasks.



**HINT:** The illustrated examples in this guide may appear slightly different from the screens displayed by your system. The differences are not significant and do not indicate any change in the functionality of your system.

## Finding your way around the desktop

Your computer's desktop includes several standard features: icons, taskbar, notification area, notifications, and background pattern.



*(Sample Image) Windows® Desktop screen*

## Icons

An icon represents a folder, file, or program that can be quickly activated by double-clicking the icon.

You can create a new desktop icon for any folder, file, or program by dragging the element's icon from its location in a window to the desktop area.

You may see various icons displayed on your system desktop, for example:



**Recycle Bin** – Holds files you have deleted. You may be able to retrieve these files until you empty the Recycle Bin.

---



- ❖ **TECHNICAL NOTE:** If you delete a large number of files or very large files from the internal storage drive, there may be insufficient space available in the Recycle Bin to hold these files. In this case, Windows® will prompt you to either permanently delete the file(s) or cancel the deletion.
  - ❖ If you delete a file (of any size) from an external media or flash media, it does not go into the Recycle Bin. The file is permanently deleted.
  - ❖ Permanently deleted files cannot be recovered from the Recycle Bin.  
For more information on the Recycle Bin, see Windows® online Help.
- 

### NOTE

If you place the pointer over an icon, a popup description of the file contents appears.

---

Your desktop may contain other icons depending on your configuration. Refer to the Windows® online Help for more specific information on each icon and how to use it, or see [“Help file” on page 121](#).

## Taskbar

Each time you open a program, a button associated with that program appears on the taskbar. With some programs, a button appears on the taskbar for each document or window you open. You can use these buttons to quickly switch between the programs or windows.

To make a program or window the currently active one, click to touch the associated taskbar button.

## Notification area

The Notification area displays icons of tasks or programs that run continuously in the background and displays notifications. To learn more about each task, position the pointer over the icon for a few moments and a short description of the task appears.

Typical tasks in the Notification area are Current time, Power usage mode, network connectivity status, and speaker volume.

To activate a specific task, click or touch the appropriate Notification area icon.

## Notifications

There are many types of notifications you can employ to help you with the many tasks you perform every day.

User experience notifications can be set for toast, tile, badge, and raw notifications.

**Toast notifications**—Designed for time-sensitive delivery of personalized content, such as an instant message from a friend.

**Tile notifications**—Used by applications that are not currently running with an at-a-glance characteristic, giving you a quick preview of the subject line of your latest email or the current weather conditions.

**Badge notifications**—A specialized type of tile notification (shown on the Start screen tile) using glyphs to indicate the number of applications that have updates available or the status of a running application.

**Raw notifications**—These run a background task on behalf of an application while that application is not running in order to make available the latest content, such as an online newspaper.

## Windows® Store

Although many applications will be pre-installed or built-in to your computer, you will also have the ability to download many other applications with a touch or the click of your mouse.

In the Windows® Store you can search for and browse thousands of apps, all grouped into easy to find categories.

## Setting up for communications

To connect to the Internet, you need:

- ❖ A browser or communications program
- ❖ An Internet Service Provider (ISP) or online service if you plan to use the Internet
- ❖ A way to connect to the ISP (for example Wi-Fi®/ LAN/ broadband connection, etc.)

### Using Wireless LAN connectivity

---

**NOTE** Wireless connectivity and some features may require you to purchase additional software, external hardware or services. Availability of public wireless LAN access points may be limited.

---

Your system may come with an optional wireless LAN module. This is a technology that expands wireless communication beyond networking equipment, and can connect many different kinds of electronic devices without the need for cables.

For information on how to set up a wireless connection, refer to your wireless networking device documentation or your network administrator.

**NOTE** To enable or disable wireless communication, use the F12 key. For more information see [“TOSHIBA Function Keys” on page 120](#).

---

For help with common Wi-Fi® networking problems, see [“Wireless networking problems” on page 109](#).

## Connecting your computer to a network

You can connect your computer to a network to increase its capabilities and functionality.

## Accessing a network

To access a network, connect an Ethernet cable to the Network port (RJ45) on your computer. For specific information about connecting to the network, consult your network administrator. Many hotels, airports, and offices offer Wi-Fi® access.

## Exploring audio features

You can use your computer to record sounds using the computer's internal microphones (available on certain models) or an optional external microphone. You can listen to sound files or audio CDs using the built-in speakers, headphones, or external speakers.

## Recording sounds

You may record sounds using the computer's internal microphones (available on certain models) or by connecting an optional external microphone.

## Using a microphone



- 1 If you want to use an external microphone, connect it to the computer.
- 2 From the Start screen begin typing **Sound Recorder** and click or touch your selection. If you are in the Desktop, move your pointer to the upper-right corner of the screen or swipe in from the right edge. When the Windows® charms appear click or touch the **Search** (🔍) charm and, in the Search field, type **Sound Recorder**.

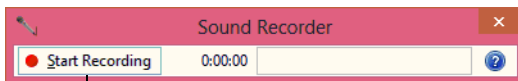

Start Recording/Stop Recording button

*(Sample Image) Sound Recorder screen*

- 3 Click or touch the **Start Recording** button.
- 4 Speak normally into the microphone.
- 5 When you have finished recording, click or touch the **Stop Recording** button.  
The **Save As** dialog box appears.
- 6 To save the file, type a file name, and then click or touch **Save**.

---

## Using external speakers or headphones

Your computer is equipped with a full stereo sound system with internal speakers. Instead of using the internal speakers, you can connect headphones or a pair of external stereo speakers.

---

**CAUTION**

Before putting on headphones to listen, turn the volume down. Do not set the volume too high when using headphones. Continuous exposure to loud sound can harm your hearing.

---



**TECHNICAL NOTE:** When using amplified speakers, use speakers that require an external power source. Other types of speakers will be inadequate to produce sound from the computer.

---

To play back sound files through external speakers or headphones:



- 1 Locate the headphone jack on the computer.
- 2 Using any necessary adapters, plug the cable from the headphones or external speakers into the headphone jack.

The headphone jack requires a 16-ohm stereo mini connector.

To adjust the volume:

- ❖ For external speakers, use the volume controls on each speaker.
- ❖ For headphones, use the computer's volume control.



## Using the Web Camera

**(Available on certain models.)**

Your computer may come with a built-in Web Camera. With this Web Camera you can do the following:

- ❖ Take pictures and record videos with your computer
- ❖ Chat with others and have them see you while using instant messaging (IM) programs
- ❖ Have video conference calls



---

**NOTE** To email, instant message or video conference, you must be connected to the Internet.

---

Depending on your computer model, the process of sending email, taking pictures or recording video messages may vary.

To access the Web Camera, on the Start screen click or touch the **Camera** tile. The Web Camera indicator light glows when the Web Camera is active.

---

**NOTE** When the Web camera is not active the indicator light is off.

---

## Using the Memory card reader

(Available on certain models.)

The Memory card reader supports the use of Secure Digital™ (SD™, SDHC, SDXC), or MultiMediaCard® (MMC®) media. These media can be used with a variety of digital products: digital music players, cellular phones, PDAs, digital cameras, digital video camcorders, etc.

---

**CAUTION** To use a micro or mini SD™ Card, an SD™ adapter is required.

---

The Memory card reader may also support other types of media.

---

**NOTE** Do not use the Copy Disk function for this type of media. To copy data from one media to another, use the drag-and-drop feature of the Windows® operating system.

---

## Inserting memory media

**NOTE** To locate your Memory card reader, please refer to your Quick Start document.

---

The following instructions apply to all types of supported media devices.

- 1 Turn the media so that the contacts (metal areas) are face down.

- 2 Push the media into the Memory card reader until it locks in place.

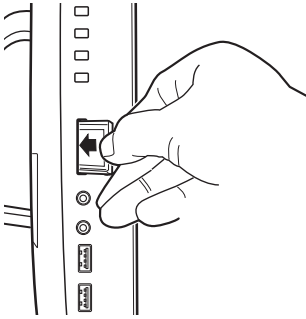

*(Sample Illustration) Inserting memory media*

**CAUTION**

When inserting memory media, do not touch the metal contacts. You could expose the storage area to static electricity, which can destroy data.

Always remove memory media when not in use.

## Removing memory media

- 1 If you are not currently on the Desktop, choose the Desktop tile on the Start screen, otherwise skip to step 2.
- 2 Prepare the card for removal by clicking on or touching the **Show hidden icons** button (▲), if necessary, in the notification area and then selecting the **Safely Remove Hardware and Eject Media** icon.
- 3 Highlight, and then click or touch the item you would like to eject.



If the system is unable to prepare the media for safe removal, a message will tell you to try again later. If the media can be removed now, the system displays **Safe to Remove Hardware**.

If the computer has a spring-loaded adapter slot, see step 4; otherwise, skip to step 5.

- 4 Gently press the card inward to release it.  
The card pops out slightly.

- 5 Grasp the card and pull it straight out.

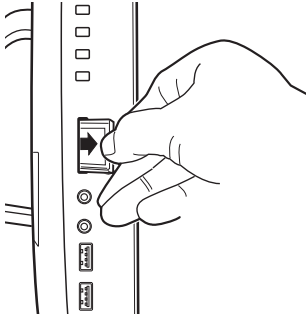

*(Sample Illustration) Removing memory media*

**CAUTION**

Do not remove memory media while data is being written or read. Even when the Windows® message “copying...” disappears, writing to the media might still be in progress and your data could be destroyed. Wait for the indicator light to go out.

# Chapter 5

## Utilities

---

Your computer includes several utilities designed to help you to reconfigure your system to best meet your individual needs. Together, these allow you to ascertain certain system details, set additional options, or change default options. These utilities are described in this chapter.

---

**NOTE** The utilities described in this chapter, and the icons shown in the sample images are applicable only if the related utility is available on your system.

---

- ❖ Desktop Assist
- ❖ eco Utility®
- ❖ Supervisor password
- ❖ User password
- ❖ System Settings
- ❖ Sleep Utilities
- ❖ TOSHIBA function key
- ❖ Recovery Media Creator
- ❖ Service Station
- ❖ TOSHIBA Application Installer

## Desktop Assist

The TOSHIBA Assist provides quick access to computer functions and allows you to customize a range of computer settings.

To access Desktop Assist from the Start screen begin typing **Desktop Assist**, or while in the Desktop screen double-click or touch the **Desktop Assist**, icon.



The Desktop Assist window appears.

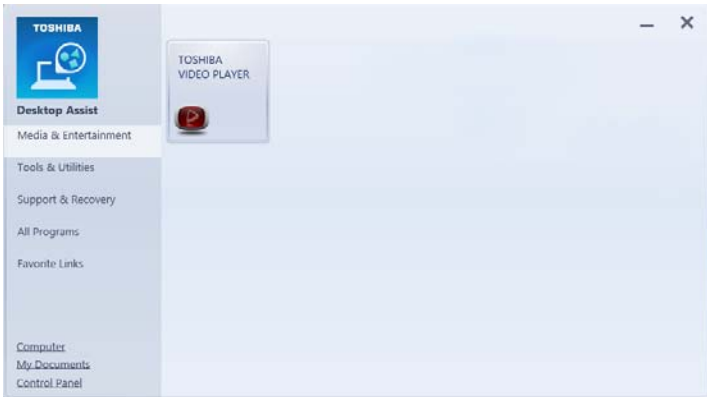

*(Sample Image) Desktop Assist window*

The Desktop Assist offers several options:

- ❖ [Media & Entertainment](#)
- ❖ [Tools & Utilities](#)
- ❖ [Support & Recovery](#)

## Media & Entertainment

The feature available in this category is TOSHIBA Video Player.



*(Sample Image) Desktop Assist window – Media & Entertainment tab*

## Tools & Utilities

The features that may be available in this category are:

- ❖ eco Utility®
- ❖ Password Utility
- ❖ System Settings
- ❖ TOSHIBA function key



*(Sample Image) Desktop Assist window – Tools & Utilities tab*

## Support & Recovery

The features that may be available in this category are:

- ❖ [Recovery Media Creator](#)
- ❖ [Service Station](#)
- ❖ [TOSHIBA Application Installer](#)
- ❖ [User's Guide](#)



*(Sample Image) Desktop Assist window – Support & Recovery tab*



## eco Utility®

The eco Utility® monitors your power savings from using the eco power plan by tracking real-time power consumption and accumulated savings over time.

To access the eco Utility®:

- 1 From the Start screen begin typing **eco Utility**, or while in the Desktop screen double-click or touch the **Desktop Assist** icon.
- 2 Click or touch **Tools & Utilities**.
- 3 Click or touch **eco Utility**.

The eco Utility® window appears.



*(Sample Image) eco Utility® window*

- 4 To activate the eco power plan, select **eco Mode** on the left side.
- 5 Click or touch the **eco Mode** button.
- 6 Click or touch **Close**.

For more information on the eco power plan and utility, click or touch the **Help** button at the bottom of the window.

---

## Password Utility

Setting a password lets you walk away from your computer while providing additional protection for your files. When you set a password, you must enter the password before you can work on your computer again.

TOSHIBA supports several types of passwords on your computer:

- ❖ A supervisor password—Prohibits unauthorized users from accessing certain functions such as System Settings. This is useful if more than one person uses the computer.
- ❖ A user password—Prevents unauthorized users from starting the computer.

When setting up passwords, keep the following in mind:

- ❖ The supervisor password must be set before the user password, or the user password must be deleted and then re-entered after the supervisor password is set.
- ❖ The user password can be set up under the supervisor password.

### Using a supervisor password

A supervisor password prevents other users from changing hardware configuration options.

### Setting a supervisor password

---

**CAUTION**

If you choose to set a supervisor or user password, TOSHIBA strongly recommends that you save your password in a location where you can later access it should you not remember it.

TOSHIBA is not responsible for any losses that may occur to you, your organization or others as a result of the inability to access your computer.

---

To set a supervisor password:

- 1 To access Supervisor Password from the Start screen begin typing **Password Utility**, or while in the Desktop screen double-click or touch the **Desktop Assist** icon.



- 2 Click or touch **Tools & Utilities**.
- 3 Click or touch **Password Utility**.



*(Sample Image) Supervisor Password tab*

- 4 Click or touch **Supervisor Password**.
- 5 Click or touch **Set**.
- 6 Enter your password, and then enter it again to verify it.
- 7 Click or touch **Set**.

**NOTE** Under User Policy, this option may or may not ask for password verification.

- 8 Click or touch **OK** to save your password as a text file.

Password Utility will suggest "memo.txt" for the text file name. If you have saved a password previously, using the same name may overwrite your password text file with the new password. By using a different name, you can prevent overwriting your previously stored passwords.

- 9 Click or touch **Save**.
- 10 Click or touch **OK**.

---

## Deleting a supervisor password

To delete a supervisor password:

- 1 To access Supervisor Password from the Start screen begin typing **Password Utility**, or while in the Desktop screen double-click or touch the **Desktop Assist** icon.
- 2 Click or touch **Tools & Utilities**.
- 3 Click or touch **Password Utility**.  
A pop-up screen appears asking for a password.
- 4 Enter your password, and then click or touch **Verify**.
- 5 Click or touch **Supervisor Password**.
- 6 Click or touch **Delete**.  
An authority verification pop-up screen appears.
- 7 Click or touch **Delete**.
- 8 Enter the password, and then click or touch **Verify**.
- 9 Click or touch **OK** to exit.

## Using a user password

A user password provides power-on password protection.

## Setting a user password

---

**CAUTION**

If you choose to set a supervisor or user password, TOSHIBA strongly recommends that you save your password in a location where you can later access it should you not remember it.

TOSHIBA is not responsible for any losses that may occur to you, your organization or others as a result of the inability to access your computer.

---

To register a password for the power-on password functions:

- 1 To access User Password from the Start screen begin typing **Password Utility**, or while in the Desktop screen double-click or touch the **Desktop Assist** icon.

- 2 Click or touch **Tools & Utilities**.
- 3 Click or touch **Password Utility**.
- 4 Click or touch **User Password**.
- 5 Click or touch **Set**.
- 6 Enter your password, and then enter it again to verify.
- 7 Click or touch **Set**.
- 8 Click or touch **OK** to save your password as a text file.

---

Password Utility will suggest “memo.txt” for the text file name. If you have saved a password previously, using the same name may overwrite your password text file with the new password. By using a different name, you can prevent overwriting your previously stored passwords.

---

- 9 Click or touch **Save**.
- 10 Click or touch **OK**.

## Deleting a user password

To cancel the power-on password function:

- 1 To access User Password from the Start screen begin typing **Password Utility**, or while in the Desktop screen double-click or touch the **Desktop Assist** icon.
- 2 Click or touch **Tools & Utilities**.
- 3 Click or touch **Password Utility**.  
A pop-up screen appears asking for a password.
- 4 Enter your password, and then click or touch **Verify**.
- 5 Click or touch **Delete**.  
An authority verification pop-up screen appears.
- 6 Click or touch **Delete**.
- 7 Enter the password, and then click or touch **Verify**.
- 8 Click or touch **OK** to exit.



## System Settings

System Settings is the TOSHIBA configuration management tool available through the Windows® operating system. To access it:

- 1 To access System Settings from the Start screen begin typing **System Settings**, or while in the Desktop screen double-click or touch the **Desktop Assist** icon.
- 2 Click or touch **Tools & Utilities**.
- 3 Click or touch **System Settings**.

The System Settings screen appears.

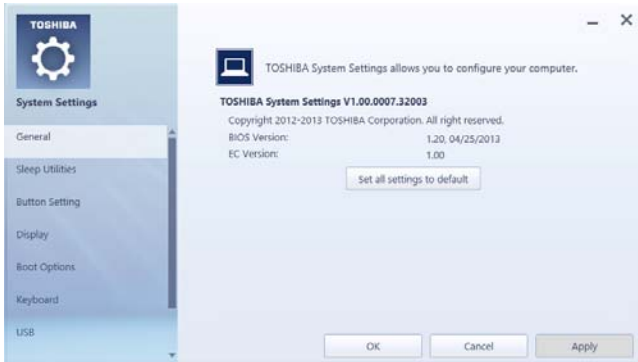

*(Sample Image) System Settings screen – General tab options*

The System Settings screen may have the following tabs:

- ❖ **Boot Options**—Allows you to change the sequence in which your computer searches the drives for the operating system
- ❖ **Boot Speed**—Reduces the time needed for the BIOS to initialize, using either the Fast or Normal settings.
- ❖ **Button Setting**—Allows you to customize the function buttons, such as updating and assigning other applications to the function buttons.

- 
- ❖ **Display**—Allows you to select the internal LCD and/or external monitor when the computer boots up.

---

**NOTE** When the computer restarts, it remembers the last configuration. If data does not appear on the display you are using after starting in Sleep mode, press the (⌘) + P keys to toggle the display.

---

- ❖ **General**—Allows you to view the current BIOS version or change certain settings back to their default values.
- ❖ **HDD Accelerator**—Allows you to accelerate the HDD by using a part of the computer's main memory as a cache.
- ❖ **Keyboard**—Allows you to set conditions for the keyboard.
- ❖ **LAN**—Allows you to set networking functions.
- ❖ **Sleep Utilities**—Sets advanced features when the computer is in Sleep mode, Hibernate mode, and Shut down state. See "[Sleep Utilities](#)" on page 88.
- ❖ **USB**—Allows you to enable or disable the internal USB 3.0 controller.

## Sleep Utilities

This utility displays whether the “USB Sleep and Charge function” is enabled or disabled and shows the position of the USB port that supports the “USB Sleep and Charge function.”



- 1 While in the Desktop screen double-click or touch the **Desktop Assist** icon.
- 2 Click or touch **Tools & Utilities**.
- 3 Click or touch **System Settings**.
- 4 Click or touch **Sleep Utilities**.

## USB Sleep and Charge

Your computer can supply USB bus power (DC 5V) to the USB port even when the computer is in Sleep mode, Hibernation mode or shutdown state (powered off).

This function can only be used for the port that supports the USB Sleep and Charge function (hereinafter called “compatible port”).

Compatible ports are USB ports that have the (⚡) symbol.

You can use the “USB Sleep and Charge function” to charge certain USB compatible external devices such as mobile phones or portable digital music players. However, the “USB Sleep and Charge function” may not work with certain external devices even if they are compliant with the USB specification. In those cases, power on the computer to charge the device.



- 
- NOTE**
- ❖ When “USB Sleep and Charge function” is set to Enabled, USB bus power (DC 5V) will be supplied to the compatible port even when the power of the computer is turned OFF. USB bus power (DC 5V) is similarly supplied to the external devices which are connected to the compatible ports. However, some external devices cannot be charged solely by supplying USB bus power (DC 5V). As for the specifications of the external devices, please contact the device manufacturer or check the specifications of the external devices thoroughly before use.
  - ❖ Using the “USB Sleep and Charge function” to charge external devices will take longer than charging the devices with their own chargers.
  - ❖ External devices connected to the USB bus power (DC 5V) function that interfaces with the power ON/OFF of the computer may always be in an operational state.
  - ❖ When there is a current overflow of the external device connected to the compatible port, USB bus power (DC 5V) supply may be stopped for safety reasons.
- 

**▲ WARNING** Metal paper clips or hair pins/clips will generate heat if they come into contact with USB ports. Do not allow USB ports to come into contact with metal products.

---

## Enabling/Disabling USB Sleep and Charge

This utility can be used to enable or disable the USB Sleep and Charge function. To enable this function, select **Enable**. To disable this function, toggle the Enable button to the **Disabled** position.

## Power supply mode settings

Your computer may provide two different charging modes, to support various types of USB devices. If your computer provides more than one charging mode, the charging mode you should select depends on the USB device you want to charge. For example, **Auto Mode**, which is the default mode, will charge a wide variety of digital audio players. If your device does not charge in Auto Mode, try using **Alternate Mode**. To select a different charging mode, use the **Power supply mode** drop-down list in the utility.

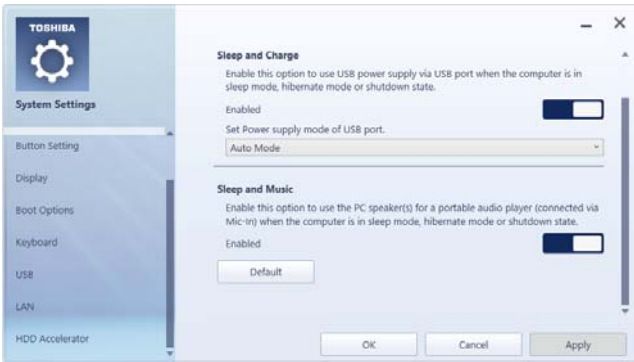

*(Sample Image) TOSHIBA Sleep Utility screen*

**NOTE** With certain external devices, the USB Sleep and Charge function may not work no matter which charging mode you select. In those cases, disable USB Sleep and Charge in the utility and turn the computer on to charge the device, or use a different charging device.

## Sleep and Music

Your Toshiba computer may be equipped with the “Sleep and Music” feature that allows you to listen to music stored on a portable audio device using the speakers of your computer, even when the computer is powered OFF. Power OFF includes Sleep Mode, Hibernation Mode, or Shut down state.

When the Sleep and Music feature is enabled, it is possible to play music from the computer’s speakers by connecting an audio cable to the Microphone/Line-in  jack.

---

The volume settings and sound quality may differ between Windows® mode and “Sleep and Music” mode. When using the “Sleep and Music” feature, the volume adjustment and mute setting cannot be changed from the computer. To adjust these settings, use the volume controls on your portable audio device. Be sure to turn down the volume of the portable audio device before connecting it to the computer.

---

**NOTE** This feature applies only to the computer’s speakers. The headphone jack and mute function on the computer are disabled when using “Sleep and Music.”

---

---

## TOSHIBA function key

Turns notifications for wireless status ON/OFF.



*(Sample Image) Function Key*

---

**NOTE**

The TOSHIBA function key is disabled by default.

---

## Recovery Media Creator

The Recovery Media Creator utility enables you to create recovery media that can be used to return your system to its out-of-box state, if necessary. For detailed information on using the utility to create recovery media, see [“Creating recovery media” on page 33](#).

## Service Station

The Service Station helps you keep your new computer running at its best by notifying you when updated software, firmware, documentation or other information is available for your computer. The Service Station will alert you when updates are available, and you can then choose to install the updates if you wish.

## TOSHIBA Application Installer

The TOSHIBA Application Installer allows you to reinstall the drivers and applications that were originally bundled with your computer.

To reinstall drivers and applications:

- 1 To access TOSHIBA Application Installer from the Start screen begin typing **Application Installer**, or while in the Desktop screen double-click or touch the **Desktop Assist** icon.
- 2 Click or touch **Support & Recovery**.
- 3 Click TOSHIBA Application Installer.
- 4 Click or touch **TOSHIBA Application Installer**.

The TOSHIBA Application Installer window appears.

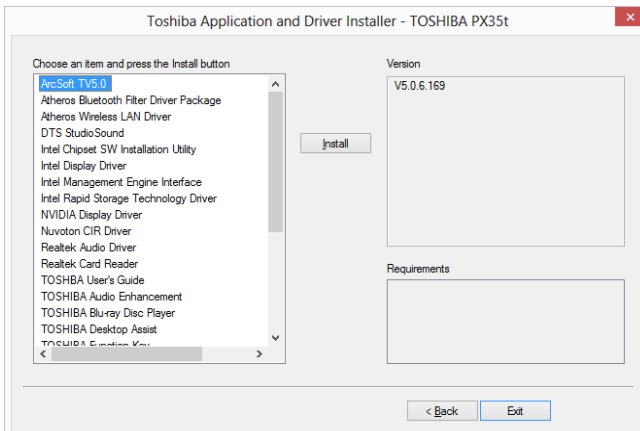

*(Sample Image) TOSHIBA Application Installer selection screen*

- 5 Click or touch the item you want to install.
- 6 Click or touch **Install**, then follow the on-screen prompts to complete the installation process.

# Chapter 6

## If Something Goes Wrong

---

Some problems you may encounter when using your computer are relatively easy to identify and solve. Others may require help from your network administrator or the manufacturer of the software program.

This chapter aims to help you solve many problems by yourself. It covers the problems you are most likely to encounter.

If all else fails, contact Toshiba. You will find information on Toshiba's support services at the end of this chapter.

### Problems that are easy to fix

#### **Your program or application stops responding.**

---

The Windows 8 operating system allows for the use of both applications ("Apps" used with the Windows® "Modern UI") and programs (used in the traditional Windows® desktop environment). For the purpose of simplifying the information we will use the terms interchangeably in this chapter.

---

If you are working in a program that suddenly freezes, chances are the program has stopped responding. You can exit the program without shutting down the operating system or closing other programs.

To close a program that has stopped responding:

- 1 Press Ctrl, Alt, and Del simultaneously (once), and then click or touch **Task Manager**.

The Task Manager window appears.

- 2 Select the program or application you want to close, and then click or touch **End Task** in the lower right corner.

Closing the failed program should allow you to continue working. If it does not, continue with the next step.

- 3 Close the remaining programs one by one by selecting the program name, then select **End Task**.

Closing all programs should allow you to continue working. If it does not, power off your computer, and then restart it.

## **Problems when you turn on the computer**

These problems may occur when you turn on the power.

### **The computer will not start.**

Make sure you attached the AC adaptor and power cord/cable properly.

Press and hold the power button for at least 10 seconds.

Check that the wall outlet is working by plugging in another device, such as a lamp.

Verify that the computer is on by looking at the ON/OFF indicator. If the indicator is glowing white, the computer is on. Also, try turning the computer off and then on.

Verify that the computer is receiving power from the external power source by looking at the ON/OFF light. If the indicator is glowing, the computer is connected to a live external power source.



**The computer displays the** WARNING RESUME FAILURE/Windows Error Recovery – Windows did not shut down successfully **message.**

To continue, select **Start Windows normally**. If you performed a shutdown before this message was displayed, a program or driver may have prevented Windows® from shutting down.

Data stored in the computer's memory has been lost. Data stored in the computer's internal storage drive may not be affected.

## The Windows® operating system is not working

Once you are familiar with your computer and used to the way the operating system responds to your work routine, you can easily detect if the operating system is not working correctly. For example:

- ❖ The operating system fails to start after the initial startup appears.
- ❖ The operating system takes a long time to start.
- ❖ The operating system responds differently from the normal routine.
- ❖ The screen does not look right.

Unless a hardware device has failed, problems usually occur when you change the system in some way such as installing a new program or adding a device.

If you experience any of these problems, use the options in the Startup menu to fix the problem.

## Using Startup options to fix problems

If the operating system fails to start properly, you may need to troubleshoot the operating system and/or its settings. There are several options to choose from depending on the severity of the problem and your level of expertise with computers.

If Windows® fails to start properly twice, the Windows Boot menu will launch. To enter the Boot menu manually:

- 1 Press Ctrl, Alt, and Del simultaneously (once).
- 2 Press the **Power** button in the lower right corner of your screen.

- 3 Click or touch the **Restart** option from the menu.
- 4 Click or touch **Troubleshoot** from the menu.

You now have several options:

### **Refresh your computer**

- ❖ Your files and personalization settings won't change.
- ❖ Your computer settings will be changed back to their defaults.
- ❖ Your Apps from the Windows® Store are retained.
- ❖ Apps you installed from discs or Web sites are removed.
- ❖ A list of removed apps is saved to your desktop.

For more information, see [“Refresh your PC \(with user's data\)” on page 37.](#)

### **Reset your computer**

- ❖ All of your personal files and apps are removed.
- ❖ Your computer settings are changed back to their defaults.

For more information, see [“Reset your PC” on page 39.](#)

### **Advanced options**

Clicking this option presents you with another set of options:

#### **System Restore**

- ❖ System Restore allows you to use a Restore point to return the computer to a state at which it was performing properly. Restore points are created:
  - ❖ When new hardware or software is installed
  - ❖ Manually by the user

#### **System Image Recovery**

Windows® will “Recover” the Operating system using a specific image provided by the user.

#### **Automatic Repair**

This feature automates the repair process. The Operating System will automatically look for problems and repair them if possible.

## Command Prompt

The command prompt is a very powerful tool for advanced users.

## Startup Settings

In previous Operating Systems the majority of the options found on this menu were available by pressing the F8 key during the Windows® boot process:

- ❖ **Enable low resolution video mode**  
Restarts Windows® using your current video driver at low resolution. This allows you to reset your display settings in the event they have been improperly set.
- ❖ **Enable debugging mode**  
Starts Windows® in an advanced troubleshooting mode
- ❖ **Enable boot logging**  
Creates a file that lists all the drivers that are installed during startup
- ❖ **Enable Safe Mode**  
Starts Windows® with a minimal set of drivers and services. If the computer starts and runs in Safe Mode, you will know the Operating System is most likely working properly and that you should look to third-party applications or drivers for the source of your problem.
- ❖ **Disable driver signature enforcement**  
Allows drivers containing improper signatures to be installed
- ❖ **Disable early-launch anti-malware protection**  
Allows drivers to initialize without being measured by the Anti-malware driver
- ❖ **Disable automatic restart on system failure**  
Prevents Windows® from automatically restarting if an error causes it to fail. Choose this option only if Windows® is stuck in a loop where it fails, attempts to restart, and fails again repeatedly.

**Internet problems****My Internet connection is very slow.**

Many factors contribute to the speed with which you can surf the Internet. They include: network speed, network conditions, time of day (when everyone else is surfing, your access can be slow) and popularity of the sites you are trying to access. If accessing a particular site is very slow, try later.

**My browser cannot find the URL address I typed in.**

Make sure you separated the domain names of the address with the forward slash (/). Check the spelling of each name and the syntax of the address carefully. A single incorrect letter or missed character will make it impossible for your browser to locate the site.

**My browser cannot find a site I bookmarked.**

The World Wide Web is constantly changing. A site you bookmarked yesterday may not be available today or its server may be down for temporary repair. Try again later.

**The Windows® operating system can help you**

If the operating system has started properly but you still have a problem using your computer, the online Help can assist you in troubleshooting the problem. Getting to the online Help will differ depending on which interface you are in:

- ❖ **Start screen**—Type Help and Support
- 

**NOTE**

As soon as you begin typing, the search feature automatically begins.

---

- ❖ **Desktop**—Press the F1 key

When the “Windows Help and Support” screen appears, do one or both of the following:

- ❖ In the open search field type the topic you need help with and follow the on-screen instructions
- ❖ click one of the options listed in the window and follow the instructions

You can connect to Support Online by going to Toshiba support at [support.toshiba.com](http://support.toshiba.com).

---

## Fixing a problem with Device Manager

Device Manager provides a way to check and change the configuration of a device.

---

**CAUTION**

Changing the default settings using Device Manager can cause other conflicts that make one or more devices unusable. Device Manager is a configuration tool for advanced users who understand configuration parameters and the ramifications of changing them.

---

### Checking device properties

Device Manager provides a way to view the properties of a device. Properties include the name of the manufacturer, the type of device, the drivers installed, and the system resources assigned to the device.

To check a device's properties:

- 1 From the Start screen, type **Device**.

The search feature appears.

- 2 Click or touch **Settings**.

- 3 From the list of device(s), click or touch **Device Manger**.

- 4 To view the properties, double-click the device.

The operating system displays the device Properties dialog box, which provides an array of tabs. They may include:

- ❖ The **General** tab, which provides basic information about the device.
- ❖ The **Resources** tab, which lists resources assigned to the device. This tab does not appear if the device is not using resources.
- ❖ The **Driver** tab, which displays the drivers being used by the device. This tab also provides options for updating the driver or rolling back the driver in case the new version is causing a problem.

The tabs that appear in the dialog box vary from one device to another.

For more information about Device Manager, refer to Windows® online Help.

## Memory problems

Incorrectly connected or faulty memory modules may cause errors that seem to be hardware or even software related. It is worthwhile checking for these first:

- 1 From the Start or Desktop screen, move your pointer over the upper or lower right corner of the screen.
- 2 When the Windows charms appear, click or touch the **Settings** (⚙️) charm.
- 3 In the lower right of the screen click or touch the **Power** (🔌) icon.

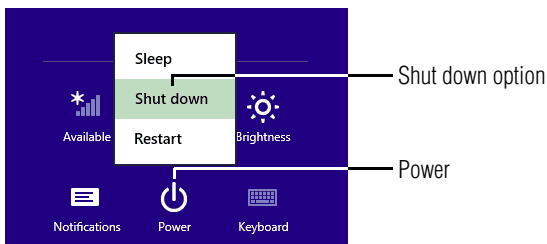

*(Sample Image) Shut down*

- 4 While holding the Shift key, click or touch the **Shut down** option.

The computer closes all open applications, shuts down the operating system, and then turns off.

- 5 Check for the error again.
- 6 If the error recurs, remove the memory module entirely and check for the error again.

If removing the memory module eliminates the error, the memory module may be faulty. If the error recurs without the memory module installed, the error is not caused by the memory module.



**TECHNICAL NOTE:** You must have at least one memory module installed for the computer to work.

### NOTE

For this model, Slot A is the bottom slot. Slot B is the top slot. If only one memory module is to be installed, it must be installed in Slot A.

---

## Power and the battery

Your computer receives its power through the AC adaptor and power cord/cable and from the real-time clock (RTC) battery. A faulty AC adaptor or power cord/cable will not power the computer.

Here are some typical problems and how to solve them:

### **The ON/OFF light does not come on when you plug in the AC adaptor and power cord/cable.**

Make sure the AC adaptor and power cord/cable are firmly plugged into both the wall outlet and the computer.

If the ON/OFF light still does not come on, check that the wall outlet is working properly by plugging in a lamp or other appliance.

## Keyboard problems

---

**NOTE** To capture a print screen of the entire screen, press the Fn + PRTSC key.

To capture only the active window displayed, press Fn + ALT while simultaneously pressing the PRTSC key.

---

### **You have connected an external keyboard and the operating system displays one or more keyboard error messages.**

You may need to update your keyboard driver. Refer to the documentation that came with the keyboard or to the keyboard manufacturer's Web site.

The keyboard you connected may be defective or incompatible with the computer. Try using a different make of keyboard.

## Display problems

Here are some typical display problems and their solutions:

### **The screen is blank.**

Display Auto Off may have gone into effect. Press any key to activate the screen.

You may have activated the instant password feature by pressing Fn and F1 simultaneously. If you have registered a password, press any key, type the password and press ENTER. If no password is registered, press any key. The screen reactivates and allows you to continue working.

**The screen does not look correct.**

Choose a theme for your desktop background, under **Change the visuals and sounds on your computer**, in the **Themes** panel. You can also change the setting for individual components separately by selecting an item from just below the **Themes** panel (**Desktop Background**, **Color**, **Sounds**, and **Screen Saver**).

For more information, see the Windows® online Help.

**Small bright dots appear on your TFT display when you turn on your computer.**

Small bright dots may appear on your screen display when you turn on your computer. Your display contains an extremely large number of thin-film transistors (TFT) and is manufactured using high-precision technology. Any small bright dots that may appear on your display are an intrinsic characteristic of the TFT manufacturing technology. Over a period of time, and depending on the usage of the computer, the brightness of the screen will deteriorate. This is also an intrinsic characteristic of the screen technology.

**Disk or storage drive problems**

Problems with the storage drive or with external media usually show up as an inability to access the drive or as sector errors. Sometimes a drive problem may cause one or more files to appear to have garbage in them. Typical problems are:

**Error-checking**

---

**NOTE** This feature is not available for optical disc drives.

---

Run Error-checking, which analyzes the directories and files on the storage drive and repairs any damage it finds.

To run Error-checking:

- 1 From the Start screen, type **computer**.



- 2 Click or touch **Computer** from the list that appears.

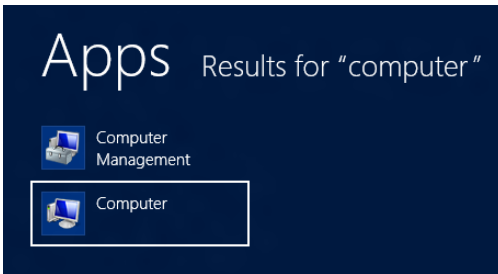

*(Sample Image) Search results for "computer"*

- 3 Right-click or touch the drive you wish to check.

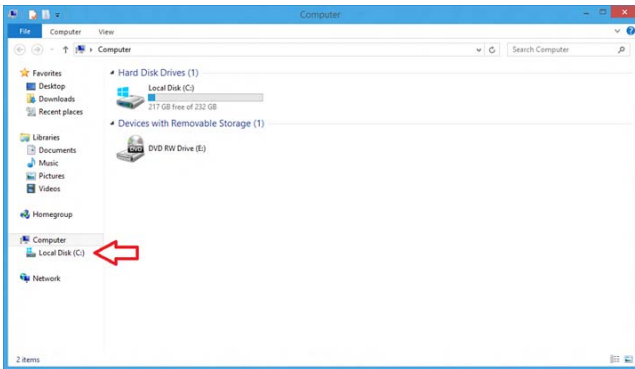

*(Sample Image) Clicking on the drive*

- 4 In the pop-up menu, click or touch **Properties**.  
The drive's Properties box appears.
- 5 Click or touch the **Tools** tab.
- 6 Click or touch the **Check** button.  
The Error Checking box appears.  
The system will alert you if you need to scan the drive.
- 7 Even if you do not need to scan the drive for errors you can scan by clicking or touching **Scan drive**.  
Error-checking tests and repairs the storage drive.

**Your hard disk seems very slow.**

If you have been using your computer for a long time, your files may have become fragmented. Run Disk Defragmenter.

To do this:

- 1 Move your pointer to the upper-right corner of the screen or swipe in from the right edge. When the Windows® charms appear click or touch the **Search** (🔍) charm, then click or touch **Settings** and, in the Search field, type **Defragment**.
- 2 Click or touch **Defragment and Optimize Drives**.
- 3 From the Optimize Drives menu click or touch the drive you wish to defragment.
- 4 Click or touch the **Optimize** button.

The system will display the status as it optimizes and defragments the drive.

**Your data files are damaged or corrupted.**

Refer to your software documentation for file recovery procedures. Many software packages automatically create backup files.

You may also be able to recover lost data using utility software. Consult the dealer from whom you purchased your computer and/or program. Your dealer is your best source for current information.

**Some programs run correctly but others do not.**

This is probably a configuration problem. If a program does not run properly, refer to its documentation and check that the hardware configuration meets its needs.

**Optical disc drive problems****You cannot access a disc in the drive.**

If the optical disc drive is an external drive, make sure the two USB cables or the AC adaptor cable are properly connected to the computer and refer to the documentation that came with your drive.

Make sure the tray that holds the optical disc is closed properly. Press gently until it clicks into place.

Open the tray and remove the disc. Make sure the tray is clean. Any dirt or foreign object can interfere with the laser beam.

---

Examine the disc to see if it is dirty. If necessary, wipe it with a clean cloth dipped in water or a neutral cleaner.

Replace the disc in the tray. Make sure that the disc is lying flat against the tray, label side out. Close the tray carefully, making sure it has shut completely.

**You press the disc eject button, but the drive tray does not slide out.**

Make sure the computer is connected to a power source and turned on. The optical disc drive eject mechanism requires power to operate.

Make sure a program is not accessing the drive and preventing it from ejecting.

If you need to remove a disc and cannot turn on the computer, use a narrow object, such as a straightened paper clip, to press the manual eject button. This button is in the small hole next to the optical disc drive eject button on the face of the optical disc drive tray.

---

**CAUTION**

Never use a pencil to press the manual eject button. Pencil lead can break off inside the computer and damage it.

---

**Some discs run correctly but others do not.**

Check that the type of disc you are using is compatible with your optical disc drive. For more information regarding supported optical media formats, refer to the complete detail specifications for your computer at [support.toshiba.com](http://support.toshiba.com).

If the problem is with an optical data disc, refer to the software's documentation and check that the hardware configuration meets the program's needs.

**The disc will not come out of the drive when you click the eject button on the screen.**

Press the button on the optical disc drive itself. For additional information see [“You press the disc eject button, but the drive tray does not slide out.” on page 107.](#)

## Sound system problems

### **No sound is coming from the computer's speakers.**

Adjust the volume control.

Try pressing the F11 key to see if volume mute is disabled.

Check that the volume control on the computer is turned up.

If you are using external headphones or speakers, check that they are securely connected to your computer.

### **The computer emits a loud, high-pitched noise.**

This is feedback between the microphone and the speakers.

Make sure you have connected the microphone to the microphone jack and the speakers to the headphone jack.

Adjust the volume control.

## Printer problems

This section lists some of the most common printer problems.

### **The printer will not print.**

Check that the printer is connected to a working power outlet, turned on and ready (on line).

Check that the printer has plenty of paper. Some printers will not start printing when there are just two or three sheets of paper left in the tray.

Make sure that the printer cable is firmly attached to the computer and the printer, or that the wireless connection is good.

Run the printer's self-test to check for any problem with the printer itself.

Make sure that you installed the proper printer drivers as shown in the instructions that came with the printer.

You may have connected the printer while the computer is on. Disable Sleep mode, turn off the computer, and turn off the printer. Turn the printer back on, make sure that it is online, and then turn the computer back on.

Try printing another file. For example, you could create and attempt to print a short test file using Notepad. If a Notepad file prints correctly, the problem may be in your original file.

If you cannot resolve the problem, contact the printer's manufacturer.

---

## The printer will not print what you see on the screen.

Many programs display information on the screen differently from the way they print it. See if your program has a print preview mode. This mode lets you see your work exactly as it will print. Contact the software manufacturer for more information.

## Wireless networking problems

---

**NOTE** This section provides general troubleshooting tips for networking problems, specifically wireless (Wi-Fi®) networking.

The terms and concepts used assume a basic understanding of networks, and may be for more advanced users. If you need assistance or if you are not familiar with the terminology, please see Windows® Help and Support or contact your computer technician.

---

- ❖ Verify that your computer can detect access points or routers. If it can detect a Wi-Fi® access point or router then it may be a configuration issue.
- ❖ Verify that signal strength is good using the utility provided with the Wi-Fi® adapter.
- ❖ If another computer is on the same network, verify that it has network access, and can connect to the Internet. If, for example, the other computer cannot browse to a public Web site, the ISP's (Internet Service Provider) service may be disrupted.
- ❖ Verify that the Service Set Identifier (SSID), or network name, is correct – i.e., that it matches the SSID assigned to the access point you are attempting to connect through. SSIDs are case-sensitive.
- ❖ Check the Windows® Control Panel's Device Manager to verify that the Wi-Fi® adapter is recognized by the Windows® operating system, and that the driver is loaded. To access the Device Manager, from the Start screen begin typing **Computer**. If you are in the Desktop screen, move your pointer to the upper-right corner of the screen or swipe in from the right edge. When the Windows® charms appear click or touch the **Search** (🔍) charm, and then type **Computer**. Click or touch **Control Panel, System and Security**, and then

---

**System.** Carefully note any error messages – these will be very helpful if you should confer with a support technician at a later time.

---

**NOTE** To enable or disable wireless communication, use the F12 key. For more information see [“TOSHIBA Function Keys” on page 120.](#)

---

- ❖ Use IPCONFIG to verify that the computer has a useful IP address – one other than the private address of 169.254.xxx.xxx assigned by Windows®.

- 1 From the Start screen, type Cmd.
- 2 Click **Command Prompt**.
- 3 Enter IPCONFIG/ALL, and then press ENTER.

The IP address for each active network adapter will be displayed.

- ❖ Connect your computer directly to your router or broadband modem, by plugging a standard CAT5 Ethernet patch cable (sold separately) into your computer's RJ45 Ethernet port. If your connection problem disappears, the problem lies in the Wi-Fi® part of your network.
- ❖ If you have enabled any security provisions (closed system, MAC address filtering, Wired Equivalent Privacy [WEP], etc.), check the access point vendor's Web site for recent firmware upgrades. Problems with WEP keys, in particular, are frequently addressed in new firmware releases.

### **The Windows® operating system wireless management utility does not work.**

If you are using an external Wi-Fi® adapter (a USB adapter, or other variety), check if the adapter comes with its own management utility. If it does, the utility may be disabling the Windows® operating system wireless management utility, in which case you must use the adapter's management utility. If the documentation that accompanies the adapter does not provide enough information to determine if this is the case, contact that vendor's support group for further advice.

## DVD operating problems

If you experience a problem playing DVDs, you may be able to fix the problem yourself.

For general problems playing a DVD title, try the following steps:

- 1 Verify that the disc is in a format that the drive supports.
- 2 Ensure that the disc is properly inserted in the drive tray.
- 3 Use the DVD Player software that came with your computer to view DVD movies.
- 4 Clean the disc and try again.

A dirty drive can also cause audio problems. If you have tried several discs and all fail, consider sending your drive to an authorized service provider to get it cleaned.

- 5 From the Start screen, type **Computer**. Click or touch **Computer** from the list that appears.

The optical disc drive should appear in the list.

- 6 See [“Checking device properties” on page 101](#) for instructions on using Device Manager to view the optical disc drive properties.
- 7 Check the Toshiba Web site for new information on optical disc drives and their operation.

### A blank screen appears while watching a DVD-ROM movie or title.

Change the setting for when to turn off the display using the following steps:

- 1 Move your pointer to the upper-right corner of the screen or swipe in from the right edge. When the Windows® charms appear, click or touch the **Search** (🔍) charm, click or touch **Settings** and, in the Search field, type **Power**.
- 2 From the search list, click or touch **Choose when to turn off display**.
- 3 To keep the display from turning off, click or touch **Never** in both drop down lists.
- 4 Click or touch **Save changes**.

**The screen saver runs while you are watching a movie or title.**

If the screen saver is enabled, it runs on top of any movie or title you are watching. To disable the screen saver:

- 1 Right-click the desktop and click **Personalize** in the menu.
- 2 Click or touch **Screen Saver** in the lower-right corner of the window.
- 3 Select **None** from the **Screen saver** drop-down list.
- 4 Click or touch **OK**.

**Develop good computing habits****Save your work frequently.**

You can never predict when your computer will lock, forcing you to close a program and lose unsaved changes. Many software applications build in an automatic backup, but you should not rely solely on this feature. Save your work! See [“Computing tips” on page 47](#) for instructions.

**On a regular basis, back up the information stored on your internal storage drive.**

Use Windows® to back up files, or the entire computer, to an optical disc, USB drive, or external hard disk. Here are some ways you can do this:

- ❖ Use the Windows® operating system to back up files or your entire computer to an optical disc, USB drive, or external hard disk.
- ❖ Copy files to a rewritable external storage device.
- ❖ Connect your computer to the office network and copy files to your network partition.

Some people use a combination of these methods, backing up all files to tape weekly and copying critical files to external media on a daily basis.

If you have installed your own programs, you should back up these programs as well as your data files. If something goes wrong that requires you to reformat your internal storage drive and start again, reloading all your programs and data files from a backup source will save time.



## Read the user's guides.

It is very difficult to provide a fail-safe set of steps you can follow every time you experience a problem with the computer. Your ability to solve problems will improve as you learn about how the computer and its software work together.

Get familiar with all the user's guides provided with your computer, as well as the manuals that come with the programs and devices you purchase.

Your local computer store or book store sells a variety of self-help books you can use to supplement the information in the manuals.

## Data and system configuration backup in the Windows® operating system

The Windows® operating system offers some easy-to-use features for backing up your Windows® settings and your data - documents and other important files. Take advantage of these features to protect yourself from much more difficult and time-consuming restoration procedures, and to safeguard your valuable data from loss.

### Saving system configuration with restore points

The System Restore feature of the Windows® operating system quickly creates restore points - 'snapshots' of your Windows® operating system configuration - and saves them for later recall. If you experience problems after installing some new hardware or software, you can easily select a previously established Control Point to 'turn back the clock,' restoring the Windows® operating system to the state it was in just prior to the installation. This is much easier and more effective than uninstalling the hardware or software, which often leaves behind unwanted files and settings. It is also easy to undo a restore point selection, if you change your mind.

Follow these steps to create a restore point using the System Restore utility:

- 1 From the Start screen, type **Control**. Click or touch **Control Panel** from the list that appears.
- 2 Click or touch **System and Security**, and then **System**.

- 3 In the left pane, click or touch **System Protection**.  
The System Protection tab of the System Properties window appears.
- 4 Click or touch **Configure**.
- 5 Under **Restore settings** select **Turn on System Protection**.
- 6 Click or touch **OK**.
- 7 Click or touch **Create**.
- 8 In the input field, enter a name that is descriptive enough to be easily understood in the future, such as “Before installing Brand X Accounting app.” Then click or touch **Create**.

The Windows® operating system creates the restore point, automatically stamps it with the current date and time, and displays a message that the restore point was successfully created.

- 9 Click or touch **Close**.

Then, at a later time, you can re-establish your Windows® configuration using the saved restore point. To do this:

- 1 From the Start screen, type **Control**. Click or touch **Control Panel** from the list that appears.
- 2 Click or touch **System and Security**, and then **System**.
- 3 In the left pane, click or touch **System Protection**.  
The System Protection tab of the System Properties window appears.
- 4 Click or touch **System Restore...**
- 5 Click or touch **Next**.
- 6 Click or touch the Restore point you want to use then click or touch **Next**.

The time stamp and description of each Restore point is displayed.

---

**NOTE**

At this point you can click “Scan for affected programs” to determine what the impact of using the clicked Restore Point will be.

---

- 7 Verify that the Restore point you chose is the correct one. If it is not, click or touch **Back** to return to the previous step.
- 8 Close all programs and save all open files.
- 9 Click or touch **Finish**, and then **Yes** to begin the system restore.

Your Windows® operating system configuration will now be restored to the state it was in when the chosen restore point was created, and then the computer will be automatically restarted.

## Backing up your data or your entire computer with the Windows® operating system

The most valuable component of your computer system is the data you create and store on its internal storage drive. Since problems with either hardware or software can make the data inaccessible or even destroy it, the next most valuable component of your computer system may be a recent backup of your data.

Fortunately, the Windows® operating system offers a convenient way to back up your computer or just your important files to optical disc drives, or hard drives. An external hard drive is recommended in case the internal storage drive fails. No additional software is required. Most of the optical disc drives built into recent Toshiba computer models can write to (or “burn”) as well as read from optical discs. External optical disc writers are also widely available.

Follow these steps to back up your computer or files to optical discs, or a storage drive:

- 1 From the Start screen, type **Control**. Click or touch **Control Panel** from the list that appears.
- 2 Click or touch **Save backup copies of your files with File History** under the **System and Security** heading. Follow the on-screen instructions to back up your files.

For additional Help, while in the Windows® Desktop screen, press the F1 key to launch the Windows® Help and Support screen. Search for “back up files”.

## General tips for installing hardware and software

Here are a few tips to help ensure safe and easy installation of new hardware (printers, pointing devices, external hard drives, optical disc drive writers, scanners, etc.) and software (applications like Microsoft® Office and Adobe® Photoshop®, or utility software such as special toolbars for your web browser).

- ❖ Create a restore point (refer to [“Saving system configuration with restore points” on page 113](#)). Before installing anything, use the System Restore utility to set a restore point (see the section titled restore points). If anything goes wrong, you will then be able to easily restore the Windows® operating system to the state it was in prior to the installation, undoing any changes that the installation process introduced.
- ❖ Back up your critical data (see [“Backing up your data or your entire computer with the Windows® operating system” on page 115](#)).
- ❖ Have your back up DVD(s) on hand in case you need any files from them.
- ❖ Do not guess – follow directions carefully! It is often necessary to run an installation utility first – before connecting a new hardware item to the computer. If the device is connected first, it may be very difficult to complete the installation successfully. Always carefully follow the installation instructions that accompany the hardware or software.
- ❖ Restart the Windows® operating system. Always restart the Windows® operating system after each installation, even if the installation utility does not prompt you to do so. This will ensure that the installation is completed, and will clean up anything that the installation utility left behind.
- ❖ Do one installation at a time. If you have several new items to add to your computer system, install just one at a time, creating restore points immediately before each successive installation. This will make it much easier to determine the origin of any new problems. For best results, follow this sequence:
  - 1 Back up critical data.
  - 2 Create a restore point.

- 3 Install one item of hardware or software.
- 4 Restart the Windows® operating system.
- 5 Use the new hardware or software for a while, noting any new problems. Make sure that your critical applications (email, business applications, etc.) are working correctly, and verify that important devices are still functioning.
- 6 For each additional hardware or software item, repeat these steps, starting at step 1 if any of your critical data has changed, or starting at step 2 if no critical data has changed.

### **USB Sleep and Charge is not working.**

USB Sleep and Charge may be disabled. Open the TOSHIBA Sleep and Charge utility to check if the feature is disabled and to enable it if necessary.

- ❖ Make sure that the device you want to charge is connected to a port that supports the USB Sleep and Charge function. Ports that support this feature are identified with the (⚡) symbol.
- ❖ USB Sleep and Charge may be disabled. Open the TOSHIBA Sleep utility to check if the feature is disabled and to enable it if necessary. For more information, see [“Enabling/Disabling USB Sleep and Charge” on page 89.](#)
- ❖ Try selecting a different charging mode in the TOSHIBA Sleep utility, if your computer provides more than one charging mode. For more information, see [“Power supply mode settings” on page 90.](#)
- ❖ The USB Sleep and Charge function may not work with certain external devices even if they are compliant with the USB specification. In those cases, power on the computer to charge the device or use a different charging device.

### **The “USB Wakeup function” does not work.**

- ❖ When the USB Sleep and Charge function is set to Enabled the USB Wakeup function does not work for ports that support the USB Sleep and Charge function. In that case, use a USB port that does not have the USB Sleep and Charge function -compatible symbol (⚡), if you have a non-Sleep and Charge USB port available, or disable the USB Sleep and Charge function. For more information, see [“Sleep Utilities” on page 88.](#)

---

## If you need further assistance

If you have followed the recommendations in this chapter and are still having problems, you may need additional technical assistance.

Since some problems may be related to the operating system or the program you are using, it is important to investigate other sources.

- ❖ Review the troubleshooting information in your operating system documentation.
- ❖ If the problem occurs while you are running a program, consult the program's documentation for troubleshooting suggestions. Contact the software company's technical support group for their assistance.
- ❖ Consult the dealer from whom you purchased your computer and/or program. Your dealer is your best source for current information.

For the detailed specifications for your computer, visit [support.toshiba.com](http://support.toshiba.com).

## Contacting Toshiba

### Toshiba's Technical Support Web site

For technical support, or to stay current on the most recent software and hardware options for your computer, and for other product information, be sure to regularly check the Toshiba Web site at [support.toshiba.com](http://support.toshiba.com).

## Other Toshiba Internet Web sites

<a href="http://toshiba.com">toshiba.com</a>	Worldwide Toshiba corporate site
<a href="http://us.toshiba.com">us.toshiba.com</a>	Marketing and product information in the USA
<a href="http://accessories.toshiba.com">accessories.toshiba.com</a>	Accessories information in the USA
<a href="http://www.toshiba.ca">www.toshiba.ca</a>	Canada
<a href="http://www.toshiba-Europe.com">www.toshiba-Europe.com</a>	Europe
<a href="http://www.toshiba.co.jp/index.htm">www.toshiba.co.jp/index.htm</a>	Japan
<a href="http://latin.toshiba.com">latin.toshiba.com</a>	Mexico and all of Latin America
<a href="http://acclaim.toshiba.com">acclaim.toshiba.com</a>	Toshiba USA Self-Service support web site

---

## Toshiba's worldwide offices

**Australia**

Toshiba (Australia) Pty. Limited  
84-92 Talavera Road  
North Ryde NSW 2113  
Sydney  
Australia

**France**

Toshiba Systèmes (France) S.A.  
7, Rue Ampère; B. P. 131  
92800 Puteaux Cédex  
France

**Italy**

Centro Direzionale Colleoni  
Palazzo Perseo  
Via Paracelso 10  
20041, Agrate Brianza  
Milano, Italy

**Latin America and Caribbean**

Toshiba America Information  
Systems, Inc.  
9740 Irvine Boulevard  
Irvine, California 92618  
United States

**Spain**

Toshiba Information Systems  
(España) S.A.  
Parque Empresarial San Fernando  
Edificio Europa, 1a Planta  
Escalera A  
28831 (Madrid) San Fernando de  
Henares  
Spain

**United States**

Toshiba America Information  
Systems, Inc.  
9740 Irvine Boulevard  
Irvine, California 92618  
United States

**Canada**

Toshiba Canada Ltd.  
191 McNabb Street  
Markham, Ontario  
L3R - 8H2  
Canada

**Germany**

Toshiba Europe GmbH  
Leibnizstraße 2  
D-93055 Regensburg  
Germany

**Japan**

Toshiba Corporation, PCO-IO  
1-1, Shibaura 1-Chome  
Minato-Ku, Tokyo, 105-8001  
Japan

**Mexico**

Toshiba de México S.A. de C.V.  
Sierra Candela No.111, 6to. Piso  
Col. Lomas de Chapultepec.  
CP 11000 Mexico, DF.

**United Kingdom**

Toshiba Information Systems  
(U.K) Ltd.  
Toshiba Court  
Weybridge Business Park  
Addlestone Road  
Weybridge, Surrey KT15 2UL  
United Kingdom

**The Rest of Europe**

Toshiba Europe (I.E.) GmbH  
Hammfelddamm 8  
D-4-1460 Neuss  
Germany

For more information on additional Toshiba worldwide locations, please visit: [www.toshiba.co.jp/index.htm](http://www.toshiba.co.jp/index.htm).

# Appendix A

## TOSHIBA Function Keys

---

TOSHIBA function keys provide a quick way to modify selected system functions and to launch applications.

### Functions

TOSHIBA Function keys are used to set or modify the following system functions:

- ❖ Help
- ❖ Display Brightness
- ❖ Internet and Media
- ❖ Mute
- ❖ Wireless ON/OFF
- ❖ Zoom (Display resolution)



## Help file



This TOSHIBA function key will display the help file.

## Display brightness



This TOSHIBA function key decreases the screen brightness.



This TOSHIBA function key increases the screen brightness.

## Internet and Media Control buttons



This TOSHIBA function key launches the default browser.



This TOSHIBA function key launches the Windows Media® Player.



This TOSHIBA function key allows you to return to the preceding track on the disc.



This TOSHIBA function key allows you to start playing the disc, or pause it if currently playing.



This TOSHIBA function key allows you to skip to the following track on the disc.



This TOSHIBA function key decreases the volume of the sound coming from the computer.



This TOSHIBA function key increases the volume of the sound coming from the computer.

## Volume Mute



This TOSHIBA function key enables/disables volume mute on your computer.

When volume mute is enabled, no sound will come from the speakers or headphones.

## Disabling or enabling wireless devices



This TOSHIBA Function key enables/disables the Wi-Fi® antenna in your computer.

The wireless modes are:

- ❖ Disables the wireless antenna
- ❖ Enables the wireless antenna

## Keyboard Function keys

Fn+



This TOSHIBA function key allows you to zoom out.

Fn+



This TOSHIBA function key allows you to zoom in.

## Zoom (Display resolution)



This TOSHIBA function key switches screen resolution.

Fn+ [Space bar]

Cycle through the screen resolutions, and then select the desired resolution.

# Appendix B

## Power Cord/Cable Connectors

Your computer ships with the correct power supply for the country of purchase. This appendix shows the shapes of the typical AC power cord/cable connectors for various parts of the world.

### USA



UL approved

### Canada



CSA approved

### United Kingdom

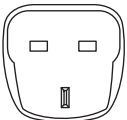

BS approved

### Europe



VDA approved  
NEMKO approved

### Australia



AS approved

# Glossary



TECHNICAL NOTE: Some features defined in this glossary may not be available on your computer.

## Acronyms

The following acronyms may appear in this User's Guide.

<b>AC</b>	Alternating Current
<b>BIOS</b>	Basic Input/Output System
<b>BD-ROM</b>	Blu-ray Disc Read-Only Memory
<b>bps</b>	bits per second
<b>CD</b>	Compact Disc
<b>CD-ROM</b>	Compact Disc Read-Only Memory
<b>CD-RW</b>	Compact Disc Rewrite Memory
<b>CMOS</b>	Complementary Metal-Oxide Semiconductor
<b>CPU</b>	Central Processing Unit
<b>DC</b>	Direct Current
<b>DMA</b>	Direct Memory Access
<b>DIMM</b>	Dual Inline Memory Module
<b>DOS</b>	Disk Operating System

<b>DPI</b>	Dots Per Inch
<b>DVD</b>	Digital Versatile (or Video) Disc
<b>DVD-ROM</b>	Digital Versatile (or Video) Disc Read-Only Memory
<b>eSATA</b>	external Serial Advanced Technology Attachment
<b>FAT</b>	File Allocation Table
<b>FCC</b>	Federal Communications Commission
<b>GB</b>	gigabyte
<b>GBps</b>	gigabytes per second
<b>HDD</b>	Hard Disk Drive
<b>HDMI</b>	High-Definition Multimedia Interface
<b>HDMI CEC</b>	High-Definition Multimedia Interface Consumer Electronics Control
<b>HTML</b>	Hypertext Markup Language
<b>IEEE</b>	Institute of Electrical and Electronics Engineers
<b>I/O</b>	Input/Output
<b>IRQ</b>	interrupt request
<b>ISP</b>	Internet Service Provider
<b>KB</b>	kilobyte
<b>LAN</b>	Local Area Network
<b>LCD</b>	Liquid Crystal Display
<b>LED</b>	Light Emitting Diode
<b>MB</b>	megabyte
<b>MBps</b>	megabytes per second
<b>MIDI</b>	Musical Instrument Digital Interface
<b>PC</b>	Personal Computer
<b>PCI</b>	Peripheral Component Interconnect
<b>PCMCIA</b>	Personal Computer Memory Card International Association
<b>RAM</b>	Random Access Memory
<b>RGB</b>	Red, Green Blue light (monitor)

---

<b>RFI</b>	Radio Frequency Interference
<b>ROM</b>	Read-Only Memory
<b>RTC</b>	Real-Time Clock
<b>SD</b>	Secure Digital
<b>SDRAM</b>	Synchronous Dynamic Random Access Memory
<b>SSD</b>	Solid State Drive
<b>TFT</b>	Thin Film Transistor
<b>USB</b>	Universal Serial Bus
<b>URL</b>	Uniform Resource Locator
<b>WAN</b>	Wide Area Network
<b>www</b>	World Wide Web

## Terms

The following terms may appear in this User's Guide.

**A active-matrix display**—A liquid crystal display (LCD) made from an array of liquid crystal cells using active-matrix technology. Also known as a “TFT display,” in its simplest form there is one thin film transistor (TFT) for each cell. This type of display works well with computers because of its shallow depth and high-quality color. Active-matrix displays are viewable from wider angles than most passive-matrix displays.

**adapter**—A device that provides a compatible connection between two units. For example, the computer's internal display adapter receives information from the software and translates it into images on the screen. An adapter can take a number of forms, from a microprocessor to a simple connector. An intelligent adapter (one that is capable of doing some processing) may also be called a controller.

**Alternating Current (AC)**—The type of power usually supplied to residential and commercial wall outlets. AC reverses its direction at regular intervals. Compare *Direct Current (DC)*.

**application**—A computer application that you use to perform tasks of a specific type. Applications include word processors, spreadsheets, and database management systems. See also *program*.

**B backup**—A copy of a file, usually on a removable disk, kept in case the original file is lost or damaged.

**Basic Input/Output System (BIOS)**—See *BIOS*.

**baud rate**—The speed at which a communication device, such as a printer or modem, transmits information. Baud rate is the number of signal changes per second (not necessarily the same as bits per second). See also *bits per second*.

**Blu-ray Disc (BD)**—Offering more storage capacity than DVDs, the format was developed to allow for more data storage and to enable recording and playback of high-definition video (HD).

**BIOS (Basic Input/Output System)**—Basic instructions, stored in read-only memory (ROM), containing the information the computer needs to check hardware and load the operating system when you start up the computer.

**bits per second (bps)**—A way of measuring the speed at which information is passed between two devices. This is the basic unit of measure used in modem communications, and is similar, but not identical, to the baud rate. See also *baud rate*.

**boot**—To start the computer. The term “boot” originates from bootstrap program (as in “pulling itself up by its bootstraps”), a program that loads and initializes the operating system. See also *reboot*.

**boot disk**—See *system disk*.

**boot setting (startup sequence)**—The order in which the computer accesses its internal storage drives to locate the startup files. Under the default startup sequence, the computer looks for the startup files in the external media before checking the internal storage drive.



**bus**—An electrical circuit that connects the central processing unit (CPU) with other parts of the computer, such as the video adapter, disk drives, and ports. It is the pathway through which data flows from one device to another. See also *bus speed*, *frontside bus*.

**bus speed**—The speed at which the central processing unit (CPU) communicates with the other parts of the computer.

**C** **cache**—A section of very fast memory in which frequently used information is duplicated for quick access. Accessing data from cache is faster than accessing it from the computer's main memory. See also *CPU cache*, *L1 cache*, *L2 cache*.

**CD**—An individual compact disc. See also *CD-ROM*.

**CD-ROM (Compact Disc Read-Only Memory)**—A form of high-capacity storage that uses laser optics instead of magnetic means for reading data. See also *CD*. Compare *DVD-ROM*.

**Central Processing Unit (CPU)**—The chip that functions as the “brain” of the computer. It takes information from outside sources, such as memory or keyboard input, processes the information, and sends the results to another device that uses the information.

**character**—Any letter, number, or symbol you can use on the computer. Some characters are non-printing characters, such as a paragraph break in a word-processing application. A character occupies one byte of computer storage.

**Charm/charms**—Start screen icons that slide out from the right side of the screen and direct you to various Windows® functions.

**chip**—A small piece of silicon containing computer logic and circuits for processing, memory, input/output, and/or control functions. Chips are mounted on printed circuit boards.

**click**—To press and release the pointing device's primary button without moving the pointing device. In the Windows® operating system, this refers to the pointing device's left button, unless otherwise stated. See also *double-click*.

**color palette**—A set of specified colors that establishes the colors that can be displayed on the screen at a particular time.

**compatibility**—The extent to which computers, applications, or devices can work together harmoniously, using the same commands, formats, or language as another.

**configuration**—(1) The collection of components that make up a single computer system. (2) How parts of the system are set up (that is, configured).

**controller**—A device that controls the transfer of data from a computer to a peripheral device and vice versa. For example, disk drives, monitors, keyboards, and printers all require controllers.

**CPU**—See *Central Processing Unit (CPU)*.

**CPU cache**—A section of very fast memory residing between the CPU and the computer's main memory that temporarily stores data and instructions the CPU will need to execute commands and applications. See also *cache, L1 cache, L2 cache*.

**cursor**—An on-screen symbol (usually a flashing vertical line) that indicates the position where characters will appear when you enter data.

**D Desktop**—Displays the standard Windows® operating system look and feel.

**default**—The setting selected by an application when the user does not specify an alternative setting.

**device**—A component attached to the computer. Devices may be external (outside the computer's case) or internal (inside the computer's case). Printers, disk drives, and modems are examples of devices.

- device driver**—A program (called a “driver”) that permits a computer to communicate with a device.
- dialog box**—An on-screen window displayed by the operating system or an application giving a direction or requesting input from the user.
- Direct Current (DC)**—The type of power usually supplied by batteries. DC flows in one direction. Compare *Alternating Current (AC)*.
- Direct Memory Access (DMA)**—A dedicated channel, bypassing the CPU, that enables direct data transfer between memory and a device.
- directory**—See *folder*.
- disable**—To turn a computer option off. See also *enable*.
- disc**—A round, flat piece of material, designed to be read from and written to by optical (laser) technology, and used in the production of optical discs, such as CDs and DVDs. Compare *disk*.
- disk**—A round, flat piece of material that can be magnetically influenced to hold information in digital form, and used in the production of magnetic disks, such as hard disks. Compare *disc*. See also *hard disk*.
- disk drive**—The device that reads and writes information and applications on external media or hard disk. It rotates the disk at high speed past one or more read/write heads.
- document**—Any file created with an application and, if saved to disk, given a name by which it can be retrieved. See also *file*.
- double-click**—To press and release the pointing device’s primary button rapidly twice without moving the pointing device. In the Windows® operating system, this refers to the pointing device’s left button, unless otherwise stated.

**download**—(1) In communications, to receive a file from another computer through a modem or network. (2) To send font data from the computer to a printer. See also *upload*.

**drag**—To hold down the mouse button while moving the pointer to drag a selected object. In the Windows® operating system, this refers to the left mouse button, unless otherwise stated.

**driver**—See device *driver*.

**DVD**—An individual digital versatile (or video) disc. See also *DVD-ROM*.

**DVD-ROM (Digital Versatile [or Video] Disc Read-Only Memory)**—A very high-capacity storage medium that uses laser optics for reading data. Each DVD-ROM can hold as much data as several CD-ROMs. Compare *CD-ROM*.

**E emulation**—A technique in which a device or application imitates another device or application.

**enable**—To turn on a computer option. See also *disable*.

**eSATA**—An external device that supports hot swapping and fast data transfer. Very useful in storing and transferring large files.

**executable file**—A computer application that is ready to run. Application applications and batch files are examples of executable files. Names of executable files usually end with a .bat or .exe extension.

**expansion device**—A device that connects to a computer to expand its capabilities. Other names for an expansion device are port expander, port replicator, docking station, or network adapter.

**extension**—See *file extension*.

**external device**—See *device*.

- F** **file**—A collection of related information, saved on disk with a unique name. A file may be an application, information used by an application, or a document. See also *document*.
- File Allocation Table (FAT)**—The section of a storage drive that keeps track of the location of stored files.
- file name**—A set of characters that uniquely identifies a file within a particular folder. It consists of two parts: the actual name and the file name extension. See also *file extension*.
- file extension**—The three characters following the period (pronounced “dot”) at the end of a file name. The extension indicates the type of file. Examples are .exe for application files and .hlp for help files. See also *file name*.
- folder**—Also called directory. A container for organizing files saved to a disk. A folder is symbolized on screen by a graphical image (icon) of a file folder. A folder can contain files and other folders.
- format**—(verb) To prepare a blank disk for use with the computer’s operating system. Formatting creates a structure on the disk so the operating system can write information to the disk or read information from it.
- frontside bus**—The primary pathway (bus) between the CPU and the computer’s main memory. Also called “system bus.” See also *bus*.
- Function key**—(1) A feature in which certain keys in combination with the Fn key can set system options or control system parameters. (2) A key or combination of keys that activates a memory resident application.
- function keys**—The keys labeled F1 through F8, typically located on the keyboard. Their function is determined by the operating system and/or individual applications.

- G** **ground**—A conductor to which all components of an electric circuit are connected. It has a potential of zero (0) volts, is connected to the earth, and is the point of reference for voltages in the circuit.
- H** **hard disk**—A storage device composed of a rigid platter or platters that can be magnetically coded with data. Hard disks hold much more information than some external media and are used for long-term storage of applications and data. The primary (or only) hard disk in a computer is usually fixed, but some computers have secondary hard disks that are removable.
- hardware**—The physical components of a computer system. Compare *software*.
- HDMI (High-Definition Multimedia Interface)**—An interface used to transmit high quality audio and video signal via a single cable in digital format, providing better picture quality than analog signal.
- HDMI-CEC (HDMI Consumer Electronics Control)**—One A/V component can control another while using this function, if connected with HDMI cables. See also *HDMI*.
- Hibernation**—A feature of many Toshiba computers that saves to the internal storage drive the current state of your work, including all open files and applications, when you turn the computer off. When you turn on the computer again, your work is returned to the same state it was when the computer was turned off. See also *Sleep, Suspend*.
- hot swapping**—The ability to add or remove devices from a computer while the computer is running and have the operating system automatically recognize the change.
- I** **icon**—A small image displayed on the screen that represents a function, file, or application.
- interlaced**—A method of refreshing a computer screen, in which only every other line of pixels is refreshed. Interlaced monitors take two passes to create a complete screen image. Compare *non-interlaced*.
- internal device**—See *device*.

**Internet**—The decentralized, world-wide network of computers that provides electronic mail, the World Wide Web, and other services. See also *World Wide Web*.

**K** **keyboard shortcut**—A key or combination of keys that you use to perform a task instead of using a pointing device such as a mouse.

**L** **L1 (level one) cache**—Memory cache built into the processor to help improve processing speed. See also *cache, CPU cache, L2 cache*.

**L2 (level two) cache**—Memory cache installed on the motherboard to help improve processing speed. It is slower than L1 cache and faster than main memory. See also *cache, CPU cache, L1 cache*.

**LAN (Local Area Network)**—A group of computers or other devices dispersed over a relatively limited area and connected by a communications link that enables any device to interact with any other on the network.

**LED (Light Emitting Diode)**—A solid state lamp (SSL) that uses light-emitting diodes (LEDs) as the source of light, which offers long life and high efficiency output. Multiple diodes are used together, since the light created by individual light-emitting diodes is small compared to incandescent and compact fluorescent lamps.

**LCD (Liquid Crystal Display)**—A type of display that uses a liquid substance between two transparent electrode panels. When an electric current passes through the electrodes, the molecules in the liquid form a crystalline pattern that polarizes the light passing through it. A filter over the electrodes permits only non-polarized light to pass to the surface of the display, creating light and dark pixels.

**load**—To move information from a storage device (such as a hard disk) into memory for processing.

**local area network**—See *LAN*.

**logical drive**—A section of a disk that is recognized by the operating system as a separate disk drive. A system's logical drives may differ from its physical drives. For example, a single hard disk drive may be partitioned into two or more logical drives.

**M memory**—Typically refers to the computer's main memory, where applications are run and data is temporarily stored and processed. Memory can be volatile and hold data temporarily, such as RAM, or it can be nonvolatile and hold data permanently, such as ROM. A computer's main memory is RAM. See also *RAM*, *ROM*.

**microprocessor**—See *Central Processing Unit (CPU)*.

**MIDI (Musical Instrument Digital Interface)**—A standard for connecting musical instruments, synthesizers, and computers. The MIDI standard provides a way of translating music into a form computers can use, and vice versa.

**motherboard**—The computer's main circuit board that contains the processor, memory, and other primary components.

**MS-DOS prompt**—See *system prompt*.

**multi-function drive**—A DVD drive that can read and write to CD and DVD media.

**multimedia**—A combination of two or more media, such as sound, animation, and video in a computer application or presentation.

**Musical Instrument Digital Interface**—See *MIDI*.

**N network**—A collection of computers and associated devices that are connected by communications facilities. A network allows you to share data and peripheral devices, such as printers, with other users and to exchange electronic mail.

**non-interlaced**—A method of refreshing a computer screen, in which each pixel of every line is refreshed as the electron beam scans across and down the screen. Compare *interlaced*.



---

**non-system disk**—A disk for storing applications and data that cannot be used to start the computer. Compare *system disk*.

**O** **online**—Available through the computer. Online may refer to information being read from your own computer's internal storage drive, such as online documentation or online Help, or to information coming from another company on a company network or the Internet.

**operating system**—A set of applications that controls how the computer works. Examples of operating systems are the Windows Vista®, Windows® 7, and Windows 8 operating systems.

**optical disc drive**—A drive which reads plastic coated discs on which information is recorded digitally, and uses a laser to read data, music, or videos.

**P** **palette**—See *color palette*.

**password**—A unique string of characters entered by a user to verify his or her identity to the computer or the network.

**PC Card**—A credit-card-sized expansion card designed to increase the capabilities of computers. PC Cards provide functions such as modem, fax/modem, hard disk drive, network adapter, sound card, or SCSI adapter.

**peripheral**—Any device, such as a printer or joystick, that is attached to the computer and controlled by the computer's CPU.

**pixel**—Short for "picture element." The smallest dot that can be produced on a screen or printer.

**Plug and Play**—Generally, refers to the computer's ability to automatically configure itself to work with peripheral devices. When capitalized, refers to a standard that, when followed by a device manufacturer, allows a computer to configure itself automatically to work with the device.

**pointer**—An icon (usually an arrow) that moves on the screen when you slide your finger across the touch pad or move a mouse. Used to point to and select/activate on-screen items, such as icons, menu items, and buttons. The shape and purpose of the pointer varies depending on the application you are using and what you are doing.

**pointing device**—Any device, such as the touch pad or a mouse, that enables you to move the pointer on the screen.

**port**—A socket on the computer where you plug in a cable for connection to a network or a peripheral device.

**processor**—See *Central Processing Unit (CPU)*.

**program**—A set of instructions that can be executed by a computer. The general classes of applications (also called software) are operating system, application, and utility. See also *operating system, application, utility*.

**properties**—The attributes of an object or device. For example, the properties of a file include the file's type, size, and creation date.

**R** **RAM (Random Access Memory)**— *Volatile* memory that can be written to as well as read. *Volatile* here means that information in RAM is lost when you turn off your computer. This type of memory is used for your computer's main memory. See also *memory. Compare ROM*.

**Random Access Memory**—See *RAM*.

**Read-Only Memory**—See *ROM*.

**reboot**—See *boot, restart*.

**removable disk**—A disk that can be removed from a disk drive. A Flash drive is one example of a removable disk.

**resolution**—A measure of the sharpness of the images that can be produced by a printer or displayed on a screen. For a printer, resolution is expressed in dots per inch (dpi). For a screen, it is expressed as the number of pixels available horizontally and vertically.

**restart**—Synonymous with reboot. To reset the computer by reloading the operating system without turning the computer off. See also *boot*.

**RGB (Red, Green, Blue) monitor**—A monitor that reproduces all colors by mixing red, green, and blue light in various combinations.

**RJ45 connector**—An eight-wire connector used to connect a computer to a network.

**ROM (Read-Only Memory)**—Non-volatile memory that can be read but not written to. Non-volatile here means that information in ROM remains whether or not the computer is receiving power. This type of memory is used to store your computer's BIOS, which is essential instructions the computer reads when you start it up. See also *BIOS, memory. Compare RAM*.

## S

**Secure Digital (SD)**—A small, portable, non-volatile memory card used to store and transfer data between digital products, providing encryption capability for content security.

**select**—To highlight or otherwise specify text, data, or graphics with the intent to perform some operation on it.

**shortcut**—See *keyboard shortcut*.

**Sleep**—A feature of some Windows® operating systems that allows you to turn off the computer without exiting your open applications and to continue from where you left off when you turn the computer on again.

**software**—See *application. Compare hardware*.

**solid state drive**—A data storage device that utilizes solid-state memory as opposed to a hard disk (see also *hard disk*). Solid state drives hold a large amount of information and are used for storage of applications and data.

**Start screen**—Displays the new Windows® operating system look and feel.

**Suspend**—A feature of some Windows® operating systems that allows you to turn off the computer without exiting your open applications and to continue from where you left off when you turn the computer on again.

**Swipe**—Swipe an open window to the left or right of the screen to display the next or previous window.

**system prompt**—The symbol (in the MS-DOS® operating system, generally a drive letter followed by a “greater than” sign) indicating where users are to enter commands.

**T** **TFT display**—See *active-matrix display*.

**Tile/Tiles**—A list of square or rectangular icons on the Start screen representing applications that can be accessed by selecting them.

**U** **Universal Serial Bus (USB)**—USB is a serial bus that supports data transfer. USB allows hot swapping of peripherals. See also *bus, hot swapping, serial*.

**upload**—To send a file to another computer through a modem or network. See also *download*.

**USB**—See *Universal Serial Bus (USB)*.

**USB Flash drive**—A small, portable flash memory card that plugs into a computer’s USB port and functions as a portable hard drive. They are smaller and more durable than an external hard drive because they do not contain any internal moving parts, but have less storage capacity. See also *Universal Serial Bus (USB)*.

**utility**—A computer program designed to perform a narrowly focused operation or solve a specific problem. Utilities are often related to computer system management.

---

**W** **Web**—See *World Wide Web*.

**Wi-Fi®**—A registered trademark term of the Wi-Fi Alliance that stands for Wireless Fidelity, and is another term for the communication protocol to permit an Ethernet connection using wireless communication components.

**World Wide Web (www)**—The worldwide network of Web sites linked together over the Internet. A user of the Web can jump from site to site regardless of the location of the computer hosting the site. See also *Internet*.

# Index

---

## A

- AC adaptor 25
- AC power 61
- accessing
  - network 71
- adding
  - optional external devices 31
- adequate ventilation
  - cooling fan 24
- app, starting 53
- App, starting from Start screen 53
- apps
  - starting from Start screen 53
- audio features 71

## B

- backing up files 48, 54
- battery
  - charging the real-time clock (RTC) 62
- BIOS Setup
  - see System Settings
- button
  - eject, optical disc drive 56
  - power 28

## C

- caring for your computer 45
- cleaning the computer 45
- communications
  - set up 70
- computer
  - caring for 45
  - cleaning 45
  - environmental precautions 22
  - moving 45
  - setting up 25
  - shut down 29
- computer lock 46
- computer will not start
  - troubleshooting 96
- computing habits
  - troubleshooting 112
- computing tips 47
- connecting
  - computer to a network 70
  - power cord/cable 27
    - connecting 25
  - power source 26
- cooling fan

adequate ventilation 24  
 customize  
   computer settings 44

**D**

data/entire system backup  
   troubleshooting 115  
 desktop  
   creating new icon 68  
   exploring the 67  
   icons 68  
   recycle bin 68  
   standard features 67  
 Desktop Assist 77  
   Media & Entertainment tab 78  
   Support & Recovery tab 80  
   Tools & Utilities tab 79  
 Device Manager  
   fixing a problem 101  
 display devices  
   external 43  
 disposal information 11  
 DVD  
   removing with computer off 60  
   removing with computer on 59  
 DVD player  
   troubleshooting 111  
 DVDs  
   using 55

**E**

eco power plan 64  
 eco Utility® 81  
 eject button  
   optical disc drive 56  
 eject, optical disc drive 56  
 exploring  
   desktop 67  
   Start screen 65

**F**

files  
   backing up 48, 54  
   saving 54

## Function keys

  disabling or enabling wireless  
   devices 123  
   display brightness 121  
   Help file 121  
   keyboard Function keys 123  
   volume mute 123  
   Zoom (Display resolution) 123  
   zooming in 123  
   zooming out 123

function keys 51

## Functions keys

  Internet/media control buttons  
   122

**H**

## HDMI™ In port

  using 43

## HDMI™ Out port

  connecting display device 44  
   connecting HDMI™-  
   compatible TV 44  
   selecting video cables 44  
   using 43

## headphones

  using 72

**I**

## icon

  desktop 68  
   moving to desktop 68  
   recycle bin 68  
   safety 20  
   Shut down 30, 31, 102

## Initial setup

  using your computer for the  
   first time 28

## internal storage drive

  recovery 32

**K**

## keyboard

  function keys 51  
   special Windows® keys 52

- troubleshooting 103
- keys
  - function keys 51
- L**
- LEDs
  - system indicator lights
    - ON/OFF light 28
    - Web Camera light 72
- Licenses 10
- lock
  - computer, using 46
- M**
- manual eject hole
  - optical disc drive 56
- Memory card reader
  - inserting memory media 73
  - removing memory media 74
  - using 73
- microphone
  - using 71
- moving the computer 45
- N**
- network
  - accessing 71
  - connecting your computer 70
- networking
  - wireless 70
- Notification area 69
- notifications 69
- O**
- online resources
  - Toshiba 60
- optical disc
  - Auto-Run feature 58
  - handling 57
  - inserting 56
  - playing optical media 58
  - positioning 57
  - recording optical media 58
  - removing with computer off 60
  - removing with computer on 59
- optical disc drive
  - components 56
  - drive in-use indicator light 56
  - eject button 56
  - handling an optical disc 57
  - inserting an optical disc 56
  - manual eject hole 56
  - playing optical media 58
  - problems 106
  - recording optical media 58
  - removing a disc 59, 60
  - troubleshooting 106
  - using 55, 56
- optical discs
  - troubleshooting 107
- optical media
  - recording 58
- optional external devices
  - adding 31
- other documentation 21
- P**
- password
  - deleting a supervisor 84
  - deleting a user 85
  - instant password 82
  - power-on password 82
  - setting 82
  - setting a supervisor 82
  - setting a user 84
  - supervisor password 82
  - user password 82
- power
  - connecting cable to AC
    - adaptor 26
  - cord/cable 27
  - cord/cable connectors 124
  - energy-saving features 61
  - turning on 28
- power button 28
- power management 61
  - optimum performance 61



- power plans
  - selecting power plan options 63
- precautions
  - safety 23
- printer
  - troubleshooting 108
- problem solving
  - contacting Toshiba 118
  - Startup options 97

**R**

- recording sounds 71
- recovery
  - creating recovery media 33
  - installing drivers and applications 41
  - internal storage drive 32
  - refresh your PC 37
  - reset your PC 39
  - restoring from recovery media 35
- Recovery Media Creator 93
- recycle bin icon 68
- refresh your PC
  - with user's data 37
- registering computer 29
- removing
  - an optical disc with computer on 59
  - and optical disc with computer off 60
- restart computer 30
- restore points
  - troubleshooting 113

**S**

- safety
  - icons 20
  - precautions 23
- saving files 54
- selecting
  - power plan options 63

- Service Station 93
  - setting up
    - communications 70
    - computer 25
    - software
      - Setup Wizard 28
    - work environment 22
  - settings
    - customize computer settings 44
  - Shut down
    - computer 30, 31, 102
    - icon 30, 31, 102
  - shut down
    - computer 29
  - Sleep mode 31
  - Sleep Utilities 88
  - software
    - Setup Wizard 28
  - sounds
    - recording 71
  - speakers
    - using external 72
  - Start screen
    - exploring the 65
  - starting an app 53
  - starting an app from Start screen 53
  - Startup menu
    - problem solving 97
  - supervisor password, deleting 84
  - supervisor password, set up 82
  - system indicator lights
    - drive in-use indicator 56
    - LEDs 28, 72
  - System Settings 86
- T**
- taskbar 68
  - Tiles
    - Start screen 67
  - tips
    - for computing 47
  - Toshiba

- online resources 60
  - registering computer
    - Toshiba Web site 29
  - worldwide offices 119
  - TOSHIBA Application Installer 94
  - TOSHIBA Function Key 92
  - TOSHIBA Function Keys
    - functions 120
  - touch screen navigation 52
  - troubleshooting 103
    - bookmarked site not found 100
    - checking device properties 101
    - computer will not start 96
    - corrupted/damaged data files 106
    - data/entire system backup 115
    - Device Manager 101
    - display problems
      - screen is blank 103
    - DVD player 111
    - eject button 107
    - error message, warning
      - resume failure 97
    - Error-checking 104
    - external keyboard 103
    - good computing habits 112
    - hard disk drive is slow 106
    - high-pitched noise 108
    - installing hardware/software 116
    - keyboard 103
    - memory problems 102
    - missing files/trouble accessing
      - a drive 104
    - on-screen eject button 107
    - optical disc drive 106
    - power and battery 103
    - printer 108
    - restore points 113
    - screen does not look correct/
      - flickers 104
    - slow Internet connection 100
    - sound system 108
    - trouble running discs 107
    - trouble running programs 106
    - URL address not found 100
    - USB Sleep and Charge
      - cannot use 117
    - Windows® operating system
      - not working 97
    - wireless networking 109
  - turning on
    - power 28
- U**
- USB Sleep and Charge
    - cannot use 117
  - user password, deleting 85
  - user password, setting 84
  - using
    - a microphone 71
    - computer lock 46
    - DVDs 55
    - eco power plan 64
    - Memory card reader 73
    - optical disc drive 55
    - Web Camera 72
  - using the wireless mouse 48
  - Utilities 76
- W**
- warranty
    - standard limited warranty 21
  - Web Camera
    - using 72
  - Web sites 118
  - Wi-Fi®
    - wireless networking 70
  - Windows® charms
    - Devices 66
    - Search 66
    - Settings 66
    - Share 66
    - Start 66
  - Windows® key 52

- Windows® operating system
  - desktop 67, 74
  - troubleshooting 97
- wireless keyboard
  - battery 50
  - functions 51
  - using 50
- wireless mouse
  - battery 49
  - using 48
- wireless networking 70
  - troubleshooting 109

## Free Manuals Download Website

<http://myh66.com>

<http://usermanuals.us>

<http://www.somanuals.com>

<http://www.4manuals.cc>

<http://www.manual-lib.com>

<http://www.404manual.com>

<http://www.luxmanual.com>

<http://aubethermostatmanual.com>

Golf course search by state

<http://golfingnear.com>

Email search by domain

<http://emailbydomain.com>

Auto manuals search

<http://auto.somanuals.com>

TV manuals search

<http://tv.somanuals.com>