

TOSHIBA
Satellite A20 Series
Portable Personal Computer
User's Manual

Copyright

© 2003 by TOSHIBA Corporation. All rights reserved. Under the copyright laws, this manual cannot be reproduced in any form without the prior written permission of TOSHIBA. No patent liability is assumed, with respect to the use of the information contained herein.

TOSHIBA Satellite A20 Series Portable Personal Computer User's Manual

First edition May 2003

Copyright authority for music, movies, computer programs, data bases and other intellectual property covered by copyright laws belongs to the author or to the copyright owner. Copyrighted material can be reproduced only for personal use or use within the home. Any other use beyond that stipulated above (including conversion to digital format, alteration, transfer of copied material and distribution on a network) without the permission of the copyright owner is a violation of copyright or author's rights and is subject to civil damages or criminal action. Please comply with copyright laws in making any reproduction from this manual.

Disclaimer

This manual has been validated and reviewed for accuracy. The instructions and descriptions it contains are accurate for the TOSHIBA Satellite A20 Series Portable Personal Computer at the time of this manual's production. However, succeeding computers and manuals are subject to change without notice. TOSHIBA assumes no liability for damages incurred directly or indirectly from errors, omissions or discrepancies between the computer and the manual.

Trademarks

IBM is a registered trademark and IBM PC is a trademark of International Business Machines Corporation.

Intel and Pentium are trademarks or registered trademarks of Intel Corporation or its subsidiaries in the United States and other countries/regions.

Windows and Microsoft are registered trademarks of Microsoft Corporation.

Photo CD is a trademark of Eastman Kodak.

Other trademarks and registered trademarks not listed above may be used in this manual.

FCC information

Product Name : *Satellite A20*

Model number : *PSA20*

FCC notice "Declaration of Conformity Information"

This equipment has been tested and found to comply with the limits for a Class B digital device, pursuant to part 15 of the FCC rules. These limits are designed to provide reasonable protection against harmful interference in a residential installation. This equipment generates, uses and can radiate radio frequency energy and, if not installed and used in accordance with the instructions, may cause harmful interference to radio communications. However, there is no guarantee that interference will not occur in a particular installation. If this equipment does cause harmful interference to radio or television reception, which can be determined by turning the equipment off and on, the user is encouraged to try to correct the interference by one or more of the following measures:

- ❖ Reorient or relocate the receiving antenna.
- ❖ Increase the separation between the equipment and receiver.
- ❖ Connect the equipment into an outlet on a circuit different from that to which the receiver is connected.
- ❖ Consult the dealer or an experienced radio/TV technician for help.

WARNING: Only peripherals complying with the FCC class B limits may be attached to this equipment. Operation with non-compliant peripherals or peripherals not recommended by TOSHIBA is likely to result in interference to radio and TV reception. Shielded cables must be used between the external devices and the computer's external monitor port, USB port, parallel port and microphone jack. Changes or modifications made to this equipment, not expressly approved by TOSHIBA or parties authorized by TOSHIBA could void the user's authority to operate the equipment.

FCC conditions

This device complies with part 15 of the FCC Rules. Operation is subject to the following two conditions:

1. This device may not cause harmful interference.
2. This device must accept any interference received, including interference that may cause undesired operation.

Contact

Address: TOSHIBA America Information Systems, Inc.
9740 Irvine Boulevard
Irvine, California 92618-1697

Telephone: (949)583-3000

EU Declaration of Conformity information

TOSHIBA declares, that the product: PSA20* conforms to the following Standards:

Supplementary Information: “The product complies with the requirements of the Low Voltage Directive 73/23/EEC, the EMC Directive 89/336/EEC and/or the R&TTE Directive 1999/05/EEC.”

This product is carrying the CE-Mark in accordance with the related European Directives. Responsible for CE-Marking is TOSHIBA Europe, Hammfelddamm 8, 41460 Neuss, Germany.

VCCI Class B Information

この装置は、情報処理装置等電波障害自主規制協議会（VCCI）の基準に基づくクラスB情報技術装置です。この装置は、家庭環境で使用することを目的としていますが、この装置がラジオやテレビジョン受信機に近接して使用されると、受信障害を引き起こすことがあります。

取扱説明書に従って正しい取り扱いをして下さい。

Modem warning notice

Conformity Statement

The equipment has been approved to [Commission Decision “CTR21”] for pan-European single terminal connection to the Public Switched Telephone Network (PSTN).

However, due to differences between the individual PSTNs provided in different countries/regions the approval does not, of itself, give an unconditional assurance of successful operation on every PSTN network termination point.

In the event of problems, you should contact your equipment supplier in the first instance.

Network Compatibility Statement

This product is designed to work with, and is compatible with the following networks. It has been tested to and found to conform with the additional requirements conditional in EG 201 121.

Germany	ATAAB AN005, AN006, AN007, AN009, AN010 and DE03, 04, 05, 08, 09, 12, 14, 17
Greece	ATAAB AN005, AN006a, d GR01, 02, 03, 04
Portugal	ATAAB AN001, 005, 006, 007, 011 and P03, 04, 08, 10
Spain	ATAAB AN005, 007, 012 and ES01
Switzerland	ATAAB AN002
All other countries/regions	ATAAB AN003, 004

Specific switch settings or software setup are required for each network, please refer to the relevant sections of the user guide for more details.

The hookflash (timed break register recall) function is subject to separate national type approvals. It has not been tested for conformity to national type regulations, and no guarantee of successful operation of that specific function on specific national networks can be given.

Japan regulations

Region selection

If you are using the computer in Japan, technical regulations described in the Telecommunications Business Law require that you select the Japan region mode. It is illegal to use the modem in Japan with any other selection.

Redial

Up to two redial attempts can be made. If more than two redial attempts are made, the modem will return **Black Listed**. If you are experiencing problems with the Black Listed code, set the interval between redials at one minute or longer.

Japan's Telecommunications Business Law permits up to two redials on analogue telephones, but the redials must be made within a total of three minutes.

The internal modem is approved by Japan Approvals Institute for Telecommunications Equipment.



A02-0604JP

Pursuant to FCC CFR 47, Part 68:

When you are ready to install or use the modem, call your local telephone company and give them the following information:

- ◆ The telephone number of the line to which you will connect the modem
- ◆ The registration number that is located on the device

The FCC registration number of the modem will be found on either the device which is to be installed, or, if already installed, on the bottom of the computer outside of the main system label.

- ◆ The Ringer Equivalence Number (REN) of the modem, which can vary. For the REN of your modem, refer to your modem's label.

The modem connects to the telephone line by means of a standard jack called the USOC RJ11C.

Type of service

Your modem is designed to be used on standard-device telephone lines. Connection to telephone company-provided coin service (central office implemented systems) is prohibited. Connection to party lines service is subject to state tariffs. If you have any questions about your telephone line, such as how many pieces of equipment you can connect to it, the telephone company will provide this information upon request.

Telephone company procedures

The goal of the telephone company is to provide you with the best service it can. In order to do this, it may occasionally be necessary for them to make changes in their equipment, operations, or procedures. If these changes might affect your service or the operation of your equipment, the telephone company will give you notice in writing to allow you to make any changes necessary to maintain uninterrupted service.

If problems arise

If any of your telephone equipment is not operating properly, you should immediately remove it from your telephone line, as it may cause harm to the telephone network. If the telephone company notes a problem, they may temporarily discontinue service. When practical, they will notify you in advance of this disconnection. If advance notice is not feasible, you will be notified as soon as possible. When you are notified, you will be given the opportunity to correct the problem and informed of your right to file a complaint with the FCC. In the event repairs are ever needed on your modem, they should be performed by TOSHIBA Corporation or an authorized representative of TOSHIBA Corporation.

Disconnection

If you should ever decide to permanently disconnect your modem from its present line, please call the telephone company and let them know of this change.

Fax branding

The Telephone Consumer Protection Act of 1991 makes it unlawful for any person to use a computer or other electronic device to send any message via a telephone fax machine unless such message clearly contains in a margin at the top or bottom of each transmitted page or on the first page of the transmission, the date and time it is sent and an identification of the business, other entity or individual sending the message and the telephone number of the sending machine or such business, other entity or individual. In order to program this information into your fax modem, you should complete the setup of your fax software before sending messages.

Instructions for IC CS-03 certified equipment

- 1 The Industry Canada label identifies certified equipment. This certification means that the equipment meets certain telecommunications network protective, operational and safety requirements as prescribed in the appropriate Terminal Equipment Technical Requirements document(s). The Department does not guarantee the equipment will operate to the user's satisfaction.

Before installing this equipment, users should ensure that it is permissible to be connected to the facilities of the local telecommunications company. The equipment must also be installed using an acceptable method of connection.

The customer should be aware that compliance with the above conditions may not prevent degradation of service in some situations. Repairs to certified equipment should be coordinated by a representative designated by the supplier. Any repairs or alterations made by the user to this equipment, or equipment malfunctions, may give the telecommunications company cause to request the user to disconnect the equipment.

Users should ensure for their own protection that the electrical ground connections of the power utility, telephone lines and internal metallic water pipe system, if present, are connected together. This precaution may be particularly important in rural areas.

***CAUTION:** Users should not attempt to make such connections themselves, but should contact the appropriate electric inspection authority, or electrician, as appropriate.*

- 2 The user manual of analog equipment must contain the equipment's Ringer Equivalence Number (REN) and an explanation notice similar to the following:
The Ringer Equivalence Number (REN) of the modem, which can vary. For the REN of your modem, refer to your modem's label.

***NOTICE:** The Ringer Equivalence Number (REN) assigned to each terminal device provides an indication of the maximum number of terminals allowed to be connected to a telephone interface. The termination on an interface may consist of any combination of devices subject only to the requirement that the sum of the Ringer Equivalence Numbers of all the devices does not exceed 5.*

3 The standard connecting arrangement (telephone jack type) for this equipment is jacktype(s):USOC RJ11C.

The IC registration number of the modem is shown below.

Canada: 1353A-L4AINT

Notes for Users in Australia and New Zealand

Modem warning notice for Australia

Modems connected to the Australian telecoms network must have a valid Austel permit. This modem has been designed to specifically configure to ensure compliance with Austel standards when the country/region selection is set to Australia. The use of other country/region setting while the modem is attached to the Australian PSTN would result in you modem being operated in a non-compliant manner. To verify that the country/region is correctly set, enter the command ATI which displays the currently active setting.

To set the country/region permanently to Australia, enter the following command sequence:

```
AT%TE=1
ATS133=1
AT&F
AT&W
AT%TE=0
ATZ
```

Failure to set the modem to the Australia country/region setting as shown above will result in the modem being operated in a non-compliant manner. Consequently, there would be no permit in force for this equipment and the Telecoms Act 1991 prescribes a penalty of \$12,000 for the connection of non-permitted equipment.

Notes for use of this device in New Zealand

- ❖ The grant of a Telepermit for a device in no way indicates Telecom acceptance of responsibility for the correct operation of that device under all operating conditions. In particular the higher speeds at which this modem is capable of operating depend on a specific network implementation which is only one of many ways of delivering high quality voice telephony to customers. Failure to operate should not be reported as a fault to Telecom.
- ❖ In addition to satisfactory line conditions a modem can only work properly if:
 - a/ it is compatible with the modem at the other end of the call and
 - b/ the application using the modem is compatible with the application at the other end of the call - e.g., accessing the Internet requires suitable software in addition to a modem.
- ❖ This equipment shall not be used in any manner which could constitute a nuisance to other Telecom customers.
- ❖ Some parameters required for compliance with Telecom's PTC Specifications are dependent on the equipment (PC) associated with this modem. The associated equipment shall be set to operate within the following limits for compliance with Telecom Specifications:
 - a/ There shall be no more than 10 call attempts to the same number within any 30 minute period for any single manual call initiation, and
 - b/ The equipment shall go on-hook for a period of not less than 30 seconds between the end of one attempt and the beginning of the next.
 - c/ Automatic calls to different numbers shall be not less than 5 seconds apart.
- ❖ Immediately disconnect this equipment should it become physically damaged, and arrange for its disposal or repair.
- ❖ The correct settings for use with this modem in New Zealand are as follows:
 - ATB0(CCITT operation)
 - AT&G2(1800Hz guard tone)
 - AT&P1 (Decadic dialing make-break ratio=33%/67%)
 - ATS0=0 (not auto answer)
 - ATS6=4 (Blind dial delay)
 - ATS7=less than 90 (Time to wait to carrier after dialing)
 - ATS10=less than 150 (loss of carrier to hangup delay, factory default of 15 recommended)

ATS11=90 (DTMF dialing on/off duration=90 ms)

ATX2 (Dial tone detect, but not (U.S.A.) call progress detect)

- ❖ When used in the Auto Answer mode, the S0 register must be set with a value of 3 or 4. This ensures:
 - (a) a person calling your modem will hear a short burst of ringing before the modem answers. This confirms that the call has been successfully switched through the network.
 - (b) caller identification information (which occurs between the first and second ring cadences) is not destroyed.
- ❖ The preferred method of dialing is to use DTMF tones (ATDT...) as this is faster and more reliable than pulse (decadic) dialing. If for some reason you must use decadic dialing, your communications program must be set up to record numbers using the following translation table as this modem does not implement the New Zealand “Reverse Dialing” standard.

Number to be dialed: 0 1 2 3 4 5 6 7 8 9

Number to program into computer: 0 9 8 7 6 5 4 3 2 1

Note that where DTMF dialing is used, the numbers should be entered normally.

- ❖ The transmit level from this device is set at a fixed level and because of this there may be circumstances where the performance is less than optimal. Before reporting such occurrences as faults, please check the line with a standard Telepermitted telephone, and only report a fault if the phone performance is impaired.
- ❖ It is recommended that this equipment be disconnected from the Telecom line during electrical storms.
- ❖ When relocating the equipment, always disconnect the Telecom line connection before the power connection, and reconnect the power first.
- ❖ This equipment may not be compatible with Telecom Distinctive Alert cadences and services such as FaxAbility.

***NOTE:** Fault callouts caused by any of the above causes may incur a charge from Telecom.*

General conditions

As required by PTC 100, please ensure that this office is advised of any changes to the specifications of these products which might affect compliance with the relevant PTC Specifications.

The grant of this Telepermit is specific to the above products with the marketing description as stated on the Telepermit label artwork. The Telepermit may not be assigned to other parties or other products without Telecom approval.

A Telepermit artwork for each device is included from which you may prepare any number of Telepermit labels subject to the general instructions on format, size and colour on the attached sheet.

The Telepermit label must be displayed on the product at all times as proof to purchasers and service personnel that the product is able to be legitimately connected to the Telecom network.

The Telepermit label may also be shown on the packaging of the product and in the sales literature, as required in PTC 100.

The charge for a Telepermit assessment is \$337.50. An additional charge of \$337.50 is payable where an assessment is based on reports against non-Telecom New Zealand Specifications. \$112.50 is charged for each variation when submitted at the same time as the original.

An invoice for \$NZ1237.50 will be sent under separate cover.

Optical disc drive safety instructions

NOTE: Be sure to check the international precautions at the end of this section.

CD-RW/DVD-ROM drives

TEAC DW-224E

- CAUTIONS:**
1. The CD-RW/DVD-ROM drive employs a laser system. To ensure proper use of this product, please read this instruction manual carefully and retain for future reference. Should the unit ever require maintenance, contact an authorized service location.
 2. Use of controls, adjustments or the performance of procedures other than those specified may result in hazardous radiation exposure.
 3. To prevent direct exposure to the laser beam, do not try to open the enclosure.

Location of the required label

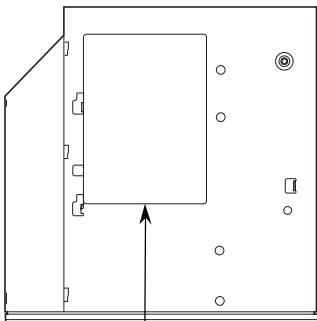

THIS PRODUCT COMPLIES WITH
DHHS RULES 21 CFR CHAPTER 1,
SUBCHAPTER J APPLICABLE AT
DATE OF MANUFACTURE.

MANUFACTURED:

Manufactured by
TEAC Corporation
3-7-3 Naka-cho, Musashino-shi,
Tokyo, Japan

Panasonic UJDA740/750

- CAUTIONS:**
- 1. The CD-RW/DVD-ROM drive employs a laser system. To ensure proper use of this product, please read this instruction manual carefully and retain for future reference. Should the unit ever require maintenance, contact an authorized service location.*
 - 2. Use of controls, adjustments or the performance of procedures other than those specified may result in hazardous radiation exposure.*
 - 3. To prevent direct exposure to the laser beam, do not try to open the enclosure.*

Location of the required label

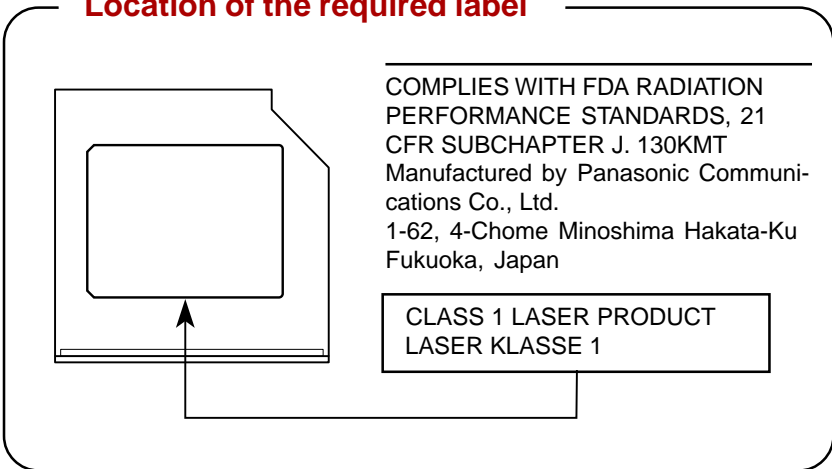

TOSHIBA SD-R2412

- CAUTIONS:**
1. *The CD-RW/DVD-ROM drive employs a laser system. To ensure proper use of this product, please read this instruction manual carefully and retain for future reference. Should the unit ever require maintenance, contact an authorized service location.*
 2. *Use of controls, adjustments or the performance of procedures other than those specified may result in hazardous radiation exposure.*
 3. *To prevent direct exposure to the laser beam, do not try to open the enclosure.*

Location of the required label

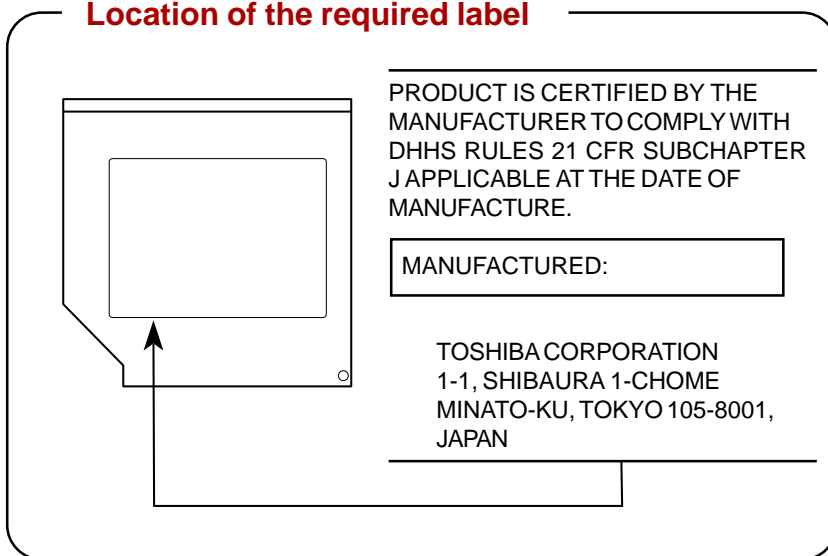

DVD-R/-RW drives

TOSHIBA SD-R6012/611

- CAUTIONS:**
1. *The DVD-R/-RW drive employs a laser system. To ensure proper use of this product, please read this instruction manual carefully and retain for future reference. Should the unit ever require maintenance, contact an authorized service location.*
 2. *Use of controls, adjustments or the performance of procedures other than those specified may result in hazardous radiation exposure.*
 3. *To prevent direct exposure to the laser beam, do not try to open the enclosure.*

Location of the required label

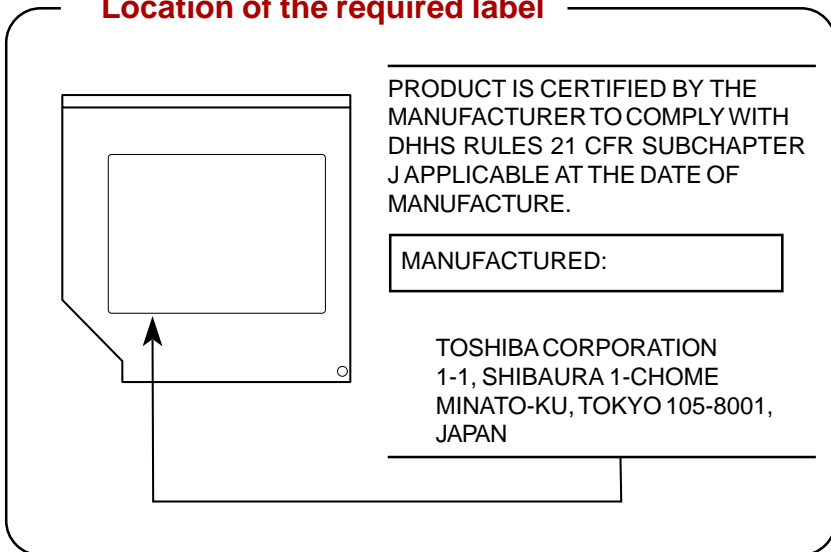

DVD Multi drives

Panasonic UJ-810/811

- CAUTIONS:**
- 1. The DVD Multi drive employs a laser system. To ensure proper use of this product, please read this instruction manual carefully and retain for future reference. Should the unit ever require maintenance, contact an authorized service location.*
 - 2. Use of controls, adjustments or the performance of procedures other than those specified may result in hazardous radiation exposure.*
 - 3. To prevent direct exposure to the laser beam, do not try to open the enclosure.*

Location of the required label

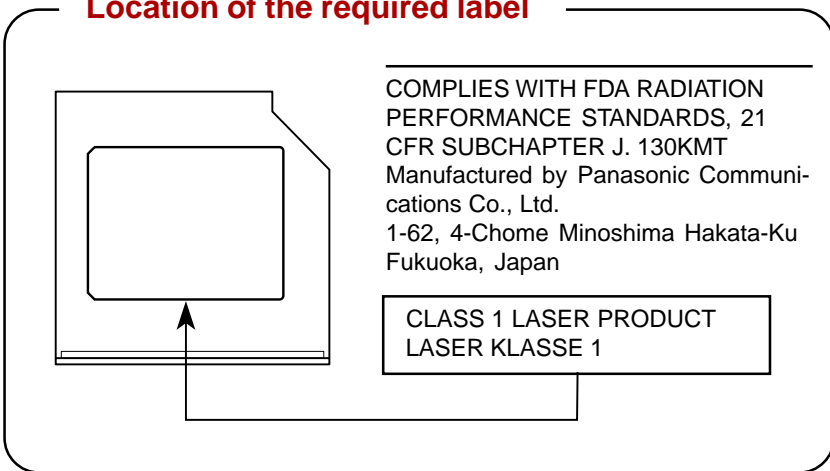

TEAC DV-W22E

This product has been designed and manufactured according to FDA regulations “title 21. CFR. chapter 1, subchapter J. based on the radiation Control for Health and Safety Act of 1968,” and is classified as a class 1 laser product. There is no hazardous invisible laser radiation during operation because invisible laser radiation emitted inside of this product is completely confined in the protective housings.

The label required in this regulation is shown below.

CAUTION

Use of controls or adjustments or performance of procedures other than those specified herein may result in hazardous radiation exposure.

Optical pickup

Type	: PSH202
Manufacturer	: TEAC
Laser output	: Less than 1.5mW (Play) and 53.3mW (Record) on the objective lens
Wavelength	: 779-789nm(CD) 652~660nm(DVD)

Location of the required label

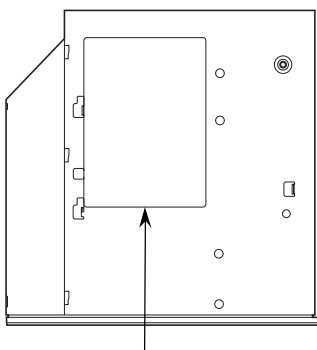

THIS PRODUCT COMPLIES WITH
DHHS RULES 21 CFR CHAPTER 1,
SUBCHAPTER J APPLICABLE AT
DATE OF MANUFACTURE.

MANUFACTURED:

Manufactured by
TEAC Corporation
3-7-3 Naka-cho, Musashino-shi,
Tokyo, Japan

International precautions

CLASS 1 LASER PRODUCT
APPAREIL À LASER DE
CLASSE 1
LASER KLASSE 1 PRODUKT
TO EN 60825-1
クラス 1 レーザー製品

CAUTION: This appliance contains a laser system and is classified as a “CLASS 1 LASER PRODUCT.” To use this model properly, read the instruction manual carefully and keep this manual for your future reference. In case of any trouble with this model, please contact your nearest “AUTHORIZED service station.” To prevent direct exposure to the laser beam, do not try to open the enclosure

CLASS 1 LASER PRODUCT
LASERSCHUTZKLASSE 1
PRODUKT
TO EN 60825

VORSICHT: Dieses Gerät enthält ein Laser-System und ist als “LASERSCHUTZKLASSE 1 PRODUKT” klassifiziert. Für den richtigen Gebrauch dieses Modells lesen Sie bitte die Bedienungsanleitung sorgfältig durch und bewahren diese bitte als Referenz auf. Falls Probleme mit diesem Modell auftreten, benachrichtigen Sie bitte die nächste “autorisierte Service-Vertretung”. Um einen direkten Kontakt mit dem Laserstrahl zu vermeiden darf das Gerät nicht geöffnet werden.

ADVERSEL: USYNLIG
LASERSTRÅLING VED ÅBNING,
NÅR SIKKERHEDSAF-BRYDER
ER UDE AF FUNKTION.
UNDGÅ UDSÆTTELSE FOR
STRÅLING

ADVARSEL: Denne mærkning er anbragt udvendigt på apparatet og indikerer, at apparatet arbejder med laserstråler af klasse 1, hvilket betyder, at der anvendes laserstråler af svageste klasse, og at man ikke på apparatets yderside kan blive udsat for utilladelig kraftig stråling.

**APPARATET BOR KUN ÅBNES AF FAGFOLK
MED SÆRLIGT KENDSKAB TIL APPARATER
MED LASERSTRÅLER!**

Indvendigt i apparatet er anbragt den her gengivne advarselsmærkning, som advarer imod at foretage sådanne indgreb i apparatet, at man kan komme til at udsætte sig for laserstråling.

OBS! Apparaten innehåller laserkomponent som avger laserstråining överstigande gränsen för laserklass 1.

VAROITUS. Suojakoteloä si saa avata. Laite sisältää laserdiodin, joka lähetää näkymätöntä silmilie vaarallista lasersäteilyä.

CAUTION: USE OF CONTROLS OR ADJUSTMENTS OR PERFORMANCE OF PROCEDURES OTHER THAN THOSE SPECIFIED IN THE OWNER'S MANUAL MAY RESULT IN HAZARDOUS RADIATION EXPOSURE.

VORSICHT: DIE VERWENDUNG VON ANDEREN STEUERUNGEN ODER EINSTELLUNGEN ODER DAS DURCHFÜHREN VON ANDEREN VORGÄNGEN ALS IN DER BEDIENUNGSANLEITUNG BESCHRIEBEN KÖNNEN GEFÄHRLICHE STRAHLENEXPOSITIONEN ZUR FOLGE HABEN.

Table of Contents

Preface

Manual contents	xxviii
Conventions	xxix
Abbreviations	xxix
Icons	xxix
Keys	xxix
Key operation	xxx
Display	xxx
Messages	xxx

General Precautions

Stress injury	xxxi
Heat injury	xxxi
Pressure or impact damage	xxxi
PC card overheating	xxxii
Mobile phone	xxxii
Central Processing Unit (CPU) Performance Disclaimer	xxxii

Chapter 1 Introduction

Equipment checklist	1-1
Hardware	1-1
Software	1-1
Documentation	1-2
Features	1-2
Special features	1-7
Utilities	1-9
Options	1-10

Chapter 2 The Grand Tour

Front with the display closed	2-1
Left side	2-2
Right side	2-3

Back side	2-4
Underside	2-6
Front with the display open	2-7
System indicators	2-8
Keyboard indicators	2-10
USB diskette drive	2-11
Optical media drives	2-12
Region codes for DVD drives and media	2-12
Writable discs	2-12
Formats	2-13
CD-RW/DVD-ROM drive	2-13
DVD-R/-RW drive	2-14
DVD Multi drive	2-14
Universal AC adaptor	2-15

Chapter 3 Getting Started

Setting up your work space	3-1
General conditions	3-2
Placement of the computer	3-2
Seating and posture	3-3
Lighting	3-4
Work habits	3-4
Connecting the universal AC adaptor	3-5
Opening the display	3-6
Turning on the power	3-6
Starting up for the first time	3-7
Turning off the power	3-7
Shut Down mode (Boot mode)	3-7
Hibernation mode	3-8
Standby mode	3-10
Restarting the computer	3-12
Restoring the preinstalled software from the Product	
Recovery CD-ROM	3-12

Chapter 4 Operating Basics

Touch Pad	4-1
Using the USB diskette drive	4-2
Connecting 3 1/2" diskette drive	4-2
Disconnecting 3 1/2" diskette drive	4-3

Using optical media drives	4-3
Loading discs	4-4
Removing discs	4-7
Audio/Video controls	4-8
Mode control button	4-8
Controls for CD/DVD and Digital Audio	4-8
Next and Previous buttons	4-9
Play/Pause and Stop buttons	4-10
Writing CDs on CD-RW/DVD-ROM drive	4-10
Before writing or rewriting	4-10
When writing or rewriting	4-11
Writing CDs on DVD-R/-RW drive	4-12
Important message	4-12
Disclaimer	4-12
Writing CDs on DVD Multi drive	4-13
Important message	4-13
Disclaimer	4-13
Read/write function chart	4-14
Before writing or rewriting	4-16
When writing or rewriting	4-17
Drag'n Drop CD+DVD	4-17
Data Verification	4-18
Video (DVD-R/-RW/-RAM)	4-18
Media care	4-20
CD/DVDs	4-20
Diskettes	4-20
Modem	4-21
Region selection	4-21
Properties menu	4-22
Connecting	4-23
Disconnecting	4-24
Wireless LAN	4-24
Supported features	4-24
Security	4-25
Wireless communication switch	4-25
Wireless communication indicator	4-25
LAN	4-26
Connecting LAN cable	4-26
Disconnecting LAN cable	4-27
Cleaning the computer	4-28
Moving the computer	4-28
Heat dispersal	4-29

Chapter 5 The Keyboard

Typewriter keys	5-1
F1 ... F12 function keys	5-2
Soft keys: Fn key combinations	5-2
Emulating keys on enhanced keyboard	5-2
Hot keys	5-4
Fn Sticky key	5-6
Windows special keys	5-7
Keypad overlay	5-7
Turning on the overlays	5-7
Temporarily using normal keyboard (overlay on)	5-8
Temporarily using overlay (overlay off)	5-9
Temporarily changing modes	5-9
Generating ASCII characters	5-9

Chapter 6 Power

Power conditions	6-1
Power indicators	6-2
Battery indicator	6-2
DC IN indicator	6-3
Power indicator	6-3
Battery types	6-3
Battery pack	6-3
Real Time Clock battery	6-4
Care and use of the battery pack	6-5
Safety precautions	6-5
Charging the batteries	6-8
Monitoring battery capacity	6-9
Maximizing battery operating time	6-10
Retaining data with power off	6-11
Extending battery life	6-11
Replacing the battery pack	6-12
Removing the battery pack	6-12
Installing the battery pack	6-13
Starting the computer by password	6-15

Power-up modes	6-15
Windows utilities	6-15
Hot keys	6-15
Panel power on/off	6-16
System Auto Off	6-16

Chapter 7 HW Setup and Passwords

Accessing HW Setup	7-1
HW Setup window	7-1
General	7-1
Password	7-2
Device Config	7-5
Parallel/Printer	7-5
Display	7-5
Boot Priority	7-6
Keyboard	7-8
USB	7-8
LAN	7-9
Supervisor password	7-9

Chapter 8 Optional Devices

PC cards	8-2
Inserting a PC card	8-2
Removing a PC card	8-3
SD cards	8-4
Inserting an SD card	8-4
Removing an SD card	8-5
SD card care	8-5
Memory expansion	8-6
Installing memory module	8-7
Removing memory module	8-11
Battery pack (Black)	8-13
Universal AC adaptor	8-13
USB FDD kit	8-13
External monitor	8-13
TV	8-14
Connecting a TV	8-14
Changing the resolution	8-14
Parallel printer	8-16
Security lock	8-17

Chapter 9 Troubleshooting

Problem solving process	9-1
Preliminary checklist	9-1
Analyzing the problem	9-2
Hardware and system checklist	9-3
System start-up	9-3
Self test	9-4
Power	9-4
Password	9-7
Keyboard	9-8
LCD panel	9-8
Hard disk drive	9-9
CD-RW/DVD-ROM drive	9-10
DVD-R/-RW drive	9-11
DVD Multi drive	9-13
Diskette drive	9-15
SD card	9-15
PC card	9-16
Infrared port	9-16
Pointing device	9-17
USB	9-19
Memory expansion	9-19
Sound system	9-20
Monitor	9-20
Modem	9-21
LAN	9-22
Wireless LAN	9-23
TV output signal	9-23
Printer	9-24
TOSHIBA support	9-25
Before you call	9-25
Where to write	9-25

Appendixes

Appendix A Specifications	A-1
Appendix B Display Controller and Modes	B-1
Appendix C AT Commands	C-1
Appendix D S-registers	D-1
Appendix E V.90	E-1
Appendix F Internal Modem Guide	F-1
Appendix G Wireless LAN	G-1
Appendix H AC Power Cord and Connectors	H-1
Appendix I Parts Numbers	I-1

Glossary

Index

Preface

Congratulations on your purchase of the Satellite A20 series computer. This powerful notebook computer provides excellent expansion capability, including multimedia devices, and it is designed to provide years of reliable, high-performance computing.

This manual tells how to set up and begin using your Satellite A20 series computer. It also provides detailed information on configuring your computer, basic operations and care, using optional devices and troubleshooting.

If you are a new user of computers or if you're new to portable computing, first read over the *Introduction* and *The Grand Tour* chapters to familiarize yourself with the computer's features, components and accessory devices. Then read *Getting Started* for step-by-step instructions on setting up your computer.

If you are an experienced computer user, please continue reading the preface to learn how this manual is organized, then become acquainted with this manual by browsing through its pages. Be sure to look over the *Special features* section of the *Introduction*, to learn about features that are uncommon or unique to the computers and carefully read *HW Setup and Passwords*.

Manual contents

This manual is composed of nine chapters, nine appendixes, a glossary and an index.

Chapter 1, *Introduction*, is an overview of the computer's features, capabilities, and options.

Chapter 2, *The Grand Tour*, identifies the components of the computer and briefly explains how they function.

Chapter 3, *Getting Started*, provides a quick overview of how to begin operating your computer and gives tips on safety and designing your work area.

Chapter 4, *Operating Basics*, includes instructions on using the following devices: Touch Pad, USB diskette drive, optical media drives, audio/video controls, modem, wireless communication features, LAN. It also provides tips on care of the computer, diskettes and CD/DVDs.

Chapter 5, *The Keyboard*, describes special keyboard functions including the keypad overlay and hot keys.

Chapter 6, *Power*, gives details on the computer's power resources and battery save modes.

Chapter 7, *HW Setup and Passwords*, explains how to configure the computer using the HW Setup program. It also tells how to set passwords.

Chapter 8, *Optional Devices*, describes the optional hardware available.

Chapter 9, *Troubleshooting*, suggests courses of action if the computer doesn't seem to be working properly.

The Appendixes provide technical information about your computer.

The Glossary defines general computer terminology and includes a list of acronyms used in the text.

The Index quickly directs you to the information contained in this manual.

Conventions

This manual uses the following formats to describe, identify, and highlight terms and operating procedures.

Abbreviations

On first appearance, and whenever necessary for clarity, abbreviations are enclosed in parentheses following their definition. For example: Read Only Memory (ROM). Acronyms are also defined in the Glossary.

Icons

Icons identify ports, dials, and other parts of your computer. The indicator panel also uses icons to identify the components it is providing information on.

Keys

The keyboard keys are used in the text to describe many computer operations. A distinctive typeface identifies the key top symbols as they appear on the keyboard. For example, **Enter** identifies the Enter key.

Key operation

Some operations require you to simultaneously use two or more keys. We identify such operations by the key top symbols separated by a plus sign (+). For example, **Ctrl + C** means you must hold down **Ctrl** and at the same time press **C**. If three keys are used, hold down the first two and at the same time press the third.

ABC When procedures require an action such as clicking an icon or entering text, the icon's name or the text you are to type in is represented in the type face you see to the left.

Display

ABC Names of windows or icons or text generated by the computer that appears on its display screen is presented in the type face you see to the left.

Messages

Messages are used in this manual to bring important information to your attention. Each type of message is identified as shown below.

***CAUTION:** Pay attention! A caution informs you that improper use of equipment or failure to follow instructions may cause data loss or damage your equipment.*

***NOTE:** Please read. A note is a hint or advice that helps you make best use of your equipment.*

General Precautions

TOSHIBA computers are designed to optimize safety, minimize strain and withstand the rigors of portability. However, certain precautions should be observed to further reduce the risk of personal injury, damage to the computer or impaired performance.

Be certain to read the general precautions below and to note the cautions included in the text of the manual.

Stress injury

Carefully read the *Instruction Manual for Safety & Comfort*. It contains information on prevention of stress injuries to your hands and wrists than can be caused by extensive keyboard use. Chapter 3, *Getting Started*, also includes information on work space design, posture and lighting that can help reduce physical stress.

Heat injury

- ❖ Avoid prolonged physical contact with the computer. If the computer is used for long periods, its surface can become very warm. While the temperature will not feel hot to the touch, if you maintain physical contact with the computer for a long time (if you rest the computer on your lap, or if you keep your hands on the palm rest, for example) your skin might suffer low-heat injury.
- ❖ If the computer has been used for a long time, avoid direct contact with the metal plate supporting the I/O ports. It can become hot.
- ❖ The surface of the AC adaptor can become hot when in use. This condition does not indicate a malfunction. If you need to transport the AC adaptor, disconnect it and let it cool before moving it.
- ❖ Do not lay the AC adaptor on a material that is sensitive to heat. The material could be damaged.

Pressure or impact damage

Do not apply heavy pressure to the computer or subject it to strong impact. Excessive pressure or impact can cause damage to computer components or otherwise cause malfunctions.

PC card overheating

Some PC cards can become hot with prolonged use. Overheating of a PC card can result in errors or instability in the PC card operation. Also be careful when you remove a PC card that has been used for a long time.

Mobile phone

Use of mobile phones can interfere with the audio system. Computer operation is not impaired but it is recommended that a distance of 30 cm be maintained between the computer and a mobile phone in use.

Central Processing Unit (CPU) Performance Disclaimer

CPU performance in your computer product may vary from specifications under the following conditions:

- ❖ Use of certain peripheral products
- ❖ Use of battery power instead of AC power
- ❖ Use of certain multimedia games or videos with special effects
- ❖ Use of standard telephone lines or low speed network connections
- ❖ Use of complex modeling software, such as high end computer aided design applications
- ❖ Use of the computer in areas with low air pressure (high altitude > 1,000 meters or > 3,280 feet above sea level)
- ❖ Use of the computer at temperatures outside the range of 5°C to 35°C (41°F to 95°F) or > 25°C (77°F) at high altitude (all temperature references are approximate).

CPU performance may also vary from specifications due to design configuration.

Under some conditions, your computer product may automatically shut down. This is a normal protective feature designed to reduce the risk of lost data or damage to the product when used outside recommended conditions. To avoid risk of lost data, always make back-up copies of data by periodically storing it on an external storage medium. For optimum performance, use your computer product only under recommended conditions. Read additional restrictions under *Environmental requirements* in Appendix A, *Specifications*. Contact TOSHIBA Technical Service and Support for more information.

Introduction

This chapter provides an equipment checklist, and it identifies the computer's features, options and accessories.

***CAUTION:** Some of the features described in this manual might not function properly if you use an operating system that was not preinstalled by TOSHIBA.*

Equipment checklist

Carefully unpack your computer. Save the box and packing materials for future use.

Hardware

Check to make sure you have all the following items:

- ❖ Satellite A20 Series Portable Personal Computer
- ❖ Universal AC adaptor and power cord
- ❖ USB diskette drive (Provided with some models)
- ❖ Modular cable

Software

- ❖ The following software is preinstalled:
 - Microsoft® Windows XP Home Edition/Professional
 - Modem driver
 - Display Driver
 - TOSHIBA Utilities
 - Wireless LAN driver (Can be used only for Wireless LAN models)
 - Sound Driver
 - DVD-Video Player (Can be used only for DVD-ROM/Multi model)
 - LAN Drivers
 - ALPS Pointing Device Driver
 - TOSHIBA Power Saver
 - TOSHIBA Console

- Infrared Device Driver
- Online manual
- ❖ Product Recovery CD-ROM

Documentation

- *Satellite A20 Portable Personal Computer User's Manual*
- Microsoft Windows XP Home Edition/Professional manual package
- *Instruction Manual for Safety & Comfort*
- End User License Agreement

Features

The computer uses TOSHIBA's advanced Large Scale Integration (LSI), Complementary Metal-Oxide Semiconductor (CMOS) technology extensively to provide compact size, minimum weight, low power usage, and high reliability. This computer incorporates the following features and benefits:

Processor

Built-in The computer is equipped with an Intel® Pentium® processor, which incorporates a math co-processor, a 20 KB level 1 cache memory and a 512 KB level 2 cache memory.

2.53 GHz Intel® Pentium® 4 processor 2.53 GHz

2.66 GHz Intel® Pentium® 4 processor 2.66 GHz

2.80 GHz Intel® Pentium® 4 processor 2.80 GHz

3.06 GHz Intel® Pentium® 4 processor 3.06 GHz

Memory

Slots 128, 256, 512 MB or 1 GB memory modules can be installed in the two memory slots for a maximum of 2 GB system memory.

Video RAM 32 MB of RAM is provided for video display.

Power

Battery pack The computer is powered by one rechargeable lithium-ion battery pack.

RTC battery The computer has an internal battery to back up the internal Real Time Clock (RTC) and calendar.

- Universal AC adaptor** The universal AC adaptor provides power to the system and recharges the batteries when they are low. It comes with a detachable power cord.
- Because it is universal, it can receive a range of AC voltage from 100 to 240 volts; however, the output current varies among different models. Using the wrong model can damage your computer. See the *Universal AC adaptor* section in Chapter 2, *The Grand Tour*.

Disks

- Hard disk drive** Available in four sizes.
- 27.94GB (30.0billion bytes)
 - 37.26GB (40.0billion bytes)
 - 55.89GB (60.0billion bytes)
 - 74.53GB (80.0billion bytes)
- USB diskette drive** Accommodates either 3 1/2" 1.44-megabyte or 720-kilobyte diskettes. It connects to a USB port.
- Optical media drive** The computer is configured with one of the optical media drives listed below. Refer also to Chapter 2, *The Grand Tour*, for specifications and to Chapter 4, *Operating Basics*, for information on using the drives.

CD-RW/DVD-ROM drive

A full-size, CD-RW/DVD-ROM drive module lets you run CD/DVDs without using an adaptor. It reads DVD-ROMs at maximum 8 speed and CD-ROMs at maximum 24 speed. It writes CD-R at up to 24 speed and CD-RW at up to 10 speed. A Mode Control button turns power to the fixed CD-RW/DVD-ROM drive on and off so you can use the drive as a stand-alone audio CD player.

DVD-R/-RW drive

A full-size DVD-R/-RW drive module lets you record data to rewritable CD/DVDs as well as run either 12 cm (4.72") or 8 cm (3.15") CD/DVDs without using an adaptor. It reads DVD-ROMs at maximum 8 speed and CD-ROMs at maximum 24 speed. It writes CD-R at up to 16 speed, CD-RW at up to 10 speed, DVD-R and DVD-RW at single speed.

DVD Multi drive

A full-size, DVD Multi drive module lets you run either 12 cm (4.72") or 8 cm (3.15") CD/DVDs without using an adaptor. It reads DVD-ROMs at maximum 8 speed and CD-ROMs at maximum 24 speed. It writes CD-R at up to 16 speed, CD-RW at up to 8 speed, DVD-R and DVD-RW at single speed, and DVD-RAM at 2 speed.



Display

The computer's LCD panel supports high-resolution video graphics. The screen can be set at a wide range of viewing angles for maximum comfort and readability.

- Built-in
- 14.1" XGA TFT screen, 16M colors, with 1024 horizontal x 768 vertical pixels
 - 15.0" TFT screen, 16 M colors, with one of the following resolutions:
 - XGA, 1024 horizontal x 768 vertical pixels
 - SXGA+, 1400 horizontal x 1050 vertical pixels

Graphics controller A 128-bit graphics controller maximizes display performance. Refer to [Appendix B](#) for more information.

Keyboard

- Built-in
- 85 keys or 86 keys, compatible with IBM® enhanced keyboard, embedded numeric overlay, dedicated cursor control,  and  keys. See Chapter 5, [The Keyboard](#), for details.

Pointing device

Built-in Touch Pad A Touch Pad and control buttons in the palm rest enable control of the on-screen pointer and scrolling of windows.

Ports

- Parallel Parallel printer or other parallel device (ECP compatible).
- External monitor 15-pin, analog VGA port supports VESA DDC2B compatible functions.

Universal Serial Bus (USB2.0)	The computer has three Universal Serial Bus ports that comply with the USB 2.0 standard, which enables data transfer speeds 40 times faster than the USB 1.1 standard. (The ports also support USB 1.1.)
Infrared (Infrared model only)	The serial infrared port meets Infrared Data Association (IrDA 1.1) standards. It enables cableless 4 Mbps, 1.152 Mbps, 115.2 Kbps, 57.6 Kbps, 38.4 Kbps, 19.2 Kbps or 9.6 Kbps data transfer with IrDA 1.1 compatible external devices.

Slots

PC card	The PC card slot accommodates one 5 mm Type II card.
SD card	This slot lets you easily transfer data from devices, such as digital cameras and Personal Digital Assistants, that use SD card flash-memory. It does not support MultiMedia cards.

Multimedia

Sound system	Windows sound system compatible sound system provides internal speakers as well as jacks for an external microphone and headphone. It also has a volume control dial.
TV out port	This port lets you transfer NTSC or PAL data to external devices.
Mode Control button	This button directly launches various CD, DVD and Digital Audio functions. Refer to Chapter 4, <i>Operating Basics</i> , for details.
Audio/Video control buttons	Audio/Video control buttons let you use the computer's optical media drive as a stand-alone audio CD player. You can also use the buttons to control the computer's DVD video player and TOSHIBA Media player when the system is on.
Headphone jack	This jack outputs analog audio signals.
Microphone jack	A 3.5 mm mini microphone jack enables connection of a three-conductor mini jack for monaural microphone input.
Line-in jack	A standard 3.5 mm mini line-in jack enables connection of a stereo device for audio input.

Communications

- Modem** An internal modem provides capability for data and fax communication. It supports V.90 and V.92. (In the U.S. and Canada, both standards are supported; in other countries/regions, only V.90 is supported.) The speed of data transfer and fax depends on analog telephone line conditions. It has a modem jack for connecting to a telephone line. It is preinstalled as a standard device in some markets. Refer to [Appendix E](#) for technical information.
- LAN** The computer has built-in support for Ethernet LAN (10 megabits per second, 10BASE-T) and Fast Ethernet LAN (100 megabits per second, 100BASE-Tx).
- Wireless LAN** Some computers in this series are equipped with a wireless LAN mini-PCI card that is compatible with other LAN systems based on Direct Sequence Spread Spectrum/Orthogonal Frequency Division Multiplexing radio technology that complies with the IEEE802.11 Standard (Revision A or B) and Turbo Mode. Revision-A supports a data transfer rate up to 54Mbit/s. Revision-B supports a data transfer rate up to 11Mbit/s. Turbo Mode supports a data transfer rate up to 108Mbit/s.

Security

- Security lock slot** Connects an optional security lock to anchor the computer to a desk or other large object.

Software

- Standard** Windows XP Home Edition/Professional operating system and TOSHIBA Utilities and drivers preinstalled on the hard disk.
- Plug and Play** When you connect an external device to the computer, Plug and Play capability enables the system to recognize the connection and make the necessary configurations automatically.

Special features

The following features are either unique to TOSHIBA computers or are advanced features, which make the computer more convenient to use.

- | | |
|--------------------------------------|---|
| Hot keys | Key combinations let you quickly modify the system configuration directly from the keyboard without running a system configuration program. |
| Display automatic power off | This feature automatically cuts off power to the internal display when there is no input from the keyboard or pointing device for a time specified. Power is restored when any key is pressed or when there is input from a pointing device. You can specify the time in the <i>Turn off monitor</i> item of the <i>Power Save Mode</i> window in TOSHIBA PowerSaver. |
| HDD automatic power off | This feature automatically cuts off power to the hard disk drive when it is not accessed for a time specified. Power is restored when the hard disk is accessed. You can specify the time in the <i>Turn off hard disks</i> item of the <i>Power Save Mode</i> window in TOSHIBA PowerSaver. |
| Hibernation | This feature lets you turn off the power without exiting from your software. The contents of main memory is saved to the hard disk, when you turn on the power again, you can continue working right where you left off. Refer to the <i>Turning off the power</i> section in Chapter 3, <i>Getting Started</i> , for details. |
| Standby | If you have to interrupt your work, you can turn off the power without exiting from your software. Data is maintained in the computer's main memory. When you turn on the power again, you can continue working right where you left off. |
| System automatic Standby/Hibernation | This feature automatically shuts down the system in standby mode or Hibernation mode when there is no input or hardware access for a time specified. You can specify the time and select either System Standby or System Hibernate in the <i>System standby and System hibernate</i> item of the <i>Power Save Mode</i> window in TOSHIBA Power Saver. |

- Keypad overlay A ten-key pad is integrated into the keyboard. Refer to the *Keypad overlay* section in Chapter 5, *The Keyboard*, for instructions on using the keypad overlay.
- Power on password Two levels of password security, supervisor and user, are available to prevent unauthorized access to your computer.
- Instant security A hot key function blanks the screen and disables the computer providing data security.
- Intelligent power supply A microprocessor in the computer's intelligent power supply detects the battery's charge and calculates the remaining battery capacity. It also protects electronic components from abnormal conditions, such as voltage overload from a universal AC adaptor. You can monitor remaining battery capacity. Use the *Battery remaining* item of the *Power Save Modes* window in TOSHIBA Power Saver.
- Battery save mode This feature lets you save battery power. You can specify the Power Save Mode in the *Running on batteries* item of the *Power Save Modes* window in TOSHIBA Power Saver.
- Panel power on/off This feature turns power to the computer off when the display panel is closed and turns it back on when the panel is opened. You can specify the setting in the *When I close the lid* item of the *System Power Mode* window in TOSHIBA Power Saver.
- Low battery automatic hibernation When battery power is exhausted to the point that computer operation cannot be continued, the system automatically enters Hibernation and shuts down. You can specify the setting in the *Battery Alarm* item of the *Alarm* window in TOSHIBA Power Saver.
- Heat dispersal The CPU has an internal temperature sensor that automatically activates cooling procedures. Refer to the *Heat dispersal* section in Chapter 4, *Operating Basics*, for details on setting the options for cooling methods.

Utilities

This section describes preinstalled utilities and tells how to start them. For details on operations, refer to each utility's online manual, help files or readme.txt files.

TOSHIBA PowerSaver To access this power savings management program, open the Control Panel and select the TOSHIBA Power Saver icon.

HW Setup This program lets you customize your hardware settings according to the way you work with your computer and the peripherals you use. To start the utility, click the Windows Start button and click Control Panel. In the Control Panel, select the TOSHIBA HW Setup icon.

TOSHIBA Controls This utility has two sections to let you do the following:

- **Buttons:** Assign applications to the Internet button (default setting is the browser) and to the TOSHIBA Console button (default setting is the TOSHIBA Console).
- **Media Apps:** Set the mode for the Audio/Video control buttons. Select the application for audio and video playback.

Fn-esse This Windows program lets you define your own "short-cut" keys to quickly launch applications and speed your work in Windows. To start the utility, click the Windows Start button, point to All Programs, point to TOSHIBA Utilities and click Fn-esse.

DVD VideoPlayer The DVD Video Player is used to play DVD-Video. It has an on-screen interface and functions. Click Start, point to All Programs, point to InterVideo WinDVD 4, then click InterVideo WinDVD4.

ConfigFree ConfigFree is a suite of utilities to allow easy control of communication devices and network connections. ConfigFree also allows you to find communication problems and create profiles for easy switching between locations and communication networks. To start ConfigFree, click the Windows Start button, point to All Programs, point to TOSHIBA ConfigFree and click ConfigFree.

Drag'nDrop CD+DVD This easy-to-use software lets you record CDs and DVDs with just a few mouse clicks. You can create CDs and DVDs in the following formats: audio and data CDs and data DVDs. Audio CDs can play on a standard stereo CD player.

Options

You can add a number of options to make your computer even more powerful and convenient to use. The following options are available:

- Memory expansion** A 128, 256, 512 MB or 1 GB memory module (PC2100, DDR) can easily be installed in the computer.
- Battery pack (Black)** An additional battery pack can be purchased from your TOSHIBA dealer. Use it as a spare or replacement.
- Universal AC adaptor** If you use your computer at more than one site frequently, it may be convenient to purchase an additional universal AC adaptor for each site so you will not have to carry the adaptor with you.
- Security lock** A slot is available to attach a security cable to the computer to deter theft.
- USB FDD Kit** A 3 1/2" diskette drive accommodates 1.44-megabyte or 720-kilobyte diskette. It connects to a USB port. (You cannot format 720-kilobyte diskettes on Windows XP, but you can use previously formatted disks.)
- Wireless LAN Kit** This option enables wireless LAN functions in computers that do not have wireless preinstalled. It is installed by dealers only. Two types of Wireless LAN kits are available: Wireless LAN Kit for IEEE 802.11 Standard (Revision B) and Wireless LAN Kit for IEEE 802.11 Standard (Revision A and B)

The Grand Tour

This chapter identifies the various components of your computer. Become familiar with each component before you operate the computer.

Front with the display closed

Figure 2-1 shows the computer's front with its display panel in the closed position.

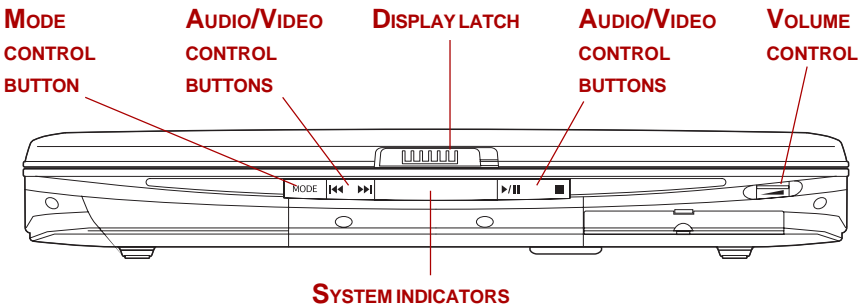

Figure 2-1 Front of the computer with display closed

- Mode Control button** Press this button to switch the mode between CD/DVD and Digital Audio.
- Audio/Video control buttons** Previous ◀◀ button: Plays the previous track/chapter/data. Play/pause ▶/|| button: Begins or pauses play. Stop ■ button: Halts play. Next ▶▶| button: Plays the next track/chapter/data. Refer to Chapter 4, *Operating Basics*.

NOTE: If Random is selected in TOSHIBA Media Player, selecting Next or Previous advances to a random selection.

- Display latch** This latch secures the LCD panel in its closed position. Slide the latch to open the display.
- Volume control** Use this dial to adjust the volume of the stereo speakers or the stereo headphones.



System indicators LEDs let you monitor the status of various computer functions. Details are given in the *System indicators* section.

Left side

Figure 2-2 shows the computer's left side.

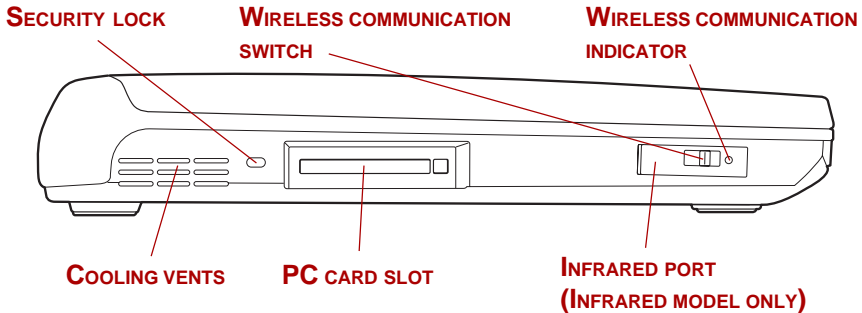

Figure 2-2 The left side of the computer

Cooling vents These vents provide an outlet for air pulled through the computer by the fan.

CAUTION: Be careful not to block the cooling vents. Also be careful to keep foreign objects out of them. A pin or similar object can damage the computer's circuitry.

Security lock A security cable attaches to this slot. The optional security cable anchors your computer to a desk or other large object to deter theft.



PC card slot A PC card slot can accommodate one 5 mm Type II card. You can install any industry standard PC card such as a SCSI adaptor, Ethernet adaptor or flash memory card.

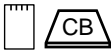

CAUTION: Keep foreign objects out of the PC card slot. A pin or similar object can damage the computer's circuitry.

**Infrared port
(Infrared model
only)**



This infrared port is compatible with Infrared Data Association (IrDA 1.1) standards. It enables cableless 4 Mbps, 1.15 Mbps, 115.2 Kbps, 57.6 Kbps, 38.4 Kbps, 19.2 Kbps or 9.6 Kbps data transfer with IrDA 1.1 compatible external devices.

**Wireless
communication
switch**



Slide this switch toward the front of the computer to turn off Wireless LAN function. Slide it toward the back of the computer to turn on the functions (Wireless LAN model or Wireless LAN ready model only).

CAUTION: Set the switch to off in airplanes and hospitals. Check the wireless communication indicator. It will stop glowing when the wireless communication function is off.

**Wireless
communication
indicator**



This indicator glows orange when the Wireless LAN function is on (Wireless LAN model or Wireless LAN ready model only).

Right side

Figure 2-3 shows the computer's right side.

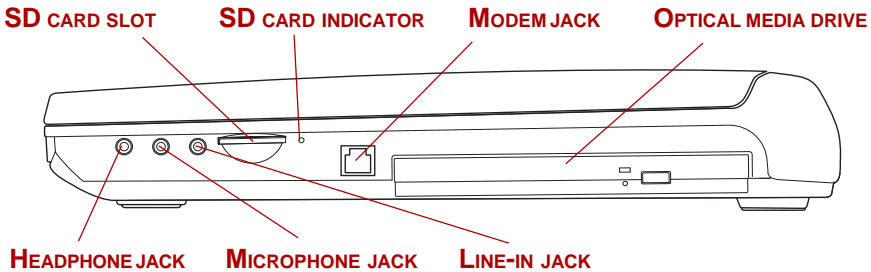

Figure 2-3 The right side of the computer

Headphone jack



This jack lets you connect digital speakers or a stereo headphone (16 ohm minimum). When you connect a digital speaker or headphones, the internal speaker is automatically disabled.

Microphone jack



A 3.5 mm mini microphone jack enables connection of a three-conductor mini jack for monaural microphone input.

Line-in jack



A standard 3.5 mm mini line-in jack enables connection of a stereo device for audio input.

SD card slot



SD cards are used in a wide variety of external devices. This slot lets you transfer data from the device to your computer. An indicator on the right side of the slot glows when a card is being accessed.

CAUTION: *Keep foreign objects out of the SD card slot. A pin or similar object can damage the computer's circuitry.*

SD card indicator

This indicator glows green when the computer is accessing the SD card slot.

Modem jack



In areas where an internal modem is installed as standard equipment, there is a modem jack that lets you use a modular cable to connect the modem directly to a telephone line.

- CAUTIONS:**
1. *In case of a lightning storm, unplug the modem cable from the telephone jack.*
 2. *Do not connect the modem to a digital telephone line. A digital line will damage the modem.*

Optical media drive

The computer is configured with a CD-RW/DVD-ROM drive, DVD-R/-RW drive or a DVDMulti drive.

Back side

Figure 2-4 shows the computer's back side.

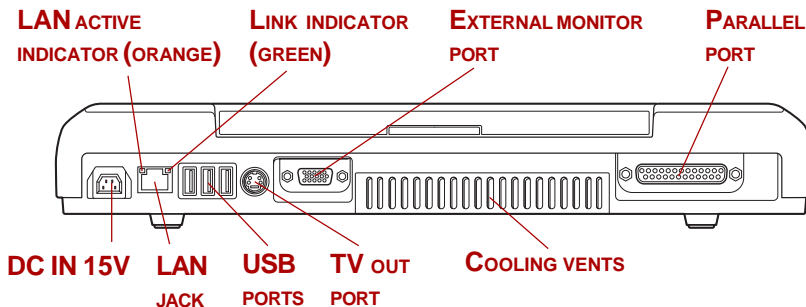
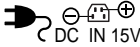

Figure 2-4 The back side of the computer

DC IN 15V

The universal AC adaptor connects to this socket. Use only the model of universal AC adaptor that comes with the computer. Using the wrong adaptor can damage your computer.

LAN jack

This jack lets you connect to a LAN. The adaptor has built-in support for Ethernet LAN (10 megabits per second, 10BASE-T) and Fast Ethernet LAN (100 megabits per second, 100BASE-Tx). The LAN has two indicators. See Chapter 4, *Operating Basics*, for details.

- CAUTIONS:**
1. Do not connect any cable other than a LAN cable to the LAN jack. It could cause damage or malfunction.
 2. Do not connect the LAN cable to a power supply. It could cause damage or malfunction.

LAN active indicator (orange)

This indicator glows orange when data is being exchanged between the computer and the LAN.

Link indicator (green)

This indicator glows green when the computer is connected to a LAN and the LAN is functioning properly.

NOTE: When the Wake-up on LAN function is activated, the LAN indicators do not glow while the computer is in standby mode (while it is waiting for a LAN wake-up signal).

TV out port

This port lets you transfer NTSC or PAL data to external devices.

Universal Serial Bus (USB 2.0) port

Three Universal Serial Bus ports are on the back side. The port complies with the USB 2.0 standard, which enables data transfer speeds 40 times faster than the USB 1.1 standard. (The ports also support USB 1.1.)

CAUTION: Keep foreign objects out of the USB connectors. A pin or similar object can damage the computer's circuitry.

NOTE: Operation of all functions of all USB devices has not been confirmed. Some functions might not execute properly.

External monitor port

This 15-pin port lets you connect an external video display.



Cooling vents

Refer to the *Left side* section.

Parallel port

This Centronics-compatible, 25-pin parallel port is used to connect a parallel printer or other parallel device. This port supports Extended Capabilities Port (ECP) standard.



Underside

Figure 2-5 shows the underside of the computer. Make sure the display is closed before turning over your computer.

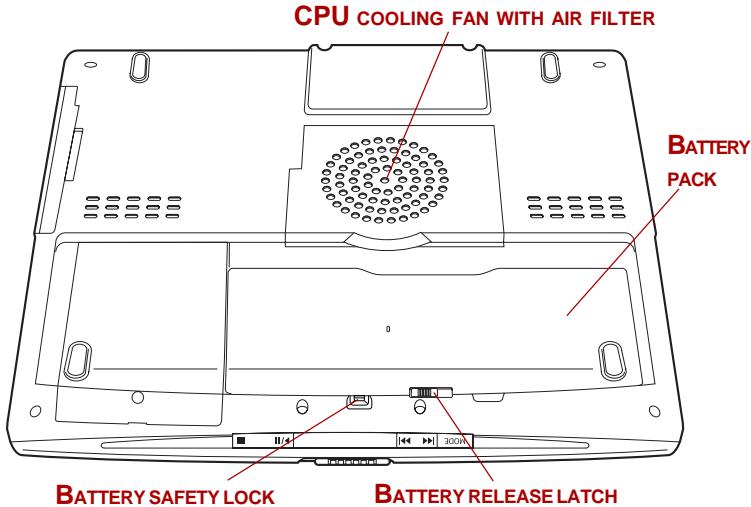

Figure 2-5 The underside of the computer

CPU cooling fan with air filter

This cooling fan intakes air to cool the CPU. An air filter prevents dust from entering the computer.

CAUTION: Clean the filter regularly with a vacuum cleaner.

Battery pack



The battery pack powers the computer when the universal AC adaptor is not connected. For detailed information on the battery pack, refer to Chapter 6, *Power*.

Battery release latch



Slide this latch to release the battery pack for removal.

Battery safety lock



Slide the battery safety lock forward to free the battery latch.

Front with the display open

Figure 2-6 shows the front of the computer with the display open. To open the display, slide the display latch on the front of the display and lift up. Position the display at a comfortable viewing angle.

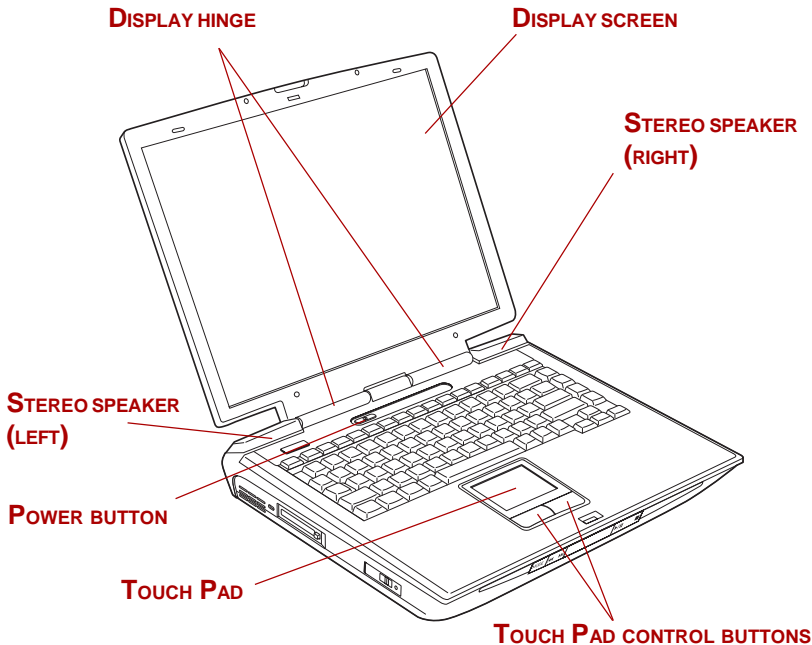

Figure 2-6 The front with the display open

Display hinge The display hinge holds the display screen at easy-to-view angles.

Display screen The LCD displays high-contrast text and graphics. The computer's LCD consists of up to 1024 x 768 pixels or 1400 x 1050 pixels. Refer to [Appendix B](#).

When the computer operates on the universal AC adaptor the display screen's image will be somewhat brighter than when it operates on battery power. The lower brightness level is intended to save battery power.

Stereo speakers The speakers emit sound generated by your software as well as audio alarms, such as low battery condition, generated by the system.

Titanium Speaker

Power button Press the power button to turn the computer's power on and off.



Touch Pad A Touch Pad located in the palm rest is used to control the on-screen pointer. Refer to the [Touch Pad](#) section in Chapter 4, *Operating Basics*.

Touch Pad control buttons Control buttons below the Touch Pad let you select menu items or manipulate text and graphics designated by the on-screen pointer.

System indicators

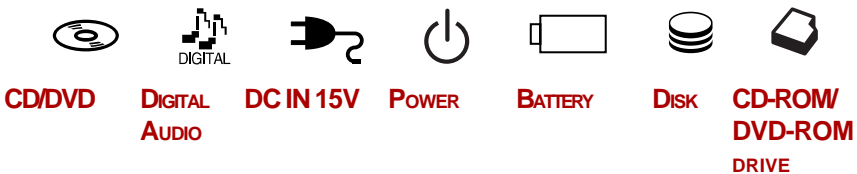

Figure 2-7 System indicators

CD/DVD The **CD/DVD** indicator glows green when the computer is accessing a CD/DVD. It does not light when the controls are in lock mode. Use the Mode Control button to lock or unlock the controls. Refer to Chapter 4, [Operating Basics](#), for details.



Digital Audio



The **Digital Audio** indicator glows green when reproducing music files (WAVE file, MIDI file, or MP3 files, etc). It does not light when the controls are in lock mode. Use the Mode Control button to lock or unlock the controls. Refer to Chapter 4, *Operating Basics*, for details.

DC IN 15V



The **DC IN** indicator glows green when DC power is supplied from the AC power adaptor. If the adaptor's output voltage is abnormal or if the power supply malfunctions, this indicator flashes orange.

Power



The **Power** indicator glows green when the computer is on. If you select **Standby** from **Shut Down Windows**, this indicator flashes orange (one second on, two seconds off) while the computer shuts down.

Battery



The **Battery** indicator shows the condition of the battery's charge: Green indicates full charge, orange indicates battery charging and flashing orange indicates a low battery charge. Refer to Chapter 6, *Power*.

Disk



The **Disk** indicator glows green when the computer is accessing the built-in hard disk.

CD-ROM/DVD-ROM drive



The **CD-ROM/DVD-ROM drive** indicator glows green when the computer is accessing a CD-RW/DVD-ROM drive, DVD-R/-RW drive or DVD Multi drive in the optical media drive.

Keyboard indicators

The figures below show the positions of the keypad overlay indicators and the CapsLock indicator.

When the F10 key indicator glows the keypad overlay lets you control the cursor.

When the F11 key indicator glows the keypad overlay lets you enter numbers.

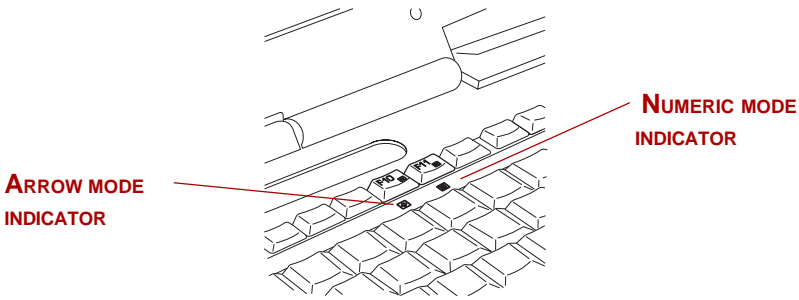

Figure 2-8 Keypad overlay indicators

Arrow mode



When the **Arrow mode** indicator lights green, you can use the keypad overlay (gray labeled keys) as cursor keys. Refer to the *Keypad overlay* section in Chapter 5, *The Keyboard*.

Numeric mode



You can use the keypad overlay (gray labeled keys) for numeric input when the **Numeric mode** indicator lights green. Refer to the *Keypad overlay* section in Chapter 5, *The Keyboard*.

When the CapsLock indicator glows the keyboard is in all-caps mode.

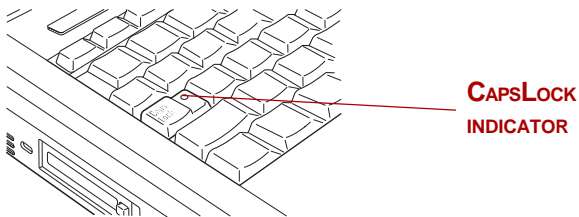

Figure 2-9 CapsLock indicator

CapsLock

This indicator glows green when the alphabet keys are locked in uppercase.

USB diskette drive

A 3 1/2" diskette drive accommodates 1.44-megabyte or 720-kilobyte diskettes. It connects to the USB port.

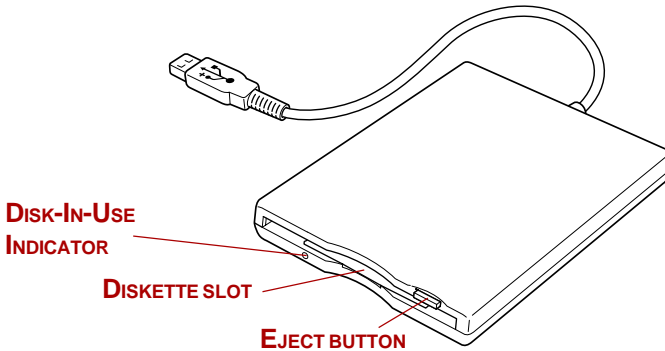

Figure 2-10 USB diskette drive

Disk-In-Use Indicator	This indicator lights when the diskette is being accessed.
Diskette slot	Insert diskettes in this slot.
Eject button	When a diskette is fully seated in the drive, the eject button pops out. To remove a diskette, push in the eject button and the diskette pops out partially for removal.

CAUTION: Check the **Disk-In-Use** indicator when you use the diskette drive. Do not press the eject button or turn off the computer while the light is glowing. Doing so could destroy data and damage the diskette or the drive.

- NOTES:**
1. The external diskette drive should be placed on a flat, horizontal surface when in use. Do not set the drive on an incline greater than 20° while it is operating.
 2. Do not set anything on top of the diskette drive.

Optical media drives

One of the following optical media drives is installed in the computer: CD-RW/DVD-ROM drive, DVD-R/-RW drive or DVD Multi drive. An ATAPI interface controller is used for CD/DVD-ROM operation. When the computer is accessing a CD/DVD, an indicator on the drive glows.

For information on loading and unloading discs and on the Mode Control buttons refer to the *Using optical media drives* and *Audio/Video controls* section in Chapter 4, *Operating Basics*.

Region codes for DVD drives and media

CD-RW/DVD-ROM, DVD Multi drives and media are manufactured according to the specifications of six marketing regions. When you purchase DVD-Video, make sure it matches your drive, otherwise it will not play properly.

Code	Region
1	Canada, United States
2	Japan, Europe, South Africa, Middle East
3	Southeast Asia, East Asia
4	Australia, New Zealand, Pacific Islands, Central America, South America, Caribbean
5	Russia, Indian Subcontinent, Africa, North Korea, Mongolia
6	China

Writable discs

This section describes the types of writable CD/DVD discs. Check the specifications for your drive to for the type of discs it can write. Use Drag'n Drop CD+DVD to write compact discs. Refer to Chapter 4, *Operating Basics*.

CDs

- ❖ CD-R discs can be written only once. The recorded data cannot be erased or changed.
- ❖ CD-RW discs can be recorded more than once. Use either 1, 2, or 4 multi speed CD-RW discs or high-speed 4- to 10-speed discs. The write speed of the high-speed CD-RW discs is maximum 10-speed.

DVDs

- ❖ DVD-R discs can be written only once. The recorded data cannot be erased or changed.
- ❖ DVD-RW discs can be recorded more than once.
- ❖ DVD-RAM discs can be recorded more than once.

Formats

The drives support the following formats:

- DVD-ROM
- DVD-Video
- CD-DA
- CD-Text
- Photo CD (single/multi-session)
- CD-ROM Mode 1, Mode 2
- CD-ROM XA Mode 2 (Form 1, Form 2)
- Enhanced CD (CD-EXTRA)
- CD-G (Audio CD only)
- Addressing Method 2

CD-RW/DVD-ROM drive

The full-size CD-RW/DVD-ROM drive module lets you record data to rewritable CDs as well as run either 12 cm (4.72") or 8 cm (3.15") CD/DVDs without using an adaptor.

NOTE: The read speed is slower at the center of a disc and faster at the outer edge.

DVD read	8 speed (maximum)
CD read	24 speed (maximum)
CD-R write	24 speed (maximum)
CD-RW write	10 speed (maximum, high-speed media)

DVD-R/-RW drive

The full-size DVD-R/-RW drive module lets you record data to rewritable CD/DVDs as well as run either 12 cm (4.72") or 8 cm (3.15") CD/DVDs without using an adaptor.

NOTE: The read speed is slower at the center of a disc and faster at the outer edge.

DVD read	8 speed (maximum)
DVD-R write	1 speed
DVD-RW write	1 speed
CD read	24 speed (maximum)
CD-R write	16 speed (maximum)
CD-RW write	10 speed (maximum)

DVD Multi drive

The full-size DVD Multi drive module lets you record data to rewritable CD/DVDs as well as run either 12 cm (4.72") or 8 cm (3.15") CD/DVDs without using an adaptor.

NOTE: The read speed is slower at the center of a disc and faster at the outer edge.

DVD read	8 speed (maximum)
DVD-R write	1 speed
DVD-RW write	1 speed
DVD-RAM write	2 speed
CD read	24 speed (maximum)
CD-R write	16 speed (maximum)
CD-RW write	8 speed (maximum)

Universal AC adaptor

The universal AC adaptor converts AC power to DC power and reduces the voltage supplied to the computer. It can automatically adjust to any voltage from 100 to 240 volts and to a frequency of either 50 or 60 hertz, enabling you to use the computer in almost any country/region.

To recharge the battery, simply connect the universal AC adaptor to a power source and the computer. See Chapter 6, *Power*, for details.

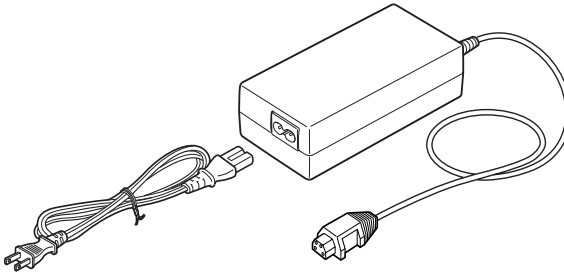

Figure 2-11 The universal AC adaptor

CAUTION: Use only the universal AC adaptor that came with the computer or an equivalent optional adaptor. Use of the wrong adaptor could damage your computer. TOSHIBA assumes no liability for any damage in such case.

Getting Started

This chapter provides basic information to get you started using your computer. It covers the following topics:

- ❖ Setting up your work space — for your health and safety

***NOTE:** Be sure also to read Instruction Manual for Safety & Comfort. This guide, which is included with the computer, explains product liability.*

- ❖ Connecting the universal AC adaptor
- ❖ Opening the display
- ❖ Turning on the power
- ❖ Starting up for the first time
- ❖ Turning off the power
- ❖ Restarting the computer
- ❖ Restoring the preinstalled software from the Product Recovery CD-ROM

***NOTE:** All users should be sure to read the section Starting up for the first time.*

Setting up your work space

Establishing a comfortable work site is important for you and your computer. A poor work environment or stressful work habits can result in discomfort or serious injury from repetitive strain to your hands, wrists or other joints. Proper ambient conditions should also be maintained for the computer's operation. This section discusses the following topics:

- ❖ General conditions
- ❖ Placement of the computer
- ❖ Seating and posture
- ❖ Lighting
- ❖ Work habits

General conditions

In general, if you are comfortable, so is your computer, but read the following to make sure your work site provides a proper environment.

- ❖ Make sure there is adequate space around the computer for proper ventilation.
- ❖ Make sure the AC power cord connects to an outlet that is close to the computer and easily accessible.
- ❖ The temperature should be 5 to 35 degrees Centigrade (41 to 95 degrees Fahrenheit) and the relative humidity should be 20 to 80 percent.
- ❖ Avoid areas where rapid or extreme changes in temperature or humidity may occur.
- ❖ Keep the computer free of dust, moisture, and exposure to direct sunlight.
- ❖ Keep the computer away from heat sources, such as electric heaters.
- ❖ Do not use the computer near liquids or corrosive chemicals.
- ❖ Do not place the computer near objects that create strong magnetic fields (e.g., stereo speakers).
- ❖ Some components in the computer, including data storage media, can be damaged by magnets. Do not place the computer near magnetic objects or bring magnetic objects close to the computer. Be careful of objects, such as stereo speakers, that produce strong magnetic fields during operation. Also, be careful with metal objects, such as bracelets, which can become magnetized.
- ❖ Do not operate the computer close to a mobile phone.
- ❖ Leave ample ventilation room for the fan. Do not block the vents.

Placement of the computer

Position the computer and peripheral devices to provide comfort and safety.

- ❖ Set the computer on a flat surface at a comfortable height and distance. The display should be no higher than eye level to avoid eye strain.
- ❖ Place the computer so that it is directly in front of you when you work and make sure you have adequate space to easily operate other devices.
- ❖ Allow adequate space behind the computer to let you freely adjust the display. The display should be angled to reduce glare and maximize visibility.
- ❖ If you use a paper holder, set it at about the same height and distance as the computer.

Seating and posture

The height of your chair in relation to the computer and keyboard as well as the support it gives your body are primary factors in reducing work strain. Refer to the following tips and to figure 3-1.

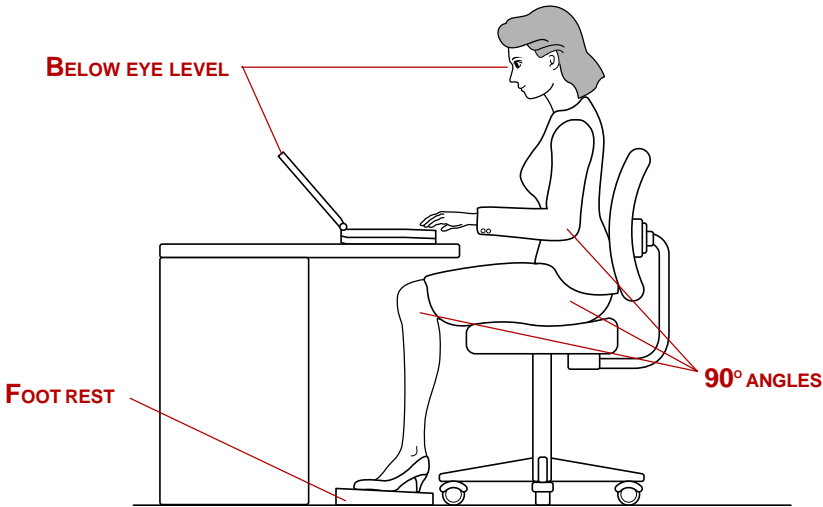

Figure 3-1 Posture and positioning of the computer

- ❖ Place your chair so that the keyboard is at or slightly below the level of your elbow. You should be able to type comfortably with your shoulders relaxed.
- ❖ Your knees should be slightly higher than your hips. If necessary, use a foot rest to raise the level of your knees to ease pressure on the back of your thighs.
- ❖ Adjust the back of your chair so it supports the lower curve of your spine.
- ❖ Sit straight so that your knees, hips and elbows form approximately 90 degree angles when you work. Do not slump forward or lean back too far.

Lighting

Proper lighting can improve legibility of the display and reduce eye strain.

- ❖ Position the computer so that sunlight or bright indoor lighting does not reflect off the screen. Use tinted windows, shades or other screen to eliminate sun glare.
- ❖ Avoid placing the computer in front of bright light that could shine directly in your eyes.
- ❖ If possible, use soft, indirect lighting in your computer work area. Use a lamp to illuminate your documents or desk, but be sure to position the lamp so that it does not reflect off the display or shine in your eyes.

Work habits

A key to avoiding discomfort or injury from repetitive strain is to vary your activities. If possible, schedule a variety of tasks into your work day. If you must spend long periods at the computer, finding ways to break up the routine can reduce stress and improve your efficiency.

- ❖ Sit in a relaxed posture. Good positioning of your chair and equipment as described earlier can reduce tension in your shoulders or neck and ease back strain.
- ❖ Vary your posture frequently.
- ❖ Occasionally stand up and stretch or exercise briefly.
- ❖ Exercise and stretch your wrists and hands a number of times during the day.
- ❖ Frequently, look away from the computer and focus your eyes on a distant object for several seconds, for example 30 seconds every 15 minutes.
- ❖ Take frequent short breaks instead of one or two long breaks, for example, two or three minutes every half hour.
- ❖ Have your eyes examined regularly and visit a doctor promptly, if you suspect you might be suffering from a repetitive strain injury.

A number of books are available on ergonomics and repetitive strain injury or repetitive stress syndrome. For more information on these topics or for pointers on exercises for such stress points as hands and wrists, please check with your library or book vendor. Also refer to the computer's *Instruction Manual for Safety & Comfort*.

Connecting the universal AC adaptor

Attach the universal AC adaptor when you need to charge the battery or you want to operate from AC power. It is also the fastest way to get started, because the battery pack will need to be charged before you can operate from battery power.

The universal AC adaptor can be connected to any power source supplying from 100 to 240 volts and 50 or 60 hertz. For details on using the universal AC adaptor to charge the battery pack, refer to Chapter 6, *Power*.

CAUTION: Use only the AC adaptor that came with the computer or an equivalent optional adaptor. Use of the wrong adaptor could damage your computer. TOSHIBA assumes no liability for any damage in such case.

1. Connect the power cord to the universal AC adaptor.

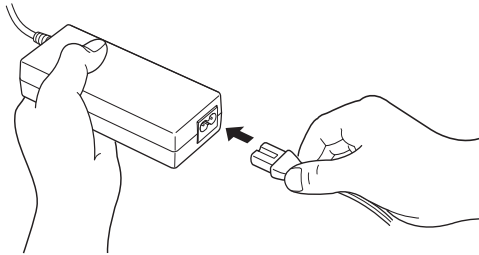

Figure 3-2 Connecting the power cord to the universal AC adaptor

2. Connect the universal AC adaptor's DC output plug to the **DC IN** input port on the back of the computer.

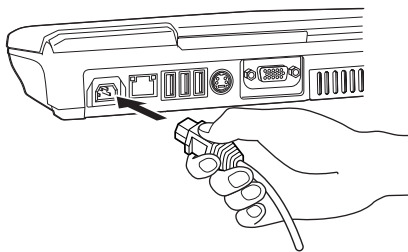

Figure 3-3 Connecting the adaptor to the computer

3. Plug the power cord into a live wall outlet. The **Battery** and **DC IN** indicators on the front of the computer should glow.

Opening the display

The display panel can be rotated in a wide range of angles for optimal viewing.

1. Slide the display latch on the front of the computer to the right.
2. Lift the panel up and adjust it to the best viewing angle for you.

CAUTION: Use reasonable care when opening and closing the display panel. Opening it vigorously or slamming it shut could damage the computer.

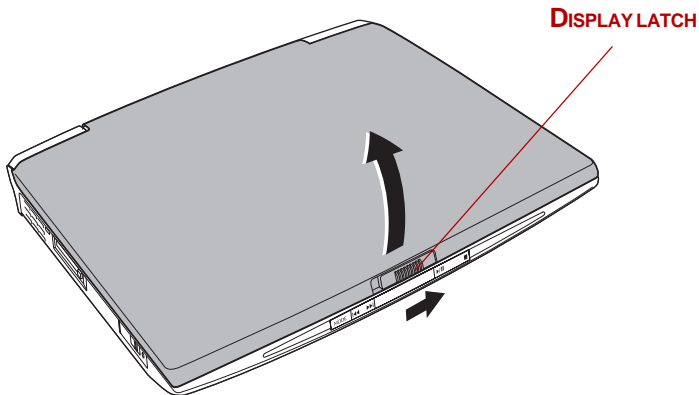

Figure 3-4 Opening the display

Turning on the power

This section describes how to turn on the power.

NOTE: After you turn on the power for the first time, do not turn it off until you have set up the operating system. Refer to the section, [Starting up for the first time](#), in this chapter.

1. Open the display.

2. Press and hold the computer's power button for two or three seconds.

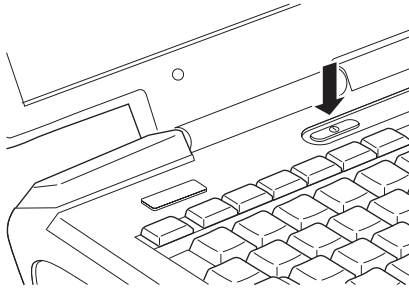

Figure 3-5 Turning on the power

Starting up for the first time

When you first turn on the power, the computer's initial screen is the Microsoft Windows XP Professional Startup Screen Logo. Follow the on-screen directions for each screen. During setup, you can click the **Back** button to return to the previous screen.

Be sure to read the **Windows End User License Agreement** display carefully.

NOTE: Be sure to read the License Agreement carefully.

Turning off the power

The power can be turned off in one of the following modes: Shut down (Boot), Hibernation or Standby mode.

Shut Down mode (Boot mode)

When you turn off the power in Shut Down mode no data is saved and the computer will boot to the operating system's main screen.

1. If you have entered data, save it to the hard disk or to a diskette.
2. Make sure all disk (disc) activity has stopped, then remove the CD/DVDs or diskette.

*CAUTION: Make sure the **Disk** indicator is off. If you turn off the power while a disk (disc) is being accessed, you can lose data or damage the disk (disc).*

3. Click **start** then click **Turn Off Computer**. From the **Turn Off Computer** menu select **Turn Off**.
4. Turn off the power to any peripheral devices.

CAUTION: Do not turn the computer or devices back on immediately. Wait a moment to let all capacitors fully discharge.

Hibernation mode

The hibernation feature saves the contents of memory to the hard disk when the computer is turned off. The next time the computer is turned on, the previous state is restored. The hibernation feature does not save the status of peripheral devices.

- CAUTIONS:**
1. Save your data. While entering hibernation mode, the computer saves the contents of memory to the HDD. However, for safety sake, it is best to save your data manually.
 2. Data will be lost if you remove the battery or disconnect the universal AC adaptor before the save is completed. Wait for the **Disk** indicator to go out.
 3. Do not install or remove a memory module while the computer is in hibernation mode. Data will be lost.

Benefits of hibernation

The hibernation feature provides the following benefits:

- ◆ Saves data to the hard disk when the computer automatically shuts down because of a low battery.

NOTE: For the computer to shut down in hibernation mode, the hibernation feature must be enabled in two places in TOSHIBA Power Saver: the Hibernate window and the Battery Alarm item of the Alarm window. Otherwise, the computer will shut down in Standby mode. If battery power becomes depleted, data saved in Standby will be lost.

- ◆ You can return to your previous working environment immediately when you turn on the computer.
- ◆ Saves power by shutting down the system when the computer receives no input or hardware access for the duration set by the System hibernate feature.
- ◆ You can use the panel power off feature.

Starting Hibernation

***NOTE:** You can also enable Hibernation by pressing **Fn + F4**. See Chapter 5, [The Keyboard](#), for details.*

To enter Hibernation mode, follow the steps below.

1. Click **start**.
2. Select **Turn Off Computer**.
3. Open the **Turn Off Computer** dialog box. **Hibernate** is not displayed.
4. Press the **Shift** key. The **Standby** item will change to **Hibernate**.
5. Select **Hibernate**.

Automatic Hibernation

The computer will enter Hibernate mode automatically when you press the power button or close the lid. First, however, make the appropriate settings according to the steps below.

1. Open the **Control Panel**.
2. Open **Performance and Maintenance** and open **TOSHIBA Power Saver**.
3. Select the **Hibernate** window, select the **Enable Hibernate support** check box and click the **Apply** button.
4. Select the **Power Save Modes** window.
5. Double-click **Power Mode (Full Power, Normal, etc.)** and open the **System Power Mode** window.
6. Enable the desired Hibernation settings for **When I press the power button** and **When I close the lid**.
7. Click the **OK** button.

Data save in hibernation mode

When you turn off the power in hibernation mode, the computer takes a moment to save current memory data to the hard disk. During this time, the **Disk** indicator will light.

After you turn off the computer and memory is saved to the hard disk, turn off the power to any peripheral devices.

CAUTION: Do not turn the computer or devices back on immediately. Wait a moment to let all capacitors fully discharge.

Standby mode

If you have to interrupt your work, you can turn off the power without exiting from your software. Data is maintained in the computer's main memory. When you turn on the power again, you can continue working right where you left off.

- NOTES:**
1. When the AC adaptor is connected, the computer will go into Standby mode according to the settings in the TOSHIBA Power Saver utility.
 2. To restore operation from Standby mode, press the power button or press any key. The latter action works only if Wake-up on Keyboard is enabled in HW Setup.
 3. If the computer automatically enters Standby mode while a network application is active, the application might not be restored when the computer wakes up from Standby.
 4. To prevent the computer from automatically entering Standby mode, disable Standby in TOSHIBA Power Saver. That action, however, will nullify the computer's Energy Star compliance.

- CAUTIONS:**
1. Before entering Standby mode, be sure to save your data.
 2. Do not install or remove a memory module while the computer is in standby mode. The computer or the module could be damaged.
 3. Do not remove the battery pack while the computer is in standby mode (unless the computer is connected to an AC power source). Data in memory will be lost.
 4. If you carry the computer on board an aircraft or into a hospital, be sure to shut down the computer in hibernation mode or in shutdown mode to avoid radio signal interference.

Benefits of standby

The standby feature provides the following benefits:

- ❖ Restores the previous working environment more rapidly than does hibernation.
- ❖ Saves power by shutting down the system when the computer receives no input or hardware access for the duration set by the System Standby feature.
- ❖ You can use the panel power off feature.

Executing standby

NOTE: You can also enable Standby by pressing **Fn + F3**. See Chapter 5, [The Keyboard](#), for details.

You can enter standby mode in one of three ways:

1. Click **start**, click **Turn Off Computer** and click **Stand by**.
2. Close the display panel. This feature must be enabled. Refer to the *System Power Mode* item in *Power Saver Utility* in the Control Panel.

Open **Performance and Maintenance** and open **TOSHIBA Power Saver**.

3. Press the power button. This feature must be enabled. Refer to the *System Power Mode* item in *Power Saver Utility* in the Control Panel.

Open **Performance and Maintenance** and open **TOSHIBA Power Saver**.

When you turn the power back on, you can continue where you left when you shut down the computer.

- NOTES:*
1. When the computer is shut down in standby mode, the **Power** indicator flashes orange.
 2. If you are operating the computer on battery power, you can lengthen the operating time by shutting down in hibernation mode. Standby mode consumes more power.

Standby limitations

Standby will not function under the following conditions:

- ❖ Power is turned back on immediately after shutting down.
- ❖ Memory circuits are exposed to static electricity or electrical noise.

Restarting the computer

Certain conditions require that you restart the system. For example, if:

- ◆ You change certain computer settings.
- ◆ An error occurs and the computer does not respond to your keyboard commands.

There are three ways to restart the computer system:

1. Click **start** then click **Turn Off Computer**. From the **Turn Off Computer** menu select **Restart**.
2. Press **Ctrl + Alt + Del** to display the **Windows Task Manager**, then select **Shutdown** and **Restart**.
3. Press the power button and hold it down for five seconds. Wait 10 to 15 seconds, then turn the power on again by pressing the power button.

Restoring the preinstalled software from the Product Recovery CD-ROM

If preinstalled files are damaged, use the Product Recovery CD-ROM to restore them. To restore the operating system and all preinstalled software, follow the steps below.

***CAUTION:** When you reinstall the Windows operating system, the hard disk will be reformatted and all data will be lost.*

1. Load the Product Recovery CD-ROM in the fixed optical media drive and turn off the computer's power.
2. Hold down the **F12** key and turn on the power. When **In Touch with Tomorrow TOSHIBA** appears, release the **F12** key.
3. Use the left or right cursor key to select the CD-ROM icon in the display menu. For details, refer to the *Boot priority* section in Chapter 7, *HW Setup and Passwords*.
4. Follow the on-screen instructions.

Operating Basics

This chapter gives information on basic operations including using the Touch Pad, USB diskette drive, optical media drives, audio/video controls, modem, wireless communication features and LAN. It also provides tips on caring for your computer, diskettes and CD/DVDs.

Touch Pad

The configuration, the computer is equipped a Touch Pad as a pointing device. To use the Touch Pad, simply touch and move your finger tip across it in the direction you want the on-screen pointer to go.

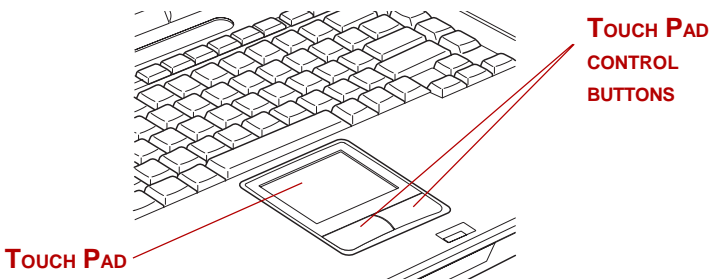

Figure 4-1 Touch Pad and Touch Pad control buttons

Two buttons below the keyboard are used like the buttons on a mouse pointer. Press the left button to select a menu item or to manipulate text or graphics designated by the pointer. Press the right button to display a menu or other function depending on the software you are using.

NOTE: You can also tap the Touch Pad to perform functions similar to those of the left button.

Click: Tap the Touch Pad once

Double-click: Tap twice

Drag and drop: Tap to select the material you want to move. Leave your finger on the Touch Pad after the second tap and move the material.

Using the USB diskette drive

A 3 1/2" diskette drive connects to the computer's USB port. It accommodates 1.44-megabyte or 720-kilobyte diskettes. Refer to Chapter 2, *The Grand Tour*, for more information.

Connecting 3 1/2" diskette drive

To connect the drive, plug the diskette drive connector into a USB port. Refer to Figure 4-2.

CAUTION: Make sure the connector is right side up and properly aligned with the socket. Do not try to force the connection, doing so can damage the connecting pins.

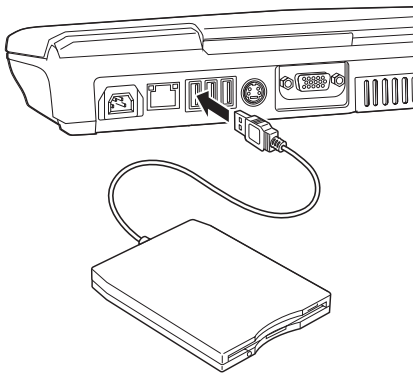

Figure 4-2 Connecting the USB diskette drive

NOTE: If you connect the diskette drive after turning on the computer, it will take about 10 seconds for the computer to recognize the drive. Do not disconnect and reconnect before 10 seconds has elapsed.

Disconnecting 3 1/2" diskette drive

When you have finished using the diskette drive, follow the procedures below to disconnect it:

1. Wait for the indicator light to go out to make sure all diskette activity has stopped.

CAUTION: *If you disconnect the diskette drive or turn off the power while the computer is accessing the drive you may lose data or damage the diskette or the drive.*

2. Click the **Safety Remove Hardware** icon on the Task Bar.
3. Click **Diskette drive**.
4. Pull the diskette drive connector out of the USB port.

Using optical media drives

The illustrations in this section might differ slightly from your drive, but, operation is the same for all optical media drives. The full-size drive provides high-performance execution of CD/DVD-ROM-based programs. You can run either 12 cm (4.72") or 8 cm (3.15") CD/DVDs without an adaptor. An ATAPI interface controller is used for CD/DVD-ROM operation. When the computer is accessing a CD/DVD, an indicator on the drive glows.

NOTE: *Use the WinDVD 4 application to view DVD-Video discs.*

If you have a CD-RW/DVD-ROM drive, refer also to the [Writing CDs on CD-RW/DVD-ROM drive](#) section for precautions on writing to CDs.

If you have a DVD-R/-RW drive, refer also to the [Writing CD/DVDs on DVD-R/-RW drive](#) section for precautions on writing to CDs.

If you have a DVD Multi drive, refer also to the [Writing CD/DVDs on DVD Multi drive](#) section for precautions on writing to CDs.

Loading discs

To load CD/DVDs, follow the steps below and refer to figures 4-3 to 4-7.

1. a. When the power is on, press the eject button to open the drawer slightly.

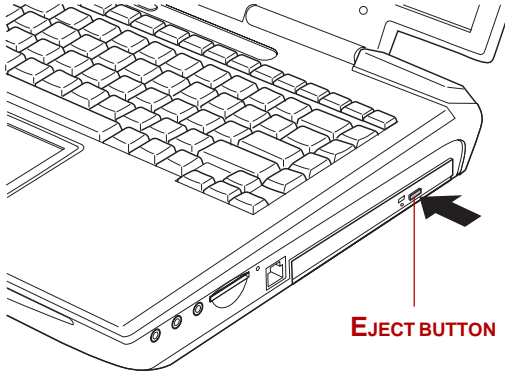

Figure 4-3 Pressing the eject button

- b. Pressing the eject button will not open the drawer when the drive's power is off. If the power is off, you can open the drawer by inserting a slender object (about 15 mm) such as a straightened paper clip into the eject hole just to the right of the eject button.

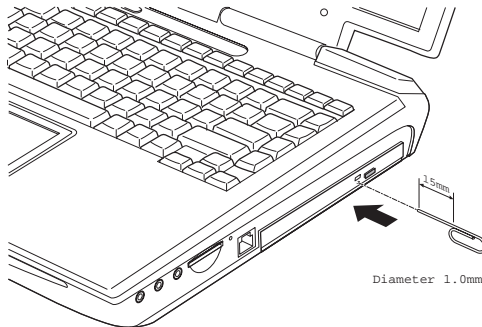

Figure 4-4 Manual release with the eject hole

2. Grasp the drawer gently and pull until it is fully opened.

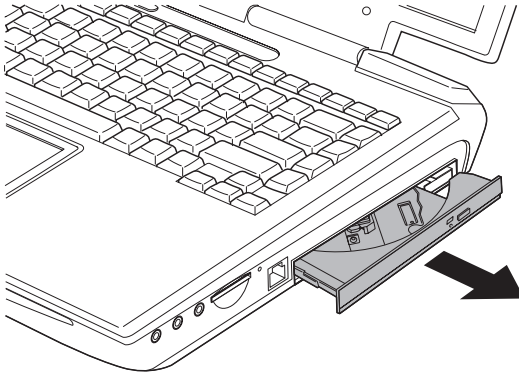

Figure 4-5 Pulling the drawer open

3. Lay the CD/DVD, label side up, in the drawer.

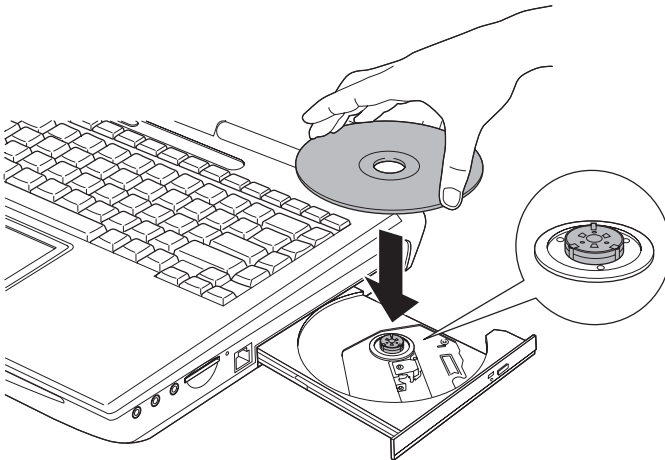

Figure 4-6 Inserting a CD/DVD

NOTE: When the drawer is fully opened, the edge of the computer will extend slightly over the CD/DVD tray. Therefore, you will need to turn the CD/DVD at an angle when you place it in the tray. After seating the CD/DVD, however, make sure it lies flat, as shown in figure 4-6.

- CAUTIONS:**
1. Do not touch the laser lens. Doing so could cause misalignment.
 2. Be careful to keep foreign matter from entering the drive. Check the back edge of the tray to make sure it carries no debris before closing the drive.
4. Press gently at the center of the CD/DVD until you feel it click into place. The CD/DVD should lie below the top of the spindle, flush with the spindle base.
 5. Push the center of the drawer to close it. Press gently until it locks into place.

CAUTION: If the CD/DVD is not seated properly when the drawer is closed, the CD/DVD might be damaged. Also, the drawer might not open fully when you press the eject button.

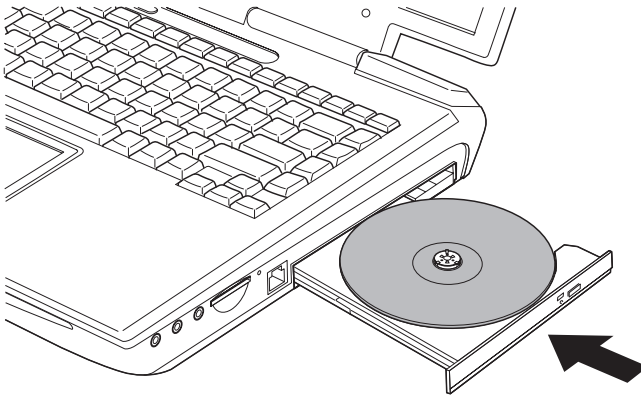

Figure 4-7 Closing the CD/DVD drawer

Removing discs

To remove the CD/DVD, follow the steps below and refer to figure 4-8.

CAUTION: Do not press the eject button while the computer is accessing the optical media drive. Wait for the drive indicator to go out before you open the drawer. Also, if the CD/DVD is spinning when you open the drawer, wait for it to stop before you remove it.

1. To pop the drawer partially open, press the eject button. Gently pull the drawer out until it is fully opened.

CAUTIONS: 1. When the drawer pops open slightly, wait a moment to make sure the CD/DVD has stopped spinning before pulling the drawer fully open.

2. Turn off the power before you use the eject hole. If the CD/DVD is spinning when you open the drawer, the CD/DVD could fly off the spindle and cause injury.

2. The CD/DVD extends slightly over the sides of the drawer so you can grasp it. Hold the CD/DVD gently and lift it out.

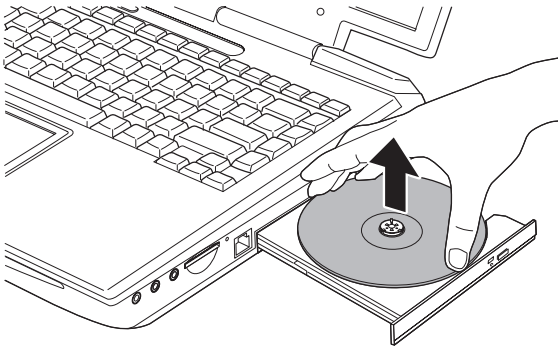

Figure 4-8 Removing a CD/DVD

3. Push the center of the drawer to close it. Press gently until it locks into place.

Audio/Video controls

This section describes how to use the audio/video control buttons. You do not have to turn on the computer's operating system to play audio CD/DVDs. The following controls let you use the computer as a stand-alone CD/DVD player. When the operating system is running, the buttons control video as well as audio.

Mode Control button

Besides the CD/DVD and Digital control functions described in the chart in the next section, you can use the Mode Control button to turn off the computer and change the lock setting.

- ❖ If the CD/DVD and Digital Audio controls are locked, hold down the Mode Control button for four seconds to change to unlock mode while the computer turns off.
- ❖ If the CD/DVD and Digital Audio controls are unlocked, hold down the Mode Control button for four seconds to change to lock mode while the computer turns off.

Controls for CD/DVD and Digital Audio

The chart below describes controls for CD/DVD and Digital Audio.

	CD/DVD control	Digital Audio control
Power is off and you press Play/Pause	If an audio CD is in the optical media drive, the system enters CD Player mode and operates as a stand-alone CD player. If a DVD is in the optical media drive, the operating system starts and the DVD Video player starts.	Operating system starts, TOSHIBA Media Player starts and Digital Audio Data play begins.
OS is running and you press Play/Pause	If an audio CD is in the optical media drive, TOSHIBA Media Player starts and CD audio play begins. If a DVD is in the optical media drive, the DVD Video player starts and DVD Video play begins.	TOSHIBA Media Player starts and Digital Audio Data play begins.

CD player mode and you press Mode Control	Optical media drive power turns off.	-----
OS is running and you press Mode Control	The mode changes to Digital/Audio control.	The mode changes to CD/DVD control.

- NOTES:**
- If the computer power is off, the CD/DVD control functions only for the optical media drive. If you want to control the optical media drive by CD/DVD control when the OS is booted up, set the appropriate player application software. You cannot play optical media, only by setting the internal CD/DVD play drive on the Media Apps tab of the TOSHIBA Controls.*
 - To play Digital Audio Data, you must set the play list in the TOSHIBA Media Player. The next time you play Digital Audio Data in succession, the former play list will become active. If a CD was played the previous time, then All Audio will be used.*

CAUTION: Do not install or remove a memory module while the optical media drive power is on in CD Player mode. First press the Mode control button to turn off the power to the optical media drive.

Next and Previous buttons

A single button on a rocker controls the **Next** and **Previous** functions. Press on the icon to select the desired function.

Next Press the  icon to advances to the next track, chapter or data.

Previous Press the  icon to advances to the previous track, chapter or data.

NOTE: *If Random is selected in TOSHIBA Media Player, selecting Next or Previous advances to a random selection.*

Play/Pause and Stop buttons

A single button on a rocker controls the **Play/Pause** and **Stop** functions. Press on the icon to select the desired function.

Play/Pause Press the ►/■ icon to begin or pause play.

Stop Press the ■ icon to stop play.

Writing CDs on CD-RW/DVD-ROM drive

Depending on the type of drive installed, you may be able to write CDs. The CD-RW/DVD-ROM drive lets you write as well as read CD-ROMs. Observe the precautions in this section to ensure the best performance for writing CDs. For information on loading and unloading CDs refer to the [Using optical media drives](#) section.

***NOTE:** CD-R discs can be written to only once. CD-RW discs can be rewritten many times.*

Before writing or rewriting

Please observe the following points when you write or rewrite the data.

- ◆ We recommend the following manufacturers of CD-R and CD-RW media. Media quality can affect write or rewrite success rates.

CD-R: TAIYOYUDEN CO., LTD.

Mitsui Chemicals Inc.

MITUBISHICHEMICAL CORPORATION

RICOH Co., Ltd.

Hitachi Maxell Ltd.

CD-RW: MITUBISHICHEMICAL CORPORATION

RICOH Co., Ltd.

TOSHIBA has confirmed the operation of CD-R and CD-RW media of the manufacturers above. Operation of other media cannot be guaranteed.

- ◆ CD-RW can generally be rewritten about 1,000 times. However, the actual number of rewrites is affected by the quality of the media and the way it is used.

- ❖ Be sure to connect the universal AC adaptor when you write or rewrite.
- ❖ Be sure to close all other software programs except the writing software.
- ❖ Do not run software such as a screen saver which can put a heavy load on the CPU.
- ❖ Operate the computer at full power. Do not use power-saving features.
- ❖ Do not write while virus check software is running. Wait for it to finish, then disable virus detection programs including any software that checks files automatically in the background.
- ❖ Do not use hard disk utilities, including those intended to enhance HDD access speed. They may cause unstable operation and damage data.
- ❖ Write from the computer's HDD to the CD. Do not try to write from shared devices such as a LAN server or any other network device.
- ❖ Writing with software other than Drag'n Drop CD+DVD has not been confirmed. Therefore, operation with other software cannot be guaranteed.

When writing or rewriting

Note the following when you write or rewrite a CD-R or CD-RW.

- ❖ Always copy data from the HDD to the CD. Do not use cut-and-paste. The original data will be lost if there is a write error.
- ❖ Do not perform any of the following actions:
 - Operate the computer for any other function, including use of a mouse or Touch Pad, closing/opening the LCD panel.
 - Start a communication application such as a modem.
 - Apply impact or vibration to the PC.
 - Install, remove or connect external devices, including the following:
PC card, SD card, USB devices, external display, optical digital devices.
 - Use the CD/MP3 control buttons to reproduce music and voice.
 - Open the optical media drive.
- ❖ If the media is poor in quality, dirty or damaged, writing or rewriting errors may occur.
- ❖ Set the computer on a level surface and avoid places subject to vibration such as airplanes trains, or cars. Do not use an unstable surface such as a stand.
- ❖ Keep mobile phones and other wireless communication devices away from the computer.

Writing CD/DVDs on DVD-R/-RW drive

You can use the DVD-R/-RW drive to write data to either CD-R/RW or DVD-R/-RW discs. The following applications for writing are supplied on CD-ROM: Drag'n Drop CD+DVD, licensed by Easy Systems Japan Ltd., and DigiOn Inc., MotionDV STUDIO, DVDfunSTUDIO and DVD-MovieAlbum, licensed by Matsushita Electric Industrial Co., Ltd.

Important message

Before you write or rewrite to CD-R/RW or DVD-R/-RW disc, read and follow all set-up and operating instructions in this and the next section. If you fail to do so, the DVD-R/-RW drive may not function properly, and you may fail to write or rewrite, lose data or incur other damage.

NOTE: Also refer to the disc-writing instructions beginning on page 4-14 in the next section, Writing CD/DVDs on DVD Multi drive.

Disclaimer

TOSHIBA does not bear responsibility for the following:

- ❖ Damage to any CD-R/RW or DVD-R/-RW disc that may be caused by writing or rewriting with this product.
- ❖ Any change or loss of the recorded contents of CD-R/RW or DVD-R/-RW disc that may be caused by writing or rewriting with this product, or for any business profit loss or business interruption that may be caused by the change or loss of the recorded contents.
- ❖ Damage that may be caused by using third party equipment or software.

Given the technological limitations of current optical disc writing drives, you may experience unexpected writing or rewriting errors due to disc quality or problems with hardware devices. Also, it is a good idea to make two or more copies of important data, in case of undesired change or loss of the recorded contents.

Writing CD/DVDs on DVD Multi drive

You can use the DVD Multi drive to write data to either CD-R/RW or DVD-R/-RW/-RAM discs. The following applications for writing are supplied on CD-ROM: Drag'n Drop CD+DVD, licensed by Easy Systems Japan Ltd., and DigiOn Inc., MotionDV STUDIO, DVDfunSTUDIO and DVD-MovieAlbum, licensed by Matsushita Electric Industrial Co.,Ltd.

Important message

Before you write or rewrite to CD-R/RW or DVD-R/-RW/-RAM disc, read and follow all set-up and operating instructions in this section. If you fail to do so, the DVD Multi drive may not function properly, and you may fail to write or rewrite, lose data or incur other damage.

Disclaimer

TOSHIBA does not bear responsibility for the following:

- ❖ Damage to any CD-R/RW or DVD-R/-RW/-RAM disc that may be caused by writing or rewriting with this product.
- ❖ Any change or loss of the recorded contents of CD-R/RW or DVD-R/-RW/-RAM disc that may be caused by writing or rewriting with this product, or for any business profit loss or business interruption that may be caused by the change or loss of the recorded contents.
- ❖ Damage that may be caused by using third party equipment or software.

Given the technological limitations of current optical disc writing drives, you may experience unexpected writing or rewriting errors due to disc quality or problems with hardware devices. Also, it is a good idea to make two or more copies of important data, in case of undesired change or loss of the recorded contents.

Read/write function chart

Disc type	CD-R	CD-RW	DVD-R	DVD-RW	DVD-RAM	DVD+R	DVD+RW
Read	Yes	Yes	Yes	Yes	Yes	No	No
Write	Yes	Yes	Yes	Yes	*1	No	No
Drag'n Drop CD+DVD*2	Yes	Yes	Yes	Yes	No	No	No
DVDFunSTUDIO*2	No	No	Yes	Yes	No	No	No
DVD-MovieAlbum*2	No	No	No	No	Yes	No	No
DVD-Video*3	No	No	Yes	Yes	No	No	No
DVD VR*3 (DVD Video Recoding)	No	No	No	No	Yes	No	No

*1 DVD Multi Drive: Yes. DVD-R/-RW: No.

*2 Software supplied with the product can be used for writing to a disc.

*3 Video format can be written.

- ❖ Based on TOSHIBA's limited compatibility testing, we suggest the following manufacturers of CD-R/RW and DVD-R/-RW/-RAM disc. However, in no event does TOSHIBA guarantee the operation, quality or performance of any disc. Disc quality can affect write or rewrite success rates.

CD-R: TAIYOYUDEN CO., LTD.

Mitsui Chemicals Inc.

MITUBISHI CHEMICAL CORPORATION

RICOH Co., Ltd.

Hitachi Maxell Ltd.

CD-RW: MITUBISHI CHEMICAL CORPORATION

RICOH Co., Ltd.

DVD-R: **DVD Specifications for Recordable Disc for General Version 2.0**

TAIYOYUDEN CO., LTD.

PIONEER VIDEO CORPORATION

MITSUBISHI CHEMICAL CORPORATION

DVD-RW: **DVD Specifications for Re-recordable Disc for Version 1.1**

VICTOR COMPANY OF JAPAN, LIMITED

TDK Corporation

DVD-RAM: **DVD Specifications for DVD-RAM Disc for Version 2.0 or Version 2.1**

Matsushita Electric Industrial Co., Ltd.

- ❖ If the disc is poor in quality, dirty or damaged, writing or rewriting errors may occur. Be careful to check the disc for dirt or damage before you use it.
- ❖ The actual number of rewrites to CD-RW or DVD-RW/-RAM is affected by the quality of the disc and the way it is used.
- ❖ There are two types of DVD discs: authoring and general use discs. Do not use authoring discs. Only general use discs can be written to by a computer drive.
- ❖ You can use DVD-RAM discs that can be removed from a cartridge and DVD-RAM discs designed without a cartridge. You cannot use a disc with a 2.6 GB single-sided capacity or 5.2 GB double-sided capacity.
- ❖ Other DVD-ROM drives for computers or other DVD players may not be able to read DVD-R/-RW discs.

- ❖ You cannot add data to a DVD-R/-RW disc that has previously been written to.
- ❖ You cannot overwrite data that has been previously written to a DVD-RW disc.
- ❖ You cannot partially delete any data written to a DVD-RW disc.
- ❖ Data written to a CD-R/DVD-R disc cannot be deleted either in whole or in part.
- ❖ Data deleted (erase) from a CD-RW and DVD-RW/-RAM disc cannot be recovered. Check the content of the disc carefully before you delete it. If multiple drives that can write data to discs are connected, be careful not to delete data from the wrong drive.
- ❖ In writing to a DVD-R/-RW disc, some disc space is required for file management, so you may not be able to write the full capacity of the disc.
- ❖ Since the disc is based on the DVD standard, it will be filled with dummy data if the written data is less than about 1 GB. Even if you write only a small amount of data, it will take time to fill in the dummy data.
- ❖ Two types of DVD-R/-RW/-RAM discs are on the market: data and video. Use a video disc to store video data. You can use video discs on a DVD recorder as well as on your computer's DVD-ROM drive. You cannot use data discs on a DVD recorder.
- ❖ DVD-RAM formatted by FAT32 cannot be read in Windows 2000 without DVD-RAM Driver Software.

Before writing or rewriting

Please observe the following points when you write or rewrite data.

- ❖ When multiple drives that can write data to discs are connected, be careful not to write to the wrong drive.
- ❖ Be sure to connect the universal AC adaptor before you write or rewrite.
- ❖ Before you enter standby/hibernation mode, be sure to finish DVD-RAM writing. Writing is finished if you can eject DVD-RAM media.
- ❖ Be sure to close all other software programs except the writing software.
- ❖ Do not run software such as a screen saver, which can put a heavy load on the CPU.
- ❖ Operate the computer in the full-power mode. Do not use power-saving features.
- ❖ Do not write while virus check software is running. Wait for it to finish, then disable virus detection programs including any software that checks files automatically in the background.

- ❖ Do not use hard disk utilities, including those intended to enhance HDD access speed. They may cause unstable operation and data damage.
- ❖ Write from the computer's HDD to the CD/DVD. Do not try to write from shared devices such as a LAN server or any other network device.
- ❖ Writing with software other than Drag'n Drop CD+DVD, DVDfunSTUDIO and DVDMovieAlbum is not recommended.

When writing or rewriting

Please observe/consider the following when you write or rewrite to a CD-R/RW or DVD-R/-RW/-RAM disc.

- ❖ Do not perform any of the following actions when writing or rewriting:
 - Operate the computer for any other function, including using a mouse or Touch Pad or closing/opening the LCD panel.
 - Start a communication application such as a modem.
 - Apply impact or vibration to the computer.
 - Install, remove or connect external devices, including the following:
PC card, SD card, USB devices, external display, optical digital devices.
 - Use the Audio/Video control button to reproduce music or voice.
 - Open the DVD Multi drive
- ❖ Do not use standby/hibernation while writing or rewriting.
- ❖ Make sure writing or rewriting is completed before going into standby/hibernation. Writing is completed if you can open the DVD Multi drive tray.
- ❖ Set the computer on a level surface and avoid places subject to vibration such as airplanes, trains, or cars. Do not use an unstable surface such as a stand.
- ❖ Keep mobile phones and other wireless communication devices away from the computer.
- ❖ Always copy data from the HDD to the DVD-RAM. Do not use cut-and-paste. The original data will be lost if there is a write error.

Drag'n Drop CD+DVD

Note the following limitations when you use Drag'n Drop CD+DVD:

- ❖ DVD-Video cannot be created using Drag'n Drop CD+DVD.
- ❖ DVD-Audio cannot be created using Drag'n Drop CD+DVD.

- ❖ You cannot use Drag'n Drop CD+DVD's music CD function to record music to a DVD-R/-RW disc.
- ❖ Do not use the DISC Backup function of Drag'n Drop CD+DVD to copy DVD-Video and DVD-ROM with copyright protection, because the copy will not play correctly.
- ❖ DVD-RAM disc cannot be backed up with the DISC Backup function of Drag'n Drop CD+DVD.
- ❖ You cannot backup a CD-ROM or CD-R/RW to DVD-R/-RW using the DISC Backup function of Drag'n Drop CD+DVD.
- ❖ You cannot back up DVD-ROM, DVD-Video or DVD-R/-RW to CD-R/RW using the DISC Backup function of Drag'n Drop CD+DVD.
- ❖ Drag'n Drop CD+DVD cannot record in packet format.
- ❖ You might not be able to use the DISC backup function of Drag'n Drop CD+DVD to back up a DVD-R/-RW disc that was made with other software on a different DVD-R/-RW recorder.

Data verification

To verify that data is written or rewritten correctly, follow the steps below before you write or rewrite a Data CD/DVD.

1. Right-click **Data BOX** and select **Options** to display the **DATA DISC Option** window.
2. Mark the **Record and Verify** check box and select **Byte compare**.
3. Click the **OK** button.

The "Record and Verify" function automatically checks whether data has been correctly recorded onto a CD/DVD. "Byte compare" compares the original data file with the data recorded on the CD/DVD and checks that the data completely matches.

Video (DVD-R/-RW/-RAM)

Note the following limitations when you write video to DVD:

- ❖ When installing, uninstalling or MotionDV STUDIO, DVDfunSTUDIO or DVDMovieAlbum, the computer should be set to system administrator or equivalent privilege.
- ❖ Whether MotionDV STUDIO and DVD-MovieAlbum use NTSC or PAL format is determined when the application is installed. To change the format, you will have to reinstall MotionDV STUDIO and DVD-MovieAlbum.

- ❖ When Drag'n Drop or similar software is resident in the computer's memory, the DVD Multi drive locks. In this situation, other software cannot be used to write data to the disc.
- ❖ While you are editing DVD-R/-RW/-RAM, you can display previews. However, if an application other than WinDVD is running, the preview might not display properly. To ensure proper display of previews, do not start other applications while you are editing DVD-R/-RW/-RAM disc.
- ❖ Do not change the resolution or the number of screen colors while MotionDV STUDIO, DVDfunSTUDIO or DVD-MovieAlbum is running.
- ❖ Although the online manual and Help files indicate that JPEG files can be used, in fact, they cannot be used.
- ❖ 8cm (3.15") DVD-R/-RW discs cannot be use with DVDfunSTUDIO.
- ❖ DVDfunSTUDIO cannot make DVD-Audio, VideoCD, and miniDVD.
- ❖ DVD-R/-RW discs cannot be written in VR format.
- ❖ It may take several hours for DVDfunSTUDIO to convert video to MPEG format, and several hours more to save the MPEG file to a DVD Multi drive.
- ❖ In order to write to a DVD-RW disc that has already been written to using DVDfunSTUDIO, you will first have to delete all of the data with Drag'n Drop CD+DVD or similar software.
- ❖ You will need at least 20 GB of empty hard disk space to write to a DVD-R/-RW disc.
- ❖ You cannot record in DVD-Video format on a DVD-RAM disc.
- ❖ You will need to format a DVD-RAM for UDF 2.0 using a formatting tool, before you write to DVD-RAM using DVD-MovieAlbum.
- ❖ You cannot edit DVD-RAM video data that has copyright protection, using DVD-MovieAlbum.
- ❖ You can add PAL format images only to a PAL type DVD-RAM and NTSC format images only to an NTSC-type DVD-RAM.
- ❖ You cannot convert a PAL format DVD-RAM to NTSC format or an NTSC type DVD-RAM to PAL format.

Media care

This section provides tips on protecting data stored on your CD/DVDs and diskettes.

Handle your media with care. The following simple precautions will increase the lifetime of your media and protect the data stored on them:

CD/DVDs

1. Store your CD/DVDs in the container they came in to protect them and keep them clean.
2. Do not bend the CD/DVD.
3. Do not write on, apply a sticker to, or otherwise mar the surface of the CD/DVD that contains data.
4. Hold the CD/DVD by its outside edge or the edge on the center hole. Fingerprints on the surface can prevent the drive from properly reading data.
5. Do not expose to direct sunlight, extreme heat or cold. Do not place heavy objects on your CD/DVDs.
6. If your CD/DVDs become dusty or dirty, wipe them with a clean dry cloth. Wipe from the center out, do not wipe in a circular direction around the CD/DVD. If necessary, use a cloth dampened in water or a neutral cleaner. Do not use benzine, thinner or similar cleaner.

Diskettes

1. Store your diskettes in the container they came in to protect them and keep them clean. If a diskette is dirty, do not use cleaning fluid. Clean it with a soft damp cloth.
2. Do not slide back the diskette's protective metal covering or touch the diskette's magnetic surface. Fingerprints may prevent the diskette drive from reading data from the diskette.
3. Data may be lost if the diskette is twisted; bent; or exposed to direct sunlight, extreme heat or cold.
4. Do not place heavy objects on your diskettes.
5. Do not eat, smoke, or use erasers near your diskettes. Foreign particles inside the diskette's jacket can damage the magnetic surface.

6. Magnetic energy can destroy the data on your diskettes. Keep your diskettes away from speakers, radios, television sets and other sources of magnetic fields.

Modem

This section describes how to connect and disconnect the internal modem to and from a telephone jack.

***NOTE:** The internal modem does not support voice functions. All data and fax functions are supported.*

***CAUTIONS:** 1. In case of a lightning storm, unplug the modem cable from the telephone jack.*

2. Do not connect the modem to a digital telephone line. A digital line will damage the modem.

Region selection

Telecommunication regulations vary from one region to another, so you will need to make sure the internal modem's settings are correct for the region in which it will be used.

To select a region, follow the steps below.

1. Click **start**, point to **All Programs**, point to **TOSHIBA Internal Modem** and click **Region Select Utility**.

***NOTE:** Do not use the Country/Region Select function in the Modem setup utility in the Control Panel if the function is available. If you change the Country/Region in the Control Panel, the change may not take effect.*

2. The Region Selection icon will appear in the Windows Task Bar.



Figure 4-9 The Region Selection icon

3. Click the icon with the primary mouse button to display a list of regions that the modem supports. A sub menu for telephony location information will also be displayed. A check will appear next to the currently selected region and telephony location.
4. Select a region from the region menu or a telephony location from the sub-menu.
 - When you click a region it becomes the modem's region selection, and the New Location for telephony will be set automatically.
 - When you select a telephony location, the corresponding region is automatically selected and it becomes the modem's current region setting.

Properties menu

Click the icon with the secondary mouse button to display the following menu.

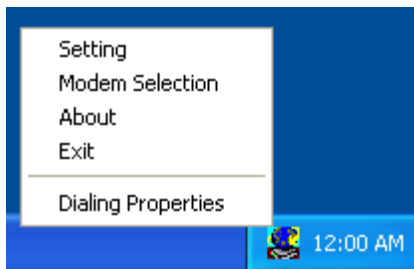

Figure 4-10 The menu list

Setting

You can enable or disable the following settings:

AutoRun Mode

The Region Select utility starts automatically when you start up the operating system.

Open the Dialing Properties dialog box after selecting region.

The dialing properties dialog box will be displayed automatically after you select the region.

Location list for region selection.

A submenu appears displaying location information for telephony.

Open dialog box, if the modem and Telephony Current Location region code do not match.

A warning dialog box is displayed if current settings for region code and telephony location are incorrect.

Modem Selection

If the computer cannot recognize the internal modem, a dialog box is displayed. Select the COM port for your modem to use.

Dialing Properties

Select this item to display the dialing properties.

CAUTION: *If you are using the computer in Japan, the Telecommunications Business Law requires that you select Japan region mode. It is illegal to use the modem in Japan with any other selection.*

Connecting

To connect the internal modem cable, follow the steps below.

1. Plug one end of the modular cable into the modem jack.
2. Plug the other end of the modular cable into a telephone jack.

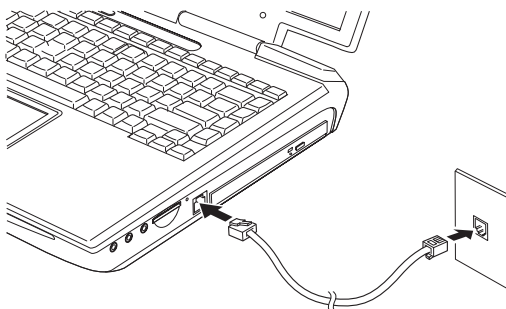

Figure 4-11 Connecting the internal modem

CAUTION: *Do not pull on the cable or move the computer while the cable is connected.*

NOTE: If you use a storage device such as a DVD-ROM drive, CD-RW/DVD-ROM drive or HDD connected to a 16-bit PC card, you might experience the following modem problems:

1. *Modem speed is slow or communication is interrupted.*
2. *Skips may occur in sound.*

Disconnecting

To disconnect the internal modem cable, follow the steps below.

1. Pinch the lever on the connector in the telephone jack and pull out the connector.
2. Disconnect the cable from the computer in the same manner.

Wireless LAN

The Wireless LAN is compatible with other LAN systems based on Direct Sequence Spread Spectrum/Orthogonal Frequency Division Multiplexing radio technology that complies with IEEE802.11 Wireless LAN standard (Revision A or B) and Turbo Mode.

Supported features

It supports the following features:

- ❖ Automatic Transmit Rate Select mechanism in the transmit range of 54, 48, 36, 24, 18, 12, 9 and 6 Mbit/s. (Revision A, Revision A/B combo type)
- ❖ Automatic Transmit Rate Select mechanism in the transmit range of 11, 5.5, 2 and 1 Mbit/s. (Revision B)
- ❖ Automatic Transmit Rate Select mechanism in the transmit range of 108, 96.72, 48, 36, 24, 18 and 12 Mbit/s. (Turbo Mode, Revision A/B combo type)
- ❖ Frequency Channel Selection (Revision A/Turbo Mode: 5 GHz, Revision B: 2.4 GHz)
- ❖ Roaming over multiple channels
- ❖ Card Power Management
- ❖ Wired Equivalent Privacy (WEP) data encryption, based on the 152 bit encryption algorithm. (Revision A/B combo type) Wired Equivalent Privacy (WEP) data encryption, based on the 128 bit encryption algorithm. (Revision B only type)

- ❖ Advanced Encryption Standard (AES) data encryption, based on 256 bit encryption algorithm. (Revision A/B combo type)

NOTE: Wake-up on LAN does not function on a Wireless LAN.

Security

- ❖ Be sure to enable the WEP (encryption) function to prevent unauthorized access to your Wireless LAN. Such access can enable illegal intrusion into data, eavesdropping and loss or destruction of data. TOSHIBA strongly recommends that you enable the WEP function.
- ❖ TOSHIBA is not liable for damage resulting from unauthorized access to a Wireless LAN including, but not limited to, illegal intrusion, eavesdropping and loss or destruction of data.

Wireless communication switch

You can enable or disable Wireless LAN function, with the on/off switch. No transmissions are sent or received when the switch is off. Slide the switch toward the back of the computer to turn it on and toward the front of the computer to turn it off.

CAUTION: Set the switch to off in airplanes and hospitals. Check the indicator. It will stop glowing when the wireless communication function is off.

Wireless communication indicator

The wireless communication indicator indicates the status of the wireless communication functions.

Indicator status	Indication
Indicator off	Wireless communication switch is set to off.
Indicator glows	Wireless communication switch is on. Wireless LAN is turned on by an application.

If you used the Task Bar to disable W-LAN, restart the computer or follow the procedures below to enable the system to recognize W-LAN. Open or click the following: **start, Control Panel, System, Hardware Device Manager, Network adapters, TOSHIBA Wireless LAN Mini PCI Card or Atheros AR5001X Mini PCI Wireless Network Adapter** and **enable**.

LAN

The computer has built-in support for Ethernet LAN (10 megabits per second, 10BASE-T) and Fast Ethernet LAN (100 megabits per second, 100BASE-Tx). This section describes how to connect/disconnect to a LAN.

- CAUTIONS:**
1. *Do not install or remove an optional memory module while Wake-up on LAN is enabled.*
 2. *Do not connect any cable other than a LAN cable to the LAN jack. It could cause damage or malfunction.*
 3. *Do not connect the LAN cable to a power supply. It could cause damage or malfunction.*

- NOTES:**
1. *The Wake-up on LAN function consumes power even when the system is off. Leave the universal AC adaptor connected while using this feature.*
 2. *When the Wake-up on LAN function is activated, the LAN indicators do not glow while the computer is in standby mode (while it is waiting for a LAN wake-up signal).*

Connecting LAN cable

CAUTION: *The computer must be configured properly before connecting to a LAN. Logging onto a LAN using the computer's default settings could cause a malfunction in LAN operation. Check with your LAN administrator regarding set-up procedures.*

If you are using Fast Ethernet LAN (100 megabits per second, 100BASE-TX), be sure to connect with a CAT5 cable. You cannot use a CAT3 cable.

If you are using Ethernet LAN (10 megabits per second, 10BASE-T), you can connect with either a CAT5 or a CAT3.

To connect the LAN cable, follow the steps below.

1. Turn off the power to the computer and to all external devices connected to the computer.

2. Plug one end of the cable into the LAN jack. Press gently until you hear the latch click into place.

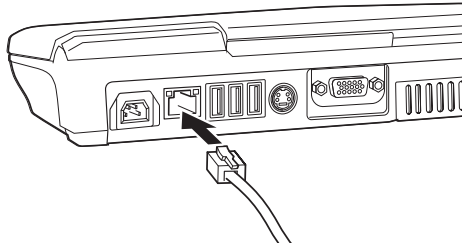

Figure 4-12 Connecting the LAN cable

3. Plug the other end of the cable into a LAN hub connector. Check with your LAN administrator before connecting to a hub.

NOTE: When the computer is exchanging data with the LAN, the **LAN Active** indicator glows orange. When the computer is connected to a LAN hub but is not exchanging data, the **Link** indicator glows green.

Disconnecting LAN cable

To disconnect the LAN cable, follow the steps below.

CAUTION: Make sure the **LAN Active** indicator (orange LED) is out before you disconnect the computer from the LAN.

1. Pinch the lever on the connector in the computer's LAN jack and pull out the connector.
2. Disconnect the cable from the LAN hub in the same manner. Check with your LAN administrator before disconnecting from the hub.

Cleaning the computer

To help ensure long, trouble-free operation, keep the computer free of dust and use care with liquids around the computer.

- ❖ Be careful not to spill liquids into the computer. If the computer does get wet, turn the power off immediately and let the computer dry completely before you turn it on again.
- ❖ Clean the computer using a slightly damp (with water) cloth. You can use glass cleaner on the display. Spray a small amount of cleaner on a soft, clean cloth and wipe the screen gently with the cloth.

***CAUTION:** Never spray cleaner directly onto the computer or let liquid run into any part of it. Never use harsh or caustic chemical products to clean the computer.*

- ❖ Remove dust from the air filter on the underside of the computer regularly with a vacuum cleaner. Refer to the *Underside* section in Chapter 2, *The Grand Tour*, for the location of the air filter.

Moving the computer

The computer is designed for rugged durability. However, a few simple precautions taken when moving the computer will help ensure trouble-free operation.

- ❖ Make sure all disk activity has ended before moving the computer. Check the **Disk** indicators on the computer.
- ❖ If a CD/DVD is in the drive, remove it. Also make sure the drawer is securely closed.
- ❖ Turn off the power to the computer.
- ❖ Disconnect the universal AC adaptor and all peripherals before moving the computer.
- ❖ Close the display. Do not pick up the computer by its display panel.
- ❖ Use the carrying case when transporting the computer.

Heat dispersal

To protect from overheating, the CPU has an internal temperature sensor. If the computer's internal temperature rises to a certain level, the cooling fan is turned on or the processing speed is lowered. You can select whether to control the CPU temperature by turning on the fan first, then if necessary, lowering the CPU speed. Or, by lowering the CPU speed first, then if necessary, turning on the fan. Use the *Cooling Method* item of the *Power Save Mode* window in TOSHIBA Power Saver.

- | | |
|----------------------------|---|
| Maximum Performance | Turn on the fan first, then if necessary, lower the CPU processing speed. |
| Performance | Use a combination of the fan and lowering the CPU processing speed. |
| Battery optimized | Lower the CPU processing speed first, then if necessary turn on the fan. |

When the CPU temperature falls to a normal range, the fan is turned off and the CPU operation returns to standard speed.

***NOTE:** If the CPU temperature reaches an unacceptably high level with either setting, the system automatically shuts down to prevent damage. Data in memory will be lost.*

The Keyboard

The computer's keyboard layouts are compatible with a 101/102-key enhanced keyboard. By pressing some keys in combination, all the 101/102-key keyboard functions can be executed on the computer.

The number of keys on your keyboard depends on which country/region's keyboard layout your computer is configured with. Keyboards for numerous languages are available.

There are five types of keys: typewriter keys, keypad overlay, function keys, soft keys and cursor control keys.

Typewriter keys

The typewriter keys, produce the upper- and lower-case letters, numbers, punctuation marks, and special symbols that appear on the screen.

There are some differences, however, between using a typewriter and using a computer keyboard:

- ❖ Letters and numbers produced in computer text vary in width. Spaces, which are created by a "space character," may also vary depending on line justification and other factors.
- ❖ The lowercase l (el) and the number 1 (one) are not interchangeable on computers as they are on a typewriter.
- ❖ The uppercase O (oh) and the 0 (zero) are not interchangeable.
- ❖ The **Caps Lock** function key locks only the alphabetic characters in uppercase while the shift lock on a typewriter places all keys in the shifted position.
- ❖ The **Shift** keys, the **Tab** key, and the **BkSp** (backspace) key perform the same function as their typewriter counterparts but also have special computer functions.

F1 ... F12 function keys

The function keys, not to be confused with **Fn**, are the 12 keys at the top of your keyboard. These keys function differently from other keys.



F1 through **F12** are called function keys because they execute programmed functions when pressed. Used in combination with the **Fn** key, keys marked with icons execute specific functions on the computer. See the section, *Soft keys: Fn key combinations*, in this chapter. The function executed by individual keys depends on the software you are using.

Soft keys: Fn key combinations

The **Fn** (function) is unique to TOSHIBA computers and is used in combination with other keys to form soft keys. Soft keys are key combinations that enable, disable or configure specific features.

NOTE: Some software may disable or interfere with soft-key operations. Soft-key settings are not restored by the Standby feature.

Emulating keys on enhanced keyboard

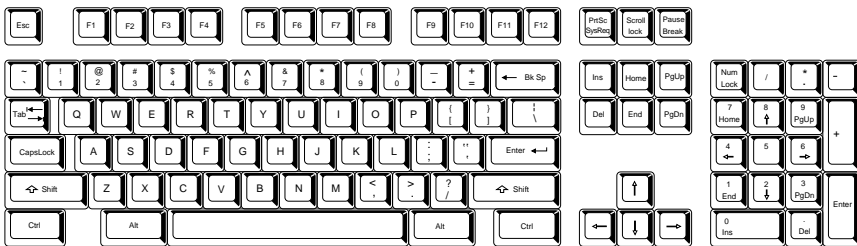
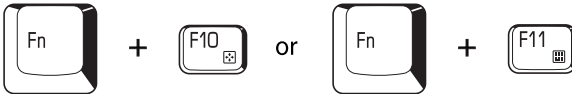

Figure 5-1 A 101-key enhanced keyboard layout

The keyboard is designed to provide all the features of the 101-key enhanced keyboard, shown in figure 5-1. The 101/102-key enhanced keyboard has a numeric keypad and scroll lock key. It also has additional **Enter** and **Ctrl** keys to the right of the main keyboard. Since the keyboard is smaller and has fewer keys, some of the enhanced keyboard functions must be simulated using two keys instead of one on the larger keyboard.

Your software may require you to use keys that the keyboard does not have. Pressing the **Fn** key and one of the following keys simulates the enhanced keyboard's functions.



Press **Fn + F10** or **Fn + F11** to access the integrated keypad. When activated, the keys with gray markings on the bottom edge become numeric keypad keys (**Fn + F11**) or cursor control keys (**Fn + F10**). Refer to the [Keypad overlay](#) section in this chapter for more information on how to operate these keys. The power on default for both settings is off.



Press **Fn + F12 (ScrLock)** to lock the cursor on a specific line. The power on default is off.



Press **Fn + Enter** to simulate **Enter** on the enhanced keyboard's numeric keypad.



Press **Fn + Ctrl** to simulate the enhanced keyboard's right **Ctrl** key.

Hot keys

Hot keys (**Fn** + a function or Esc key) let you enable or disable certain features of the computers.



Sound mute: Pressing **Fn + Esc** in a Windows environment turns sound on or off. When you press these hot keys, the current setting will change and be displayed as an icon.



Instant security: Press **Fn + F1** to blank the screen to prevent others from accessing your data. To restore the screen and original settings, press any key or press the Touch Pad. If a screensaver password is registered, a dialog box will appear. Enter the screensaver password and click **OK**. If no password is set, the screen will be restored when you press any key or press the Touch Pad.



Power save mode: Pressing **Fn + F2** changes the power save mode.

If you press **Fn + F2** in a Windows environment, the Power Save Mode is displayed in a dialog box similar to the one below. Continue holding down **Fn** and press **F2** again to change the setting. You can also change this setting through the *Plugged in or Running on batteries* item of the *Power Saver Properties* window in Power Saver.



Standby: When you press **Fn + F3**, the computer enters Standby. To avoid entering Standby unexpectedly, a dialog box appears for verification. However, if you select the check box, it will not appear in the future.



Hibernation: When you press **Fn + F4**, the computer enters Hibernation. To avoid entering Hibernation unexpectedly, a dialog box appears for verification. However, if you select the check box, it will not appear in the future.



Display selection: Press **Fn + F5** to change the active display device. When you press these hot keys, a dialog box appears. Only selectable devices will be displayed. Hold down **Fn** and press **F5** again to change the device. When you release **Fn** and **F5**, the selected device will change. If you hold down these hot keys for five seconds the selection will return to **LCD**.



LCD Display Brightness: Pressing **Fn + F6** decreases the display brightness in decrements. When you press these hot keys, the current setting will be displayed for two seconds by an icon. You can also change this setting through the *Monitor brightness* item of the *Power Save Mode* window in Power Saver.



LCD Display Brightness: Pressing **Fn + F7** increases the display brightness in increments. When you press these hot keys, the current setting will be displayed for two seconds by a pop-up icon. You can also change this setting through the *Monitor brightness* item of the *Power Save Mode* window in Power Saver.

- NOTES:**
1. *The brightness level is always set at the maximum value for about 18 seconds, when the LCD turns on. After 18 seconds, the brightness level will appear at the Power Save Mode setting or you can change it manually.*
 2. *Display clarity increases with the brightness level.*



Wireless setting: **Fn + F8** are not used.



Touch Pad: Pressing **Fn + F9** in a windows environment enables or disables the Touch Pad function. When you press these hot keys, the current setting will change and be displayed as an icon.

Fn Sticky key

You can use the TOSHIBA Accessibility Utility to make the **Fn** key sticky, that is, you can press it once, release it, and they press an “**F number**” key. To start the TOSHIBA Accessibility Utility, click **start**, point to **All Programs**, point to **TOSHIBA Utilities** and click **Accessibility**.

Windows special keys

The keyboard provides two keys that have special functions in Windows : one activates the **start** menu and the other has the same function as the secondary mouse button.



This key activates the Windows **start** menu.



This key has the same function as the secondary mouse button.

Keypad overlay

Your computer's keyboard does not have an independent numeric keypad, but its numeric keypad overlay functions like one.

The keys in the center of the keyboard with gray letters make up the numeric keypad overlay. The overlay provides the same functions as the numeric keypad on the 101/102-key enhanced keyboard in figure 5-2.

Turning on the overlays

The numeric keypad overlay can be used for numeric data input or cursor and page control.

Arrow mode

To turn on the Arrow mode, press **Fn + F10**. The Arrow mode **F10** indicator lights. Now try cursor and page control using the keys shown in figure 5-2. Press **Fn + F10** again to turn off the overlay.

Numeric mode

To turn on the Numeric mode, press **Fn + F11**. The Numeric mode **F11** indicator lights. Now try numeric data entry using the keys in figure 5-2. Press **Fn + F11** again to turn off the overlay.

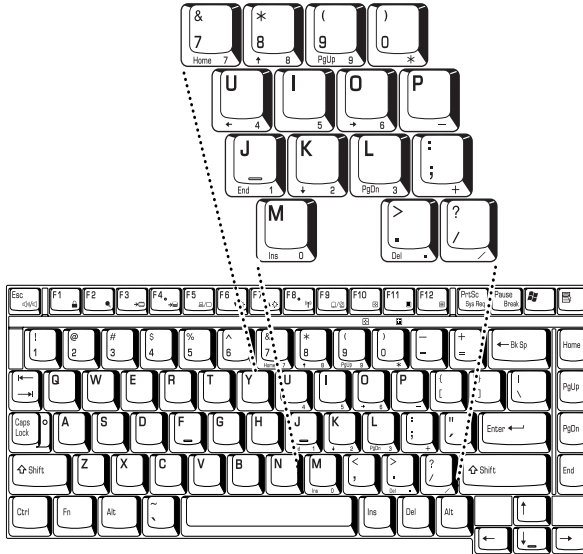

Figure 5-2 The numeric keypad overlay

Temporarily using normal keyboard (overlay on)

While using the overlay, you can temporarily access the normal keyboard without turning off the overlay:

1. Hold **Fn** and press any other key. All keys will operate as if the overlay were off.
2. Type upper-case characters by holding **Fn + Shift** and pressing a character key.
3. Release **Fn** to continue using the overlay.

Temporarily using overlay (overlay off)

While using the normal keyboard, you can temporarily use the keypad overlay without turning it on:

1. Press and hold down **Fn**.
2. Check the keyboard indicators. Pressing **Fn** turns on the most recently used overlay. If the Numeric mode indicator lights, you can use the overlay for numeric entry. If the Arrow mode indicator lights, you can use the overlay for cursor and page control.
3. Release **Fn** to return to normal keyboard operation.

Temporarily changing modes

If the computer is in **Numeric mode**, you can switch temporarily to **Arrow mode** by pressing a shift key.

If the computer is in **Arrow mode**, you can switch temporarily to **Numeric mode** by pressing a shift key.

Generating ASCII characters

Not all ASCII characters can be generated using normal keyboard operation. But, you can generate these characters using their ASCII codes.

With the overlay on:

1. Hold down **Alt**.
2. Using the overlay keys, type the ASCII code.
3. Release **Alt**, and the ASCII character appears on the display screen.

With the overlay off:

1. Hold down **Alt + Fn**.
2. Using the overlay keys, type the ASCII code.
3. Release **Alt + Fn**, and the ASCII character appears on the display screen.

Power

The computer's power resources include the universal AC adaptor and internal batteries. This chapter gives details on making the most effective use of these resources including charging and changing batteries, tips for saving battery power, and power up modes.

Power conditions

The computer's operating capability and battery charge status are affected by the power conditions: whether a universal AC adaptor is connected, whether a battery is installed and what the charge level is for the battery.

Table 6-1 Power conditions

		Power on	Power off (no operation)
Universal AC adaptor connected	Battery fully charged	<ul style="list-style-type: none"> Operates LED: Battery green DC IN green 	<ul style="list-style-type: none"> LED: Battery green DC IN green
	Battery partially charged or no charge	<ul style="list-style-type: none"> Operates Quick charge LED: Battery orange DC IN green 	<ul style="list-style-type: none"> Quick charge LED: Battery orange DC IN green
	No battery installed	<ul style="list-style-type: none"> Operates No charge LED: Battery off DC IN green 	<ul style="list-style-type: none"> No charge LED: Battery off DC IN green

Table 6-1 Power conditions continued

		Power on	Power off (no operation)
AC adaptor not connected	Battery charge is above low battery trigger point	<ul style="list-style-type: none"> Operates LED: Battery off DC IN off 	
	Battery charge is below low battery trigger point	<ul style="list-style-type: none"> Operates LED: Battery flashes orange DC IN off 	
	Battery charge is exhausted	Computer goes into resume mode shuts down	
	No battery installed	<ul style="list-style-type: none"> Cannot operate LED: Battery off DC IN off 	

Power indicators

As shown in the above table, the **Battery**, **DC IN** and **Power** indicators on the system indicator alert you to the computer's operating capability and battery charge status.

Battery indicator

Check the **Battery** indicator to determine the status of the battery pack. The following indicator lights indicate the battery status:

- Flashing orange The battery charge is low. The universal AC adaptor must be connected to recharge the battery.
- Orange Indicates the universal AC adaptor is connected and charging the battery.
- Green Indicates the universal AC adaptor is connected and the battery is fully charged.

No light Under any other conditions, the indicator does not light.

***NOTE:** If the battery becomes too hot while it is being charged, the charge will stop and the battery indicator will go out. When the battery's temperature falls to a normal range, charge will resume. This occurs whether the computer's power is on or off.*

DC IN indicator

Check the **DC IN** indicator to determine the power status with the universal AC adaptor connected:

- Green Indicates the universal AC adaptor is connected and supplying proper power to the computer.
- Flashing orange Indicates a problem with the power supply. Plug the universal AC adaptor into another outlet. If it still does not operate properly, see your dealer.
- No light Under any other conditions, the indicator does not light.

Power indicator

Check the **Power** indicator to determine the power status:

- Green Indicates power is being supplied to the computer and the computer is turned on.
- Blinking orange Indicates power is being supplied to the computer while the computer is in Standby mode. The indicator turns on for one second and off for two seconds.
- No light Under any other conditions, the indicator does not light.

Battery types

The computer has two types of batteries:

- ◆ Battery pack
- ◆ Real Time Clock (RTC) battery

Battery pack

When the universal AC adaptor is not connected, the computer's main power source is a removable lithium ion battery pack, also referred to in this manual as the battery pack. You can purchase additional battery packs for extended use of the computer away from an AC power source.

Before you remove the battery pack, set the computer to Hibernation mode or save your data and shut down the computer. Do not change the battery pack while the universal AC adaptor is connected.

- CAUTIONS:**
- 1. The battery pack is a lithium ion battery, which can explode if not properly replaced, used, handled or disposed of. Dispose of the battery as required by local ordinances or regulations. Use only batteries recommended by TOSHIBA as replacements.*
 - 2. Do not remove the battery pack while the computer is in Standby mode. Data is stored in RAM, so if the computer loses power it will be lost. When the computer is powered off in Standby mode, and the universal AC adaptor is not connected, the battery pack supplies power to maintain data and program in memory. If the battery pack is completely discharged, Standby mode does not function and the computer loses all data in memory.*

To ensure that the battery pack maintains its maximum capacity, operate the computer on battery power at least once a month until the battery pack is fully discharged. Refer to [Extending battery life](#) in this chapter for procedures. If the computer is continuously operated on AC power through a universal AC adaptor for an extended period, more than a month, the battery may fail to retain a charge. It may not function efficiently over the expected life of the battery and the **Battery** indicator may not indicate a low-battery condition.

Real Time Clock battery

The Real Time Clock (RTC) battery provides power for the internal real time clock and calendar. It also maintains the system configuration.

If the RTC battery becomes completely discharged, the system loses this data and the real time clock and calendar stop working. The following message appears when you turn on the power:

```
**** RTC battery is low or CMOS checksum is inconsistent ****  
Press [F1] key to set Date/Time.
```

CAUTION: *The computer's RTC battery is a lithium ion battery and should be replaced only by your dealer or by a TOSHIBA service representative. The battery can explode if not properly replaced, used, handled or disposed of. Dispose of the battery as required by local ordinances or regulations.*

Care and use of the battery pack

The battery pack is a vital component of portable computing. Taking proper care of it will help ensure longer operating time on battery power as well as a longer life for your battery pack. Follow the instructions in this section carefully to ensure safe operation and maximum performance.

Safety precautions

Mishandling of batteries can cause death, serious injury or property damage. Carefully observe the following advisories:

Danger: Indicates an imminently hazardous situation, which could result in death or serious injury, if you do not follow instructions.

Warning: Indicates a potentially hazardous situation, which could result in death or serious injury, if you do not follow instructions.

Caution: Indicates a potentially hazardous situation, which if not avoided, may result in moderate or minor injury or property damage.

Note: Provides important information.

Danger

1. Never try to dispose of the battery pack by burning or expose it to a heating device such as a microwave oven. The battery pack could explode and cause bodily injury.
2. Never try to disassemble, repair or otherwise tamper with a battery pack. The battery pack will overheat and ignite. Leakage of caustic alkaline solution or other electrolytic substances will cause fire or injury, possibly resulting in death or serious injury.
3. Never short-circuit the battery pack by contacting the terminals with a metal object. A short-circuit can cause fire or otherwise damage the battery pack and possibly cause injury. To avoid accidental short-circuit, always wrap the battery pack in plastic and cover the terminals with electrical tape when storing or disposing of the battery pack.
4. Never puncture the battery pack with a nail or other sharp object. Never strike it with a hammer or other object. Never step on it.
5. Never try to charge the battery pack in any manner other than that described in the user's manual. Never connect the battery pack to a plug socket or to a automobile's cigarette lighter socket. It may rupture or ignite.

6. Use only the battery pack supplied with the computer or other device or an battery pack approved by the computer or device's manufacturer. Battery packs have different voltages and terminal polarities. Use of an improper battery could cause smoke, fire or rupture of the battery pack.
7. Never subject a battery pack to heat, such as storage near a heat source. Exposure to heat can cause the battery pack to ignite, explode or leak caustic liquid and cause death or serious injury. It could also fail or malfunction causing data loss.
8. Never expose the battery pack to abnormal shock, vibration or pressure. The battery pack's internal protective device will fail, causing it to overheat, explode, ignite or leak caustic liquids possibly resulting in death or serious injury.
9. Never let a battery pack become wet. A wet battery pack will overheat, ignite or rupture possibly resulting in death or serious injury.

Warning

1. Never allow caustic electrolyte fluid leaked from a battery pack to contact your eyes, skin or clothing. If caustic electrolyte fluid should contact your eyes, immediately wash your eyes with large amounts of running water and seek medical attention, to help prevent eye damage. If electrolyte fluid should contact your skin immediately wash it under running water to prevent rash. If it contacts your clothes, promptly remove them to prevent the fluid from contacting your skin or eyes.
2. Immediately turn off the power, disconnect the universal AC adaptor and remove the battery if any of the following events are observed in the battery pack: offensive or unusual odor, excessive heat, discoloration or deformation. Never use the computer again until it has been checked by a TOSHIBA service provider. It might generate smoke or fire, or the battery pack might rupture.
3. Make sure the battery is securely installed in the computer before attempting to charge the battery pack. Improper installation could generate smoke or fire, or cause the battery pack to rupture.
4. Keep the battery pack out of reach of infants and children. It can cause injury.

Caution

1. Never continue to use a battery pack after its recharging capacity has become impaired, or after the display of a warning message indicating that the battery pack's power is exhausted. Continued use of an exhausted or impaired battery pack could cause the loss of data.
2. Never dispose of battery packs with normal trash. Bring them to your TOSHIBA dealer or to another recycling center to save resources and prevent environmental damage. Cover the terminals with electrical tape to prevent short-circuits, which could cause the battery pack to ignite or rupture.
3. Use only battery packs recommended by TOSHIBA as replacements.
4. Always make sure the battery pack is installed correctly and securely. Otherwise, a battery pack could fall out and possibly cause injury.
5. Charge the battery pack only in an ambient temperature between 5 and 35 degrees Celsius. Otherwise, the electrolyte solution might leak, battery pack performance might deteriorate and the battery life might be shortened.
6. Be sure to monitor the remaining battery power. If the battery pack and real time clock battery discharge completely, Standby and Suspend will not function and data in memory will be lost. Also, the computer might register an incorrect time and date. In this case, connect the universal AC adaptor to recharge the batteries.
7. Never install or remove the battery pack without first turning off the power and disconnecting the universal AC adaptor. Never remove the battery pack while the computer is in Suspend or Standby mode. Data will be lost.

Note

1. Never remove the battery pack while the Wake-up on LAN function is enabled. Data will be lost. Before you remove a battery pack, disable the Wake-up on LAN function.
2. To ensure the battery pack maintains maximum capacity, operate the computer on battery power once a week until the battery pack is fully discharged. Refer to the section *Extending battery life* in this chapter for procedures. If the computer is continuously operated on AC power for an extended period, more than a week, the battery might fail to retain a charge. It might not function efficiently over the expected life of the battery pack and the **Battery** indicator might not indicate a low-battery condition.
3. After the battery pack is charged, avoid leaving the universal AC adaptor connected and the computer turned off for more than a few hours at a time. Continuing to charge a fully-charged battery pack can damage the battery.

Charging the batteries

When the power in the battery pack becomes low, the **Battery** indicator flashes orange indicating that only a few minutes of battery power remain. If you continue to use the computer while the **Battery** indicator flashes, the computer enables Hibernation mode (so you don't lose data) and automatically turns off.

***NOTE:** The computer enters Hibernate mode only if Hibernation is enabled in two places in TOSHIBA Power Saver: the Hibernation window and the Battery Alarm item of the Alarm window.*

You must recharge a battery pack when it becomes discharged.

Procedures

To recharge a battery pack while it is installed in the computer, connect the universal AC adaptor to the **DC IN** socket and plug the other end into a working outlet.

The **Battery** indicator glows orange when the battery is being charged.

***CAUTION:** Use only the computer connected to an AC power source or the optional TOSHIBA Battery charger to charge the battery pack. Never attempt to charge the battery pack with any other charger.*

Time

The following table shows the approximate time required to fully charge a discharged battery.

Battery type	Charging time (hours)	
	Power on	Power off
Battery pack	3.5 to 12.5 or longer	about 3.5
RTC battery	8	Doesn't charge

***NOTE:** The charging time when the computer is on is affected by ambient temperature, the temperature of the computer and how you use the computer. If you make heavy use of external devices, for example, the battery might scarcely charge at all during operation. Refer also to the section [Maximizing battery operating time](#).*

Battery charging notice

The battery may not charge right away under the following conditions:

- ❖ The battery is extremely hot or cold. If the battery is extremely hot, it might not charge at all. To ensure the battery charges to its full capacity, charge the battery at room temperature of 10° to 30°C (50° to 88°F).
- ❖ The battery is nearly completely discharged. Leave the universal AC adaptor connected for a few minutes and the battery should begin charging.

The **Battery** indicator may show a rapid decrease in battery operating time when you try to charge a battery under the following conditions:

- ❖ The battery has not been used for a long time.
- ❖ The battery has completely discharged and been left in the computer for a long time.
- ❖ A cool battery is installed in a warm computer.

In such case, follow the steps below.

1. Fully discharge the battery by leaving it in the computer with the power on until the power automatically shuts off.
2. Plug in the universal AC adaptor.
3. Charge the battery until the **Battery** indicator glows green.

Repeat these steps two or three times until the battery recovers normal capacity.

***NOTE:** Leaving the universal AC adaptor connected will shorten battery life. At least once a month, run the computer on battery power until the battery is fully discharged, then recharge the battery.*

Monitoring battery capacity

Remaining battery power can be monitored in the *Power Save Modes* window in PowerSaver.

***NOTES:** 1. Wait at least 16 seconds after turning on the computer before trying to monitor the remaining operating time. The computer needs this time to check the battery's remaining capacity and to calculate the remaining operating time, based on the current power consumption rate and remaining battery capacity. The actual remaining operating time may differ slightly from the calculated time.*

2. *With repeated discharges and recharges, the battery's capacity will gradually decrease. Therefore, an often used, older battery will not operate for as long as a new battery even when both are fully charged. In this case, Power Save Modes window in TOSHIBA Power Saver will indicate a 100% charge for both the old and new battery, but the displayed estimated time remaining will be shorter for the older battery.*

Maximizing battery operating time

A battery's usefulness depends on how long it can supply power on a single charge.

How long the charge lasts in a battery depends on:

- ❖ How you configure the computer (for example, whether you enable battery-power saving options). The computer provides a battery save mode, which can be set in TOSHIBA Power Saver, to conserve battery power. This mode has the following options:
 - Processor speed
 - Monitor brightness
 - System standby
 - System hibernate
 - Turn off monitor
 - Turn off hard disks
- ❖ How often and how long you use the hard disk, CD/DVD-ROM and the diskette drive.
- ❖ How much charge the battery contained to begin with.
- ❖ How you use optional devices, such as a PC card, to which the battery supplies power.
- ❖ Enabling Standby mode conserves battery power if you are frequently turning the computer off and on.
- ❖ Where you store your programs and data.
- ❖ Closing the display when you are not using the keyboard saves power.
- ❖ Operating time decreases at low temperatures.
- ❖ The condition of the battery terminals. Make sure the battery terminals stay clean by wiping them with a clean dry cloth before installing the battery pack.

Retaining data with power off

When you turn off your computer with fully charged batteries, the batteries retain data for the following approximate time periods:

Battery pack	about 6 days (Standby mode) about 27 days (Boot mode)
RTC battery	1 month

Extending battery life

To maximize the life of your battery pack:

- ❖ At least once a month, disconnect the computer from a power source and operate it on battery power until the battery pack fully discharges. Before doing so, follow the steps below.
 1. Turn off the computer's power.
 2. Disconnect the universal AC adaptor and turn on the computer's power. If it does not turn on go to step 4.
 3. Operate the computer on battery power for five minutes. If the battery pack has at least five minutes of operating time, continue operating until the battery pack is fully discharged. If the **Battery** indicator flashes or there is some other warning to indicate a low battery, go to step 4.
 4. Connect the universal AC adaptor to the computer and the power cord to a power outlet. The **DC IN** indicator should glow green, and the **Battery** indicator should glow orange to indicate that the battery pack is being charged. If the **DC IN** indicator does not glow, power is not being supplied. Check the connections for the universal AC adaptor and power cord.
 5. Charge the battery pack until the **Battery** indicator glows green.
- ❖ If you have extra battery packs, rotate their use.
- ❖ If you will not be using the system for an extended period, more than one month, remove the battery pack.
- ❖ Disconnect the universal AC adaptor when the battery is fully charged. Overcharging makes the battery hot and shortens life.
- ❖ If you are not going to use the computer for more than eight hours, disconnect the universal AC adaptor.
- ❖ Store spare battery packs in a cool dry place out of direct sunlight.

Replacing the battery pack

When the battery pack reaches the end of its operating life you will need to install a new one. The life of the battery pack is generally about 500 recharges. If the **Battery** indicator flashes orange shortly after fully recharging the battery, the battery pack needs to be replaced.

You might also replace a discharged battery pack with a charged spare when you are operating your computer away from an AC power source. This section explains how to remove and install the battery pack.

Removing the battery pack

To replace a discharged battery, follow the steps below.

- CAUTIONS:**
- 1. When handling battery packs, be careful not to short circuit the terminals. Also do not drop, hit or otherwise apply impact; do not scratch or break the casing and do not twist or bend the battery pack.*
 - 2. Do not remove the battery pack while the computer is in Standby mode. Data is stored in RAM, so if the computer loses power it will be lost.*
 - 3. In Hibernation mode, data will be lost if you remove the battery or disconnect the universal AC adaptor before the save is completed. Wait for the **Disk** indicator to go out.*
 - 4. Do not touch the battery release latch while holding the computer. The battery might accidentally drop out causing damage to the battery or personal injury.*

1. Save your work.
2. Turn the computer's power off. Make sure the **Power** indicator is off.
3. Remove all cables connected to the computer.
4. Turn the computer upside down.

5. Slide the battery safety lock forward to free the battery release latch.
6. Slide the battery release latch to free the battery pack for removal, then slide out the battery pack.

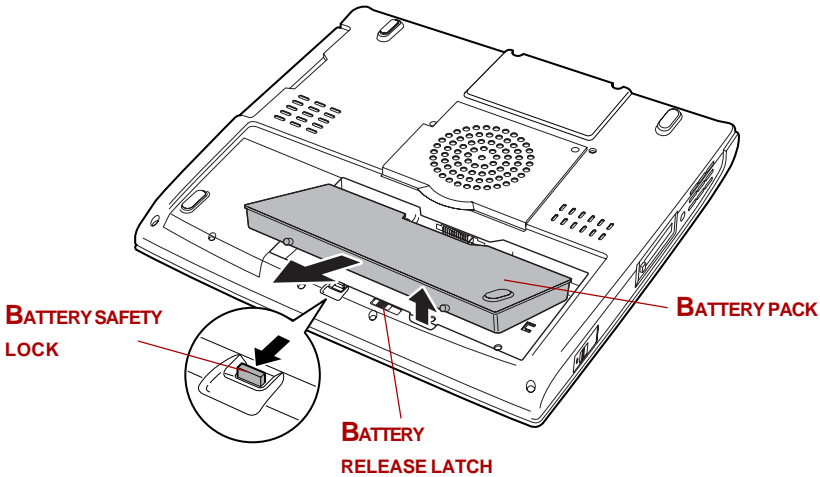

Figure 6-1 Releasing the battery pack

CAUTION: For environmental reasons, do not throw away a spent battery pack. Please return spent battery packs to your TOSHIBA dealer.

Installing the battery pack

To install a battery, follow the steps below.

- CAUTIONS:**
1. The battery pack is a lithium ion battery, which can explode if not properly replaced, used, handled or disposed of. Dispose of the battery as required by local ordinances or regulations. Use only batteries recommended by TOSHIBA as replacements.
 2. Do not touch the battery release latch while holding the computer. The battery might accidentally drop out causing damage to the battery or personal injury.

1. Turn the computer's power off.
2. Disconnect all cables connected to the computer.
3. Insert the battery pack.
4. Secure the battery safety lock.

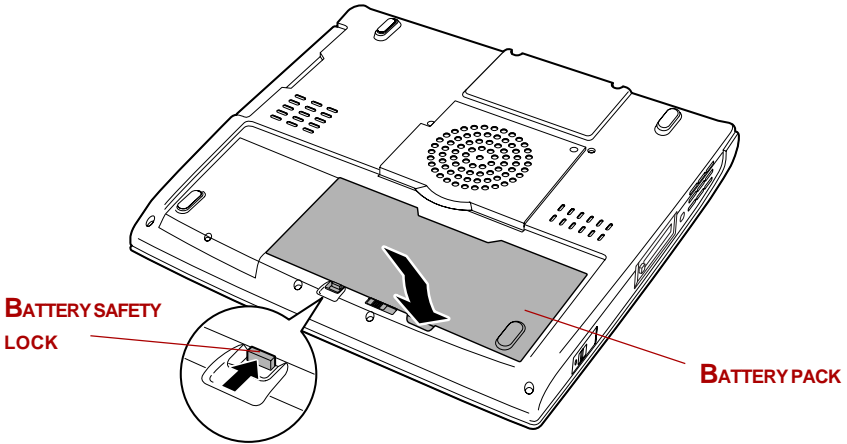

Figure 6-2 Securing the battery pack

Starting the computer by password

If you registered a user or supervisor password, you must enter it to start the computer. For information on setting a [user](#) or [supervisor password](#), refer to Chapter 7, *HW Setup and Passwords*.

To start the computer with the password, follow these steps:

1. Turn on the power as described in Chapter 3, *Getting Started*. The following message appears:

Password=

***NOTE:** At this point, the hot keys **Fn + F1** to **F5** do not work. They will function after you enter the password.*

2. Enter the Password.
3. Press **Enter**.

***NOTE:** If you enter the password incorrectly three times in a row, the computer shuts off. In this case, you must turn the computer back on to retry password entry.*

Power-up modes

The computer has the following power-up modes:

- ❖ **Boot:** Computer shuts down without saving data. Always save your work before you turn the computer off in boot mode.
- ❖ **Hibernation:** Data in memory is saved to the hard disk.
- ❖ **Standby:** Data is maintained in the computer's main memory.

***NOTE:** Refer also to the sections [Turning on the power](#) and [Turning off the power](#) in Chapter 3, *Getting Started*.*

Windows utilities

You can specify the setting in TOSHIBA Power Saver.

Hot keys

You can use hot keys **Fn + F3** to enter [Standby](#) mode and **Fn + F4** to enter [Hibernation](#). See Chapter 5, *The Keyboard*, for details.

Panel power on/off

You can set up your computer so that power turns off automatically when you close the display panel. When you open the panel, power turns on in Standby or Hibernation mode but not in boot mode.

***NOTE:** If the panel power off function is enabled and you use Shut down Windows, do not close the display until the shut down function is completed.*

System Auto Off

This feature turns the system off automatically if it is not used for a set duration. The system shuts down in Standby mode or Hibernation mode in Windows.

HW Setup and Passwords

This chapter explains how to use TOSHIBA HW Setup program to configure your computer and how to set passwords. TOSHIBA HW Setup lets you configure settings for General, Password, Device Config, Parallel/Printer, Display, Boot Priority, Keyboard, USB and LAN.

Accessing HW Setup

To run HW Setup, click **start**, click **Control Panel** and select **TOSHIBA HW Setup**.

HW Setup window

The HW Setup window contains the following tabs: General, Password, Device Config, Parallel/Printer, Display, BootPriority, Keyboard, USB and LAN.

There are also three buttons: **OK**, **Cancel** and **Apply**.

- OK** Accepts your changes and closes the HW Setup window.
- Cancel** Closes the window without accepting your changes.
- Apply** Accepts all your changes without closing the HW Setup window.

General

This window displays the BIOS version and contains two buttons: **Default** and **About**.

Setup

This field displays **BIOS Version** and date.

Default

Click **Default** to return all HW Setup values to the factory settings.

About

Click **About** to display the HW Setup version.

Password

User Password

This option allows you to set or reset the user password for power on.

- | | |
|-----------------------|---|
| Not Registered | Change or remove the password. (Default) |
| Registered | Set the password. A dialogue box will appear to let you set the password. |

To enter a user password:

1. Select **Registered** to display the following prompt:

Enter Password:

2. Enter a password of up to 10 characters. (You cannot use the following characters: - ^ @ [] ; : , . /space.) The character string you enter is displayed as a string of asterisks. For example, if you enter a password consisting of four characters, the display is shown as:

Enter Password: ****

***NOTE:** If you click the **OK** button before entering the password, **Not registered** will appear on the display.*

3. Click the **OK** button. The following message appears, allowing you to verify the password.

Verify Password:

4. If character strings match, the password is registered and the display changes to:

The password was registered

If they do not match, the following message appears. You must repeat from step 1.

Entry Error!!!

To delete a user password:

1. Select **Not Registered** to display the following prompt:

Enter Password:

2. Enter the currently registered password. The character string you enter is displayed as a string of asterisks.

Enter Password: ****

***NOTE:** If you click the **OK** button before entering the password, **Registered** will appear on the display.*

3. Click the **OK** button. If the character string you enter matches the registered password, the password option is reset and the display changes to:

The password was deleted

If they do not match, the following message appears. You must repeat step 1.

Incorrect Password

***NOTE:** If you enter the password incorrectly three times, the screen will display:*

Sorry, access denied!!! Powering off your machine then powering it back on again are required to regain access.

You will not be able to access the password option in the HW Setup. In this case you must turn the power off and back on to retry the procedure.

4. Follow the same procedures described in the earlier section, *How to set the password*, to set a new user password.

Refer to the *Supervisor password* section later in this chapter for details on setting the supervisor password.

Key FD

After you set a password, you can create a Key FD (diskette). If you forget the user password, the Key FD lets you bypass the password function.

NOTE: It is a good idea to create more than one Key FD in case a Key FD is damaged or lost.

To create a Key FD follow the steps below.

1. Turn off the computer's power.
2. Connect the diskette drive to a USB port on the computer.
3. Set a diskette's write-protect tab to the write enable position and insert the diskette in the drive.

NOTE: All data on the diskette will be destroyed.

4. Turn on the computer's power.
Password= will be displayed on the LCD.
5. Enter the password.
6. Press the Tab key.
Insert FD Ready (Y/N) will be displayed on the LCD.
7. Press Y.
Remove FD press key will be displayed on the LCD.
8. Remove the diskette and press any key.

Device Config

Device Configuration

This option lets you set the device configuration.

- All Devices** BIOS sets all devices.
- Setup by OS** Operating system sets devices that it can control. (Default)

Paralle/Printer

This tab lets you set the Parallel Port Mode. Use the Windows Device Manager to make settings for the Parallel port.

Parallel Port Mode

The options in this tab are **ECP** and **Standard Bi-directional**.

- ECP** Sets the port type to Extended Capabilities Port (ECP). For most printers, the port should be set to **ECP**. (Default)
- Standard Bi-directional** This setting should be used with some other parallel devices.

Display

This tab lets you customize your computer's display settings for either the internal LCD screen or for an external monitor.

Power On Display

Lets you set the display to be used when the computer is booted.

- Auto-Selected** Selects an external monitor if one is connected. Otherwise, it selects the internal LCD. (Default)
- LCD + AnalogRGB** Selects both the internal LCD and external monitor for simultaneous display.

Boot Priority

Boot Priority Options

This option sets the priority for booting the computer. Select from the following settings:

- | | |
|---------------------------------|---|
| HDD → FDD → CD-ROM → LAN | The computer looks for bootable files in the following order: HDD, diskette drive, CD-ROM* and LAN. (Default) |
| FDD → HDD → CD-ROM → LAN | The computer looks for bootable files in the following order: diskette drive, HDD, CD-ROM* and LAN. |
| HDD → CD-ROM → LAN → FDD | The computer looks for bootable files in the following order: HDD, CD-ROM*, LAN and diskette drive. |
| FDD → CD-ROM → LAN → HDD | The computer looks for bootable files in the following order: diskette drive, CD-ROM*, LAN and HDD. |
| CD-ROM → LAN → HDD → FDD | The computer looks for bootable files in the following order: CD-ROM*, LAN, HDD, diskette drive. |
| CD-ROM → LAN → FDD → HDD | The computer looks for bootable files in the following order: CD-ROM*, LAN, diskette drive and HDD. |

* In this computer, CD-ROM refers to any optical media drive.

To change the boot drive, follow the steps below.

1. Hold down **F12** and boot the computer.
2. The following menu will be displayed with the following icons: Built-in HDD, CD-ROM, FDD, Network (LAN), PC (ATA) card boot.



NOTE: A bar will appear only under the selected device.

3. Use the left/right cursor keys to highlight the boot device you want and press **Enter**.

- NOTES:**
1. *If a supervisor password is set, the menu above does not appear when you use the user password to start the computer.*
 2. *The selection method above does not change the boot priority settings in HW Setup.*
 3. *If you press a key other than one of those above or if the selected device is not installed, the system will boot according to the current setting in HW Setup.*
 4. *Support of PC (ATA) card boot is guaranteed only for TOSHIBA PC card HDDs.*
 5. *A PC (ATA) card takes the position of HDD in the Boot Priority Options list.*

HDD Priority Options

If a PC card HDD is installed along with the built-in HDD, this option lets you set the priority for HDD detection. If the first detected HDD has a boot command, the system will boot from the HDD.

Built-in HDD -> PC Card (Default)

HDDs are searched for a boot command in the following order: the built-in HDD and the PC card. (Default)

PC Card -> Built-in HDD

HDDs are searched for a boot command in the following order: the PC card and the built-in HDD.

NOTE: *If a boot command is not found on the first detected HDD, the system will not boot from the other HDD. It will search the next device in the boot priority for a boot command.*

Network Boot Protocol

This feature sets the protocol to remotely boot from the network when Wake-up on LAN is enabled.

- [PXE]** Sets PXE as the protocol. (Default)
- [RPL]** Sets RPL as the protocol.

***NOTE:** The Wake-up on LAN function consumes power even when the system is off. Leave the universal AC adaptor connected while using this feature.*

Keyboard

Wake-up on Keyboard

When this feature is enabled and the computer is in Standby mode, you can turn on the computer by pressing any key. It is effective only for the internal keyboard and only when the computer is in standby mode.

- Enabled** Enables the Wake-up on Keyboard.
- Disabled** Disables the Wake-up on Keyboard. (Default)

USB

USB KB/Mouse Legacy Emulation

Use this option to enable or disable USB KB/Mouse Legacy Emulation. If your operating system does not support USB, you can still use a USB mouse and keyboard by setting the **USB KB/Mouse Legacy Emulation** item to **Enabled**.

- Enabled** Enables the USB KB/Mouse Legacy Emulation. (Default)
- Disabled** Disables the USB KB/Mouse Legacy Emulation.

USB-FDD Legacy Emulation

Use this option to enable or disable USB-FDD Legacy Emulation.

- Enabled** Enables the USB-FDD Legacy Emulation. (Default)
- Disabled** Disables the USB-FDD Legacy Emulation.

LAN

Wake-up on LAN

This feature lets the computer's power be turned on when it receives a wake-up signal from the LAN.

- Enabled** Enables Wake-up on LAN.
- Disabled** Disables Wake-up on LAN. (Default)

***CAUTION:** Do not install or remove an optional memory module while Wake-up on LAN is enabled.*

***NOTE:** The Wake-up on LAN function consumes power even when the system is off. Leave the universal AC adaptor connected while using this feature.*

Built-in LAN

This feature enables or disables the Built-in LAN.

- Enabled** Enables Built-in LAN functions. (Default)
- Disabled** Disables Built-in LAN functions.

Supervisor password

If you set a supervisor password, some functions might be restricted when a user logs on with the user password. To set a supervisor password, execute the file TOSUP.EXE. The file is located at:

**C:\Program Files\Toshiba\Windows Utilities
\SVPWTool\TOSUP.EXE**

This utility lets you do the following:

- ◆ Register, delete or change the supervisor password.
- ◆ Specify restrictions for general users.

Optional Devices

Optional devices can expand the computer's capabilities and its versatility. This chapter describes connection or installation of the following devices, which are available from your TOSHIBA dealer:

Cards/memory

- ❖ PC cards
- ❖ SD cards
- ❖ Memory expansion

Power devices

- ❖ Battery pack (Black)
- ❖ Universal AC adaptor

Peripheral devices

- ❖ USB FDD kit
- ❖ External monitor
- ❖ TV
- ❖ Parallel printer

Other

- ❖ Security lock

PC cards

The computer is equipped with a PC card expansion slot that can accommodate one 5 mm Type II card. Any PC card that meets industry standards (manufactured by TOSHIBA or other vendor) can be installed. The slot supports 32-bit cards, including CardBus PC cards, which provide superior performance for the greater demands of multimedia. It also supports 16-bit PC cards, including PC card 16's multifunction card.

Inserting a PC card

The PC card connector is located on the left side of the computer.

Windows' hot-install feature lets you insert PC cards while the computer's power is on.

***NOTE:** Do not insert a PC card while the computer is in standby or hibernation mode. Some cards might not work properly.*

To insert a PC card, follow the steps below.

1. Insert the PC card.
2. Press gently to ensure a firm connection.

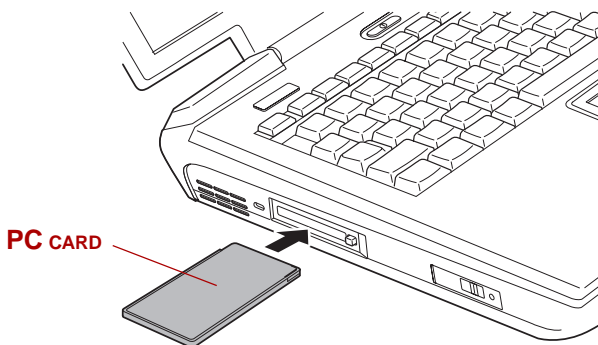

Figure 8-1 Inserting a PC card

After inserting the card, refer to the card's documentation and check the configuration in Windows to make sure it is appropriate for your card.

Removing a PC card

To remove the PC card, follow the steps below.

1. Click the **Safety Remove Hardware** icon on the Task Bar.
2. Click **PC card**.
3. Press the PC card eject button to extend it.
4. Press the extended eject button to pop the card out slightly.
5. Grasp the PC card and remove it.

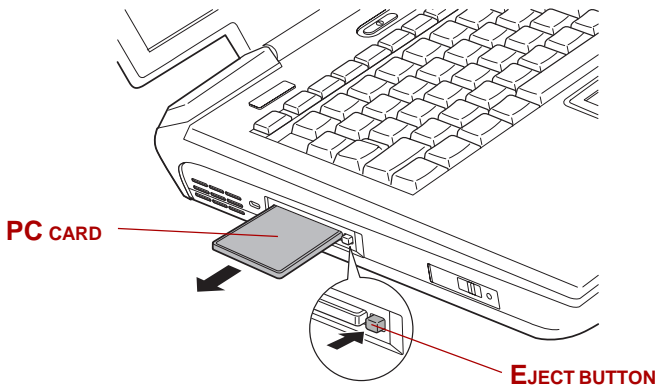

Figure 8-2 Removing a PC card

SD cards

The computer is equipped with an SD card slot that can accommodate Secure Digital flash memory cards with various memory capacities. SD cards let you easily transfer data from devices, such as digital cameras and Personal Digital Assistants, that use SD card flash-memory. The cards have a high level of security and copy protection features. The slot cannot accommodate MultiMedia cards.

CAUTION: Keep foreign objects out of the SD card slot. A pin or similar object can damage the computer's circuitry.

NOTE: SD memory cards comply with SDMI (Secure Digital Music Initiative), which is a technology adopted to prevent unlawful copy or playback of digital music. For this reason, you cannot copy or playback protected material on another computer or other device. You may not use the reproduction of any copyrighted material except for your personal enjoyment.

Inserting an SD card

To insert an SD card, follow the steps below.

1. Insert the SD card.
2. Press it gently to ensure a firm connection.

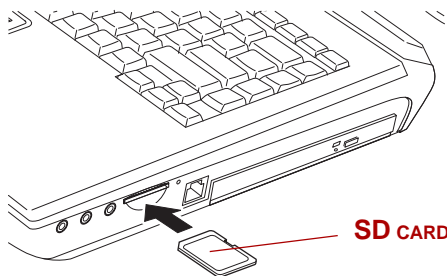

Figure 8-3 Inserting an SD card

CAUTION: Make sure the SD card is oriented properly before you insert it.

Removing an SD card

To remove an SD card, follow the steps below.

1. Click the **Safety Remove Hardware** icon on the Task Bar.
2. Point to **SD card** and click.
3. Push in the card and release it to pop the card out slightly.
4. Grasp the card and remove it.

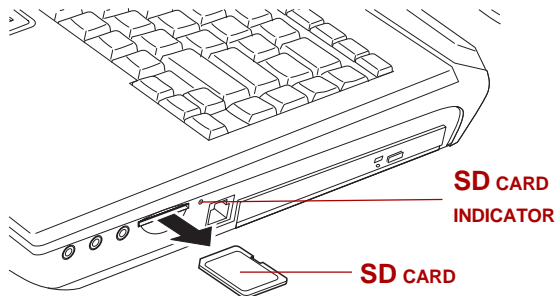

Figure 8-4 Removing an SD card

- CAUTIONS:**
1. Make sure the **SD card** indicator is out before you remove the card or turn off the computer's power. If you remove the card or turn off the power while the computer is accessing the card you may lose data or damage the card.
 2. Do not remove an SD card while the computer is in Standby or Hibernation mode. The computer could become unstable or data in the SD card could be lost.

SD card care

CAUTION: Set the write-protect switch to the lock position, if you do not want to record data.

1. Do not write to an SD card if the battery power is low. Low power could affect writing accuracy.
2. Do not remove an SD card while read/write is in progress.
3. The SD card is designed so that it can be inserted only one way. Do not try to force the card into the slot.

4. Do not leave an SD card partially inserted in the slot. Press the SD card until you hear it click into place.
5. Do not twist or bend SD cards.
6. Do not expose SD cards to liquids or store in humid areas or lay them close to containers of liquid.
7. After using an SD card, return it to its case.
8. Do not touch the metal part or expose it to liquids or let it get dirty.

Memory expansion

You can install additional memory in the computer's memory socket to increase the amount of RAM. This section describes how to install and remove a memory module.

- CAUTIONS:**
1. *Use only memory modules approved by TOSHIBA.*
 2. *Do not try to install or remove a memory module under the following conditions. You can damage the computer and the module. Also, data will be lost.*
 - a. *The computer is turned on.*
 - b. *The computer was shut down using Standby mode or Hibernation mode.*
 - c. *Wake-up on LAN is enabled.*
 3. *Some memory modules can be physically installed but are not compatible with the computer. In this case, the computer will issue a warning. A beep will sound when you turn on the power.*

If the module is installed in slot A, there will be a long beep followed by a short beep. If the module is installed in slot B, there will be a long beep followed by two short beeps. In this case, shut down the power and remove the incompatible module.

NOTE: *Use a 0-bit, Phillips screwdriver to remove and fasten screws. Use of an incorrect screwdriver can damage the screw heads.*

Installing memory module

Follow the steps below to install a memory module.

1. Set the computer to boot mode and turn the computer's power off. Make sure the **Power** indicator is off.
2. Remove universal AC adaptor and all cables connected to the computer.
3. Turn the computer upside down and remove the battery pack. Refer to *Replacing the battery pack* section in Chapter 6, *Power*, for details.
4. Turn the computer right side up and open the display panel. Tilt the display panel slightly beyond the upright position before removing the keyboard display.
5. Slip your fingernails under two notches on the keyboard brace and pull off the keyboard brace in the direction indicated by the arrows.

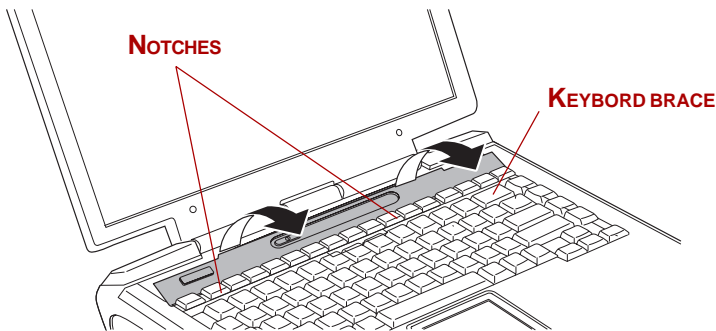

Figure 8-5 Removing the keyboard brace

6. Remove three screws securing the keyboard. The center screw also secures a metal brace.

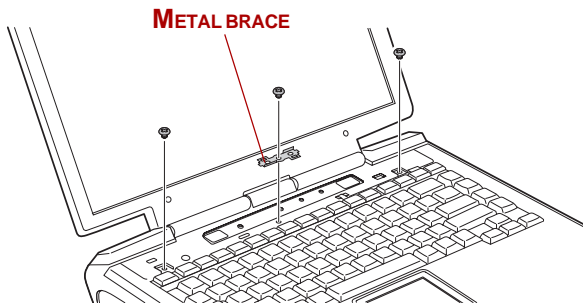

Figure 8-6 Removing three screws

CAUTION: Be careful not to drop any of the screws inside the computer.

7. Lift up the back edge of the keyboard and rotate it out.

CAUTION: Be careful not to apply tension to the flat cable connected to the keyboard.

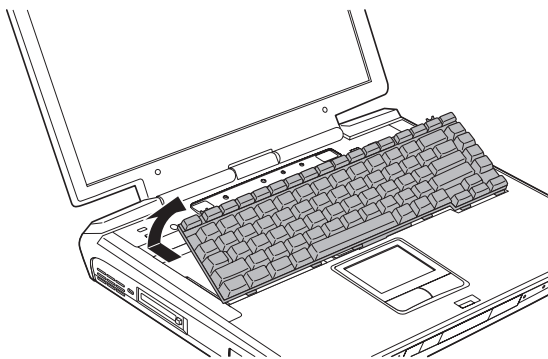

Figure 8-7 Rotating out the keyboard

8. Lay the keyboard upside down on the palm rest.

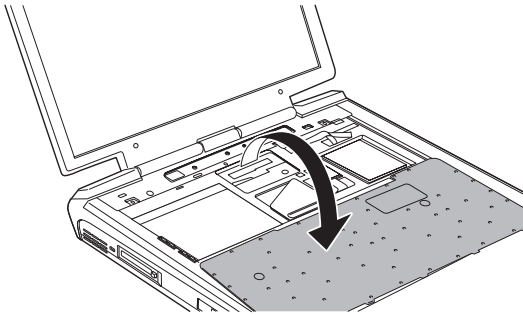

Figure 8-8 Laying the keyboard on the palm rest

9. Lift back the insulation sheet covering the memory module and secure the sheet with tape to keep it out of your way.

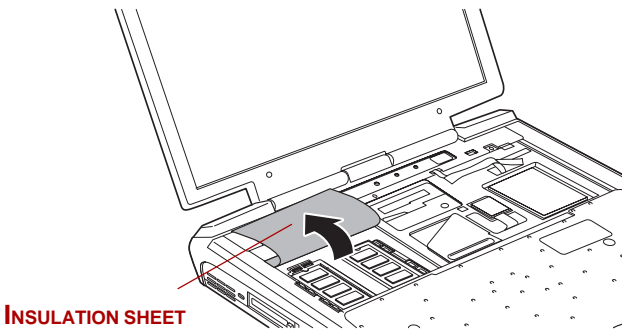

Figure 8-9 Lifting back the insulation sheet

CAUTION: Do not touch the connectors on the memory module or on the computer. Debris on the connectors may cause memory access problems.

10. Insert a new module in the socket and push it down so it lies flat. Latches on either side will click into place to secure the module.

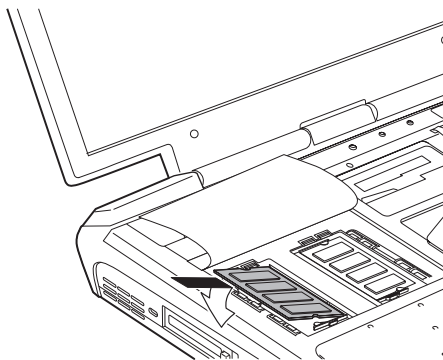

Figure 8-10 Installing one memory module

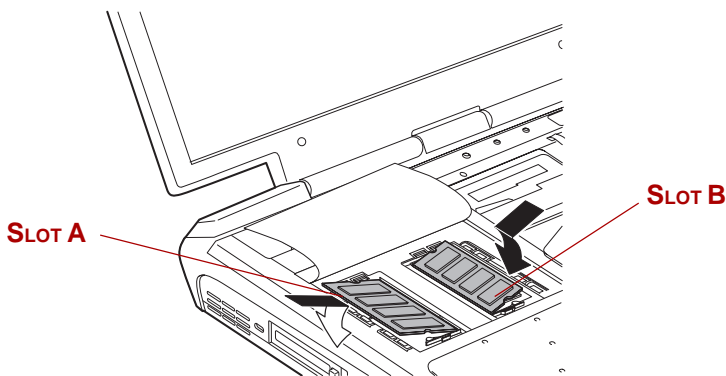

Figure 8-11 Installing two memory modules

11. Seat the insulation sheet to cover the module.

NOTE: Be sure to check that the insulation sheet is returned to the original position to cover the memory module.

12. Insert tabs on the front of the keyboard into corresponding notches on the computer and seat the keyboard.

***CAUTION:** When seating the keyboard, be sure to fit the flexible printed circuit board under the palm rest if the flat cable was pulled out while you were removing the keyboard.*

13. Three screws secure the keyboard and a metal brace. Seat the brace over the middle screw hole and secure the three screws.

***CAUTION:** Be sure to use all three screws removed in step 6. Make sure no screw was dropped into the computer. Make sure all foreign matter, such as the tape applied in step 9 is removed.*

14. Seat the keyboard brace and press to secure latches.
15. Install the battery pack. Refer to [Replacing the battery pack](#) section in Chapter 6, *Power*, for details.
16. Turn the power on and make sure the added memory is recognized. Open **System Properties** in the Control Panel and click the **General** tab.

Removing memory module

To remove the memory module, make sure the computer is in boot mode then:

1. Be sure the power is off and all cables are disconnected from the computer.
2. Turn the computer upside down and remove the battery.
3. Follow steps 4 through 9 in *Installing memory module* to access the memory module.

4. Push the latches to the outside to release the module. A spring will force one end of the module up.
5. Grasp the module by the sides and pull it out.

CAUTIONS:

1. *If you use the computer for a long time, the memory modules and the circuits locating close to the memory modules will become hot. In this case, let them cool to room temperature before you replace them. Or you will get burnt if you touch any of them.*
2. *Do not touch the connectors on the memory module or on the computer. Debris on the connectors may cause memory access problems.*

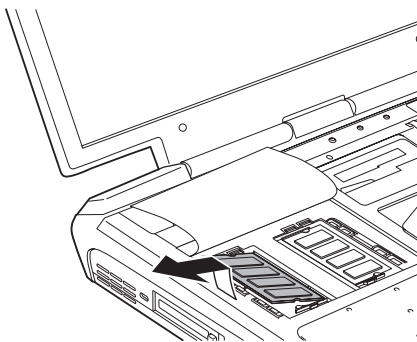

Figure 8-12 Removing the memory module

6. Follow steps 11 through 15 in *Installing memory module*.

Battery pack (Black)

You can increase the portability of the computer with additional battery packs. If you're away from an AC power source and your battery runs low, you can replace it with a freshly charged battery. See Chapter 6, *Power*.

Universal AC adaptor

If you frequently transport the computer between different sites such as your home and office, purchasing a universal AC adaptor for each location will reduce the weight and bulk of your carrying load.

USB FDD kit

The 3 1/2" external diskette drive module can be connected to the USB port. For details on connecting the 3 1/2" external diskette drive module, refer to Chapter 4, *Operating Basics*.

External monitor

An external analog monitor can be connected to the external monitor port on the computer. The computer supports VGA and Super VGA video modes. To connect a monitor, follow the steps below.

1. Turn the computer off.
2. Connect the monitor to the external monitor port.
3. Turn the monitor's power on.
4. Turn the computer on.

When you turn on the power, the computer automatically recognizes the monitor and determines whether it is color or monochrome.

To change the display settings, press **Fn + F5**. If you disconnect the monitor before you turn the computer off, be sure to press **Fn + F5** to switch to the internal display. Refer to Chapter 5, *The Keyboard*, for details on using hot keys to change the display setting.

TV

You can connect a television set to the TV out port on the computer. Follow the steps below.

Connecting a TV

1. Turn the computer off.
2. Use a video cable (not supplied) to connect the TV adaptor cable's mini-jack to the TV out port on the computer.
3. Connect the TV adaptor cable's RCA jack to the RCA jack on the TV.
4. Turn the television on.
5. Turn the computer on.

You can use the hotkeys **Fn + F5** to change the display device. Refer to Chapter 5, *The Keyboard*.

NOTE: *If a television is connected to the computer, set the TV type in Display Properties. Follow the steps below.*

- a. Click **start** and click **Control Panel**.
- b. Double-click the **Display** icon to open the Display Properties window.
- c. Click the **Settings** tab and click the **Advanced** button.
- d. Click the **nView Display Mode** tab, click **Device Settings** and click **Select Output Device**.
- e. Select **Advanced** and select **TV** in the **Device Selection** window.
- f. Select the **Format** box and select the format that your TV supports.

Changing the resolution

After you connect a TV (NTSC), follow the steps below to set the Display resolution to 640 x 480.

1. Open **Display properties** and select the **Settings** tab.

2. Select **Advanced**.

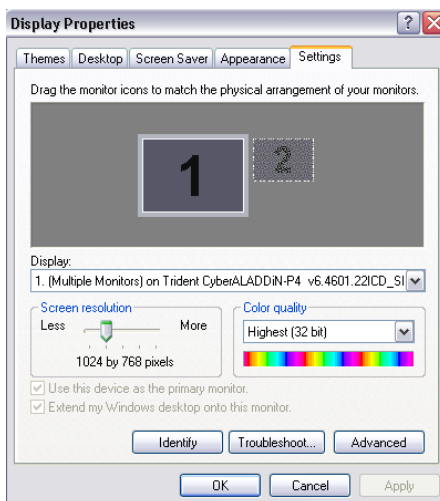

Figure 8-13 Display properties

3. Select the **Adapter** tab, then select **List All Modes....**

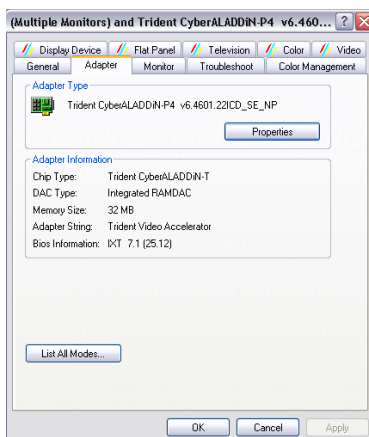

Figure 8-14 The Adapter window

4. Select **640 by 480, High Color (16 bit), 60 Hertz**.

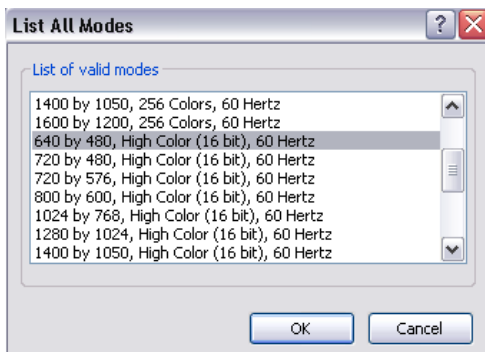

Figure 8-15 Resolution menu

Parallel printer

You can connect any standard Centronics-compatible parallel printer to your computer. All you need is an IBM PC™ parallel printer cable. Your dealer can supply one or you can purchase one at most computer stores.

The cable's connectors are designed so that it is impossible for you to connect them incorrectly. To connect a printer, follow these steps:

1. Turn off the computer.
2. Insert one end of the cable into the computer's parallel port.
3. Tighten the screws that fasten the cable connector to the computer's parallel port.
4. Insert the other end of the cable into the printer's parallel connector.
5. Fasten the connector to the printer with the clips on the parallel port.
6. Turn on the printer.
7. Turn on the computer.
8. Start the HW Setup program. Refer to Chapter 7, *HW Setup and Passwords*.
9. Select the **Parallel/Printer** tab from the **TOSHIBA HW Setup** window.
10. Set the **Parallel Port Mode** and press **OK**.
11. Choose **Reboot** for the change to take effect.

12. Select the printer in Windows Add Print Wizard. To access the **Add Print Wizard** utility, click **Start**, point to **Settings**, click **Printers** and double click the **Add Printer** icon.

Security lock

A security lock enables you to anchor your computer to a desk or other heavy object to help prevent unauthorized removal of the computer.

Attach one end of a cable to the desk and the other end to the security lock slot on the right side of the computer.

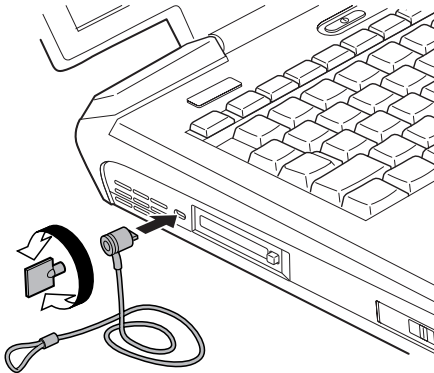

Figure 8-16 Security lock

Troubleshooting

TOSHIBA designed the computer for durability. However, should problems occur, following the procedures in this chapter can help to determine the cause.

All readers should become familiar with this chapter. Knowing what might go wrong can help prevent problems from occurring.

Problem solving process

Resolving problems will be much easier if you observe the following guidelines:

- ❖ Stop immediately when you recognize a problem exists. Further action may result in data loss or damage. You may destroy valuable problem-related information that can help solve the problem.
- ❖ Observe what is happening. Write down what the system is doing and what actions you performed immediately before the problem occurred. If you have a printer attached, print a copy of the screen using **PrtSc SysReq**.

The questions and procedures offered in this chapter are meant as a guide, they are not definitive problem solving techniques. Many problems can be solved simply, but a few may require help from your dealer. If you find you need to consult your dealer or others, be prepared to describe the problem in as much detail as possible.

Preliminary checklist

Consider the simplest solution first. The items in this checklist are easy to fix and yet can cause what appears to be a serious problem.

- ❖ Make sure you turn on all peripheral devices before you turn on the computer. This includes your printer and any other external device you are using.
- ❖ Before you attach an external device, turn the computer off. When you turn the computer back on it recognizes the new device.
- ❖ Make sure all options are set properly in the setup program.
- ❖ Check all cables. Are they correctly and firmly attached? Loose cables can cause signal errors.
- ❖ Inspect all connecting cables for loose wires and all connectors for loose pins.

- ❖ Check that your diskette or CD/DVD-ROM is correctly inserted and that the diskette's write protect tab is correctly set.

Make notes of your observations and keep them in a permanent error log. This will help you describe your problems to your dealer. If a problem recurs, the log will help you identify the problem faster.

Analyzing the problem

Sometimes the system gives clues that can help you identify why it is malfunctioning. Keep the following questions in mind:

- ❖ Which part of the system is not operating properly: keyboard, diskette drives, hard disk drive, optical media drive, display. Each device produces different symptoms.
- ❖ Is the operating system configuration set properly? Check the configuration options.
- ❖ What appears on the display screen? Does it display any messages or random characters? Print a copy of the screen if you have a printer attached. Look up the messages in the software and operating system documentation. Check that all connecting cables are correctly and firmly attached. Loose cables can cause erroneous or intermittent signals.
- ❖ Do any indicators light? Which ones? What color are they? Do they stay on or blink? Write down what you see.
- ❖ Do you hear any beeps? How many? Are they long or short? Are they high pitched or low? Is the computer making any unusual noises? Write down what you hear.

Record your observations so you can describe them to your dealer.

Software The problems may be caused by your software or disk. If you cannot load a software package, the media may be damaged or the program might be corrupted. Try loading another copy of the software.

If an error message appears while you are using a software package, check the software documentation. These documents usually include a problem solving section or a summary of error messages.

Next, check any error messages in the OS documentation.

Hardware If you cannot find a software problem, check your hardware. First run through the items in the preliminary checklist above. If you still cannot correct the problem, try to identify the source. The next section provides checklists for individual components and peripherals.

Hardware and system checklist

This section discusses problems caused by your computer's hardware or attached peripherals. Basic problems may occur in the following areas:

- ◆ System start-up
- ◆ Self test
- ◆ Power
- ◆ Password
- ◆ Keyboard
- ◆ LCD panel
- ◆ Hard disk drive
- ◆ CD-RW/DVD-ROM drive
- ◆ DVD-R/-RW drive
- ◆ DVD Multi drive
- ◆ Diskette drive
- ◆ SD card
- ◆ PC card
- ◆ Infrared port
- ◆ Pointing device
- ◆ USB
- ◆ Memory expansion
- ◆ Sound system
- ◆ Monitor
- ◆ Modem
- ◆ LAN
- ◆ Wireless LAN
- ◆ TV output signal
- ◆ Printer

System start-up

When the computer does not start properly, check the following items:

- ◆ Self Test
- ◆ Power Sources
- ◆ Power-on Password

Self test

When the computer starts up, the self test will be run automatically, and the following will be displayed:

**In Touch with Tomorrow
TOSHIBA**

This message remains on the screen for a few seconds.

If the self test is successful, the computer tries to load the operating system. Depending on how the Boot Priority is set in the TOSHIBA HW Setup program.

If any of the following conditions are present, the self test failed:

- ❖ The computer stops and does not proceed to display information or messages except the TOSHIBA logo.
- ❖ Random characters appear on the screen, and the system does not function normally.
- ❖ The screen displays an error message.

Turn off the computer and check all cable connections as well as PC card and memory module connections. If the test fails again, contact your dealer.

Power

When the computer is not plugged into an AC outlet, the battery pack is the primary power source. However, your computer has a number of other power resources, including intelligent power supply, Real Time Clock battery. These resources are interrelated and any one could affect apparent power problems. This section provides check lists for AC power and the battery. If you cannot resolve a problem after following them, the cause could lie with another power resource. In such case, contact your dealer.

Overheating power down

If the computer's internal temperature becomes too high, the computer will automatically shut down.

Problem	Procedure
Computer shuts down and DC IN indicator flashes orange	Leave the computer off until the computer reaches room temperature, then turn it back on. If the computer is still too warm, the DC IN indicator will continue blinking when you turn on the power. Let it cool longer and try again. If the computer has reached room temperature and still does not start, or if it starts but shuts down quickly, contact your dealer.

AC power

If you have trouble turning on the computer with the universal AC adaptor connected, check the **DC IN** indicator. Refer to Chapter 6, *Power*, for more information.

Problem	Procedure
Universal AC adaptor doesn't power the computer (DC IN indicator does not glow green)	Check the connections. Make sure the cord is firmly connected to the computer and a power outlet. Check the condition of the cord and terminals. If the cord is frayed or damaged, replace it. If the terminals are soiled, wipe them with cotton or a clean cloth. If the universal AC adaptor still does not power the computer, contact your dealer.

Battery

If you suspect a problem with the battery, check the **DC IN** indicator as well as the **Battery** indicator. For information on indicators and battery operation see Chapter 6, *Power*.

Problem	Procedure
Battery doesn't power the computer	The battery may be discharged. Connect the universal AC adaptor to charge the battery.
Battery doesn't charge when the universal AC adaptor is attached (Battery indicator does not glow orange.)	<p>If the battery is completely discharged, it will not begin charging at once. Wait a few minutes.</p> <p>If the battery still does not charge, make sure the outlet is supplying power. Plug in an appliance and see if it works. If it doesn't, try another power source.</p> <p>Check whether the battery is hot or cold. If the battery is too hot or too cold, it will not charge properly. Let it reach room temperature.</p> <p>Unplug the universal AC adaptor and remove the battery to make sure the terminals are clean. If necessary wipe them with a soft dry cloth dipped in alcohol.</p> <p>Connect the universal AC adaptor and replace the battery.</p> <p>Make sure the battery is securely seated.</p> <p>If the indicator still does not glow, the battery may be at the end of its operating life. Replace it.</p> <p>If you do not think the battery is at the end of its operating life, see your dealer.</p>

Battery doesn't power the computer as long as expected	Check the power consumption settings in TOSHIBA Power Saver Utility. Consider using a power saving mode.
--	--

RTC Battery

Problem	Procedure
---------	-----------

The following message is displayed:

```
RTC battery is low or CMOS checksum is inconsistent
Press [F1] key to set Date/Time.
```

The RTC battery is discharged	<ol style="list-style-type: none">1. Press F1 to start the BIOS setup.2. Set the system date.3. Set the system time.4. Press End to exit the program.5. When a confirmation dialog box appears, make sure your settings are correct and press Y.6. Restart the computer.
-------------------------------	--

Password

For information on setting and using a password, refer to Chapter 7, *HW Setup and Passwords*.

Problem	Procedure
---------	-----------

Cannot enter or forgot password	<p>If you created a Key FD (diskette), you can use it to start the computer.</p> <p>If you did not create a Key FD or cannot use it to start the computer, contact your dealer.</p>
---------------------------------	---

Keyboard

Keyboard problems can be caused by your setup configuration. For more information refer to Chapter 5, *The Keyboard*.

Problem	Procedure
Some letter keys produce numbers	Check that the numeric keypad overlay is not selected. Press Fn + F10 and try typing again.
Output to screen is garbled	Make sure the software you are using is not remapping the keyboard. Remapping involves reassigning the meaning of each key. See your software's documentation. If you are still unable to use the keyboard, consult your dealer.

LCD panel

Problem	Procedure
No display	Press hot keys Fn + F5 to change the display priority, to make sure it is not set for an external monitor.
Markings appear on the LCD.	They might have come from contact with the keyboard, Touch Pad. Try wiping the LCD gently with a clean dry cloth. If markings remain, use LCD cleaner. Be sure to let the LCD dry before closing it.

Problems above remain unresolved or other problems occur

Refer to your software's documentation to determine if the software is causing the difficulty.

Contact your dealer if the problems continue.

Hard disk drive

Problem	Procedure
---------	-----------

Computer does not boot from hard disk drive

Check if a diskette is in the diskette drive or a CD-ROM is in the optical media drive. Remove any diskette and/or CD-ROM and check Boot priority. Refer to the *Boot Priority* section in Chapter 7, *HW Setup and Passwords*.

There may be a problem with your operating system files. Refer to your OS documentation.

Slow performance

Your files may be fragmented. Run SCANDISK and defragmenter to check the condition of your files and disk. Refer to your OS documentation or online HELP for information on running SCANDISK and the defragmenter.

As a last resort, reformat the hard disk. Then, reload the operating system and other files.

If problems persist, contact your dealer.

CD-RW/DVD-ROM drive

For more information, refer to Chapter 4, *Operating Basics*.

Problem	Procedure
You cannot access a CD/DVD in the drive	Make sure the drive's drawer is securely closed. Press gently until it clicks into place.
	Open the drawer and make sure the CD/DVD is properly seated. It should lie flat with the label facing up.
	A foreign object in the drawer could block laser light from reading the CD/DVD. Make sure there is no obstruction. Remove any foreign object.
	Check whether the CD/DVD is dirty. If it is, wipe it with a clean cloth dipped in water or a neutral cleaner. See the <i>Media care</i> section in Chapter 4 for details on cleaning.
Some CD/DVDs run correctly, but others do not	The software or hardware configuration may be causing a problem. Make sure the hardware configuration matches your software's needs. Check the CD/DVD's documentation.
	Check the type of CD/DVD you are using. The drive supports: DVD-ROM: DVD-ROM, DVD-Video CD-ROM: CD-DA, CD-Text, Photo CD (single/multi-session), CD-ROM Mode 1, Mode 2, CD-ROM XA Mode 2 (Form1, Form2), Enhanced CD (CD-EXTRA), CD-G (Audio CD only), Addressing Method 2

Check the region code on the DVD. It must match that on the CD-RW/DVD-ROM drive. Region codes are listed in the *Optical media drives* section in Chapter 2, *The Grand Tour*.

- Cannot write correctly
- If you have trouble writing, make sure you are observing the following precautions:
- Use only media recommended by TOSHIBA.
 - Do not use the mouse or keyboard during writing.
 - Use only the software supplied with the computer for recording.
 - Do not run or start other software during writing.
 - Do not jar the computer during writing.
 - Do not connect/ disconnect external devices or install/remove internal cards during writing.
-

If problems persist, contact your dealer.

DVD-R/-RW drive

For more information, refer to Chapter 4, *Operating Basics*.

Problem	Procedure
You cannot access a CD/DVD in the drive	<p>Make sure the drive's drawer is securely closed. Press gently until it clicks into place.</p> <hr/> <p>Open the drawer and make sure the CD/DVD is properly seated. It should lie flat with the label facing up.</p> <hr/> <p>A foreign object in the drawer could block laser light from reading the CD/DVD. Make sure there is no obstruction. Remove any foreign object.</p>

Check whether the CD/DVD is dirty. If it is, wipe it with a clean cloth dipped in water or a neutral cleaner. See the [Media care](#) section in Chapter 4 for details on cleaning.

Some CD/DVDs run correctly, but others do not

The software or hardware configuration may be causing a problem. Make sure the hardware configuration matches your software's needs. Check the CD/DVD's documentation.

Check the type of CD/DVD you are using. The drive supports:

DVD-ROM: DVD-ROM, DVD-Video

CD-ROM: CD-DA, CD-Text, Photo CD (single/multi-session), CD-ROM Mode 1, Mode 2, CD-ROM XA Mode 2 (Form1, Form2), Enhanced CD (CD-EXTRA), CD-G (Audio CD only), Addressing Method 2

Check the region code on the DVD. It must match that on the CD-RW/DVD-ROM drive. Region codes are listed in the [Optical media drives](#) section in Chapter 2, *The Grand Tour*.

Cannot write correctly

If you have trouble writing, make sure you are observing the following precautions:

- Use only media recommended by TOSHIBA.
- Do not use the mouse or keyboard during writing.
- Use only the software supplied with the computer for recording.
- Do not run or start other software during writing.
- Do not jar the computer during writing.

- Do not connect/ disconnect external devices or install/remove internal cards during writing.

If problems persist, contact your dealer.

DVD Multi drive

For more information, refer to Chapter 4, *Operating Basics*.

Problem	Procedure
You cannot access a CD/DVD in the drive	Make sure the drive's drawer is securely closed. Press gently until it clicks into place.
	Open the drawer and make sure the CD/DVD is properly seated. It should lie flat with the label facing up.
	A foreign object in the drawer could block laser light from reading the CD/DVD. Make sure there is no obstruction. Remove any foreign object.
	Check whether the CD/DVD is dirty. If it is, wipe it with a clean cloth dipped in water or a neutral cleaner. See the <i>Media care</i> section in Chapter 4 for details on cleaning.
Some CD/DVDs run correctly, but others do not	The software or hardware configuration may be causing a problem. Make sure the hardware configuration matches your software's needs. Check the CD/DVD's documentation.

Check the type of CD/DVD you are using. The drive supports:

DVD-ROM: DVD-ROM, DVD-Video

CD-ROM: CD-DA, CD-Text, Photo CD (single/multi-session), CD-ROM Mode 1, Mode 2, CD-ROM XA Mode 2 (Form1, Form2), Enhanced CD (CD-EXTRA), CD-G (Audio CD only), Addressing Method 2

Check the region code on the DVD. It must match that on the CD-RW/DVD-ROM drive. Region codes are listed in the [Optical media drives](#) section in Chapter 2, *The Grand Tour*.

Cannot write correctly

If you have trouble writing, make sure you are observing the following precautions:

- Use only media recommended by TOSHIBA.
- Do not use the mouse or keyboard during writing.
- Use only the software supplied with the computer for recording.
- Do not run or start other software during writing.
- Do not jar the computer during writing.
- Do not connect/disconnect external devices or install/remove internal cards during writing.

If problems persist, contact your dealer.

Diskette drive

For more information, refer to Chapter 4, *Operating Basics*.

Problem	Procedure
Drive does not operate	There may be a faulty cable connection. Check the connection to the computer and to the drive.
You cannot access the external 3 1/2" diskette drive	Try another diskette. If you can access the diskette, the original diskette (not the drive) is probably causing the problem. If problems persist, contact your dealer.

SD card

Refer also to Chapter 8, *Optional Devices*.

Problem	Procedure
SD card error occurs	Reseat the SD card to make sure it is firmly connected. Check the card's documentation.
You cannot write to an SD card	Make sure the card is not write protected.
You cannot read a file	Make sure the target file is on the SD Card inserted in the slot. If problems persist, contact your dealer.

PC card

Refer also to Chapter 8, *Optional Devices*.

Problem	Procedure
PC card error occurs	Reseat the PC card to make sure it is firmly connected.
	Make sure the connection between the external device and the card is firm.
	Check the card's documentation.
	If problems persist, contact your dealer.

Infrared port

Refer also to the documentation for your IrDA compatible device and related software.

Problem	Procedure
Infrared devices do not work as expected	Make sure there is no obstruction blocking communication between the computer and the target device.
	If problems persist, contact your dealer.

Pointing device

If you are using a USB mouse, also refer to the [USB](#) section in this chapter and to your mouse documentation.

Touch Pad

Problem	Procedure
On-screen pointer does not respond to Pad operation	The system might be busy. If the pointer is shaped as an hourglass, wait for it to resume its normal shape and try again to move it.
Double-tapping does not work	Try changing the double-click speed setting in the mouse control utility. <ol style="list-style-type: none">1. Open the Control Panel, select the Mouse icon and press Enter.2. Click the Buttons tab.3. Set the double-click speed as instructed and click OK.
The mouse pointer moves too fast or too slow	Try changing the speed setting in the mouse control utility. <ol style="list-style-type: none">1. Open the Control Panel, select the Mouse icon and press Enter.2. Click the Pointer Options tab.3. Set the speed as instructed and click OK. <p>If problems persist, contact your dealer.</p>

USB mouse

Problem	Procedure
---------	-----------

On-screen pointer does not respond to mouse operation

The system might be busy. If the pointer is shaped as an hourglass, wait for it to resume its normal shape and try again to move it.

Make sure the mouse is properly connected to the USB port.

Double-clicking does not work

Try changing the double-click speed setting in the mouse control utility.

1. Open the **Control Panel**, select the **Mouse** icon and press **Enter**.
2. Click the **Buttons** tab.
3. Set the double-click speed as instructed and click **OK**.

The mouse pointer moves too fast or too slow

Try changing the speed setting in the mouse control utility.

1. Open the **Control Panel**, select the **Mouse** icon and press **Enter**.
2. Click the **Pointer Options** tab.
3. Set the speed as instructed and click **OK**.

The mouse pointer moves erratically

The mouse might be dirty. Refer to your mouse documentations for instructions on cleaning.

If problems persist, contact your dealer.

USB

Refer also to your USB device's documentation.

Problem	Procedure
USB device does not work	<p>Check for a firm cable connection between the USB ports on the computer and the USB device.</p> <hr/> <p>Make sure the USB device drivers are properly installed. Refer to your Windows XP documentation for information on checking the drivers.</p> <p>If problems persist, contact your dealer.</p>

Memory expansion

Refer also to Chapter 8, *Optional Devices*, for information on installing memory modules.

Problem	Procedure
Beep sounds. (If slot A two beeps, If slot B three beeps, If both two and three beeps.)	<p>Make sure the memory module installed in the expansion slot is compatible with the computer. If an incompatible module has been installed, follow the steps below.</p> <ol style="list-style-type: none">1. Turn off the power.2. Disconnect the universal AC adaptor and all peripheral devices.3. Remove the battery pack.4. Remove the memory module.5. Replace the battery pack and/or connect the universal AC adaptor.6. Turn on the power. <p>If problems persist, contact your dealer.</p>

Sound system

Refer also to documentation for your audio devices.

Problem	Procedure
No sound is heard	Adjust the volume control dial.
	Check the software volume settings.
	Make sure the headphone connection is secure. If problems persist, contact your dealer.
	If problems persist, contact your dealer.

Monitor

Refer also to Chapter 8, *Optional Devices*, and to your monitor's documentation.

Problem	Procedure
Monitor does not turn on	Make sure that the external monitor's power switch is on. Confirm that the external monitor's power cable is plugged into a working power outlet.
No display	Try adjusting the contrast and brightness controls on the external monitor.
	Press hot keys Fn + F5 to change the display priority and make sure it is not set for the internal display.
Display error occurs	Check that the cable connecting the external monitor to the computer is attached firmly.
	If problems persist, contact your dealer.

Modem

Refer to [Appendix C](#) and [D](#).

Problem	Procedure
Communication software can't initialize modem	Make sure the computer's internal modem settings are correct. Refer to <i>Phone and Modem Properties</i> in the Control Panel.
You can hear a dial tone but can't make a call	If the call is going through a PBX machine, make sure the communication application's tone dial detection feature is disabled. You can also use the ATX command. Refer to Appendix C , <i>AT Commands</i> .
You place a call, but a connection can't be made	Make sure the settings are correct in your communications application.
After making a call you can't hear a ring	Make sure the tone or pulse selection in your communications application is set correctly. You can also use the ATD command. Refer to Appendix C , <i>AT Commands</i> .
Communication is cut off unexpectedly	The computer will automatically cut off communication when connection with the carrier is not successful for a set time interval. Try lengthening this time interval.

A **CONNECT** display is quickly replaced by **NO CARRIER**

Check the error control setting in your communications application.

You can also use the ATN command. Refer to Appendix C, [AT Commands](#).

Character display becomes garbled during a communication

In data transmission, make sure the parity bit and stop bit settings correspond with those of the remote computer.

Check the flow control and communication protocol.

You cannot receive an incoming call

Check the rings before auto answer setting in your communications application.

You can also use the ATS0 command. Refer to Appendix D, [S-registers](#).
If problems persist, contact your dealer.

LAN

Problem

Procedure

Cannot access LAN

Check for a firm cable connection between the LAN jack and the LAN HUB.

Wake-up on LAN does not work

Make sure the universal AC adaptor is connected. The Wake-up on LAN function consumes power even when the system is off.

If problems persist, consult your LAN administrator.

Wireless LAN

If the following procedures do not restore LAN access, consult your LAN administrator. For more information on wireless communication, refer to Chapter 4, *Operating Basics*.

Problem	Procedure
Cannot access Wireless LAN	Make sure the computer's wireless communication switch is set to on. If problems persist, contact your LAN administrator or dealer.

TV output signal

Refer also to your Personal Conferencing Kit's documentation.

Problem	Procedure
Display on TV is poor	Make sure the TV type is correct for your area: NTSC (US, JAPAN), PAL (Europe).
No display	Try adjusting the contrast and brightness controls on the external monitor. Press hotkeys Fn + F5 to change the display. Refer to Chapter 5, <i>The Keyboard</i> . NOTE: <i>If you turn the computer off in Standby mode while the display is on TV, the computer will select either the internal LCD or an external computer CRT as the display device.</i> If problems persist, contact your dealer.

Printer

Refer also to the *Parallel printer* section in Chapter 8, *Optional Devices*, and to the troubleshooting and other relevant sections in your printer and software documentation.

Problem	Procedure
Printer does not turn on.	Check that the printer is connected to an electric outlet. Make sure the outlet is supplying power by plugging in an appliance.
Computer/printer do not communicate	<p>Make sure the printer is turned on and is online (ready to use).</p> <hr/> <p>Inspect the cable connecting the printer to the computer for damage. Make sure it is securely connected.</p> <hr/> <p>A parallel printer connects to the parallel port. Make sure the port is configured correctly. Refer to Chapter 7, <i>HW Setup and Passwords</i>.</p> <hr/> <p>Make sure your software is configured to recognize the printer. Check your printer and software documentation.</p>
Printer error	<p>Check your printer documentation.</p> <hr/> <p>If problems persist, contact your dealer.</p> <hr/>

TOSHIBA support

If you require any additional help using your computer or if you are having problems operating the computer, you may need to contact TOSHIBA for additional technical assistance.

Before you call

Some problems you experience may be related to software or the operating system, it is important to investigate other sources of assistance first. Before contacting TOSHIBA, try the following:

- ❖ Review troubleshooting sections in the documentation for software and peripheral devices.
- ❖ If a problem occurs when you are running software applications, consult the software documentation for troubleshooting suggestions. Call the software company's technical support for assistance.
- ❖ Consult the dealer you purchased your computer and/or software from. They are your best sources for current information and support.

Where to write

If you are still unable to solve the problem and suspect that it is hardware related, write to TOSHIBA at the nearest location listed below:

Outside of Europe

Australia

TOSHIBA Australia Pty. Ltd.
Information Systems Division
84-92 Talavera Road
North Ryde N.S.W. 2113
Sydney

Canada

TOSHIBA of Canada Ltd.
191 McNabb Street,
Markham, Ontario
L3R8H2

China

TOSHIBA Computer Systems
(Shanghai) Co., Ltd.
Bldg. 33, No. 351, Jinzang Road,
Pudong New Area,
Shanghai,
P.R. China 201206

Singapore

TOSHIBA Singapore Pte. Ltd.
438B Alexandra Road #06-01
Alexandra Technopark
Singapore 119968

United States of America

TOSHIBA America Information
Systems, Inc.
9740 Irvine Boulevard
Irvine, California 92618
USA

The Rest of Europe

TOSHIBA Europe (I.E.) GmbH
Geschäftsbereich,
Deutschland-Österreich
Hammfelddamm 8,
D-41460 Neuss, Germany

In Europe

Germany & Austria

TOSHIBA Europe (I.E.) GmbH
Geschäftsbereich,
Deutschland-Österreich
Hammfelddamm 8,
D-41460 Neuss, Germany

France

TOSHIBA Systèmes France S.A.
7, Rue Ampère B.P. 131,
92804 Puteaux Cedex

Netherlands

TOSHIBA Information Systems,
Benelux B.V.
Rivium Boulevard
41 2909 LK Capelle a/d IJssel

Spain

TOSHIBA Information Systems,
ESPAÑA
Parque Empresarial San Fernando
Edificio Europa, 1ª Planta,
Escalera A 28830 Madrid

United Kingdom

TOSHIBA Information Systems (U.K.)
Ltd.
TOSHIBA Court
Weybridge Business Park
Addlestone Road
Weybridge, Surrey KT15 2UL

Specifications

This appendix summarizes the computer's technical specifications.

Environmental Requirements

Conditions	Ambient temperature	Relative humidity
Operating	5°C (41°F) to 35°C (95°F)	20% to 80%
Non-operating	-20°C (-4°F) to 65°C (149°F)	10% to 95%
Thermal Gradient	20°C per hour maximum	
Wet-bulb temperature	26°C maximum	
Conditions	Altitude (from sea level)	
Operating	-60 to 3,000 meters	
Non-operating	-60 to 10,000 meters maximum	

Power Requirements

Universal AC adaptor	100-240 volts AC 50 or 60 hertz (cycles per second)
Computer	15VDC 8.0 amperes

Built-in Modem**Network control unit (NCU)**

Type of NCU	AA
Type of line	Telephone line (analog only)
Type of dialing	Pulse Tone
Control command	AT commands EIA-578 commands
Monitor function	Computer's speaker

Communication specifications

Communication system	Data:	Full duplex
	Fax:	Half duplex
Communication protocol	Data	
	ITU-T-Rec (Former CCITT)	V.21/V.22/V.22bis/V.32 /V.32bis/V.34/V.90
	Bell	103/212A
	Fax	
	ITU-T-Rec (Former CCITT)	V.17/V.29/V.27ter /V.21 ch2
Communication speed	Data transmission and reception	
	300/1200/2400/4800/7200/9600/12000/14400/ 16800/19200/21600/24000/26400/28800/31200/ 33600 bps	
	Data reception only with V.90	
	28000/29333/30666/32000/33333/34666/36000/37333/ 38666/40000/41333/42666/44000/45333/46666/48000/ 49333/50666/52000/53333/54666/56000 bps	
	Fax	
	2400/4800/7200/9600/12000/14400 bps	
Transmitting level	-10 dBm	
Receiving level	-10 to -40 dBm	
Input/output impedance	600 ohms \pm 30%	
Error correcting	MNP class 4 and ITU-T V.42	
Data compression	MNP class 5 and ITU-T V.42bis	
Power supply	+3.3V (supplied by computer)	

Display Controller and Modes

Display controller

The display controller interprets software commands into hardware commands that turn particular pixels on or off.

The controller is an advanced Video Graphics Array (VGA) that provides Extended Graphics Array (XGA) and Super Extended Graphics Array Plus (SXGA+) support for the internal LCD and external monitors.

Four models are available:

- ◆ 14.1" XGA, 1024 horizontal x 768 vertical pixels
- ◆ 15.0" XGA, 1024 horizontal x 768 vertical pixels
- ◆ 15.0" SXGA+, 1400 horizontal x 1050 vertical pixels

A high-resolution external monitor connected to the computer can display up to 1600 horizontal and 1200 vertical pixels at 16 M colors.

The display controller also controls the video mode, which uses industry standard rules to govern the screen resolution and the maximum number of colors that can be displayed on screen.

Software written for a given video mode will run on any computer that supports the mode.

The computer's display controller supports all VGA and SVGA modes, the most widely used industry standards.

Video modes

The computer supports video modes defined in the tables below. If your application offers a selection of mode numbers that do not match the numbers on the table, select a mode based on mode type, resolution, character matrix, number of colors and refresh rates. Also, if your software supports both graphics and text modes, the screen display may appear to operate faster using a text mode.

Table1 Video modes (VGA)

<i>Video mode</i>	<i>Type</i>	<i>Resolution</i>	<i>Character matrix (pels)</i>	<i>LCD colors</i>	<i>CRT colors</i>	<i>Scanning frequency Vertical (Hz)</i>
0, 1	VGA Text	40 x 25 Characters	8 x 8	16 of 256K	16 of 256K	70
2, 3	VGA Text	80 x 25 Characters	8 x 8	16 of 256K	16 of 256K	70
0*, 1*	VGA Text	40 x 25 Characters	8 x 14	16 of 256K	16 of 256K	70
2*, 3*	VGA Text	80 x 25 Characters	8 x 14	16 of 256K	16 of 256K	70
0+, 1+	VGA Text	40 x 25 Characters	9 x 16	16 of 256K	16 of 256K	70
2+, 3+	VGA Text	80 x 25 Characters	9 x 16	16 of 256K	16 of 256K	70
4, 5	VGA Grph	320 x 200 Pels	8 x 8	4 of 256K	4 of 256K	70
6	VGA Grph	640 x 200 Pels	8 x 8	2 of 256K	2 of 256K	70
7	VGA Text	80 x 25 Characters	9 x 14	Mono	Mono	70
7+	VGA Text	80 x 25 Characters	9 x 16	Mono	Mono	70

Table1 Video modes (VGA) continued

<i>Video mode</i>	<i>Type</i>	<i>Resolution</i>	<i>Character matrix (pels)</i>	<i>LCD colors</i>	<i>CRT colors</i>	<i>Scanning frequency Vertical (Hz)</i>
D	VGA Grph	320 x 200 Pels	8 x 8	16 of 256K	16 of 256K	70
E	VGA Grph	640 x 200 Pels	8 x 8	16 of 256K	16 of 256K	70
F	VGA Grph	640 x 350 Pels	8 x 14	Mono	Mono	70
10	VGA Grph	640 x 350 Pels	8 x 14	16 of 256K	16 of 256K	70
11	VGA Grph	640 x 480 Pels	8 x 16	2 of 256K	2 of 256K	60
12	VGA Grph	640 x 480 Pels	8 x 16	16 of 256K	16 of 256K	60
13	VGA Grph	320 x 200 Pels	8 x 8	256 of 256K	256 of 256K	70

Table 2 Video modes (XGA)

<i>Resolution</i>	<i>LCD colors</i>	<i>CRT colors</i>	<i>Vertical frequency (Hz)</i>
640 x 480	256/256K	256/256K	60
			75
			85
800 x 600	256/256K	256/256K	60
			75
			85
1024 x 768	256/256K	256/256K	60
			75
			85
1280 x 1024	256/256K (Virtual)	256/256K	60
			75
			85
1600 x 1200	256/256K (Virtual)	256/256K	60
640 x 480	64K/64K	64K/64K	60
			75
			85
800 x 600	64K/64K	64K/64K	60
			75
			85
1024 x 768	64K/64K	64K/64K	60
			75
			85
1280 x 1024	64K/64K (Virtual)	64K/64K	60
			75
			85
1600 x 1200	64K/64K (Virtual)	64K/64K	60

Table 2 Video modes (XGA) continued

<i>Resolution</i>	<i>LCD colors</i>	<i>CRT colors</i>	<i>Vertical frequency (Hz)</i>
640 x 480	16M/16M	16M/16M	60 75 85
800 x 600	16M/16M	16M/16M	60 75 85
1024 x 768	16M/16M	16M/16M	60 75 85
1280 x 1024	16M/16M (Virtual)	16M/16M	60 75
1600 x 1200	16M/16M (Virtual)	16M/16M	60

Table 3 Video modes (Super XGA+)

<i>Resolution</i>	<i>LCD colors</i>	<i>CRT colors</i>	<i>Vertical frequency (Hz)</i>
640 x 480	256/256K	256/256K	60
			75
			85
800 x 600	256/256K	256/256K	60
			75
			85
1024 x 768	256/256K	256/256K	60
			75
			85
1280 x 1024	256/256K	256/256K	60
			75
			85
1400 x 1050	256/256K	256/256K	60
1600 x 1200	256/256K (Virtual)	256/256K	60
640 x 480	64K/64K	64K/64K	60
			75
			85
800 x 600	64K/64K	64K/64K	60
			75
			85
1024 x 768	64K/64K	64K/64K	60
			75
			85
1280 x 1024	64K/64K	64K/64K	60
			75
			85

Table 3 Video modes (Super XGA+) continued

<i>Resolution</i>	<i>LCD colors</i>	<i>CRT colors</i>	<i>Vertical frequency (Hz)</i>
1400 x 1050	64K/64K	64K/64K	60
1600 x 1200	64K/64K (Virtual)	64K/64K	60
640 x 480	16M/16M	16M/16M	60
			75
			85
800 x 600	16M/16M	16M/16M	60
			75
			85
1024 x 768	16M/16M	16M/16M	60
			75
			85
1280 x 1024	16M/16M	16M/16M	60
			75
1400 x 1050	16M/16M	16M/16M	60
1600 x 1200	16M/16M (Virtual)	16M/16M	60

APPENDIX B

AT Commands

In most cases, you will not need to type AT commands manually. However, there might be some occasions when you will need to do so.

This chapter describes AT commands for data mode. Fax and voice commands are taken care of by application software.

The format for entering AT commands is:

ATXn

where **X** is the AT command, and **n** is the specific value for that command. After you type in the command press **Enter**.

Any command issued is acknowledged with a response in either text or numeric values known as result codes.

All commands and command-values accepted by the modem are described in this section; any entry other than those listed results in an error.

+++ Escape sequence

The escape sequence allows the modem to exit data mode and enter online command mode. While in online command mode, you can communicate directly to your modem using AT commands. Once you finish, you can return to data mode using the ATO command.

A pause, the length of which is set by Escape Guard Time (S12), must be completed after an escape sequence is entered. This pause prevents the modem from interpreting the escape sequence as data.

The value of the escape sequence character may be changed using register S2.

A/ Repeat last command

This command repeats the last command string entered. Do not precede this command with an AT prefix or conclude it by pressing **Enter**.

A Answer command

This command instructs the modem to go off-hook and answer an incoming call.

Bn Communication standard setting

This command determines the communication standard CCITT or Bell.

B0 Selects CCITT V.22 mode when the modem is at 1200 bps.

B1 Selects Bell 212A when the modem is at 1200 bps (default).

B15 Selects V.21 when the modem is at 300 bps.

B16 Selects Bell 103J when the modem is at 300 bps (default).

Result Codes:

OK n=0,1,15,16

ERROR Otherwise

Dn Dial

This command instructs the modem to dial a telephone number. Enter n (the telephone number and any modifiers) after the ATD command.

Any digit or symbol (0-9, *, #, A, B, C, D) may be dialed as touch-tone digits. Characters such as spaces, hyphens, and parentheses do not count. They are ignored by the modem, but you may want to include them to make the number and modifiers easier to read.

The following may be used as phone number modifiers:

P Pulse dialing.

T Touch-tone dialing (default).

, Pause during dialing. Pause for time specified in Register S8 before processing the next character in the dial string.

W Wait for dial tone. Modem waits for a second dial tone before processing the dial string.

@ Wait for quiet answer. Wait for five seconds of silence after dialing the number. If silence is not detected, the modem sends a NO ANSWER result code back to the caller.

! Hook flash. Causes the modem to go on-hook for 0.5 seconds and then return to off-hook.

- ; Return to command mode. Causes the modem to return to command mode after dialing a number, without disconnecting the call.
- S=n Dial a telephone number previously stored using the &Zn=X command (See &Zn=X command for more information). The range is 0-3.

En Echo command

This command controls whether or not the characters entered from your computer keyboard are displayed on your monitor (echoed) while the modem is in command mode.

- E0** Disables echo to the computer.
- E1** Enables echo to the computer (default).

Result Codes:

- OK** n=0,1
- ERROR** Otherwise

Hn Hook control

This command instructs the modem to go on-hook to disconnect a call, or off-hook to make the phone line busy.

- H0** Modem goes on-hook (default).
- H1** Modem goes off-hook.

Result Codes:

- OK** n=0,1
- ERROR** Otherwise

In Request ID information

This command displays product information about the modem.

- I0** Returns modem identity string and driver version number.
- I3** Same as **I0**.
- I9** Returns region ID in English.

Result Codes:

- OK** n=0,3,9
- ERROR** Otherwise

Ln Monitor speaker volume

This command sets speaker volume to low, medium, or high.

- L0** Low volume.
- L1** Low volume. (Same as **L0**)
- L2** Medium volume (default).
- L3** High volume.

Result Codes:

- OK** n=0,1,2,3
- ERROR** Otherwise

Mn Monitor speaker mode

This command turns the speaker on or off.

- M0** The speaker is off.
- M1** The speaker is on until the modem detects the carrier signal (default).
- M2** The speaker is always on when modem is off-hook.
- M3** Speaker is on until the carrier is detected, except when dialing.

Result Codes:

- OK** n=0,1,2,3
- ERROR** Otherwise

Nn Modulation handshake

This command controls whether or not the local modem performs a negotiated handshake at connection time with the remote modem when the communication speed of the two modems is different.

- N0** When originating or answering, this is for handshake only at the communication standard specified by S37 and the ATB command.
- N1** When originating or answering, begin the handshake at the communication standard specified by S37 and the ATB command (default).

During handshake, a lower transmission speed may be selected.

Result Codes:

OK n=0,1

ERROR Otherwise

On Return online to data mode

O0 Instructs the modem to exit online command mode and return to data mode (see AT escape sequence, +++).

O1 This command issues a retrain before returning to online data mode.

O3 This command issues a rate renegotiation before returning to online data mode.

Result Codes:

OK n=0,1,3

ERROR Otherwise

P Select pulse dialing

This command configures the modem for pulse (non touch-tone) dialing. Dialed digits are pulsed until a T command or dial modifier is received. Tone dial is the default setting.

Qn Result code control

Result codes are informational messages sent from the modem and displayed on your monitor. Basic result codes are **OK**, **CONNECT**, **RING**, **NO CARRIER**, and **ERROR**. The ATQ command allows the user to turn result codes on or off.

Q0 Enables modem to send result codes to the computer (default).

Q1 Disables modem from sending result codes to the computer.

Result Codes:

OK n=0,1

ERROR Otherwise

T Select tone dialing

This command instructs the modem to send DTMF tones while dialing. Dialed digits are tone dialed until a P command or dial modifier is received. This is the default setting.

Vn DCE response format

This command controls whether result codes (including call progress and negotiation progress messages) are displayed as words or their numeric equivalents.

V0 Displays result codes as digits.

V1 Displays result codes as text (default).

Result Codes:

OK n=0,1

ERROR Otherwise

Xn Result code selection, call progress monitoring

This command selects which result codes will be used by the modem.

Command	Dial tone detect	Busy signal detect	Supported Result Code
X0	Disable	Disable	OK, CONNECT, RING, NO CARRIER, ERROR
X1	Disable	Disable	OK, RING, NO CARRIER, ERROR, CONNECT <RATE>
X2	Enable	Disable	OK, RING, NO CARRIER, ERROR, NODIALTONE, CONNECT <RATE>
X3	Disable	Enable	OK, RING, NO CARRIER, ERROR, BUSY, CONNECT <RATE>, BLACKLISTED
X4 (default)	Enable	Enable	OK, RING, NO CARRIER, ERROR, NODIALTONE, BUSY, CONNECT <RATE>, DELAYED, BLACKLISTED, REORDER, WARBLE, CALL WAITING DETECTED

X5	Enable	Enable	OK, RING, NO CARRIER, ERROR, NODIALTONE, BUSY, CONNECT <RATE>, RRING, NO BONGTONE, DELAYED, BLACKLISTED, REORDER, WARBLE, CALL WAITING DETECTED
----	--------	--------	---

Dial tone detect

Disabled: The modem dials a call regardless of whether it detects a dial tone.

Enabled: The modem dials only upon detection of a dial tone, and disconnects the call if the dial tone is not detected within 10 seconds.

Busy tone detect

Disabled: The modem ignores any busy tones it receives.

Enabled: The modem monitors for busy tones.

Result Codes:

OK n=0,1,2,3,4,5

ERROR Otherwise

Zn Recall stored profile

The modem performs a soft reset and restores (recalls) the configuration profile according to the parameter supplied. If no parameter is specified, zero is assumed. Either Z0 or Z1 restores the profile.

Result Codes:

OK n=0,1

ERROR Otherwise

&Cn Data Carrier Detect (DCD) control

Data Carrier Detect is a signal from the modem to the computer indicating that a carrier signal is being received from a remote modem. DCD normally turns off when the modem no longer detects the carrier signal.

&C0 The state of the carrier from the remote modem is ignored. DCD circuit is always on.

&C1 DCD turns on when the remote modem's carrier signal is detected, and off when the carrier signal is not detected (default).

Result Codes:

OK n=0,1

ERROR Otherwise

&Dn DTR control

This command interprets how the modem responds to the state of the DTR signal and changes to the DTR signal.

&D0 Ignore. The modem ignores the true status of DTR and treats it as always on. This should only be used if your communication software does not provide DTR to the modem

&D1 If the DTR signal is not detected while in online data mode, the modem enters command mode, issues an **OK** result code, and remains connected.

&D2 If the DTR signal is not detected while in online data mode, the modem disconnects (default).

&D3 Reset on the on-to-off DTR transition.

Result Codes:

OK n=0,1,2,3

ERROR Otherwise

&F Load factory settings

This command loads the configuration stored and programmed at the factory. This operation replaces all of the command options and the S-register settings in the active configuration with factory values.

&F Recall factory setting as active configuration.

&Gn V.22bis guard tone control

This command determines which guard tone, if any, to transmit while transmitting in the high band (answer mode). This command is only used in V.22 and V.22bis mode. This option is not used in North America and is for international use only.

&G0 Guard tone disabled (default).

&G1 Sets guard tone to 550 Hz.

&G2 Sets guard tone to 1800 Hz.

Result Codes:

OK n=0,1,2

ERROR Otherwise

&Kn Local flow control selection

&K0 Disable flow control.

&K3 Enable CTS/RTS flow control (default).

&K4 Enable XON/XOFF flow control.

Result Codes:

OK n=0,3,4

ERROR Otherwise

&Pn Select Pulse Dial Make/Break Ratio (WW)

&P0 Selects 39% - 61% make/break ratio at 10 pulses per second.

&P1 Selects 33% - 67% make/break ratio at 10 pulses per second.

&P2 Selects 33% - 67% make/break ratio at 20 pulses per second.

Result Codes:

OK n=0,1,2

ERROR Otherwise

&Tn Self-test commands

These tests can help to isolate problems if you experience periodic data loss or random errors.

- &T0** Abort. Stops any test in progress.
- &T1** Local analog loop. This test verifies modem operation, as well as the connection between the modem and computer. Any data entered at the local DTE is modulated, then demodulated, and returned to the local DTE. To work properly, the modem must be off-line.

Result Codes:

- OK** n=0
- CONNECT** n=1
- ERROR** Otherwise

&V Display Current Configuration

This command displays the current configuration of the modem. If nonvolatile memory is supported the stored profiles are displayed as well.

- &V** View profiles.

&W Store current configuration

Saves the current (active) configuration (profile), including S-Registers. The current configuration comprises a list of storable parameters illustrated in the **&V** command. These settings are restored to the active configuration upon receiving a **Zn** command or at power up. Refer to the **&V** command.

- &W** Stores the current configuration.

&Zn=x Store telephone number

This command is used to store up to four dialing strings in the modem's nonvolatile memory for later dialing. The format for the command is **&Zn**="stored number" where n is the location 0-3 to which the number should be written. The dial string may contain up to 34 characters. The **ATDS=n** command dials using the string stored in location n.

Result codes:

- OK** n=0, 1, 2, 3
- ERROR** Otherwise

\Nn Error control mode selection

This command determines the type of error control used by the modem when sending or receiving data.

- \N0** Buffer mode. No error control.
- \N1** Direct mode.
- \N2** MNP or disconnect mode. The modem attempts to connect using MNP2-4 error control procedures. If this fails, the modem disconnects.

This is also known as MNP reliable mode.

- \N3** V.42, MNP, or buffered (default).
The modem attempts to connect in V.42 error control mode. If this fails, it attempts to connect in MNP mode. If this fails, it connects in buffer mode and continues operation. This is also known as V.42/MNP auto reliable mode (same as **&Q5**).

- \N4** V.42 or disconnect. The modem attempts to connect in V.42 error control mode. If this fails, the modem disconnects.

- \N5** V.42. MNP or buffered (same as **\N3**).

- \N7** V.42. MNP or buffered (same as **\N3**).

Result Codes:

OK n=0,1,2,3,4,5,7

ERROR Otherwise

\Qn Local flow control selection

- \Q0** Disable flow control.
- \Q1** XON/XOFF software flow control.
- \Q3** CTS/RTS to DTE (default).

Result Codes:

OK n=0,1,3

ERROR Otherwise

\Vn Protocol result code

\V0 Disable protocol result code appended to DCE speed.

\V1 Enable protocol result code appended to DCE speed (default).

Result Codes:

OK n=0,1

ERROR Otherwise

%B View numbers in blacklist

If blacklisting is in effect, this command displays the numbers for which the last call attempted in the past two hours failed. The **ERROR** result code appears in regions that do not require blacklisting.

%Cn Data compression control

This command determines the operation of V.42bis and MNP class 5 data compression. Online changes do not take effect until a disconnect occurs first.

%C0 V.42bis/MNP 5 disabled. No data compression.

%C3 V.42bis/MNP 5 enabled. Data compression enabled (default).

Result Codes:

OK n=0,3

ERROR Otherwise

S-registers

S-registers contain the settings that determine how a number of functions of the internal modem operate. For example, how many times to let the telephone ring before the modem answers and how long to wait before it hangs up if a connection fails. You can also customize certain AT commands such as the escape sequence and command line termination.

The contents of the registers are changed automatically when you modify corresponding settings in your communication software. If you choose, however, you can display and edit the contents of the registers manually when the modem is in command mode. If the value is out of the acceptable range, then an error is generated.

This chapter describes the settings for each S-register.

S-register values

The format for displaying the value of an S-register is:

ATS*n*?

where ***n*** is the register number. After you type in the register press **Enter**.

The format for modifying the value of an S-register is:

ATS*n*=*r*

where ***n*** is the register number, and ***r*** is the new register value. After you type in the register and its new value press **Enter**.

NOTE: Some registers vary from one country/region to another.

S0 Auto answer ring number

This register determines the number of rings the modem will count before automatically answering a call. Enter 0 (zero) if you do not want the modem to automatically answer at all. When disabled, the modem can only answer with an ATA command.

Range: 0-255

Default: 0

Units: rings

S1 Ring counter

This register is read only. The value of S1 is incremented with each ring. If no ring occurs over a six-second interval, this register is cleared.

Range: 0-225

Default: 0

Units: rings

S2 AT escape character (user defined)

This register determines the ASCII values used for an escape sequence. The default is the + character. The escape sequence allows the modem to exit data mode and enter command mode when online. Values greater than 127 disable the escape sequence.

Range: 0-255, ASCII decimal

Default: 43

Units: ASCII

S3 Command line termination character (user defined)

This register determines the ASCII values as the carriage return character. This character is used to end command lines and result codes.

Range: 0-127, ASCII decimal

Default: 13 (carriage return)

Units: ASCII

S4 Response formatting character (user defined)

This register determines the ASCII value used as the line feed character. The modem uses a line feed character in command mode when it responds to the computer.

Range: 0-127, ASCII decimal

Default: 10 (line feed)

Units: ASCII

S5 Command line editing character (user defined)

This register sets the character recognized as a backspace and pertains to asynchronous only. The modem will not recognize the backspace character if it is set to a value that is greater than 32 ASCII. This character can be used to edit a command line. When the echo command is enabled, the modem echoes back to the local DTE the backspace character, an ASCII space character, and a second backspace character. This means a total of three characters are transmitted each time the modem processes the backspace character.

Range: 0-127, ASCII decimal

Default: 8 (backspace)

Units: ASCII

S6 Wait before dialing

This register sets the length of time, in seconds, that the modem must wait (pause) after going off-hook before dialing the first digit of the telephone number. The modem always pauses for a minimum of two seconds, even if the value of S6 is less than two seconds. The wait for dial tone call progress feature (W dial modifier in the dial string) will override the value in register S6. This operation, however, may be affected by some ATX options according to country/region restrictions. In some countries/regions, S6 will set dial tone detect time.

Range: 3-255

Default: 3

Units: seconds

S7 Connection completion time-out

This register sets the time, in seconds, that the modem must wait before hanging up because carrier is not detected. The timer is started when the modem finishes dialing (originate), or goes off-hook (answer). In originate mode, the timer is reset upon detection of an answer tone if allowed by county restriction. The timer also specifies the wait for silence time for the @ dial modifier in seconds. S7 is not associated with the W dial modifier.

Range: 1-255

Default: 50

Units: seconds

S8 Comma pause time

This register sets the time, in seconds, that the modem must pause when it encounters a comma (,) in the dial command string. In some countries/regions, S8 will set both wait before dialing and comma pause time.

Range: 0-255

Default: 2

Units: seconds

S11 DTMF dialing speed

This register determines the dialing speed which is prefixed for each country/region.

Range: 50-255

Default: 95

Units: .001 seconds

S12 Escape guard time

This register sets the value (in 20 millisecond increments) for the required pause after the escape sequence.

Range: 0-255

Default: 50

Units: .02 seconds

S37 Dial line rate

S37=0 (default)	maximum modem speed
S37=1	reserved
S37=2	1200/75 bps
S37=3	300 bps
S37=4	reserved
S37=5	1200 bps
S37=6	2400 bps
S37=7	4800 bps
S37=8	7200 bps
S37=9	9600 bps
S37=10	12000 bps
S37=11	14400 bps
S37=12	16800 bps
S37=13	19200 bps
S37=14	21600 bps
S37=15	24000 bps
S37=16	26400 bps
S37=17	28800 bps
S37=18	31200 bps
S37=19	33600 bps

AT command set result codes

The following table shows the result codes.

The result code summary

Result Code	Numeric	Description
OK	0	Command executed
CONNECT	1	Modem connected to line
RING	2	A ring signal has been detected
NOCARRIER	3	Modem lost carrier signal, or does not detect carrier signal, or does not detect answer tone
ERROR	4	Invalid command
CONNECT1200EC*1	5	Connection at 1200 bps
NODIAL TONE	6	No dial tone detected
BUSY	7	Busy signal detected
NO ANSWER	8	No quiet answer
CONNECT2400EC*1	10	Connection at 2400 bps
CONNECT4800EC*1	11	Connection at 4800 bps
CONNECT9600EC*1	12	Connection at 9600 bps
CONNECT14400EC*1	13	Connection at 14400 bps
CONNECT19200EC*1	14	Connection at 19200 bps
CONNECT7200EC*1	24	Connection at 7200 bps
CONNECT12000EC*1	25	Connection at 12000 bps
CONNECT16800EC*1	86	Connection at 16800 bps
CONNECT300EC*1	40	Connection at 300 bps
CONNECT21600EC*1	55	Connection at 21600 bps
CONNECT24000EC*1	56	Connection at 24000 bps
CONNECT26400EC*1	57	Connection at 26400 bps
CONNECT28800EC*1	58	Connection at 28800 bps
CONNECT31200EC*1	59	Connection at 31200 bps
CONNECT33600EC*1	60	Connection at 33600 bps

Result Code	Numeric	Description
DELAYED*2	88	Delay is in effect for the dialed number
BLACKLISTED*2	89	Dialed number is blacklisted
BLACKLISTFULL*2	90	Blacklist is full

*1: *EC only appears when the Extended Result Codes configuration option is enabled. EC is replaced by one of the following symbols, depending upon the error control method used:*

V.42bis - V.42 error control and V.42bis data compression.

V.42 - V.42 error control only.

MNP 5 - MNP class 4 error control and MNP class 5 data compression.

MNP 4 - MNP class 4 error control only.

NoEC - No error control protocol.

*2: *In some countries/regions, these result codes may not appear.*

V.90

The TOSHIBA internal modem uses V.90 technology. The modem is capable of downstream speeds of 56Kbps (kilobits per second) when connected to an Internet service provider that supports V.90. As with any modem, the actual throughput (speed of data transfer) depends on analog telephone line conditions, which can vary considerably. Therefore, many users will experience throughput in the range of 28-50Kbps under normal telephone line conditions. Upstream data flows at the V.34 rate.

***NOTE:** V.90 rates can be achieved only when one V.90-capable host modem is connected to another. The TOSHIBA Internal modem will select automatically V.34 if the remote modem lacks V.90 capability or if a combination of network and/or phone line conditions prevent V.90 connection.*

V.90 mode

Function	Transmission speed
Data V.90	From 56K (maximum) to 28Kbps (minimum) Reception only

Table E-1 Result codes for a V.90 connection

No.	Result code	Description
70	CONNECT 32000 EC*	Connection at 32000 bps
72	CONNECT 36000 EC*	Connection at 36000 bps
74	CONNECT 40000 EC*	Connection at 40000 bps
76	CONNECT 44000 EC*	Connection at 44000 bps
78	CONNECT 48000 EC*	Connection at 48000 bps
80	CONNECT 52000 EC*	Connection at 52000 bps
82	CONNECT 56000 EC*	Connection at 56000 bps
100	CONNECT 28000 EC*	Connection at 28000 bps
101	CONNECT 29333 EC*	Connection at 29333 bps
102	CONNECT 30666 EC*	Connection at 30666 bps
103	CONNECT 33333 EC*	Connection at 33333 bps
104	CONNECT 34666 EC*	Connection at 34666 bps
105	CONNECT 37333 EC*	Connection at 37333 bps
106	CONNECT 38666 EC*	Connection at 38666 bps
107	CONNECT 41333 EC*	Connection at 41333 bps
108	CONNECT 42666 EC*	Connection at 42666 bps
109	CONNECT 45333 EC*	Connection at 45333 bps
110	CONNECT 46666 EC*	Connection at 46666 bps
111	CONNECT 49333 EC*	Connection at 49333 bps
112	CONNECT 50666 EC*	Connection at 50666 bps
113	CONNECT 53333 EC*	Connection at 53333 bps
114	CONNECT 54666 EC*	Connection at 54666 bps

*EC stands for the Error Control method, which appears only when the extended result codes configuration option is enabled. EC is replaced by one of the following symbols, depending on the error control method used.

V42bis V.42 error control and V.42bis data compression

V42 V.42 error control only

NoEC No error control protocol

AT Command

-V90=* V.90DialLineRate

-V90 sets the maximum V.90 downstream that the modem attempts to connect.

-V90=0 V.90 disabled

-V90=1 V.90 enabled: automatic speed selection - maximum modem speed (default)

Internal Modem Guide

This appendix describes how to install and the remove the internal modem.

***CAUTION:** Do not disassemble the computer beyond the steps described in this instruction or touch any components not specifically described.*

Installing the internal modem

***NOTE:** The internal modem is preinstalled. The following is for information only.*

To install the internal modem follow the procedures below.

Installing the modem board and jack

To install the modem board and jack, follow the steps below.

1. Save your data and turn off the computer.
2. Disconnect the AC adaptor and other peripheral devices.
3. Turn the computer upside down and remove the battery pack.
4. Remove one screw securing the Hard Disk Drive cover.
5. Pull the guide (plastic tab) toward the direction shown by arrow, then lift the HDD. Be careful not to damage the connector.
6. Remove two screws, which you use later to secure the modem board.
7. Connect the modem board cable and seat the modem board.
8. Secure the modem board with two screws removed in step 6.
9. Secure the cover with one screw.

Removing the internal modem

To remove the internal modem, follow the steps below.

1. Save your data and turn off the computer.
2. Disconnect the AC adaptor and any other peripheral device.
3. Turn the computer upside down and remove the battery pack.
4. Remove one screw securing the Hard Disk Drive cover.
5. Pull the guide (plastic tab) toward the direction shown by arrow, then lift the HDD. Be careful not to damage the connector.
6. Remove two screws and remove the modem board.
7. Disconnect the modem cable.
8. Secure the modem cover with one screw.
9. Install the battery pack.

Refer to the installation procedures for details.

Wireless LAN

This appendix is intended to help you get your Wireless LAN network up and running, with a minimum of parameters.

Card specifications

Form Factor	■ Mini PCI TypeIII
Capability	■ IEEE 802.11 Standard for Wireless LANS ■ Wi-Fi (Wireless Fidelity) certified by the Wi-Fi Alliance. The “Wi-Fi CERTIFIED” logo is a certification mark of the Wi-Fi Alliance.
Network Operating System	■ Microsoft Windows® Networking
Media Access Protocol	■ CSMA/CA (Collision Avoidance) with Acknowledgment (ACK)
Data Rate	■ 54/48/36/24/18/12/9/6 Mb/s (Revision A) ■ 11/5.5/2/1 Mb/s (Revision B) ■ 108/96/72/48/36/24/18/12 Mb/s (Turbo Mode)

Radio characteristics

Radio characteristics of Wireless LAN cards may vary according to:

- ◆ Country/region where the product was purchased
- ◆ Type of product

Wireless communication is often subject to local radio regulations. Although Wireless LAN wireless networking products have been designed for operation in the license-free 2.4 GHz and 5 GHz band, local radio regulations may impose a number of limitations to the use of wireless communication equipment.

NOTE: Refer to the sheet Information to the User for regulatory information that may apply in your country/region.

- R-F Frequency
 - Band 5 GHz (5150-5850 MHz) (Revision A, TurboMode)
 - Band 2.4 GHz (2400-2483.5 MHz) (Revision B)
- Modulation Technique
 - DSSS-CCK, DSSS-DQPSK, DSSS-DBPSK (Revision B)
 - OFDM-BPSK, OFDM-QPSK, OFDM-16QAM, OFDM-64QAM (Revision A, Turbo Mode)

The range of the wireless signal is related to the transmit rate of the wireless communication. Communications at lower transmit range may travel larger distances.

- ◆ The range of your wireless devices can be affected when the antennas are placed near metal surfaces and solid high-density materials.
- ◆ Range is also affected by "obstacles" in the signal path of the radio signals that may either absorb or reflect the radio signal.

Supported frequency sub-bands

Subject to the radio regulations that apply in your country/region, your Wireless LAN card may support a different set of 5 GHz/2.4 GHz channels.

Consult your Authorized Wireless LAN or TOSHIBA Sales office for information about the radio regulations that apply in your country/region.

Wireless IEEE 802.11 Channels Sets (Revision B)

ChannelID	Frequency Range 2400-2472MHz
1	2412
2	2417
3	2422
4	2427
5	2432
6	2437
7	2442
8	2447
9	2452
10	2457*
11	2462

* Factory-set default channels

When installing Wireless LAN Cards, the channel configuration is managed as follows:

- ❖ For wireless clients that operate in a Wireless LAN Infrastructure, the Wireless LAN Card will automatically start operation at the channel identified by the Wireless LAN Access Point, When roaming between different access points the station can dynamically switch to another channel if required.
- ❖ For Wireless LAN Cards installed in Wireless clients that operating in a peer-to-peer mode, the card will use the default channel 10.
- ❖ In a Wireless LAN Access Point, the Wireless LAN card will use the factory-set default channel (printed in bold), unless the LAN Administrator selected a different channel when configuring the Wireless LAN Access Point device.

Wireless IEEE 802.11 Channels Sets (Revision A)

ChannelID	Frequency Range 5150-5850 MHz	Note
36	5180	
40	5200	
44	5220	
48	5240	
52	5260	
56	5280	
60	5300	
64	5320	
149	5745	US only *1
153	5765	US only *1
157	5785	US only *1
161	5805	US only *1

*1: Available Area: US (USA, CANADA) only

Wireless Channels Sets (Turbo Mode)

ChannelID	Frequency Range 5150-5850 MHz	Note
42	5210	US only *1
50	5250	US only *1
58	5290	US only *1
152	5760	US only *1
160	5800	US only *1

*1: Available Area: US (USA, CANADA) only

APPENDIX G

AC Power Cord and Connectors

The power cord's AC input plug must be compatible with the various international AC power outlets and the cord must meet the standards for the country/region in which it is used. All cords must meet the following specifications:

Length:	Minimum 2 meters
Wire size:	Minimum 0.75 mm ²
Current rating:	Minimum 2.5 amperes
Voltage rating:	125 or 250 VAC (depending on country/region's power standards)

Certification agencies

U.S. and Canada: UL listed and CSA certified

No. 18 AWG, Type SVT or SPT-2 two conductor

Europe:

Austria:	OVE	Italy:	IMQ
Belgium:	CEBEC	The Netherlands:	KEMA
Denmark:	DEMKO	Norway:	NEMKO
Finland:	SETI	Sweden:	SEMKO
France:	UTE	Switzerland:	SEV
Germany:	VDE	United Kingdom:	BSI

Australia: AS

Japan: DENANHO

In Europe, power cords must be VDE type, H05VVH2-F and two conductor.

For the United States and Canada, plug configuration must be a 2-15P (250 V) or 1-15P (125 V) as designated in the U.S. National Electrical code handbook and the Canadian Electrical Code Part II.

The following illustrations show the plug shapes for the U.S.A. and Canada, the United Kingdom, Australia and Europe.

USA and Canada

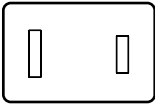

UL approved
CSA approved

United Kingdom

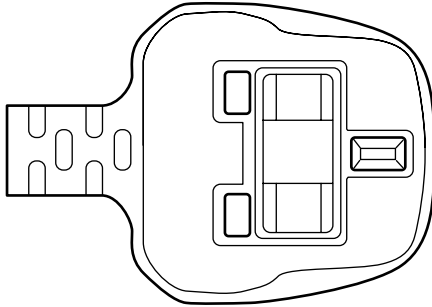

BS approved

Australia

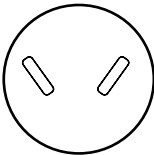

AS approved

Europe

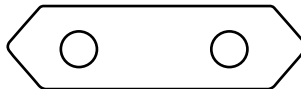

Approved by the
appropriate agency

Parts Numbers

The computer configuration and parts numbers, printed on a label on the bottom of the computer, indicate the CPU, LCD, memory, HDD, ODD and communication devices.

Configurations

The following table shows the computer configuration indicated on a label. Shaded areas indicate abbreviations used on the label. The explanations are to the left of the shading. Abbreviations are not limited to those in this chart. They may change without notice.

CPU DT Pentium4		LCD		Memory		HDD		ODD		Communicaiton	
2.53G*	P4-2.53	14" TFT-XGA	14X	256MB	256M	30G	30	CD-RW/DVD-ROM	RW/DV	802.11b	WLb
2.66G	P4-2.66	15" TFT-XGA	15X	256MB+256MB	512M	40G	40	DVD-R/-RW	DVR	802.11a/b combo	WLab
2.80G	P4-2.80	15" TFT-SXGA+	15+	512MB	512M	60G	60	DVD Multi	DRM		
3.06G	P4-3.06			512MB+256MB	768M	80G	80				
				512MB+512MB	1024M						

* Figures indicate the CPU operating speed in gigahertz. For example, P4-2.53 means Intel® Pentium® 4 processor 2.53 GHz.

Glossary

The terms in this glossary cover topics related to this manual. Alternate naming is included for reference.

Abbreviations

AC: alternating current	DVD-ROM: Digital Versatile Disc Read Only Memory
AGP: accelerated graphics port	DVD-RW: Digital Versatile Disc Read/Write
ANSI: American National Standards Institute	ECP: extended capabilities port
APM: advanced power manager	FDD: floppy disk drive
ASCII: American Standard Code for Information Interchange	FIR: fast infrared
BIOS: basic input output system	GB: gigabyte
CD-ROM: Compact Disc-Read Only Memory	HDD: hard disk drive
CD-RW: Compact Disc-Read/Write	IDE: integrated drive electronics
CMOS: complementary metal-oxide semiconductor	I/O: input/output
CPU: central processing unit	IrDA: Infrared Data Association
CRT: cathode ray tube	IRQ: interrupt request
DC: direct current	KB: kilobyte
DDC: display data channel	LCD: liquid crystal display
DMA: direct memory access	LED: light emitting diode
DOS: disk operating system	LSI: large scale integration
DVD: digital versatile disc	MB: megabyte
DVD-R: Digital Versatile Disc Recordable	OCR: optical character recognition (reader)
DVD-RAM: Digital Versatile Disc Random Access Memory	PCB: printed circuit board
	PCI: peripheral component interconnect
	RAM: random access memory
	RGB: red, green, and blue

(Abbreviations continued)

ROM: read only memory

RTC: real time clock

SCSI: small computer system interface

SIO: serial input/output

SXGA+: super extended graphics array plus

TFT: thin-film transistor

UART: universal asynchronous receiver/transmitter

USB: Universal Serial Bus

VESA: Video Electronic Standards Association

VGA: video graphics array

VRT: voltage reduction technology

XGA: extended graphics array

A

adaptor: A device that provides an interface between two dissimilar electronic devices. For example, the AC adaptor modifies the power from a wall outlet for use by the computer. This term also refers to the add-in circuit cards that control external devices, such as video monitors and magnetic tape devices.

allocate: To assign a space or function for a specific task.

alphanumeric: Keyboard characters including letters, numbers and other symbols, such as punctuation marks or mathematical symbols.

alternating current (AC): Electric current that reverses its direction of flow at regular intervals.

analog signal: A signal whose characteristics such as amplitude and frequency vary in proportion to (are an analog of) the value to be transmitted. Voice communications are analog signals.

ANSI: American National Standards Institute. An organization established to adopt and define standards for a variety of technical disciplines. For example, ANSI defined the ASCII standard and other information processing requirements.

antistatic: A material used to prevent the buildup of static electricity.

application: A group of programs that together are used for a specific task such as accounting, financial planning, spreadsheets, word processing and games.

ASCII: American Standard Code for Information Interchange. ASCII code is a set of 256 binary codes that represent the most commonly used letters, numbers, and symbols.

async: Short for asynchronous.

asynchronous: Lacking regular time relationship. As applied to computer communications, asynchronous refers to the method of transmitting data that does not require a steady stream of bits to be transmitted at regular time intervals.

B

backup: A duplicate copy of files kept as a spare in case the original is destroyed.

batch file: A file that can be executed from the system prompt containing a sequence of operating system commands or executable files.

binary: The base two number system composed of zeros and ones (off or on), used by most digital computers. The right-most digit of a binary number has a value of 1, the next a value of 2, then 4, 8, 16, and so on. For example, the binary number 101 has a value of 5. *See also* ASCII.

BIOS: Basic Input Output System. The firmware that controls data flow within the computer. *See also* firmware.

bit: Derived from "binary digit," the basic unit of information used by the computer. It is either zero or one. Eight bits is one byte. *See also* byte.

board: A circuit board. An internal card containing electronic components, called chips, which perform a specific function or increase the capabilities of the system.

boot: Short for bootstrap. A program that starts or restarts the computer. The program reads instructions from a storage device into the computer's memory.

bps: Bits per second. Typically used to describe the data transmission speed of a modem.

buffer: The portion of the computer's memory where data is temporarily stored. Buffers often compensate for differences in the rate of flow from one device to another.

bus: An interface for transmission of signals, data or electric power.

byte: The representation of a single character. A sequence of eight bits treated as a single unit; also the smallest addressable unit within the system.

C

cache memory: High speed memory which stores data that increases processor speed and data transfer rate. When the CPU reads data from main memory, it stores a copy of this data in cache memory. The next time the CPU needs that same data, it looks for it in the cache memory rather than the main memory, which saves time. The computer has two cache levels. Level one is incorporated into the processor and level two resides in external memory.

capacity: The amount of data that can be stored on a magnetic storage device such as a diskette (floppy disk) or hard disk. It is usually described in terms of kilobytes (KB), where one KB = 1024 bytes and megabytes (MB), where one MB = 1024 KB.

card: Synonym for board. *See* board.

CardBus: An industry standard bus for 32-bit PC cards.

CD-ROM: A Compact Disc-Read Only Memory is a high capacity disc that can be read from but not written to. The CD-ROM drive uses a laser, rather than magnetic heads, to read data from the disc.

CD-RW: A Compact Disc-Read/Write disc can be rewritten many times.

character: Any letter, number, punctuation mark, or symbol used by the computer. Also synonymous with byte.

chassis: The frame containing the computer.

chip: A small semiconductor containing computer logic and circuitry for processing, memory, input/output functions and controlling other chips.

CMOS: Complementary Metal-Oxide Semiconductor. An electronic circuit fabricated on a silicon wafer that requires very little power. Integrated circuits implemented in CMOS technology can be tightly packaged and are highly reliable.

cold start: Starting a computer that is currently off (turning on the power).

COM1, COM2, COM3 and COM4: The names assigned to the serial and communication ports.

commands: Instructions you enter at the terminal keyboard that direct the actions of the computer or its peripheral devices.

communications: The means by which a computer transmits and receives data to and from another computer or device. *See* parallel interface; serial interface.

compatibility: 1) The ability of one computer to accept and process data in the same manner as another computer without modifying the data or the media upon which it is being transferred. 2) the ability of one device to connect to or communicate with another system or component.

components: Elements or parts (of a system) which make up the whole (system).

computer program: A set of instructions written for a computer that enable it to achieve a desired result.

computer system: A combination of hardware, software, firmware, and peripheral components assembled to process data into useful information.

configuration: The specific components in your system (such as the terminal, printer, and disk drives) and the settings that define how your system works. You use the HW Setup program to control your system configuration.

control keys: A key or sequence of keys you enter from the keyboard to initiate a particular function within a program.

controller: Built-in hardware and software that controls the functions of a specific internal or peripheral device (e.g. keyboard controller).

co-processor: A circuit built into the processor that is dedicated to intensive math calculations.

CPS: Characters Per Second. Typically used to indicate the transmission speed of a printer.

CPU: Central Processing Unit. The portion of the computer that interprets and executes instructions.

CRT: Cathode Ray Tube. A vacuum tube in which beams projected on a fluorescent screen-producing luminous spots. An example is the television set.

cursor: A small, blinking rectangle or line that indicates the current position on the display screen.

D

data: Information that is factual, measurable or statistical that a computer can process, store, or retrieve.

data bits: A data communications parameter controlling the number of bits (binary digits) used to make up a byte. If data bits = 7 the computer can generate 128 unique characters. If data bits = 8 the computer can generate 256 unique characters.

DC: Direct Current. Electric current that flows in one direction. This type of power is usually supplied by batteries.

default: The parameter value automatically selected by the system when you or the program do not provide instructions. Also called a preset value.

delete: To remove data from a disk or other data storage device. Synonymous with erase.

device driver: A program that controls communication between a specific peripheral device and the computer. The CONFIG.SYS file contains device drivers that MS-DOS loads when you turn the computer on.

dialog box: A window that accepts user input to make system settings or record other information.

disk drive

disk drive: The device that randomly accesses information on a disk and copies it to the computer's memory. It also writes data from memory to the disk. To accomplish these tasks, the unit physically rotates the disk at high speed past a read-write head.

disk storage: Storing data on magnetic disk. Data is arranged on concentric tracks much like a phonograph record.

diskette: A removable disk that stores magnetically encoded data. Also called a floppy disk.

display: A CRT, LCD, or other image producing device used to view computer output.

documentation: The set of manuals and/or other instructions written for the users of a computer system or application. Computer system documentation typically includes procedural and tutorial information as well as system functions.

driver: A software program, generally part of the operating system, that controls a specific piece of hardware (frequently a peripheral device such as a printer or mouse).

DVD-R: A Digital Versatile Disc-Recordable disk can be written once and read many times.

DVD-RAM: A Digital Versatile Disc Random Access Memory is a high-capacity, high performance disc that lets you store large volumes of data. The DVD drive uses a laser to read data from the disc.

DVD-ROM: A Digital Versatile Disc Read Only Memory is a high capacity, high performance disc suitable for play back of video and other high-density files. The DVD drive uses a laser to read data from the disc.

DVD-RW: A Compact Disc-Read/Write disc can be rewritten many times.

E

echo: To send back a reflection of the transmitted data to the sending device. You can display the information on the screen, or output it to the printer, or both. When a computer receives back data it transmitted to a CRT (or other peripheral device) and then retransmits the data to printer, the printer is said to echo the CRT.

erase: *See* delete.

escape: 1) A code (ASCII code 27), signaling the computer that what follows are commands; used with peripheral devices such as printers and modems. 2) A means of aborting the task currently in progress.

escape guard time: A time before and after an escape code is sent to the modem which distinguishes between escapes that are part of the transmitted data, and escapes that are intended as a command to the modem.

execute: To interpret and execute an instruction.

Extended Capability Port: An industry standard that provides a data buffer, switchable forward and reverse data transmission, and run length encoding (RLE) support.

F

fast infrared: An industry standard that enables cableless infrared serial data transfer at speeds of up to 4 Mbps.

file: A collection of related information; a file can contain data, programs, or both.

firmware: A set of instructions built into the hardware which controls and directs a microprocessor's activities.

fixed disk: *See* hard disk.

floppy disk: *See* diskette.

floppy disk drive (FDD): An electro-mechanical device that reads and writes to floppy disks. *See also* diskette.

Fn-esse: A TOSHIBA utility that lets you assign functions to hot keys.

folder: An icon in Windows used to store documents or other folders.

format: The process of readying a blank disk for its first use. Formatting establishes the structure of the disk that the operating system expects before it writes files or programs onto the disk.

function keys: The keys labeled **F1** through **F12** that tell the computer to perform certain functions.

G

gigabyte (GB): A unit of data storage equal to 1024 megabytes. *See also* megabyte.

graphics: Drawings, pictures, or other images, such as charts or graphs, to present information.

H

hard disk: A non-removable disk usually referred to as drive C. The factory installs this disk and only a trained engineer can remove it for servicing. Also called fixed disk.

hard disk drive (HDD): An electro-mechanical device that reads and writes a hard disk. *See also* hard disk.

hardware: The physical electronic and mechanical components of a computer system: typically, the computer itself, external disk drives, etc. *See also* software and firmware.

hertz: A unit of wave frequency that equals one cycle per second.

hexadecimal: The base 16 numbering system composed of the digits 0 through 9 and the letters A, B, C, D, E, and F.

host computer: The computer that controls, regulates, and transmits information to a device or another computer.

hotkey: The computer's feature in which certain keys in combination with the extended function key, **Fn**, can be used to set system parameters, such as speaker volume.

HW Setup: A TOSHIBA utility that lets you set the parameters for various hardware components.

I

icon: A small graphic image displayed on the screen or in the indicator panel. In Windows, an icon represents an object that the user can manipulate.

infrared port: A cableless communications port capable of using infrared signals to send serial data.

input: The data or instructions you provide to a computer, communication device or other peripheral device from the keyboard or external or internal storage devices. The data sent (or output) by the sending computer is input for the receiving computer.

instruction: Statements or commands that specify how to perform a particular task.

interface: 1) Hardware and/or software components of a system used specifically to connect one system or device to another. 2) To physically connect one system or device to another to exchange information. 3) The point of contact between user, the computer, and the program, for example, the keyboard or a menu.

interrupt request: A signal that gives a component access to the processor.

I/O: Input/output. Refers to acceptance and transfer of data to and from a computer.

I/O devices: Equipment used to communicate with the computer and transfer data to and from it.

IrDA 1.1: An industry standard that enables cableless infrared serial data transfer at speeds of up to 4 Mbps.

K

K: Taken from the Greek word kilo, meaning 1000; often used as equivalent to 1024, or 2 raised to the 10th power. *See also* byte and kilobyte.

KB: *See* kilobyte.

keyboard: An input device containing switches that are activated by manually pressing marked keys. Each keystroke activates a switch that transmits a specific code to the computer. For each key, the transmitted code is, in turn, representative of the (ASCII) character marked on the key.

kilobyte (KB): A unit of data storage equal to 1024 bytes. *See also* byte and megabyte.

L

level 2 cache: *See* cache.

Light Emitting Diode (LED): A semiconductor device that emits light when a current is applied.

Liquid Crystal Display (LCD): Liquid crystal sealed between two sheets of glass coated with transparent conducting material. The viewing-side coating is etched into character forming segments with leads that extend to the edge of the glass. Applying a voltage between the glass sheets alters the brightness of the liquid crystal.

LSI: Large Scale Integration. 1) A technology that allows the inclusion of up to 100,000 simple logic gates on a single chip. 2) An integrated circuit that uses large scale integration.

M

main board: *See* motherboard.

megabyte (MB): A unit of data storage equal to 1024 kilobytes. *See also* kilobyte.

megahertz: A unit of wave frequency that equals 1 million cycles per second. *See also* hertz.

menu: A software interface that displays a list of options on the screen. Also called a screen.

microprocessor: A hardware component contained in a single integrated circuit that carries out instructions. Also called the central processing unit (CPU), one of the main parts of the computer.

mode: A method of operation, for example, the boot mode, standby mode or the hibernation mode.

modem: Derived from modulator/demodulator, a device that converts (modulates) digital data for transmission over telephone lines and then converts modulated data (demodulates) to digital format where received.

monitor: A device that uses rows and columns of pixels to display alphanumeric characters or graphic images. *See also* CRT.

motherboard: A name sometimes used to refer to the main printed circuit board in processing equipment. It usually contains integrated circuits that perform the processor's basic functions and provides connectors for adding other boards that perform special functions. Sometimes called a main board.

MP3: An audio compression standard that enables high-quality transmission and real-time playback of sound files.

N

non-system disk: A formatted diskette (floppy disk) you can use to store programs and data but you cannot use to start the computer. *See* system disk.

nonvolatile memory: Memory, usually read-only (ROM), that is capable of permanently storing information. Turning the computer's power off does not alter data stored in nonvolatile memory.

numeric keypad overlay: A feature that allows you to use certain keys on the keyboard to perform numeric entry, or to control cursor and page movement.

O

OCR: Optical Character Recognition (reader). A technique or device that uses laser or visible light to identify characters and input them into a storage device.

online state: A functional state of a peripheral device when it is ready to receive or transmit data.

operating system: A group of programs that controls the basic operation of a computer. Operating system functions include interpreting programs, creating data files, and controlling the transmission and receipt (input/output) of data to and from memory and peripheral devices.

output: The results of a computer operation. Output commonly indicates data 1) printed on paper, 2) displayed at a terminal, 3) sent through the serial port of internal modem, or 4) stored on some magnetic media.

P

parallel interface: Refers to a type of information exchange that transmits information one byte (8 bits) at a time. *See also* serial interface.

parity: 1) The symmetrical relationship between two parameter values (integers) both of which are either on or off; odd or even; 0 or 1. 2) In serial communications, an error detection bit that is added to a group of data bits making the sum of the bits even or odd. Parity can be set to none, odd, or even.

password: A unique string of characters used to identify a specific user. The computer provides various levels of password protection such as user, supervisor and eject.

pel: The smallest area of the display that can be addressed by software. Equal in size to a pixel or group of pixels. *See* pixel.

peripheral component interconnect: An industry standard 32-bit bus.

peripheral device: An I/O device that is external to the central processor and/or main memory such as a printer or a mouse.

pixel: A picture element. The smallest dot that can be made on a display or printer. Also called a pel.

plug and play: A capability with Windows that enables the system to automatically recognize connections of external devices and make the necessary configurations in the computer.

port: The electrical connection through which the computer sends and receives data to and from devices or other computers.

Power Saver Utility: A TOSHIBA utility that lets you set the parameters for various power-saving functions.

printed circuit board (PCB): A hardware component of a processor to which integrated circuits and other components are attached. The board itself is typically flat and rectangular, and constructed of fiberglass, to form the attachment surface.

program: A set of instructions a computer can execute that enables it to achieve a desired result. *See also* application.

prompt: A message the computer provides indicating it is ready for or requires information or an action from you.

Radio frequency interference (RFI) shield

R

Radio frequency interference (RFI) shield: A metal shield enclosing the printed circuit boards of the printer or computer to prevent radio and TV interference. All computer equipment generates radio frequency signals. The FCC regulates the amount of signals a computing device can allow past its shielding. A Class A device is sufficient for office use. Class B provides a more stringent classification for home equipment use. TOSHIBA portable computers comply with Class B computing device regulations.

Random Access Memory (RAM): High speed memory within the computer circuitry that can be read or written to.

restart: Resetting a computer without turning it off (also called “warm boot” or “soft reset”). *See also* boot.

RGB: Red, green, and blue. A device that uses three input signals, each activating an electron gun for a primary additive color (red, green, and blue) or port for using such a device. *See also* CRT.

RJ11: A modular telephone jack.

RJ45: A modular LAN jack.

ROM: Read Only Memory: A nonvolatile memory chip manufactured to contain information that controls the computer’s basic operation. You cannot access or change information stored in ROM.

S

SCSI: Small Computer System Interface is an industry standard interface for connection of a variety of peripheral devices.

SD cards: Secure Digital cards are flash memory widely used in a variety of digital devices such as digital cameras and Personal Digital Assistants.

SIO: Serial Input/Output. The electronic methodology used in serial data transmission.

soft key: Key combinations that emulate keys on the IBM keyboard, change some configuration options, stop program execution, and access the numeric keypad overlay.

software: The set of programs, procedures and related documentation associated with a computer system. Specifically refers to computer programs that direct and control the computer system’s activities. *See also* hardware.

stop bit: One or more bits of a byte that follow the transmitted character or group codes in asynchronous serial communications.

subpixel: Three elements, one red, one green and blue (RGB), that make up a pixel on the color LCD. The computer sets subpixels independently, each may emit a different degree of brightness. *See also* pixel.

synchronous: Having a constant time interval between successive bits, characters or events.

system disk: A disk that has been formatted with an operating system. For MS-DOS the operating system is contained in two hidden files and the COMMAND.COM file. You can boot a computer using a system disk. Also called an operating system disk.

T

terminal: A typewriter-like keyboard and CRT display screen connected to the computer for data input/output.

TFT: Thin-film transistor, a color LCD technology that applies individual transistors to each pixel enabling fine display control and excellent screen legibility.

Touch Pad: A pointing device integrated into the TOSHIBA computer palm rest.

TTL: Transistor-transistor logic. A logic circuit design that uses switching transistors for gates and storage.

U

Universal Serial Bus: This serial interface lets you communicate with several devices connected in a chain to a single port on the computer.

V

VGA: Video Graphics Array is an industry standard video adaptor that lets you run any popular software.

volatile memory: Random access memory (RAM) that stores information as long as power is supplied to the computer.

W

warm start: Restarting or resetting a computer without turning it off.

window: A portion of the screen that can display its own application, document or dialog box. Often used to mean a Microsoft Windows window.

Wireless LAN: Local Area Network (LAN) through wireless communication.

write protection: A method for protecting a diskette (floppy disk) from accidental erasure.

Index

A

- AC adaptor, *See* Universal AC adaptor
- ASCII characters 5-9
- AT commands Appendix C
- Audio/Video control buttons 1-5, 2-1, 4-8
 - location 2-1

B

- Battery
 - automatic hibernation 1-8
 - charging 6-8
 - extending life 6-11
 - indicator 2-9, 6-2
 - location 2-6
 - monitoring capacity 6-9
 - real time clock 1-2, 6-4
 - safety precautions 6-5
 - save mode 1-8
 - saving power 6-10
 - types 6-3

- Battery pack 1-2, 2-6, 6-3
 - additional 1-10, 8-13
 - replacing 6-12

- Boot mode 3-7
- Boot priority 7-6

C

- Cache memory 1-2
- CD-RW/DVD-ROM drive 1-3, *See also* Optical media drives
 - location 2-3
 - problems 9-10
 - specifications 2-13
 - writing CDs 4-10
- Cleaning the computer 4-28

- ConfigFree 1-9
- Cooling (heat dispersal) 1-8
 - fan 2-6
 - settings 4-29
 - vents
 - precaution 2-2
 - location 2-2, 2-4, 2-6
- CPU, *See* Processor

D

- Diskette drive 1-3
 - USB kit 1-10, 8-13
 - using 4-2
 - view 2-11
- Display 1-4, 2-8
 - automatic power off 1-7
 - brightness decrease 5-5
 - brightness increase 5-6
 - location 2-7
 - opening 3-6
 - problems 9-8
 - selection 5-5
- Documentation list 1-2
- Drag 'n Drop CD+DVD 1-10, 4-17
- DVD Multi drive 1-4, *See also* Optical media drives
 - location 2-3
 - problems 9-13
 - specifications 2-14
 - writing CD/DVDs 4-13
- DVD-R/-RW drive 1-3, *See also* Optical media drives
 - location 2-3
 - problems 9-11
 - specifications 2-14
 - writing CD/DVDs 4-12
- DVD Video Player 1-9

E

- Environment 3-1
- Equipment checklist 1-1
- Equipment setup
 - general conditions 3-2
 - placement 3-2
- Ergonomics
 - lighting 3-4
 - seating and posture 3-3
 - work habits 3-4
- Expansion memory, *See* Memory

F

- Fn + Ctrl (enhanced keyboard simulation) 5-3
- Fn + Enter 5-3
- Fn + Esc (sound mute) 5-4
- Fn + F1 (instant security) 5-4
- Fn + F2 (power save mode) 5-4
- Fn + F3 (standby) 5-5
- Fn + F4 (hibernation) 5-5
- Fn + F5 (display selection) 5-5
- Fn + F6 (display brightness) 5-5
- Fn + F7 (display brightness) 5-6
- Fn + F8 (wireless setting) 5-6
- Fn + F9 (Touch Pad) 5-6
- Fn + F10 (arrow mode) 5-3
- Fn + F11 (numeric mode) 5-3
- Fn + F12 (ScrLock) 5-3
- Fn-esse 1-9
- Fn Sticky key 5-6
- Function keys 5-2

G

- Graphics controller 1-4

H

- Hard disk drive 1-3
 - automatic power off 1-7
 - problems 9-9

- Headphone jack, *See* Sound system
- Heat dispersal, *See* Cooling
- Hibernation 1-7
 - automatic 1-7
 - setting 3-8
- Hot keys 1-7
 - display brightness decrease 5-5
 - display brightness increase 5-6
 - display selection 5-5
 - hibernation 5-5
 - instant security 5-4
 - power save mode 5-4
 - sound mute 5-4
 - standby 5-5
 - Touch Pad setting 5-6
 - wireless setting 5-6

HW Setup 1-9

- accessing 7-1
- boot priority 7-6
- device config 7-5
- display 7-5
- general 7-1
- keyboard 7-8
- LAN 7-9
- parallel/printer 7-5
- password 7-2
- USB 7-8
- window 7-1

I

Indicators

- keyboard 2-10
- system 2-2, 2-8
 - location 2-1

Infrared port 1-5, 2-3

- location 2-2
- problems 9-16

Instant security, *See* Hot keys

Interfaces, *See* Ports

K

- Keyboard 1-4, 5-1
 - emulating enhanced keyboard 5-2
 - F1 ... F12 function keys 5-2
 - Fn Sticky key 5-6
 - hot keys 5-4
 - problems 9-8
 - typewriter keys 5-1
 - Windows special keys 5-7
- Keypad overlay 1-8, 5-7
 - arrow mode 5-7
 - numeric mode 5-8
 - temporarily using normal keyboard (overlay on) 5-8
 - temporarily using overlay (overlay off) 5-9
 - turning on the overlays 5-7

L

- LAN 1-6, 2-5
 - connecting 4-26
 - disconnecting 4-27
 - jack/indicators location 2-4
 - LAN active indicator 2-5
 - link indicator 2-5
 - problems 9-22
- LCD, *See* Display, Video modes and Monitor external
- Level 2 cache, *See* Cache memory
- Line-in jack, *See* Sound system
- Lock security, *See* Security lock

M

- Media care
 - CD/DVDs 4-20
 - diskettes 4-20
 - SD card 8-5
- Memory 1-2
 - expansion 1-10
 - installing 8-7
 - problems 9-19

- removing 8-11
- Microphone jack, *See* Sound system
- Mode Control button 1-5, 2-1, 4-8
 - location 2-1
- Modem 1-6, 2-4, 4-21
 - connecting 4-23
 - disconnecting 4-24
 - installation Appendix F
 - jack location 2-3
 - problems 9-21
 - properties menu 4-22
 - region selection 4-21
 - V.90 Appendix E
- Monitor, external 1-4, 2-6, 8-13
 - port location 2-4
 - problems 9-20
- Moving the computer 4-28

N

- Numeric keypad, *See* Keypad overlay

O

- Optical media drives 2-12, *Also see the entries for each drive type*
 - formats 2-13
 - region codes for DVD 2-12
 - using 4-3
 - writable discs 2-12
- Overlay, *See* Keypad overlay

P

- Panel power on/off, *See* Power
- Parallel port, *See* Ports, parallel and Printer
- Parts numbers Appendix I
- Password
 - Key FD 7-4
 - power on 1-8
 - problems 9-7
 - starting the computer by 6-15
 - supervisor 7-9
 - user 7-2

- PC card 1-5, 2-2
 - inserting 8-2
 - location of slot 2-2
 - problems 9-16
 - removing 8-3
 - Pointing device, *See* Touch Pad
 - Ports
 - external monitor 1-4
 - infrared 1-5
 - parallel 1-4
 - TV out 1-5
 - USB 1-5
 - Power
 - button location 2-7
 - conditions 6-1
 - cords Appendix H
 - indicator 6-3
 - panel on/off 1-8, 6-16
 - problems 9-4
 - system auto off 6-16
 - turning off 3-7
 - hibernation mode 3-8
 - shut down mode (boot mode) 3-7
 - standby mode 3-10
 - turning on 3-6
 - Power supply 1-8
 - Power-up modes 6-15
 - Printer
 - HW Setup 7-5
 - parallel 1-4, 2-6, 8-16
 - port location 2-4
 - problems 9-24
 - Problems
 - AC power 9-5
 - analyzing symptoms 9-2
 - battery 9-6
 - CD-RW/DVD-ROM drive 9-10
 - Diskette drive 9-15
 - DVD Multi drive 9-13
 - DVD-R/-RW drive 9-11
 - hard disk drive 9-9
 - hardware and system checklist 9-3
 - infrared port 9-16
 - keyboard 9-8
 - LAN 9-22
 - LCD panel 9-8
 - memory expansion 9-19
 - modem 9-21
 - monitor external 9-20
 - mouse, USB 9-18
 - overheating power down 9-5
 - password 9-7
 - PC card 9-16
 - power 9-4
 - printer 9-24
 - RTC battery 9-7
 - SD card 9-15
 - self test 9-4
 - sound system 9-20
 - support from TOSHIBA 9-25
 - system start-up 9-3
 - Touch Pad 9-17
 - TV output signal 9-23
 - USB 9-19
 - Wireless LAN 9-23
 - Processor 1-2
- R**
- Real time clock battery, *See* battery
 - Recovery CD-ROM 3-12
 - Restarting the computer 3-12
- S**
- SD card 1-5, 2-4
 - care 8-5
 - indicator 2-4
 - inserting 8-4
 - location of slot/indicator 2-3
 - problems 9-15
 - removing 8-5
 - Security lock 1-6, 1-10, 2-2
 - connecting 8-17
 - location 2-2

Self test, *See* Problems

Soft keys

- emulating enhanced keyboard 5-2
- Enter 5-3
- right Ctrl key 5-3
- ScrLock 5-3

Sound system 1-5

- headphone jack 1-5, 2-3
- jack locations 2-3
- line-in jack 1-5, 2-4
- microphone jack 1-5, 2-3
- mute hot keys 5-4
- problems 9-20
- speakers 2-8
 - location 2-7
- volume control 2-1
 - location 2-1

Specifications Appendix A

S-registers Appendix D

Standby 1-7

- automatic 1-7
- setting 3-10

System indicators, *See* indicators

T

TOSHIBA Controls 1-9

TOSHIBA Power Saver 1-9

Touch Pad 1-4, 2-8

- control buttons 2-8
- location 2-7
- problems 9-17
- using 4-1

Troubleshooting, *See* Problems

TV

- changing the resolution 8-14
- connecting 8-14
- port 1-5, 2-5
 - location 2-4
- problems 9-23

U

Universal AC adaptor 1-3, 2-5

- additional 1-10, 8-13
- connecting 3-5
- DCIN 15V port location 2-4
- view 2-15

USB 1-5, 2-5

- FDD kit, *See* Diskette drive
- mouse problems 9-18
- port location 2-4
- problems 9-19

V

Video modes Appendix B

Video RAM 1-2

Volume control, *See* Sound system

W

Wireless LAN 1-6

- kit 1-10
- problems 9-23
- specifications Appendix G
- using 4-24
- wireless communication indicator
 - 2-3, 4-25
 - location 2-2
- wireless communication switch 2-3, 4-25
 - location 2-2

Free Manuals Download Website

<http://myh66.com>

<http://usermanuals.us>

<http://www.somanuals.com>

<http://www.4manuals.cc>

<http://www.manual-lib.com>

<http://www.404manual.com>

<http://www.luxmanual.com>

<http://aubethermostatmanual.com>

Golf course search by state

<http://golfingnear.com>

Email search by domain

<http://emailbydomain.com>

Auto manuals search

<http://auto.somanuals.com>

TV manuals search

<http://tv.somanuals.com>