

***TEC***

TEC Bar Code Printer

**B-443**

**Owner's Manual**

**TOSHIBA TEC CORPORATION**

## LIST OF STANDARDS OF CONFORMITY

Manufacturer : TOSHIBA TEC Corporation  
Address : 570 Ohito, Ohito-cho, Tagata-Gun, Shizuoka-ken, 410-2392  
Japan

declares that following product

Product Name : Bar Code Printer  
Model : B-443-QP  
Options : All

conforms to the following product specifications

Safety : EN 60950  
EMC : EN 55022  
EN 50082-1

### Supplementary Information

The product herewith complies with the requirements of the Low Voltage Directive 73/23/ECC, and the EMC directive 89/336/ECC.

## TÜV / GS

### Wichtige Sicherheitshinweise

1. Bitte lesen Sie diese Hinweise sorgfältig durch.
2. Bewahren Sie diese Anleitung für den späteren Gebrauch auf.
3. Vor dem Reinigungsvorgang ist der Drucker von Stromnetz zu trennen.  
Verwenden Sie keine Flüssig-oder Aerosolreiniger. Am besten eignet sich ein angefeuchtetes Tuch.
4. Die Netzsteckdose sollte nah am Drucker liegen und leicht zugänglich sein.
5. Der Drucker ist vor Feuchtigkeit zu schützen.
6. Bei der Aufstellung ist auf einen sicheren Stand der Druckers zu achten. Ein Kippen oder Fallen könnte Beschädigungen hervorrufen.
7. Beachten Sie die Anschlußwerte der Druckers beim Anschluß an das Stromnetz.
8. Diese Gerät kann bis zu einer Außentemperatur von maximal 40°C betrieben werden.

Copyright ©1999  
by TOSHIBA TEC CORPORATION  
All Rights Reserved  
570 Ohito, Ohito-cho, Tagata-gun, Shizuoka-ken, JAPAN

**CAUTION:**

1. This manual may not be copied in whole or in part without prior written permission of TOSHIBA TEC.
2. The contents of this manual may be changed without notification.
3. Please refer to your local Authorized Service representative with regard to any queries you may have in this manual.

Changes or modifications not expressly approved by manufacturer for compliance could void the user's authority to operate the equipment.

**CAUTION:**

*To avoid injury, be careful not to catch or jam your fingers while opening or closing the cover.*

**CAUTION:**

*Do not touch moving parts. To reduce the risk that fingers, jewelry, clothing, etc., be drawn into the moving parts, push the switch in the "OFF" position to stop movement.*

# CONTENTS

|   |           |
|---|-----------|
| <b>1. PRODUCT INTRODUCTION .....</b>                    | <b>1</b>  |
| 1.1 Compliances .....                                   | 1         |
| <b>2. GETTING STARTED .....</b>                         | <b>2</b>  |
| 2.1 Applicable Model .....                              | 2         |
| 2.2 Unpacking and Inspection .....                      | 2         |
| 2.3 Equipment Checklist .....                           | 2         |
| 2.4 Printer Parts .....                                 | 4         |
| 2.5 External Label Roll Mount .....                     | 7         |
| 2.6 Buttons and Indicators .....                        | 8         |
| <b>3. SET UP .....</b>                                  | <b>9</b>  |
| 3.1 Setting Up the Printer .....                        | 9         |
| 3.2 Loading Label and Tag Stock .....                   | 9         |
| 3.3 Self-Peeling Function .....                         | 12        |
| 3.4 Ribbon Loading Instructions .....                   | 14        |
| 3.5 Install External Label Roll Mount .....             | 17        |
| 3.6 Install Memory Module .....                         | 18        |
| 3.7 Self Test .....                                     | 19        |
| 3.8 Dump Mode .....                                     | 20        |
| <b>4. USING B-443 .....</b>                             | <b>21</b> |
| 4.1 Power-on Utilities .....                            | 21        |
| 4.1.1 Self Test Utility .....                           | 21        |
| 4.1.2 Gap Sensor Calibration Utility .....              | 21        |
| 4.1.3 Printer Initialization .....                      | 22        |
| 4.2 Error Messages .....                                | 23        |
| 4.3 Troubleshooting Guide .....                         | 24        |
| <b>5. SPECIFICATIONS, OPTIONS, &amp; SUPPLIES .....</b> | <b>25</b> |
| 5.1 Specifications .....                                | 25        |
| 5.1.1 Printer .....                                     | 25        |
| 5.1.2 Indicators and Buttons .....                      | 25        |
| 5.1.3 Communication Interface .....                     | 25        |
| 5.1.4 Power Requirements .....                          | 25        |
| 5.1.5 Environment .....                                 | 26        |
| 5.1.6 Printer Body .....                                | 26        |

5.2 Options ..... 26

5.3 Supplies..... 27

    5.3.1 Label Stock..... 27

    5.3.2 Ribbon ..... 27

## Safety Summary

Personal safety in handling or maintaining the equipment is extremely important. Warnings and Cautions necessary for safe handling are included in this manual. All warnings and cautions contained in this manual should be read and understood before handling or maintaining the equipment.

Do not attempt to effect repairs or modifications to this equipment. If a fault occurs that cannot be rectified using the procedures described in this manual, turn off the power, unplug the machine, then contact your authorized TOSHIBA TEC representative for assistance.

## Meanings of Each Symbol



This symbol indicates warning items (including cautions). Specific warning contents are drawn inside the  $\triangle$  symbol. (The symbol on the left indicates a general caution.)



This symbol indicates prohibited actions (prohibited items). Specific prohibited contents are drawn inside or near the  $\circ$  symbol. (The symbol on the left indicates "no disassembling".)



This symbol indicates actions which must be performed. Specific instructions are drawn inside or near the  $\bullet$  symbol. (The symbol on the left indicates "disconnect the power cord plug from the outlet".)



## WARNING

This indicates that there is the risk of **death** or **serious injury** if the machines are improperly handled contrary to this indication.



Any other than the specified AC voltage is prohibited.

■ Do not use voltages other than the voltage (AC) specified on the rating plate, as this may cause **fire** or **electric shock**.

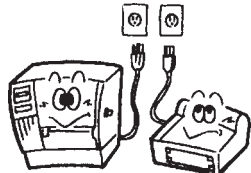

**Prohibited**

■ Do not plug in or unplug the power cord plug with wet hands as this may cause **electric shock**.

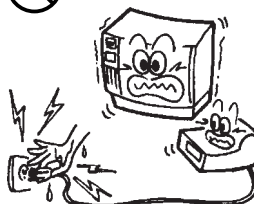

**Prohibited**

■ If the machines share the same outlet with any other electrical appliances which consume large amounts of power, the voltage will fluctuate widely each time these appliances operate. Be sure to provide an exclusive outlet for the machine as this may cause the machines to **malfunction**.

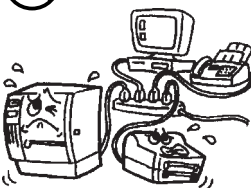

**Prohibited**

■ Do not place metal objects or water-filled containers such as flower vases, flower pots or mugs, etc. on top of the machines. If metal objects or spilled liquid enter the machines, this may cause **fire** or **electric shock**.

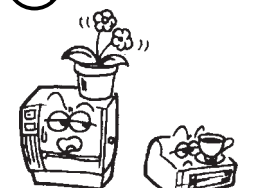

**Prohibited**

■ Do not insert or drop metal, flammable or other foreign objects into the machines through the ventilation slits, as this may cause **fire** or **electric shock**.

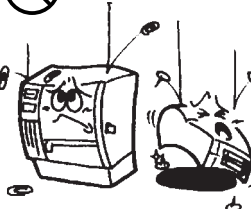

**Prohibited**

■ Do not scratch, damage or modify the power cords. Also, do not place heavy objects on, pull on, or excessively bend the cords, as this may cause **fire** or **electrical shock**.

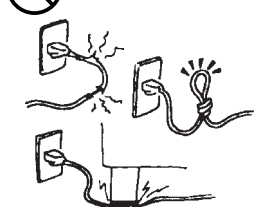

**Disconnect the plug.**



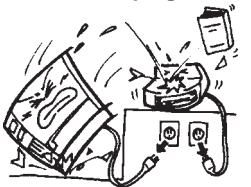



■ If the machines are dropped or their cabinets damaged, first turn off the power switches and disconnect the power cord plugs from the outlet, and then contact your authorized TOSHIBA TEC representative for assistance. Continued use of the machine in that condition may cause **fire** or **electric shock**.

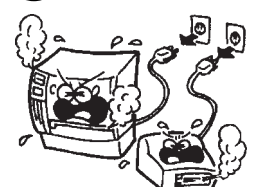

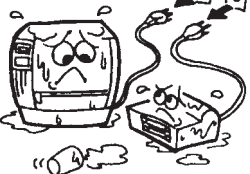
**Disconnect the plug.**

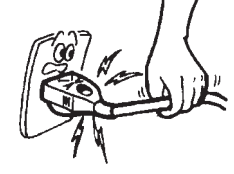
■ Continued use of the machines in an abnormal condition such as when the machines are producing smoke or strange smells may cause **fire** or **electric shock**. In these cases, immediately turn off the power switches and disconnect the power cord plugs from the outlet. Then, contact your authorized TOSHIBA TEC representative for assistance.

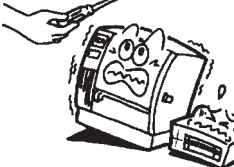

|   |   |   |  |
|---|---|---|--|
|  <p><b>Disconnect the plug.</b></p>       | <p>■ If foreign objects (metal fragments, water, liquids) enter the machines, first turn off the power switches and disconnect the power cord plugs from the outlet, and then contact your authorized TOSHIBA TEC representative for assistance. Continued use of the machine in that condition may cause <b>fire</b> or <b>electric shock</b>.</p> |  <p><b>Disconnect the plug.</b></p>  | <p>■ When unplugging the power cords, be sure to hold and pull on the plug portion. Pulling on the cord portion may cut or expose the internal wires and cause <b>fire</b> or <b>electric shock</b>.</p> |
|  <p><b>Connect a grounding wire.</b></p>  | <p>■ Ensure that the equipment is properly grounded. Extension cables should also be grounded. <b>Fire</b> or <b>electric shock</b> could occur on improperly grounded equipment.</p>   |  <p><b>No disassembling.</b></p>     | <p>■ Do not remove covers, repair or modify the machine by yourself. You may be <b>injured</b> by high voltage, very hot parts or sharp edges inside the machine.</p>                                    |



**CAUTION** This indicates that there is the risk of personal **Injury** or **damage** to objects if the machines are improperly handled contrary to this indication.

### Precautions

The following precautions will help to ensure that this machine will continue to function correctly.

- Try to avoid locations that have the following adverse conditions:
 

|   |                       |                 |
|---|-----------------------|-----------------|
| * Temperatures out of the specification | * Direct sunlight     | * High humidity |
| * Shared power source                   | * Excessive vibration | * Dust/Gas      |
- The cover should be cleaned by wiping with a dry cloth or a cloth slightly dampened with a mild detergent solution. NEVER USE THINNER OR ANY OTHER VOLATILE SOLVENT on the plastic covers.
- USE ONLY TOSHIBA TEC SPECIFIED paper and ribbons.
- DO NOT STORE the paper or ribbons where they might be exposed to direct sunlight, high temperatures, high humidity, dust, or gas.
- Ensure the printer is operated on a level surface.
- Any data stored in the memory of the printer could be lost during a printer fault.
- Try to avoid using this equipment on the same power supply as high voltage equipment or equipment likely to cause mains interference.
- Unplug the machine whenever you are working inside it or cleaning it.
- Keep your work environment static free.
- Do not place heavy objects on top of the machines, as these items may become unbalanced and fall causing **injury**.
- Do not block the ventilation slits of the machines, as this will cause heat to build up inside the machines and may cause **fire**.
- Do not lean against the machine. It may fall on you and could cause **injury**.
- Care must be taken not to injure yourself with the printer paper cutter.
- Unplug the machine when it is not used for a long period of time.

### Request Regarding Maintenance

- Utilize our maintenance services.  
After purchasing the machine, contact your authorized TOSHIBA TEC representative for assistance once a year to have the inside of the machine cleaned. Otherwise, dust will build up inside the machines and may cause a **fire** or a **malfunction**. Cleaning is particularly effective before humid rainy seasons.
- Our preventive maintenance service performs the periodic checks and other work required to maintain the quality and performance of the machines, preventing accidents beforehand. For details, please consult your authorized TOSHIBA TEC representative for assistance.
- Using insecticides and other chemicals  
Do not expose the machines to insecticides or other volatile solvents. This will cause the cabinet or other parts to deteriorate or cause the paint to peel.

# 1. PRODUCT INTRODUCTION

Thank you very much for purchasing TEC B-443 bar code printer. The attractive desktop printer delivers superior performance at an economical price. Both powerful and easy-to-use, B-443 printer is your best choice among desktop direct thermal and thermal transfer label printers.

B-443 printer offers both thermal transfer and direct thermal printing at selectable speeds of 1.5, 2.0 and 3.0 inches per second. It can accept a wide range of media, including roll feed, die-cut, and fan-fold labels or tags for both thermal transfer and direct thermal printing. All of the most frequently used bar code formats are available. Fonts and bar codes can be printed in any one of four directions. B-443 printer provides a choice of five different sizes of alphanumeric fonts. By using font multiplication, an even greater range of sizes is possible. Smooth fonts can be downloaded from the user friendly, "Label Design" Windows software. In addition, B-443 is capable of independently executing BASIC programming functions, including arithmetic, logical operation, loop, flow-control and file management, among others. This programming capability provides the greatest efficiency in label printing. The status of printer and error messages may either be printed out or viewed on a monitor by means of the RS-232 connection.

## 1.1 Compliances

CE, TÜV-GS



## 2. GETTING STARTED

### 2.1 Applicable Model

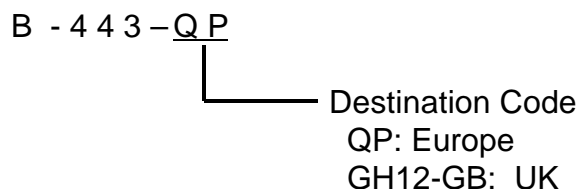

### 2.2 Unpacking and Inspection

The printer has been specially packaged to withstand damage in the shipping process. However, for fear that unexpected damage might occur, upon receiving the bar code printer, carefully inspect the package and the device. In case of evident damage, contact the carrier directly to specify the nature and extent of the damage. Please retain the packaging materials in case you need to reship the printer.

### 2.3 Equipment Checklist

- One B-443 bar code printer unit
- Ribbon paper core
- Ribbon supply/rewind spindle (2 pcs.)
- Label supply roll spindle
- External label roll mount
- Power supply
- Power cord
- Centronics interface cable
- Windows driver
- Label Design Windows software

Separately purchased items may also be included. These additional items may include:

- Additional labels
- Additional ribbons
- Memory module
- Cutter

- Portable LCD keyboard

If any parts are missing, please contact the Customer Service Department of your purchased reseller or distributor.

## 2.4 Printer Parts

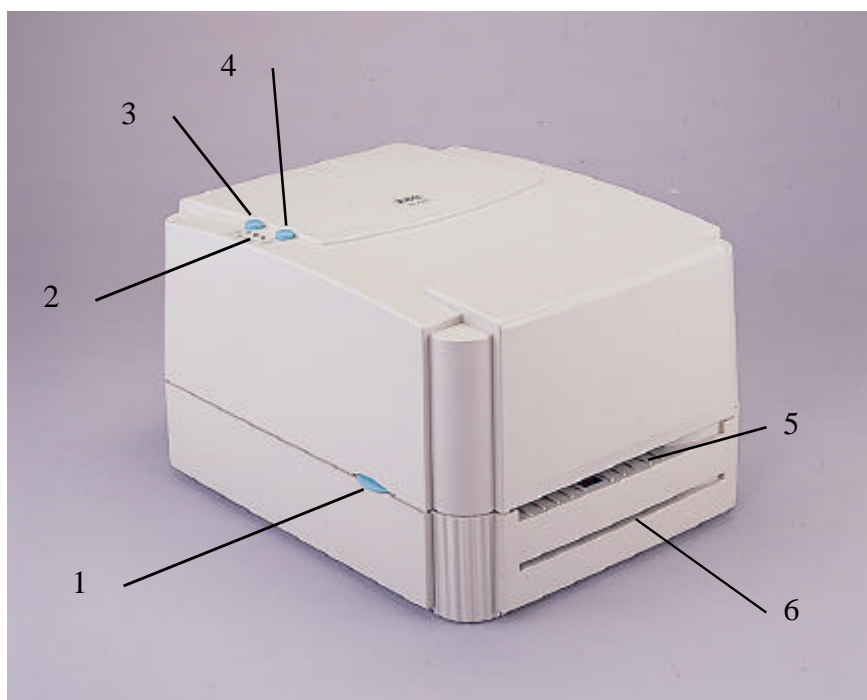

**Figure 1. Top front view**

1. Cover Release Button
2. PWR., ON-LINE and ERR. Indicators
3. PAUSE Button
4. FEED Button
5. Label Dispense Opening
6. Backing Paper Opening (for use with self-peeling function)

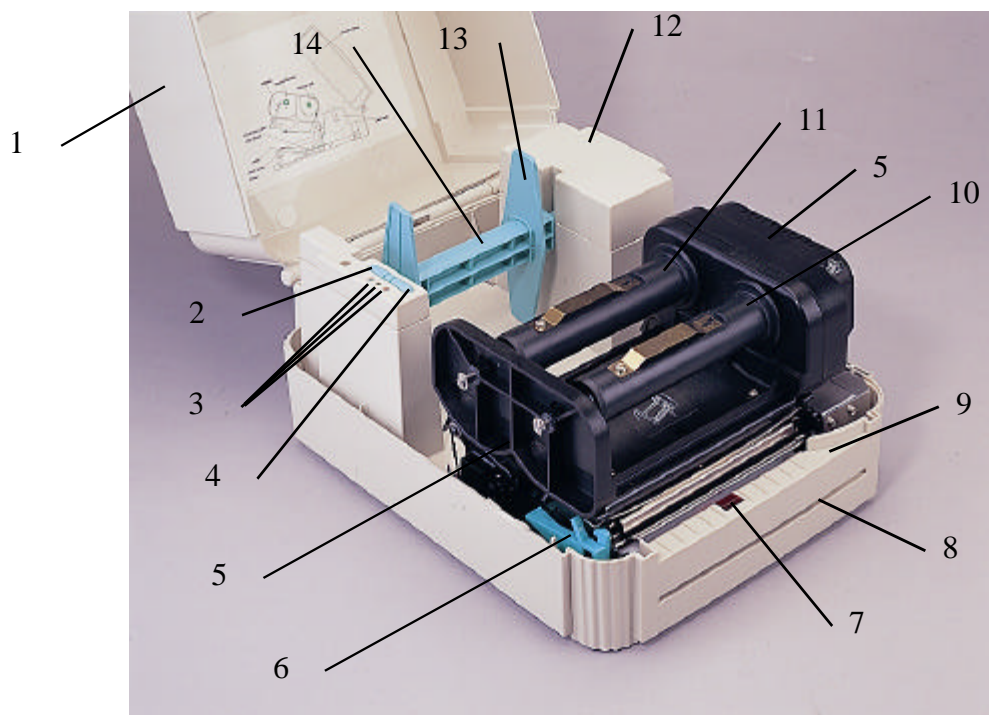

**Figure 2. Interior view**

1. Printer Cover (in open position)
2. PAUSE Button
3. PWR., ON-LINE, ERR. Indicators
4. FEED Button
5. Ribbon Mechanism
6. Printer Carriage Release Lever
7. Peel-Off Sensor
8. Backing Paper Opening
9. Detachable Front Panel
10. Ribbon Rewind Spindle
11. Ribbon Supply Spindle
12. Memory Module Slot (with cover on)
13. Fixing Tabs
14. Label Supply Roll Spindle

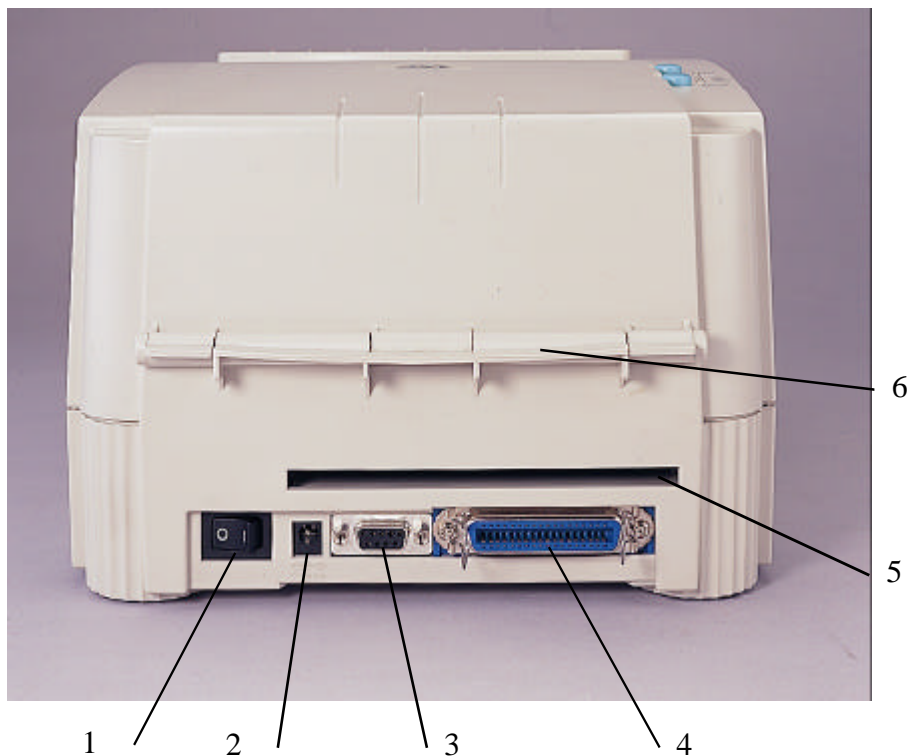

**Figure 3. Rear view**

- 1. Power On/Off Switch
- 2. Power Supply Connector
- 3. RS-232 DB-9 Interface Connector
- 4. Centronics Interface Connector
- 5. Label Insert Opening (for use with external labels)
- 6. Cover Hinge

## 2.5 External Label Roll Mount



**Figure 4. External label roll mount**

## 2.6 Buttons and Indicators

### **PWR. (POWER) Indicator**

The green **PWR.** indicator illuminates when the **POWER** switch is turned on.

### **ON-LINE Indicator**

The green **ON-LINE** indicator illuminates when the printer is ready to print. When **PAUSE** button is pressed, the **ON-LINE** indicator flashes.

### **ERR. Indicator (Error/Paper Empty)**

The red **ERR.** indicator illuminates in the event of a printer error, such as memory error, syntax error, and so forth. For a full list of error messages, please refer to section 4.2, Error Messages.

### **PAUSE Button**

The **PAUSE** button allows the user to stop a print job and then continue the printing with a second depression of the button. By pressing the **PAUSE** button: (1) the printer stops printing after the printing label, (2) the **PAUSE** LED flashes, and (3) the printer will hold all data in memory. This allows for trouble-free replacement of label stock and thermal transfer ribbon. A second depression of the **PAUSE** button will restart the printer.

***Note: If the PAUSE button is held down for more than 3 seconds, the printer will be reset and all data of the previous printing job will be lost.***

### **FEED Button**

Press the **FEED** button to feed the label to the beginning of the next label.

## 3. SET UP

### 3.1 Setting Up the Printer

1. Place the printer on a flat, secure surface.
2. Make sure the **POWER** switch is off.
3. Connect the printer to the computer mainframe with the provided RS-232C or Centronics cable.
4. Plug the power cord into the power supply connector at the rear of the printer, and then plug the power cord into a properly grounded receptacle.

### 3.2 Loading Label and Tag Stock

1. Open the printer cover
2. Disengage the printer carriage by pulling the printer carriage release lever on the left side of the platen.
3. Slide the label supply roll spindle through the core of a label roll and attach the fixing tabs onto the spindle.
4. Place the label roll into the label roll mount. Feed the label under the carriage and over the platen.
5. Adjust the label guide to fit the width of the media.
6. Engage the printer carriage.
7. Wind the label roll until it becomes adequately taut.
8. Close the printer cover and press the **FEED** button three or four times until the green **ON-LINE** indicator illuminates.
9. When the printer is out of ribbon or media, the **ON-LINE** LED will not illuminate and the **ERR.** LED will flash. Reload the ribbon or media without turning off the printer power. Press the **FEED** button three or four times until the **ON-LINE** LED illuminates. The printing job will be resumed without data loss.



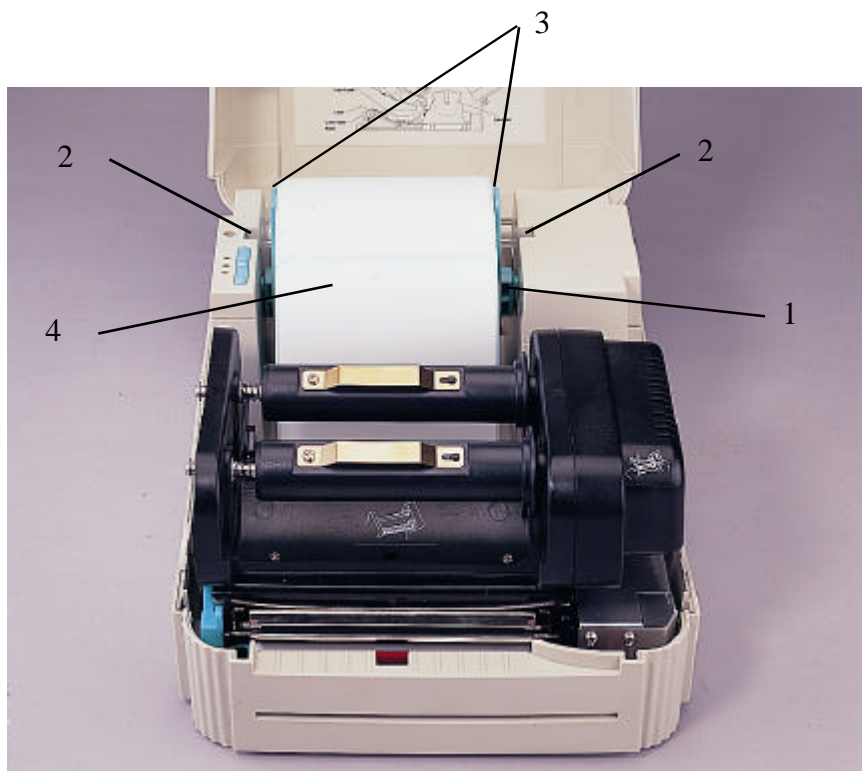

**Figure 5. Inserting label supply roll into label roll mount**

1. Label Supply Roll Spindle
2. Label Roll Mount
3. Fixing Tabs
4. Label Roll

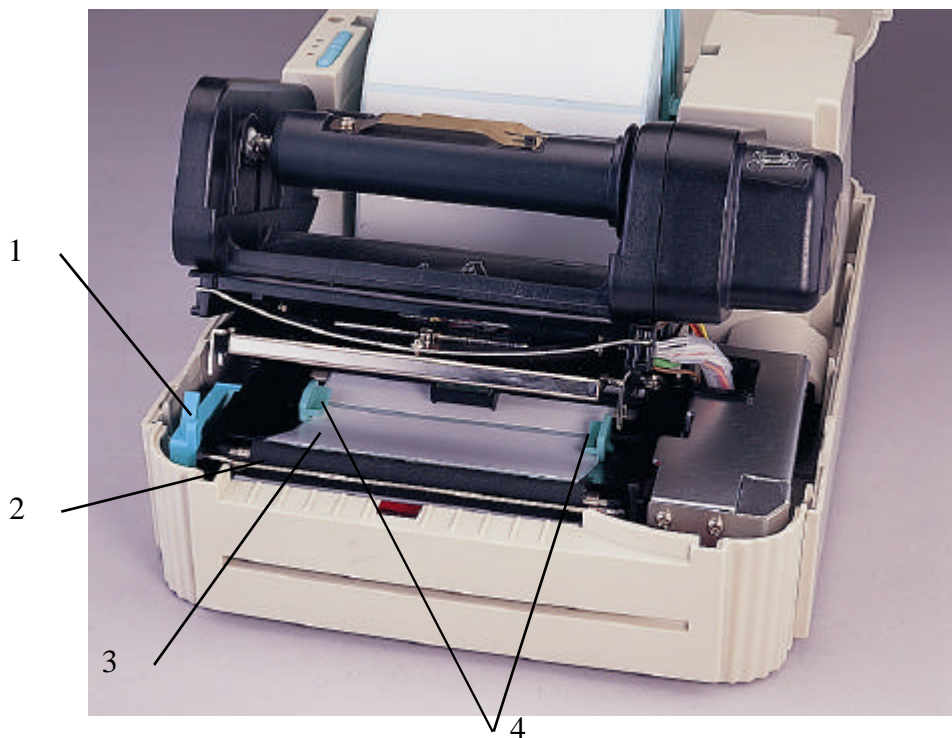

**Figure 6. Feed labels through adjustable label guide**

- 1. Printer Carriage Release Lever
- 2. Platen
- 3. Label Media
- 4. Adjustable Label Guide

### 3.3 Self-Peeling Function

To employ the self-peeling function, load the label stock according to the following steps.

1. Remove the front panel.
2. Tear off the foremost one or two labels of the label stock, as befits the case. Feed the backing paper between the platen and the white “self-peeling” roller, as shown in Figure 7.
3. Feed the backing paper through the backing paper opening in the front panel, as shown in Figure 8.
4. Put back the front panel.

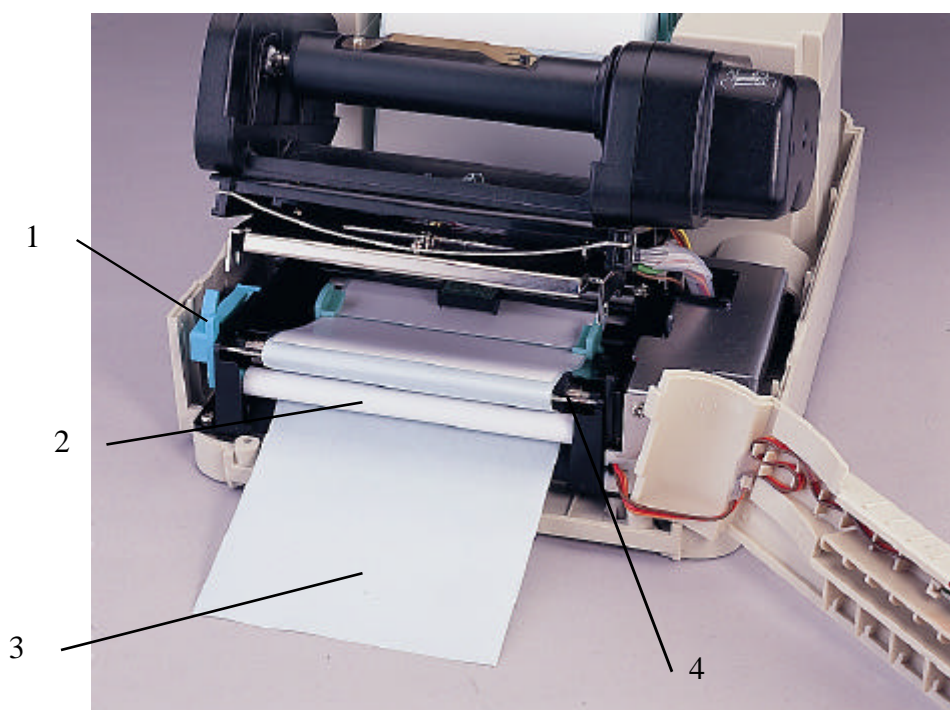

**Figure 7. Setting up printer for self-peeling function**

1. Printer Carriage Release Lever
2. Self-Peeling Roller
3. Backing Paper
4. Platen

**Note: It is recommended that the print speed be set at 2 inches per second when using the self peeling function of the printer.**

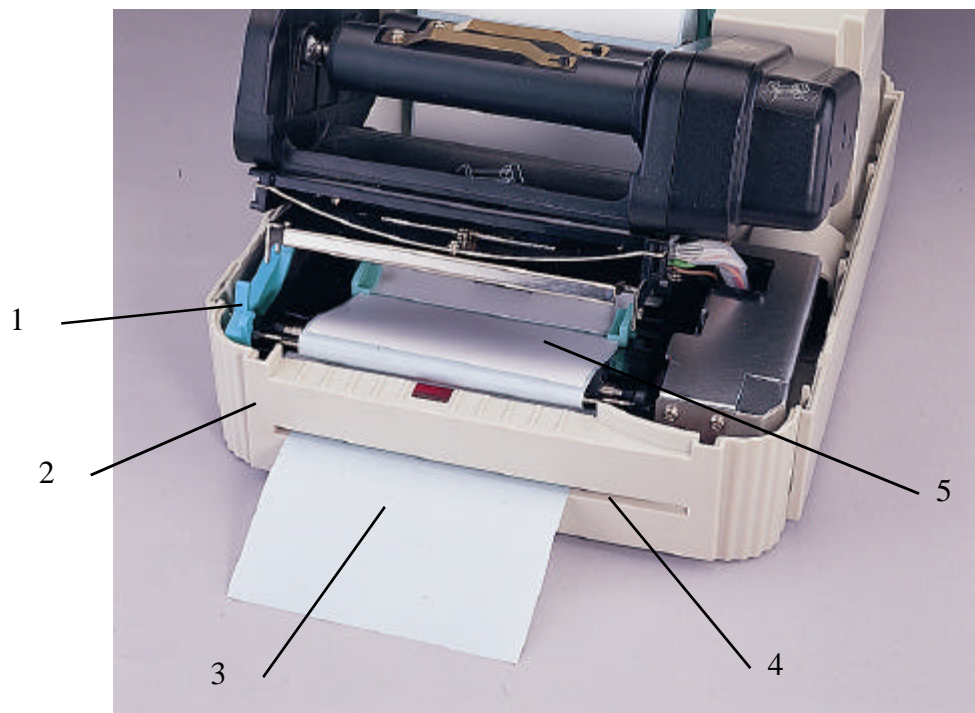
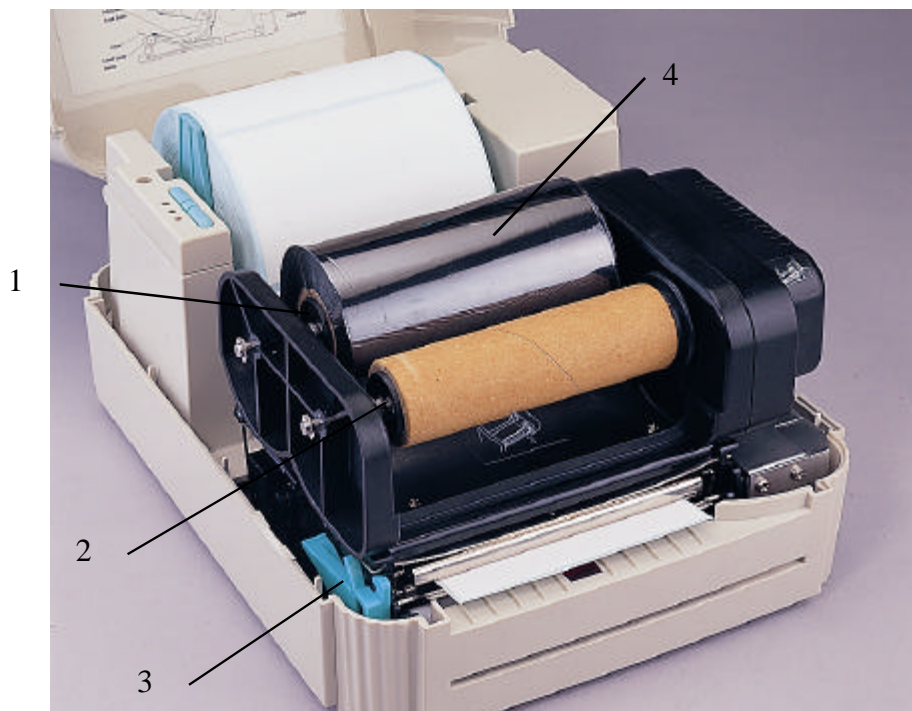

**Figure 8. Printer ready for self-peeling function**

- 1. Printer Carriage Release Lever
- 2. Printer Front Panel
- 3. Backing Paper
- 4. Backing Paper Opening
- 5. Label

### 3.4 Ribbon Loading Instructions

1. Place an empty paper core on the ribbon rewind spindle.
2. Install the ribbon on the ribbon supply spindle.
3. Disengage the printer carriage.
4. Pull the ribbon leader to the front from beneath the printer carriage. Attach the ribbon leader to the ribbon rewind paper core.
5. Rotate the ribbon rewind roller until the ribbon leader is thoroughly, firmly encompassed by the black section of the ribbon.
6. Engage the printer carriage.
7. Close the printer cover and press the **FEED** button until the green **ON-LINE** LED illuminates.



**Figure 9. Placement of ribbon supply roll**

1. Ribbon Supply Spindle
2. Ribbon Rewind Spindle
3. Printer Carriage Release Lever
4. Thermal Transfer Ribbon



**Figure 10. Installation of label stock and thermal transfer ribbon**

### 3.5 Install External Label Roll Mount

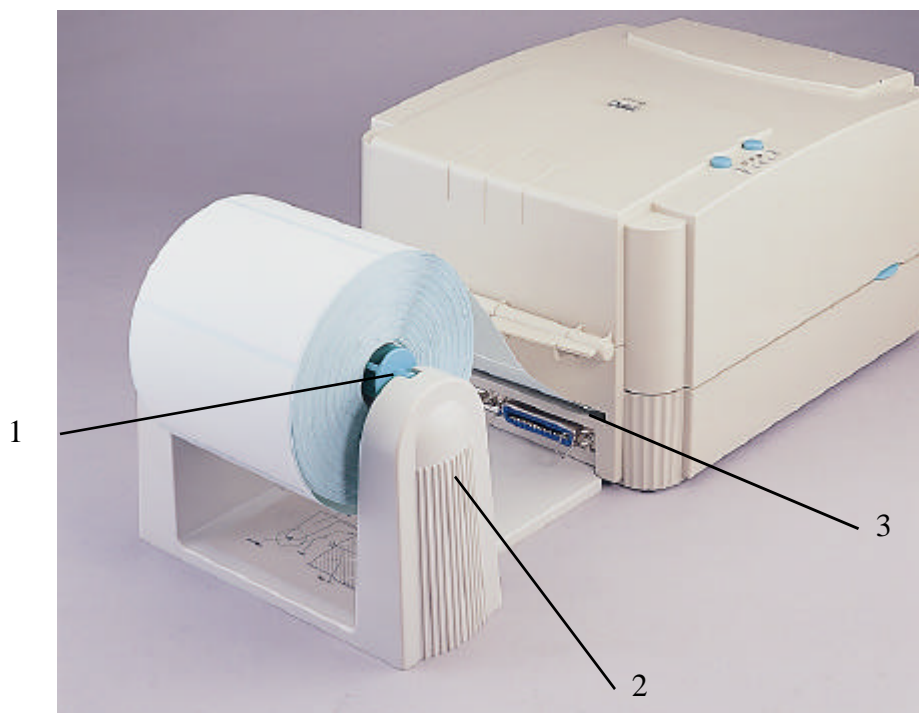

**Figure 11. Installation of external label roll mount**

1. Label Supply Roll Spindle
2. External Label Roll Mount
3. External Label Feed Opening



### 3.6 Install Memory Module

1. Power off the printer.
2. Remove the cover.
3. Insert the memory module.
4. Put the cover back.
5. Turn on the power

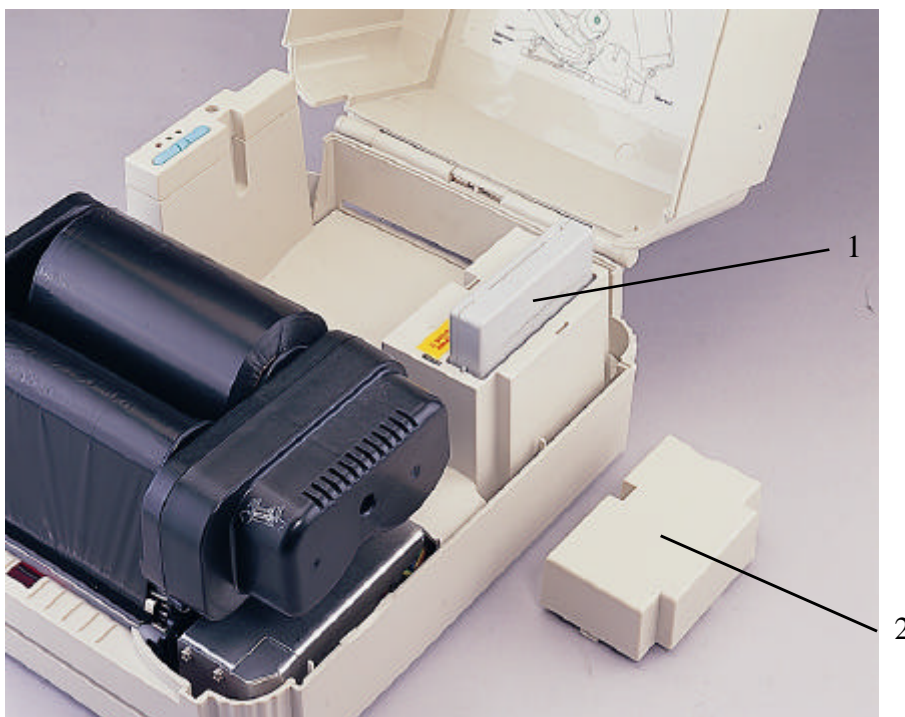

**Figure 12. Installation of memory module (Option)**

1. Memory Module.
2. Cover.

### 3.7 Self Test

To initiate the self test mode, depress the **FEED** button while turning on the printer power. The printer will calibrate the label length. If the label gap is not detected within 7", the printer stops feeding labels and the media is treated as continuous paper. In self test, a check pattern is used to check the performance of the thermal print head. Following the check pattern, the printer prints internal settings as listed below:

1. Printer model and firmware version
2. Mileage
3. Flash times
4. Check sum
5. Serial port setting
6. Code page setting
7. Country code setting
8. Print speed setting
9. Print density setting
10. Label size setting
11. Gap (Bline) width and offset setting
12. Backing paper transparency
13. File list
14. Memory available

When the self test is completed, the printer enters the dump mode. Please turn the printer's power off and then on to resume normal printing.

```
PRINTER INFO.  
TEC B-443 VER 1.00  
MILAGE(Km):0.00  
FLASH TIMES:65535  
CHECK SUM:E379  
SERIAL PORT:96.N.8.1  
CODE PAGE:437  
COUNTRY CODE:001  
SPEED:2 INCH  
DENSITY:09  
SIZE:4.02.2.46  
GAP(BLINE):0.14.0.00  
TRANSPARENCE:05.05.05  
*****  
FILE LIST:  
TOTAL FLASH: 704 K BYTES  
AVAIL FLASH: 704 K BYTES  
TOTAL RAM: 1984K BYTES  
AVAIL RAM: 1856K BYTES  
END OF FILE LIST  
*****  
NOW IN DUMP MODE
```

### 3.8 Dump Mode

After the self test, the printer enters the dump mode. In this mode, any characters sent from the host computer will be printed in two columns, as shown. The characters received will be shown in the first column, and their corresponding hexadecimal values, in the second. This is often helpful to users for the verification of programming commands or debugging of printer programs. Reset the printer by turning the **POWER** switch off and on.

```
*****
NOW IN DUMP MODE

DOWNLOAD "DE 44 4F 57 4E 4C 4F 41 44 20 22 44 45
MO2.BAS" SI 4D 4F 32 2E 42 41 53 22 0D 0A 53 49
ZE 4.00,5.00 5A 45 20 34 2E 30 30 2C 35 2E 30 30
  CLS SPEED 0D 0A 43 4C 53 0D 0A 53 50 45 45 44
  1.5 DENSIT 20 31 2E 35 0D 0A 44 45 4E 53 49 54
Y 10 DIRECT 59 20 31 30 0D 0A 44 49 52 45 43 54
ION 0 SET C 49 4F 4E 20 30 0D 0A 53 45 54 20 43
UTTER OFF S 55 54 54 45 52 20 4F 46 46 0D 0A 53
ET DEBUG LAB 45 54 20 44 45 42 55 47 20 4C 41 42
EL REFERENC 45 4C 0D 0A 52 45 46 45 52 45 4E 43
E 0,0 A=100 45 20 30 2C 30 0D 0A 41 3D 31 30 30
0 Y=100 FO 30 0D 0A 59 3D 31 30 30 0D 0A 46 4F
R I=1 TO 3 52 20 49 3D 31 20 54 4F 20 33 0D 0A
BARCODE 100, 42 41 52 43 4F 44 45 20 31 30 30 2C
Y, "39".96,1, 59 2C 22 33 39 22 2C 39 36 2C 31 2C
0,2,4,STR$(A 30 2C 32 2C 34 2C 53 54 52 24 28 41
) A=A+1 Y= 29 0D 0A 41 3D 41 2B 31 0D 0A 59 3D
Y+150 NEXT 59 2B 31 35 30 0D 0A 4E 45 58 54 0D
PRINT 1 EO 0A 50 52 49 4E 54 20 31 0D 0A 45 4F
P DEMO2 50 0D 0A 44 45 4D 4F 32 0D 0A
```

## 4. USING B-443

### 4.1 Power-on Utilities

There are three power-on utilities to set up and test B-443 hardware. These utilities are activated by pressing the **FEED** or **PAUSE** button and turning on the printer power simultaneously. The utilities are listed as below:

1. Self-test
2. Gap sensor calibration
3. Printer initialization

#### 4.1.1 Self Test Utility

Install the label first. Press the **FEED** button and then turn on the printer power. Do not release the **FEED** button until the printer feeds labels. The printer performs the following items:

1. Calibrate label pitch
2. Print out thermal print head check pattern
3. Print the internal settings
4. Enter dump mode

Regarding the self-test and dump mode, please refer to section 3.7 "Self Test" and section 3.8 "Dump Mode" for more information.

#### 4.1.2 Gap Sensor Calibration Utility

This utility is used to calibrate the sensitivity of gap sensor. Users may have to calibrate the gap sensor for two reasons:

1. The media is being changed to a new type.
2. Initialize the printer.

**Note: The ERR. LED may flash if gap sensor is not calibrated properly.**

Please follow the steps below to calibrate gap sensor:

1. Turn off the printer power and install blank labels (without any logo or character) on printer.
2. Hold down the **PAUSE** button then turn on printer power.
3. Release **PAUSE** button when the printer feeds labels. **Do not turn off printer power** until the printer stops and two green LEDs light on.

### 4.1.3 Printer Initialization

Printer initialization clears all downloaded files resident in flash memory, and sets printer parameters to default values.

| Parameter    | Default Value            | Cleared by Initialization |
|--------------|--------------------------|---------------------------|
| MILEAGE      | N/A                      | No                        |
| FLASH TIMES  | N/A                      | No                        |
| CHECK SUM    | N/A                      | No                        |
| SERIAL PORT  | 96,N,8,1                 | Yes                       |
| CODE PAGE    | 437 (8 bit), USA (7 bit) | Yes                       |
| COUNTRY CODE | 001                      | Yes                       |
| SPEED        | 2.0"/sec                 | Yes                       |
| DENSITY      | 09                       | Yes                       |
| SIZE         | N/A                      | Yes                       |
| GAP(BLINE)   | N/A                      | Yes                       |
| TRANSPARANCY | 05,05,05                 | Yes                       |

Please follow the steps below to initialize the printer:

1. Turn off the printer power.
2. Hold down the **PAUSE** and **FEED** buttons and turn on the printer power.
3. Do not release the buttons until the three LEDs flash in turn.

**Note: Printing method (thermal transfer or thermal direct printing ) will be set automatically at the activation of printer power.**

## 4.2 Error Messages

### Syntax Error

The command format is incorrect.  
The serial port setting is incorrect.

### Out of Range

Numeric input is too large to be processed.  
The input string is too long to be stored.  
The size of the text or bar code exceeds that of the label.

### Download Error

The download file format is incorrect.  
There is not enough memory to store the file.

### Stack Overflow

A mathematical expression is too complicated. Divide it into several expressions.  
The nested routine is too deep.

### Memory Error

Too many variables defined.

### RS-232 Error

The serial port setting is incorrect.

### File not Found

Cannot open the file specified. Download the file again.

### Type Mismatch

Variable type mismatch.

### Gap not Found

Cannot detect label gap. Calibrate the label again.

### Clock Access Error

Can not read from / write to the real time clock.

## 4.3 Troubleshooting Guide

The following guide lists some of the most common problems that may be encountered when operating the B-443 bar code printer. If the printer still does not function after all suggested solutions have been invoked, please contact the Customer Service Department of your purchased reseller or distributor for assistance

| Problem  | Solution  |
|--|---|
| Ribbon does not advance or rewind                            | Turn off the printer power. Adjust and re-install the ribbon and label, and then turn on the printer power again.             |
| Poor print quality   | Clean the thermal print head.<br>Adjust the print density setting.<br>Ribbon and media are not compatible.                    |
| Power indicator does not illuminate                          | Check the power cord, see whether it is properly connected.   |
| <b>ON-LINE</b> indicator is off. <b>ERR.</b> LED flashes     | Out of paper or out of ribbon<br>Calibrate the sensitivity of gap sensor.   |
| <b>ON-LINE</b> indicator is off. <b>ERR.</b> Indicator is on | Command syntax is not correct.<br>Rewind ribbon paper core is not installed.<br>Serial port baud rate setting is not correct. |
| Continuous feeding when printing labels                      | Calibrate the gap sensor.   |

**Note: When the voltage is too low or when the printing covers a wide range on the label, the print density may become inadequate. In this situation, please lower the print speed to secure normal print quality.**

## 5. SPECIFICATIONS, OPTIONS, & SUPPLIES

### 5.1 Specifications

#### 5.1.1 Printer

- Type: Direct thermal or thermal transfer
- Print speed: Selectable speeds of 1.5, 2.0 or 3.0 inches per second
- Resolution: 203 DPI (8 dots per mm)
- Font styles: Five alphanumeric fonts from 0.059"H (1.5 mm) to 0.23" (6.0 mm), expandable vertically and horizontally up to 8x. Smooth fonts may be downloaded from "Label Design"
- Bar codes: Code 39, Code 93, Code 128 UCC, Code 128 (Subsets A, B and C), Codabar, Interleaved 2 of 5, EAN-8, EAN-13, UPC-A, UPC-E, EAN and UPC with 2 or 5 digit add-on, Postnet
- 2D bar codes: Maxicode, PDF-417, DataMatrix
- Graphics: Mono PCX format

#### 5.1.2 Indicators and Buttons

- Indicators: PWR., ON-LINE, ERR.
- Buttons: POWER, PAUSE, FEED,

**Note:** *The functions of buttons and LEDs can be redefined by commands.*

#### 5.1.3 Communication Interface

- Communications: RS-232C(DB-9) at 2400, 4800, 9600 or 19200 baud and standard Centronics interface.
- Character set: ANSI ASCII character set
- Word length: 7 or 8 data bits, 1 or 2 stop bits, even, odd or none parity.
- Handshaking: Xon/Xoff (on receive mode only) and DSR/DTR
- Input buffer: 60KB

#### 5.1.4 Power Requirements

- Input voltage: Switching power, 110-240 VAC, 50-60 Hz
- Output voltage: 24 VDC
- Circuit protection: 2A maximum



### 5.1.5 Environment

- Operating temperature: 40°F to 104°F (5°C to 40°C)
- Storage temperature: 40°F to 140 °F (5°C to 60°C)
- Humidity: 10% to 95% non-condensing
- Ventilation: Free air movement

### 5.1.6 Printer Body

- Dimensions:  
6.14"H x 9.13"W x 11.34"D (15.6 cm H x 23.2 cm W x 28.8 cm D); with external roll mount 17.95" D (45.6 cm D)
- Weight:  
B-443: 6.0 lbs. (2.7 kg), or 6.5 lbs. (2.9 kg) with external roll mount

## 5.2 Options

A number of different options may be added to the B-443 bar code printer for even greater convenience and versatility. The available options include:

- Foreign character fonts, including Chinese, Japanese and others
- Expandable FLASH memory module
- Cutter
- Portable LCD keyboard

## 5.3 Supplies

### 5.3.1 Label Stock

B-443 is capable of both direct thermal and thermal transfer printing. Many different direct thermal or thermal transfer stocks can be used. Refer to the following list for specifications of compatible label media.

| Media<br>Specification           | Label   | Tag                          |
|----------------------------------|---|------------------------------|
| Paper Width                      | Min. 1" (25.4 mm)   | Min. 1" (25.4 mm)            |
|                                  | Max. 4.49" (114 mm)   | Max. 4.49" (114 mm)          |
| Paper Weight                     | Less than 240 g/m <sup>2</sup>  |                              |
| Length (Pitch)                   | 0.4" (10 mm) ~ 90" (2286 mm)  | 0.4" (10 mm) ~ 90" (2286 mm) |
| Thickness                        | 0.002" (0.05 mm) ~ 0.008" (0.20 mm)   |                              |
| Max. Roll Diameter.<br>(1" core) | Inner roll diameter. Max. 4.3" (110 mm)<br>External roll diameter. Max. 8.4" (214 mm) |                              |
| Roll Up Method                   | Print surface is wound outside as standard  |                              |
| Paper Core ID.                   | φ25.7 ± 0.3 mm  |                              |

### 5.3.2 Ribbon

Standard 300m by 60 or 110mm thermal transfer ribbons with wax, wax-resin, or resin coating (wound outside) are available from TOSHIBA TEC CORPORATION. Of ribbon selection, it is recommended that the ribbon be at least as wide as the print media. Also, the ribbon end should be transparent.

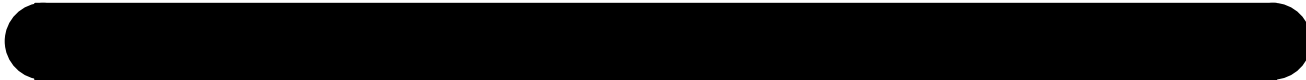

***TEC***  
**TOSHIBA TEC CORPORATION**

 PRINTED IN TAIWAN  
EO1-33013 9910 100 TSC

## Free Manuals Download Website

<http://myh66.com>

<http://usermanuals.us>

<http://www.somanuals.com>

<http://www.4manuals.cc>

<http://www.manual-lib.com>

<http://www.404manual.com>

<http://www.luxmanual.com>

<http://aubethermostatmanual.com>

Golf course search by state

<http://golfingnear.com>

Email search by domain

<http://emailbydomain.com>

Auto manuals search

<http://auto.somanuals.com>

TV manuals search

<http://tv.somanuals.com>