

TOSHIBA

TOSHIBA Thermal Printer

B-EV4 SERIES

Printer Manual

Document No. **EO18-33025**

Original **Nov, 2008**
(Revised)

This manual includes the contents of the Product Description, and Maintenance Manual.

PRINTED IN JAPAN

TOSHIBA TEC CORPORATION

TABLE OF CONTENTS

	Page
1. OUTLINE-----	1- 1
1.1 Features of the B-EV4D/EV4T-----	1- 1
1.1.1 Front View-----	1- 1
1.1.2 Rear View-----	1- 1
1.1.3 Interior View-----	1- 2
1.2 Indications of the Model Name-----	1- 4
1.3 Basic Specifications-----	1- 5
1.4 Key and LED-----	1- 8
1.5 Supply Specifications-----	1- 9
1.5.1 Media Type-----	1- 9
1.5.2 Detection Area of the Transmissive Sensor-----	1-10
1.5.3 Detection Area of the Reflective Sensor-----	1-10
1.5.4 Ribbon-----	1-11
2. ELECTRONIC SPECIFICATIONS-----	2- 1
2.1 Block Diagram-----	2- 1
2.2 Main PC Board Layout-----	2- 2
2.3 Description of the MAIN PC Board-----	2- 3
3. REPLACING THE IMPORTANT PARTS-----	3- 1
3.1 Replacing the Top Cover-----	3- 2
3.1.1 B-EV4T model-----	3- 2
3.1.2 B-EV4D model-----	3- 3
3.2 Replacing the Lower Cover-----	3- 6
3.3 Replacing the Main PC Board-----	3- 7
3.4 Replacing the Platen Ass'y-----	3- 9
3.5 Replacing the Print Head Ass'y-----	3-10
3.5.1 B-EV4T model-----	3-10
3.5.2 B-EV4D model-----	3-12
3.6 Replacing the Stepping Motor-----	3-15
3.7 Replacing the Gear Cover-----	3-17
3.8 Replacing the Feed Button PC Board-----	3-19
3.9 Replacing the Cover Open Sensor-----	3-20
3.10 Replacing the Ribbon Sensor-----	3-21
3.11 Replacing the Black Mark Sensor-----	3-22
3.12 Replacing the Feed Gap Sensor (Lower)-----	3-24
3.13 Replacing the Feed Gap Sensor (Upper)-----	3-26
4. TROUBLESHOOTING-----	4- 1
4.1 LED Status-----	4- 1
4.2 Print Quality-----	4- 2
5. MAINTENANCE-----	5- 1
6. FIRMWARE DOWNLOAD MODE-----	6- 1

CAUTION!

- 1. This manual may not be copied in whole or in part without prior written permission of TOSHIBA TEC.*
- 2. The contents of this manual may be changed without notification.*

1. OUTLINE

1.1 Feature of the B-EV4D/EV4T

1.1.1 Front View

(1) B-EV4D

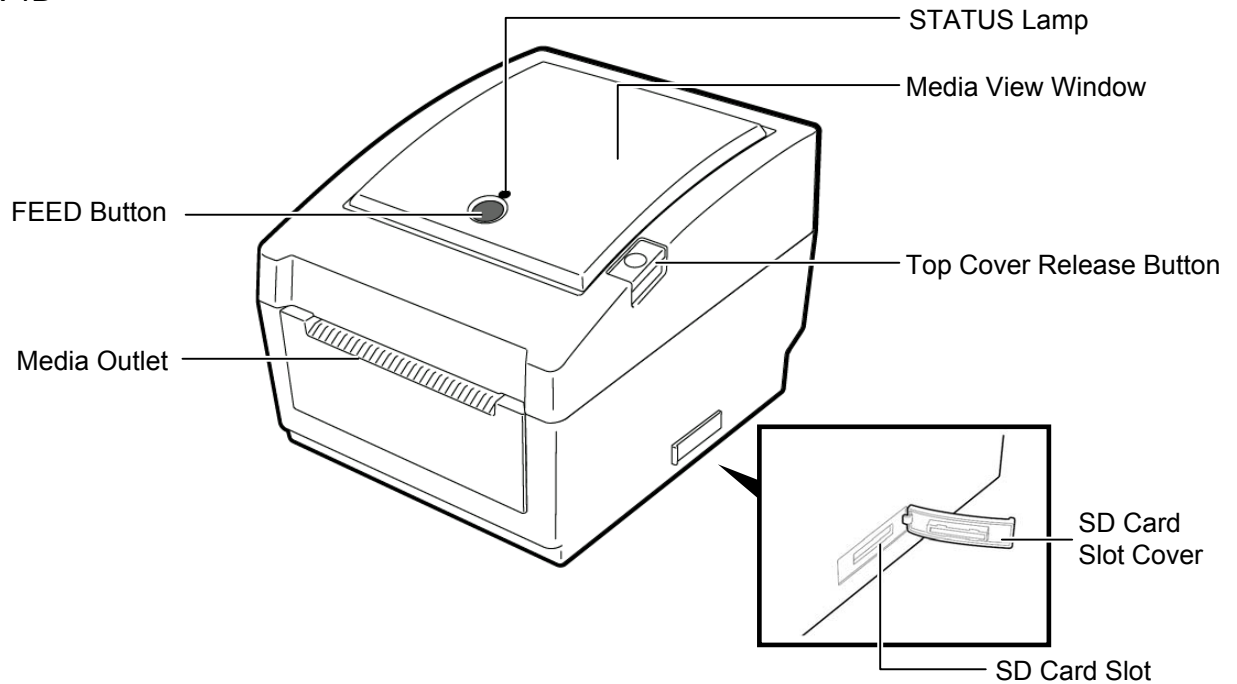

(2) B-EV4T

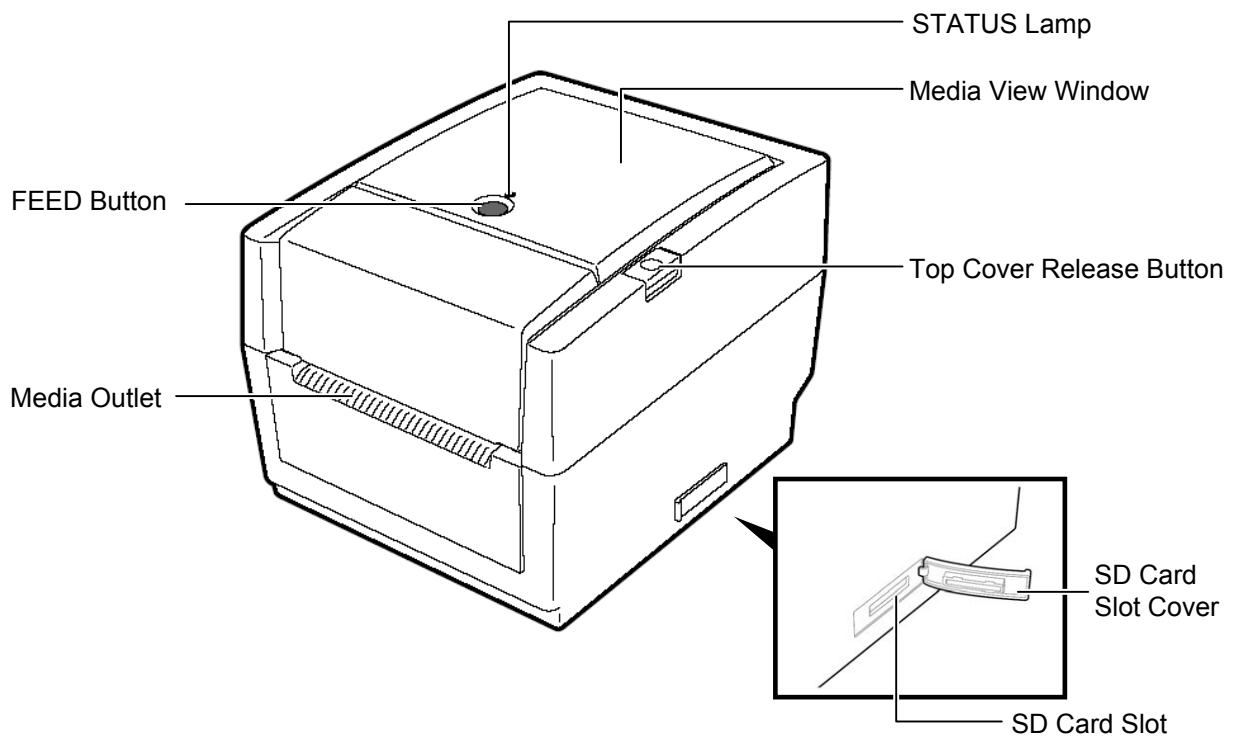

1.1.2 Rear View

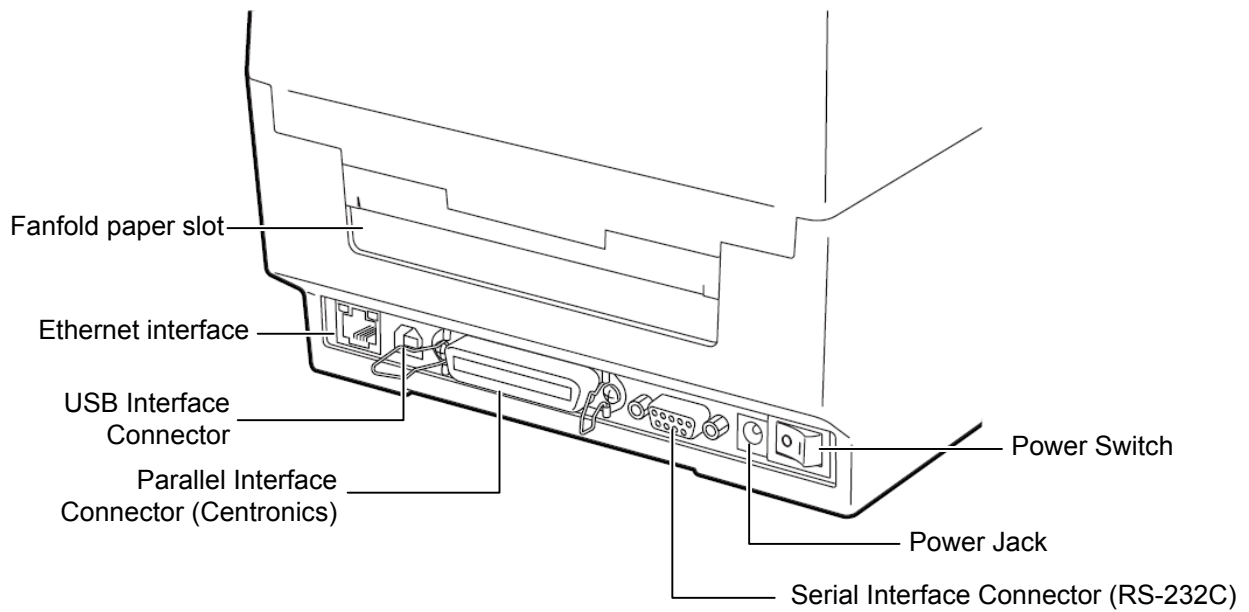

1.1.3 Interior

(1) B-EV4D

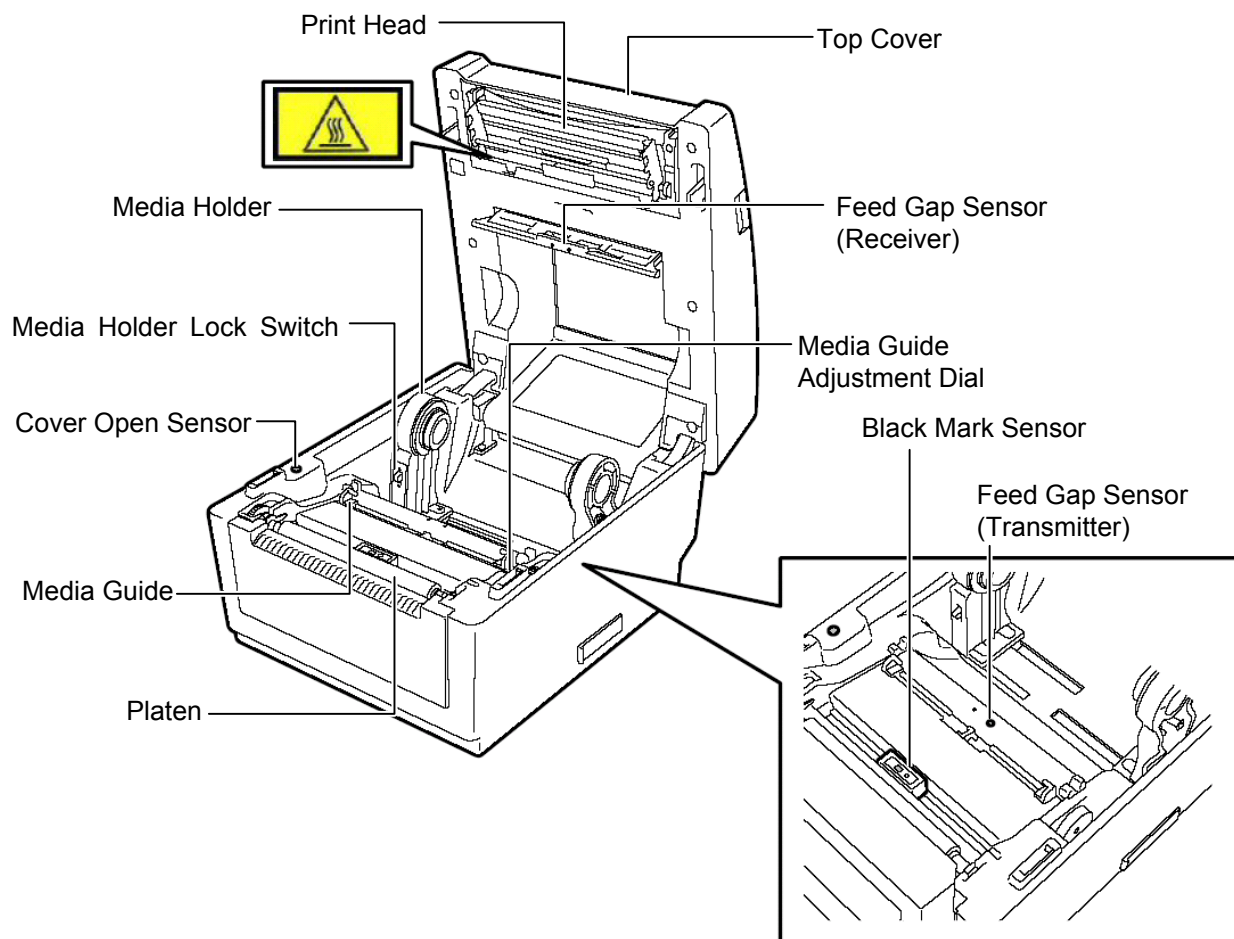

(2) B-EV4T

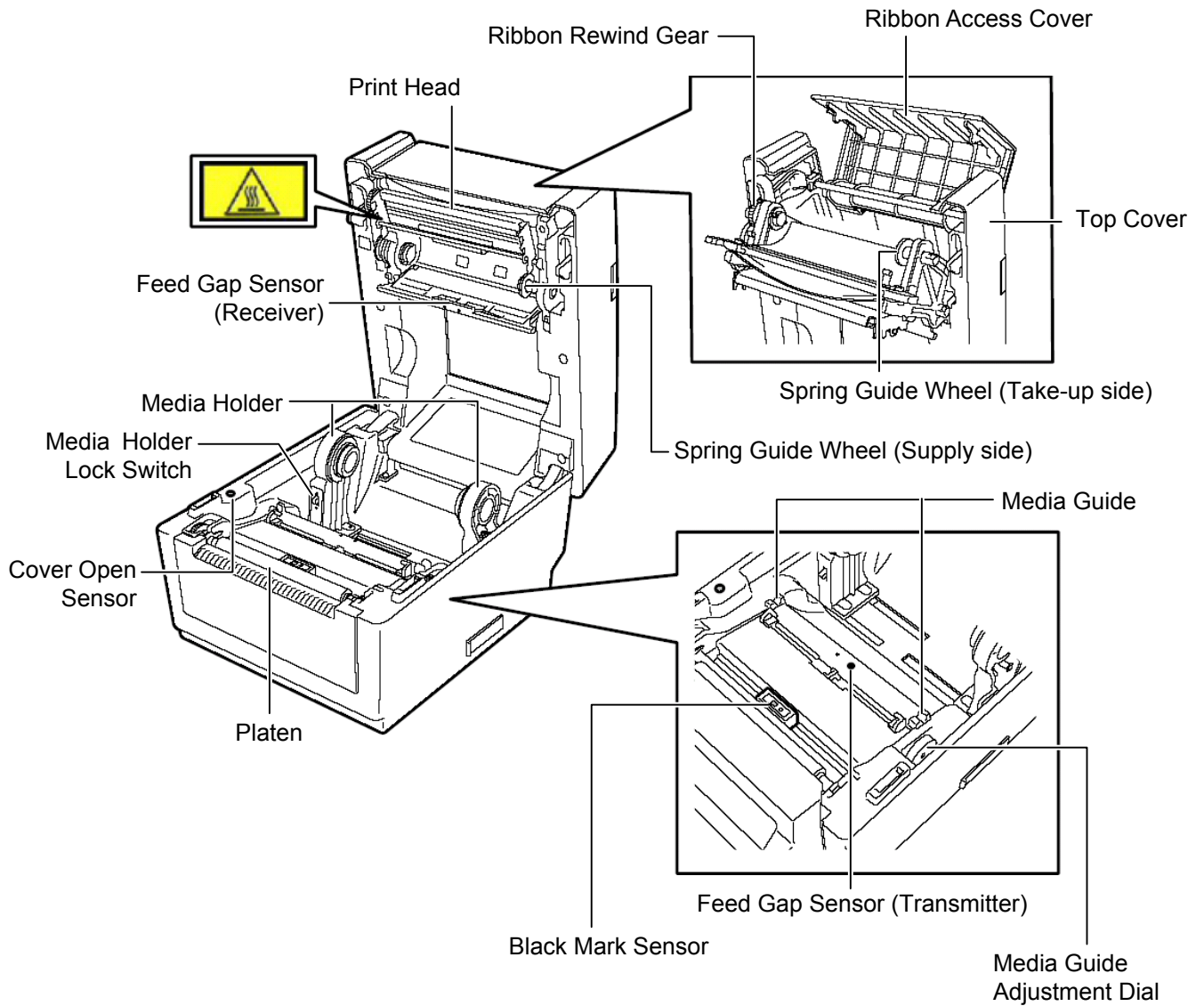

1.2 Indication of the Model Name

B - E V 4 D - G S 14 - QM - R

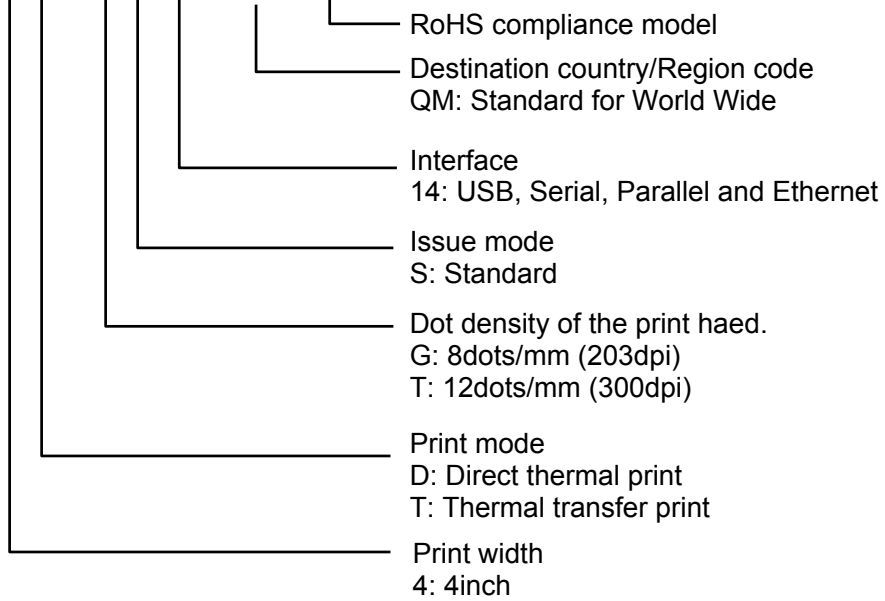

1.3 Basic Specifications

Model		B-EV4D	B-EV4T
General Characteristics	Construction	Double walled casing & Clam shell design	
	Maintenance	No tool required to repair thermal head and platen	
	Paper holder	No roll spindle & No paper holder spring	
Printer characteristics	Print method	Direct thermal printing	Direct thermal/thermal transfer printing
	Resolution	GS model: 203 dpi (8 dots/mm)	
		TS model 300 dpi (12 dots/mm)	
	Print width	GS model: 203 dpi Max. 4.25" (108 mm)	
		TS model: 300 dpi Max. 4.17"(106mm)	
	Print length	GS model: 203 dpi, Max. 39" (999 mm) TS model: 300 dpi, Max. 39" (999 mm)	
	Print Speed	GS model: 203 dpi, 2, 3, 4, 5"/sec, 2, 3 ips for peel-off	
		TS model: 300 dpi, 2, 3, 4"/sec, 2 ips for peel-off	
	RAM	8 MB SDRAM	
	Flash ROM	4 MB	
	User area	832 KB	
	Optional memory	SD Card	
	Media sensors	Feed gap sensor Black mark sensor Cover open (Reflective) Ribbon end (Reflective encoder sensor)	
	I/F (User installable)	RS-232C (Max. 115.2Kbps) Centronics (SPP) USB 2.0 (Support Full Speed) LAN 10/100Base	
	Barcode Linear (Same as B-SA4 series)	UPC-A, UPC-E, EAN8/13, UPC-A add on 2&5, EAN-8/13 add on 2&5, Code39, Code93, Code128, EAN128, NW7, MSI, Industrial 2 of 5, ITF, Postnet, RM4SCC, KIX-code, Plessey, RSS14	
Printer Language	TPCL (Refer to External Equipment I/F manual)		
2D Barcode (Same as B-SV4 series)	Data Matrix, PDF417 Maxicode, QR code Micro PDF417		

Model		B-EV4D	B-EV4T
Printer characteristics	Fonts	Bitmap: Alpha-numeric 20 types + Kanji 4 types Outline: 2 types Writable characters, Optional TTF	
	LED	One LED w/ 3 colors (w/ silk screen print of "STATUS")	
	Key	Feed key (w/ silk screen print of "FEED")	
	Switch	Power S/W	
Media characteristics	Label width	1" (25.4 mm) to 4.41" (112 mm)	
	Label length	203 dpi: 0.6" (15 mm) to 39" (999 mm) 300 dpi: 0.6" (15mm) to 39" (999 mm)	
	Label length (Strip mode)	25.4~152.4 mm (1"~6")	
	Label length (Cutter mode)	25.4~999 mm (1"~39")	
	Roll diameter	Max. 5" (127 mm)	
	Core diameter	1" (25.4 mm) to 1.5" (38 mm)	
	Media thickness	0.0024" (0.06 mm) to 0.0075" (0.19 mm)	
	Media types	Roll-fed, Fanfold, Die-cut, Continuous, Tag stock, Receipt	
Ribbon characteristics	Outside diameter	-----	Max. 40 mm
	Standard length	-----	110 m
	Ribbon width	-----	1.33" (33.8 mm) to 4.30" (110 mm)
	ID core	-----	0.5" (12.7 mm)
Operating characteristics	Operating temperature	41 degF (5 degC) to 104 degF (40 degC)	
	Storage temperature	-40 degF (-40 degC) to 140 degF (60 degC)	
	Operating humidity	25 to 85 % (Non-condensing R.H)	
	Storage humidity	10 to 90 % (Non-condensing R.H)	
	Electrical	AC Adapter: 100-240 VAC, 50/60 Hz \pm 10%	
		Power consumption G Type (203dpi) During standby: 100mA (2.4W) During a print job: 3A (72W) T Type (300dpi) During standby: 100mA (2.4W) During a print job: 2.5A (60W)	
		Rush Current 110V input: \leq 45A 220V inpt: \leq 90A	
Agency approvals	FCC Class B C-Tick CE TUV UL, cUL CCC VCCI Class B (Japanese model), PSE (AC adapter, Japanese model)		
Environmental complaint	RoHS WEEE		

Model		B-EV4D	B-EV4T
Physical characteristics	Width	7.8" (198 mm)	7.8" (198 mm)
	Height	6.7" (169.5 mm)	6.8" (173 mm)
	Depth	10.2" (258 mm)	10.2" (258 mm)
	Weight	2.5Kg or less	2.5Kg or less
Related products	Options	Full cutter module (B-EV204-F-QM-R) Partial cutter module (B-EV204-P-QM-R) Strip module (B-EV904-H-QM-R) External Media Holder (B-EV904-PH-QM-R) AC Adapter Cover Kit (B-EV904-AC-QM-R)	
	Accessories	Start-up CDROM Power Adapter Supply Loading Instruction Safety Precautions	

1.4 Key and LED

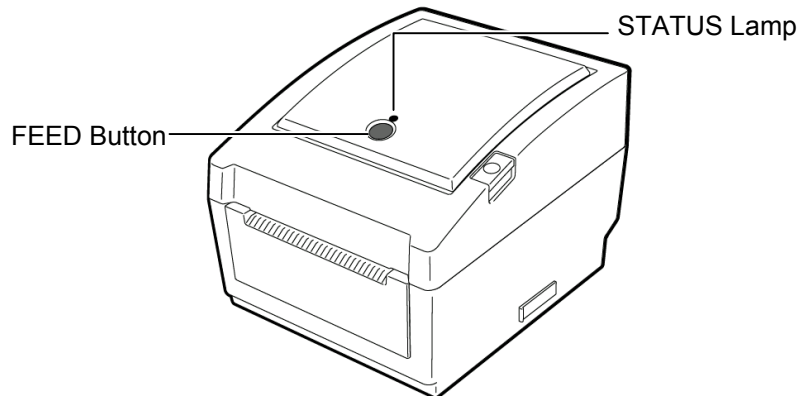

The **[FEED]** button operates as FEED button or PAUSE button depending on the printer statuses.

As the FEED button	Pressing this button when the printer is in online state causes a media feed. Pressing this button after removing a cause of an error returns the printer to online state.
As the PAUSE button	Pressing this button during printing stops printing after completing the current label. The printer resumes printing when this button is pressed again.

The indicator lamp lights up or flashes in different colors depending on the printer statuses. The main indicator lamp statuses and the corresponding printer statuses are shown inside the top cover.

Color	Status	Printer status
Green	Lights up	Stand-by
Green	Flashes fast	Communicating with a host.
Green	Flashes slowly	Printing is temporarily stopped (paused).
Green/Red	Flashes slowly	The print head temperature exceeded the upper limit.
Red	Lights up	A communication error occurred. (Only when the RS-232C is used.)
Red	Flashes fast	A paper jam occurred.
Red	Flashes at medium speed	The media is ended.
Red	Flashes slowly	An issue or feed was attempted with the top cover opened.
Orange	Flashes fast	A paper jam occurred in the cutter unit. (Only when the cutter unit is fitted.)
Orange	Flashes at medium speed	The ribbon is ended.
None	Unlit	The top cover is open.

1.5 Supply Specifications

1.5.1 Media Type

The table below shows the size and shape of the media that can be used on this printer.

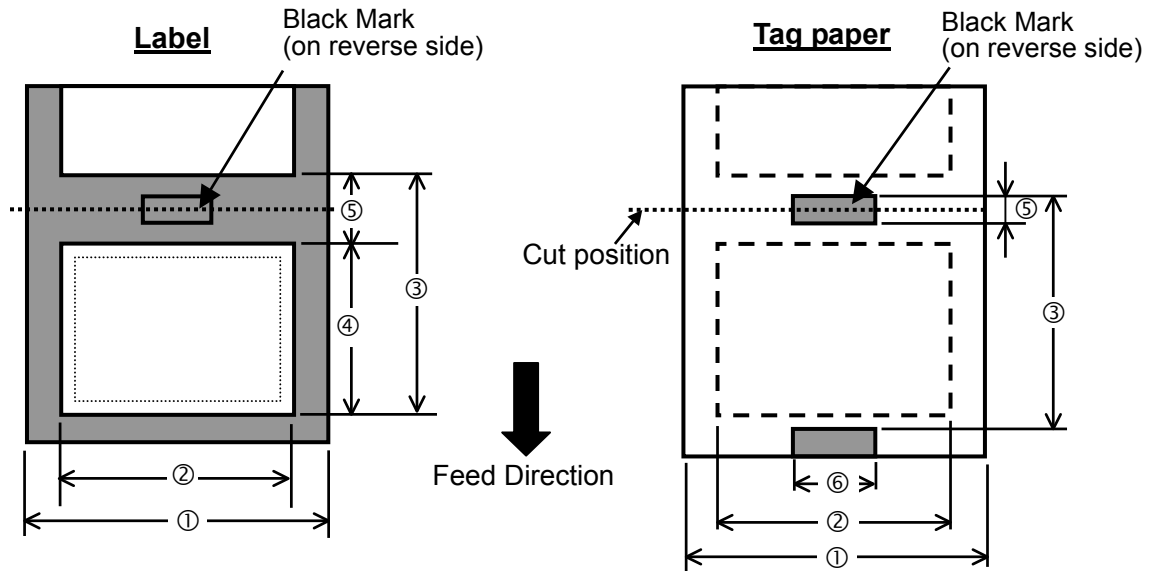

Unit: mm (inch)

Item		Issue mode	Batch mode	Strip mode	Cut mode
① Width including backing paper			25.4 to 112 (1.0 to 4.41)		
② Media width			22.4 to 109 (0.88 to 4.29)		
③ Media pitch	Label	203 dpi	10 to 999 (0.39 to 39.3)	25.4 to 152.4 (1.0 to 6)	25.4 to 999 (1.0 to 39.3)
		300 dpi	10 to 457.2 (0.39 to 18.0)	25.4 to 152.4 (1.0 to 6)	25.4 to 457.2 (1.0 to 18.0)
	Tag	203 dpi	10 to 999 (0.39 to 39.3)	----	25.4 to 999 (1.0 to 39.3)
		300 dpi	10 to 457.2 (0.39 to 18.0)	----	25.4 to 457.2 (1.0 to 18.0)
④ Media length		203 dpi	8 to 997 (0.31 to 39.25)	23.4 to 150.4 (0.92 to 5.92)	19.4 to 993 (1.0 to 39.1)
		300 dpi	8 to 455.2 (0.31 to 17.9)	23.4 to 150.4 (0.92 to 5.92)	19.4 to 451.2 (1.0 to 17.76)
⑤ Gap/black mark length			2.0 to 10.0 (0.08 to 0.39)		6.0 to 10.0 (0.24 to 0.39)
⑥ Black mark width			Min. 8.0 (0.31)		
Thickness			0.06 to 0.19 (0.0024 to 0.0075)		
Max. outer roll diameter			Ø127 (5) Ø214 (8.42): When the optional External Media Roll Hanger is used.		
Roll direction			Outside (standard), Inside (Refer to NOTE 3)		
Inner core diameter			25.4 to 38.1, or 76.2 (1 to 1.5, or 3) (See NOTE 2.)		

NOTES:

1. To ensure print quality and print head life use only TOSHIBA TEC approved media.
2. When using a media roll of 76.2-mm (3") inner core diameter, the 3"-Diameter Media Shaft included in the optional External Media Roll Hanger is required.
3. Precaution for use of labels
 When labels are used for printing, please only use outside wound labels.
 Use of an inside wound label causes a paper jam.

	Outside wound	Inside wound
Label	Usable	Not usable
Tag Paper	Usable	Usable

1.5.2 Detection Area of the Transmissive Sensor

The Transmissive sensor is fixed and positioned at 6.35 mm right of the center of the media path. The Transmissive Sensor detects a gap between labels, as illustrated below.

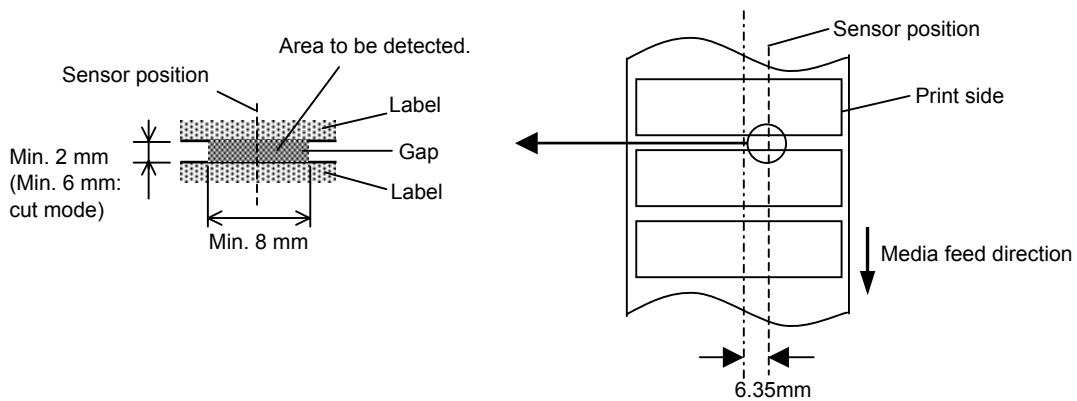

1.5.3 Detection Area of the Reflective Sensor

The figure below illustrates the relation between the head effective print width and media width. (for GS14 Type)

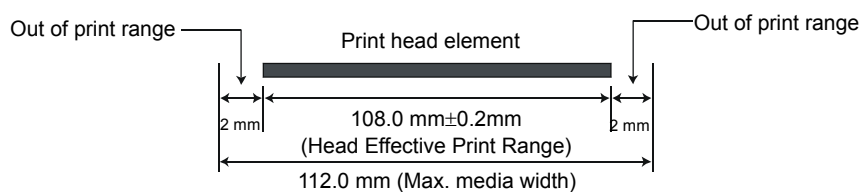

(for TS14 Type)

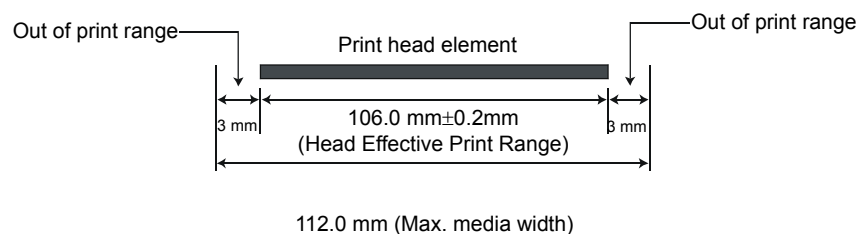

The figure below shows the effective print area on the media.

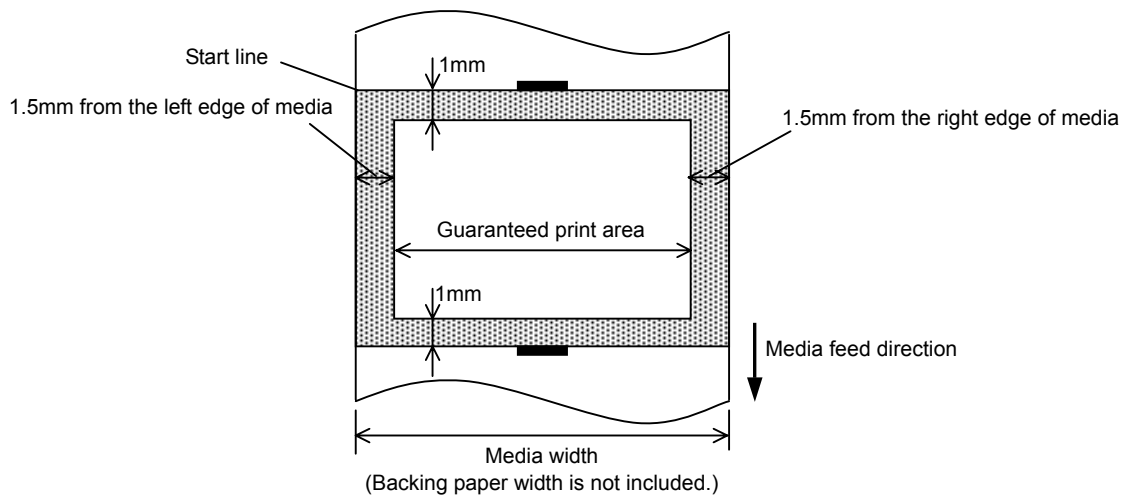

NOTES:

1. Be sure not to print on the 1.5-mm wide area from the media edges (shaded area in the above figure).
2. The centre of media should be positioned at the centre of the print head.
3. Print quality is not guaranteed within 3 mm from the print head stop position (including 1-mm slow-up.)
4. Average print (black) rate should be 15% or less. For bar code print area, the print rate should be 30% or less.
5. Line weight should be 3 to 12 dots.

1.5.4 Ribbon

Type	Spool type
Width	33.8 mm to 110 mm
Length	Depends on its thickness and outside diameter of core.
Max. outside diameter	∅40 mm
Inside diameter of core	12.7 mm
Roll direction	Outside

NOTES:

1. To ensure print quality and print head life use only TOSHIBA TEC specified ribbons.
2. Too much difference in width between media and ribbon may cause ribbon wrinkles. To avoid ribbon wrinkles use a ribbon for proper media width shown in the above table. Do not use a ribbon that is narrower than media.
3. When discarding ribbons, please follow the local rule.

2. ELECTRONIC SPECIFICATIONS

2.1 Block Diagram

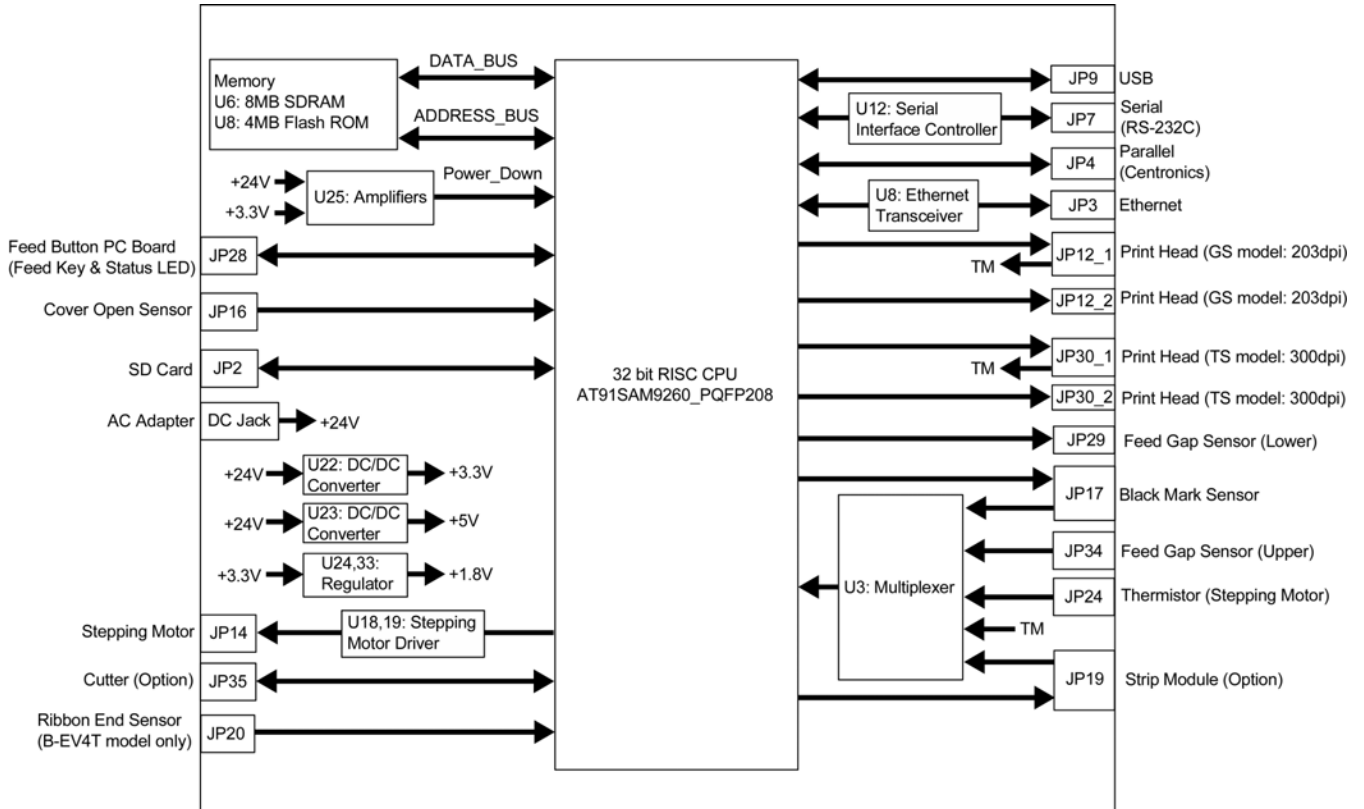

2.2 Main PC Board Layout

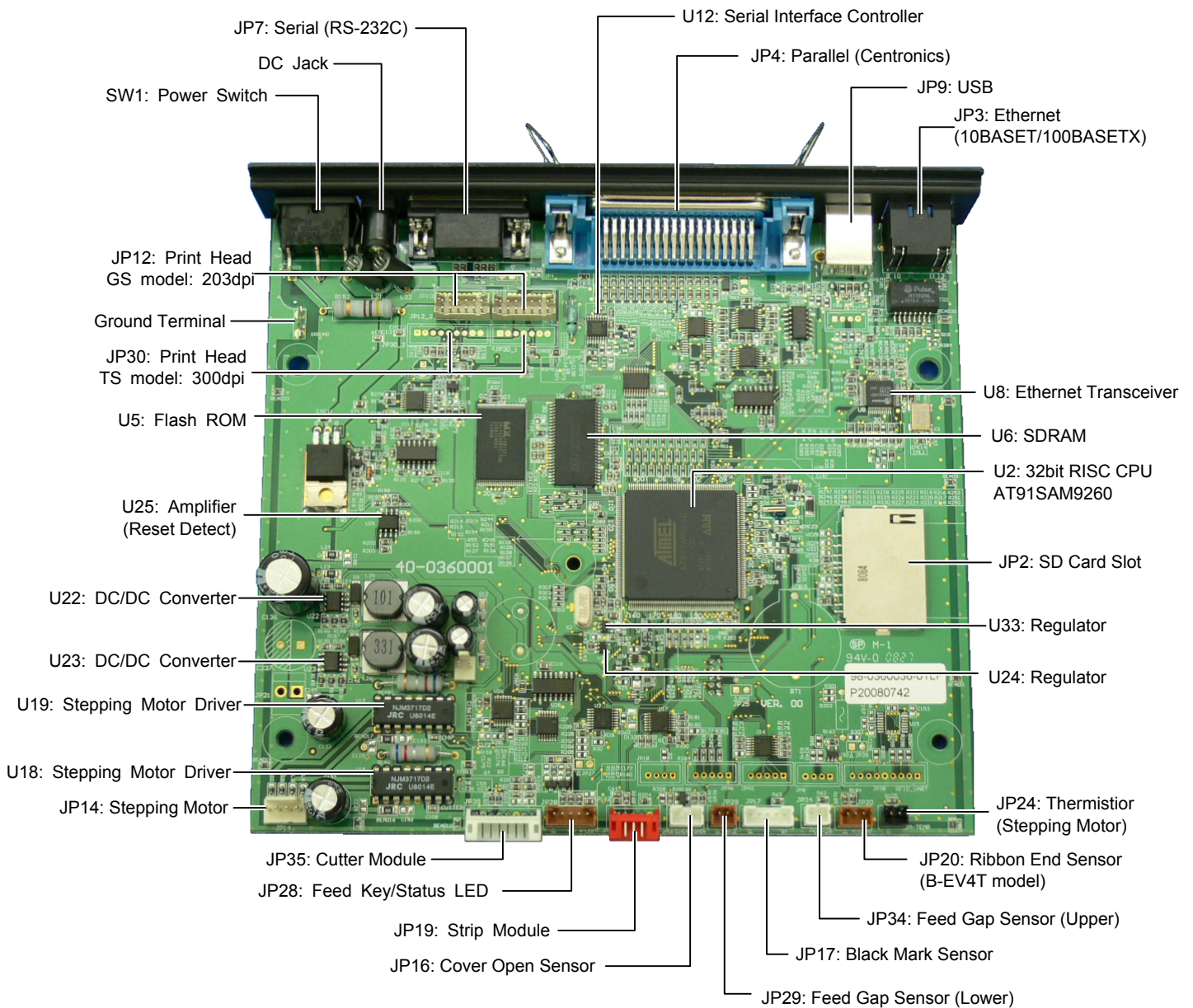

2.3 Description of the MAIN PC Board

This PC board, the brain of the printer, is comprised of the following components.

32bit RISC CPU (U2):



Type: AT91SAM9260

The 32bit RISC CPU operates the following processing:

Controlling the interfaces

- Serial Interface (RS-232C)
- Parallel Interface (Centronics)
- Ethernet (10BASET/100BASETX)

Controlling the Status LED

Detect the [Feed] key

Controlling the read/write operation on the memory

- Flash ROM
- SDRAM
- SD Card

Controlling the options

- Cutter Module
- Strip Module

Control and detect sensor statuses

- Ribbon Sensor
- Cover Open Sensor
- Feed Gap Sensor
- Black Mark Sensor
- Motor Temperature Thermistor

Controlling the Print Head

Flash ROM (U5):



Type: MX29LV320CBTC-70G

Capacity: 32M bit

The programmed data of the boot program, main program, C/G, writable character are written into the flash ROM.

SDRAM (U6):



Type: IS42S16400B-6TL

Capacity: 64M bit

It is used for drawing the print data and used as a work area.

DC/DC Converter (U22, 23):



Type: TS34063

It generates the voltages (+5V, +3.3V) from the power supply voltage (AC adapter).

+5V and +3.3V are used as the operating voltage for each circuit.

Ethernet Transceiver (U8):



Type: DM9161

This IC is used for controlling the Ethernet (10BASET/10BASETX).

Regulator (U24, U33):



Type: TS68N28CX5, TS9007DCX

It generates the voltages (+1.8) from the DC/DC converter voltage (+3.3V).

Stepping Motor Driver (U18, U19):



Type: PBL3717

This IC is used for controlling the Stepping Motor.

Serial Interface Controller (U12):



Type: SP3232ECY

This IC is used for controlling the Serial Interface (RS-232C).

Reset detect circuit (U25):



Type: TS358

This IC is single supply dual operation amplifiers.

It detects the voltage depression from +24V and +3.3V and outputs the Power Down signal to the CPU.

JP2 (SD Card Slot):

Signal	Pin No.
CD/DAT3	1
CMD	2
VSS1	3
VDD	4
CLK	5
VSS2	6
DAT0	7
DAT1	8
DAT2	9
GND	10
GND	11
CD	12
WP	13

Type: MS3B11-KAA-0

This connector is connected to the SD Card.

Note: *Recommended SD card specification.*

- Supported DOS FAT file system.
 - Folders stored in the SD card should be in the 8.3 filename format.
 - Approved SD card manufacturers: SanDisk, Transcend.
- SD V 1.0, V 1.1: 128MByte, 256MByte, 512MByte, 1GByte
SD V 2.0 (SDHC): 4GByte Class 6

JP3 (Ethernet):

Signal	Pin No.
Tx+	1
Tx-	2
Rx+	3
N/C	4
N/C	5
Rx-	6
N/C	7
N/C	8
Cathode of the Yellow LED	9
+3.3V (Anode of the Yellow LED)	10
Cathode of the Green LED	11
+3.3V (Anode of the Green LED)	12

Type: RJ45 with 2LEDs (Yellow and Green)

This connector is used for the Ethernet (10BASET/100BASETX).

JP4 (Parallel Interface):

Signal	Pin No.
Strobe	1
Data0	2
Data1	3
Data2	4
Data3	5
Data4	6
Data5	7
Data6	8
Data7	9
Ack	10
Busy	11
Paper Out / End	12
Select	13
GND	14
No Defined	15
GND	16
GND	17
No Defined	18
GND	19
GND	20
GND	21
GND	22
GND	23
GND	24
GND	25
GND	26
GND	27
GND	28
GND	29
GND	30
No Defined	31
Error / Fault	32
GND	33
GND	34
GND	35
No Defined	36

This connector is used for the Parallel (Centronics) interface.

Pin	SPP Mode	Nibble Mode	I/O	Function
1	Strobe	N/A	I	A low on this line indicates that there are valid data at the host. When this pin is de-asserted, the +ve clock edge should be used to shift the data into the device.
2-9	Data 0-7	N/A	I	Data Bus. Single-directional.
10	Ack	N/A	O	A low on this line indicates that there are valid data at the Device. When this pin is de-asserted, the +ve clock edge should be used to shift the data into the host.
11	Busy	N/A	O _t	When in reverse direction, a high indicates data, while a low indicates a command cycle. In forward direction, it functions as PtrBusy.
12	Paper Out / End	N/A	O	When low, device acknowledges reverse request.
13	Select	N/A	O	Extensibility flag
14	Ground	N/A	GND	Ground
15	No Defined	N/A	N/A	
16-17	Ground	N/A	GND	Ground
18	No Defined	N/A	N/A	
19-30	Ground	N/A	GND	Ground
31	No Defined	N/A	N/A	
32	Error / Fault	N/A	O	A low set by the device indicates that the reverse data is available
33-35	Ground	N/A	GND	Ground
36	No Defined	N/A	N/A	

JP7 (Serial Interface):

Signal	Pin No.
+5 V	1
TXD	2
RXD	3
CTS	4
GND	5
RTS	6
N/C	7
RTS	8
N/C	9

Type: D-Sub 9pin

This connector is used for the Serial (RS-232C) interface.

+5V is output from the pin 1.

The TXD signal is a serial signal and output from the pin 2.

The RXD signal is a serial signal and input into the pin 3.

JP9 (USB):

Type: Type B Connector

This connector is used for the USB interface.

Signal	Pin No.
+5 V	1
D-	2
D+	3
N/C	4
GND	5

JP12 (Print Head):

This connector is connected to the print head (for GS model, 203dpi).
The voltages and signals for controlling the print head are input/output into/from the connector.

JP12-1

Signal	Pin No.
VH (+24V)	1
VH (+24V)	2
VH (+24V)	3
VH (+24V)	4
GND	5
GND	6
/STB2	7
NC	8
TM	9
TM	10
VDD (+5V)	11
GND	12
/STB1	13
GND	14

JP12-2

Signal	Pin No.
CLK	1
GND	2
GND	3
GND	4
DI	5
/LAT	6
GND	7
GND	8
VH (+24V)	9
VH (+24V)	10
VH (+24V)	11
VH (+24V)	12

JP14 (Stepping Motor):

This connector is connected to the Stepping Motor.

Signal	Pin No.
MB (PHASE1)	1
MA (PHASE1)	2
MB (PHASE2)	3
MA (PHASE2)	4

JP16 (Cover Open Sensor):

This connector is connected to the Cover Open Sensor.

Signal	Pin No.
+3.3V	1
HEAD	2
GND	3

JP17 (Black Mark Sensor):

This connector is connected to the Black Mark Sensor.

Signal	Pin No.
N.C.	1
+3.3V	2
BM_E	3
BM_R	4
+3.3V	5

JP19 (Strip Module):

This connector is connected to the Strip Module.

Signal	Pin No.
+3.3V	1
PEEL_SW	2
PEEL_E	3
PEEL_R	4
GND	5

JP20 (Ribbon End Sensor):

This connector is connected to the Ribbon End Sensor. (B-EV4T model only)

Signal	Pin No.
+3.3V	1
RIB_END	2
GND	3

JP24 (Stepping Motor Thermistor): This connector is connected to the Stepping Motor Thermistor. MOTOR TEMP signal is temperature of the stepping motor.

Signal	Pin No.
MOTOR TEMP	1
GND	2

JP28 (Feed Key/Status LED): This connector is connected to the Feed Key and Status LED.

Signal	Pin No.
+3.3V	1
GREEN_LED	2
RED_LED	3
T_KEY	4
GND	5

JP29 (Feed Gap Sensor, Lower): This connector is connected to the Lower Feed Gap Sensor (Photo Diode).

Signal	Pin No.
+3.3V	1
GAP_E	2

Print Head (JP30):

This connector is connected to the print head (for TS model, 300dpi). The voltages and signals for controlling the print head are input/output into/from the connector.

JP30-1

Signal	Pin No.
VH (+24V)	1
VH (+24V)	2
TM	3
TM	4
/STB2	5
GND	6
GND	7

JP30-2

Signal	Pin No.
GND	1
GND	2
VDD (+5V)	3
/STB1	4
/LAT	5
CLK	6
DI	7
VH (+24V)	8
VH (+24V)	9

3. REPLACING THE IMPORTANT PARTS

WARNING!

1. Turn off the power switch and disconnect the DC plug of the AC Adapter and the RS-232C cable before replacing any parts.
2. Follow all manual instructions. Failure to do so could create safety hazards such as fire or electrocution.

CAUTION!

1. To protect the connector pins or component from static discharge, do not touch them with bare hand.
2. Use electrostatic free form and the original carton for transportation.
3. Keep your work environment static free to avoid damage to the printer.
4. Do not remove any connectors from the printer within 10 sec. after unplugging the power cord.

NOTES:

1. Manual instructions must be followed when installing option kits or adding cables to avoid system failures and to insure proper performance and operation.
2. Failure to follow manual instructions or any unauthorized modifications, substitution or change to this product will void the limited product warranty.

■ Lubrication

CAUTION!

1. Lubrication: During parts replacement
2. Kinds of oil: FLOIL G-488: 1kg can (part No.: 19454906001)

Any machine is generally in its best condition when delivered; therefore, it is necessary to try to keep this condition. Unexpected failure occurs due to lack of oil, debris, or dust. To keep its best condition, periodically clean the machine and apply proper kinds of oil to each part in which lubrication is needed. Although the frequency of lubrication varies according to how much the machine is used, at least it is necessary to lubricate before the machine becomes dry. It is also necessary to wipe off excessive oil as it collects dirt.

NOTE: Before replacing the important parts, store the printer parameter data on a PC with the B-EV4 setting tool. Uploading the data from the PC to the printer after replacement restores the printer parameter setting to the status prior to replacement. Regarding the details of B-EV4 setting tool, refer to the B-EV4 Setting Tool Specification posted on the Barcode Knowledge Pot. URL of Barcode Knowledge Pot
<http://barcode.toshibatec.co.jp/Ris/products/barcode/support/en/index.php>

3.1 Replacing the Top Cover

3.1.1 B-EV4T model

1. Press down the top cover release button to unlock the top cover, then fully open the top cover.

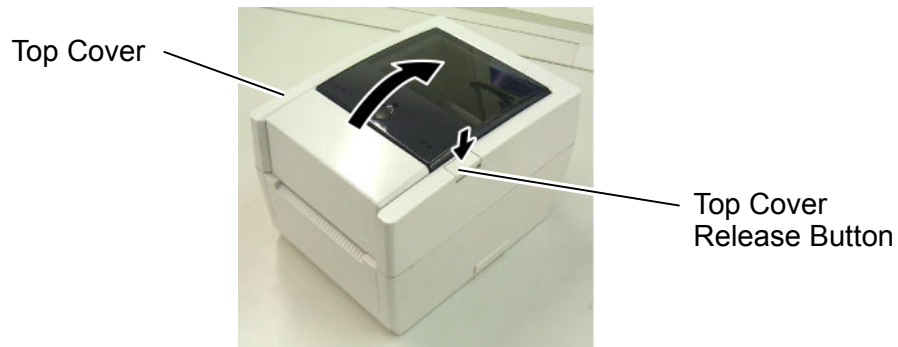

2. Use the Phillips screwdriver to remove the 6 screws from the top inner cover.

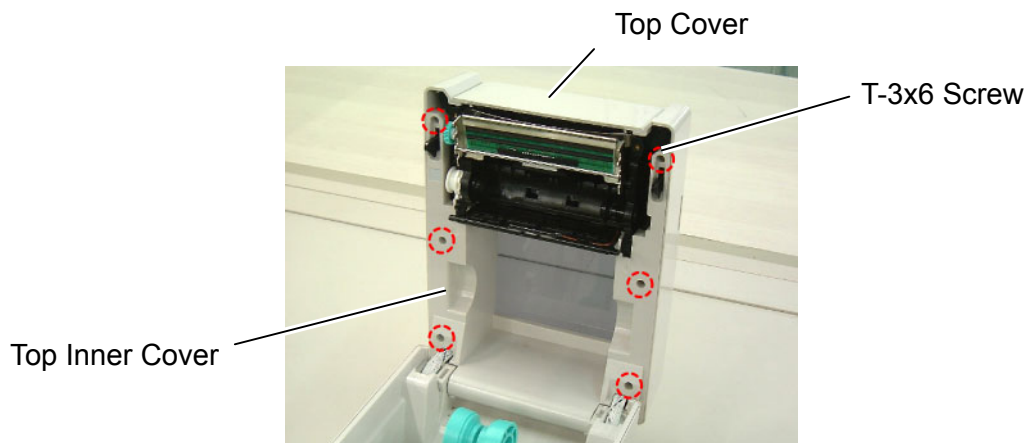

3. Disconnect the connector from the feed button PC board.

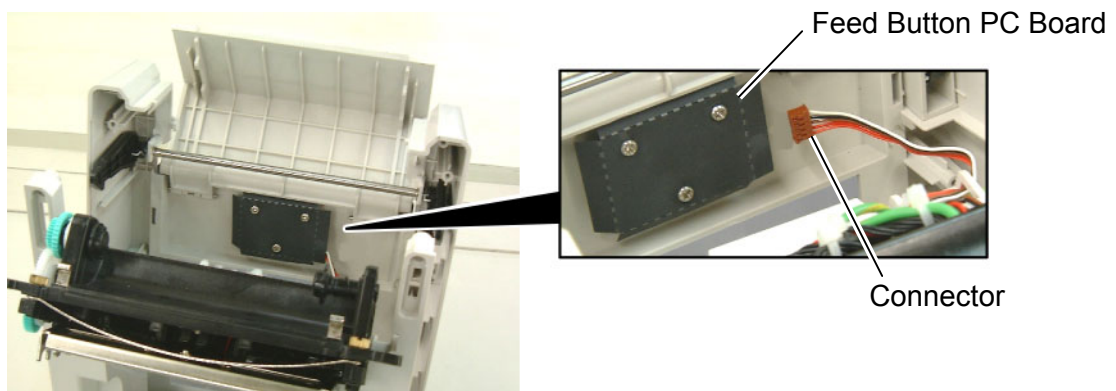

4. Remove the top cover.
5. Replace the top cover with a new one, then reassemble in the reverse order of removal.

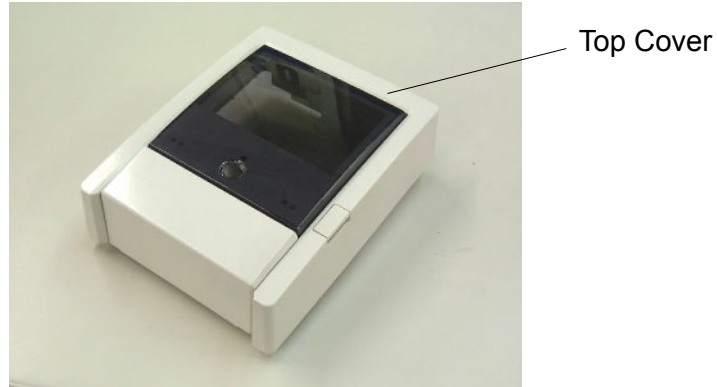

3.1.2 B-EV4D model

1. Press down the top cover release button to unlock the top cover, then fully open the top cover.

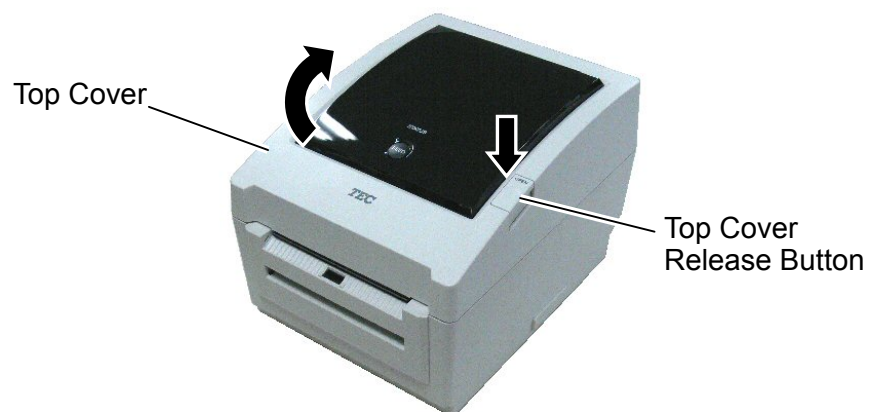

2. Use the Phillips screwdriver to remove the 6 screws from the top inner cover.

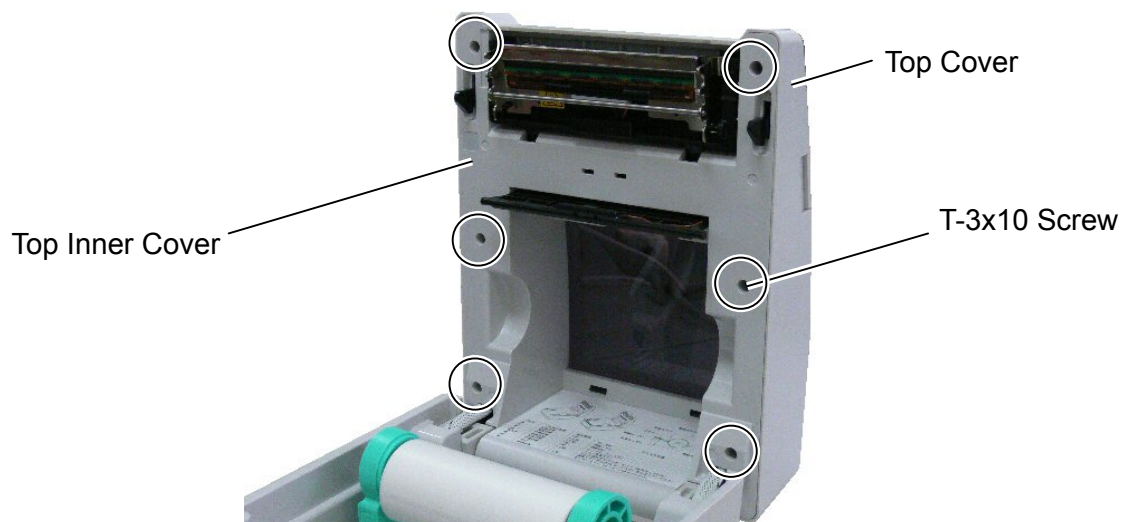

3. Release the media view window hooks which hold the top cover together with the top inner cover.

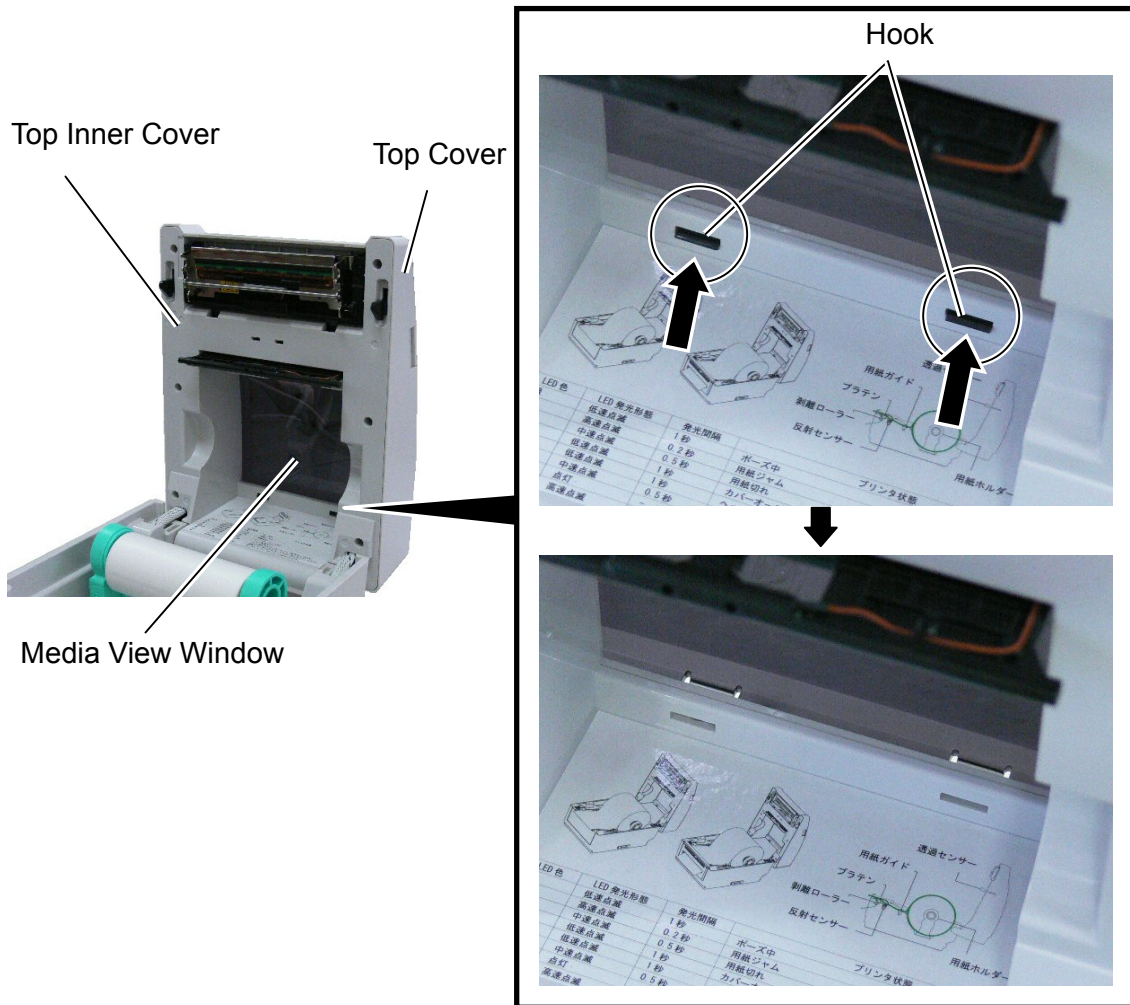

4. Upward move the top cover release levers, and then release the top cover from the top inner cover.

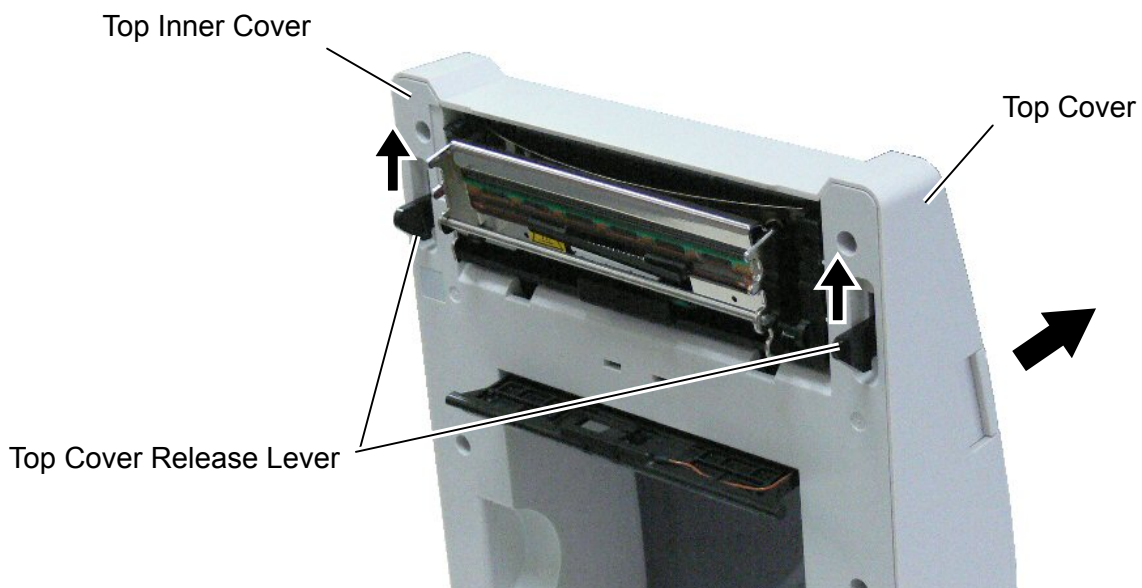

5. Disconnect the connector from the feed button PC board.

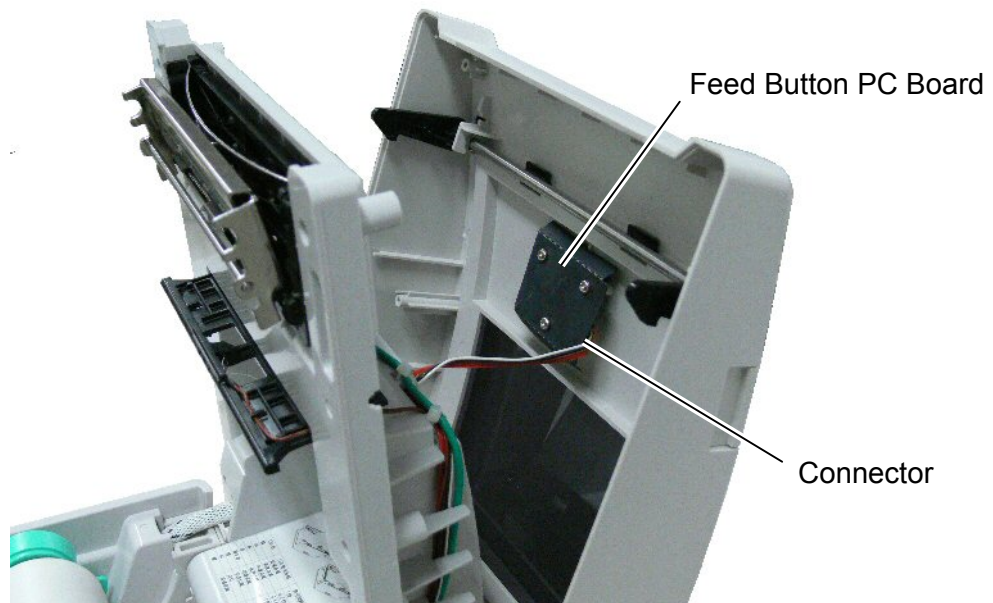

6. Remove the top cover.
7. Replace the top cover with a new one, then reassemble in the reverse order of removal.



3.2 Replacing the Lower Cover

1. Turn the printer upside down and use the Phillips screwdriver to remove the 6 screws.
2. Remove the lower cover.

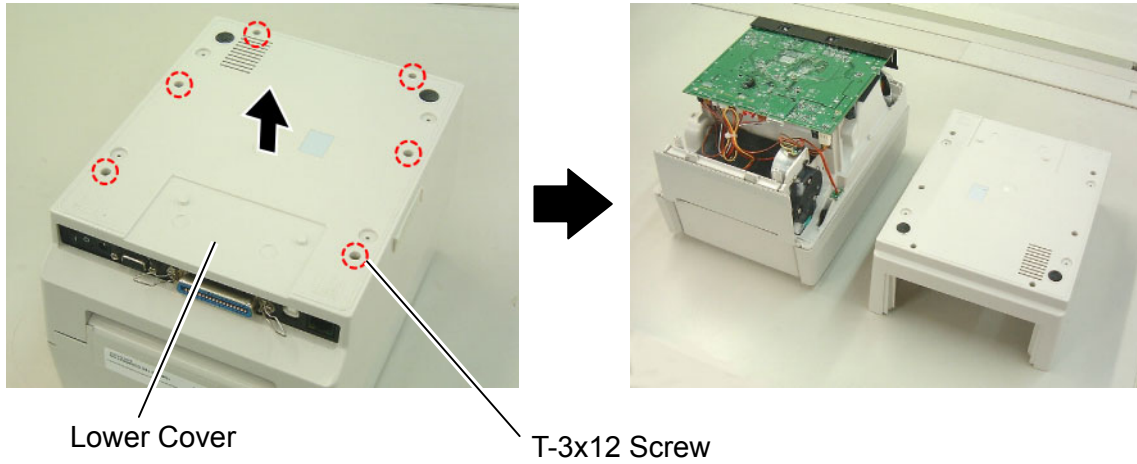

3. Replace the lower cover with a new one, then reassemble in the reverse order of removal.

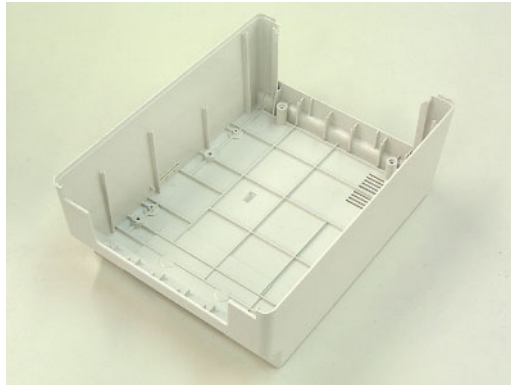

3.3 Replacing the Main PC Board

1. Refer to section 3.2 to remove the lower cover.
2. Remove the screw from the main PC board.
3. Disconnect all connectors from the main PC board.

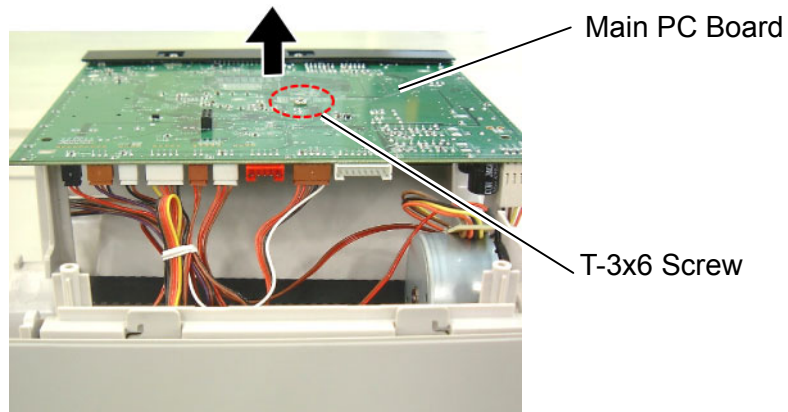

4. Use the Phillips screwdriver to remove the 2 screws and use the socket wrench to remove the 2 bolts.

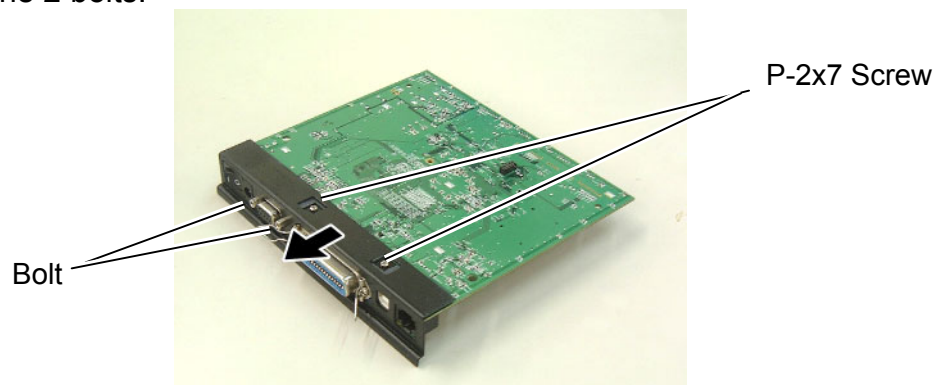

5. Detach the interface plate and the black mylar from the main PC board.

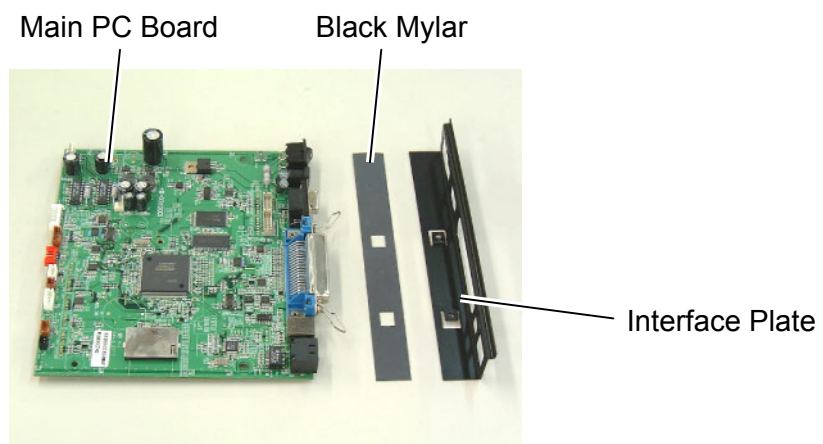

6. Replace the main PC board with a new one, then reassemble in the reverse order of removal.



7. After replacement, perform the following operations.
 - Perform a media sensor calibration with the button of the printer or B-EV4 Setting Tool.
Regarding the media sensor calibration, refer to the Owner's Manual or the B-EV4 Setting Tool Specification posted on the Barcode Knowledge Pot.
URL of Barcode Knowledge Pot:
<http://barcode.toshibatec.co.jp/Ris/products/barcode/support/en/index.php>
 - Perform a printer parameter setting with the B-EV4 Setting Tool.
 - Perform an interface setting (RS-232C, Ethernet) with the B-EV4 Setting Tool.

NOTE: It is possible to save/upload the printer parameter and interface setting into/from the PC with the B-EV4 Setting Tool.
8. Also, make sure the printer performs correctly for the following points.
 - The sensor adjustment is performed correctly.
 - Printing is performed correctly during the diagnostic test print.
 - When the PC connected to the printer sends sample data to the printer, printing is performed correctly.

NOTE: Firmware download onto the Main PC board
Perform a firmware download onto the Main PC board if necessary (in the case of alteration/addition to the specification).
Regarding the download procedure, refer to Firmware Down Loading Procedure which is posted on the Barcode Knowledge Pot. The firmware program to be downloaded is also available from this website.

3.4 Replacing the Platen Ass'y

1. Refer to section 3.1 to open the top cover.
2. Release the platen holder tabs from the lower inner cover and vertically raise them.
3. Remove the platen ass'y.

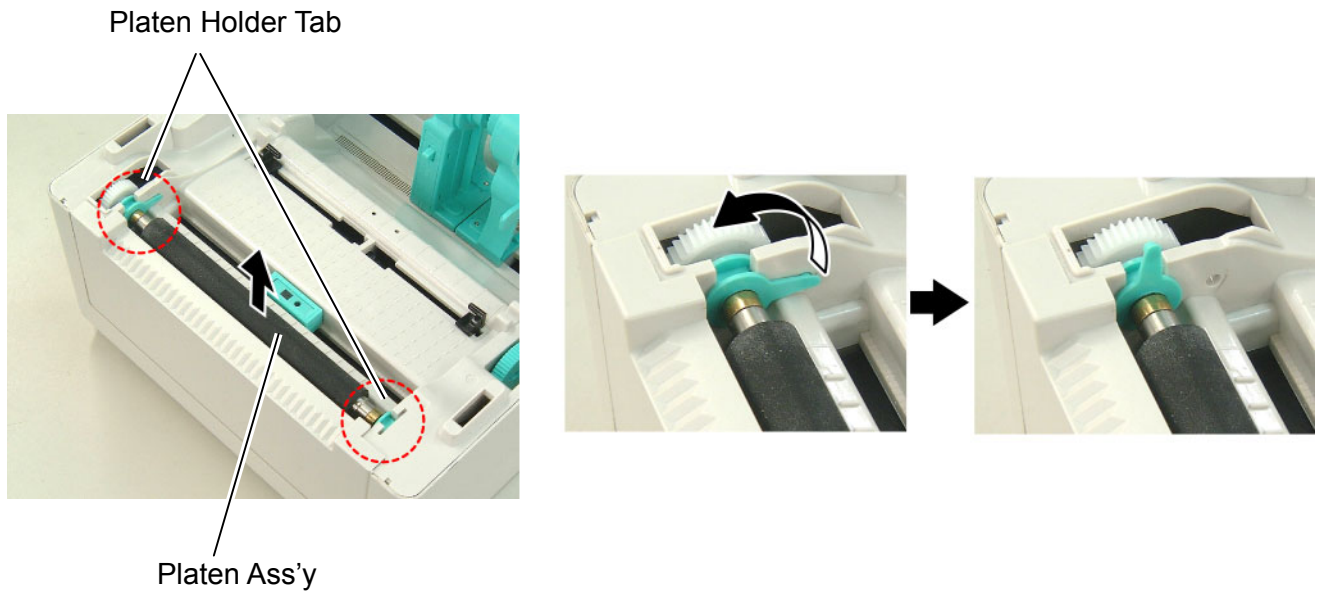

4. Replace the platen ass'y with a new one, then reassemble in the reverse order of removal.



5. After replacing, perform a diagnostic test print or print a sample label to make sure the printer performs correctly for the following points.
 - The label is issued correctly.
 - No noise is generated during the print operation.
 - None of blurred print, smudge, etc. is generated.

3.5 Replacing the Print Head Ass'y

CAUTION!

1. NEVER touch the element when handling the Print Head.
2. NEVER touch the connector pins to avoid a breakdown of the Print Head by static electricity.

3.5.1 B-EV4T model

1. Refer to section 3.1 to open the top cover.
2. Open the ribbon access cover.

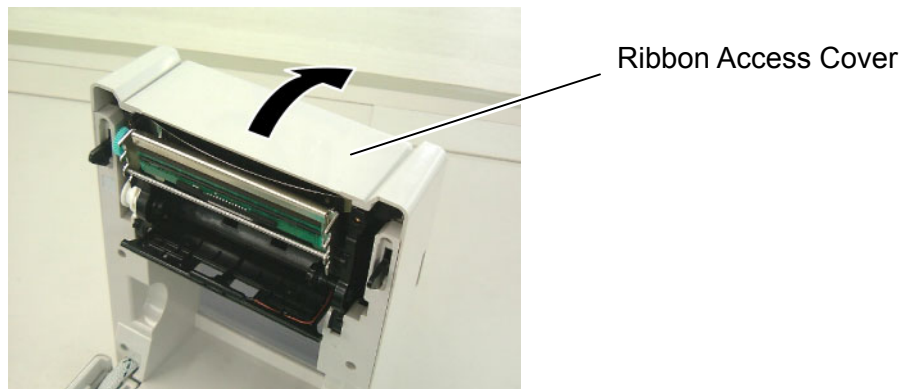

3. Remove the two screws which secure the print head ass'y.

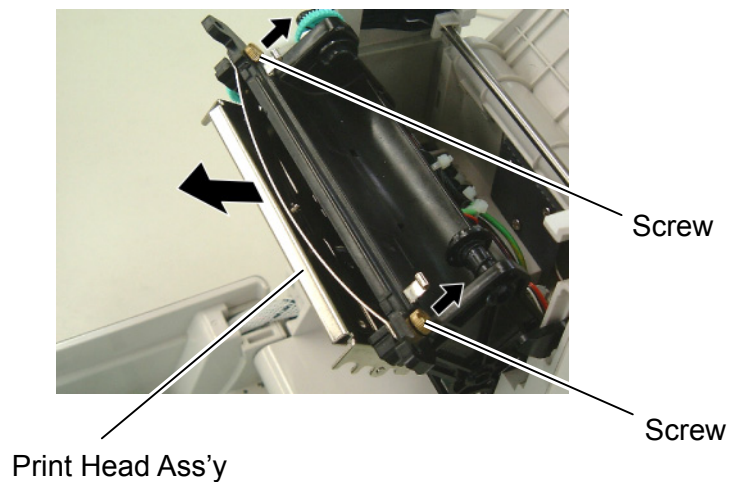

4. Remove the connector from the print head ass'y.
5. Remove the print head ass'y.

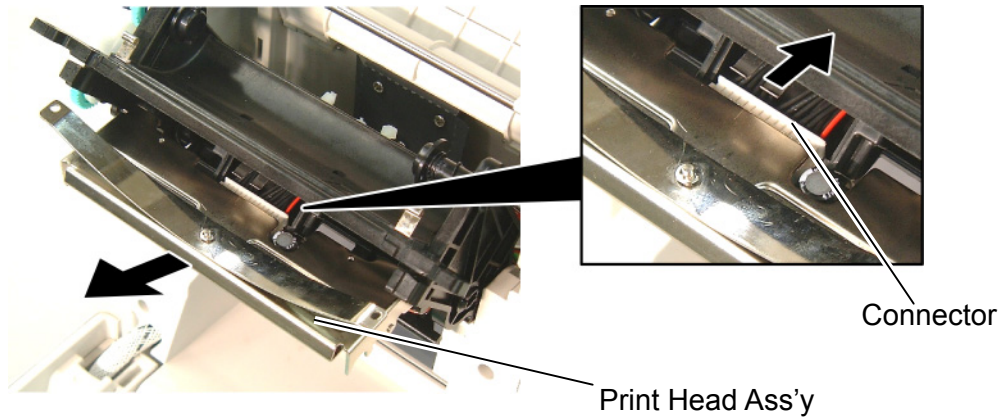

6. Replace the print head ass'y with a new one, then reassemble in the reverse order of removal.

[Print head element side]

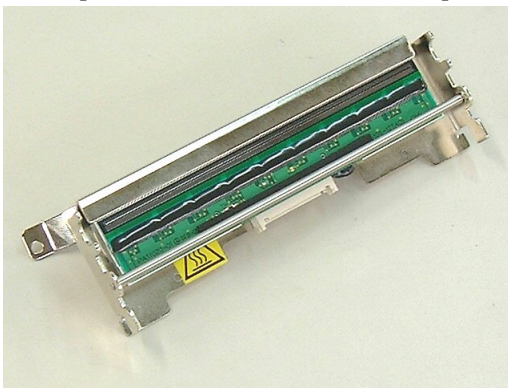

[Print head bracket side]

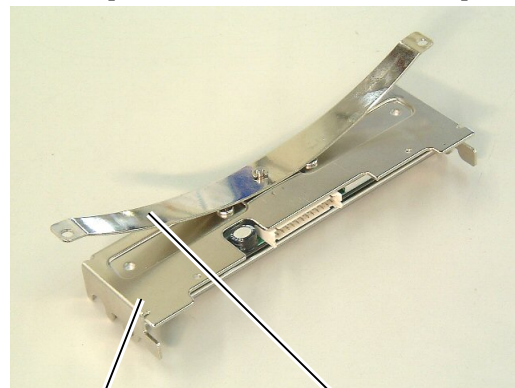

Bracket

Spring Plate

NOTE: Do not disassemble the print head ass'y which contains the bracket and the spring plate.

7. After replacing, perform a diagnostic test print or print a sample label to make sure the printer performs correctly for the following points.
 - Printing is performed correctly.
 - None of dot missing is generated.
 - None of blurred print, stain, chipped bar code or characters, wrinkle, smudge, uneven print, etc. is generated.
 - Reading the bar code is possible.

3.5.2 B-EV4D model

1. Refer to section 3.1 to open the top cover.
2. The print head block is secured to the top inner cover with the latches. Push both sides of the bracket and pull the print head block.

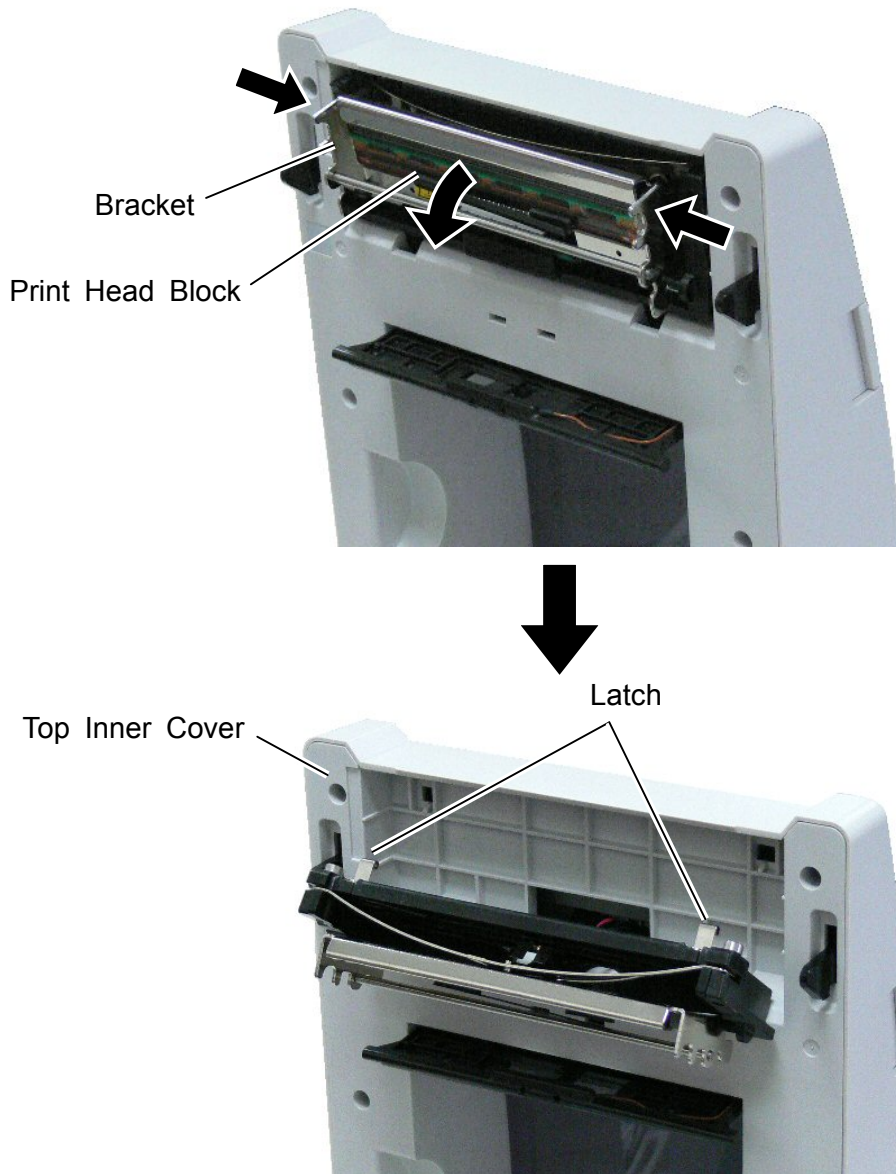

3. Remove the two pins which secure the print head ass'y.

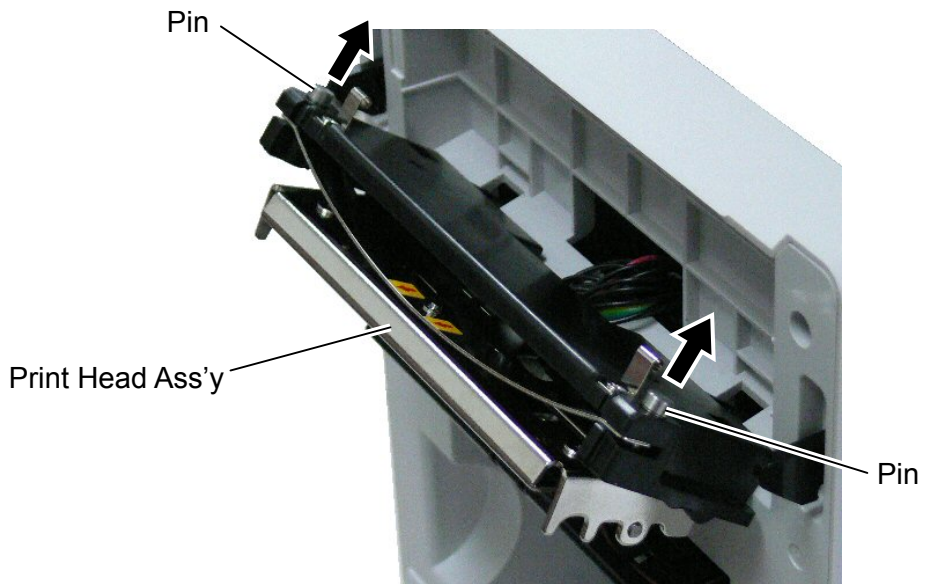

4. Remove the connector from the print head ass'y.

5. Remove the print head ass'y.

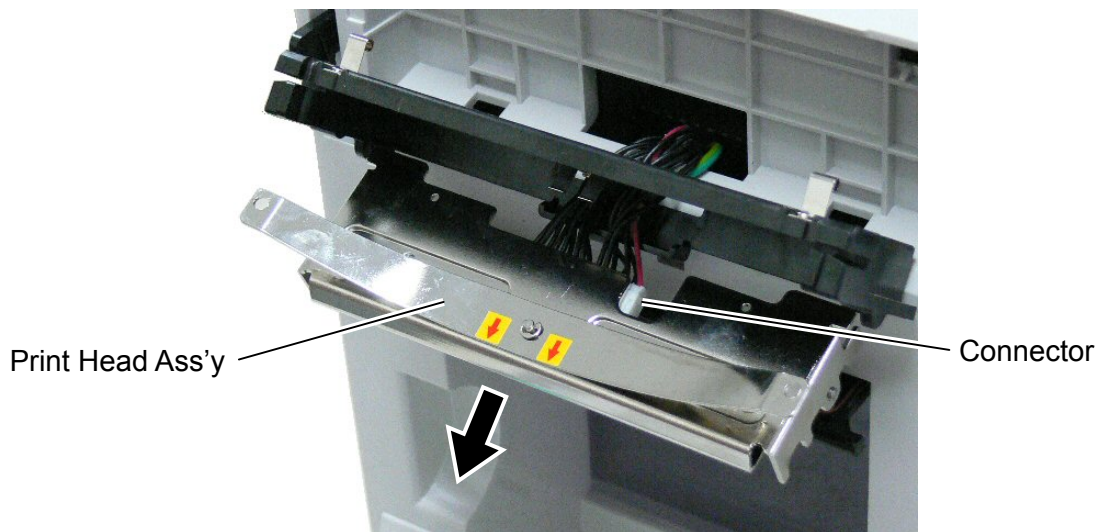

NOTE: Do not bend or damage the spring plates when removing and reassembling the print head ass'y.

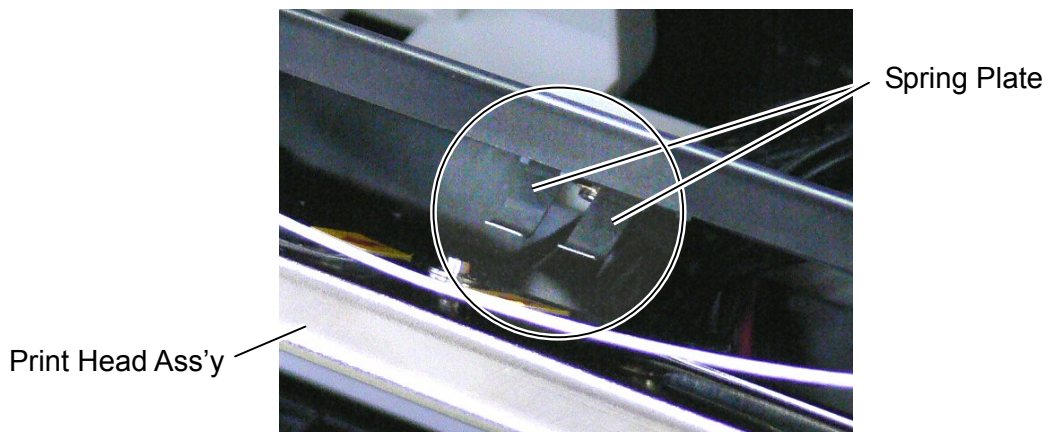

6. Replace the print head ass'y with a new one, then reassemble in the reverse order of removal.

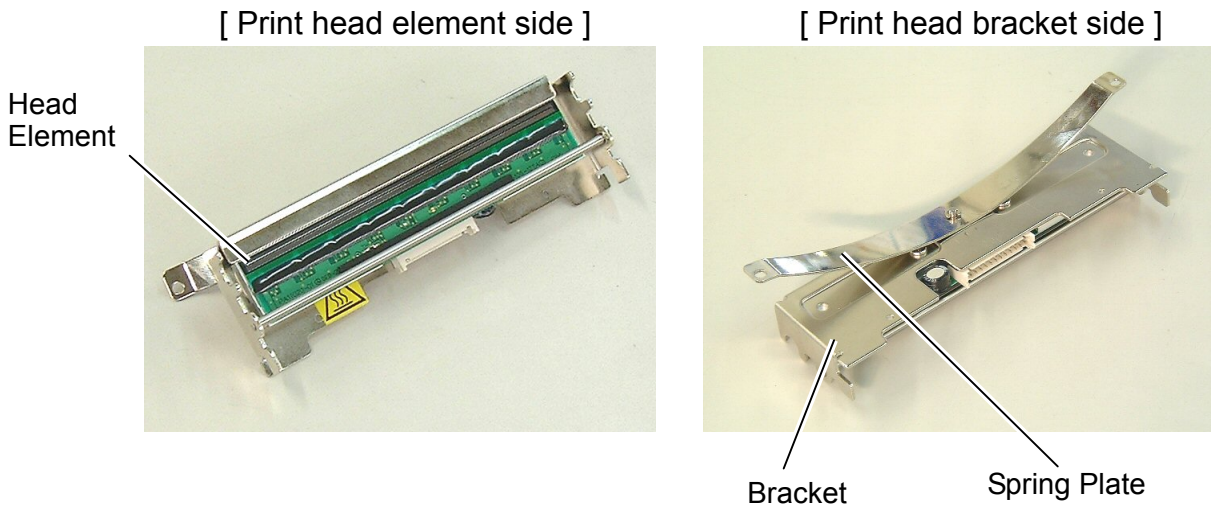

Be careful of the following points when reassembling the print head ass'y. Hook both openings on the bracket to the bosses. It is easy to assemble the bracket by hooking one opening at a time. Also, do not touch or scratch the print head element.

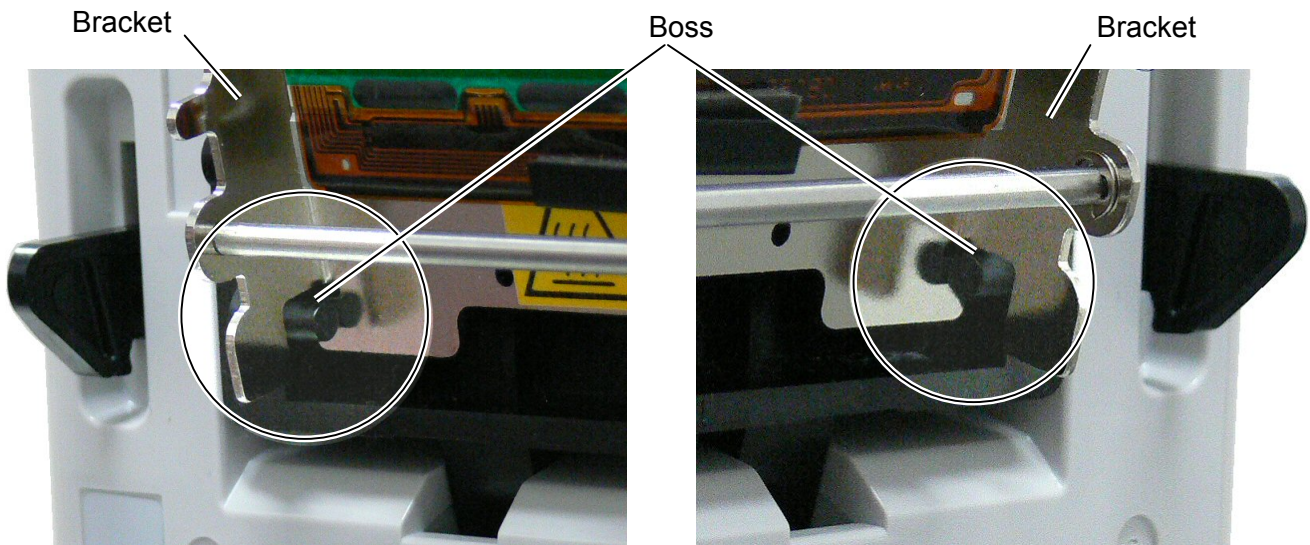

NOTE: Do not disassemble the print head ass'y which contains the bracket and the spring plate.

7. After replacing, perform a diagnostic test print or print a sample label to make sure the printer performs correctly for the following points.
- Printing is performed correctly.
 - None of dot missing is generated.
 - None of blurred print, stain, chipped bar code or characters, wrinkle, smudge, uneven print, etc. is generated.
 - Reading the bar code is possible.

3.6 Replacing the Stepping Motor

1. Refer to section 3.2 to remove the lower cover.
2. Disconnect the stepping motor connector from the main board.
3. Use the Phillips screwdriver to remove the 2 screws.

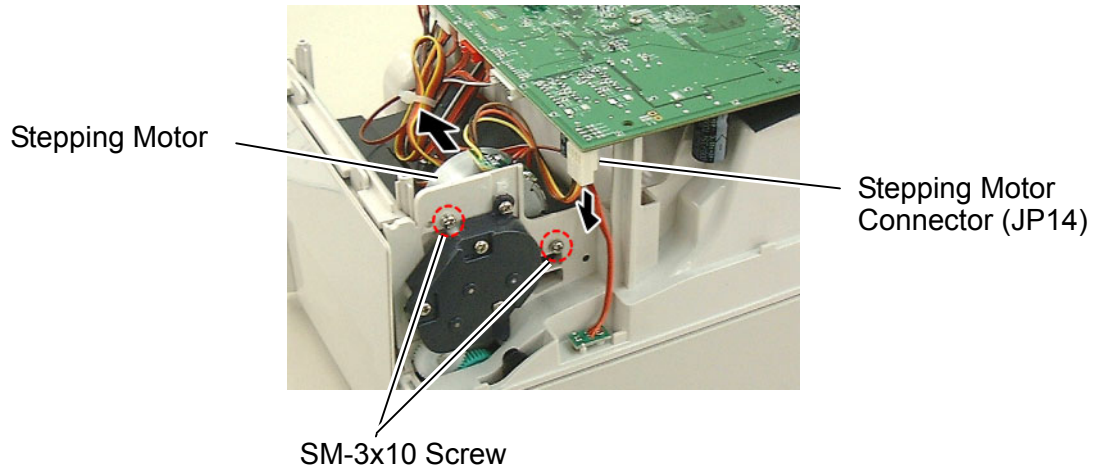

4. Remove the stepping motor. The plastic parts for mounting the stepping motor and thermistor appear.

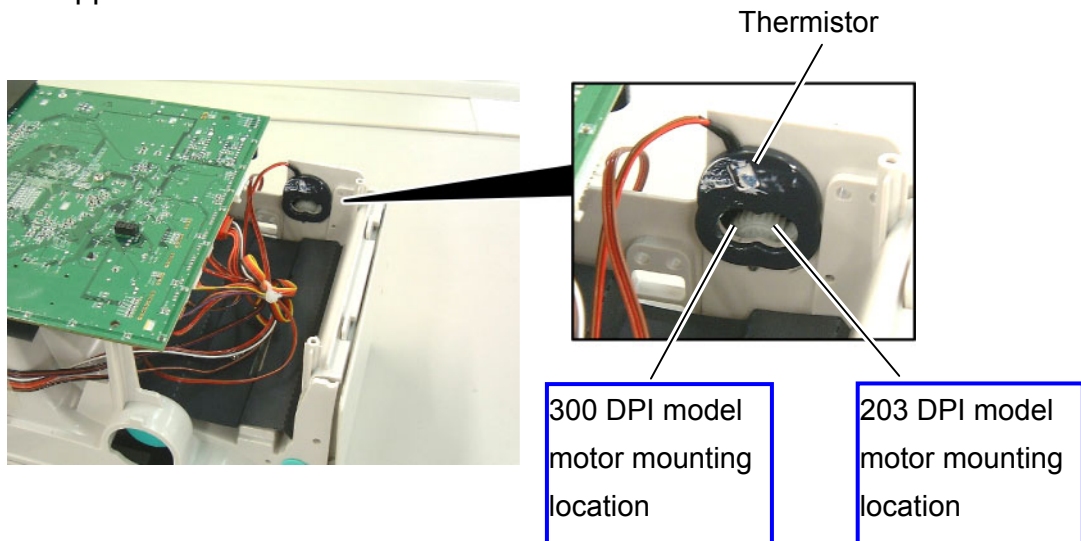

5. Replace the stepping motor with a new one, then reassemble in the reverse order of removal. Be sure to apply FLOIL to the gear when reassembling.

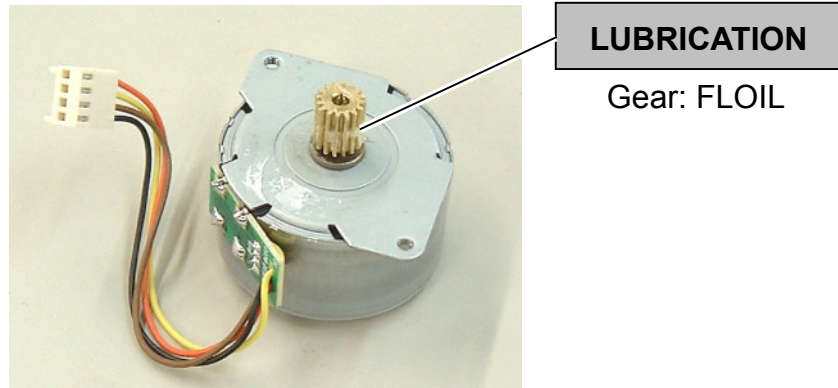

NOTE:

Make sure that the stepping motor is mounted in the correct position and the thermal conductive grease is applied to the thermistor to keep good contact with the stepping motor case.

6. After replacing, perform a diagnostic test print or print a sample label to make sure the printer performs correctly for the following points.
 - Printing is performed correctly.
 - No noise is generated during the print operation.

3.7 Replacing the Gear Cover

1. Refer to section 3.2 to remove the lower cover.
2. Use the Phillips screwdriver to remove the 4 screws.
3. Remove the gear cover.
4. Remove the each gear.

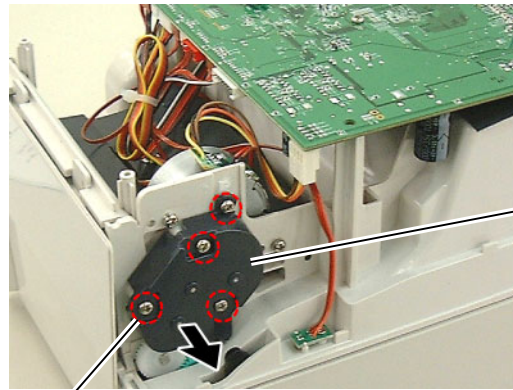

Gear Cover

SM-3x6 Screw

NOTE: Between 200 dpi printer and 300 dpi printer, the number of gears and the position of the motor pulley differ. Be careful of the orientation of the gear when replacing.

300dpi model

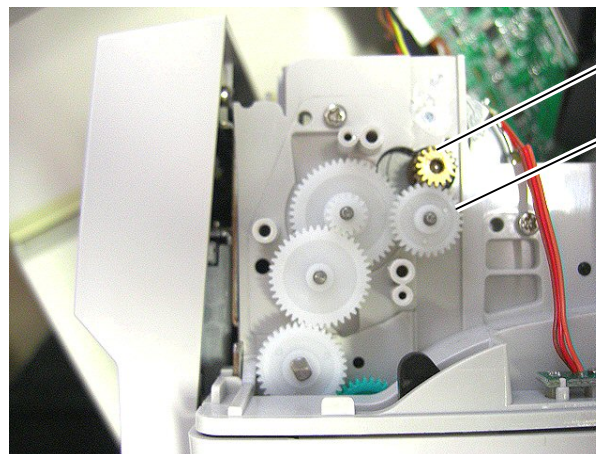

Motor Pulley

LUBRICATION

Gear: FLOIL

200dpi model

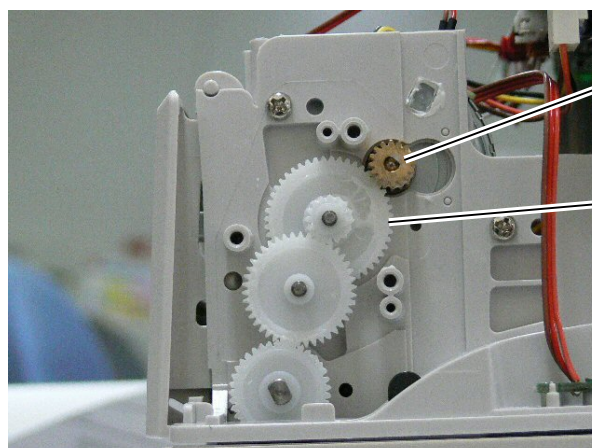

Motor Pulley

LUBRICATION

Gear: FLOIL

5. Replace the gear cover and the each gears with a new one, then reassemble in the reverse order of removal. Be sure to apply FLOIL to the gear when reassembling.

3.8 Replacing the Feed Button PC Board

1. Refer to section 3.1 to remove the top cover.
2. Remove the screws which fix the feed button PC board and the mylar sheet to the mechanism.

B-EV4D model



B-EV4T model

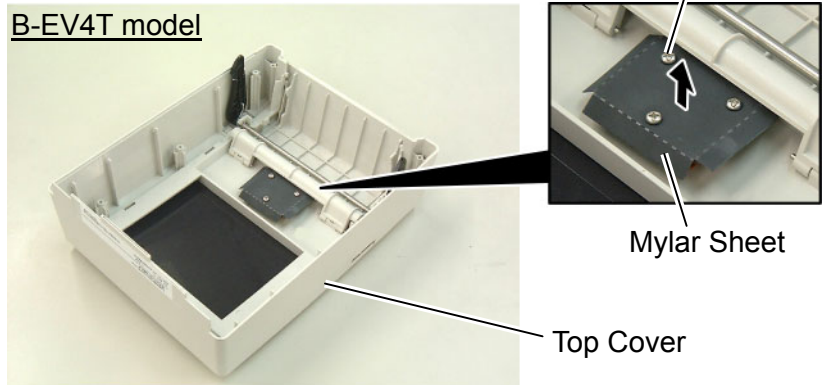

Feed Button PC Board

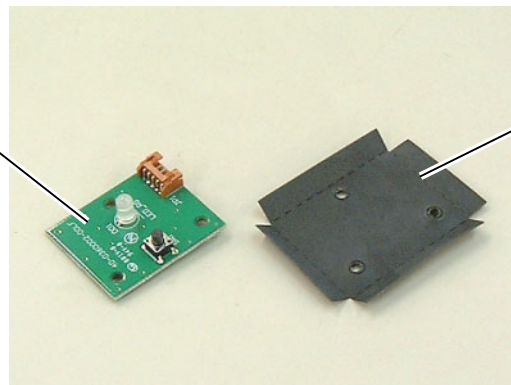

Mylar Sheet

3. Replace the feed button PC board with a new one, then reassemble in the reverse order of removal.

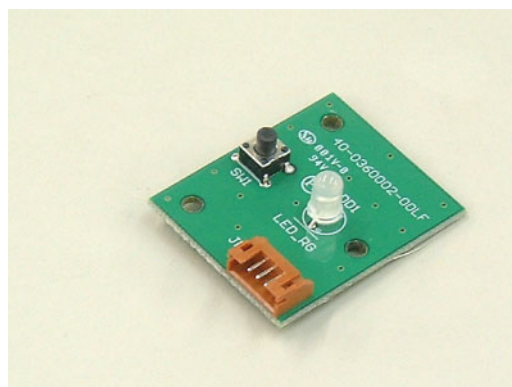

4. After replacing, make sure the printer performs correctly for the following points.
 - When the printer is turned on and then the top cover is opened, the status lamp gets unlit.
 - Next, when the top cover is closed, the status lamp lights up in green.
 - When the **[FEED]** button is pressed during the unloading of a media, the status lamp flashes in red.

3.9 Replacing the Cover Open Sensor

1. Refer to section 3.1 to remove the top cover.
2. Remove the sensor connector from the main PC board.

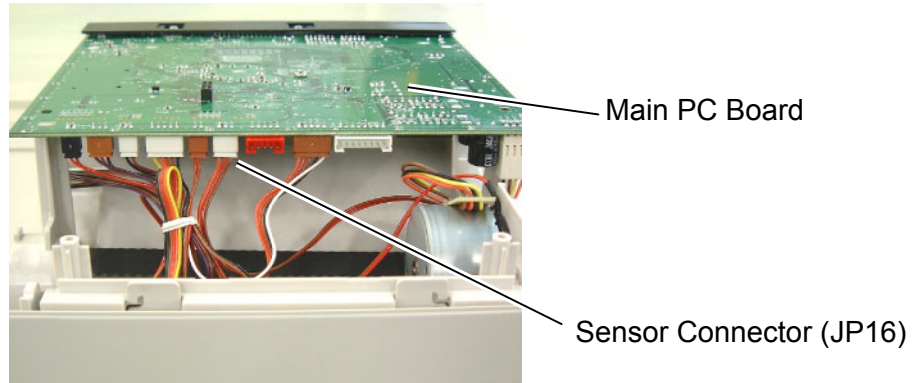

3. Use the Phillips screwdriver to remove the screw from the cover open sensor.

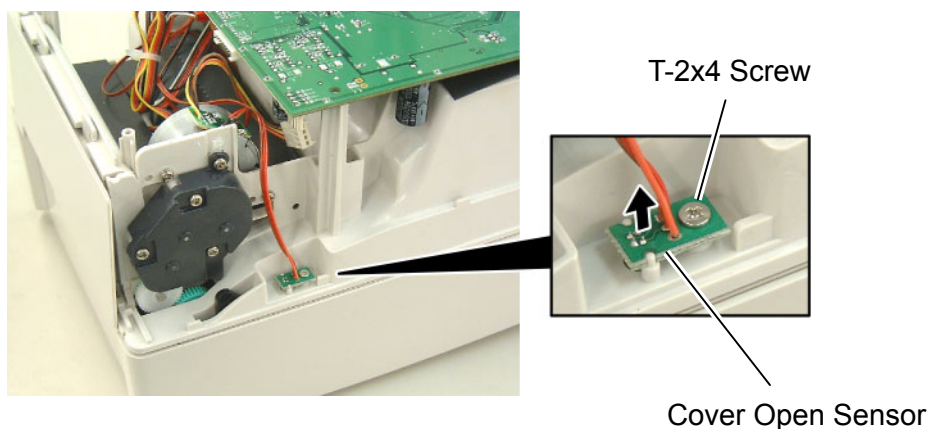

4. Replace the cover open sensor with a new one, then reassemble in the reverse order of removal.

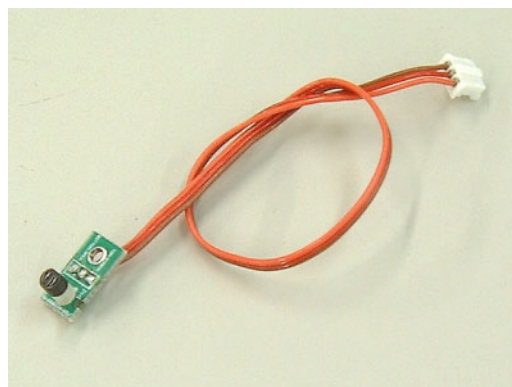

5. After replacing, make sure the printer performs correctly for the following points.
 - When the printer is turned on and then the top cover is opened, the status lamp gets unlit.
 - Next, when the top cover is closed, the status lamp lights up in green.

3.10 Replacing the Ribbon Sensor (B-SV4T model only)

1. Refer to section 3.1 to remove the top cover.
2. Remove the sensor connector from the main PC board.

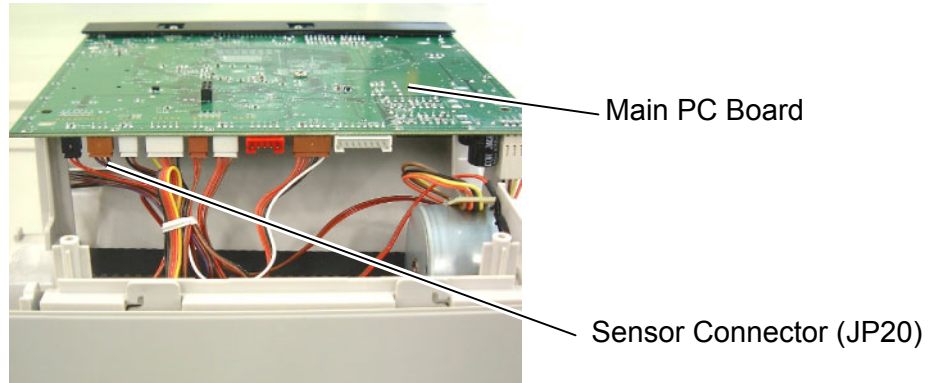

3. Use the Phillips screwdriver to remove the screw from the ribbon sensor.

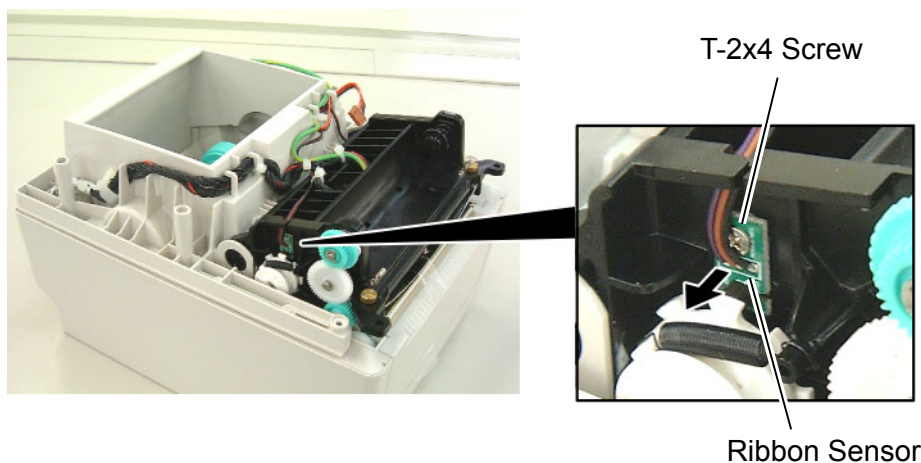

4. Replace the ribbon sensor with a new one, then reassemble in the reverse order of removal.
5. After replacing, make sure the printer performs correctly for the following points.
 - Printing is performed correctly and the ribbon is not slack or wrinkled.
 - When the ribbon is unloaded and the thermal transfer printing is performed, an error occurs. (The ribbon sensor detects the status correctly.)

3.11 Replacing the Black Mark Sensor

1. Refer to section 3.1 to remove the top cover.
2. Remove the sensor connector from the main PC board.
3. Use the Phillips screwdriver to remove the 2 screws from the mylar sheet.
4. Remove the mylar sheet.

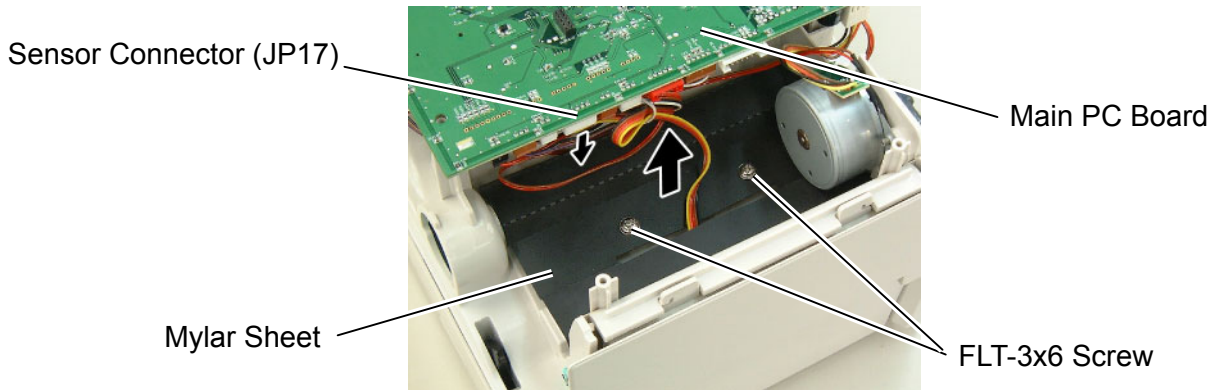

5. Use the Phillips screwdriver to remove the screw from the sensor plate.
6. Remove the sensor plate.

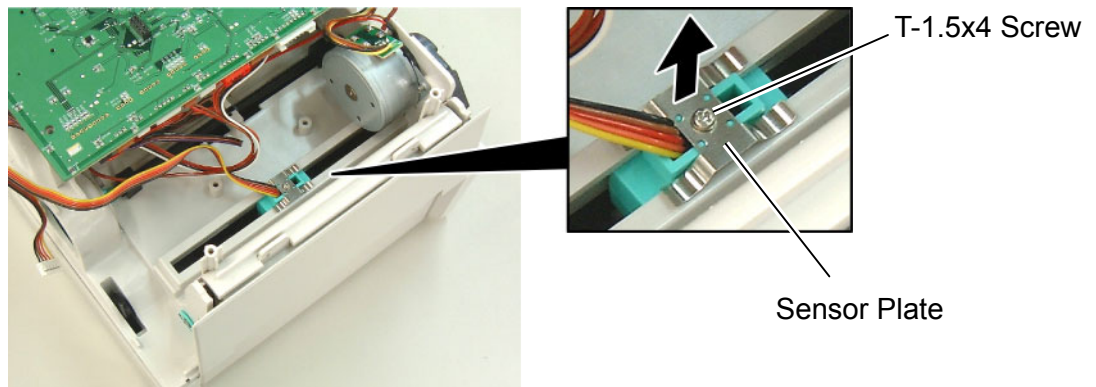

7. Remove the black mark sensor.

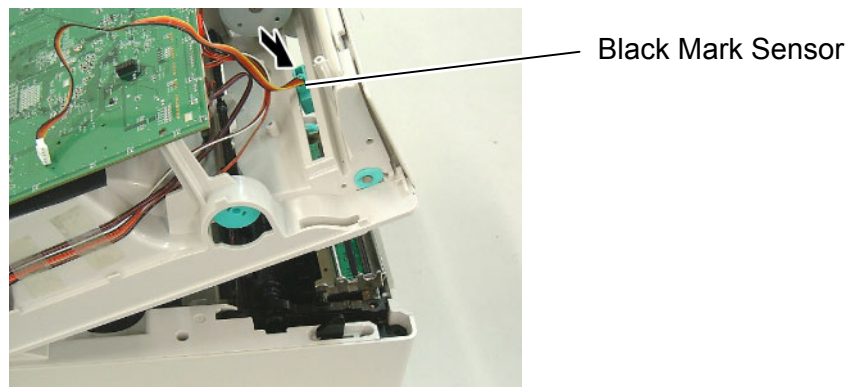

8. Replace the black mark sensor with a new one, then reassemble in the reverse order of removal.



9. After replacing, perform a black mark sensor calibration with the button of the printer or the B-EV4 Setting Tool. Failure to do this may cause a sensor error. Regarding the calibration with the button of the printer, refer to the Owner's Manual. Regarding the calibration with the B-EV4 Setting Tool, refer to the B-EV4 Setting Tool Specification posted on the Barcode Knowledge Pot.
URL of Barcode Knowledge Pot
<http://barcode.toshibatec.co.jp/Ris/products/barcode/support/en/index.php>
10. Also, make sure the black mark sensor performs correctly for the following points.
 - When the PC connected to the printer sends sample data to the printer, printing is performed correctly. (Specify the black mark sensor as the media sensor.)
 - When the **[FEED]** button is pressed during the unloading of a media, the status lamp flashes in red.

3.12 Replacing the Feed Gap Sensor (Lower)

1. Refer to section 3.1 to remove the top cover.
2. Use the Phillips screwdriver to remove the 2 screws from the mylar sheet.
3. Remove the mylar sheet.

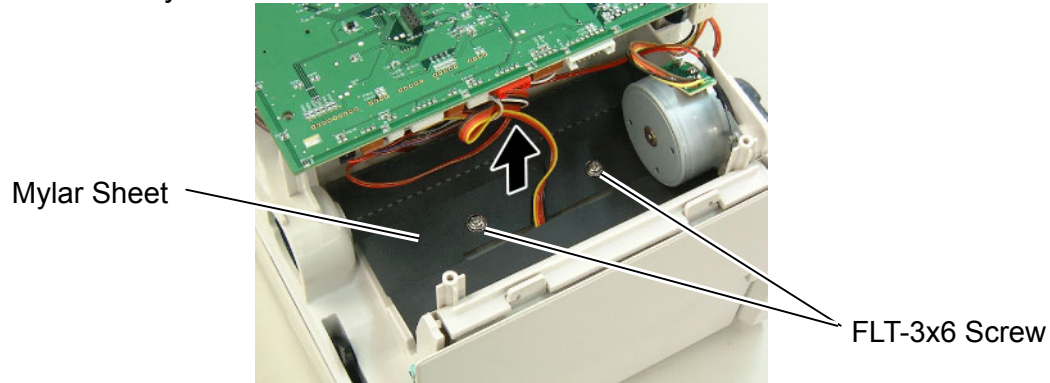

4. Remove the sensor connector from the main PC board.
5. Use the Phillips screwdriver to remove the screw from the sensor plate.
6. Remove the sensor plate.
7. Remove the feed gap sensor (lower).

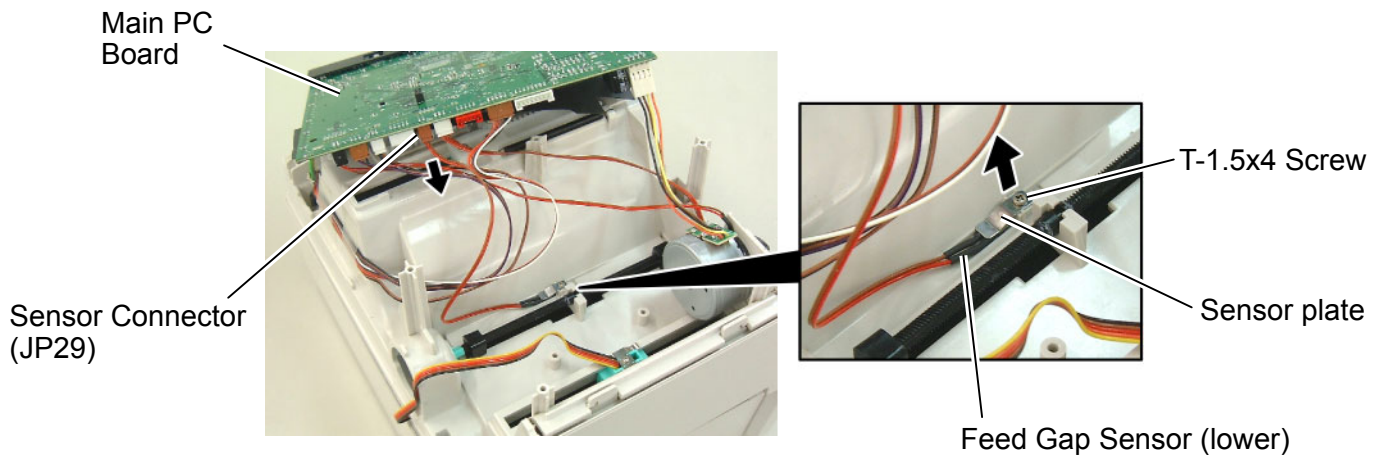

8. Replace the feed gap sensor (lower) with a new one, then reassemble in the reverse order of removal.



9. After replacing, perform a feed gap sensor (lower) calibration with the button of the printer or the B-EV4 Setting Tool. Failure to do this may cause a sensor error. Regarding the calibration with the button of the printer, refer to the Owner's Manual. Regarding the calibration with the B-EV4 Setting Tool, refer to the B-EV4 Setting Tool Specification posted on the Barcode Knowledge Pot.
URL of Barcode Knowledge Pot
<http://barcode.toshibatec.co.jp/Ris/products/barcode/support/en/index.php>
10. Also, make sure the feed gap sensor performs correctly for the following points.
 - When the PC connected to the printer sends sample data to the printer, printing is performed correctly. (Specify the feed gap sensor as the media sensor.)
 - When the **[FEED]** button is pressed during the unloading of a media, the status lamp flashes in red.

3.13 Replacing the Feed Gap Sensor (Upper)

1. Refer to section 3.1 to remove the top cover.
2. Refer to section 3.2 to remove the lower cover.
3. Remove the sensor connector from the main PC board.

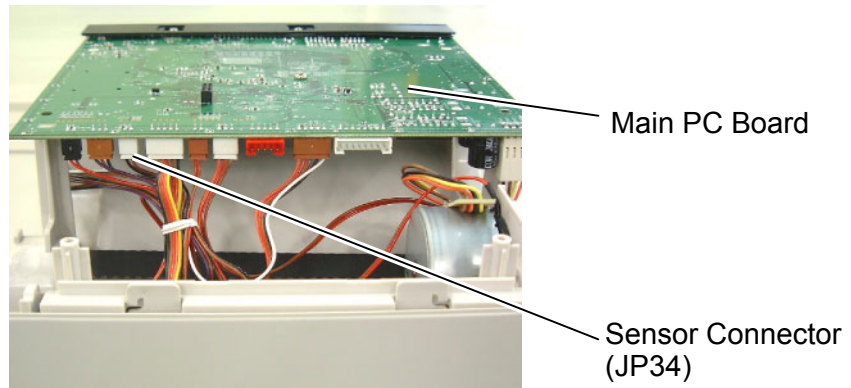

4. Use the Phillips screwdriver to remove the screw from the sensor plate.
5. Remove the sensor plate.

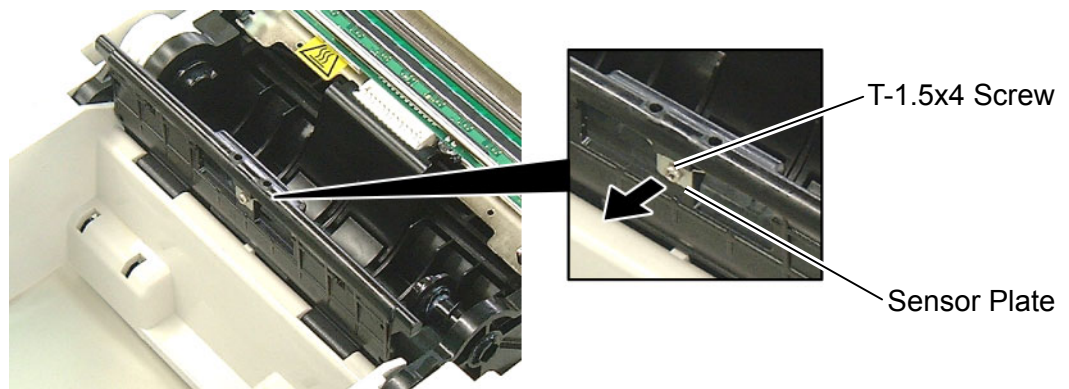

6. Remove the feed gap sensor (upper).

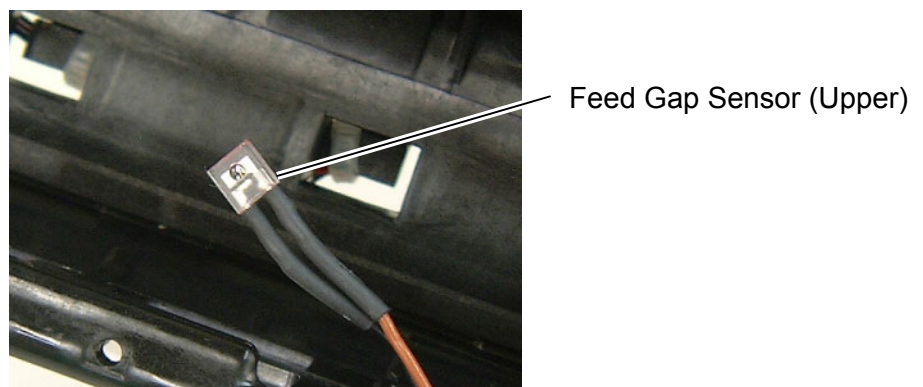

7. Replace feed gap sensor (upper) with a new one, then reassemble in the reverse order of removal.



8. After replacing, perform a feed gap sensor (upper) calibration with the button of the printer or the B-EV4 Setting Tool. Failure to do this may cause a sensor error. Regarding the calibration with the button of the printer, refer to the Owner's Manual. Regarding the calibration with the B-EV4 Setting Tool, refer to the B-EV4 Setting Tool Specification posted on the Barcode Knowledge Pot.
URL of Barcode Knowledge Pot
<http://barcode.toshibatec.co.jp/Ris/products/barcode/support/en/index.php>
9. Also, make sure the feed gap sensor performs correctly for the following points.
 - When the PC connected to the printer sends sample data to the printer, printing is performed correctly. (Specify the feed gap sensor as the media sensor.)
 - When the **[FEED]** button is pressed during the unloading of a media, the status lamp flashes in red.

4. TROUBLESHOOTING

The following guide lists the most common problems that might be encountered when operating this bar code printer. If the printer still does not function after all suggested solutions have been invoked, please contact the Customer Service Department of your purchased reseller or distributor for assistance.

4.1 LED Status

This section lists the common problems that according to the LED status and other problems you may encounter when operating the printer. Also, it provides solutions.

LED Status / Color	Printer Status	Possible Cause	Recovery Procedure
OFF	No response	No power	<ul style="list-style-type: none"> * Turn on the power switch. * Check if the green LED is lit on power supply. If it is not lit on, power supply is broken. * Check both power connections from the power cord to the power supply and from the power supply to the printer power jack if they are connected securely.
Solid Green	ON	The printer is ready to use	* No action necessary.
Green with blinking	Pause	The printer is paused	* Press the FEED button to resume for printing.
Red with blinking	Error	The out of label or ribbon or the printer setting is not correct	<p>Out of label or ribbon</p> <ul style="list-style-type: none"> * Load a roll of label and follow the instructions in loading the media then press the FEED button to resume for printing. * Load a roll of ribbon and follow the instructions in loading the ribbon then press the FEED button to resume for printing.

4.2 Print Quality

Problem	Possible Cause	Recovery Procedure
Not Printing	Check if interface cable is well connected to the interface connector.	Re-connect cable to interface.
	The serial port cable pin configuration is not pin to pin connected.	Please replace the cable with pin to pin connected.
	The serial port setting is not consistent between host and printer.	Please reset the serial port setting.
	The port specified in the Windows driver is not correct.	Select the correct printer port in the driver.
	The Ethernet IP, subnet mask, gateway is not configured properly.	Configure the IP, subnet mask and gateway.
No print on the label	Label or ribbon loaded not correctly.	Follow the instructions in loading the media or loading the ribbon.
	Ribbon run out.	Loading the ribbon.
Continuous feeding labels	The printer setting may go wrong.	Please do the initialization and gap/black mark calibration.
Paper Jam	Gap/black mark sensor sensitivity is not set properly (sensor sensitivity is not enough)	Calibrate the gap/black mark sensor.
	Make sure label size is set properly.	Set label size exactly as installed paper in the labeling software or program.
	Labels may be stuck inside the printer mechanism near the sensor area.	Remove the stuck label.
Poor Print Quality	Top cover is not closed properly.	Close the top cover completely and make sure the right side and left side levers are latched properly
	Check if supply is loaded correctly.	Reload the supply.
	Ribbon and media are incompatible.	Change the ribbon or label combination.
	Check if dust or adhesives are accumulated on the print head.	Clean the print head.
	Check if print density is set properly.	Adjust the print density and print speed.
	Check print head test pattern if head element is damaged.	Run printer self-test and check the print head test pattern if there is dot missing in the pattern.

5. MAINTENANCE

WARNING!

DO NOT USE a spray cleaner containing flammable gas for cleaning this product, as this may cause a fire.

This section presents the clean tools and methods to maintain your printer.

1. Please use one of following material to clean the printer.

- Cotton swab (Head cleaner pen)
- Lint-free cloth
- Vacuum / Blower brush
- 100% ethanol

2. The cleaning process is described as following

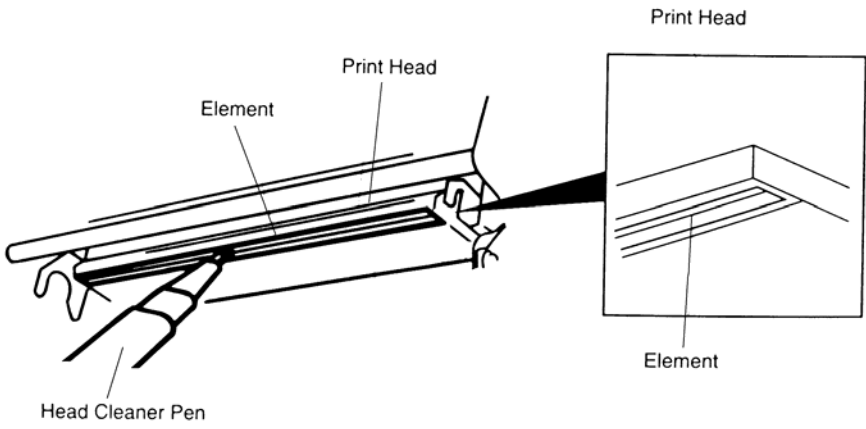
Printer Part	Method	Interval
Print Head	<ol style="list-style-type: none"> 1. Always turn off the printer before cleaning the print head. 2. Allow the print head to cool for a minimum of one minute. 3. Use a cotton swab (Head cleaner pen) and 100% ethanol to clean the print head surface. 	Clean the print head when changing a new label roll.
		
Platen Roller	<ol style="list-style-type: none"> 1. Turn the power off. 2. Rotate the platen roller and wipe it thoroughly with 100% ethanol and a cotton swab, or lint-free cloth. 	Clean the platen roller when changing a new label roll.
Tear Bar/Peel Bar	Use the lint-free cloth with 100% ethanol to wipe it.	As needed
Sensor	Compressed air or vacuum	Monthly
Exterior	Wipe it with water-dampened cloth	As needed
Interior	Brush or vacuum	As needed

Notes:

1. *Do not touch printer head by hand. If you touch it careless, please use ethanol to clean it.*
2. *Please use 100% Ethenol. DO NOT use medical alcohol, which may damage the printer head.*
3. *Regularly clean the print head and supply sensors once change a new ribbon to keep printer performance and extend printer life.*
4. *Continuous printing will cause printer motor overheat. Printer will stop printing automatically about 10~15 minutes until motor is cooling down. Please don't turn off power when printer pauses or the data transfered to printer buffer will be lost.*
5. *The maximum printing ratio per dot line is 15% for this printer. To print the full web black line, the maximum black line height is limited to 40 dots, which is 5mm for 203 DPI resolution printer and 3.3mm for 300 DPI resolution printer.*

6. SYSTEM MODE

When the **[FEED]** button is held and the B-EV4 series is turned on, the printer is ready to start the system mode. As the STATUS lamp turns in the following order every 1.5 seconds, release the **[FEED]** button while the STATUS lamp indicates your desired mode to go into it.

Note: To go into the firmware download mode, release the **[FEED]** button and then immediately press it again.

- (1) Lights in green then blinks in green: System Mode Start
- (2) Blinks in red: Firmware Download Mode
- (3) Blinks in orange: Abort of Label Format Auto Call
- (4) Lights in orange: Parameter Clear
- (5) Lights in red: Sensor Adjustment
- (6) Lights in green: Diagnostic Test Print/DUMP Mode

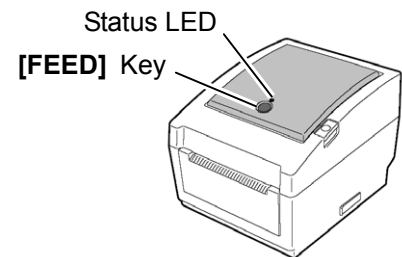

6.1 FIRMWARE DOWNLOAD

CAUTION: Do not turn off the PC and the printer while the firmware downloading is being performed.

For the firmware version V1.0D and greater, it is possible to perform an auto download with the SD card. For the download procedure and recommended SD card, refer to the Firmware Downloading Procedure and the Recommended SD Card List which are posted on the Barcode Knowledge Pot.

(URL: <http://barcode.toshibatec.co.jp/Ris/products/barcode/support/en/index.php>)

B-EV4D Series

B-EV4T Series

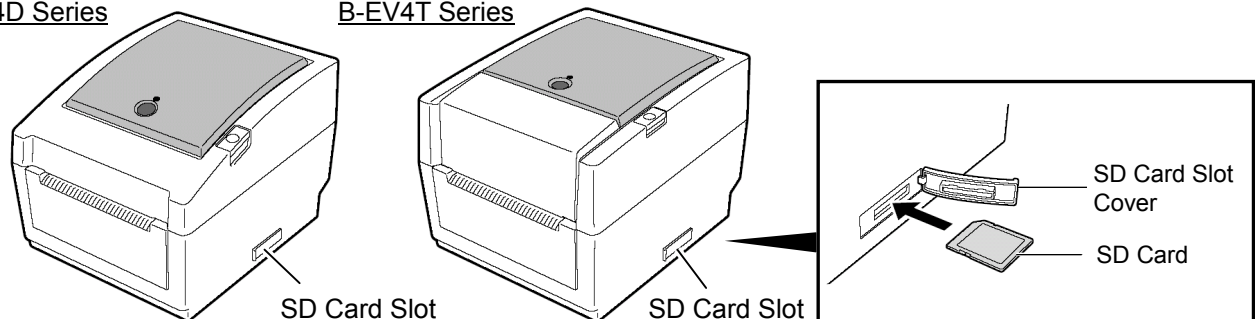

For the firmware version V1.0C or less, follow the procedures below.

1. Copy the firmware file onto the drive C of the PC.
2. Connect the PC and the printer via the parallel interface.
3. Hold the **[FEED]** button and turn on the printer to go into the system mode.
4. While the STATUS lamp blinks in red, release the **[FEED]** button and then immediately press it again to go into the download mode.
5. Place the PC into MS DOS Prompt mode, and then type in the following command to copy the firmware file, which was copied onto the drive C, onto the parallel port.

```
C:\ >COPY xxxxxx.xxx /B LPT1
```

└── Firmware File Name

6. The STATUS lamp lights in green and then blinks in orange and red every one second.

When the firmware downloading is successfully completed, the printer resets automatically. Now the firmware downloading is terminated.

6.2 ABORT OF LABEL FORMAT AUTO CALL

When the STATUS lamp blinks in orange during the system mode, releasing the **[FEED]** button aborts a label format auto call.

6.3 PARAMETER CLEAR

When the STATUS lamp lights in orange during the system mode, releasing the **[FEED]** button performs a Parameter Clear.

Parameter	Initial Setting
TONE ADJUST	+00
FEED ADJUST	+0.0mm
CUT POSITION ADJUST	+0.0mm
BACKFEED ADJUST	+0.0mm
Character Code	PC-850
Zero Font	0 (without slash)
Baud Rate	9600 bps
Data Length	8 bits
Stop Bit	1 bit
Parity	None
Flow Control Code	XON/XOFF + READY / BUSY (DTR) method
Control Code	Auto
[FEED] Key Function	FEED
Euro Font Code	B0H
X axis Fine Adjustment	0mm
Sensor Selection	Feed Gap Sensor
Print Speed	203dpi model: 5inch/sec. 300dpi model: 3inch/sec.
IP Address	192.168.010.020
Subnet Mask	255.255.255.000
Gateway	000.000.000.000
DHCP	Disable
DHCP Client ID	FFFFFFFFFFFFFFFFFFFFFFFFFFFFFFFF
Socket COMM.	Enabled
Socket COMM. Port	08000

6.4 SENSOR ADJUSTMENT

Adjust the sensor to the proper position and set the label or tag paper.

When the STATUS lamp lights in red during the system mode, releasing the **[FEED]** button performs an auto sensor adjustment and measurement of the label length.

For the details of the sensor adjustment, refer to the Owner's Manual.

6.5 DIAGNOSTIC TEST PRINT/DUMP MODE

When the STATUS lamp lights in green during the system mode, releasing the **[FEED]** button makes a Diagnostic Test Print and the printer goes into the dump mode.

Test Print Sample

PRINTER INFO.		
PROGRAM VERSION	V1.0C	0A9D
TONE ADJUST	+00	
FEED ADJUST	+0.0mm	
CUT POSITION ADJUST	+0.0mm	
BACKFEED ADJUST	+0.0mm	
PARAMETER	[PC-850] [0]	
	[9600] [8] [1] [NONE] [2]	
	[ON] [AUTO] [FEED] [B0]	
X-COORDINATE ADJUST	+0.0mm	
SENSOR SELECTION	TRANSMISSIVE	
SENSOR ADJ. VALUE	TRANSMISSIVE [19]	REFLECTIVE [47]
PRINT SPEED	5 IPS	
FLASH ROM	4 MB	
SDRAM	8 MB	
USER MEMORY	[704 KB] [0 KB]	
TTF AREA	[0 KB] [0 KB]	
EXT CHAR AREA	[0 KB] [0 KB]	
BASIC AREA	[0 KB] [0 KB]	
PC SAVE AREA	[704 KB] [0 KB]	
INFORMATION	B-EV4-Gx-QM	0000000001
TOTAL FEED	0.0 km	
TOTAL PRINT	0.0 km	
TOTAL CUT	0	
IP ADDRESS	192.168.10.20	
SUBNET MASK	255.255.255.0	
GATEWAY	0.0.0.0	
MAC ADDRESS	00-1B-82-FF-0C-E8	
DHCP	Disabled	
DHCP CLIENT ID	FFFFFFFFFFFFFFFFFFFF	
	FFFFFFFFFFFFFF	
SOCKET COMM.	Enabled	
SOCKET COMM. PORT	8000	

TOSHIBA TEC CORPORATION  PRINTED IN JAPAN
EO18-33025

Free Manuals Download Website

<http://myh66.com>

<http://usermanuals.us>

<http://www.somanuals.com>

<http://www.4manuals.cc>

<http://www.manual-lib.com>

<http://www.404manual.com>

<http://www.luxmanual.com>

<http://aubethermostatmanual.com>

Golf course search by state

<http://golfingnear.com>

Email search by domain

<http://emailbydomain.com>

Auto manuals search

<http://auto.somanuals.com>

TV manuals search

<http://tv.somanuals.com>