

TOSHIBA

TOSHIBA Barcode Printer

B-EX4T1 SERIES

Owner's Manual
Mode d'emploi
Bedienungsanleitung
Manual de instrucciones
Gebruikershandleiding
Manuale Utente
Manual do Utilizador



CE Compliance (for EU only)

This product complies with the requirements of EMC and Low Voltage Directives including their amendments.

VORSICHT:

- *Schallemission: unter 70dB (A) nach DIN 45635 (oder ISO 7779)*
- *Die für das Gerät Vorgesehene Steckdose muß in der Nähe des Gerätes und leicht zugänglich sein.*

Centronics is a registered trademark of Centronics Data Computer Corp.
Microsoft is a registered trademark of Microsoft Corporation.
Windows is a trademark of Microsoft Corporation.

This equipment has been tested and found to comply with the limits for a Class A digital device, pursuant to Part 15 of the FCC Rules. These limits are designed to provide reasonable protection against harmful interference when the equipment is operated in a commercial environment. This equipment generates, uses, and can radiate radio frequency energy and, if not installed and used in accordance with the instruction manual, may cause harmful interference to radio communications. Operations of this equipment in a residential area is likely to cause harmful interference in which case the user will be required to correct the interference at his own expense.

(for USA only)

Changes or modifications not expressly approved by manufacturer for compliance could void the user's authority to operate the equipment.

"This Class A digital apparatus meets all requirements of the Canadian Interference-Causing Equipment Regulations."

"Cet appareil numérique de la classe A respecte toutes les exigences du Règlement sur le matériel brouilleur du Canada."

(for CANADA only)



N258

IP20

< For EU Only >

TOSHIBA TEC Europe Retail Information Systems S.A.
Rue de la Célidée 33 BE-1080 Brussels

Copyright © 2011
by TOSHIBA TEC CORPORATION
All Rights Reserved
570 Ohito, Izunokuni-shi, Shizuoka-ken, JAPAN

TOSHIBA

TOSHIBA Barcode Printer

B-EX4T1 SERIES

Owner's Manual

Waste Recycling information for users:

Following information is only for EU-member states:

The use of the crossed-out wheeled bin symbol indicates that this product may not be treated as general household waste.

By ensuring this product is disposed of correctly you will help prevent potential negative consequences for the environment and human health, which could otherwise be caused by inappropriate waste handling of this product. For more detailed information about the take-back and recycling of this product, please contact your supplier where you purchased the product.



Precautions for Handling of Wireless Communication Devices

Wireless LAN Module: SD-Link 11g

RFID Module: TEC-RFID-EU1 (B-EX700-RFID-H1-QM-R), TRW-USM-01 (B-EX700-RFID-U2-US-R), TRW-EUM-01 (B-EX700-RFID-U2-EU-R), TRW-CNM-01 (B-EX700-RFID-U2-CN-R)

For Europe

This device was tested and certified by Notified Body.

Hereby, Toshiba TEC Corporation, declares that this device is in compliance with the essential requirements and other relevant provisions of Directive 1999/5/EC.

This equipment uses the radio frequency band which has not been harmonized throughout all EU and EFTA countries, and can be used in the following countries.

Austria, Belgium, Bulgaria, Cyprus, Czech Republic, Denmark, Estonia, Finland, France, Hungary, Germany, Greece, Ireland, Italy, Latvia, Lithuania, Luxembourg, Malta, Netherlands, Poland, Portugal, Romania, Slovakia, Slovenia, Spain, Sweden, United Kingdom, Norway, Liechtenstein, Iceland, Switzerland

For USA

This device complies with Part 15 of the FCC Rules.

Operation is subject to the following two conditions:

- (1) this device may not cause harmful interference, and
- (2) this device must accept any interference received, including interference that may cause undesired operation.

Changes or modification not expressly approved by manufacturer for compliance could void the user's authority to operate the equipment.

For Canada

Operation is subject to the following two conditions:

- (1) this device may not cause interference, and
- (2) this device must accept any interference, including interference that may cause undesired operation of the device.

For Taiwan

Caution

根據低功率電波輻射性電機管理辦法

For safety

Do not use this product in locations where use may be forbidden, for example, in an aeroplane or a hospital. If you do not know the forbidden areas, please refer to and follow the airline company or medical institution guidelines.

Otherwise, flight instrument or medical equipment may be affected, causing a serious accident.

This product may affect the operation of some implanted cardiac pacemakers and other medically implanted equipment. Pace maker patients should be aware that the use of this product very close to a pacemaker might cause the device to malfunction.

If you have any reason to suspect that interference is taking place, immediately turn off the product and contact your TOSHIBA TEC sales agent.

Do not disassemble, modify, or repair the product.

Doing so may cause injury. Also, modification is against the Laws and Regulations for Radio Equipment. Please ask your TOSHIBA TEC sales agent for repair.

Safety Summary

Personal safety in handling or maintaining the equipment is extremely important. Warnings and Cautions necessary for safe handling are included in this manual. All warnings and cautions contained in this manual should be read and understood before handling or maintaining the equipment.

Do not attempt to effect repairs or modifications to this equipment. If a fault occurs that cannot be rectified using the procedures described in this manual, turn off the power, unplug the machine, then contact your authorised TOSHIBA TEC representative for assistance.

Meanings of Each Symbol



This symbol indicates warning items (including cautions). Specific warning contents are drawn inside the Δ symbol. (The symbol on the left indicates a general caution.)



This symbol indicates prohibited actions (prohibited items). Specific prohibited contents are drawn inside or near the \odot symbol. (The symbol on the left indicates “no disassembling”.)



This symbol indicates actions which must be performed. Specific instructions are drawn inside or near the \bullet symbol. (The symbol on the left indicates “disconnect the power cord plug from the outlet”.)



WARNING

This indicates that there is the risk of **death** or **serious injury** if the machines are improperly handled contrary to this indication.



Any other than the specified AC voltage is prohibited.

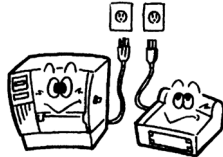

Do not use voltages other than the voltage (AC) specified on the rating plate, as this may cause **fire** or **electric shock**.



Prohibited

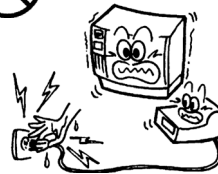

Do not plug in or unplug the power cord plug with wet hands as this may cause **electric shock**.



Prohibited



If the machines share the same outlet with any other electrical appliances that consume large amounts of power, the voltage will fluctuate widely each time these appliances operate. Be sure to provide an exclusive outlet for the machine as this may cause **fire** or **electric shock**.



Prohibited



Do not place metal objects or water-filled containers such as flower vases, flower pots or mugs, etc. on top of the machines. If metal objects or spilled liquid enter the machines, this may cause **fire** or **electric shock**.



Prohibited

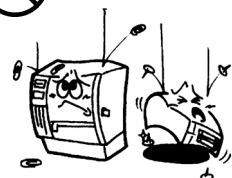

Do not insert or drop metal, flammable or other foreign objects into the machines through the ventilation slits, as this may cause **fire** or **electric shock**.



Prohibited



Do not scratch, damage or modify the power cords. Also, do not place heavy objects on, pull on, or excessively bend the cords, as this may cause **fire** or **electrical shock**.



Disconnect the plug.

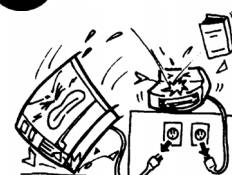











If the machines are dropped or their cabinets damaged, first turn off the power switches and disconnect the power cord plugs from the outlet, and then contact your authorised TOSHIBA TEC representative for assistance. Continued use of the machine in that condition may cause **fire** or **electric shock**.

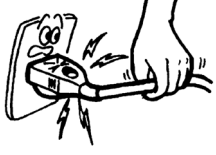

Disconnect the plug.

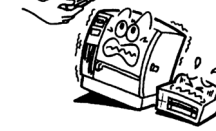

Continued use of the machines in an abnormal condition such as when the machines are producing smoke or strange smells may cause **fire** or **electric shock**. In these cases, immediately turn off the power switches and disconnect the power cord plugs from the outlet. Then, contact your authorised TOSHIBA TEC representative for assistance.

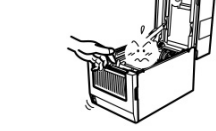
 <p>Disconnect the plug.</p> 	<p>If foreign objects (metal fragments, water, liquids) enter the machines, first turn off the power switches and disconnect the power cord plugs from the outlet, and then contact your authorised TOSHIBA TEC representative for assistance. Continued use of the machine in that condition may cause fire or electric shock.</p>	 <p>Disconnect the plug.</p> 	<p>When unplugging the power cords, be sure to hold and pull on the plug portion. Pulling on the cord portion may cut or expose the internal wires and cause fire or electric shock.</p>
 <p>Connect a grounding wire.</p> 	<p>Ensure that the equipment is properly grounded. Extension cables should also be grounded. Fire or electric shock could occur on improperly grounded equipment.</p>	 <p>No disassembling.</p> 	<p>Do not remove covers, repair or modify the machine by yourself. You may be injured by high voltage, very hot parts or sharp edges inside the machine.</p>
 <p>Prohibited</p> 	<p>Do not use a spray cleaner containing flammable gas for cleaning this product, as this may cause a fire.</p>	 <p>Prohibited</p> 	<p>Care must be taken not to injure yourself with the printer paper cutter.</p>



CAUTION

This indicates that there is the risk of personal **injury** or **damage** to objects if the machines are improperly handled contrary to this indication.

Precautions

The following precautions will help to ensure that this machine will continue to function correctly.

- Try to avoid locations that have the following adverse conditions:
 - * Temperatures out of the specification
 - * Shared power source
- * Direct sunlight
- * Excessive vibration
- * High humidity
- * Dust/Gas
- The cover should be cleaned by wiping with a dry cloth or a cloth slightly dampened with a mild detergent solution. NEVER USE THINNER OR ANY OTHER VOLATILE SOLVENT on the plastic covers.
- USE ONLY TOSHIBA TEC SPECIFIED paper and ribbons.
- DO NOT STORE the paper or ribbons where they might be exposed to direct sunlight, high temperatures, high humidity, dust, or gas.
- Ensure the printer is operated on a level surface.
- Any data stored in the memory of the printer could be lost during a printer fault.
- Try to avoid using this equipment on the same power supply as high voltage equipment or equipment likely to cause mains interference.
- Unplug the machine whenever you are working inside it or cleaning it.
- Keep your work environment static free.
- Do not place heavy objects on top of the machines, as these items may become unbalanced and fall causing **injury**.
- Do not block the ventilation slits of the machines, as this will cause heat to build up inside the machines and may cause **fire**.
- Do not lean against the machine. It may fall on you and could cause **injury**.
- Unplug the machine when it is not used for a long period of time.
- Place the machine on a stable and level surface.

Request Regarding Maintenance

- Utilize our maintenance services.
After purchasing the machine, contact your authorised TOSHIBA TEC representative for assistance once a year to have the inside of the machine cleaned. Otherwise, dust will build up inside the machines and may cause a **fire** or a **malfunction**. Cleaning is particularly effective before humid rainy seasons.
- Our preventive maintenance service performs the periodic checks and other work required to maintain the quality and performance of the machines, preventing accidents beforehand.
For details, please consult your authorised TOSHIBA TEC representative for assistance.
- Using insecticides and other chemicals
Do not expose the machines to insecticides or other volatile solvents. This will cause the cabinet or other parts to deteriorate or cause the paint to peel.

TABLE OF CONTENTS

	Page
1. PRODUCT OVERVIEW.....	E1- 1
1.1 Introduction.....	E1- 1
1.2 Features	E1- 1
1.3 Unpacking.....	E1- 1
1.4 Accessories	E1- 2
1.5 Appearance	E1- 3
1.5.1 Dimensions.....	E1- 3
1.5.2 Front View	E1- 3
1.5.3 Rear View.....	E1- 3
1.5.4 Operation Panel	E1- 4
1.5.5 Interior	E1- 4
1.6 Options	E1- 5
2. PRINTER SETUP	E2- 1
2.1 Installation	E2- 2
2.2 Connecting the Power Cord	E2- 3
2.3 Loading Supplies	E2- 4
2.3.1 Loading the Media.....	E2- 5
2.3.2 Loading the Ribbon	E2-10
2.4 Connecting the Cables to Your Printer	E2-12
2.5 Turning the Printer ON/OFF	E2-13
2.5.1 Turning ON the Printer	E2-13
2.5.2 Turning OFF the Printer.....	E2-13
2.6 Printer Setting.....	E2-14
2.6.1 User System Mode.....	E2-15
2.6.2 Parameter Setting	E2-16
2.6.3 Enabling LAN/WLAN	E2-24
2.6.4 Basic Program Setting.....	E2-24
2.6.5 Enabling Z-Mode	E2-25
2.6.6 Automatic Calibration	E2-26
2.6.7 Dump Mode Setting.....	E2-27
2.6.8 Logging.....	E2-29
2.6.9 System Mode	E2-30
2.6.10 Interface Setting	E2-31
2.6.11 Real Time Clock (RTC)	E2-38
2.6.12 Copying Data to/from USB Memory	E2-39
2.7 Installing the Printer Drivers	E2-40
2.7.1 Introduction.....	E2-40
2.7.2 General Description.....	E2-40
2.7.3 Installing the Printer Driver	E2-40
2.7.4 Preparation for installation.....	E2-41
2.7.5 Installation under Windows2000/XP/Server2003	E2-43
2.7.6 Installation under WindowsVista/Server2008/7/Server2008R2	E2-48
2.7.7 Installation under Windows2000 (USB with Plug & Play enabled)	E2-51
2.7.8 Installation under WindowsXP/Server2003 (USB with Plug & Play enabled)	E2-53
2.7.9 Installation under Windows Vista/Server2008/7/Server2008R2 (USB with Plug & Play enabled).....	E2-54
2.7.10 Uninstallation the Printer Driver.....	E2-55
2.8 Print Test	E2-58

2.9	Position and Print Tone Fine Adjustment	E2-60
2.9.1	Fine Adjustment	E2-60
2.10	Threshold Setting	E2-67
2.11	Sensor Setting	E2-69
3.	ON LINE MODE.....	E3- 1
3.1	Key Functions	E3- 1
3.2	LCD	E3- 2
3.2	Operation Example.....	E3- 3
4.	MAINTENANCE	E4- 1
4.1	Cleaning	E4- 1
4.1.1	Print Head/Platen/Sensors	E4- 1
4.1.2	Covers and Panels	E4- 2
4.1.3	Optional Cutter Module.....	E4- 3
5.	TROUBLESHOOTING	E5- 1
5.1	Error Messages	E5- 1
5.2	Possible Problems.....	E5- 4
5.3	Removing Jammed Media.....	E5- 5
6.	PRINTER SPECIFICATIONS	E6- 1
7.	SUPPLY SPECIFICATIONS	E7- 1
7.1	Media.....	E7- 1
7.1.1	Media Type.....	E7- 1
7.1.2	Detection Area of the Transmissive Sensor	E7- 3
7.1.3	Detection Area of the Reflective Sensor.....	E7- 4
7.1.4	Effective Print Area.....	E7- 4
7.1.5	RFID Tags	E7- 5
7.2	Ribbon	E7- 7
7.3	Recommended Media and Ribbon Types	E7- 7
7.4	Care/Handling of Media and Ribbon	E7- 8
APPENDIX 1 MESSAGES AND LEDS.....		EA1-1
APPENDIX 2 INTERFACE.....		EA2-1
APPENDIX 3 PRINT SAMPLES		EA3-1
APPENDIX 4 GLOSSARIES		EA4-1

WARNING!

This is a Class A product. In a domestic environment this product may cause radio interference in which case the user may be required to take adequate measures.

CAUTION!

- 1. This manual may not be copied in whole or in part without prior written permission of TOSHIBA TEC.*
- 2. The contents of this manual may be changed without notification.*
- 3. Please refer to your local Authorised Service representative with regard to any queries you may have in this manual.*

1. PRODUCT OVERVIEW

1.1 Introduction

Thank you for choosing the TOSHIBA B-EX4T1 series bar code printer. This Owner's Manual contains from general set-up through how to confirm the printer operation using a test print, and should be read carefully to help gain maximum performance and life from your printer. For most queries please refer to this manual and keep it safe for future reference. Please contact your TOSHIBA TEC representative for further information concerning this manual.

1.2 Features

This printer has the following features:

- The print head block can be opened providing smooth loading of media and ribbon.
- Various kinds of media can be used as the media sensors can be moved from the centre to the left edge of the media.
- Web functions such as remote maintenance and other advanced network features are available.
- Superior hardware, including the specially developed 8 dots/mm (203 dots/inch) or 12 dots/mm (305 dots/inch) thermal print head which will allow very clear print at a printing speed of 3 inches/sec., 6 inches/sec., 10 inches/sec., 12 inches/sec. or 14 inches/sec. with 8 dots/mm thermal head or 3 inches/sec., 5 inches/sec., 8 inches/sec., 10 inches/sec., 12 inches/sec. or 14 inches/sec. with 12 dots/mm thermal head.
- Besides the optional Cutter Module, there is also an optional Peel off Module, Ribbon Saving Module, RS-232C I/F card, Centronics I/F card, Expansion I/O Card, Wireless LAN I/F card, the RTC/USB host I/F card, RFID module, and Narrow width platen kit.

1.3 Unpacking

Unpack the printer as per the Unpacking Instructions supplied with the printer.

NOTES:

1. Check for damage or scratches on the printer. However, please note that TOSHIBA TEC shall have no liability for any damage of any kind sustained during transportation of the product.
2. Keep the cartons and pads for future transportation of the printer.

1.4 Accessories

When unpacking the printer, please make sure all the following accessories are supplied with the printer.

- Power cord

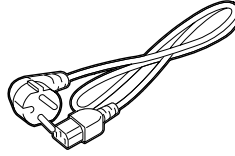

- Safety precautions

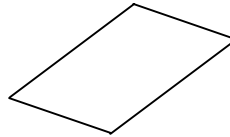

- Quick installation manual

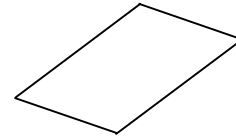

1.5 Appearance

The names of the parts or units introduced in this section are used in the following chapters.

1.5.1 Dimensions

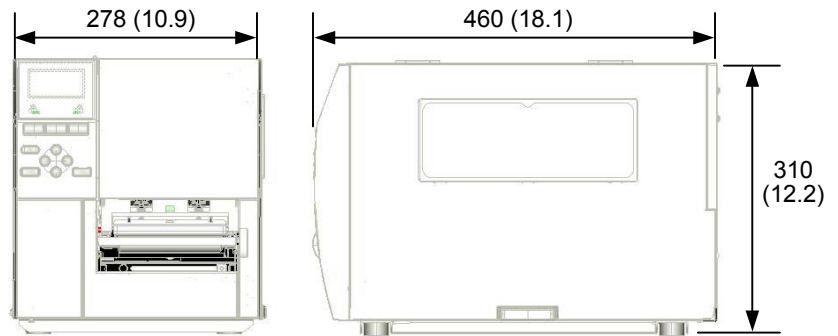

Dimensions in mm (inches)

1.5.2 Front View



1.5.3 Rear View

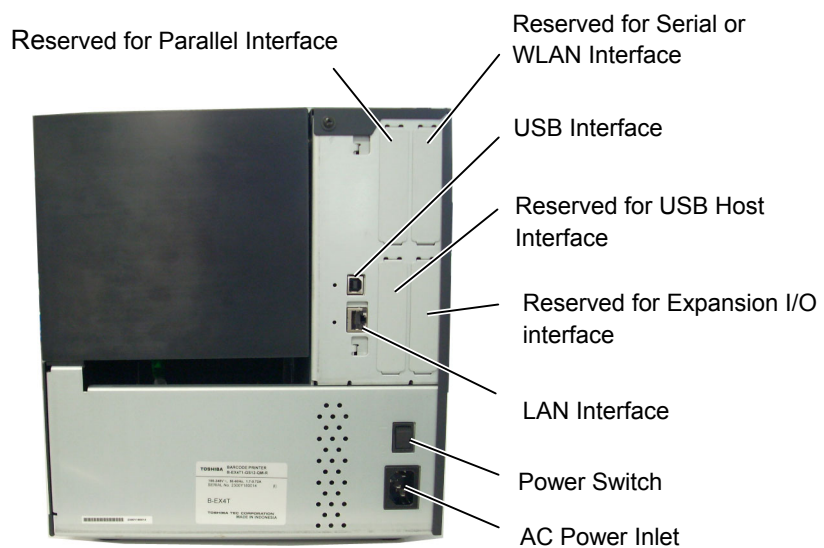

1.5.4 Operation Panel

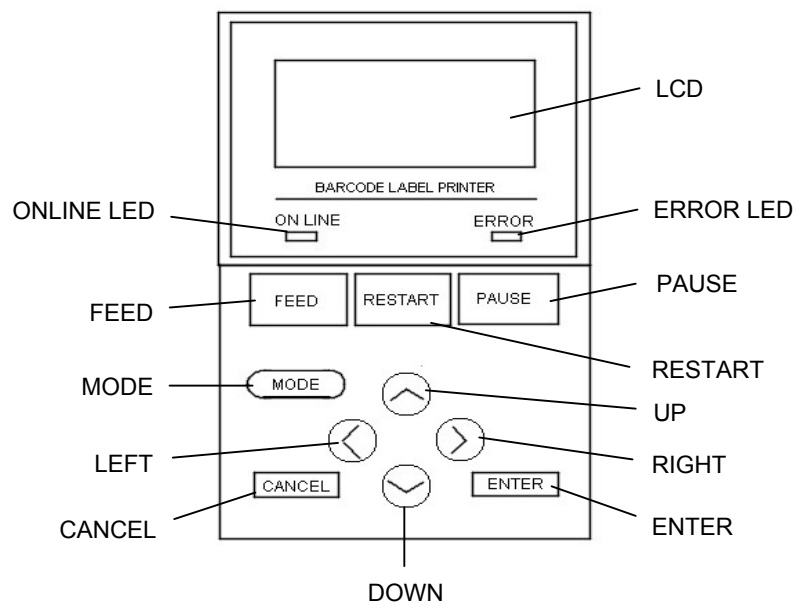

Please see **Section 3** for further information about the Operation Panel.

1.5.5 Interior

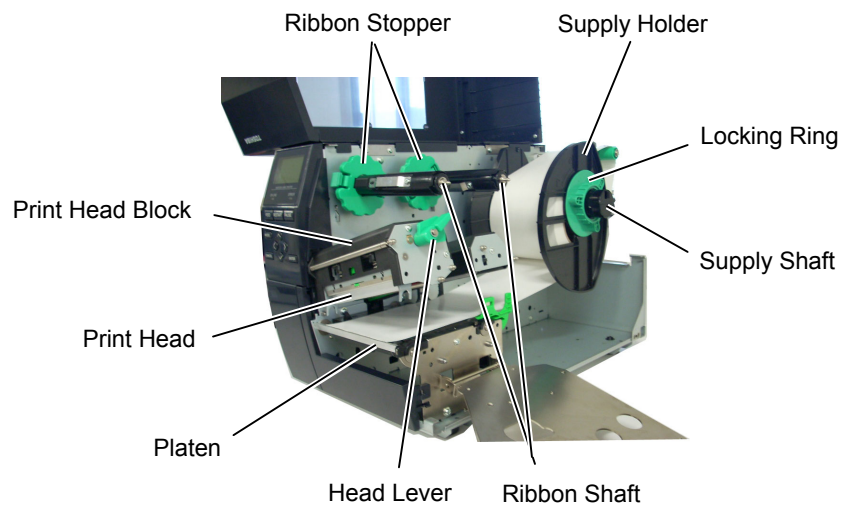

1.6 Options

Option Name	Type	Description
Disc cutter module	B-EX204-QM-R	Disc cutter Each time media is cut, the media feed is stopped.
Rotary cutter module	B-EX204-R-QM-R	Rotary cutter On-the-fly (non-stop) cut operation is enabled.
Strip module	B-EX904-H-QM-R	This allows use of on-demand (peel-off) operation or to take-up labels and backing paper together when using the rewind guide plate. To purchase the strip module, please inquire at your local distributor.
Ribbon saving module	B-EX904-R-QM-R	This module moves the print head up and down by using a solenoid to minimize ribbon usage as far as possible.
Narrow width platen	B-EX904-PK-QM-R	This platen kit is for using narrow and thin paper.
RFID module mount kit	B-EX700-RFID-H1-QM-R	This kit is to mount Tagsys HF RFID module and antenna.
RFID module	B-EX700-RFID-U2-EU-R B-EX700-RFID-U2-US-R B-EX700-RFID-U2-CN-R	Installing this module enables read and write of UHF RFID tags. EU for Europe US for USA/Canada CN for China
203-dpi print head	B-EX704-TPHE2-QM-R	This print head enables a conversion of a 305dpi print head of the B-EX4T1-TS12 model into 203dpi print head.
305-dpi print head	B-EX704-TPHE3-QM-R	This print head enables a conversion of a 203dpi print head of the B-EX4T1-GS12 model into 305dpi print head.
RTC & USB host interface card	B-EX700-RTC-QM-R	This card holds the current time: year, month, day, hour, minute, second and provides a USB host interface.
Expansion I/O interface card	B-EX700-IO-QM-R	Installing this card in the printer allows connection to an external device with the exclusive interface.
Parallel interface card	B-EX700-CEN-QM-R	Installing this card provides a Centronics interface port.
Serial interface card	B-EX700-RS-QM-R	Installing this card provides an RS-232C interface port.
Wireless LAN interface card	B-EX700-WLAN-QM-R	Installing this card allows a communication by wireless LAN.

NOTE:

To purchase the optional kits, please contact the nearest authorised TOSHIBA TEC representative or TOSHIBA TEC Head Quarters.

2. PRINTER SETUP

This section outlines the procedures to setup your printer prior to its operation. The section includes precautions, loading media and ribbon, connecting cables, setting the operating environment of the printer, and performing an online print test.

Setup Flow	Procedure	Reference
Installation	After referring to the Safety Precautions in this manual, install the printer on a safe and stable location.	2.1 Installation
Connecting the power cord	Connect a power cord to the power inlet of the printer, then, to an AC outlet.	2.2 Connecting the Power Cord
Loading the media	Load a label stock or tag stock.	2.3 Loading the Media
Media sensor position alignment	Adjust the position of feed gap sensor or black mark sensor according to the media to be used.	2.3.1 Loading the Media
Loading the ribbon	In case of thermal transfer printing, load the ribbon.	2.3.2 Loading the Ribbon
Connecting to a host computer	Connect the printer to a host computer or a network.	2.4 Connecting the Cables to Your Printer
Turning the power ON	Turn on the printer power.	2.5 Turning the Printer ON/OFF
Printer setting	Set the printer parameters in the system mode.	2.6 Printer Setting
Installing the printer driver	If necessary, install the printer driver in your host computer.	2.7 Installing the Printer Drivers
Print test	Make a print test in your operating environment and check the print result.	2.8 Print Test
Position and Print Tone Fine adjustment	If necessary, fine adjust the print start position, cut/strip position, print tone, etc.	2.9 Position and Print Tone Fine Adjustment
Automatic threshold setting	If the print start position cannot be detected properly when pre-printed label is used, set the threshold automatically.	2.10 Threshold Setting
Manual threshold setting	If the print start position cannot be detected properly even an automatic threshold setting is performed, manually set the threshold.	2.10 Threshold Setting

2.1 Installation

To insure the best operating environment, and to assure the safety of the operator and the equipment, please observe the following precautions.

- Operate the printer on a stable, level, operating surface in a location free from excessive humidity, high temperature, dust, vibration or direct sunlight.
- Keep your work environment static free. Static discharge can cause damage to delicate internal components.
- Make sure that the printer is connected to a clean source of AC Power and that no other high voltage devices that may cause line noise interference are connected to the same mains.
- Assure that the printer is connected to the AC mains with a three-prong power cable that has the proper ground (earth) connection.
- Do not operate the printer with the cover open. Be careful not to allow fingers or articles of clothing to get caught into any of the moving parts of the printer especially the optional cutter mechanism.
- Make sure to turn off the printer power and to remove the power cord from the printer whenever working on the inside of the printer such as changing the ribbon or loading the media, or when cleaning the printer.
- For best results, and longer printer life, use only TOSHIBA TEC recommended media and ribbons.
- Store the media and ribbons in accordance with their specifications.
- This printer mechanism contains high voltage components; therefore you should never remove any of the covers of the machine as you may receive an electrical shock. Additionally, the printer contains many delicate components that may be damaged if accessed by unauthorised personnel.
- Clean the outside of the printer with a clean dry cloth or a clean cloth slightly dampened with a mild detergent solution.
- Use caution when cleaning the thermal print head as it may become very hot while printing. Wait until it has had time to cool before cleaning. Use only the TOSHIBA TEC recommended print head cleaner to clean the print head.
- Do not turn off the printer power or remove the power plug while the printer is printing or while the ON LINE lamp is blinking.

2.2 Connecting the Power Cord

CAUTION!

1. Make sure that the printer Power Switch is turned to the OFF (O) position before connecting the Power Cord to prevent possible electric shock or damage to the printer.
2. Connect the Power Cord to a supply outlet with a properly grounded (earthed) connection.

1. Make sure that the printer Power Switch is in the OFF (O) position. Connect the Power Cord to the printer as shown in the figure below.



Power Switch



Power Cord

2. Plug the other end of the Power Cord into a grounded outlet as shown in the figure below.

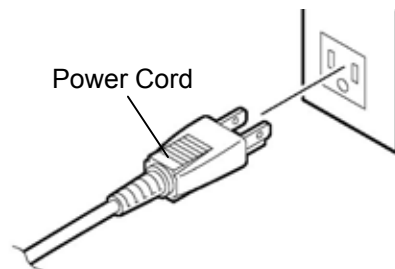

[Example of US Type]

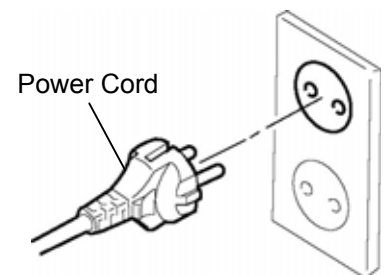

[Example of EU Type]

2.3 Loading Supplies

WARNING!

1. Do not touch any moving parts. To reduce the risk of fingers, jewellery, clothing, etc., being drawn into the moving parts, be sure to load the media once the printer has stopped moving completely.
2. The Print Head becomes hot immediately after printing. Allow it to cool before loading the media.
3. To avoid injury, be careful not to trap your fingers while opening or closing the cover.

CAUTION!

1. Be careful not to touch the Print Head Element when raising the Print Head Block. Failure to do this may cause missing dots by static electricity or other print quality problems.
2. When loading or replacing the media or a ribbon, be careful not to damage the print head with a hard object like a watch or a ring.



Care must be taken not to allow the metal or glass part of a watch to touch the print head edge.

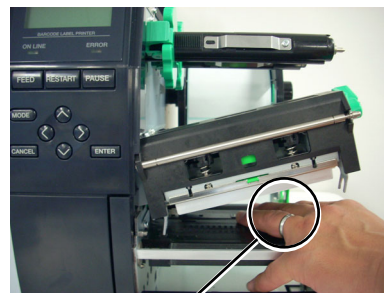

Care must be taken not to allow a metal object like a ring to touch the print head edge.

Since the print head element can be easily damaged by shock, please treat it carefully by not hitting a hard object against it.

2.3.1 Loading the Media

The following procedure shows the steps to properly load the media into the printer so that it feeds straight and true through the printer.

The printer prints both labels and tags.

1. Turn off the power and open the Top Cover.
2. Turn the Head Lever to **FREE** position, then release the Ribbon Shaft Holder Plate.
3. Open the Print Head Block.

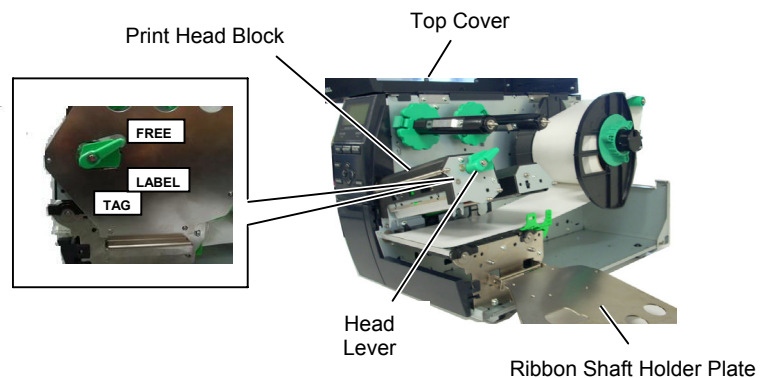

NOTES:

1. When the Head Lever is turned to **FREE** position, the Print Head is raised.
2. To enable printing the Head Lever must be set to the **LABEL / TAG** position. (This ensures that the Print Head is closed.)
There are two head pressure levels in the **LABEL / TAG** position. Set the Head Lever depending on the media type:
Position **LABEL**: Labels
Position **TAG**: Tags
However, proper position may differ depending on media. For details, refer to your TOSHIBA TEC authorised service representative.
3. Do not turn the Locking Ring counter-clockwise too far or it may come off the Supply Holder.

4. Turn the Locking Ring counterclockwise and remove the Supply Holder from the Supply Shaft.

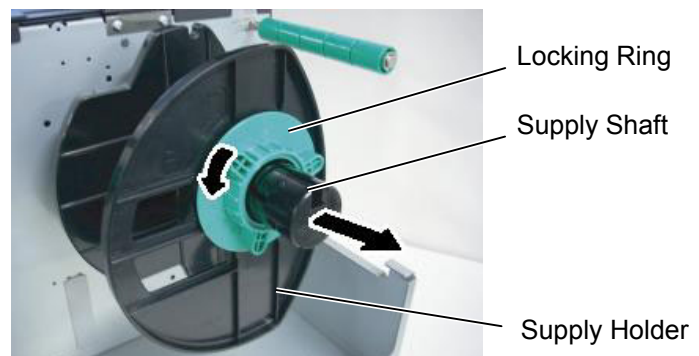

5. Put the media on the Supply Shaft.
6. Pass the media around the Guide Shaft, then pull the media towards the front of the printer.

2.3.1 Loading the Media (Cont.)

NOTE:
Do not over-tighten the Locking Ring of the Supply Holder.

7. Align the projection of the Supply Holder with the groove of the Supply Shaft, and push the Supply Holder against the media until the media is held firmly in place. This will centre the media automatically. Then turn the Locking Ring clockwise to secure the Supply Holder.

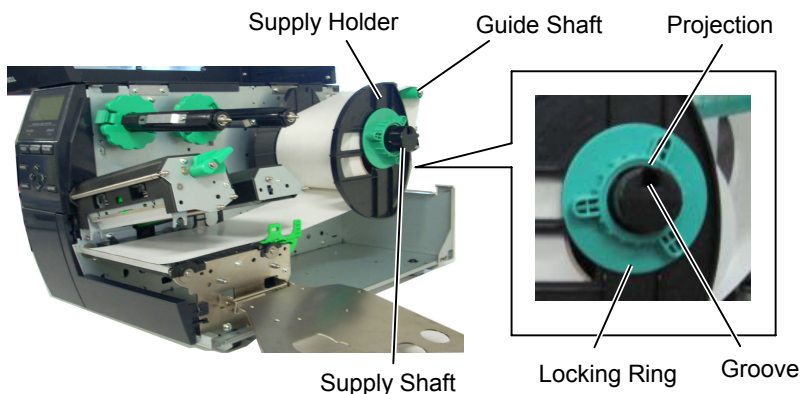

In the case of a label rolled with the print side facing inside.

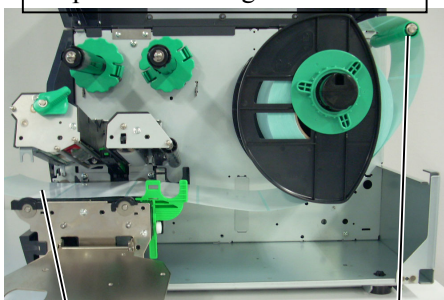

Media

Guide Shaft

In the case of a label rolled with the print side facing outside.

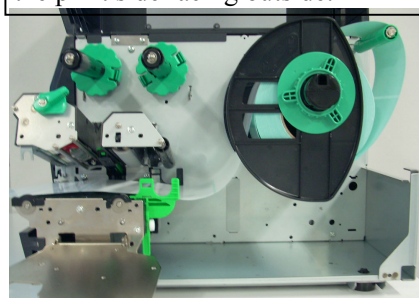

8. Place the media between the Media Guides, adjust the Media Guides to the media width, and tighten the Locking Screw.
9. Check that the media path through the printer is straight. The media should be centred under the Print Head.

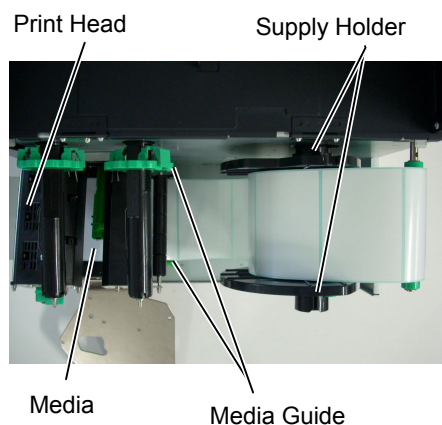
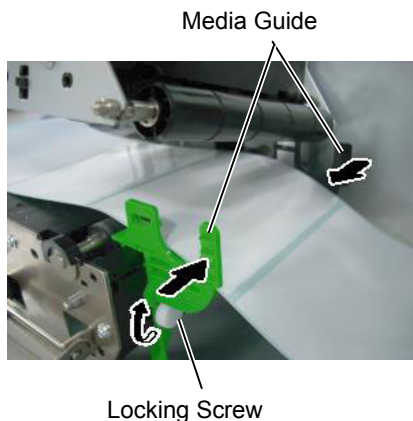

2.3.1 Loading the Media (Cont.)

10. Lower the Print Head Block until it stops.
11. After loading the media, it may be necessary to set the Media Sensors used to detect the print start position for label or tag printing.

Setting the Feed Gap Sensor position

- (1) Manually move the Media Sensor so that the Feed Gap Sensor is positioned at the centre of the labels. (● indicates the position of the Feed Gap Sensor).

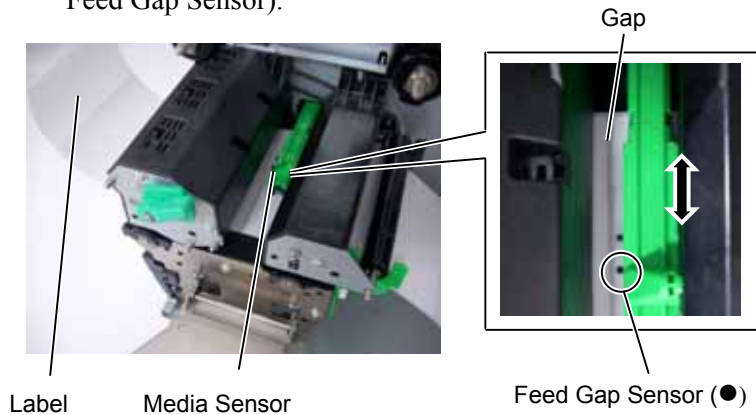

NOTE:

Be sure to set the black mark sensor to detect the centre of the black mark, otherwise a paper jam or no paper error may occur.

Setting the Black Mark Sensor position

- (1) Pull about 500 mm of media out of the front of the printer, turn the media back on itself and feed it under the Print Head past the sensor so that the black mark can be seen from above.
- (2) Manually move the Media Sensor so that the Black Mark Sensor is in line with the centre of the black mark on the media. (■ indicates the position of the Black Mark Sensor).

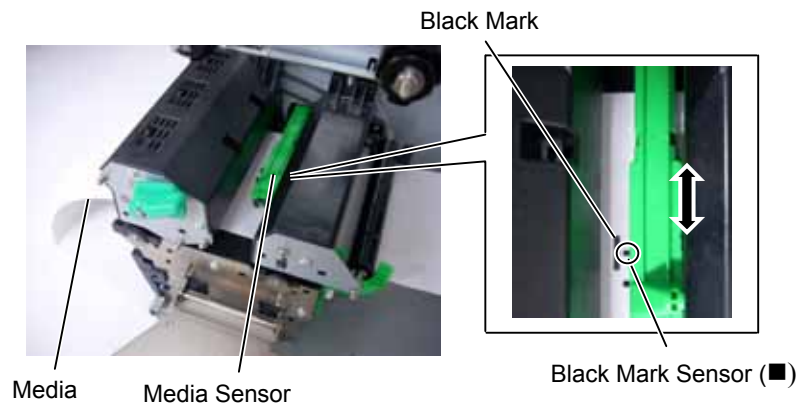

2.3.1 Loading the Media (Cont.)

- 12. Batch mode**
In the batch mode, the media is continuously printed and fed until the number of labels/tags specified in the issue command have been printed.

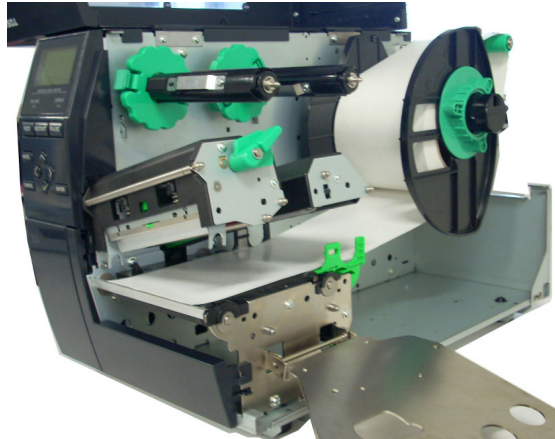

- 13. Loading with peel off module**
When the optional Strip Module is fitted, the backing paper is automatically removed from the label at the Strip Plate as each label is printed.

NOTES:

1. Be sure to set the Selection Switch to **STANDARD/PEEL OFF** position.
2. The backing paper is easier to feed back to the Take-Up Spool if the Front Plate is removed.
3. Fit the Take-Up Clip so that the longer side of the clip is fitted into the shallow groove in the Take-Up Spool.
4. The backing paper can be wound directly onto the Take-up Spool or a paper core.

- (1) Remove enough labels from the leading edge of the media to leave 500mm of backing paper free.
- (2) Insert the backing paper under the Strip Plate.
- (3) Wind the backing paper onto the Take-up Spool and fix it in position with the Take-up Clip. (Wind the paper counterclockwise around the spool as this is the direction it rotates.)
- (4) Rotate the Take-up Spool counter-clockwise a few times to remove any slack in the backing paper.
- (5) Set the Selection Switch mounted on the Rewinder Assembly to **STANDARD/PEEL OFF** position.

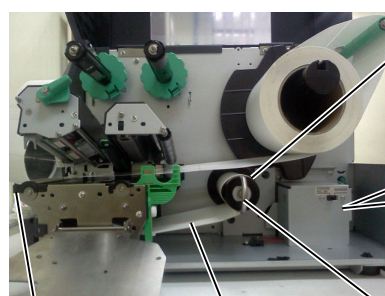

Strip Plate

Backing Paper

Take-up Spool



Take-up Clip

2.3.1 Loading the Media (Cont.)

WARNING!

The cutter is sharp, so care must be taken not to injure yourself when handling the cutter.

CAUTION!

1. Be sure to cut the backing paper of the label. Cutting labels will cause the glue to stick to the cutter which may affect the cutter quality and shorten the cutter life.
2. Use of tag paper when the thickness exceeds the specified value may affect the cutter life.

NOTE:

When using the Rotary Cutter, be sure to install the Ribbon Saving Module (B-EX904-R-QM-R). Failure to do this may cause a paper jam or ribbon error.

14. Loading with cutter

When the optional Cutter Module is fitted, the media is automatically cut. A disc cutter and a rotary cutter are available as an option, but they are used in the same way.

Insert the leading edge of the media into the cutter until it comes out the Media Outlet of the Cutter Module.

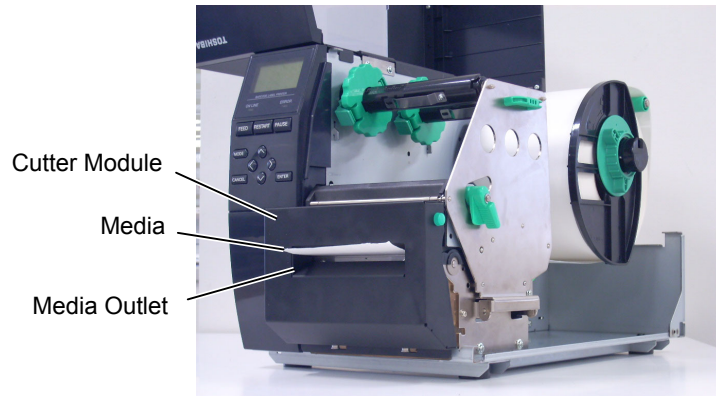

2.3.2 Loading the Ribbon

NOTES:

1. When attaching the ribbon stoppers, make sure that the pinchers face into the printer
2. Be sure to remove any slack in the ribbon when printing. Printing with a wrinkled ribbon will lower the print quality.
3. The Ribbon Sensor is mounted on the rear of the Print Head Block to detect a ribbon end. When a ribbon end is detected, "NO RIBBON" message will appear on the display and the ERROR LED will illuminate.

There are two types of media available for printing on: these are thermal transfer media and direct thermal media (a chemically treated surface). DO NOT LOAD a ribbon when using a direct thermal media.

1. Grasp the tabs on the top and bottom of the Ribbon Stoppers and move the Ribbon Stoppers back to the end of the Ribbon Shaft.

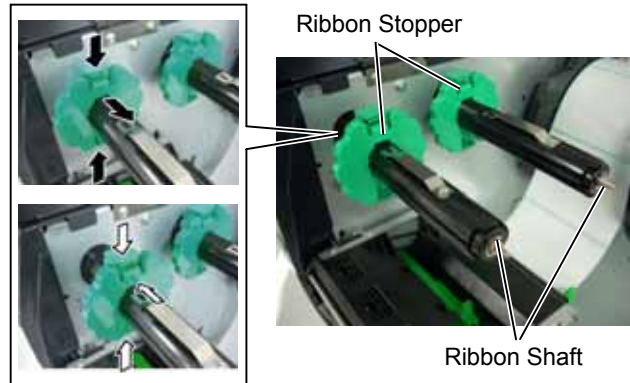

2. Leaving plenty of slack between the ribbon spools, place the ribbon onto the Ribbon Shafts as shown below.

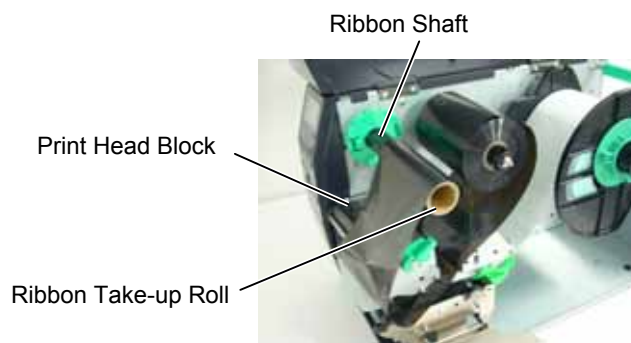

Ribbon path

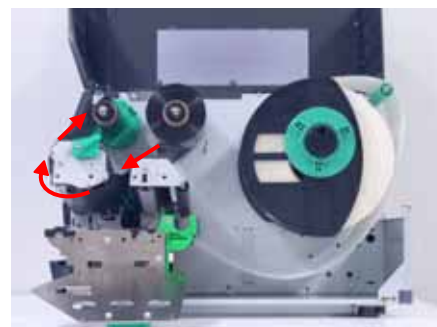

2.3.2 Loading the Ribbon (Cont.)

3. Slide the Ribbon Stoppers along the Ribbon Shafts to a position where the ribbon is centred when fitted.
4. Lower the Print Head Block and set the Ribbon Shaft Holder Plate aligning its holes with the Ribbon Shafts.
5. Take up any slack in the ribbon. Wind the leading tape onto the ribbon take-up roll until the ink ribbon can be seen from the front of the printer.

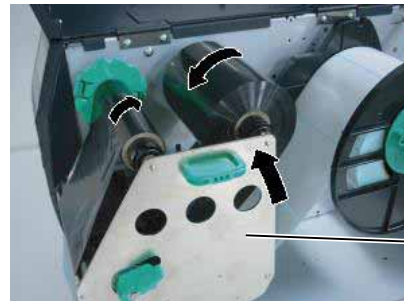

Ribbon Shaft
Holder Plate

6. Turn the Head Lever to **Lock** position to close the Print Head.
7. Close the Top Cover.

■ Auto Ribbon Saving Mode

When the optional Ribbon Saving Module (B-EX904-R-QM-R) is installed, it is possible to reduce ribbon loss by stopping the ribbon feed for non-print areas. To activate the ribbon save, at least the following non-print area is required:

203 dpi mode (mm)

Print speed	3 ips	6 ips	10 ips	12 ips	14 ips
Min. non-print area	20	20	35	60	75

305 dpi model (mm)

Print speed	3 ips	5 ips	8 ips	10 ips	12 ips	14 ips
Min. non-print area	20	20	25	35	60	75

2.4 Connecting the Cables to Your Printer

The following paragraphs outline how to connect the cables from the printer to your host computer, and will also show how to make cable connections to other devices. Depending on the application software you use to print labels, there are 5 possibilities for connecting the printer to your host computer. These are:

- An Ethernet connection using the printer's standard LAN connector.
- A USB cable connection between the printer's standard USB connector and your host computer's USB port. (Conforming to USB 2.0)
- A serial cable connection between the printer's optional RS-232 serial connector and one of your host computer's COM ports.
- A parallel cable connection between the printer's optional parallel connector and your host computer's parallel port (LPT).
- Wireless LAN using an optional Wireless LAN board.

For details, refer to **APPENDIX 2**.

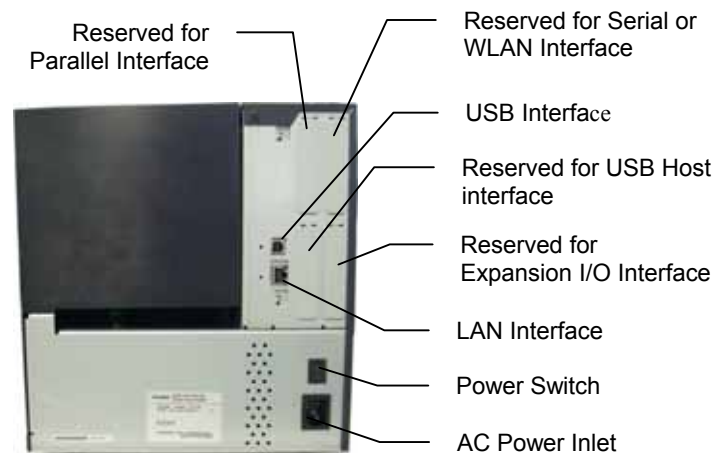

2.5 Turning the Printer ON/OFF

When the printer is connected to your host computer it is good practice to turn the printer ON before turning on your host computer and turn OFF your host computer before turning off the printer.

2.5.1 Turning ON the Printer

CAUTION!

Use the power switch to turn the printer On/Off. Plugging or unplugging the Power Cord to turn the printer On/Off may cause fire, an electric shock, or damage to the printer.

NOTE:

If a message other than ON LINE appears on the display or the ERROR LED lamp is illuminated, refer to **Section 5.1, Error Messages**.

1. To turn ON the printer power, press the Power Switch as shown in the diagram below. Note that (|) is the power ON side of the switch.



Power Switch

2. Check that the ON LINE message appears in the LCD Message Display and that the ON LINE and POWER LED lights are illuminated.

2.5.2 Turning OFF the Printer

CAUTION!

1. Do not turn off the printer power while the media is being printed, as this may cause a paper jam or damage to the printer.
2. Do not turn off the printer power while the ON LINE lamp is blinking as this may cause damage to your computer.

1. Before turning off the printer Power Switch verify that the ON LINE message appears in the LCD Message Display and that the ON LINE LED light is on and is not flashing.
2. To turn OFF the printer power press the Power Switch as shown in the diagram below. Note that (O) is the power OFF side of the switch.



Power Switch

2.6 Printer Setting

Depending on the settings of your host computer or an interface to be used, it may be necessary to change the printer parameter settings.

Follow the procedures described below to change the printer parameter settings to correspond to your environment.

NOTE:

Incorrect settings can cause the printer to function erroneously. If you have any problems with the parameter settings, please contact your nearest TOSHIBA TEC service representative.

*For the settings this manual does not cover, please contact your nearest TOSHIBA TEC service representative, or refer to the **B-EX4T Series Key Operation Specification**.*

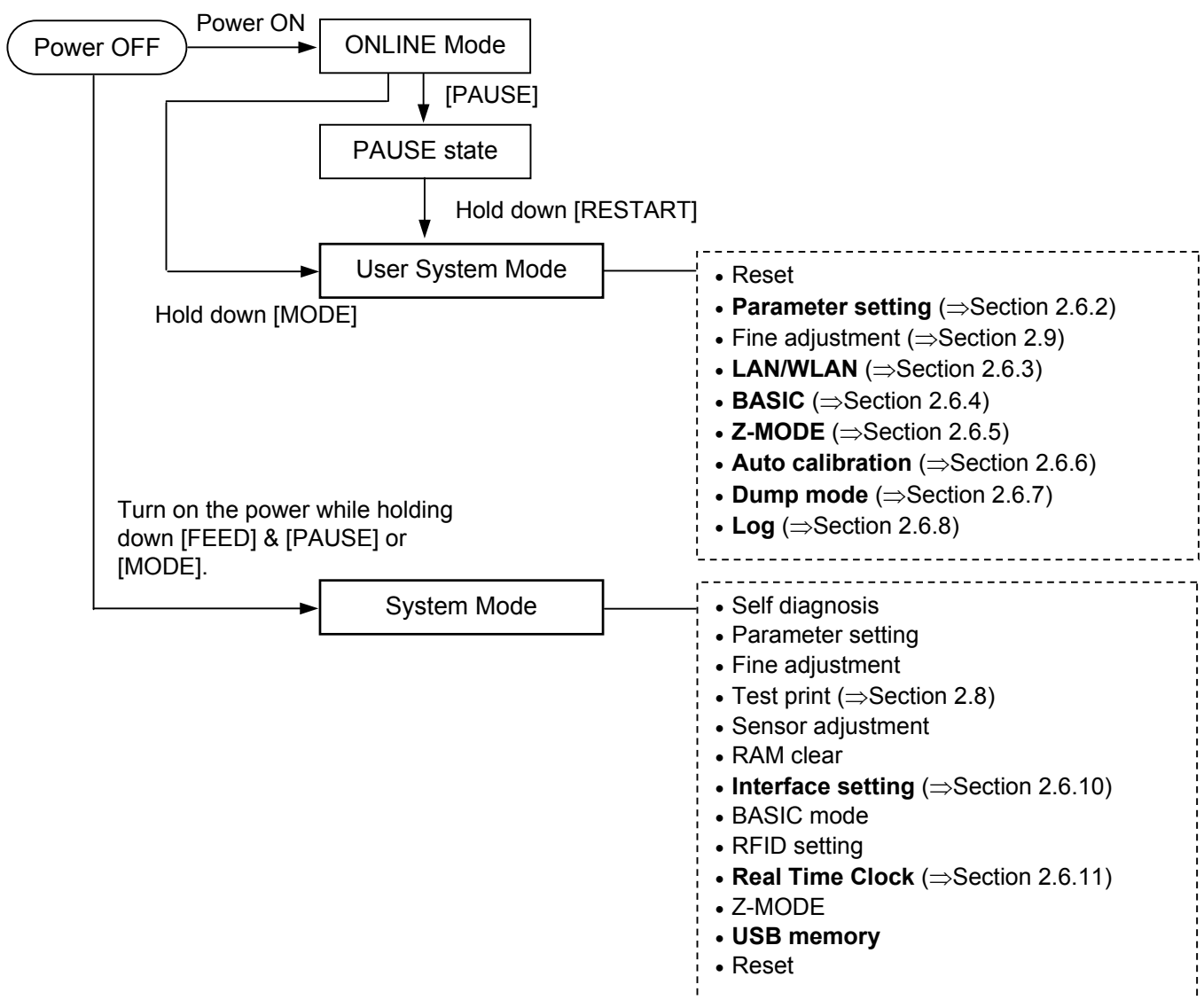

2.6 Printer Setting (Cont.)

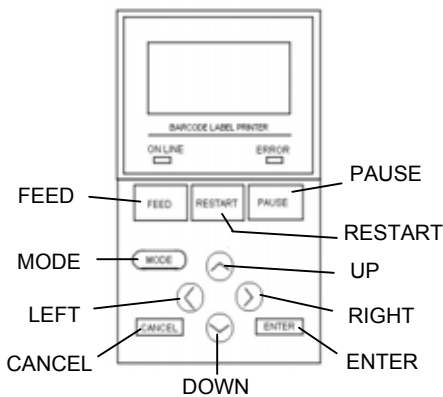

■ Key functions in the system mode

Key	Function
[MODE]	Returns to the mode menu screen.
[CANCEL] or [FEED]+[RESTART]	Returns to the upper hierarchy.
[ENTER] or [PAUSE]	Displays a next screen. Saves the setting and returns to the upper hierarchy.
[UP] or [RESTART]	Moves the cursor upward. ^(Note 1) Increases a value. ^(Note 2)
[DOWN] or [FEED]	Moves the cursor downward. ^(Note 1) Decreases a value. ^(Note 3)
[LEFT]	Moves the cursor to the left. ^(Note 3)
[RIGHT]	Moves the cursor to the right. ^(Note 3)

NOTES:

1. The cursor does not move any further when the selected option is listed at the top or bottom.
2. The value does not increase or decrease any further when the selected value is the upper or lower limit.
3. The cursor does not move any further when it is at the left-most or right-most position.
4. Be careful the selected value does not become effective if the printer is turned off without pressing the [ENTER] key.

2.6.1 User System Mode

How to enter the User System Mode

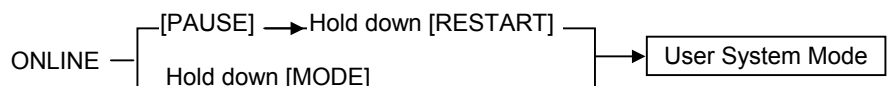

The User System Mode consists of the following menus.

<1>RESET Used to reset the printer.
<2>PARAMETER SET (⇒ Section 2.6.2) Used to set the printer parameters.
<3>ADJUST SET (⇒ Section 2.9) Used to fine adjust the print start position, cut position, etc.
<4>LAN/WLAN (⇒ Section 2.6.3) Used to enable or disable the LAN communication and SNMP.
<5>BASIC (⇒ Section 2.6.4) Used to set the function of basic program when it is loaded to the printer.
<6>Z-MODE (⇒ Section 2.6.5) Same as BASIC
<7>AUTO CALIB (⇒ Section 2.6.6) Used to enable or disable the automatic calibration function.
<8>DUMP MODE (⇒ Section 2.6.6) Used to print the data in the receive buffer for debug.
<9>LOG (⇒ Section 2.6.7) Used to save print logs in a USB memory.

2.6.2 Parameter Setting

The Parameter Set menu allows configuring printer parameter settings. The following table shows the contents of the Parameter Set menu.

USER SYSTEM MODE

▲	<1>RESET
	<2>PARAMETER SET
	<3>ADJUST SET
▼	<4>LAN/WLAN

Contents of the Parameter Set Menu

Menu	Sub menu	Parameter	
Parameter set	Printer Set (Section 2.6.2.1)	MEDIA LOAD	
		FORWARD WAIT	
		FW/BK ACT	
		HU CUT/RWD	
		RBN SAVE	
		PRE PEEL OFF	
		BACK SPEED	
	Software Set (Section 2.6.2.2)		FONT CODE
			ZERO FONT
			CODE
			PEEL OFF STATUS
			USB I/F STATUS
			FEED KEY
			KANJI CODE
			EURO CODE
			AUTO HD CHK
			WEB PRINTER
			RBN NEAR END
			EX I/O
			LBL/RBN END
			MAX CODE
		XML	
		THRESHOLD SELECT	
		ENERGY TYPE	
		PW SAVE TIME	
	Panel (Section 2.6.2.3)		LCD LANGUAGE
			DISPLAY
			CONTRAST
	Password (Section 2.6.2.4)		PASSWORD

2.6.2 Parameter Setting (Cont.)

2.6.2.1 Printer Set

(1) MEDIA LOAD

This parameter is to choose how the printer behaves to detect the home position.

- OFF Media loading function is disabled (Same as a feed by [FEED] key)
- STD When the printer is tuned on, reset in batch, or print head is closed, the printer detects a gap/black mark and feeds the paper from the sensor to the print start position.
- ECO When the printer is tuned on, reset in batch, or print head is closed, the printer detects a gap/black mark and feeds the paper to the print start position based on the label pitch.
- ECO+Bfeed Economy + backfeed

(2) FORWARD WAIT

This parameter is to choose whether or not to activate the auto forward wait function. This function, used in the cut mode, automatically feeds the media forward if there is more than 1-second idle time after printing, to prevent the top edge of the media from curling.

- OFF Disables the auto forward feed wait
- ON Enables the auto forward feed wait

(3) FORWARD WAIT POS.

When the auto forward feed wait parameter is set to ON, the feed amount can be fine adjusted.

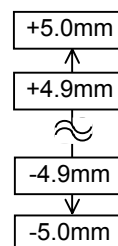

(4) FW/BK ACT.

- MODE1 The printer waits for next issue with 13.7-mm media forwarded.
- MODE2 When the thermal transfer method, Transmissive sensor, and cut issue are selected, the printer feeds 6-mm media backward, then waits for next issue with 3-mm media forwarded.

2.6.2 Parameter Setting (Cont.)

NOTE:

The print head may not be raised depending on the rise of the solenoid's temperature.

NOTE:

1. *Do not enable the ribbon saving function when the ribbon saving module is not installed. Doing so causes ribbon slack and print failure.*
2. *The ribbon saving option must be selected according to the head lever position. Incorrect setting may disable the proper ribbon saving function.*

NOTE:

Pre-strip function is automatically enabled when the print speed is set to 10 ips.

(5) HU CUT/RWD.

This parameter is to choose whether or not to activate the head up action in the cut issue or to use the Rewinder in the batch or strip issue. This function prevents ribbon smudges by raising the print head during a reverse feed to the print start position.

- OFF Head up cut is not performed or the Rewinder is not used.
- ON Head up cut is performed or the Rewinder is used.

(6) RBN SAVE

This parameter is to choose whether or not to activate the ribbon saving function. This function enables reducing the ribbon loss caused by taking up unused ribbon during non-print areas.

- TAG Enabled (When the head lever is set to TAG position.)
- LABEL Enabled (When the head lever is set to Label position)
- OFF Disabled.

(7) PRE PEEL OFF

This parameter is to choose whether to activate the pre-strip function. When this parameter is set to ON, the top edge of a label is separated (pre-stripped) from the backing paper before the label is printed. This function is intended to make the strip issue easier in the case the labels are hard to strip due to the label intensity, adhesive power, or the printing speed.

- OFF Disables pre peel off
- ON Enables pre peel off

(8) BACK SPEED

This parameter is to choose a back feed speed.

In the strip issue, the back feed speed of 3 ips may cause a shortage of feed amount due to a lack of torque, slippery media surface, etc. In such case, reduce the back feed speed to 2 ips to secure the feed amount.

- STD 3ips
- LOW 2ips

2.6.2 Parameter Setting (Cont.)

2.6.2.2 Software Set

(1) FONT CODE

This parameter is to choose a character code used for printing. Printed characters differ depending on the chosen character code and font.

- PC-850
- PC-852
- PC-857
- PC-8
- PC-851
- PC-855
- PC-1250
- PC-1251
- PC-1252
- PC-1253
- PC-1254
- PC-1257
- LATIN9
- Arabic
- PC-866
- UTF-8

NOTE:

The following fonts do not support a zero with a slash.

Therefore, even if a zero with a slash is specified, a zero without a slash is used.

[Bit map fonts]

OCR-A, OCR-B, GOTHIC725 Black, Kanji, Chinese character

[Outline fonts]

Price fonts 1, 2, and 3, DUTCH801 Bold, BRUSH738 Regular, GOTHIC725 Black, TrueType font

(2) ZERO FONT

This parameter is to choose the way to indicate zero between “0” and “Ø”.

- 0 No slash used
- Ø Slash used

(3) CODE

This parameter is to choose a command control code.

- AUTO Automatically selected.
- {,}
- ESC, LF, NUL
- MANUAL Control code is specified by a user.

(4) MANUAL

When MANUAL is selected for the CODE parameter, you need to specify each of the control codes 1 to 3 with hex. code.

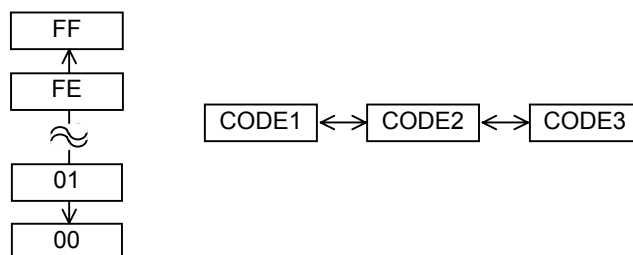

2.6.2 Parameter Setting (Cont.)

(5) PEEL OFF STATUS

This parameter is to choose whether the printer sends a strip wait status to the host in response to a status request command.

- OFF
- ON

(6) USB I/F STATUS

This parameter is to choose whether or not to return a response to the host via USB.

- OFF Disables sending a response via USB
- ON Enables sending a response via USB

(7) FEED KEY

This parameter is to choose the function of the FEED key.

- FEED Feeds one label.
- PRINT Prints data in the image buffer (The last printed data)

(8) KANJI CODE

This parameter is to choose a KANJI code.

- TYPE1 Windows code
- TYPE2 Original code

After selecting a Kanji code, press [ENTER] key

(9) EURO CODE

This parameter is to choose a Euro code (€).

“20” to “FF” (Specify the hex code in 2 bytes of ASCII code)

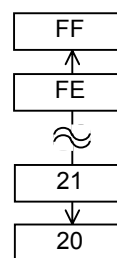

(10) AUTO HD CHK

This parameter is to choose whether to perform the auto print head check at a power on time.

- OFF Auto print head check is not performed.
- ON Auto print head check is performed.

2.6.2 Parameter Setting (Cont.)

NOTE:

Since a detected remaining ribbon length has some margin of error, use the specified length as a guide.

(11) WEB PRINTER

This parameter is to choose whether to use the printer as a web printer. When the web printer is enabled, the status of the printer connected to a network can be monitored through the web browser.

- OFF Disables web printer function
- ON INTERNAL Enables web printer function (using an internal memory)
- ON EXTERNAL Enables web printer function (using an external memory)

(12) RBN NEAR END

This parameter is to choose the remaining ribbon length where the ribbon near end is detected.

- OFF Ribbon near end is not detected.
- 30m Ribbon near end is detected when the remaining ribbon is 30-m long. (Equivalent to ribbon diameter of 38 mm)
- 70m Ribbon near end is detected when the remaining ribbon is 70-m long. (Equivalent to ribbon diameter of 43 mm)

(13) EX.I/O

This parameter is to choose a type of the expansion I/O interface operating mode. This parameter needs to be set depending on the expansion I/O control specification of the device to be connected via the expansion I/O interface.

- TYPE1 Standard mode
- TYPE2 In-line mode

(14) LBL/RBN END

This parameter is to choose a printer processing when a label end or ribbon end is detected.

- TYPE1 When a label/ribbon end is detected in the middle of printing, the printer immediately stops printing.
- TYPE2 Selectable only when the ribbon saving function is not activated.
When a label/ribbon end is detected in the middle of printing, the printer prints the half-finished label as far as possible, and stops when the next label is at the home position.

NOTE:

The type specified by the command may differ from the actual mode, depending on the status of this parameter. Also, the data transmission method differs partly.
For details, refer to the External Equipment Interface Specification.

(15) MAXI CODE

This parameter is to choose a Maxicode specification.

- TYPE1 Compatible with the current version
- TYPE2 Special specification

2.6.2 Parameter Setting (Cont.)

(16) XML

This parameter is to choose a type of XML data to be printed.

- OFF Disables XML data printing.
- STD Standard specification
- ORACLE Oracle
- SAP SAP
- STD EXT Standard specification (External memory)
- ORACLE EXT Oracle using an external memory
- SAP EXT SAP using an external memory

(17) THRESHOLD SELECT

This parameter is to choose which threshold value for the media sensor to validate.

- REFLECT Reflective sensor
- TRANS. Transmissive sensor

Then, choose which value to use.

- MANUAL SET Threshold set in the Threshold mode takes effect.
- COMMAND SET Threshold set by command takes effect.

(18) ENERGY TYPE

This parameter is to choose an energy level applied to the print head.

- TRANSFER Thermal transfer print method → ①
- DIRECT Thermal direct print method → ②

① When TRANSFER is selected for the Energy type parameter, choose a ribbon type.

- Semi resin1 Semi-resin 1
- Semi resin2 Semi-resin 2
- Resin1 Resin 1
- Resin2 Resin 2
- Reserve1 to Reserve6 Reserved

② When DIRECT is selected for the Energy type parameter

- Standard Standard
- Reserve1 to Reserve9 Reserved

(19) PW SAVE TIME

This parameter is to set the length of time until the printer enters the sleep mode. (Unit: minute)

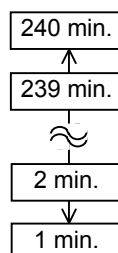

2.6.2 Parameter Setting (Cont.)

NOTE:

The language displayed on panel is Japanese when Japanese is selected, and English when English, German, French, Dutch, Spanish, Italian; or Portuguese is selected.

2.6.2.3 PANEL

(1) LCD LANGUAGE

This parameter is to choose a language in which the LCD message is displayed.

- ENGLISH
- GERMAN
- FRANCH
- DUTCH
- SPANISH
- JAPANESE
- ITALIAN
- PORTUGUESE

(2) MACHINE NAME

This parameter is to choose whether to display the model name.

- OFF Hidden
- ON Displayed

(3) PRINT PAGE

This parameter is to choose whether to display the number of labels printed.

- OFF Hidden
- ON Displayed

(4) IP ADDRESS

This parameter is to choose whether to display the IP address.

- OFF Hidden
- ON Displayed

(5) CONTRAST

This parameter is to adjust the contrast of the LCD.

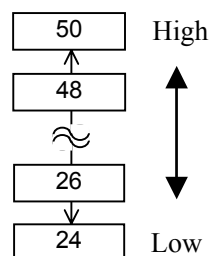

2.6.2 Parameter Setting (Cont.)

2.6.2.4 PASSWORD

(1) PASSWORD

This parameter is for system administrator only. Please do not change the setting for this parameter.

2.6.3 Enabling LAN/WLAN

The LAN/WLAN menu allows selecting whether or not to enable the LAN communication and SNMP.

USER SYSTEM MODE	
▲	<1>RESET
	<2>PARAMETER SET
	<3>ADJUST SET
▼	<4>LAN/WLAN

(1) LAN/WLAN

- OFF LAN and Wireless LAN are disabled.
- ON (AUTO) Automatically selected.
- ON (LAN) LAN is enabled.
- ON (WLAN) Wireless LAN is enabled.

(2) SNMP

- OFF SNMP is disabled.
- ON SNMP is enabled.

2.6.4 Basic Program Setting

The following table shows the contents of the Basic program setting menu.

USER SYSTEM MODE	
▲	<2>PARAMETER SET
	<3>ADJUST SET
	<4>LAN/WLAN
▼	<5>BASIC

Contents of the Basic Program Setting Menu

Menu	Sub menu
BASIC	BASIC
	FILE MAINTENANCE
	TRACE
	EXPAND MODE

(1) BASIC

This parameter is to choose whether to enable the BASIC program.

- OFF Disables BASIC program.
- ON Enables BASIC program.

(2) FILE MAINTENANCE

The block number and BASIC program file name (up to 12 characters) stored in the BASIC program storage area are displayed. If file name exceeds 12 characters, the overflowing characters are not displayed. When no file is stored, a hyphen (“-”) is displayed in place of the file name.

2.6.4 Basic Program Setting (Cont.)

(3) TRACE

This parameter is to choose whether to enable tracing the BASIC program.

- OFF Disables tracing the BASIC program.
- ON Enables tracing the BASIC program.

(4) EXPAND MODE

The printer switches the mode to execute the BASIC program.

2.6.5 Enabling Z-Mode

The Z-Mode menu allows selecting whether or not to enable the Z-Mode (Zebra converter).

USER SYSTEM MODE	
▲	<3>ADJUST SET
	<4>LAN/WLAN
	<5>BASIC
▼	<6>Z-MODE

(1) Z-MODE

- OFF Z-Mode is disabled.
- ON SETTING OFF Z-Mode is enabled. BASIC system mode program is not started immediately.
- ON SETTING ON Z-Mode is enabled. BASIC system mode program is started immediately.

2.6.6 Automatic Calibration

USER SYSTEM MODE

▲	<4>LAN/WLAN
	<5>BASIC
	<6>Z-MODE
▼	<7>AUTO CALIB

The Auto Calibration menu allows selecting whether or not to enable the automatic calibration at a power on time. When the automatic calibration is activate, the printer feeds the media for about 160 mm each time the power is turned on or the top cover is opened, to detect a print start position.

(1) AUTO CALIB

- | | |
|--------------------|--|
| • OFF | Disabled. |
| • ON TRANS. | Enabled. (Transmissive sensor) |
| • ON REFLECT | Enabled. (Reflective sensor) |
| • ON ALL | Enabled. (Transmissive & Reflective sensors) |
| • ON TRANS.+Bfeed | Auto calibration + back feed (Transmissive sensor) |
| • ON REFLECT+Bfeed | Auto calibration + back feed (Reflective sensor) |
| • ON ALL+Bfeed | Auto calibration + back feed (Transmissive & Reflective sensors) |

NOTES:

1. When AUTO CALIB is enabled, an automatic calibration is performed at an open/close of the print head and at a power on time.
2. When AUTO CALIB is enabled, the media length, effective print length, sensor type, and whether to use ribbon or not specified by commands are ignored.
3. This function is available only when the media pitch is 10.0 mm to 150.0 mm.
4. When the printer cannot detect the second black mark/gap, it will continue to feed the media for up to 500.0mm. If this does not work, the printer will stop, resulting in a paper jam.
5. During an automatic calibration, the printer also feeds the ribbon. Even if the ribbon is not loaded, no error results. However, the print condition will be automatically changed to "No ribbon" after the calibration ends.
6. When the cutter is installed and a previous issue was performed in cut issue mode, the media is cut and ejected after an automatic calibration completes.
7. When a label end or a head open occurs during an automatic calibration, the printer stops, resulting in an error. Loading new media and closing the print head can clear the error and resume the automatic calibration.
8. The media is fed backward after an auto calibration is performed if the reverse feed is enabled.

2.6.7 Dump Mode Setting

USER SYSTEM MODE	
▲	<5>BASIC
	<6>Z-MODE
	<7>AUTO CALIB
▼	<8>DUMP MODE

In the Dump Mode, data in the receive buffer are printed. Data are expressed in hexadecimal values. This operation allows verification of the programming commands or debug of the program.

(1) BUFFER

This parameter is to choose the receive buffer to dump.

- RS-232C RS-232C receive buffer
- CENTRONICS Centronics receive buffer
- LAN Network I/F receive buffer
- BASIC1 BASIC Interpreter:
I/F → Interpreter buffer
- BASIC2 BASIC Interpreter:
Interpreter buffer → I/F
- USB USB receive buffer
- RFID RFID receive buffer

(2) DUMP LIST

This parameter is to choose the output destination.

- USB MEMORY Saves in the USB memory. → ①
- PRINT Prints out → ②

① When USB MEMORY is selected:

A file is automatically created in the USB memory and named in the following format based on the printer model and saved date.

/ATA0/DUMP/B-EX4T1_DUMP_1007291030.BIN
(e.g. B-EX4T Type1, 10:30, July 29, 2010)

② When PRINT is selected:

Choose a printing method.

- ON DEMAND Prints 166 lines of data (approx. 50 cm), then stops. Subsequent data is printed when the [ENTER] key is pressed.
- ALL Prints all data in the receive buffer.

NOTE:

If a file with the same name already exists in the USB memory, it will be overwritten.

2.6.7 Dump Mode Setting (Cont.)

The data in the receive buffer is printed as follows.

Print Conditions

- Printing width: 3.9 inches (Approx. 100 mm)
- Sensor selection: None
- Print speed: 6"/sec. (203 dpi)
5"/sec. (305 dpi)
- Printing mode: Depends on the selection in use.
- 16 bytes/line
- Data is printed in the order from the new one to the old one.
- Data specified by the receive buffer write pointer will be printed in boldface.

```

00 00 00 00 00 00 00 00 00 00 00 00 00 00 00 00 .....
00 00 00 00 00 00 00 00 00 00 00 00 00 00 00 00 .....
00 00 00 00 00 00 00 00 00 00 00 00 00 00 00 00 .....
00 00 00 00 00 00 00 00 00 00 00 00 00 00 00 00 .....
7B 41 58 3B 2B 30 30 30 2C 2B 30 30 30 2C 2B 30 {AX;+000,+000,+0
30 7C 7D 7B 44 30 37 37 30 2C 31 31 30 30 2C 30 0}|{D0760,1100,0
37 34 30 7C 7D 7B 43 7C 7D 7B 4C 43 3B 30 30 33 740}|{C}|{LC;003
30 2C 30 30 32 30 2C 30 30 33 30 2C 30 36 36 30 0,0020,0030,0660
2C 30 2C 32 7C 7D 7B 4C 43 3B 30 30 37 30 2C 30 0,2}|{LC;0070,0
30 32 30 2C 30 30 37 30 2C 30 36 36 30 2C 30 2C 020,0070,0660,0,
39 7C 7D 7B 4C 43 3B 30 30 35 30 2C 30 30 32 30 9}|{LC;0050,0020
.....
44 45 46 47 48 49 4A 7C 7D 7B 50 43 31 30 3B 30 DEFGHIJ}|{PC10;0
33 35 30 2C 30 34 30 30 2C 31 2C 31 2C 4B 2C 30 350,0400,1,1,K,0
30 2C 42 3D 41 42 43 44 65 66 67 68 69 6A 6B 6C 0,B=ABCDefghijkl
.....
6D 6E 6F 70 7C 7D 7B 50 56 30 32 3B 30 33 33 30 mnop}|{PV02;0330
2C 30 36 36 30 2C 30 32 37 30 2C 30 32 35 30 2C 0660,0270,0250,
41 2C 30 30 2C 42 3D 42 7C 7D 7B 50 56 30 33 3B A,00,B=BI}|{PV03;
.....
3B 30 39 30 30 2C 30 31 38 30 2C 54 2C 48 2C 30 ;0900,0180,T,H,0
35 2C 41 2C 30 3D 31 32 33 34 35 36 37 38 39 30 5,A,0=1234567890
41 42 43 44 45 7C 7D 00 00 00 00 00 00 00 00 00 ABCDE}|{.....
.....

```

NOTE:
If an error occurs while printing, the printer stops printing and shows an error message. After clearing the error, the printer does not resume printing automatically.

Receive Buffer Size

Interface	203 dpi	305 dpi
RS-232C	6MB (393216 lines)	6MB (393216 lines)
Centronics	6MB (393216 lines)	6MB (393216 lines)
LAN	6MB (393216 lines)	6MB (393216 lines)
BASIC 1	8KB (512 lines)	8KB (512 lines)
BASIC 2	8KB (512 lines)	8KB (512 lines)
USB	6MB (393216 lines)	6MB (393216 lines)
RFID	8KB (512 lines)	8KB (512 lines)

Required Media Length

Interface	203 dpi	305 dpi
RS-232C	1189.2 m	1189.2 m
Centronics	1189.2 m	1189.2 m
LAN	1189.2 m	1189.2 m
BASIC 1	2 m	2 m
BASIC 2	2 m	2 m
USB	1189.2 m	1189.2 m
RFID	2 m	2 m

*: Media length required for printing all data in the receive buffer.

2.6.8 Logging

The Log menu allows saving print logs in a USB memory.

USER SYSTEM MODE

▲	<6>Z-MODE
	<7>AUTO CALIB
	<8>DUMP MODE
▼	<9>LOG

(1) LOG

- PRINTER TO USB Saves print logs in the USB memory.

A file is automatically created in the USB memory and named in the following format based on the printer model and saved date.

/ATA0/LOG/B-EX4T1_LOG_1007291030.TXT

(e.g. B-EX4T Type1, 10:30, July 29, 2010)

NOTE:

If a file with the same name already exists in the USB memory, it will be overwritten.

2.6.9 System Mode

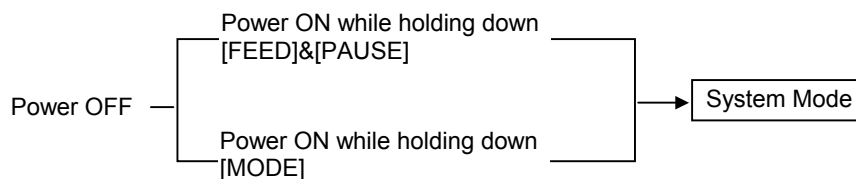
How to enter the System Mode

The System Mode consists of the following menus.

<1>DIAG. Used to check and print the printer system information and maintenance counter status.
<2>PARAMETER SET (⇒ Section 2.6.2) Used to set the parameters for each printer function.
<3>ADJUST SET (⇒ Section 2.9) Used to fine adjust the print position, cut position, print tone, etc.
<4>TEST PRINT (⇒ Section 2.8) Used to perform print tests.
<5>SENSOR ADJUST Used to check the sensor statuses and set each sensor.
<6>RAM CLEAR Used to perform a RAM clear. DO NOT USE this menu.
<7>INTERFACE (⇒ Section 2.6.10) Used to set the interface parameters.
<8>BASIC (⇒ Section 2.6.4) Used to set the function of basic program when it is loaded to the printer.
<9>FOR FACTORY Used for an in-process inspection. DO NOT USE this menu.
<10>RFID Used to set RFID related parameters.
<11>RTC (⇒ Section 2.6.11) Used to set the date and time of the real time clock, enable or disable the low battery check, and choose a real time renewal timing.
<12>Z-MODE (⇒ Section 2.6.5) Same as BASIC
<13>USB MEMORY (⇒ Section 2.6.12) Used to copy data to/from USB memory.
<14>RESET Used to reset the printer.

2.6.10 Interface Setting

The Interface menu allows configuring printer interface parameters. The following table shows the contents of the Interface menu.

SYSTEM MODE

▲	<4>TEST PRINT
	<5>SENSOR ADJUST
	<6>RAM CLEAR
▼	<7>INTERFACE

Contents of the Interface Menu

Menu	Sub menu	Parameter
Interface	NETWORK	LAN/WLAN
		SNMP
		SETTING
		BASIC INFORMATION
		IP ADDRESS
		GATEWAY ADDRESS
		SUBNET MASK
		SOCKET PORT
		PORT NUMBER
		DHCP
		DHCP CLIENT ID
		DHCP HOST NAME
		WLAN STANDARD
		WLAN MODE
		DEFAULT KEY
		802.11B CHANNEL
		802.11B BAUD
		802.11G CHANNEL
		802.11G BAUD
		WLAN POWER SAVE
		WINS
	WINS ADDRESS	
	LPR	
	USB	
	RS-232C	SPEED
		DATA LENGTH
		STOP BIT
		PARITY
		CONTROL
	CENTRO.	ACK/BUSY
		INPU PRIME
		PLUG & PLAY

2.6.10 Interface Setting (Cont.)

2.6.10.1 Network Setting

(1) LAN/WLAN

- OFF LAN and Wireless LAN are disabled.
- ON (AUTO) Automatically selected.
- ON (LAN) LAN is enabled.
- ON (WLAN) Wireless LAN is enabled.

(2) SNMP

- OFF SNMP is disabled.
- ON SNMP is enabled.

(3) BASIC INFORMATION

The following information is displayed.

IP Address
Gateway address
Subnet mask
Socket port status
Socket port number

(4) IP ADDRESS

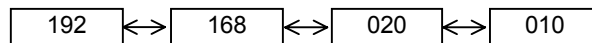

(5) GATEWAY ADDRESS

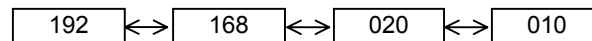

(6) SUBNET MASK

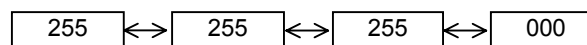

(7) SOCKET PORT

- OFF Socket port is disabled.
- ON Socket port is enabled.

2.6.10 Interface Setting (Cont.)

(8) PORT NUMBER

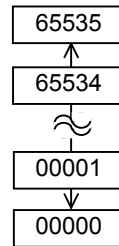

(9) DHCP

- OFF DHCP is disabled.
- ON DHCP is enabled.

(10) DHCP CLIENT ID

- ASCII DHCP client ID is entered with ASCII code. → ①
- HEX DHCP client ID is entered with Hex. code. → ②

① When ASCII is selected:
Enter 64 characters with ASCII code.

② When HEX is selected:
Enter 64 characters with Hex. code.

(11) DHCP HOST NAME

Enter 32 characters with ASCII code.

(12) WLAN STANDARD

- 11b/g
- 11b
- 11g

**2.6.10 Interface Setting
(Cont.)**

(13) WLAN MODE

This parameter is to choose the connection mode and authentication.

ADHOC	OPEN		OFF			
			WEP40			
	SHARED Not used		WEP104			
			WEP40			
INFRA	OPEN		WEP104			
			OFF			
	SHARED		WEP40			
			WEP104			
	802.1x	OPEN	TLS	WEP40		
				WEP104		
			TTLS	WEP40		
				WEP104		
			LEAP	WEP40		
				WEP104		
			PEAP	WEP40		
				WEP104		
			MD5	WEP40		
				WEP104		
			EAP-FAST	WEP40		
				WEP104		
				SHARED KEY	EAP-MD5	WEP40
						WEP104
		NETWORK EAP		WEP40		
				WEP104		
	WPA	OPEN	TLS			
			TTLS			
			LEAP			
			PEAP			
			EAP-FAST			
			NETWORK EAP			
	WPA-PSK					
	WPA2	OPEN	TLS			
TTLS						
LEAP						
PEAP						
EAP-FAST						
NETWORK EAP						
WPA2-PSK						

2.6.10 Interface Setting (Cont.)

(14) DEFAULT KEY

This parameter is to choose a WEP key.

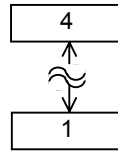

(15) 802.11b CHANNEL

This parameter is to choose a channel for 802.11b WLAN.

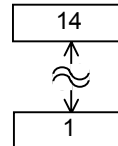

(16) 802.11b BAUD

This parameter is to choose a baud rate for 802.11b WLAN.

- 11M
- 5.5M
- 2M
- 1M

(17) 802.11g CHANNEL

This parameter is to choose a channel for 802.11g. WLAN.

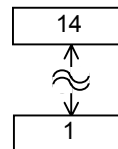

(18) 802.11g BAUD

This parameter is to choose a baud rate for 802.11g WLAN.

- 54M
- 48M
- 36M
- 24M
- 18M
- 12M
- 9M
- 6M
- 11M
- 5.5M
- 2M
- 1M

2.6.10 Interface Setting (Cont.)

(19) WLAN POWER SAVE

This parameter is to choose whether to enable the power save function while WLAN communication.

- OFF Power save function is disabled.
- ON Power save function is enabled.

(20) WINS

- OFF WINS is disabled.
- ON (MANUAL) WINS is enabled. (Manual)
- ON (DHCP) WINS is enabled. (DHCP)

(21) WINS ADDRESS

The WINS address is displayed.

(22) LPR

- OFF LPR is disabled.
- ON LPR is enabled.

2.6.10.2 USB

(1) USB SERIAL ID

- OFF USB serial ID is disabled.
- ON USB serial ID is enabled.

2.6.10.3 RS-232C

(1) SPEED

- 2400 bps
- 4800 bps
- 9600 bps
- 19200 bps
- 38400 bps
- 115200 bps

2.6.10 Interface Setting (Cont.)

(2) DATA LENGTH

- 8 bits
- 7 bits

(3) STOP BIT

- 1 bit
- 2 bits

(4) PARITY

- NONE
- EVEN
- ODD

(5) CONTROL

- XON+READY AUTO XON/XOFF mode
- XON+XOFF AUTO XON/XOFF+READY/BUSY mode
- READY/BUSY RTS RTS mode
- XON+XOFF XON/XOFF mode
- READY/BUSY READY/BUSY mode

2.6.10.4 CENTRO.

(1) ACK/BUSY

This parameter is to choose an ACK/BUSY timing.

- TYPE1 A rise of ACK signal and a release of BUSY occur at the same time.
- TYPE2 A fall of ACK signal and a release of BUSY occur at the same time.

(2) INPUT PRIME

This parameter is to choose whether to enable a rest operation when INIT signal is ON.

- OFF
- ON

(3) PLUG & PLAY

- OFF
- ON

2.6.11 Real Time Clock (RTC)

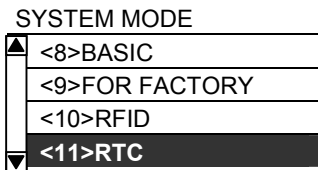

The RTC menu allows setting the date and time, enabling the battery check function, and selecting the RTC data renewal timing while printing.

The Real Time Clock Setting is effective only when an optional RTC & USB Host Interface Card, B-EX700-RTC-QM-R, is installed.

(1) DATE TIME

This parameter is to set date and time.

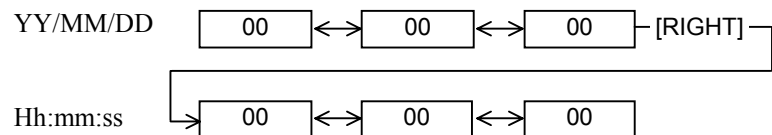

(2) BATTERY CHECK

This parameter is to choose whether or not to enable the low battery check function.

- OFF
- ON

(3) RENEWAL

This parameter is to choose when date and time are updated while printing.

- BATCH As the real time clock data is read only for the first media in a batch the same time is printed on the all media.
- PAGE As the real time clock data is read at the start of printing each media, a real time can be printed on each media.

2.6.12 Copying Data to/from USB Memory

SYSTEM MODE

▲	<10>RFID
	<11>RTC
	<12>Z-MODE
▼	<13>USB MEMORY

The USB Memory menu allows copying data from a USB memory to the printer and saving data from the printer to a USB memory.

USB memory can be used only when an optional RTC & USB Host Interface Card, B-EX700-RTC-QM-R, is installed.

(1) USB TO PRINTER

This parameter is to copy data from a USB memory to the printer.

- **COPIED DATA** Data including firmware (BOOT/MAIN/CG/KANJI/HTML), storage area information, and parameter settings
- **CONFIG FILE** File containing firmware (BOOT/MAIN/CG/KANJI/HTML)

1. When the file selection screen is displayed, choose a file to be copied.
2. The confirmation message is displayed.
3. The data is read from the USB memory. It takes 3 to 5 minutes to read all information.

(2) PRINTER TO USB

This parameter is to save the firmware (BOOT/MAIN/CG/KANJI/HTML), storage area information, and parameter settings to a USB memory.

- ALL

1. The confirmation message is displayed.
2. The data is copied to the USB memory. It takes approx. 40 seconds to save all information.

A file is automatically created in the USB memory and named in the following format based on the printer model and saved date.

/ATA0/SYSTEM/B-EX4T1-T1105.DAT
(e.g. B-EX4T Type1, 305 dpi model, November 5)

NOTE:

If a file with the same name already exists in the USB memory, it will be overwritten.

2.7 Installing the Printer Drivers

2.7.1 Introduction

This chapter describes how to install the TOSHIBA printer driver for the TOSHIBA bar code printer on your Windows host computer; install and delete the printer driver, the procedure for adding the LAN port, cautions and limitations.

2.7.2 General Description

(1) Features

Once you install the TOSHIBA printer driver on your Windows host computer, you can use the TOSHIBA bar code printer, as well as the easy-to-use general printers.

You can use this printer by connecting a USB cable, or a LAN cable to your host computer.

(2) System Requirements

To install the TOSHIBA printer driver on your host computer, the following system and environment are required:

- Operating system: Windows 2000, Windows XP, Windows Server 2003, Windows Vista, Windows Server 2008, Windows 7 or Windows Server 2008 R2
- Hardware: A DOS-/V (IBM PC/AT compatible) machine running an above operating system.
- Interface:
 - USB interface
 - LAN interface

2.7.3 Installing the Printer Driver

The installation procedure of this printer driver differs depending on the printer models and the connection methods. Follow the procedure for the appropriate condition to install the printer driver.

If the older version of this printer driver has been already installed, be sure to uninstall it first, restart the printer, and install the latest printer driver. See **Section 2.7.10 Uninstalling the Printer Driver**.

■ Installation method for each operating system

OS	Connection method	
	Plug and Play is not used. LAN	Plug and Play is used. USB
Windows 2000	Section 2.7.5 Installation under Windows 2000/XP/Server2003	Section 2.7.7 Installation under Windows 2000 (USB interface with plug and play enabled)
Windows XP		Section 2.7.8 Installation under Windows XP/Server2003 (USB interface with plug and play enabled.)
Windows Server 2003		
Windows Vista	Section 2.7.6 Installation under Windows Vista/Server2008/7	Section 2.7.9 Installation under Windows Vista/Server2008/7 (USB connection with plug and play enabled)

2.7.4 Preparation for Installation

- (1) Access Toshiba TEC web site at the following address and download the printer driver install file “TPCL72M2E.exe” to the local disc.

http://www.toshibatec-ris.com/products/barcode/download/driver_agreement.html

Note: If you do not agree with the Software License Agreement, you cannot download the file.

- (2) Double-click the downloaded “TPCL72M2E.exe”, and the “TPCL PRINTER DRIVER – InstallShield Wizard” is displayed. Click the [Next] button.

Note: Log on as the user with administrative privilege.

When the User Account Control screen is displayed under Windows Vista/Server2008/7/Server2008R2, click on the “Allow”.

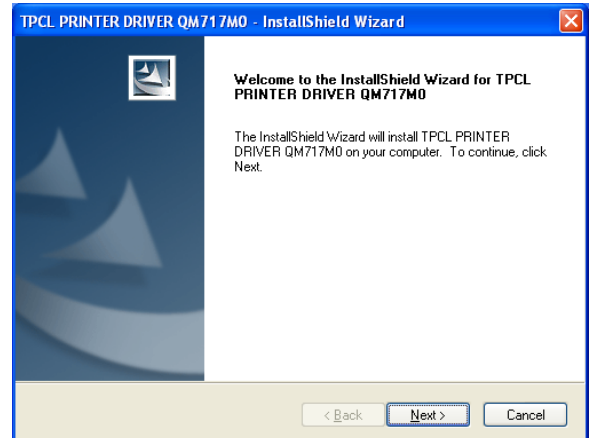
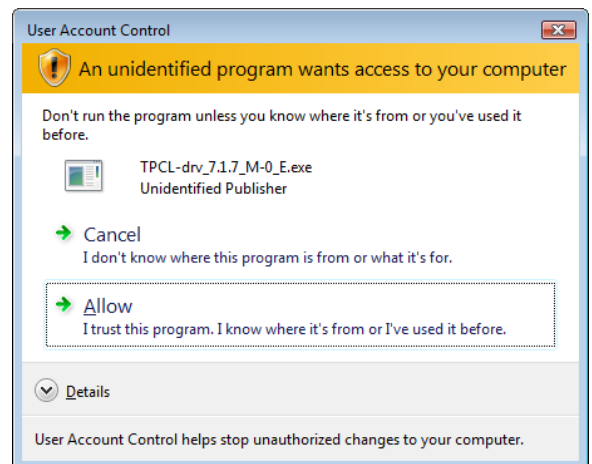

- (3) The “Software License Agreement” is displayed. Select “I accept the terms of the license agreement” and click the [Next] button.

Note: If you do not agree with the Software License Agreement, you cannot download the file.

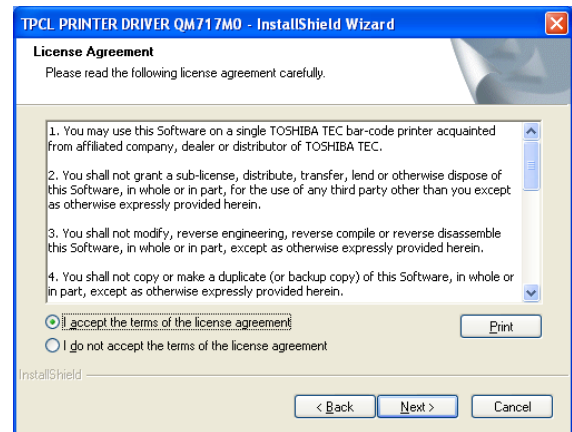

- (4) When you click the [Install] button, the printer driver install file is created in “C:\TEC_DRV”.

Note: The folder name cannot be changed from “C:\TEC_DRV”.

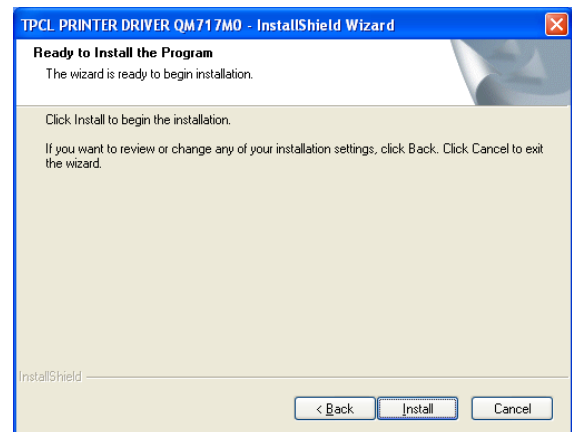

- (5) When the installation is completed, click the [Finish] button.

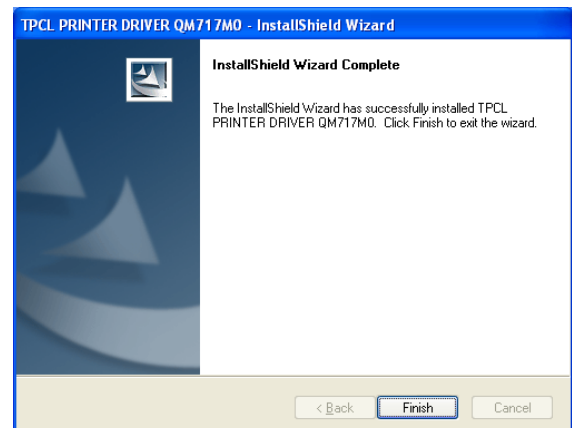

Note: In the case of Windows Vista/Server2008/7/Server2008R2, the screen on the right will appear. Click the “Install this driver software anyway”.

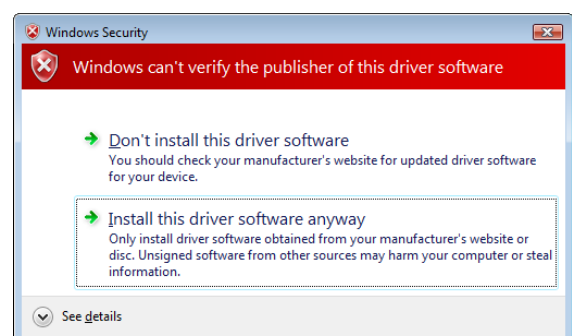

2.7.5 Installation under Windows 2000/XP/Server2003

- (1) Turn on the PC.

Note: Log on as the user with administrative privilege.

- (2) Select the “Start”, “Printer and FAX” to show the printer folder.

Supplement: In the case of Windows 2000, select “Start”, “Setting”, and “Printer”. If the “Printer and FAX” folder is not found, click the “Control Panel” and select the “Printer and FAX”. In the case of the category view, click the “Printer and Other Hardware” and select the “Printer and FAX”.

- (3) Select the “Add printer” from the File menu. The “Add Printer Wizard” is displayed.

- (4) Click the [Next] button in the “Add Printer Wizard”.

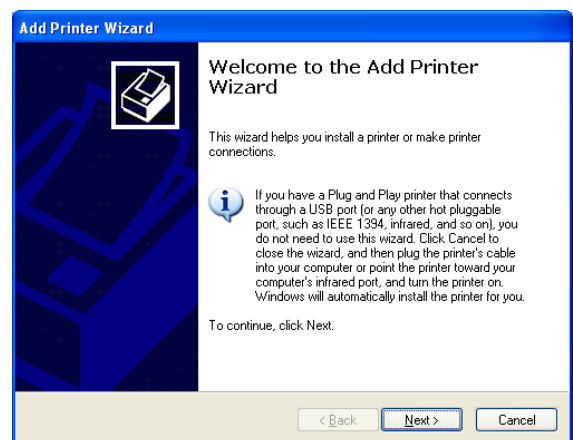

- (5) Select the “Local printer attached to this computer” and click the [Next] button.

Note: Do not check the “Automatically detect and install my Plug and Play printer” checkbox.

Even in the case of specifying the network printer or a printer connected to other PC, be sure to choose the local printer in this step. This setting is changed after the installation is completed.

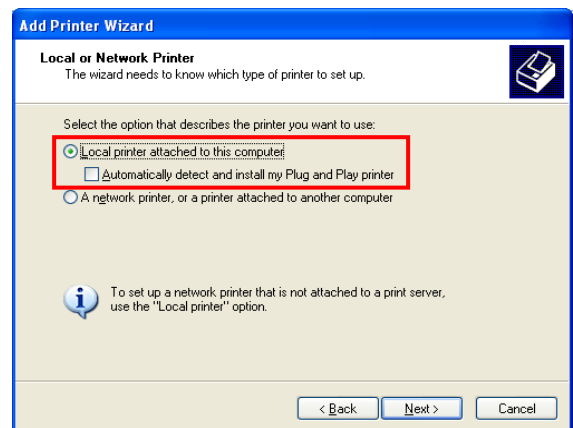

- (6) Specify a printer port and click the [Next] button.

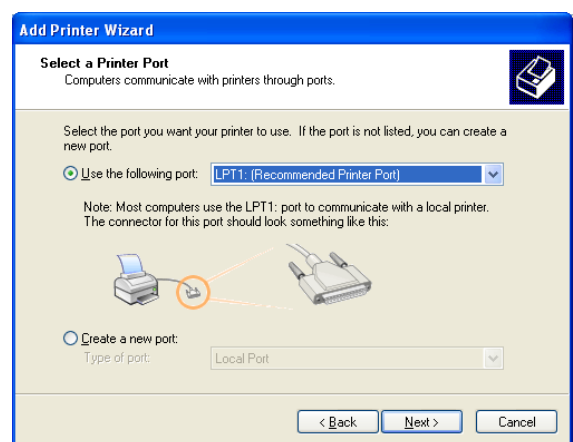

- (7) When the “Install Printer Software” screen appears, click the [Have Disk] button.

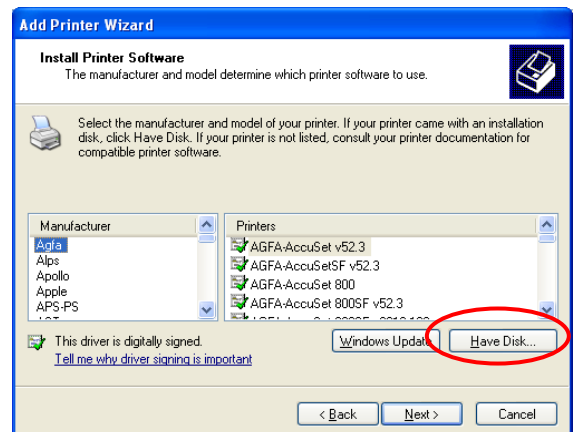

- (8) Specify the printer driver install folder (C:/TEC_DRV) created in **Section 2.7.4 Preparation for Installation**, and click the [Open] button. Select the “TEC.inf” and click the [OK] button.

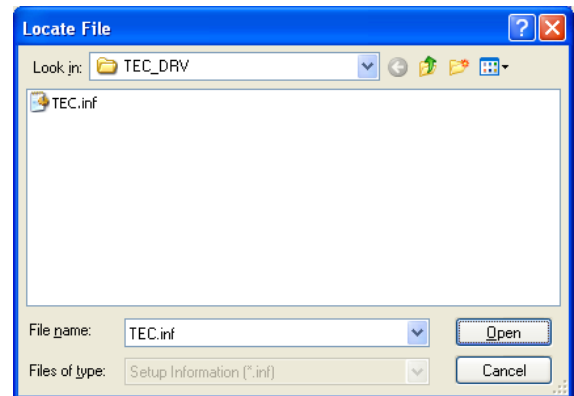

- (9) The list of the installable printer is displayed.

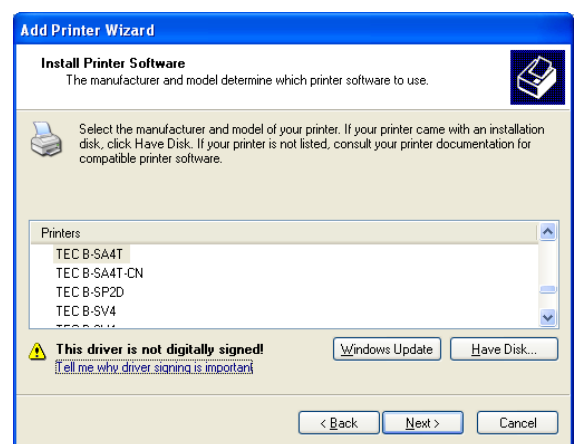

- (10) Select the model to be installed, and click the [Next] button.
(Example: B-SA4T)

- (11) Select the “Replace existing driver”, and click the [Next] button.

Supplement: This step will be omitted when the printer driver is installed for the first time.

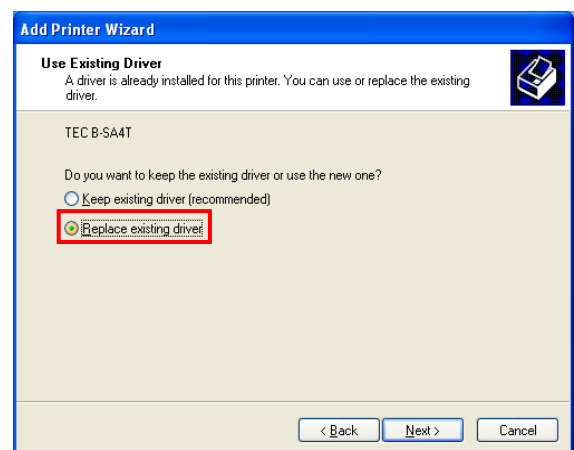

- (12) Select whether or not to use the printer as a default printer, then click the [Next] button.

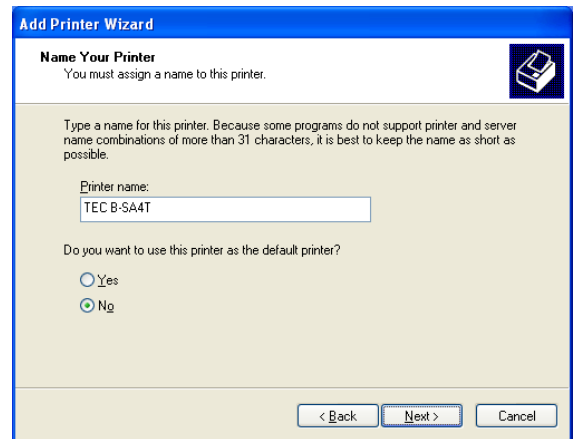

The screenshot shows the 'Add Printer Wizard' dialog box with the title 'Name Your Printer'. The subtitle reads 'You must assign a name to this printer.' Below this, there is a text box labeled 'Printer name:' containing the text 'TEC B-SA4T'. A question follows: 'Do you want to use this printer as the default printer?' with two radio buttons: 'Yes' (unselected) and 'No' (selected). At the bottom right, there are three buttons: '< Back', 'Next >', and 'Cancel'.

- (13) Select whether or not to share the printer with other users on the network, then click the [Next] button.

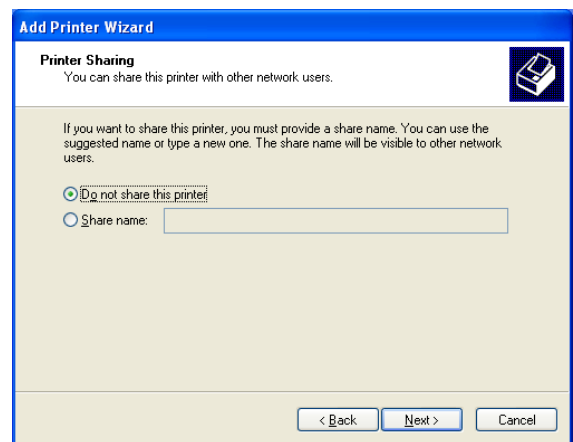

The screenshot shows the 'Add Printer Wizard' dialog box with the title 'Printer Sharing'. The subtitle reads 'You can share this printer with other network users.' Below this, there is a text box labeled 'Share name:' which is empty. A question follows: 'Do you want to share this printer?' with two radio buttons: 'Do not share this printer' (selected) and 'Share name:' (unselected). At the bottom right, there are three buttons: '< Back', 'Next >', and 'Cancel'.

- (14) Select whether or not to perform a print test, then click the [Next] button.

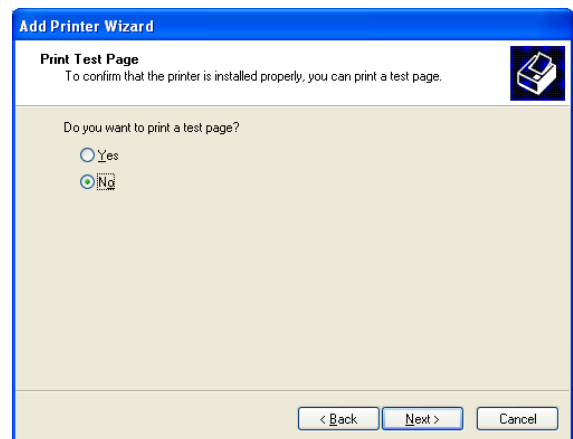

The screenshot shows the 'Add Printer Wizard' dialog box with the title 'Print Test Page'. The subtitle reads 'To confirm that the printer is installed properly, you can print a test page.' Below this, there is a question: 'Do you want to print a test page?' with two radio buttons: 'Yes' (unselected) and 'No' (selected). At the bottom right, there are three buttons: '< Back', 'Next >', and 'Cancel'.

- (15) When the “Completing the Add Printer Wizard” is displayed, click the [Finish] button.

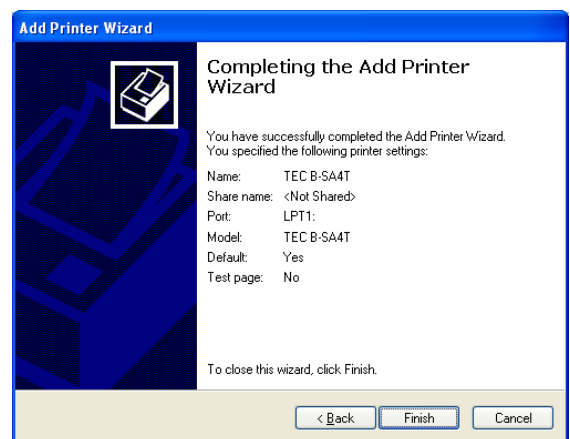

- (16) When the screen on the right appears, click the [Continue Anyway] button.

Note: “Digital Signature Not Found” message may be displayed. In that case, click the [Yes] button.

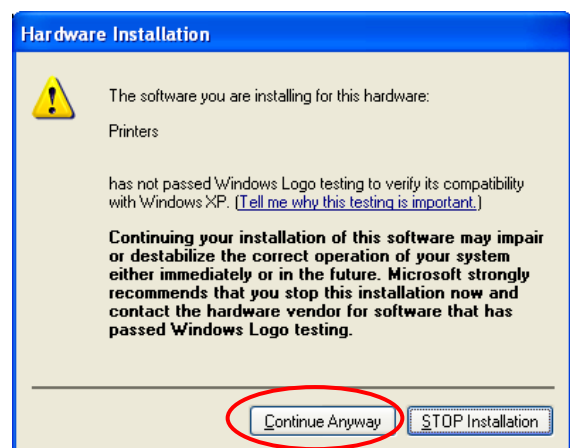

- (17) Installation of the printer driver starts.

- (18) When the installation is completed, a new printer icon will be added to the “Printer” folder.

2.7.6 Installation under Windows Vista/Server2008/7/Server2008R2

- (1) Turn on the PC.

Note: Log on as the user with administrative privilege.

- (2) Select “Start”, “Control Panel”, “Hardware and Sound”, and “Printer” to open the printer folder.

Supplement: Entering “Printer” in the Search box of the Start menu causes the “Printer” to be shown in the Program.

- (3) Click the “Install a Printer” to start adding a printer.

- (4) Select the “Add a local printer”.

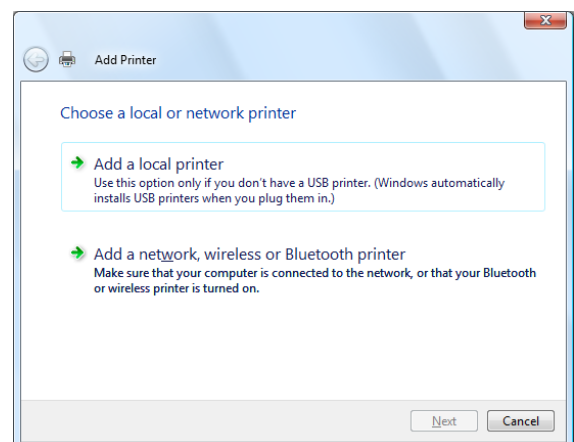

- (5) Select a printer port, and click the [Next] button.

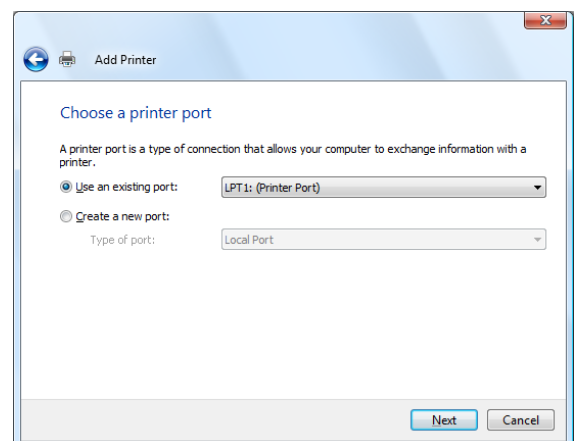

- (6) When the screen on the right appears, select “TEC” from the Manufacturer list.

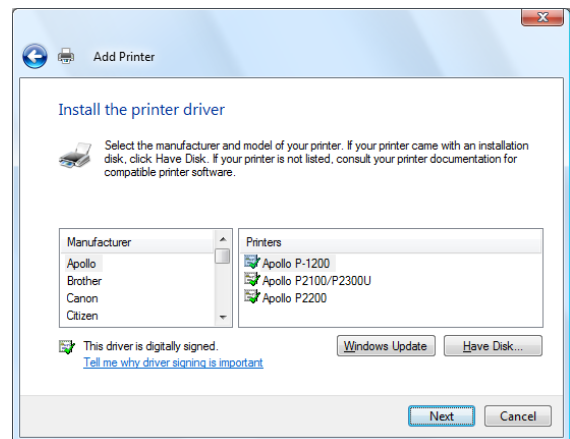

- (7) The list of the installable printer models are displayed.

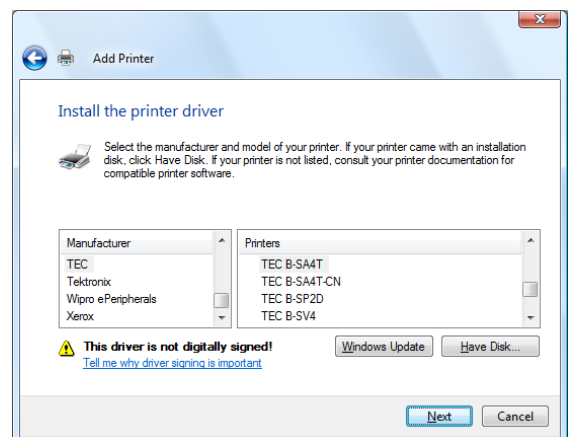

- (8) Select a model to be installed, then click the [Next] button.

- (9) Select the “Replace the current driver”, and click the [Next] button.

Supplement: This step will be omitted when the printer driver is installed for the first time.

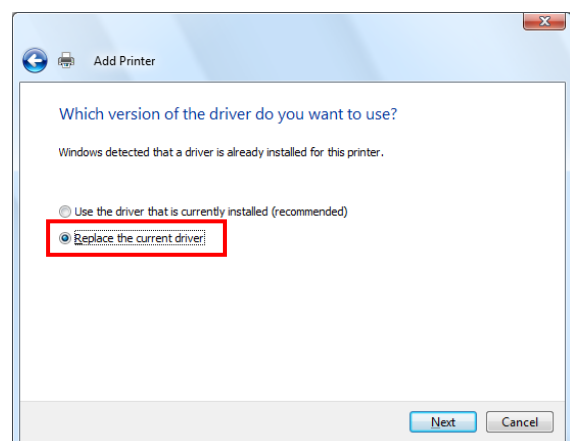

- (10) Select whether or not to use the printer as a default printer, then click the [Next] button.

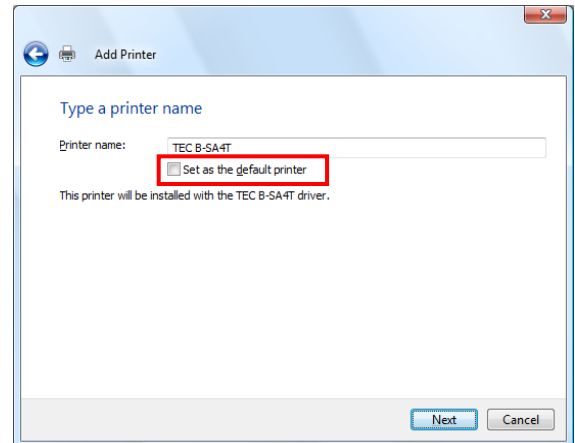

- (11) Installation starts.

- (12) When the installation is completed, the “Add Printer” screen is displayed. At this time, a new printer icon is added to the “Printer” folder. Click the [Finish] button.
If you want to perform a print test, click the [Print a test page] button.

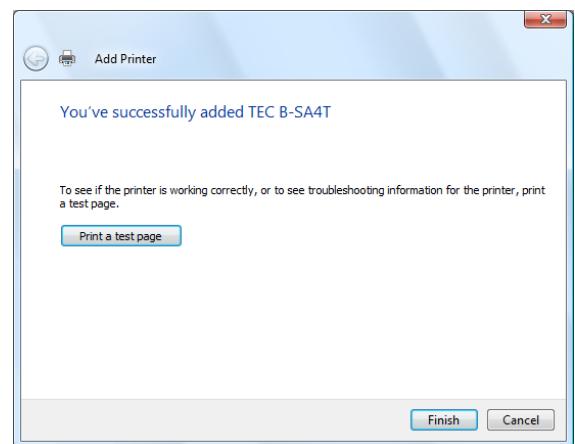

2.7.7 Installation under Windows 2000 (USB with Plug & Play Enabled)

- (1) Turn on the PC.

Note: Log on as the user with administrative privilege.

- (2) Turn on the printer and connect it to the PC with a USB cable.

- (3) “USB DEVICE” is detected and “USB Print support” is automatically installed.

- (4) After a while, the “Found New Hardware Wizard” is displayed. Click the [Next] button.

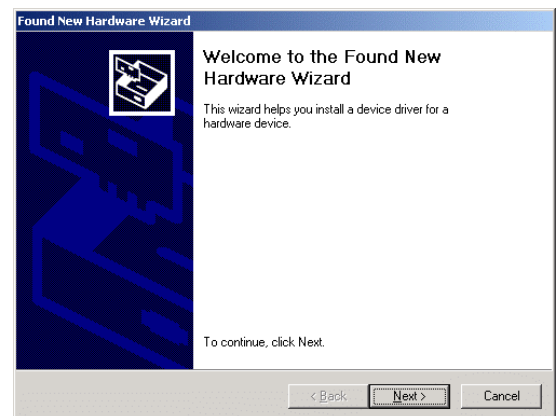

- (5) Select the “Search for a suitable driver for my device (recommended)”, and click the [Next] button.



- (6) Check the “Specify a location” checkbox, then click the [Next] button.

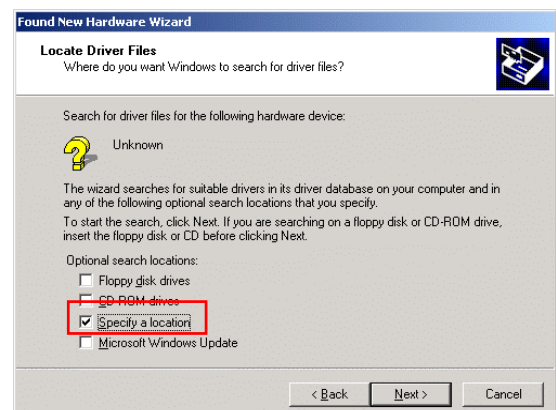

- (7) Click the [Browse] button. Specify the folder (C:\TEC_DRV) created in **Section 2.7.4**, and click the [Next] button.



- (8) Make sure the driver of this device has been detected, then click the [Next] button.

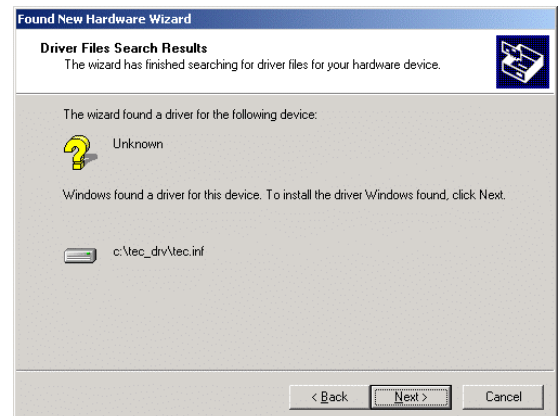

- (9) When the screen on the right is displayed, click the [Yes] button.

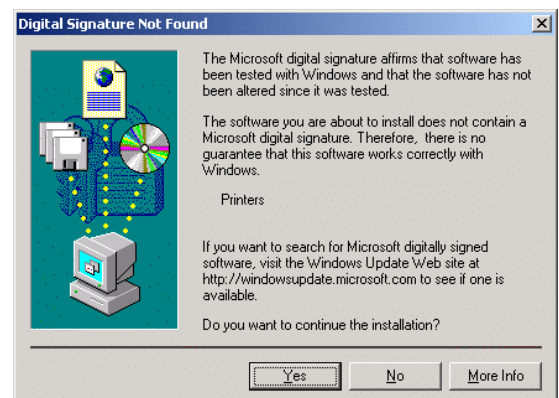

- (10) When the “Completing the Found New Hardware Wizard” is displayed, click the [Finish] button.



- (11) When the installation is completed, a new printer icon is added to the Printer folder.

2.7.8 Installation under Windows XP/Server2003 (USB with Plug & Play enabled)

- (1) Turn on the PC.

Note: Log on as the user with administrative privilege.

- (2) Turn on the printer, and connect it to the PC with a USB cable.

- (3) “USB DEVICE” is detected, and the “USB Print Support” is automatically installed.

- (4) After a while, new devices are detected.

- (5) When the “Found New Hardware Wizard” is displayed, select “Install from a list or specific location [Advanced]” and click the [Next] button.

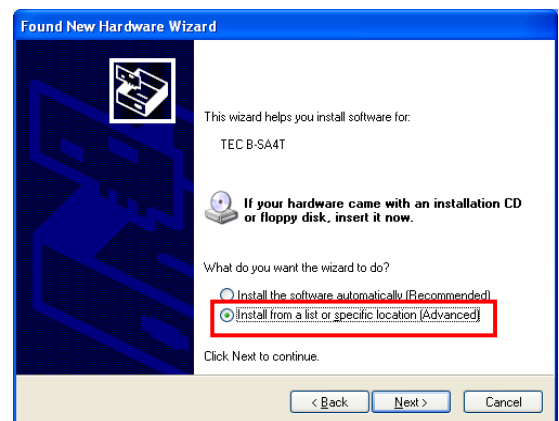

- (6) Select the “Search for the best driver in these locations”, check the “Include this location in the search” checkbox, and click the [Browse] button. Specify the folder (C:\TEC_DRV) created in **Section 2.7.4**, and click the [Next] button.

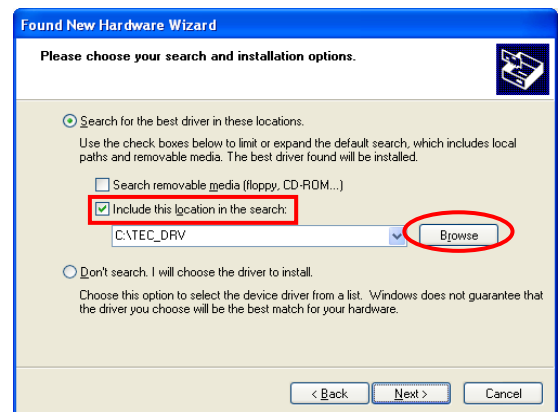

- (7) When the screen on the right appears, click the [Continue Anyway] button.

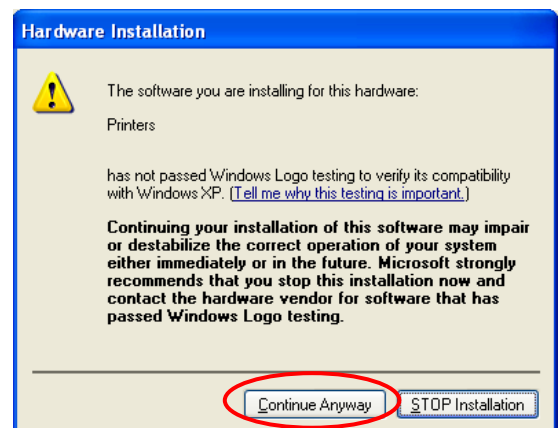

- (8) When the “Completing the Found New Hardware Wizard” is displayed, click the [Finish] button.

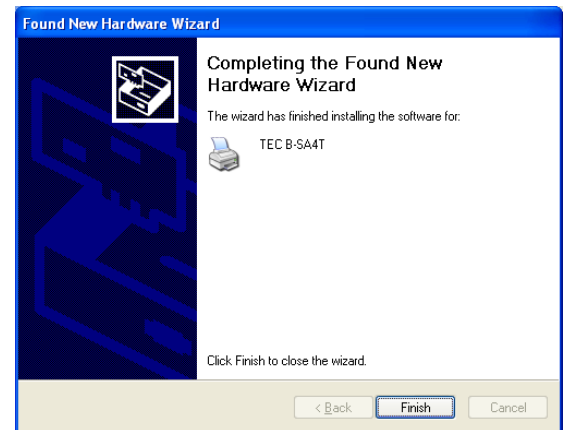

- (9) When the installation is completed, a new printer icon is added to the Printer folder.

2.7.9 Installation under Windows Vista/Server 2008/7/Server2008R2 (USB with Plug & Play Enabled)

- (1) Turn on the PC.

Note: Log on as the user with administrative privilege.

- (2) Turn on the printer and connect it to the PC with a USB cable.
- (3) Installation of the device driver software is automatically started.
- (4) After a while, the printer driver installation is completed.
- (5) When the installation is completed, a new printer icon is added to the Printer folder.

2.7.10 Uninstalling the Printer Driver

1) To delete the printer drivers except for V6.5 Build75 and V6.5 Build77

In the following cases, be sure to uninstall the printer driver using the procedure below.

- When the same version is installed again.
- When an older version has been already installed.
- When the installation is canceled on the way or when the [No] is selected at a confirmation of the digital signature.
- When the printer driver cannot be installed for some reason.

Notes: 1. When installing the printer driver with Plug & Play enabled, turn OFF the printer first.
2. When the printer driver is deleted, the information of the registered stocks and bar codes are also deleted. This information can be saved in a file beforehand by using the export function, and restored by using the import function after re-installation of the printer driver.

● Deleting the printer drivers except for V7.2 M-2

Before deleting the printer driver except for V7.2 M-2, follow the procedure described in **Section 2.7.4 Preparation for Installation**. Doing this causes the previously installed printer driver to be updated and creates the shortcut of the Driver Wizard in the TPCL Printer Driver of TOSHIBA TEC folder.

However, it is not possible to update the printer driver which is older than V6.9.3 M-0. For such versions, first delete "C:\TEC_DRV" folder, then conduct the Preparation for Installation. When the preparation is completed, the shortcut of the "Driver Wizard" is created in the TPCL Printer Driver folder.

● How to uninstall the printer driver

- (1) Select the "Start", "All programs", "TOSHIBA TEC", "TPCL Printer Driver", and "Driver Wizard".

Note: Log on as the user with administrative privilege.

Exit the all Windows applications before performing the above operation. Confirm that there is no print job in the spooler, then close the spooler and the printer folder.

In the case of Windows Vista/Server 2008/7/Server2008R2, the User Account Control screen may appear. In that case, click the [Allow].

- (2) Select the "Remove printer drivers", and click the [Next] button.

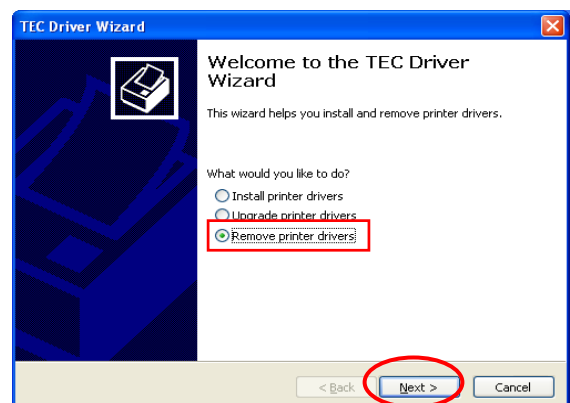
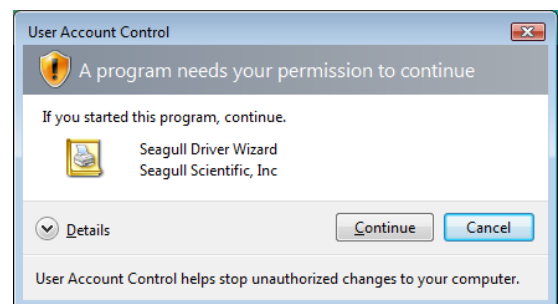

- (3) Select the “Automatically remove all TEC Printer Drivers”, and click the [Next] button.

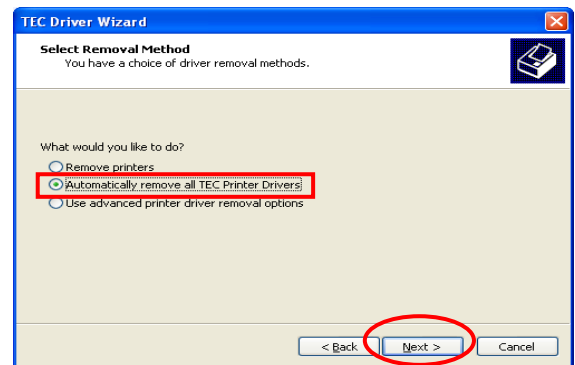

- (4) Click the [Finish] button to start to delete the printer drivers.

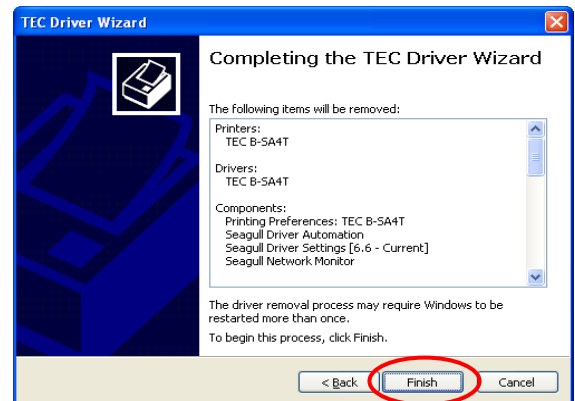

- (5) When the “Restart System” screen is displayed, click the [Restart] button.

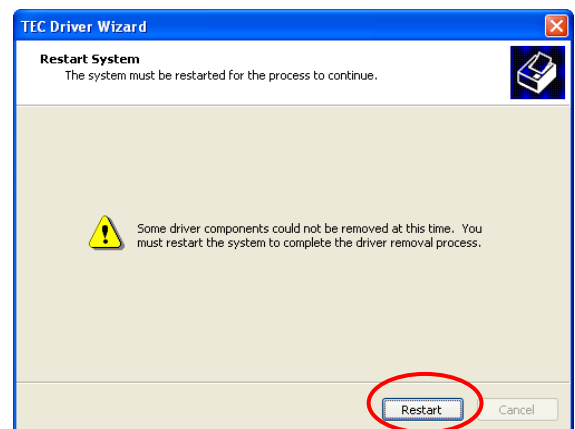

- (6) When the printer driver is deleted successfully, the screen on the right is displayed.

Note: If the deletion of the printer driver failed, retry from Steps 1 to 5 until the deletion succeeds.

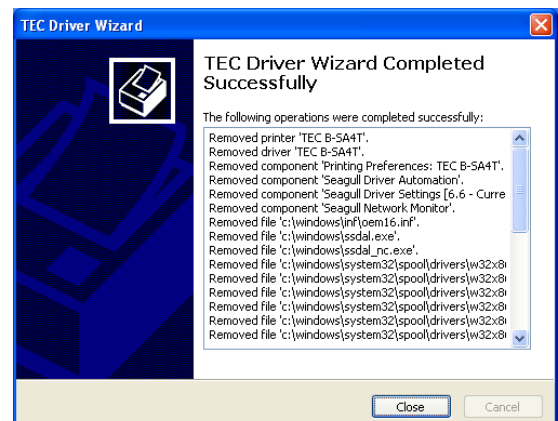

Note: In the case a network printer has been installed in multiple user accounts under Windows

Vista/server 2008/7/Server2008R2, it is not possible to delete the printer driver. First, delete the printer icon from each user account, then delete the printer driver.

● **Deleting the setup information configured during the preparation**

- (1) Select the “Start”, “Control Panel”, and “Add/Remove Programs”.

Note: Log on as the user with administrative privilege.

- (2) Select the “TPCL Printer Driver Vx.x (version)” or “TEC Printer Driver Install file” from the list, then click the [Delete] button.
- (3) When the confirmation message is displayed, click the [Yes] button.
- (4) When the “Uninstall completed” screen appears, click the [Finish] button.

2) To delete the V6.5 Build75 or V6.5 Build77

- (1) Select the “Start”, “Control Panel”, and “Add/Remove Programs”.

Note: Log on as the user with administrative privilege.

- (2) Select the “TEC **** printer” from the “Edit/Remove Programs”, and click the [Add and delete]. (**** indicates a printer model name. For example, B-SA4T, etc.)
- (3) Confirm that the selected file in the “File Delete confirmation” window is correct, then click the [Yes] button.
- (4) When “Uninstall completed” is displayed, click the [OK] button.

Note: If you deleted the printer icon without performing Steps 1 to 4 above, delete the setup information through the “Add/Remove Programs” after re-installing the printer driver.

- (5) When the deletion is completed, reboot the PC.

2.8 Print Test

After your operating environment has been set, perform a print test.

1. Perform a print test by using the Printer Driver or an Issue Command.

The printer driver's Properties screen allows you to set the communication conditions, media size, and other printing conditions in accordance with your operating environment. For details, refer to the **Help for the Windows Printer Drivers** screen.

Example: Stock tab display of the Printer Driver's Properties Screen

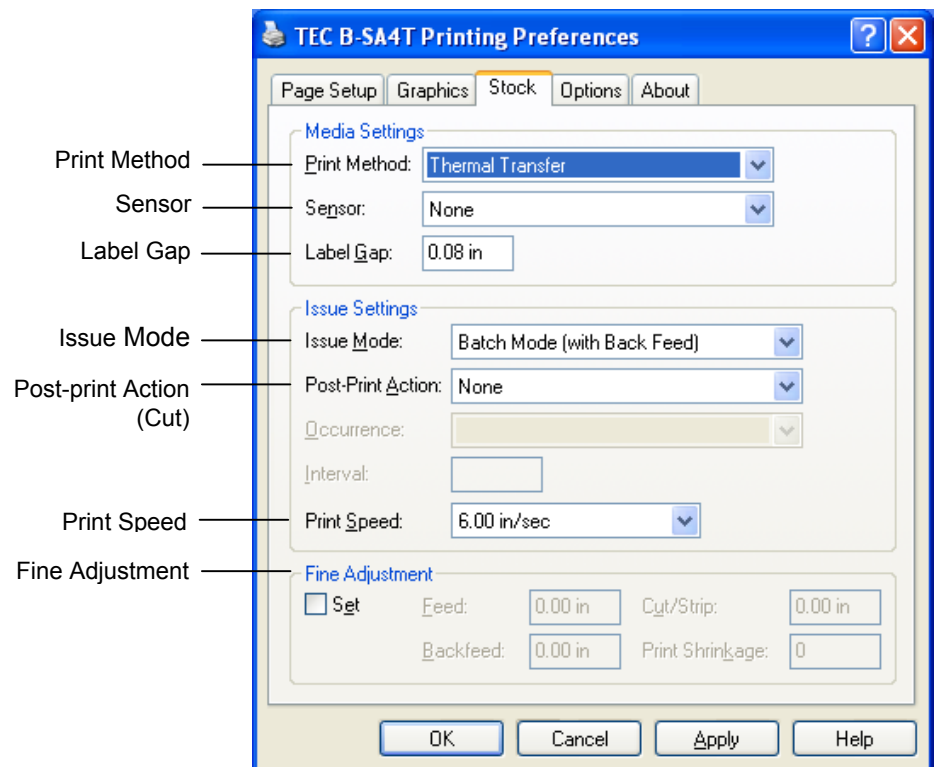

- Print Method: Direct thermal or thermal transfer is selectable.
- Sensor: Media sensor type is selectable.
- Issue Mode: Batch, strip or cut is selectable.
- Post-print Action: Whether to use the cutter or not is selectable.
- Fine Adjustment: Adjustment values for the feed amount, cut/strip position, etc. can be set.

2. Confirm the print test result.

- When a print start position, cut/strip position, or print tone needs to be adjusted: ⇒ **Section 2.9 Position and Print Tone Fine Adjustment**
- When pre-printed media is used, and if a print start position is not properly detected: ⇒ **Section 2.10 Threshold Setting**

2.8 Print Test (Cont.)

■ When using a Strip Module or an optional Cutter Module

It is necessary to set the issue mode, cut/strip position, etc. on the Printer Driver or with TPCL (TEC Printer Command Language) in accordance with your printing condition.

For details of the TPCL, refer to the **B-EX4T/EX6T Series External Equipment Interface Specification**.

Regarding how to use the Printer Driver, refer to the **Help for the Windows Printer Drivers** screen.

To gain maximum performance and life from the Cutter Module or Strip Module, periodic cleaning is required.

Before starting a cleaning, be sure to TURN OFF the printer to avoid risk of injury.

For details of cleaning, refer to **Section 4.1.3 Optional Cutter Module**.

2.9 Position and Print Tone Fine Adjustment

This section describes how to fine adjust a print start position, cut/strip position, reverse feed amount, print tone, and ribbon motor torque. When a fine adjustment is required, follow the procedure below.

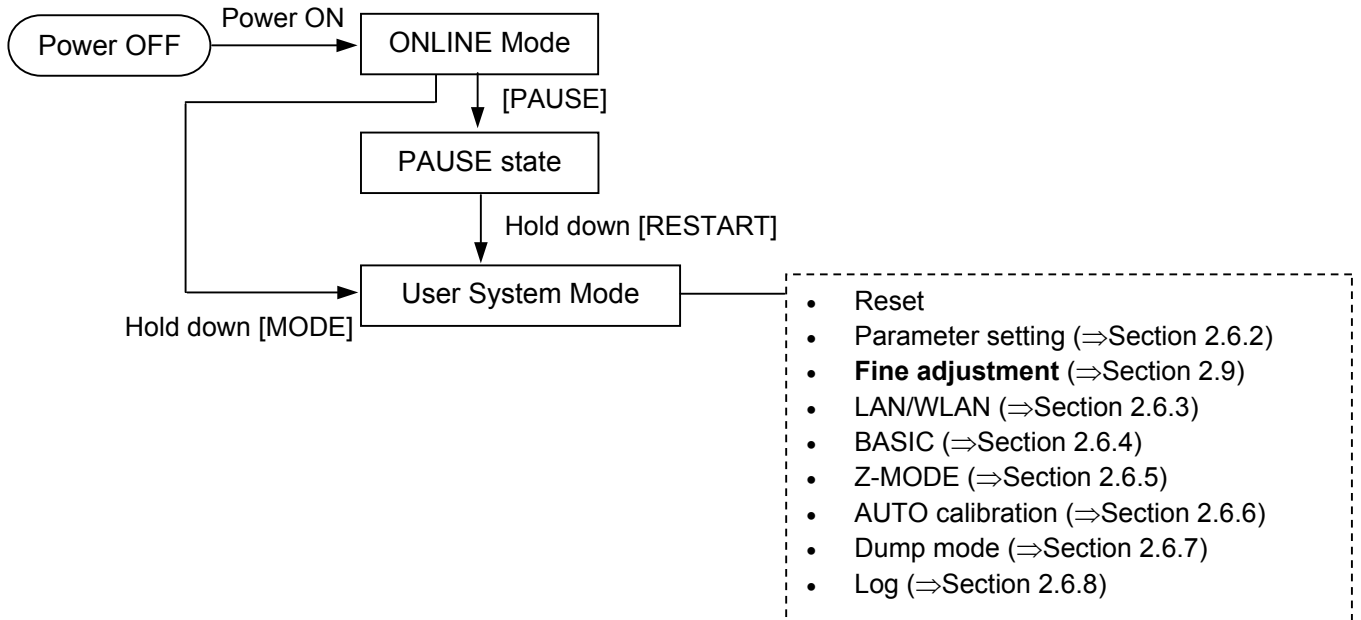

2.9.1 Fine Adjustment

USER SYSTEM MODE	
▲	<1>RESET
	<2>PARAMETER SET
	<3>ADJUST SET
▼	<4>LAN/WLAN

Contents of the Fine Adjustment Menu

Menu	Parameter	
Adjust set	FEED ADJ.	Adjusts the feed amount to the print start position
	CUT ADJ.	Adjusts the cut or strip position.
	BACK ADJ.	Adjusts the reverse feed amount.
	X ADJUST	Adjusts the print position in X coordinate (horizontal direction)
	TONE ADJ. (TRANS.)	Adjusts the print tone for thermal transfer printing.
	TONE ADJ. (DIRECT)	Adjusts the print tone for direct thermal printing.
	RBN ADJ. <FW>	Adjusts the ribbon take-up motor drive voltage.
	RBN ADJ. <BK>	Adjusts the ribbon feed motor drive voltage.
	THRESHOLD <REFL.>	Sets a fine adjustment value for the threshold for the reflective sensor.
	THRESHOLD <TRANS.>	Sets a fine adjustment value for the threshold for the transmissive sensor.

NOTE:

The printer driver's properties screen also has Parameter Fine Adjustment menu.

2.9.1 Fine Adjustment(Cont.)

(1) FEED ADJ.

Print start position is shifted by fine adjusting the feed amount.

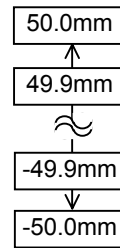

• Example of Print Start Position Fine Adjustment

When setting +3.0 mm

Compared with “+0.0mm” position, the print start position is shifted forward.

When setting +0.0 mm

When setting -3.0 mm

Compared with “+0.0mm” position, the print start position is shifted backward.

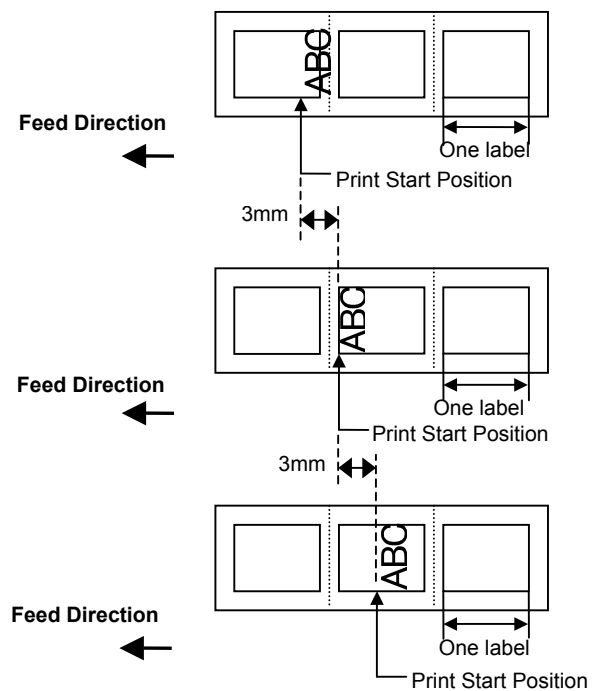

2.9.1 Fine Adjustment(Cont.)

(2) CUT ADJ.

Cut position or peel-off position is shifted by fine adjusting the feed amount.

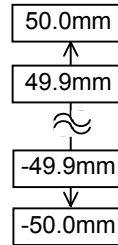

• Example of Cut Position Fine Adjustment

When setting +3.0 mm

Compared with “+0.0mm” position, the cut position is shifted forward.

When setting +0.0 mm

When setting -3.0 mm

Compared with “+0.0mm” position, the cut position is shifted backward.

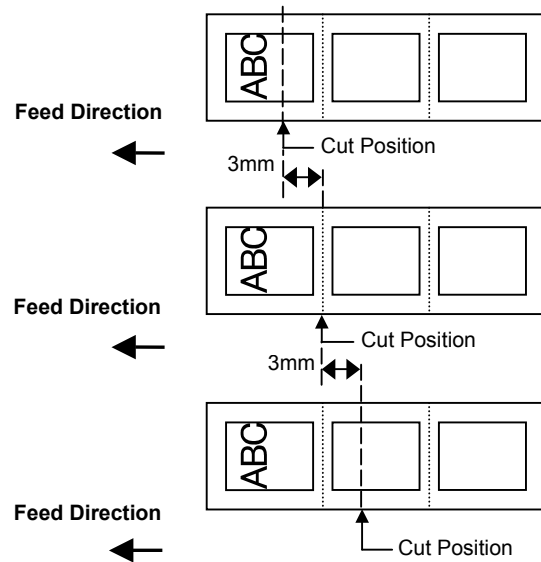

• Example of Peel-off Position Fine Adjustment

When setting +3.0 mm

Compared with “+0.0mm” position, the peel-off position is shifted forward.

When setting +0.0 mm

When setting -3.0 mm

Compared with “+0.0mm” position, the peel-off position is shifted backward.

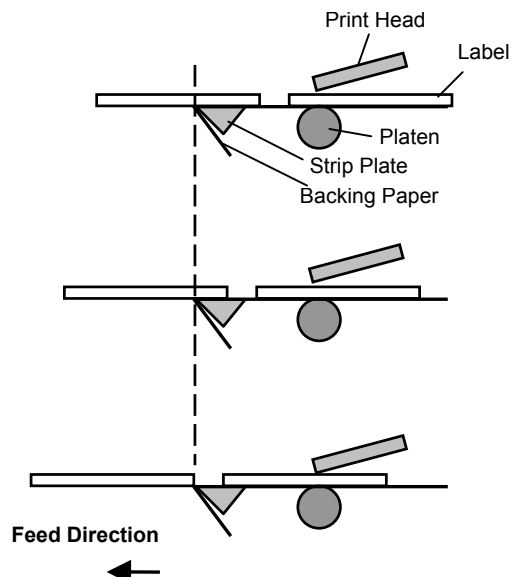

2.9.1 Fine Adjustment(Cont.)

(3) BACK ADJ.

Reverse feed amount to the next print start position is fine adjusted.

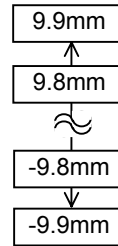

• Example of Reverse Feed Amount Fine Adjustment

When setting +3.0 mm

Compared with “+0.0mm” position, the print start position after a reverse feed is shifted forward.

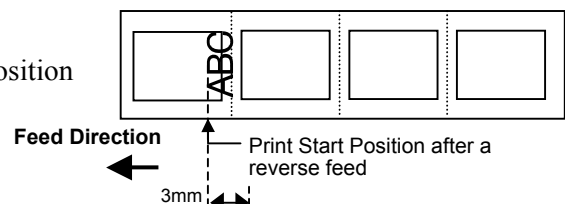

When setting +0.0 mm

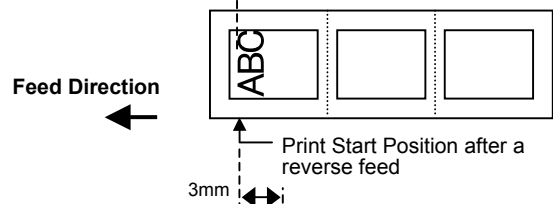

When setting -3.0 mm

Compared with “+0.0mm” position, the print start position after a reverse feed is shifted backward.

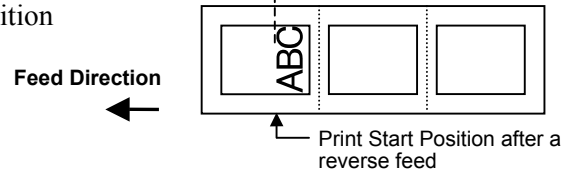

NOTE:

Depending on the print conditions, a label may not return to the home position with a reverse feed, even if a reverse feed amount is specified to the same length as the forward feed.

On the following conditions, the media may not return to the home position, resulting in an error.

- The media sensor is used.
- The media pitch is almost the same as the distance between the print head and the media sensors (75.5 mm.)
- A printer action includes a reverse feed (such as cut issues, strip issues, and automatic forward feed standby.)

To prevent an error from occurring, the reverse feed amount needs to be increased by performing the back feed fine adjustment in the positive (+) direction.

2.9.1 Fine Adjustment(Cont.)

(4) X ADJUST

Print position in X-coordinate (horizontal direction) is fine adjusted.

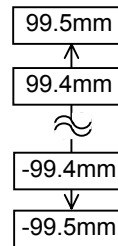

• Example of X Coordinate Fine Adjustment

When setting -50.0 mm

Compared with “+0.0mm” position, the print position is shifted to the left.

When setting +0.0 mm

When setting +50.0 mm

Compared with “+0.0mm” position, the print position is shifted to the right.

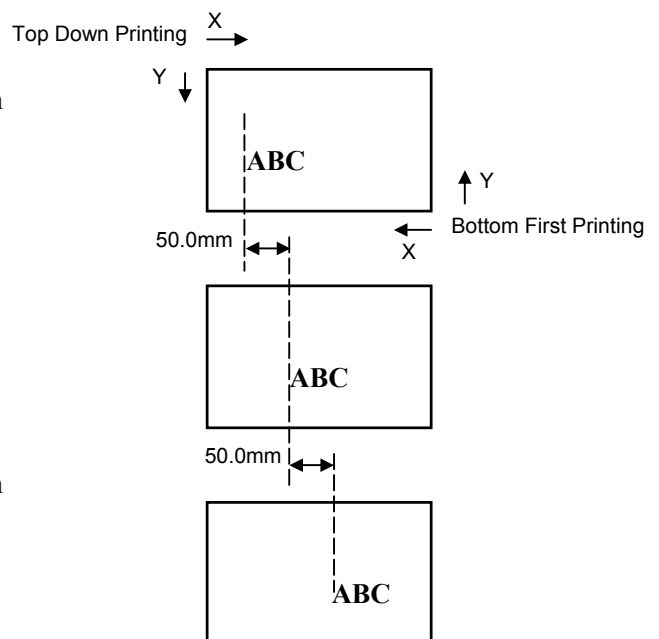

2.9.1 Fine Adjustment(Cont.)

(5) TONE ADJ.(TRANS.)

Print tone for the thermal transfer printing is fine adjusted.

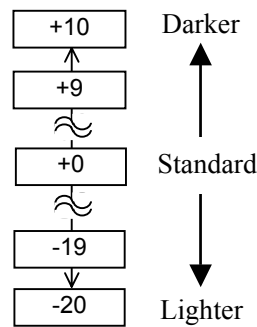

(6) TONE ADJ.(DIRECT.)

Print tone for the direct thermal printing is fine adjusted.

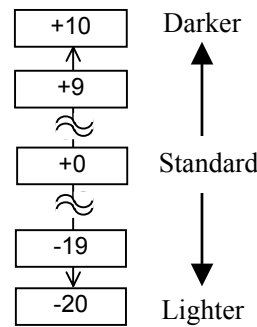

(7) RBN ADJ.<FW>

When the ribbon is slack or wrinkled and printing is affected, fine adjust the ribbon motor torque.

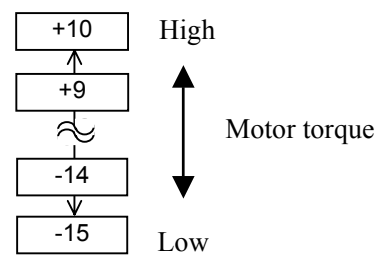

2.9.1 Fine Adjustment (Cont.)

(8) RBN ADJ.<BK>

When the ribbon is slack or wrinkled and printing is affected, fine adjust the ribbon motor torque.

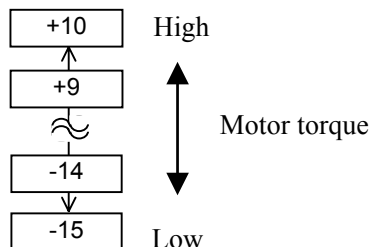

(9) THRESHOLD <REFL.>

When you perform a threshold setting for the reflective sensor and found the threshold needs to be adjusted, set a fine adjustment value. This menu is accessible directly from the Threshold Setting Mode so that the threshold can be manually set right away.

Manually set threshold = Peak voltage – The value set here
For details, refer to **Section 2.10**.

NOTE:
When "0.0 V" is set for this parameter, it is automatically corrected to 1.0V (default) after the power is turned OFF then ON.

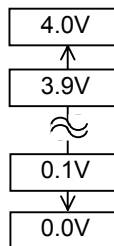

(10) THRESHOLD <TRANS.>

When you perform a threshold setting for the Transmissive sensor and found the threshold needs to be adjusted, set a fine adjustment value. This menu is accessible directly from the Threshold Setting Mode so that the threshold can be manually set right away.

Manually set threshold = Peak voltage – The value set here
For details, refer to **Section 2.10**.

NOTE:
When "0.0 V" is set for this parameter, it is automatically corrected to 1.4V (default) after the power is turned OFF then ON.

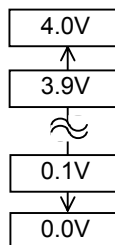

2.10 Threshold Setting

To maintain a constant print position the printer uses the media sensor to detect a print start position according to the difference of voltage between a print area and a gap or black mark. When the media is pre-printed, the darker (or more dense) inks can interfere with this process causing paper jam errors.

To get around this problem, first, try an automatic threshold setting. If the problem still occurs, then, the threshold voltage needs to be fine adjusted.

Threshold is a voltage level by which the printer determines whether a print area or a gap/a black mark is being detected by the media sensor. The threshold is a boundary between a print area and a gap/black mark, and should be a midpoint of their voltage levels.

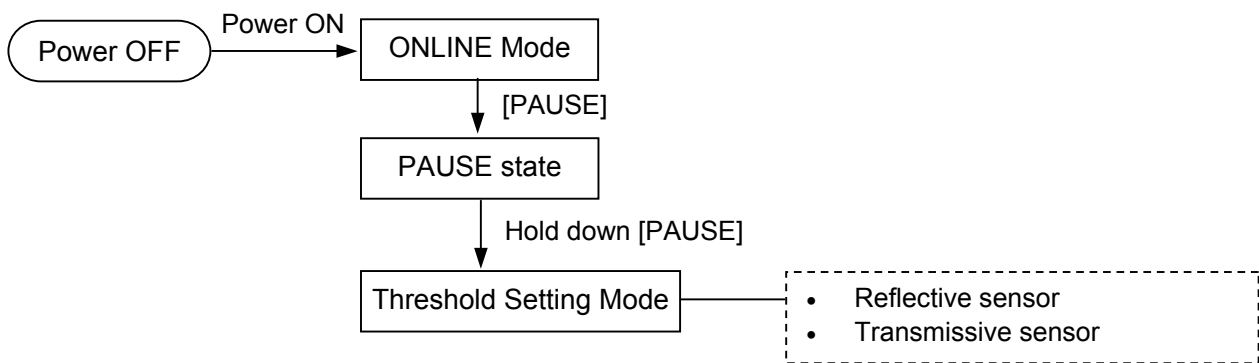

- (1) Load the media to be used.
- (2) Choose 1) or 2) depending on the sensor type to be used, then press the [ENTER].

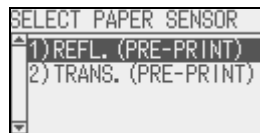

- (3) Hold down the [PAUSE] until more than 1.5 labels (tags) have been fed. The media will continue to be fed until the [PAUSE] is released. (An automatic threshold setting for the selected sensor is completed by this operation.)

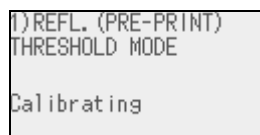

- (4) The result of the threshold setting is displayed.

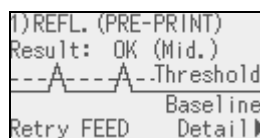

(e.g.: Succeeded)

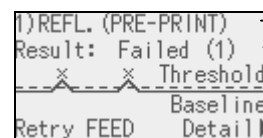

(e.g.: Failed)





- Sensor type
- Result (Text)
- Result (Graph)
- Key operation guide

NOTES:

1. Failure to feed more than 1.5 labels may result in an incorrect threshold setting.
2. A paper end or ribbon end error cannot be detected during paper feed.

2.10 Threshold Setting (Cont.)

NOTE:
 To make a threshold value set in this section effective, select the Transmissive Sensor (when using pre-printed media) or Reflective Sensor (when using manual threshold value) in Issue Command or the printer driver.

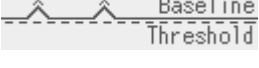
	Display example	Explanation
1		Result: OK (Mid.) Threshold is at the midpoint between the peak and the baseline.
2		Result: OK (High) Threshold is near the peak voltage. Adjusting the threshold to the midpoint between the peak and the baseline enables more accurate detection.
3		Result: OK (Low) Threshold is near the baseline voltage. Adjusting the threshold to the midpoint between the peak and the baseline enables more accurate detection.
4		Failed (1) The media sensor cannot detect a gap/black mark. Sensor adjustment is required. (=>Section 2.11)
5		Failed (1) The media sensor cannot detect a gap/black mark. (Threshold ≤ Baseline) Sensor adjustment is required. (=>Section 2.11)
6		Failed (2) Detection by the media sensor is disabled. Sensor adjustment is required. (=>Section 2.11)

(5) Press the [RIGHT] to see the details.

1) REFL. (PRE-PRINT) Peak : 3.7V Threshold : 2.7V Baseline : 1.3V ◀Result Adjust▶	1) REFL. (PRE-PRINT) Peak : 2.1V Threshold : 1.3V Baseline : 1.2V ◀Result	— Sensor type — Peak voltage — Threshold voltage — Baseline voltage — Key operation guide
(e.g.: Succeeded)	(e.g.: Failed)	

NOTE:
 The threshold can be manually set as follows:
 Manually set threshold = Peak voltage – Threshold fine adjustment value
 e.g.) When Peak=3.5V and Fine adjustment value=1.0V, the threshold will be set to 2.5V.

(6) To return to the previous display, press the [LEFT]. To adjust the threshold, press the [RIGHT]. The threshold fine adjustment screen in ADJUST SET menu appears. Set a value and press the [ENTER].



(7) The result after manually setting the threshold is displayed.

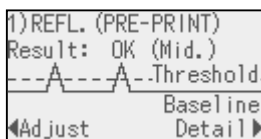

2.11 Sensor Setting

If a paper jam error still occurs even after a threshold setting has been performed, register the voltage level of media to the media sensor.

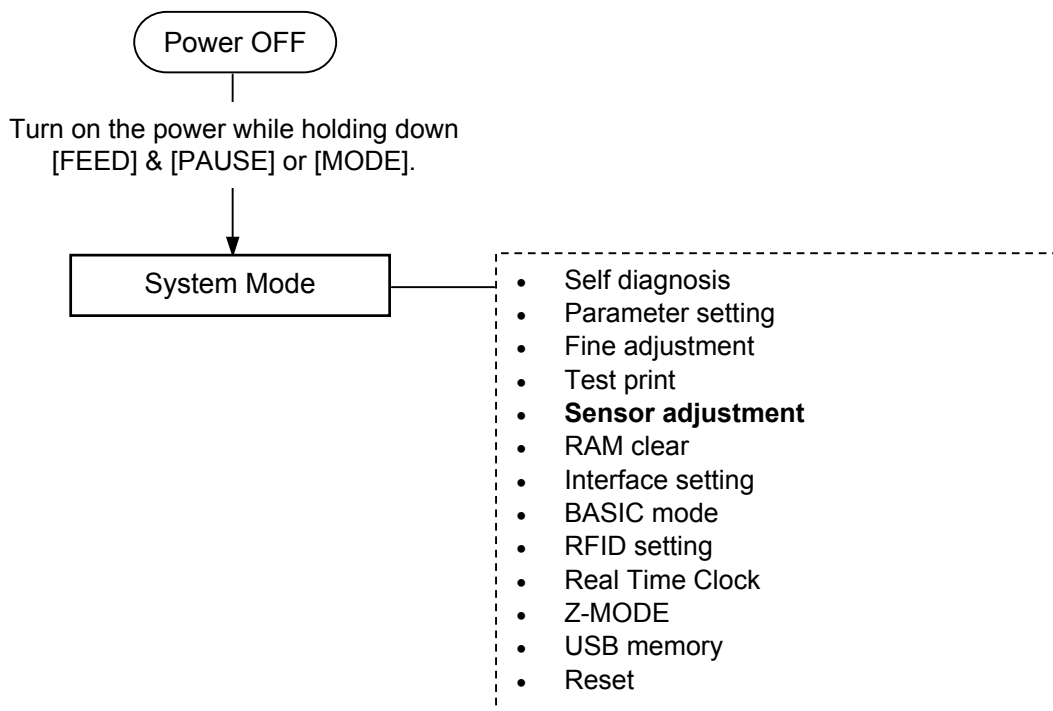

SYSTEM MODE

▲	<2>PARAMETER SET
	<3>ADJUST SET
	<4>TEST PRINT
▼	<5>SENSOR ADJUST

Contents of the Sensor Adjust Menu

Menu	Parameter	
Sensor Adjust	TEMPERATURE	Displays the ambient temperature and print head temperature.
	REFLECT	Registers the voltage level of tag paper's print area to the reflective sensor.
	TRANS.	Registers the voltage level of label gap to the transmissive sensor.
	PE REFL./TRANS.	Registers the voltage level of no paper to the reflective/transmissive sensor.
	RIBBON	Registers the voltage level of ribbon to the ribbon end sensor.

2.11 Sensor Setting (Cont.)

(1) REFLECT

1. Select "REFLECT" from the Sensor Adjust menu.
2. Place the tag paper to be used on the reflective sensor so that the sensor can detect a print area.
3. Hold down the [ENTER] for 3 seconds or more.
4. When registration of the "print area level" is completed, "Adjust Complete" is displayed and an asterisk is shown on the right side of the voltage.

(2) TRANS.

1. Select "TRANS." from the Sensor Adjust menu.
2. Remove some labels and place the backing paper so that the Transmissive sensor can detect it.
3. Hold down the [ENTER] for 3 seconds or more.
4. When registration of the "label gap level" is completed, "Adjust Complete" is displayed and an asterisk is shown on the right side of the voltage.

(3) PE REFL./TRANS.

1. Select "PE REFL./TRANS." from the Sensor Adjust menu.
2. Remove any media from the media sensor.
3. Hold down the [ENTER] for 3 seconds or more.
4. When registration of the "no media level" is completed, "Adjust Complete" is displayed and an asterisk is shown on the right side of the voltage.

3. ON LINE MODE

This chapter describes usage of the keys on the Operation Panel in On Line mode.

When the printer is in On Line mode and connected to a host computer, the normal operation of printing images on labels or tags can be accomplished.

3.1 Key Functions

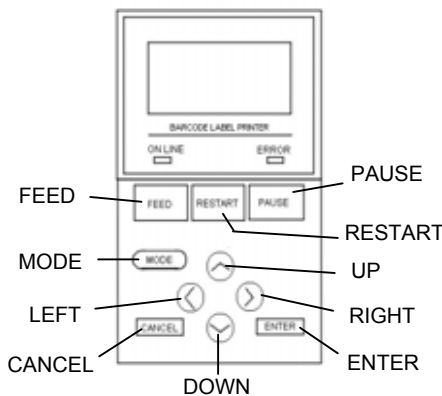

■ Key functions in the online mode

Key	Function
[FEED]	(1) Feeds one piece of paper.
	(2) Prints the data in the image buffer on one label according to the system mode setting.
	(3) Closes the help message.
[RESTART]	(1) Resumes printing after a temporary stop of label printing or after an error.
	(2) Places the printer in the usual initial state which is obtained when the power is turned on.
	(3) Places the printer in the user system mode.
	(4) Closes the help message.
[PAUSE]	(1) Stops label printing temporarily.
	(2) Programs the threshold values.
	(3) Closes the help message.
[MODE]	(1) Places the printer in the user system mode.
	(2) Closes the help message.
[CANCEL]	(1) Clears the job.
	(2) Displays previous help message page.
[ENTER]	(1) Displays next help message page.
	(2) Closes the help message.
[UP]	(1) Scrolls up
[DOWN]	(1) Scrolls down
[LEFT]	(1) Displays previous help message page.
[RIGHT]	(1) Displays next help message page.

3.2 LCD

Online state

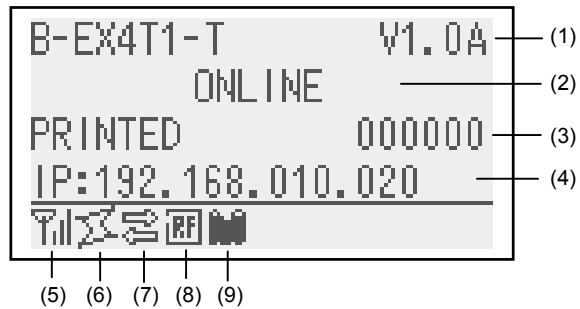

Error state

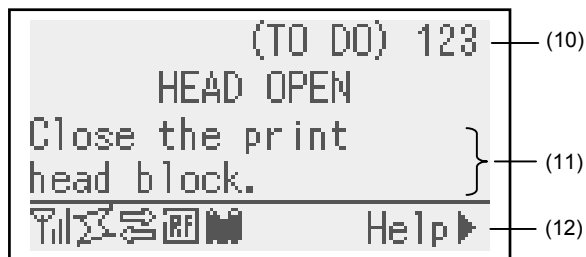

No.	Description
(1)	Model name and firmware version
(2)	Message
(3)	The number of labels printed
(4)	IP address (only when LAN/WLAN is enabled.)
(5)	Radio intensity (only when WLAN is enabled.) Indicates the radio intensity in 4 levels.
(6)	WLAN connection (only when WLAN is enabled.) <ul style="list-style-type: none"> ▪ Lights up when connecting to an access point. ▪ Flashes while roaming. ▪ Goes off when disconnected.
(7)	Data transmission Appears while receiving data from the host.
(8)	RFID (only when RFID module is installed.) <ul style="list-style-type: none"> ▪ Appears when a communication between the printer and the RFID module is enabled. ▪ Flashes while communicating with the RFID module.
(9)	Ribbon near end Flashes when a ribbon near end state is detected.
(10)	The number of remaining labels to print
(11)	Error description and solution
(12)	Help guide Appears when a help guide message is provided. Press the [RIGHT] key to see the help guide message.

3.3 Operation Example

■ Online Mode

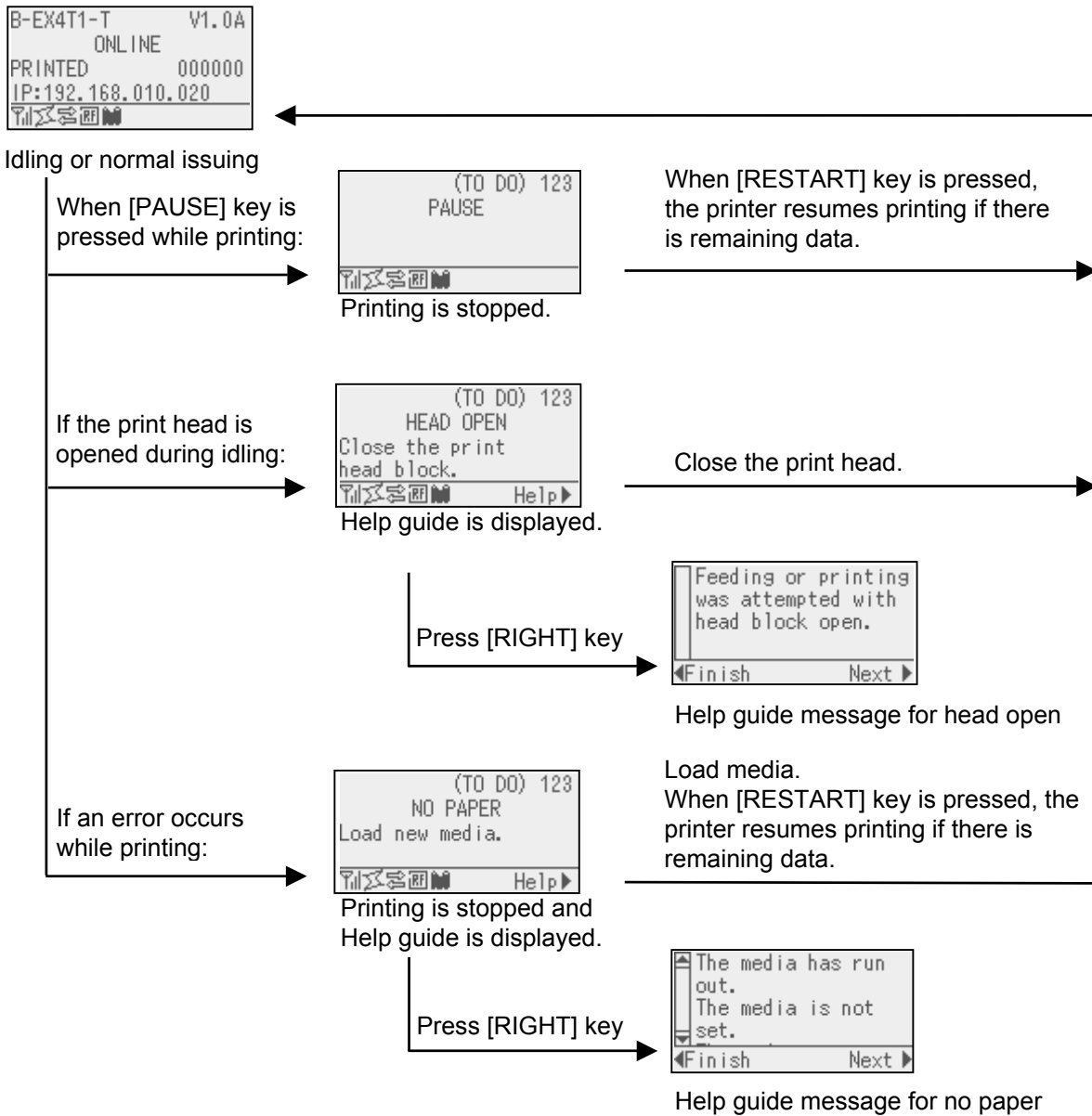

3.3 Operation Example (Cont.)

■ Help Guide Message



Idling or normal issuing

If an error occurs while printing:



Printing is stopped and Help guide is displayed.

Load media.
When [RESTART] key is pressed, the printer resumes printing if there is remaining data.

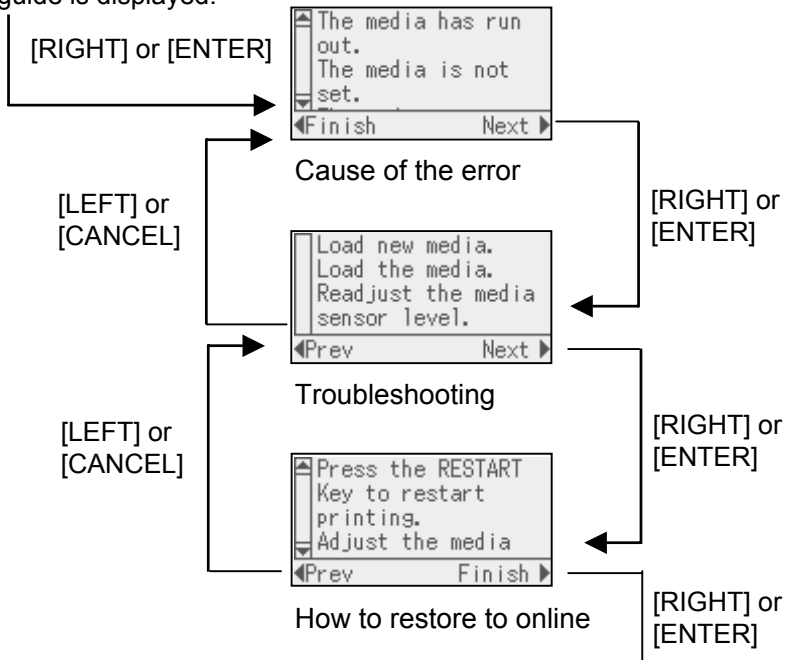

3.3 Operation Example (Cont.)

■ Cancellation of Print Job

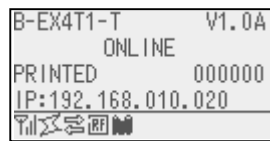

While [CANCEL] is held down, the received data is discarded.
(Quick reset)

Idling or normal issuing

When [PAUSE] key is pressed while printing:



Hold down [CANCEL] for 3 sec. or more.

If an error occurs while printing:

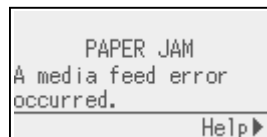

Hold down [CANCEL] for 3 sec. or more.



4. MAINTENANCE

WARNING!

1. Be sure to disconnect the power cord before performing maintenance. Failure to do this may cause an electric shock.
2. To avoid injury, be careful not to pinch your fingers while opening or closing the cover and print head block.
3. The print head becomes hot immediately after printing. Allow it to cool before performing any maintenance.
4. Do not pour water directly onto the printer.

This chapter describes how to perform routine maintenance.

To ensure the continuous high quality operation of the printer, you should perform a regular maintenance routine. For high throughput it should be done on a daily basis. For low throughput it should be done on a weekly basis.

4.1 Cleaning

To maintain the printer performance and print quality, please clean the printer regularly, or whenever the media or ribbon is replaced.

4.1.1 Print Head/Platen/Sensors

CAUTION!

1. Do not use any volatile solvent including thinner and benzene, as this may cause discoloration to the cover, print failure, or breakdown of the printer.
2. Do not touch the Print Head Element with bare hands, as static may damage the Print Head.

1. Turn off the power and unplug the printer.
2. Open the Top Cover.
3. Turn the Head Lever to **Free** position, then release the Ribbon Shaft Holder Plate.
4. Open the Print Head Block.
5. Remove the ribbon and media.

CAUTION!

When cleaning the print head, be careful not to damage the print head with a hard object like a watch or a ring.



Care must be taken not to allow the metal or glass part of a watch to touch the print head edge.



Care must be taken not to allow a metal object like a ring to touch the print head edge.

Since the print head element can be easily damaged by shock, please treat it carefully by not hitting a hard object against it.

4.1.1 Print Head/Platen/Sensors (Cont.)

NOTE:

Please purchase the Print Head Cleaner from your authorised TOSHIBA TEC service representative.

6. Clean the Print Head Element with a Print Head Cleaner or a cotton swab or soft cloth slightly moistened with alcohol.

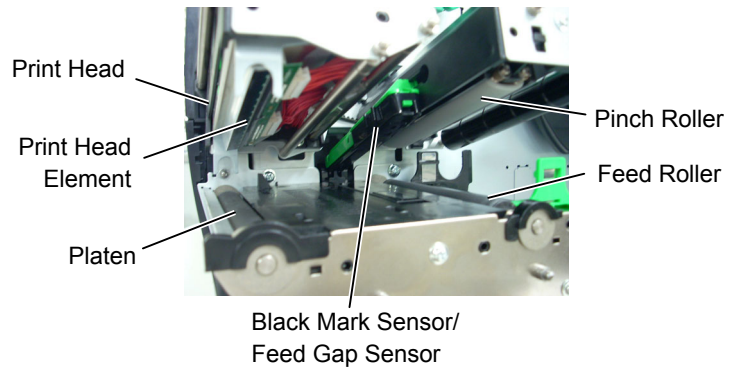

7. Wipe the Platen, Feed Roller, and Pinch Roller with a soft cloth slightly moistened with alcohol. Remove dust or foreign substances from the internal part of the printer.
8. Wipe the Feed Gap Sensor and Black Mark Sensor with a dry soft cloth.

4.1.2 Covers and Panels

CAUTION!

1. DO NOT POUR WATER directly onto the printer.
2. DO NOT APPLY cleaner or detergent directly onto any cover or panel.
3. NEVER USE THINNER OR OTHER VOLATILE SOLVENT on the plastic covers.
4. DO NOT clean the panel, covers, or the supply window with alcohol as it may cause them to discolour, loose their shape or develop structural weakness.

Wipe the covers and panels with a dry soft cloth or a cloth slightly moistened with mild detergent solution.



4.1.3 Optional Cutter Module

WARNING!

1. *Be sure to turn the power off before cleaning the Cutter Module.*
2. *As the cutter blade is sharp, care should be taken not to injure yourself while cleaning.*

The disc cutter and rotary cutter are available as an option. They are both cleaned in the same way. When removing the Cutter Cover of the rotary cutter unit, remove the screws from the bottom of the cover.

1. Loosen the two Plastic Head Screws to remove the Cutter Cover.
2. Remove the jammed paper.
3. Clean the Cutter with a soft cloth slightly moistened with alcohol.
4. Attach the Cutter Cover.

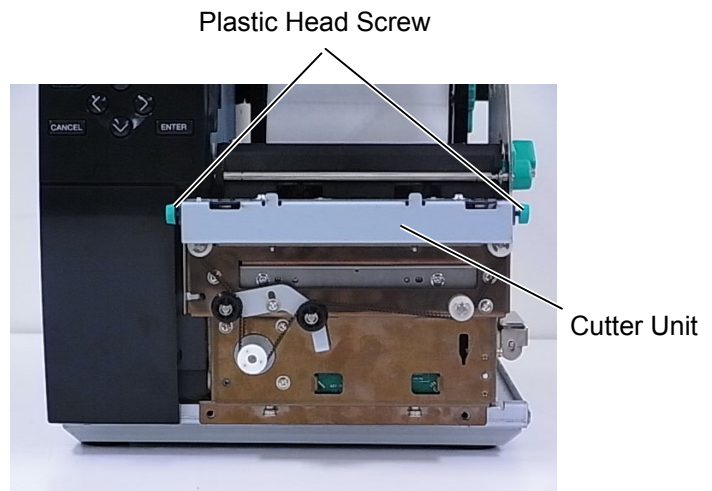

5. TROUBLESHOOTING

This chapter lists the error messages, possible problems, and their solutions.

WARNING!

If a problem cannot be solved by taking the actions described in this chapter, do not attempt to repair the printer. Turn off and unplug the printer, then contact an authorised TOSHIBA TEC service representative for assistance.

5.1 Error Messages

NOTES:

- If an error is not cleared by pressing the **[RESTART]** key, turn the printer off and then on.
- After the printer is turned off, all print data in the printer is cleared.
- “****” indicates the number of unprinted media. Up to 9999 (in pieces).

Error Messages	Problems/Causes	Solutions
HEAD OPEN	The Print Head Block is opened in Online mode.	Close the Print Head Block.
HEAD OPEN ****	Feeding or printing has been attempted with the Print Head Block open.	Close the Print Head Block. Then press the [RESTART] key.
COMMS ERROR	A communication error has occurred.	Make sure the interface cable is correctly connected to the printer and the host, and the host is turned on.
PAPER JAM ****	1. The media is jammed in the media path. The media is not fed smoothly.	1. Remove the jammed media, and clean the Platen. Then reload the media correctly. Finally press the [RESTART] key. ⇒ Section 5.3.
	2. The media is not loaded properly.	2. Reload the media correctly. Then press the [RESTART] key. ⇒ Section 2.3.
	3. Wrong Media Sensor is selected for the media being used.	3. Turn the printer off and then on. Then select the Media Sensor for the media being used. Finally resend the print job.
	4. The Black Mark Sensor is not correctly aligned with the Black Mark on the media.	4. Adjust the sensor position. Then press the [RESTART] key. ⇒ Section 2.3.1.
	5. Size of the loaded media is different from the programmed size.	5. Replace the loaded media with one that matches the programmed size then press the [RESTART] key, or turn the printer off and then on, select a programmed size that matches the loaded media. Finally resend the print job.
	6. Media sensor has not been properly calibrated for the media being used.	6. Refer to Section 2.10 to set the threshold. If this does not solve the problem, turn off the printer, and call a TOSHIBA TEC authorised service representative.

5.1 Error Messages (Cont.)

Error Messages	Problems/Cause	Solutions
CUTTER ERROR **** (Only when the cutter module is installed on the printer.)	1. The media is jammed in the cutter.	1. Remove the jammed media. Then press the [RESTART] key. If this does not solve the problem, turn off the printer, and call a TOSHIBA TEC authorised service representative. ⇒ Section 4.1.3.
	2. The Cutter Cover is not attached properly.	2. Attach the Cutter Cover properly.
NO PAPER ****	1. The media has run out.	1. Load new media. Then press the [RESTART] key. ⇒ Section 2.3.1.
	2. The media is not loaded properly.	2. Reload the media correctly. Then press the [RESTART] key. ⇒ Section 2.3.1.
	3. The media sensor position has not been adjusted properly.	3. Adjust the sensor position. Then press the [RESTART] key. ⇒ Section 2.3.1.
	4. Media sensor has not been properly calibrated for the media being used.	4. Refer to Section 2.10 to set the threshold. If this does not solve the problem, turn off the printer, and call a TOSHIBA TEC authorised service representative.
	5. The media is slack.	5. Take up any slack in the media.
RIBBON ERROR ****	1. The ribbon is not fed properly.	1. Remove the ribbon, and check the status of the ribbon. Replace the ribbon, if necessary. If the problem is not solved, turn off the printer, and call a TOSHIBA TEC authorised service representative.
	2. The ribbon is not loaded.	2. Load a ribbon. ⇒ Section 2.3.2
	3. The ribbon sensor has a problem.	3. Turn off the printer and call a TOSHIBA TEC authorised service representative.
NO RIBBON ****	The ribbon has run out.	Load a new ribbon. Then press the [RESTART] key. ⇒ Section 2.3.2.
REWIND FULL ****	The Built-in Rewinder Unit is full.	Remove the backing paper from the Built-In Rewinder Unit. Then press the [RESTART] key.
EXCESS HEAD TEMP	The Print Head has overheated.	Turn off the printer, and allow it to cool down (about 3 minutes). If this does not solve the problem, call a TOSHIBA TEC authorised service representative.
HEAD ERROR	There is a problem with the Print Head.	Replace the Print Head.
POWER FAILURE	A momentary power failure has occurred.	Check the power source which supplies power to the printer. If the rating is not correct, or if the printer shares the same power outlet with other electrical appliances that consume large amounts of power, change the outlet.

5.1 Error Messages (Cont.)

Error Messages	Problems/Cause	Solutions
SYSTEM ERROR	1. The printer is used in a location where it is subject to noise. Or, there are power cords of other electrical appliances near the printer or interface cable.	1. Keep the printer and the interface cables away from the source of noise
	2. The Power Cord of the printer is not grounded.	2. Ground the Power Cord.
	3. The printer shares the same power source with any other electrical appliances.	3. Provide an exclusive power source for the printer.
	4. An application software used on your host computer has an error or malfunction.	4. Confirm the host computer operates properly.
MEMORY WRITE ERR.	An error has occurred in writing to the flash ROM/USB memory.	Turn the printer off, and then on again.
FORMAT ERROR	An error has occurred in formatting the flash ROM/USB memory.	Turn the printer off, and then on again.
MEMORY FULL	Saving failed because of an insufficient capacity of the flash ROM/USB memory.	Turn the printer off, and then on again.
EEPROM ERROR	Data cannot be read from/written to a backup EEPROM properly.	Turn the printer off, and then on again.
RFID WRITE ERROR	The printer did not succeed in writing data onto an RFID tag after having retried for a specified times.	Press the [RESTART] key.
RFID ERROR	The printer cannot communicate with the RFID module.	Turn the printer off, and then on again.
LOW BATTERY	The voltage of the Real Time Clock Battery is low level.	If you would like to keep using the same battery even after "LOW BATTERY" error occurs, turn off the printer and start it in the system mode. Set the date and time for the RTC again. Reset the printer, then place it in online. As long as the power is on, this date and time will be effective. Call a TOSHIBA TEC authorised service representative for replacement of the battery.
SYNTAX ERROR	While the printer is in the Download mode for upgrading the firmware, it receives an improper command, for example, a Issue Command.	Turn the printer off, and then on again.
PASSWORD INVALID Please Power OFF	A wrong password was entered consecutively for three times.	Please inquire of the system administrator.
Other error messages	A hardware or software problem may have occurred.	Turn the printer off and then on. If this does not solve the problem, turn off the printer again, and call a TOSHIBA TEC authorised service representative.

5.2 Possible Problems

This section describes problems that may occur when using the printer, and their causes and solutions.

Possible Problems	Causes	Solutions
The printer will not turn on.	1. The Power Cord is disconnected.	1. Plug in the Power Cord.
	2. The AC outlet is not functioning correctly.	2. Test with a power cord from another electric appliance.
	3. The fuse has blown, or the circuit breaker has tripped.	3. Check the fuse or breaker.
The media is not fed.	1. The media is not loaded properly.	1. Load the media properly. ⇒ Section 2.3.1.
	2. The printer is in an error condition.	2. Solve the error in the message display. (See Section 5.1 for more detail.)
Pressing the [FEED] key in the initial state results in an error.	A feed or an issue was attempted not on the following default conditions. Sensor type: Feed gap sensor Printing method: Thermal transfer Media pitch: 76.2 mm	Change the print condition by using the printer driver or a print command so that it corresponds to your printing conditions. Then, clear the error state by pressing the [RESTART] key.
Nothing is printed on the media.	1. The media is not loaded properly.	1. Load the media properly. ⇒ Section 2.3.1.
	2. The ribbon is not loaded properly.	2. Load the ribbon properly. ⇒ Section 2.3.2.
	3. The print head is not installed properly.	3. Install the print head properly. Close the Print Head Block.
	4. The combination of the ribbon and media is not proper.	4. Select an appropriate ribbon for the media type being used.
The printed image is blurred.	1. The combination of the ribbon and media is not proper.	1. Select an appropriate ribbon for the media type being used.
	2. The Print Head is not clean.	2. Clean the print head using the Print Head Cleaner or a cotton swab slightly moistened with ethyl alcohol.
The cutter does not cut.	1. The Cutter Cover is not attached properly.	1. Attach the Cutter Cover properly.
	2. The media is jammed in the Cutter.	2. Remove the jammed paper. ⇒ Section 4.1.3.
	3. The cutter blade is dirty.	3. Clean the cutter blade. ⇒ Section 4.1.3.
The Strip Module does not remove labels from the backing paper.	Label stock is too thin or the glue is too sticky.	1. Refer to Section 7.1 Media and change the label.
		2. Set the Pre-strip function to ON. ⇒ Section 2.6.2.

5.3 Removing Jammed Media

This section describes in detail how to remove jammed media from the printer.

CAUTION!
Do not use any tool that may damage the Print Head.

1. Turn off and unplug the printer.
2. Open the Top Cover.
3. Turn the Head Lever to **Free** position, then open the Ribbon Shaft Holder Plate.
4. Open the Print Head Block.
5. Remove the ribbon and media.

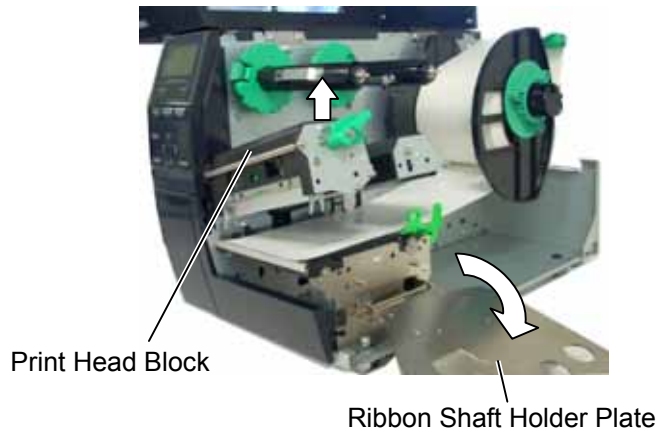

6. Remove the jammed media from the printer. DO NOT USE any sharp implements or tools as these could damage the printer.
7. Clean the Print Head and Platen, then remove any further dust or foreign substances.
8. Paper jams in the Cutter Unit can be caused by wear or residual glue from label stock on the cutter. Do not use non-specified media in the cutter.

NOTE:
If you get frequent jams in the cutter, contact a TOSHIBA TEC authorised service representative.

CAUTION!

When removing the jammed media, be careful not to damage the print head with a hard object like a watch or a ring.

Care must be taken not to allow the metal or glass part of a watch to touch the print head edge.

Care must be taken not to allow a metal object like a ring to touch the print head edge.

Since the print head element can be easily damaged by shock, please treat it carefully by not hitting a hard object against it.

6. PRINTER SPECIFICATIONS

This section describes the printer specifications.

Model		B-EX4T-GS12-QM-R/CN-R	B-EX4T-TS12-QM-R/CN-R
Item			
Dimension (W x D x H)	278 mm x 460 mm x 310 mm (10.9" x 18.1" x 12.2")		
Weight (kg)	17 kg		
Operating temperature range	5 degC to 40 degC (40 degF to 104 degF)		
Relative humidity	25% to 85% RH (no condensation)		
Power supply	Universal switching power source AC 100 V to 240 V, 50/50 Hz +/- 10%		
Input voltage	AC100 V to 240 V, 50/60 Hz +/- 10%		
Power	During a print job*	116W 0.59A	
Consumption	During stand-by	15W or less	
	During sleep mode	5.7W 0.09A	
Resolution	8 dots/mm (203 dpi)	12 dots/mm (305 dpi)	
Printing method	Thermal transfer or Thermal direct		
Printing speed	76.2 mm/sec. (3 inches/sec.) 152.4 mm/sec. (6 inches/sec.) 254.0 mm/sec. (10 inches/sec.) 304.8 mm/sec. (12 inches/sec.) 355.6 mm/sec. (14 inches/sec.)	76.2 mm/sec. (3 inches/sec.) 127.0 mm/sec. (5 inches/sec.) 203.8 mm/sec. (8 inches/sec.) 254.0 mm/sec. (10 inches/sec.) 304.8 mm/sec. (12 inches/sec.) 355.6 mm/sec. (14 inches/sec.)	
Available media width (including backing paper)	25.0 mm to 120 mm (0.98 inches to 4.72 inches)		
Effective print width (max.)	104.0 mm (4.1 inches)		
Issue mode	Batch Strip (Strip mode is enabled only when the optional Strip Module is installed.) Cut (Cut mode is enabled only when the optional Cutter Module is installed.)		
LCD Message display	Graphic type 128 x 64 dots		

*: While 20% slant lines are printed in the specified format.

Item	Model	
	B-EX4T-GS12-QM-R/CN-R	B-EX4T-TS12-QM-R/CN-R
Bar code types	JAN8, JAN13, EAN8, EAN8+2 digits, EAN8+5 digits, EAN13, EAN13+2 digits, EAN13+5 digits, UPC-E, UPC-E+2 digits, UPC-E+5 digits, UPC-A, UPC-A+2 digits, UPC-A+5 digits, MSI, ITF, NW-7, CODE39, CODE93, CODE128, EAN128, Industrial 2 to 5, Customer Bar Code, POSTNET, KIX CODE, RM4SCC (ROYAL MAIL 4 STATE CUSTOMER CODE), GS1 DataBar	
Two-dimensional code	Data Matrix, PDF417, QR code, Maxi Code, Micro PDF417, CP Code	
Font	Times Roman (6 sizes), Helvetica (6 sizes), Presentation (1 size), Letter Gothic (1 size), Prestige Elite (2 sizes), Courier (2 sizes), OCR (2 types), Gothic (1 size), Outline font (4 types), Price font (3 types) 24 x 24 Simp-Chinese font (only CN model)	
Rotations	0, 90, 180, 270 deg	
Standard interface	USB interface LAN interface	
Optional interface	Serial interface (B-EX700-RS-QM-R) Parallel interface (B-EX700-CEN-QM-R) Expansion I/O interface (B-EX700-IO-QM-R) RTC & USB Host interface (B-EX700-RTC-QM-R) Wireless LAN interface (B-EX700-WLAN-QM-R)	

NOTES:

- *Data Matrix™ is a trademark of International Data Matrix Inc., U.S.*
- *PDF417™ is a trademark of Symbol Technologies Inc., US.*
- *QR Code is a trademark of DENSO CORPORATION.*
- *Maxi Code is a trademark of United Parcel Service of America, Inc., U.S.*

7. SUPPLY SPECIFICATIONS

7.1 Media

Please make sure that the media being used is approved by TOSHIBA TEC. The warranty does not apply when a problem is caused by using media that is not approved by TOSHIBA TEC.

For information regarding TOSHIBA TEC approved media, please contact a TOSHIBA TEC authorised service representative.

7.1.1 Media Type

Two types of media can be loaded for this thermal transfer and direct thermal printer: label or tag. The table below shows size and shape of the media available for this printer.

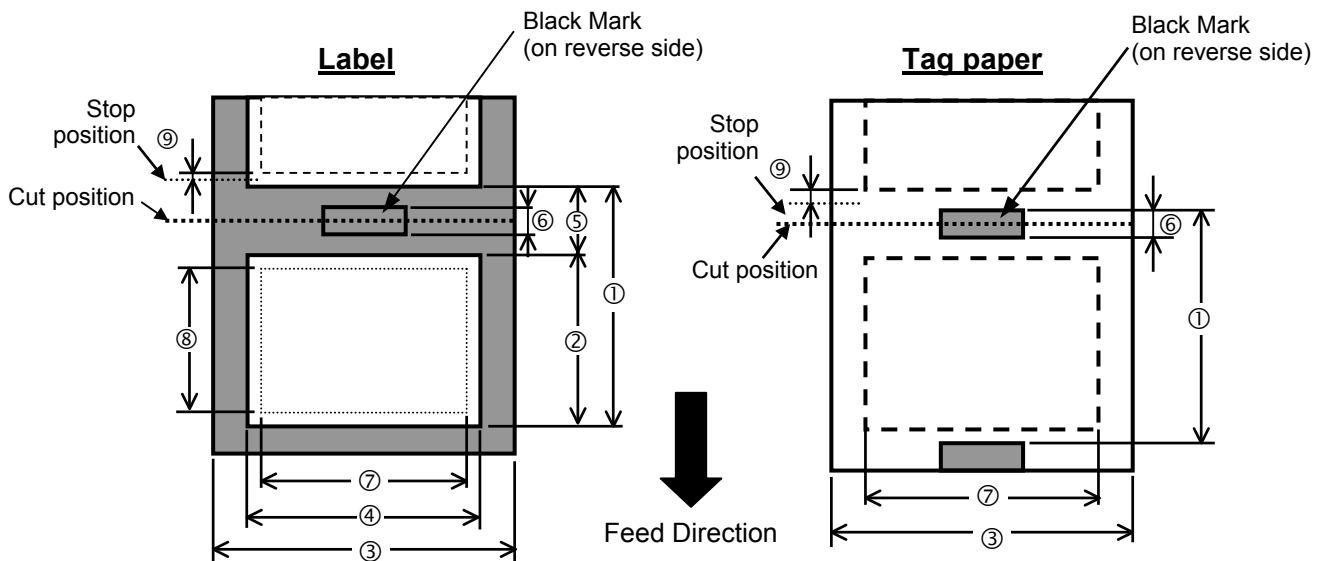

B-EX4T-GS12-QM-R

[Unit: mm]

Item	Label dispensing mode	Batch mode	Strip mode	Cut mode		
				Rotary cutter		Disc cutter
				Head-up disabled	Head-up enabled	
① Media pitch	Label	10.0 – 1500.0	25.4 – 256.0	3"/s.: 87.0 - 1500.0 6"/s.: 99.0 – 1500.0	38.0 – 1500.0	25.4 – 1500.0
	Tag	10.0 – 1500.0	----	30.0 – 1500.0		25.4 – 1500.0
② Label length		8.0 – 1498.0	23.4 – 1498.0	3"/s.: 81.0 – 1494.0 6"/s.: 93.0 – 1494.0	25.0 – 1494.0	23.4 – 1494.0
③ Tag/Backing paper width		30.0 – 120.0	50.0 – 120.0	30.0 – 120.0		
④ Label width		27.0 – 117.0				
⑤ Gap length		2.0 – 20.0		6.0 – 20.0		
⑥ Black mark length (Tag paper)		2.0 – 10.0				
⑦ Max. effective print width		104.0 ±0.2				
⑧ Effective print length	Label	6.0 – 1496.0	21.4 – 252.0	3"/s.: 79.0 - 1492.0 6"/s.: 91.0 – 1492.0	23.0 – 1492.0	21.4 – 1492.0
	Tag	8.0 – 1498.0	----	28.0 – 1498.0		21.40 – 1498.0
⑨ Print speed up/slow down area		1.0 (Slow down shall be 1.5 when the print speed is 14 ips.)				
Thickness	Label	0.08 – 0.17				
	Tag	0.08 – 0.263 (30 to 50 mm width)				
Maximum effective length for on the fly issue		749.0				
Maximum outer roll diameter		Ø200 (Ø180 when using the built-in Rewinder)				
Roll direction		Inside (standard)				
Inner core diameter		Ø76.2±0.3				

B-EX4T-TS12-QM-R

[Unit: mm]

Item	Label dispensing mode	Batch mode	Strip mode	Cut mode		
				Rotary cutter		Disc cutter
				Head-up disabled	Head-up enabled	
① Media pitch	Label	10.0 – 1500.0	25.4 – 256.0	3"/s.: 94.0 - 1500.0 5"/s.: 102.0 – 1500.0 8"/s.: 113.0 – 1500.0	38.0 – 1500.0	25.4 – 1500.0
	Tag	10.0 – 1500.0	----	3"/s., 5"/s.: 30.0 – 1500.0 8"/s.: 38.0 – 1494.0		25.4 – 1500.0
② Label length		6.0 – 1498.0	23.4 – 1498.0	3"/s.: 81.0 – 1494.0 5"/s.: 89.0 – 1494.0 8"/s.: 100.0 – 1494.0	25.0 – 1494.0	23.4 – 1494.0
③ Tag/Backing paper width		30.0 – 120.0	50.0 – 120.0	30.0 – 120.0		
④ Label width		27.0 – 117.0				
⑤ Gap length		2.0 – 20.0		6.0 – 20.0		
⑥ Black mark length (Tag paper)		2.0 – 10.0				
⑦ Max. effective print width		104.0 ±0.2				
⑧ Effective print length	Label	6.0 – 1496.0	21.4 – 252.0	3"/s.: 79.0 - 1492.0 5"/s.: 87.0 – 1492.0 8"/s.: 98.0 – 1492.0	23.0 – 1492.0	21.4 – 1492.0
	Tag	8.0 – 1498.0	----	3"/s., 5"/s.: 28.0 – 1498.0 8"/s.: 36.0 – 1498.0		21.40 – 1498.0
⑨ Print speed up/slow down area		1.0 (Slow down shall be 1.5 when the print speed is 14 ips.)				
Thickness	Label	0.08 – 0.17				
	Tag	0.08 – 0.263 (30 to 50 mm width)				
Maximum effective length for on the fly issue		749.0				
Maximum outer roll diameter		Ø200 (Ø180 when using the built-in Rewinder)				
Roll direction		Inside (standard)				
Inner core diameter		Ø76.2±0.3				

NOTES:

- To ensure print quality and print head life use only TOSHIBA TEC specified media.
- When the Rotary Cutter is used, the minimum label length differs depending on the print speed.
 - * When issuing a label at 3"/sec., label length shall be 91.0 mm – (Gap length/2) or longer.
 - * When issuing a label at 5"/sec., label length shall be 99.0 mm – (Gap length/2) or longer.
 - * When issuing a label at 6"/sec., label length shall be 103.0 mm – (Gap length/2) or longer.
 - * When issuing a label at 8"/sec., label length shall be 110.0 mm – (Gap length/2) or longer.
- When the Disc cutter is used, the minimum label length shall be 18.0 mm – (Gap length/2) or longer.
- When using the Rotary Cutter, be sure to install the Ribbon Saving Module (B-EX904-R-QM-R) to perform head-up and cut. Failure to do this may cause a paper jam or ribbon error.
- The Rotary Cutter and the Strip Module do not support the print speed of 10"/sec. or faster.
- When you use tag paper which is narrower than 50 mm, turn the Head Lever to **LABEL** position.
- The ratio of a label length to a gap length must be a minimum of 3 to 1 (3:1).
- When using a label stock in cut mode, be sure to cut the gaps. Cutting labels will cause the glue to stick to the cutter, which may affect the cutter performance and shorten the cutter life.

7.1.2 Detection Area of the Transmissive Sensor

The Transmissive Sensor is movable from the centre to the left edge of media.
 The Transmissive Sensor detects a gap between labels, as illustrated below.

<Label>

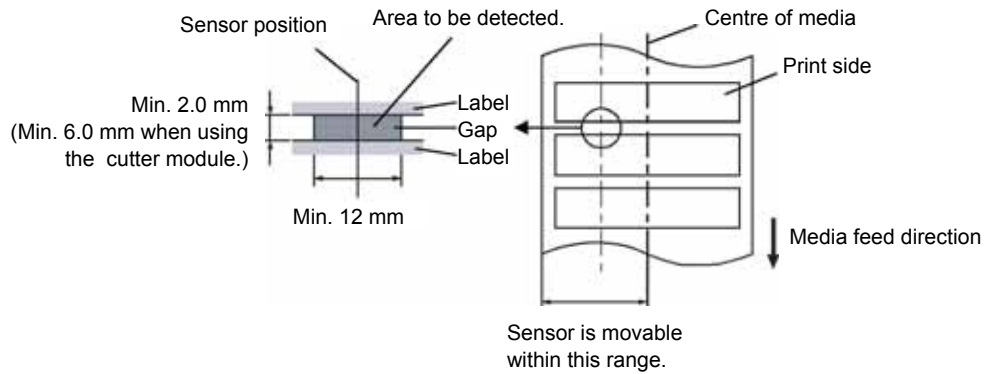

<Tag paper with square holes>

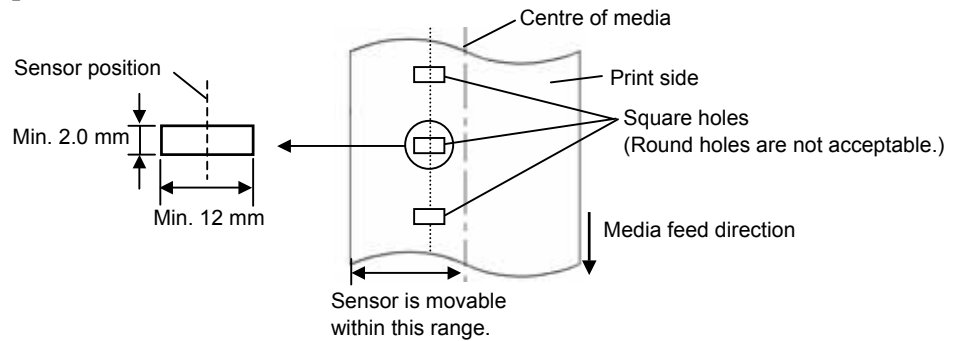

NOTE:
 Round holes are not acceptable.

7.1.3 Detection Area of the Reflective Sensor

The Reflective Sensor is movable from the centre to the left edge of media.

The reflection factor of the Black Mark must be 10% or lower with a waveform length of 950 nm.

The Reflective Sensor should be aligned with the centre of the Black Mark.

Rectangular holes can substitute the black marks, on the condition that nothing is printed on the back side.

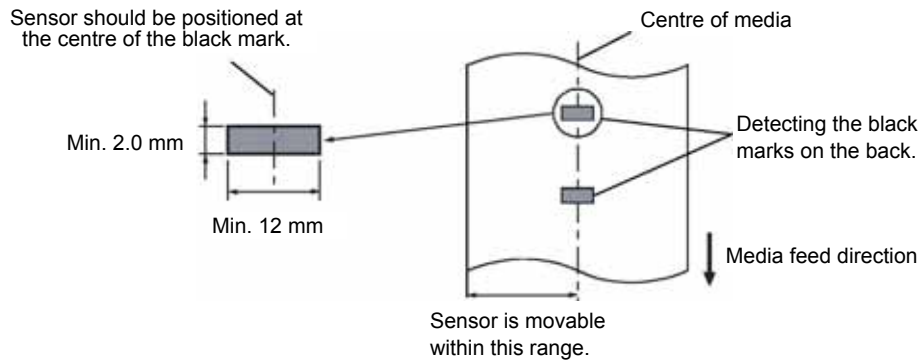

7.1.4 Effective Print Area

The figure below illustrates the relation between the head effective print width and media width.

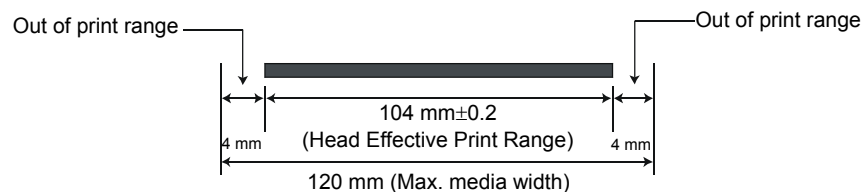

The figure below shows the effective print area on the media.

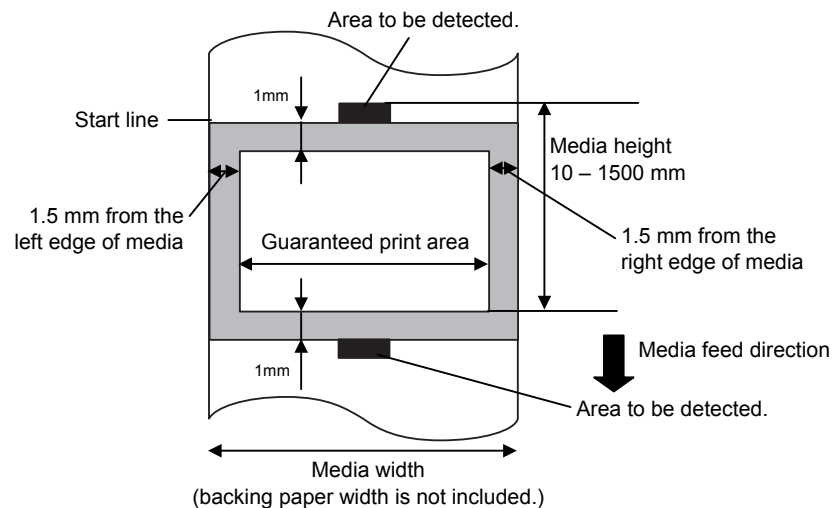

NOTES:

1. Be sure not to print on the 1.5-mm wide area from the media edges (shaded area in the above figure). Printing on this area may cause ribbon wrinkles, resulting in a poor print quality of the guaranteed print area.
2. The centre of media is positioned at the centre of the Print Head.
3. Print quality in the 3-mm area from the print head stop position (including 1.5-mm non-printable area for print speed slow down) is not guaranteed.

7.1.5 RFID Tags

Available RFID tag types are different depending on the RFID modules, as follows:

■ **B-EX700-RFID-U2-US-R and B-EX700-RFID-U2-EU-R**

- EPC UHF Gen2
- ISO-18000-6C

■ **B-EX700-RFID-H1-QM-R**

- TAGSYS C210
- TAGSYS C220
- TAGSYS C240
- TAGSYS C320 (Only when the TAGSYS S003 module is used.)
- I-Code
- Tag-it
- ISO15693

Cautions for using RFID Tags

(1) Lift-up of Print Head

An RFID tag chip or the print head may be damaged when the print head passes over the chip. This can be prevented by using the ribbon saving module (optional for the B-EX4T). The print head is lifted by the ribbon saving module when it passes over the chip to prevent it from touching the chip. The print head is lifted by approximately 1 mm from the platen.

(2) Storage of RFID Supplies

Do not store RFID tags close to printers, or their communication performance may not be as specified when they are used.

(3) Roll-type RFID Supplies

When RFID supplies are to be rolled, roll hardness must be concerned. Although it depends on the type of glue, tag, and backing paper, RFID-tag embedded labels tend to stay rolled. Especially, when they are wound outside, a paper jam error may occur. Unless otherwise specified, it is recommended that the RFID-tag embedded labels be wound inside.

(4) Sensor

When the transmissive sensor or reflective sensor is enabled, transmittance or reflectivity of a label or tag may vary at an RFID-tag embedded area depending on the pattern of an antenna or other factors. In such cases, a manual threshold setting is required. For details, refer to **Section 2.10 Threshold Setting**.

(5) Cutter

When an RFID label or tag is used in cut issue mode, care must be taken not to cut an antenna of the RFID tag or an IC chip in order not to damage the cutter.

(6) Static Electricity

When printing is performed in a place where humidity is low or under some specific conditions, writing data on an RFID tag may fail due to static electricity generated by a label or a ribbon.

(7) Printing on Bump (Chip/Antenna) Area

Embedding an RFID tag in labels creates bumps on the label surface, causing incomplete printing. Uneven printing or incomplete printing can occur easily, especially within 5 mm back and forth, and right and left sides of the RFID-tag embedded area, as shown in the figure below.

NOTE: The degree of poor printing quality differs depending on height of a chip/antenna used.

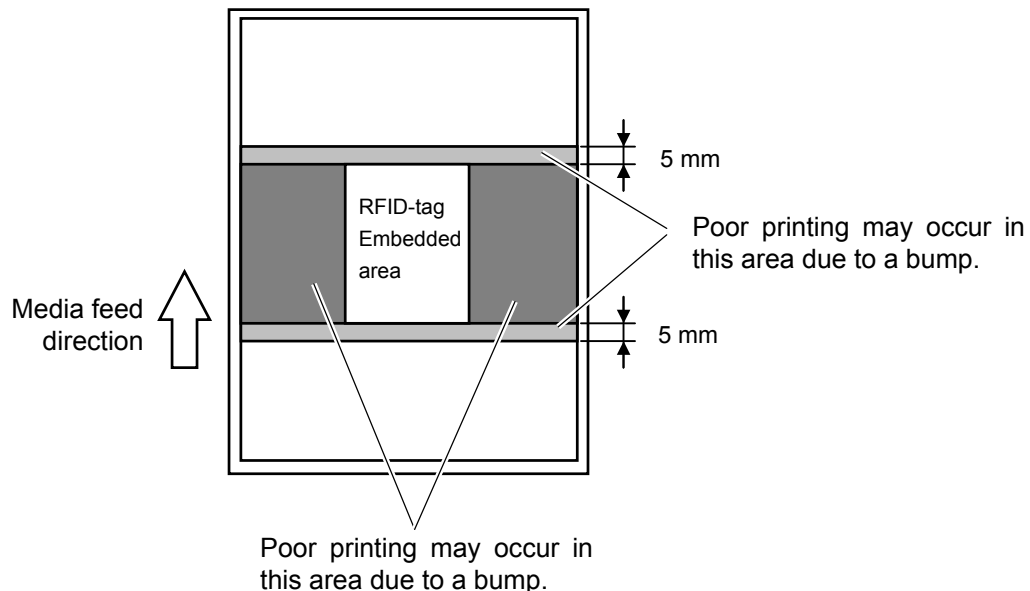

(8) Ambient Temperature

As low temperature deteriorates wireless performance, writing data on an RFID tag may fail under such conditions.

(9) Head-up Reverse Feed

When an RFID label is used, a reverse feed may be required before an issue depending on the location of an RFID tag in the label.

A printer without the ribbon saving module may not be able to perform a reverse feed properly because the print head may be caught by an edge of the label. For this reason, the ribbon saving module must be installed in the printer when media, which requires a reverse feed before an issue, is used.

(10) Strip Issue

Stripping performance in strip issue mode depends on the type of glue, tag, and backing paper. For some RFID supplies used, a strip issue may not be performed properly.

(11) Caution for Minimum Label Pitch Length

When media, of which label pitch length is short, is used, data may be written on an RFID tag next to the target RFID tag.

As the location, where data is to be written, differs among RFID tag types, a check must be performed to make sure that the data is written on the target RFID tags. The B-EX RFID Analyze Tool can be used for this purpose. For details, please contact the nearest TOSHIBA TEC support representative.

(12) Defective RFID Supply

RFID supplies may include defective RFID tags at the time of shipment from the maker. The defect rate differs depending on tag types, method of converting to supplies, etc.

The RFID supply manufacturer should provide a way to identify defective tags by printing a mark on them or any other methods.

Or, defective tags should be rejected in the production process.

The end users must be notified on how to identify a defective tag from a good one.

7.2 Ribbon

Please make sure that the ribbon being used is approved by TOSHIBA TEC. The warranty does not apply to any problem caused by using non-approved ribbons.

For information regarding TOSHIBA TEC approved ribbon, please contact a TOSHIBA TEC service representative.

Type	Spool type
Width	41 – 112 mm Recommended width is 41, 50, 68, 84, and 112 mm.
Length	600 m
Outside Diameter	φ90 mm (max.)

The table below shows the correlation between ribbon width and media width (backing paper is not included.)

Ribbon width	Media width	Ribbon width	Media width
41 mm	30 – 36 mm	84 mm	63 – 79 mm
50 mm	36 – 45 mm	112 mm	79 – 120 mm
68 mm	45 – 63 mm		

NOTES:

1. To ensure print quality and print head life use only TOSHIBA TEC specified ribbons.
2. To avoid ribbon wrinkles use a ribbon that is wider than the media by 5 mm or more. However, too much difference in width between the two may cause wrinkles.
3. When using a 120 mm wide media, be sure to use a 112 mm wide ribbon. Use of other ribbons may cause ribbon wrinkles.

7.3 Recommended Media and Ribbon Types

Media type	Description
Vellum paper and labels	General use for low cost applications.
Coated paper	Matt coated paper General use including applications that require small letters and/or symbols. Glossy coated paper Used where a high-grade finish is required
Plastic films	Synthetic film (Polypropylene, etc.) This water-proof and solvent-resistant material has high physical strength and low-temperature resistance, but poor heat resistance (dependant upon material). This material can be used for labels stuck to recyclable containers, so it can be recycled in the same process. PET film This water-proof and solvent-resistant material has high physical strength, and low-temperature resistance as well as heat resistance. This material is used for many applications, especially where high durability is required. Mode/serial plate labels, caution labels, etc. Polyimide This material gives the best performance on heat resistance (greater than PET film). It is often used for PCB labels as it can withstand passage through a solder bath.

7.3 Recommended Media and Ribbon Types (Cont.)

Ribbon type	Description
Smear-less ribbon (Wax resin ribbon)	Good match for coated paper. The printed image will resist water and light rubbing.
Scratch and solvent resistance ribbon	Very good match for plastic films (synthetic paper, PET, polyimide, etc.) Scratch and solvent resistance Heat resistance with PET and polyimide.

Combination of Media and Ribbon

Media type	Vellum paper and label	Coated paper	Plastic films
Smear-less ribbon (wax-resin ribbon)		○	
Scratch/solvent resistance ribbon			○

○: Good match

7.4 Care/Handling of Media and Ribbon

CAUTION!

Be sure to carefully review and understand the Supply Manual. Use only media and ribbons that meet specified requirements. Use of non-specified media and ribbons may shorten the head life and result in problems with bar code readability or print quality. All media and ribbons should be handled with care to avoid any damage to the media, ribbons or printer. Read the guidelines in this section carefully.

- Do not store the media or ribbon for longer than the manufacturer's recommended shelf life.
- Store media rolls on the flat end. Do not store them on the curved sides as this might flatten that side causing erratic media advance and poor print quality.
- Store the media in plastic bags and always reseal after opening. Unprotected media can get dirty and the extra abrasion from the dust and dirt particles will shorten the print head life.
- Store the media and ribbon in a cool, dry place. Avoid areas where they would be exposed to direct sunlight, high temperature, high humidity, dust or gas.
- The thermal paper used for direct thermal printing must not have specifications which exceed Na⁺ 800 ppm, K⁺ 250 ppm and Cl⁻ 500 ppm.
- Some ink used on pre-printed media may contain ingredients which shorten the print head's product life. Do not use labels pre-printed with ink which contain hard substances such as carbonic calcium (CaCO₃) and kaolin (Al₂O₃, 2SiO₂, 2H₂O).

For further information, please contact your local distributor or your media and ribbon manufacturers.

APPENDIX 1 MESSAGES AND LEDS

Appendix 1 describes the LCD messages displayed on the operation panel.

Symbols in the message

- 1: ○: The LED is illuminated. ⊙: The LED is flashing. ●: The LED is unlit.
- 2: ****: the number of unprinted media. Up to 9999 (in pieces)
- 3: %%,%%%,%%%: Remaining memory size of the external memory: 0 to 09,999,999 (in K bytes)
- 4: ####: Remaining memory size for PC commands storage area in the internal memory: 0 to 3072 (in K bytes)
- 5: &&&&: Remaining memory size for writable characters storage area: 0 to 3147 (in K bytes)

No.	LCD Message	LED Indication		Printer Status	Restoration by RESTART key Yes/No	Acceptance of Status Request/ Reset Command Yes/No
		ONLINE	ERROR			
1	ON LINE	○	●	In online mode	----	Yes
	ON LINE	⊙	●	In online mode (The printer in communication)	----	Yes
2	HEAD OPEN	●	●	The print head block is opened in online mode.	----	Yes
3	PAUSE	●	●	The printer is paused.	Yes	Yes
4	COMMS ERROR	●	○	A parity, overrun, or framing error has occurred during communication through the RS-232C.	Yes	Yes
5	PAPER JAM	●	○	The media is jammed during paper feed.	Yes	Yes
6	CUTTER ERROR	●	○	A problem has occurred with the cutter module.	Yes	Yes
7	NO PAPER	●	○	The media has run out, or the media is not loaded properly.	Yes	Yes
8	NO RIBBON	●	○	The ribbon has run out.	Yes	Yes
9	HEAD OPEN	●	○	Feed or printing was attempted with the print head block open.	Yes	Yes
10	HEAD ERROR	●	○	There is a problem with the print head.	Yes	Yes
11	EXCESS HEAD TEMP	●	○	The print head is overheated.	No	Yes
12	RIBBON ERROR	●	○	The ribbon has been torn. A problem has occurred with the sensor that determines the torque for the ribbon motor.	Yes	Yes
13	REWIND FULL	●	○	An overflow error has occurred in the rewinder unit.	Yes	Yes
14	SAVING####KB&&&&KB or SAVING%,%%%,%%%KB	○	●	Writable character or PC command save mode	----	Yes
15	FORMAT####KB&&&&KB or FORMAT%,%%%,%%%KB	○	●	The storage area is being initialised.	----	Yes
16	NOW LOADING...	○	●	TrueType font or BASIC program is being downloaded.	----	Yes
17	MEMORY WRITE ERR.	●	○	An error has occurred while writing to flash memory or USB memory.	No	Yes
18	FORMAT ERROR	●	○	An erase error has occurred while formatting the flash memory or USB memory.	No	Yes
19	MEMORY FULL	●	○	Data cannot be stored because the flash memory or USB memory is full.	No	Yes
20	Display of error message (See Notes.)	●	○	A command error has occurred while analyzing the command.	Yes	Yes

No.	LCD Message	LED Indication		Printer Status	Restoration by RESTART key Yes/No	Acceptance of Status Request/ Reset Command Yes/No
		ONLINE	ERROR			
21	POWER FAILURE	●	○	A power failure has occurred.	No	No
22	EEPROM ERROR	●	○	Data cannot be read from/written to a backup EEPROM properly	No	No
23	SYSTEM ERROR	●	○	When the following abnormal operations are performed, a system error occurs: (a) Command fetch from an odd address (b) Access to word data at an odd address (c) Access to long-word data at an odd address (d) Access to the area of 80000000H to FFFFFFFFH in the logic space in user mode. (e) An undefined instruction in an area other than a delay slot was decoded. (f) An undefined instruction in a delay slot was decoded. (g) An instruction to rewrite a delay slot was decoded.	No	No
24	DHCP CLIENT INITIALIZING...	●	●	DHCP Client is being initialised. (Only when the DHCP is enabled.)	----	----
25	RFID WRITE ERROR	●	○	The printer did not succeed in writing data onto an RFID tag after having retried for a specified times.	Yes	Yes
26	RFID ERROR	●	○	The printer cannot communicate with the RFID module	Yes	Yes
27	LOW BATTERY	●	○	The voltage of the Real Time Clock Battery is low level.	No	Yes
28	INPUT PASSWORD	●	●	The printer is waiting for a password to be entered.	No	No
29	PASSWORD INVALID Please Power OFF	●	●	A wrong password was entered consecutively for three times.	No	No

NOTE: When an error message listed above appears on the LCD message display, please refer to **Section 5 TROUBLESHOOTING** for solution.

NOTES:

- If a command error is found in the command received, up to 42 bytes of the erroneous command, starting from the command code, will be displayed. (However, [LF] and [NUL] will not be displayed.)

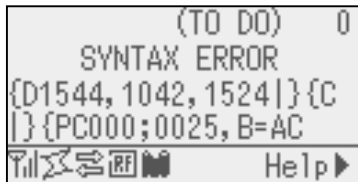

Example 1

[ESC]PC001;0A00,0300,2,2,A,00,B[LF][NUL]

└── Command error

The following message appears.

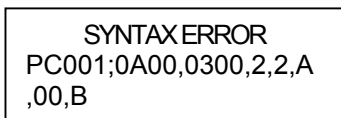

Example 2

[ESC]T20G30[LF] [NUL]

└── Command error

The following message appears.

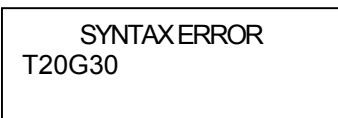

Example 3

[ESC]PC002;0100,0300,15,15,A,00,00,J0101,+000000000A,Z10,P1[LF] [NUL]

└── Command error

The following message appears.

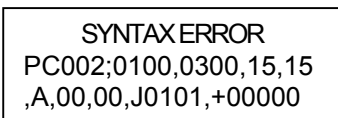

- When the error command is shown, “? (3FH)” appears for codes other than codes 20H to 7FH and A0H to DFH.
- The battery level is not checked when the printer is reset or real time clock is not installed.
- For details, please refer to the **B-EX4T/EX6T Series External Equipment Interface Specification**.

APPENDIX 2 INTERFACE

NOTE:

To prevent radiation and reception of electrical noise, the interface cables must meet the following requirements:

- In case of a parallel interface cable or serial interface cable, fully shielded and fitted with metal or metallised connector housings.
- Keep as short as possible.
- Should not be bundled tightly with power cords.
- Should not be tied to power line conduits.
- A parallel interface cable to be used should conform to IEEE1284.

■ USB interface (Standard)

Physical Layer: Conforming to V2.0 Full speed
 Transfer type: Control transfer, Bulk transfer
 Transfer rate: Full speed (12M bps)
 Class: Printer class
 Number of ports: 1
 Power source: Self power
 Connector: Type B

Pin No.	Signal
1	VCC
2	D-
3	D+
4	GND



Series B Plug

■ LAN (Standard)

Physical Layer: IEEE802.3 10BASE-T/100BASE-TX
 Number of ports: 1
 Connector: RJ-45
 LED status: Link LED, Activity LED

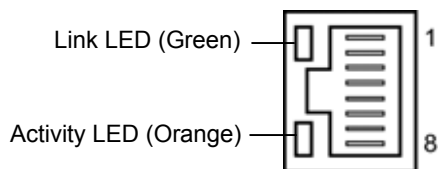

LED	LED Status	LAN status
Link	ON	10Mbps link or 100Mbps link is detected.
	OFF	No link is detected. * Communication cannot be made while the Link LED is off.
Activity	ON	Communicating
	OFF	Idle

LAN cable: 10BASE-T: UTP category 3 or category 5
 100BASE-TX: UTP category 5
 Cable length: Segment length Max. 100 m

NOTE:

When a generally-used twisted pair Ethernet (TPE) or UTP cable is used, a communication error may occur depending on your operating environment. In such case, you may be requested to use a shielded twisted pair cable.

■ **Serial interface (Option: B-EX700-RS-QM-R)**

Type: RS-232C
 Communication mode: Full duplex
 Transmission speed: 2400 bps, 4800 bps, 9600 bps, 19200 bps, 38400 bps, 115200 bps
 Synchronization: Start-stop synchronization
 Start bit: 1 bit
 Stop bit: 1 bit, 2 bit
 Data length: 7 bit, 8 bit
 Parity: None, EVEN, ODD
 Error detection: Parity error, Framing error, Overrun error
 Protocol: Unprocedure communication
 Data input code: ASCII code, European character 8 bit code, graphic 8 bit code, JIS8 code, Shift JIS Kanji code, JIS Kanji code
 Receive buffer: 1M byte
 Connector:

Pin No.	Signal
1	N.C
2	TXD (Transmit Data)
3	RXD (Received Data)
4	DSR (Data Set Ready)
5	SG (Signal Ground)
6	DTR (Data Terminal Ready)
7	CTS (Clear to Send)
8	RTS (Request to Send)
9	N.C

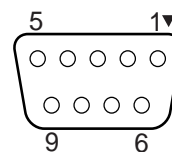

■ **Parallel interface (Centronics) (Option: B-EX700-CEN-QM-R)**

Mode: Conforming to IEEE1284
 Compatible mode (SPP mode), Nibble mode
 Data input method: 8 bit parallel
 Control signal:

SPP Mode	Nibble Mode	ECP Mode
nStrobe	HostClk	HostClk
nAck	PtrClk	PeriphClk
Busy	PtrBusy	PeriphAck
Perror	AckDataReq	NAckReverse
Select	Xflag	Xflag
nAutoFd	HostBusy	HostAck
nInIt	nInIt	nReverseRequest
nFault	nDataAvail	nPeriphRequest
nSelectIn	IEEE1284Active	IEEE1284Active

Data input code: ASCII code
 European 8 bit code
 Graphic 8 bit code
 JIS8 code
 Shift JIS Kanji code
 JIS Kanji code
 Receive buffer: 6M byte

Connector:

PIN No.	Signal		
	SPP Mode	Nibble Mode	ECP Mode
1	nStrobe	HostClk	HostClk
2	Data 1	Data 1	Data 1
3	Data 2	Data 2	Data 2
4	Data 3	Data 3	Data 3
5	Data 4	Data 4	Data 4
6	Data 5	Data 5	Data 5
7	Data 6	Data 6	Data 6
8	Data 7	Data 7	Data 7
9	Data 8	Data 8	Data 8
10	nAck	PtrClk	PeriphClk
11	Busy	PtrBusy	PeriphAck
12	PError	AckDataReq	nAckReverse
13	Select	Xflag	XFlag
14	nAutoFd	HostBusy	HstAck
15	NC	NC	NC
16	0V	0V	0V
17	CHASSIS GND	CHASSIS GND	CHASSIS GND
18	+5V (For detection)	+5V (For detection)	+5V (For detection)
19	TWISTED PAIR GND(PIN1)	TWISTED PAIR GND(PIN1)	TWISTED PAIR GND(PIN1)
20	TWISTED PAIR GND(PIN2)	TWISTED PAIR GND(PIN2)	TWISTED PAIR GND(PIN2)
21	TWISTED PAIR GND(PIN3)	TWISTED PAIR GND(PIN3)	TWISTED PAIR GND(PIN3)
22	TWISTED PAIR GND(PIN4)	TWISTED PAIR GND(PIN4)	TWISTED PAIR GND(PIN4)
23	TWISTED PAIR GND(PIN5)	TWISTED PAIR GND(PIN5)	TWISTED PAIR GND(PIN5)
24	TWISTED PAIR GND(PIN6)	TWISTED PAIR GND(PIN6)	TWISTED PAIR GND(PIN6)
25	TWISTED PAIR GND(PIN7)	TWISTED PAIR GND(PIN7)	TWISTED PAIR GND(PIN7)
26	TWISTED PAIR GND(PIN8)	TWISTED PAIR GND(PIN8)	TWISTED PAIR GND(PIN8)
27	TWISTED PAIR GND(PIN9)	TWISTED PAIR GND(PIN9)	TWISTED PAIR GND(PIN9)
28	TWISTED PAIR GND(PIN10)	TWISTED PAIR GND(PIN10)	TWISTED PAIR GND(PIN10)
29	TWISTED PAIR GND(PIN11)	TWISTED PAIR GND(PIN11)	TWISTED PAIR GND(PIN11)
30	TWISTED PAIR GND(PIN31)	TWISTED PAIR GND(PIN31)	TWISTED PAIR GND(PIN31)
31	nInit	nInit	nReverseRequest
32	nFault	NDataAvail	nPeriphRequest
33	0V	0V	0V
34	NC	NC	NC
35	NC	NC	NC
36	nSelectIn	IEEE1284Active	IEEE1284Active

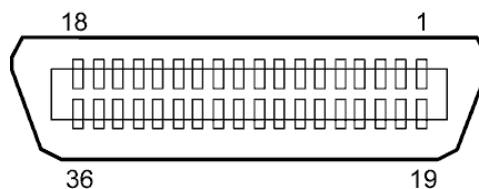

IEEE1284-B Connector

■ Wireless LAN (Option: B-EX700-WLAN-QM-R)

Standard:	Conforming to IEEE802.11b, and IEEE802.11g
Client protocol:	TCP/IP, Socket, LPD (LLPR), DHCP/WINS, HTTPD (SNMP)
Print protocol:	Socket communication/LPR
Security protocol:	WEP (64 bits/128 bits) or AES, TKIP (only when using WPA, WPA-PSK) Shared key (for WEP), PSK, PEAP, TLS, TTLS, MD5, LEAP, EAP-FAST
Antenna:	Built-in
Parameter setting:	via USB, LAN, WLAN, RS-232C, Parallel
Default IP address:	192.168.10.21
Default subnet mask:	255.255.255.0
Certification:	Wi-Fi, CCX V3, V4

NOTE:

MAC address of the Wireless LAN module will be necessary when setting the MAC address filtering function of an access point. Please ask a service person of your nearest TOSHIBA TEC service representative.

■ USB Host interface (Option: B-EX700-RTC-QM-R)

Physical Layer:	Conforming to V2.0 Full speed
Transfer type:	Control transfer, Bulk transfer
Transfer rate:	Full speed (12M bps)
Number of ports:	1
Power supply:	50mA output
Connector:	Type A

■ Expansion I/O Interface (Option: B-EX700-IO-QM-R)

Input Signal IN0 to IN5
 Output Signal OUT0 to OUT6
 Connector (External Device Side) FCN-781P024-G/P or equivalent
 Connector (Printer Side) FCN-685J0024 or equivalent

Pin	Signal	I/O	Function	Pin	Signal	I/O	Function
1	IN0	Input	FEED	13	OUT6	Output	
2	IN1	Input	PRINT	14	N.C.	----	
3	IN2	Input	PAUSE	15	COM1	Common (Power)	
4	IN3	Input		16	N.C.	----	
5	IN4	Input		17	N.C.	----	
6	IN5	Input		18	N.C.	----	
7	OUT0	Output	FEED	19	N.C.	----	
8	OUT1	Output	PRINT	20	N.C.	----	
9	OUT2	Output	PAUSE	21	COM2	Common (Ground)	
10	OUT3	Output	ERROR	22	N.C.	----	
11	OUT4	Output		23	N.C.	----	
12	OUT5	Output	POWER ON	24	N.C.	----	

N.C.: No Connection

Input Circuit

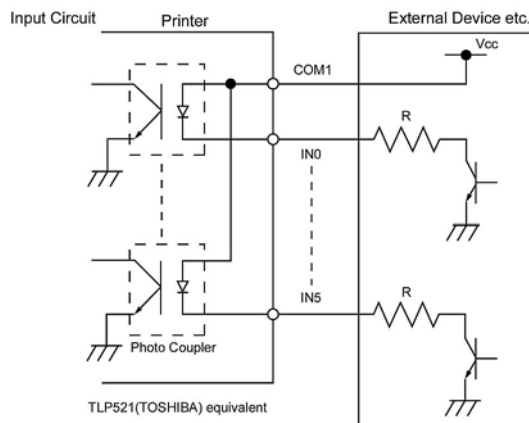

Output Circuit

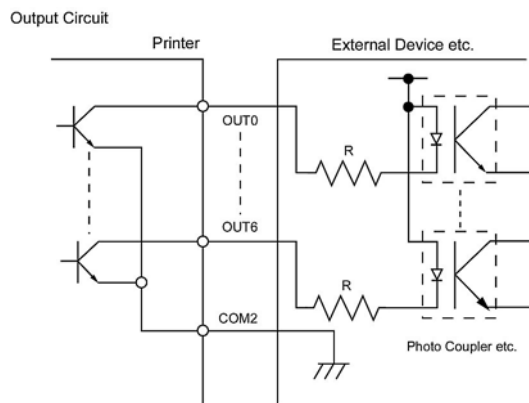

Operating environment Temperature: 0 to 40 °C
 Humidity: 20 to 90% (No Condensation)

■ RFID (Option)**• B-EX700-RFID-U2-US-R**

Module: TOSHIBATEC TEC TRW-USM-01
Frequency: US settings: 902.75-927.25MHz (UHF US)
AU settings: 918.25-925.75MHz (UHF Australia)
TW settings: 922.25-927.25MHz (UHF Taiwan)
KR settings: 910.4-913.6MHz (UHF Korea)
Output: 10 to 100 mW
Available RFID tag: EPC C1 Gen2, IOS-18000-6C

• B-EX700-RFID-U2-EU-R

Module: TOSHIBATEC TEC TRW-EUM-01
Frequency: 869.85 MHz (UHF Europe)
865.2-866.8MHz (UHF India)
Output: 10 to 100 mW
Available RFID tag: EPC C1 Gen2, ISO-18000-6C

• B-EX700-RFID-H1-QM-R

Module: TagSysm MEDIO S002 (Not included in this optional kit.)
Frequency: 13.56MHz
Output: 200 mW
Available RFID tag: TagSys C210, C220, C240, I-Code, Tag-it, ISO15693

APPENDIX 3 PRINT SAMPLES

■ Font

<A>Times Roman medium

Times Roman medium

<C>Times Roman bold

<D>Times Roman bold

<E>Times Roman bold

<F>*Times Roman italic*

<G>Helvetica medium

<H>Helvetica medium

<I>Helvetica medium

<J>Helvetica bold

<K>Helvetica bold

<L>*Helvetica italic*

<M>**PRESENTATION BOLD**

<N>Letter Gothic medium

<O>Prestige Elite medium

<P>Prestige Elite bold

<Q>Courier medium

<R>Courier bold

<S>OCR-A

<T>OCR-B

<q>Gothic 725 Black

<Outline Font:A> **H e l v e t i c a b o l d**

<Outline Font:B> **Helvetica bold(P)**

<Outline Font:E> *0 1 2 3 4 5 6 7 8 9, y \$*

<Outline Font:F> **0 1 2 3 4 5 6 7 8 9, ¥ \$**

<Outline Font:G> **0 1 2 3 4 5 6 7 8 9, ¥ \$**

<Outline Font:H> **Dutch 801 bold**

<Outline Font:I> *Brush 738 regular*

<Outline Font:J> **Gothic 725 Black**

APPENDIX 3 PRINT SAMPLES (Cont.)

■ Bar codes

JAN8, EAN8



Interleaved 2 of 5



NW7



UPC-E



EAN13+5 digits



CODE39 (Full ASCII)



UPC-E+2 digits



EAN8+2 digits



UPC-A



MSI



CODE39 (Standard)



JAN13, EAN13



EAN13+2 digits



CODE128



CODE93



UPC-E+5 digits



EAN8+5 digits



UPC-A+2 digits



UPC-A+5 digits



UCC/EAN128



Industrial 2 of 5



POSTNET



Customer bar code



Customer bar code of high priority



KIX Code



RM4SCC



Data Matrix



MicroQR



QR code



Micro PDF417



MaxiCode

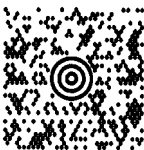

CP Code



PDF417



• **GS1 DataBar family (with no compound composite printed)**

GS1 DataBar (Truncated)



GS1 DataBar Stacked



GS1 DataBar Stacked Omnidirectional



GS1 DataBar Limited



GS1 DataBar Expanded



GS1 DataBar Expanded Stacked



UPC-A

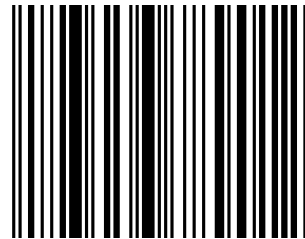

UPC-E

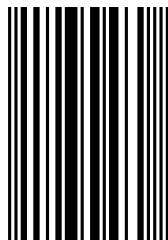

EAN-13

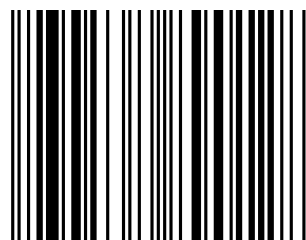

EAN-8

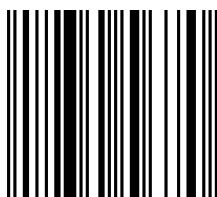

UCC/EAN-28 with CC-A, CC-B, or CC-C



• **GS1 DataBar family (with compound composite printed)**

GS1 DataBar (Truncated)



GS1 DataBar Stacked



GS1 DataBar Stacked Omnidirectional



GS1 DataBar Limited



GS1 DataBar Expanded



GS1 DataBar Expanded Stacked

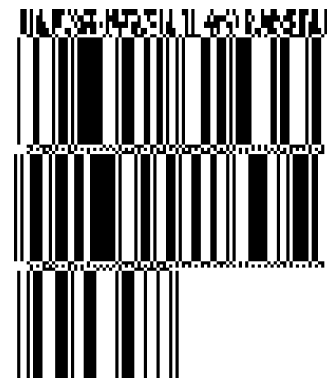

UPC-A



UPC-E



EAN-8



EAN-13



UCC/EAN-128 with CC-A or CC-B



UCC/EAN-128 with CC-C



APPENDIX 4 GLOSSARIES

Bar code

A code which represents alphanumeric characters by using a series of black and white stripes in different widths. Bar codes are used in various industrial fields: Manufacturing, Hospitals, Libraries, Retail, Transportation, Warehousing, etc. Reading bar codes is a fast and accurate means of capturing data while keyboard entry tends to be slow and inaccurate.

Batch mode

Issue mode that continuously prints media until the specified number of media has been printed.

Black mark

A mark printed on the media so that the printer can maintain a constant print position by detecting this mark.

Black mark sensor

A reflective sensor which detects the difference of potential between the black mark and print area to find the print start position.

Built-in rewinder mode

Printer mode of operation where a strip module is installed to take up printed media onto the built-in rewinder.

Cut mode

Printer mode of operation where an optional cutter module is installed to automatically cut media from the supply roll after they are printed. The print command can specify to cut every media or to cut after a set number of media have been printed.

Cutter module

A device used to cut the media.

DHCP

Dynamic Host Configuration Protocol

A communications protocol which lets a network administrator temporarily assign an IP address to a computer plugged into a different place in the network.

DPI

Dot Per Inch

The unit used to express print density.

Expansion I/O interface

An interface circuit that may be installed into printer to allow the printer to be connected to an external device such as a wrapping machine and to receive feed, print start, and pause signals from the external device and to send back print, pause, and error status signals to the external device.

Feed gap sensor

A transmissive sensor which detects the difference of potential between the gap between labels and the label to find the print position of the label.

Font

A complete set of alphanumeric characters in one style of type. E.g. Helvetica, Courier, Times

Gap

Clearance between labels

IPS

Inch per second

The unit used to express print speed.

Label

A type of media with adhesive backing.

LCD

Liquid Crystal Display

Installed on the operation panel and displays operation modes, error message and so on.

Media

Material on which data is printed by the printer. Label, tag paper, fanfold paper, perforated paper, etc.

Plug and Play

When Plug and Play is enabled, the PC will automatically identify the printer (if the PC supports Plug & Play), optimize the system resource (IRQ and DMA), and display a message prompting a printer driver installation.

Pre-printed media

A type of media on which characters, logos, and other designs have been already printed.

Printer IP address

A 32-bit address of a printer connected to TCP/IP network, which identifies the network printer. An IP address is written as 4 sets of numbers, separated by periods.

Print head element

The thermal print head consists of a single line of tiny resistive elements and when current is allowed to flow through each element it heats up causing a small dot to be burned onto thermal paper or a small dot of ink to be transferred from a thermal ribbon to ordinary paper.

Print speed

The speed at which printing occurs. This speed is expressed in units of ips (inches per second).

Reflective sensor

See Black mark sensor.

Resolution

The degree of detail to which an image can be duplicated. The minimum unit of divided image is called a pixel. As the resolution becomes higher, the number of pixels increased, resulting in more detailed image

RFID (Radio Frequency Identification)

A method of automatically identifying people or objects using radio waves. In case of the B-SX series, the RFID module writes digital information to an RFID tag mounted inside labels or tag paper while the printer is printing data on them. The RFID tag is a microchip attached to an antenna. The microchip holds data and the antenna enables the tag to send and receive data.

Ribbon

An inked film used to transfer an image onto the media. In the thermal transfer printing, it is heated by the thermal print head, causing an image to be transferred onto the media.

Strip mode

A device used to remove labels from the backing paper.

Supply

Media and ribbon

Tag

A type of media with no adhesive. Usually tags are made of cardboard or other durable material.

Thermal direct printing

A printing method using no ribbon, but thermal media which reacts to heat. The thermal print head heats the thermal media directly, causing print image to be printed on the media.

Thermal print head

A print head using thermal transfer or thermal direct printing method.

Thermal transfer printing

A printing method that the thermal print head heats an ink or resin coating on the ribbon against the media, causing the ink/resin to transfer onto the media.

Threshold setting

A sensor setting operation to have the printer maintain a constant print position of pre-printed media.

Transmissive sensor

See Feed gap sensor.

USB (Universal Serial Bus)

An interface that is used to connect peripherals, such as a printer, keyboard, mouse. The USB allows disconnection of a USB device without turning off the power.

Web printer

The web printer function allows you to browse the printer status on the PC, issue media, check or change the settings, or download the firmware to the printer. For details, refer to the **Network Specification**.



TOSHIBA TEC CORPORATION

M EO1-33089

Free Manuals Download Website

<http://myh66.com>

<http://usermanuals.us>

<http://www.somanuals.com>

<http://www.4manuals.cc>

<http://www.manual-lib.com>

<http://www.404manual.com>

<http://www.luxmanual.com>

<http://aubethermostatmanual.com>

Golf course search by state

<http://golfingnear.com>

Email search by domain

<http://emailbydomain.com>

Auto manuals search

<http://auto.somanuals.com>

TV manuals search

<http://tv.somanuals.com>