

TEC

TEC Thermal Printer

B-SX4T SERIES

Owner's Manual



TOSHIBA TEC CORPORATION

CE Compliance (for EU only)

This product complies with the requirements of EMC and Low Voltage Directives including their amendments.

VORSICHT:

- *Schallemission: unter 70dB (A) nach DIN 45635 (oder ISO 7779)*
- *Die für das Gerät Vorgesehene Steckdose muß in der Nähe des Gerätes und leicht zugänglich sein.*

Centronics is a registered trademark of Centronics Data Computer Corp.
Microsoft is a registered trademark of Microsoft Corporation.
Windows is a trademark of Microsoft Corporation.

As an ENERGY STAR® Partner, TOSHIBA TEC has determined that this product meets the ENERGY STAR® guidelines for energy efficiency.



-- Outline of the International ENERGY STAR® Office Equipment Program --

The International ENERGY STAR® Office Equipment Program is an international program that promotes energy saving through the penetration of energy efficient computers and other office equipment. The program backs the development and dissemination of products with functions that effectively reduce energy consumption. It is an open system in which business proprietors can participate voluntarily. The targeted products are office equipment such as computers, monitors, printers, facsimiles, copiers, scanners, and multifunction devices. Their standards and logos are uniform among participating nations.

ENERGY STAR is a U.S. registered mark.

This equipment has been tested and found to comply with the limits for a Class A digital device, pursuant to Part 15 of the FCC Rules. These limits are designed to provide reasonable protection against harmful interference when the equipment is operated in a commercial environment. This equipment generates, uses, and can radiate radio frequency energy and, if not installed and used in accordance with the instruction manual, may cause harmful interference to radio communications. Operations of this equipment in a residential area is likely to cause harmful interference in which case the user will be required to correct the interference at his own expense.

(for USA only)

Changes or modifications not expressly approved by manufacturer for compliance could void the user's authority to operate the equipment.

"This Class A digital apparatus meets all requirements of the Canadian Interference-Causing Equipment Regulations."

"Cet appareil numérique de la classe A respecte toutes les exigences du Règlement sur le matériel brouilleur du Canada."

(for CANADA only)



Copyright © 2003
by TOSHIBA TEC CORPORATION
All Rights Reserved
570 Ohito, Ohito-cho, Tagata-gun, Shizuoka-ken, JAPAN

Safety Summary

Personal safety in handling or maintaining the equipment is extremely important. Warnings and Cautions necessary for safe handling are included in this manual. All warnings and cautions contained in this manual should be read and understood before handling or maintaining the equipment.

Do not attempt to effect repairs or modifications to this equipment. If a fault occurs that cannot be rectified using the procedures described in this manual, turn off the power, unplug the machine, then contact your authorised TOSHIBA TEC representative for assistance.

Meanings of Each Symbol



This symbol indicates warning items (including cautions). Specific warning contents are drawn inside the Δ symbol. (The symbol on the left indicates a general caution.)



This symbol indicates prohibited actions (prohibited items). Specific prohibited contents are drawn inside or near the $\text{\textcircled{X}}$ symbol. (The symbol on the left indicates “no disassembling”.)



This symbol indicates actions which must be performed. Specific instructions are drawn inside or near the \bullet symbol. (The symbol on the left indicates “disconnect the power cord plug from the outlet”.)



WARNING

This indicates that there is the risk of **death** or **serious injury** if the machines are improperly handled contrary to this indication.

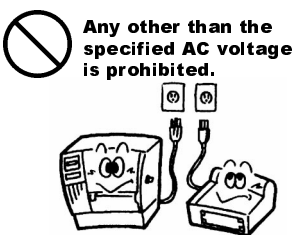

Do not use voltages other than the voltage (AC) specified on the rating plate, as this may cause **fire** or **electric shock**.



Prohibited

Do not plug in or unplug the power cord plug with wet hands as this may cause **electric shock**.



Prohibited

If the machines share the same outlet with any other electrical appliances that consume large amounts of power, the voltage will fluctuate widely each time these appliances operate. Be sure to provide an exclusive outlet for the machine as this may cause **fire** or **electric shock**.



Prohibited

Do not place metal objects or water-filled containers such as flower vases, flower pots or mugs, etc. on top of the machines. If metal objects or spilled liquid enter the machines, this may cause **fire** or **electric shock**.



Prohibited

Do not insert or drop metal, flammable or other foreign objects into the machines through the ventilation slits, as this may cause **fire** or **electric shock**.



Prohibited

Do not scratch, damage or modify the power cords. Also, do not place heavy objects on, pull on, or excessively bend the cords, as this may cause **fire** or **electrical shock**.

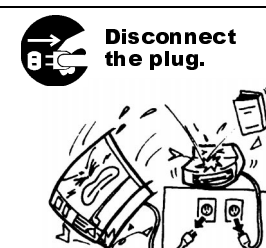





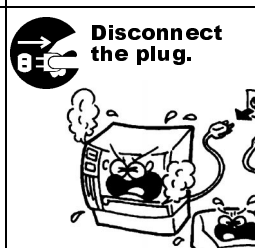

Disconnect the plug.

If the machines are dropped or their cabinets damaged, first turn off the power switches and disconnect the power cord plugs from the outlet, and then contact your authorised TOSHIBA TEC representative for assistance. Continued use of the machine in that condition may cause **fire** or **electric shock**.

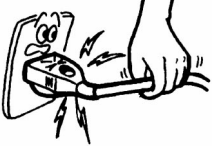

Disconnect the plug.

Continued use of the machines in an abnormal condition such as when the machines are producing smoke or strange smells may cause **fire** or **electric shock**. In these cases, immediately turn off the power switches and disconnect the power cord plugs from the outlet. Then, contact your authorised TOSHIBA TEC representative for assistance.

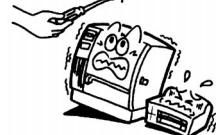
 <p>Disconnect the plug.</p> 	<p>If foreign objects (metal fragments, water, liquids) enter the machines, first turn off the power switches and disconnect the power cord plugs from the outlet, and then contact your authorised TOSHIBA TEC representative for assistance. Continued use of the machine in that condition may cause fire or electric shock.</p>	 <p>Disconnect the plug.</p> 	<p>When unplugging the power cords, be sure to hold and pull on the plug portion. Pulling on the cord portion may cut or expose the internal wires and cause fire or electric shock.</p>
 <p>Connect a grounding wire.</p> 	<p>Ensure that the equipment is properly grounded. Extension cables should also be grounded. Fire or electric shock could occur on improperly grounded equipment.</p>	 <p>No disassembling.</p> 	<p>Do not remove covers, repair or modify the machine by yourself. You may be injured by high voltage, very hot parts or sharp edges inside the machine.</p>



CAUTION

This indicates that there is the risk of personal **Injury** or **damage** to objects if the machines are improperly handled contrary to this indication.

Precautions

The following precautions will help to ensure that this machine will continue to function correctly.

- Try to avoid locations that have the following adverse conditions:
 - * Temperatures out of the specification
 - * Shared power source
- * Direct sunlight
- * Excessive vibration
- * High humidity
- * Dust/Gas
- The cover should be cleaned by wiping with a dry cloth or a cloth slightly dampened with a mild detergent solution. NEVER USE THINNER OR ANY OTHER VOLATILE SOLVENT on the plastic covers.
- USE ONLY TOSHIBA TEC SPECIFIED paper and ribbons.
- DO NOT STORE the paper or ribbons where they might be exposed to direct sunlight, high temperatures, high humidity, dust, or gas.
- Ensure the printer is operated on a level surface.
- Any data stored in the memory of the printer could be lost during a printer fault.
- Try to avoid using this equipment on the same power supply as high voltage equipment or equipment likely to cause mains interference.
- Unplug the machine whenever you are working inside it or cleaning it.
- Keep your work environment static free.
- Do not place heavy objects on top of the machines, as these items may become unbalanced and fall causing **injury**.
- Do not block the ventilation slits of the machines, as this will cause heat to build up inside the machines and may cause **fire**.
- Do not lean against the machine. It may fall on you and could cause **injury**.
- Care must be taken not to injure yourself with the printer paper cutter.
- Unplug the machine when it is not used for a long period of time.
- Place the machine on a stable and level surface.

Request Regarding Maintenance

- Utilize our maintenance services.
After purchasing the machine, contact your authorised TOSHIBA TEC representative for assistance once a year to have the inside of the machine cleaned. Otherwise, dust will build up inside the machines and may cause a **fire** or a **malfunction**. Cleaning is particularly effective before humid rainy seasons.
- Our preventive maintenance service performs the periodic checks and other work required to maintain the quality and performance of the machines, preventing accidents beforehand.
For details, please consult your authorised TOSHIBA TEC representative for assistance.
- Using insecticides and other chemicals
Do not expose the machines to insecticides or other volatile solvents. This will cause the cabinet or other parts to deteriorate or cause the paint to peel.

TABLE OF CONTENTS

	Page
1. PRODUCT OVERVIEW	E1-1
1.1 Introduction	E1-1
1.2 Features.....	E1-1
1.3 Unpacking.....	E1-1
1.4 Accessories	E1-2
1.5 Appearance.....	E1-3
1.5.1 Dimensions	E1-3
1.5.2 Front View.....	E1-3
1.5.3 Rear View	E1-3
1.5.4 Operation Panel.....	E1-4
1.5.5 Interior.....	E1-4
2. PRINTER SETUP.....	E2-1
2.1 Precautions	E2-1
2.2 Procedure before Operation	E2-2
2.3 Fitting the Fan Filter	E2-2
2.4 Connecting the Cables to Your Printer	E2-3
2.5 Connecting the Power Cord	E2-4
2.6 Turning the Printer ON/OFF	E2-5
2.6.1 Turning ON the Printer.....	E2-5
2.6.2 Turning OFF the Printer.....	E2-5
2.7 Loading the Media.....	E2-6
2.8 Loading the Ribbon	E2-11
2.9 Inserting the Optional PCMCIA Cards	E2-13
2.10 Test Print.....	E2-14
3. ON LINE MODE.....	E3-1
3.1 Operation Panel	E3-1
3.2 Operation	E3-2
3.3 Reset.....	E3-2
3.4 Dump Mode.....	E3-3
4. MAINTENANCE.....	E4-1
4.1 Cleaning.....	E4-1
4.1.1 Print Head/Platen/Sensors	E4-1
4.1.2 Covers and Panels	E4-2
4.1.3 Optional Cutter Module.....	E4-3
4.2 Care/Handling of the Media and Ribbon.....	E4-3
5. TROUBLESHOOTING	E5-1
5.1 Error Messages.....	E5-1
5.2 Possible Problems.....	E5-2
5.3 Removing Jammed Media.....	E5-3
5.4 Threshold Setting	E5-4

APPENDIX 1 SPECIFICATIONS.....	EA1-1
A1.1 Printer	EA1-1
A1.2 Options	EA1-2
A1.3 Media	EA1-2
A1.3.1 Media Type.....	EA1-2
A1.3.2 Detection Area of the Transmissive Sensor	EA1-3
A1.3.3 Detection Area of the Reflective Sensor.....	EA1-4
A1.3.4 Effective Print Area.....	EA1-4
A1.4 Ribbon	EA1-5
APPENDIX 2 MESSAGES AND LEDS	EA2-1
APPENDIX 3 INTERFACE	EA3-1
APPENDIX 4 PRINT SAMPLES.....	EA4-1
GLOSSARIES	
INDEX	

WARNING!

This is a Class A product. In a domestic environment this product may cause radio interference in which case the user may be required to take adequate measures.

CAUTION!

1. *This manual may not be copied in whole or in part without prior written permission of TOSHIBA TEC.*
2. *The contents of this manual may be changed without notification.*
3. *Please refer to your local Authorised Service representative with regard to any queries you may have in this manual.*

1. PRODUCT OVERVIEW

1.1 Introduction

Thank you for choosing the TEC B-SX4T series thermal printer. This Owner's Manual contains from general set-up through how to confirm the printer operation using a test print, and should be read carefully to help gain maximum performance and life from your printer. For most queries please refer to this manual and keep it safe for future reference. Please contact your TOSHIBA TEC representative for further information concerning this manual.

1.2 Features

This printer has the following features:

- The print head block can be opened providing smooth loading of media and ribbon.
- Various kinds of media can be used as the media sensors can be moved from the centre to the left edge of the media.
- When the optional interface board is installed, Web functions such as remote maintenance and other advanced network features are available.
- Superior hardware, including the specially developed 8 dots/mm (203 dots/inch) thermal print head which will allow very clear print at a printing speed of 76.2 mm/sec. (3 inches/sec.), 152.4 mm/sec. (6 inches/sec.), or 254.0 mm/sec. (10 inches/sec.).
- Besides the optional Cutter Module, there is also an optional Strip Module, Ribbon Saving Module, PCMCIA Interface Board, Expansion I/O Interface Board, LAN Interface Board, and the USB Interface Board.

1.3 Unpacking

Unpack the printer as per the Unpacking Instructions supplied with the printer.

NOTES:

1. Check for damage or scratches on the printer. However, please note that TOSHIBA TEC shall have no liability for any damage of any kind sustained during transportation of the product.
2. Keep the cartons and pads for future transportation of the printer.

1.4 Accessories

When unpacking the printer, please make sure all the following accessories are supplied with the printer.

- US Power Cord (1 pc.)
(P/No. FBCB0030203)
QQ model only

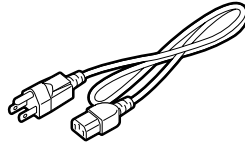

- EU Power Cord (1 pc.)
(P/No. EKA-0030001)
QP model only

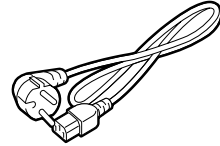

- CD-ROM (1 pc.)
QQ (P/No.: 7FM00332100)
QP (P/No.: 7FM00256100)

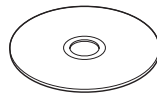

- Fan Filter (1 pc.)
(P/No. FMBB0036801)

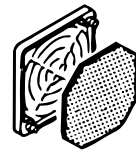

- Warranty Disclaimer Sheet (1 sheet)
QQ-US model only

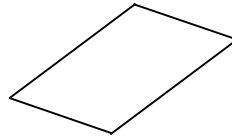

1.5 Appearance

The names of the parts or units introduced in this section are used in the following chapters.

1.5.1 Dimensions

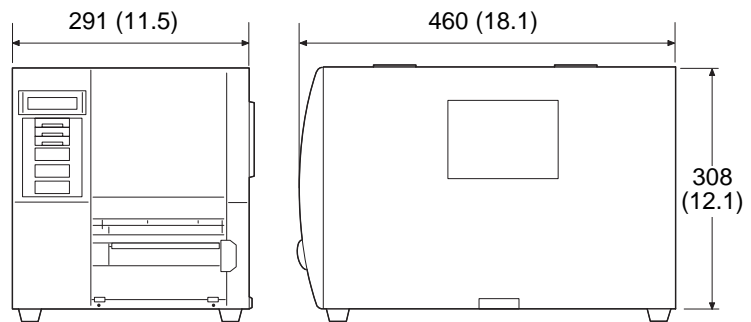

Dimensions in mm (inches)

1.5.2 Front View



1.5.3 Rear View

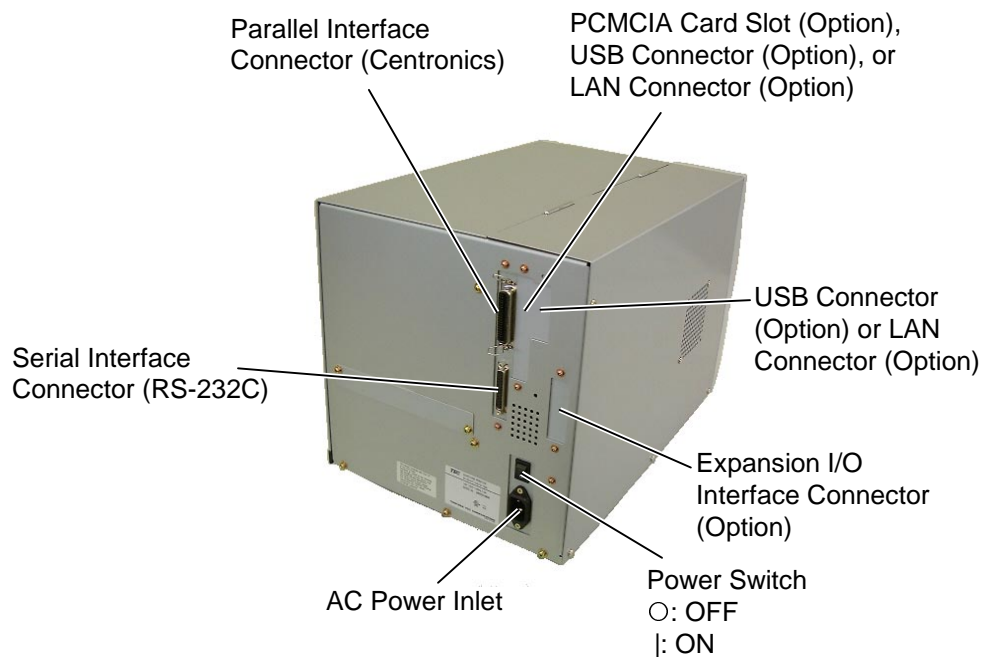

1.5.4 Operation Panel

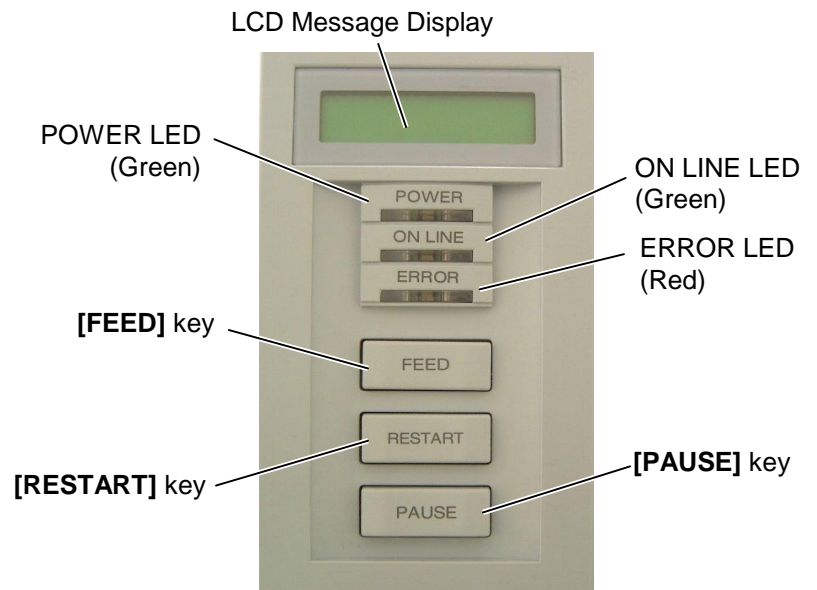

Please see Section 3.1 for further information about the Operation Panel.

1.5.5 Interior

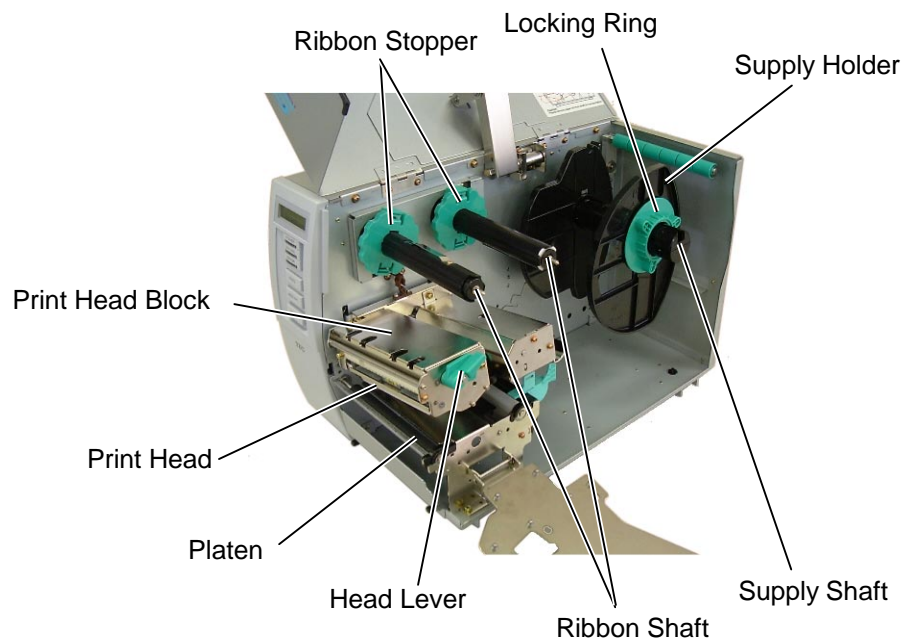

2. PRINTER SETUP

This section outlines the procedures to setup your printer prior to its operation. The section includes precautions, connecting cables, assembling accessories, loading media and ribbon, inserting the optional memory card, and performing a test print.

2.1 Precautions

To insure the best operating environment, and to assure the safety of the operator and the equipment, please observe the following precautions.

- Operate the printer on a stable, level, operating surface in a location free from excessive humidity, high temperature, dust, vibration or direct sunlight.
- Keep your work environment static free. Static discharge can cause damage to delicate internal components.
- Make sure that the printer is connected to a clean source of AC Power and that no other high voltage devices that may cause line noise interference are connected to the same mains.
- Assure that the printer is connected to the AC mains with a three-prong power cable that has the proper ground (earth) connection.
- Do not operate the printer with the cover open. Be careful not to allow fingers or articles of clothing to get caught into any of the moving parts of the printer especially the optional cutter mechanism.
- Make sure to turn off the printer power and to remove the power cord from the printer whenever working on the inside of the printer such as changing the ribbon or loading the media, or when cleaning the printer.
- For best results, and longer printer life, use only TOSHIBA TEC recommended media and ribbons.
- Store the media and ribbons in accordance with their specifications.
- This printer mechanism contains high voltage components; therefore you should never remove any of the covers of the machine as you may receive an electrical shock. Additionally, the printer contains many delicate components that may be damaged if accessed by unauthorised personnel.
- Clean the outside of the printer with a clean dry cloth or a clean cloth slightly dampened with a mild detergent solution.
- Use caution when cleaning the thermal print head as it may become very hot while printing. Wait until it has had time to cool before cleaning. Use only the TOSHIBA TEC recommended print head cleaner to clean the print head.
- Do not turn off the printer power or remove the power plug while the printer is printing or while the ON LINE lamp is blinking.

2.2 Procedure before Operation

NOTE:

To communicate with the host computer, one of the following cables is required.

- (1) RS-232C cable: 25 pins
- (2) Centronics cable: 36 pins
- (3) USB: B plug (Option)
- (4) LAN: 10 Base-T or 100 Base-TX (Option)

This section describes the outline of the printer setup.

1. Unpack the accessories and printer from the box.
2. Refer to Safety Precautions in this manual and set up the printer at a proper location.
3. Fit the Fan Filter to the printer. (Refer to Section 2.3.)
4. The host computer must have a serial, Centronics parallel, USB or LAN port. (Refer to Section 2.4.)
5. Be sure to insert the power cord plug into an AC outlet. (Refer to Section 2.5.)
6. Load the media. (Refer to Section 2.7.)
7. Adjust the position of the Feed Gap Sensor or Black Mark Sensor depending on the media being used. (Refer to Section 2.7.)
8. Load the ribbon. (Refer to Section 2.8.)
9. Turn the power ON. (Refer to Section 2.6.)
10. Perform a test print. (Refer to Section 2.10.)
11. Install the Printer Drivers. (Refer to the Printer Driver Manual.)

2.3 Fitting the Fan Filter

When installing the printer, it is important to ensure that the Fan Filter is attached before using the printer.

The Fan Filter consists of 2 parts:

- (1) Filter Pad
- (2) Filter Retainer

To fit the Fan Filter, put the Filter Pad inside the Filter Retainer and simply press into place as shown in the diagram below, ensuring connecting pins are aligned with the connecting holes.

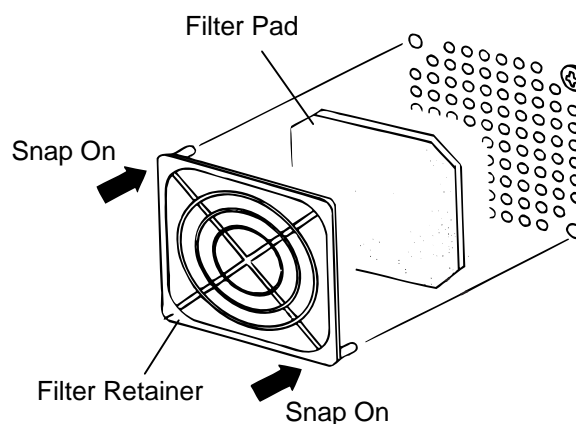

2.4 Connecting the Cables to Your Printer

The following paragraphs outline how to connect the cables from the printer to your host computer, and will also show how to make cable connections to other devices. Depending on the application software you use to print labels, there are 4 possibilities for connecting the printer to your host computer. These are:

- A serial cable connection between the printer's RS-232 serial connector and one of your host computer's COM ports. (Refer to APPENDIX 3.)
- A parallel cable connection between the printer's standard parallel connector and your host computer's parallel port (LPT).
- An Ethernet connection using the optional LAN board.
- A USB cable connection between the printer's optional USB connector and your host computer's USB port. (Conforming to USB 1.1)

NOTES:

1. The picture on the right shows the layout of the interface connectors when the options are fully installed. It may be different depending on your system configuration.
2. The USB interface and LAN interface cannot be used at the same time.

The diagram below shows all the possible cable connections to the current version of the printer.

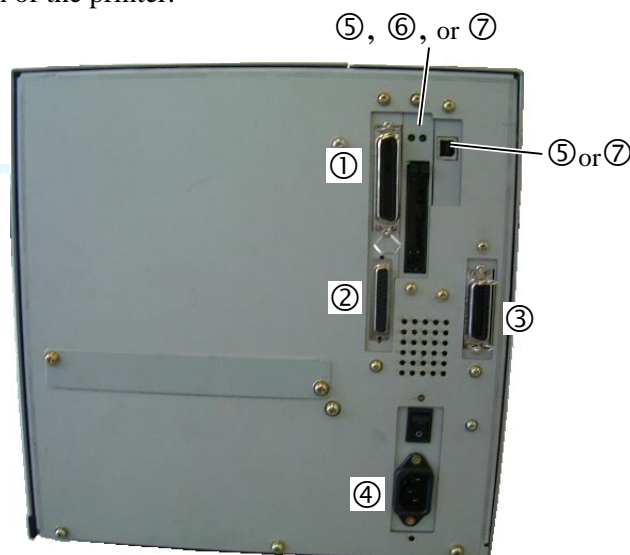

- ① Parallel Interface Connector (Centronics)
- ② Serial Interface Connector (RS-232C)
- ③ Expansion I/O Interface Connector (Option)
- ④ Power Inlet
- ⑤ USB Interface Connector (Option)
- ⑥ PCMCIA Card Slot (Option)
- ⑦ LAN Interface Connector (Option)

2.5 Connecting the Power Cord

CAUTION!

1. Make sure that the printer Power Switch is turned to the OFF (O) position before connecting the Power Cord to prevent possible electric shock or damage to the printer.
2. Use only the Power Cord supplied with the printer. Use of any other cord may cause electric shock or fire.
3. Connect the Power Cord to a supply outlet with a properly grounded (earthed) connection.

1. Make sure that the printer Power Switch is in the OFF (O) position.



Power Switch

2. Connect the Power Cord to the printer as shown in the figure below.

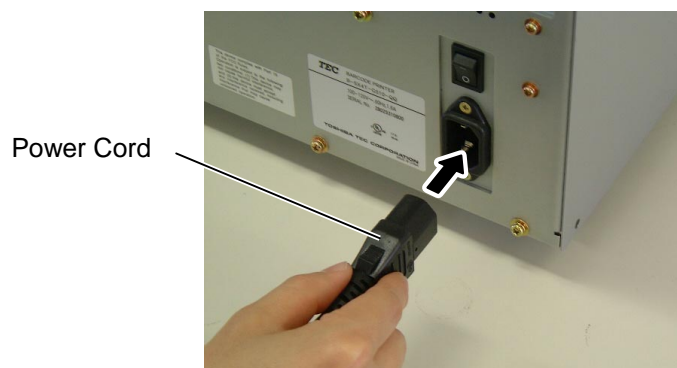

3. Plug the other end of the Power Cord into a grounded outlet as shown in the figure below.

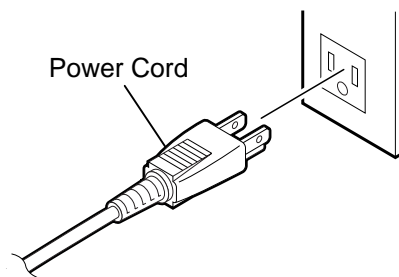

[QQ Type]

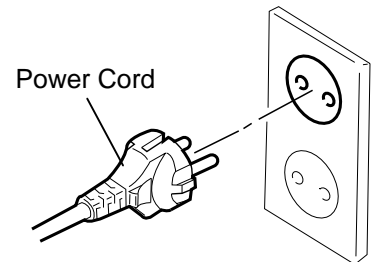

[QP Type]

2.6 Turning the Printer ON/OFF

When the printer is connected to your host computer it is good practice to turn the printer ON before turning on your host computer and turn OFF your host computer before turning off the printer.

2.6.1 Turning ON the Printer

CAUTION!

Use the power switch to turn the printer On/Off. Plugging or unplugging the Power Cord to turn the printer On/Off may cause fire, an electric shock, or damage to the printer.

NOTE:

If a message other than ON LINE appears on the display or the ERROR LED lamp is illuminated, go to Section 5.1, Error Messages.

1. To turn ON the printer power, press the Power Switch as shown in the diagram below. Note that (|) is the power ON side of the switch.



Power Switch

2. Check that the ON LINE message appears in the LCD Message Display and that the ON LINE and POWER LED lights are illuminated.

2.6.2 Turning OFF the Printer

CAUTION!

1. Do not turn off the printer power while the media is being printed as this may cause a paper jam or damage to the printer.
2. Do not turn off the printer power while the ON LINE lamp is blinking as this may cause damage to your computer.

1. Before turning off the printer Power Switch verify that the ON LINE message appears in the LCD Message Display and that the ON LINE LED light is on and is not flashing.
2. To turn OFF the printer power press the Power Switch as shown in the diagram below. Note that (O) is the power OFF side of the switch.



Power Switch

2.7 Loading the Media

WARNING!

1. Do not touch any moving parts. To reduce the risk of fingers, jewellery, clothing, etc., being drawn into the moving parts, be sure to load the media once the printer has stopped moving completely.
2. The Print Head becomes hot immediately after printing. Allow it to cool before loading the media.
3. To avoid injury, be careful not to trap your fingers while opening or closing the cover.

CAUTION!

Be careful not to touch the Print Head Element when raising the Print Head Block. Failure to do this may cause missing dots by static electricity or other print quality problems.

NOTES:

1. When the Head Lever is turned to **Free** position, the Print Head is raised.
2. To allow printing the Head Lever must be set to **Lock** position. (This ensures that the Print Head is closed.) There are two head pressure levels in the **Lock** position. Set the Head Lever depending on the media type:
 Position ①: Labels
 Position ②: Tags
 However, proper position may differ depending on media. For details, refer to TOSHIBA TEC authorised service representative.
3. Do not turn the Locking Ring counterclockwise too far or it may come off the Supply Holder.

The following procedure shows the steps to properly load the media into the printer so that it feeds straight and true through the printer.

The printer prints both labels and tags.

1. Turn off the power and open the Top Cover.
2. Turn the Head Lever to **Free** position, then release the Ribbon Shaft Holder Plate.
3. Open the Print Head Block.

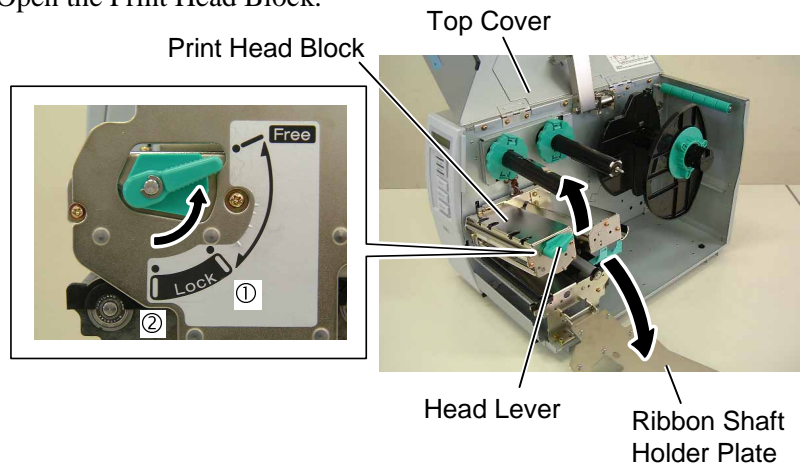

CAUTION!

When loading or replacing the media or a ribbon, be careful not to damage the print head with a hard object like a watch or a ring.

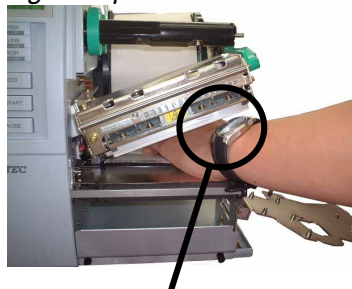

Care must be taken not to allow the metal or glass part of a watch to touch the print head edge.

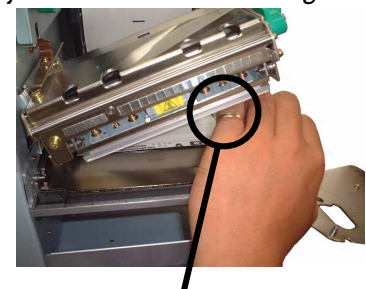

Care must be taken not to allow a metal object like a ring to touch the print head edge.

Since the print head element can be easily damaged by shock, please treat it carefully by not hitting a hard object against it.

4. Turn the Locking Ring counterclockwise and remove the Supply Holder from the Supply Shaft.

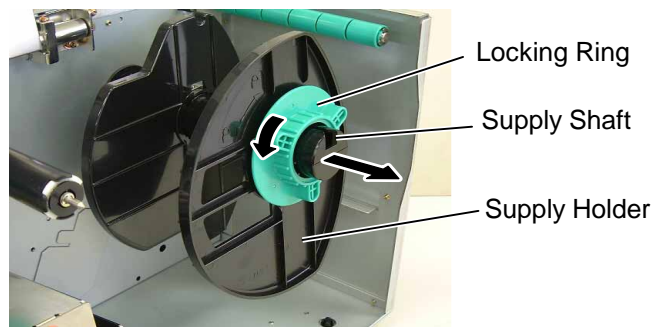

2.7 Loading the Media (Cont.)

NOTE:
Do not over-tighten the Locking Ring of the Supply Holder.

5. Put the media on the Supply Shaft.
6. Pass the media around the Damper, then pull the media towards the front of the printer.
7. Align the projection of the Supply Holder with the groove of the Supply Shaft, and push the Supply Holder against the media until the media is held firmly in place. This will center the media automatically.
Then turn the Locking Ring clockwise to secure the Supply Holder.

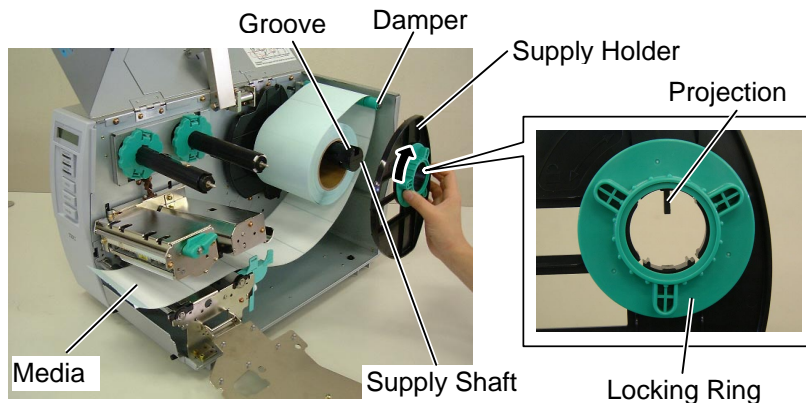

In case of a label rolled with the print side facing inside.

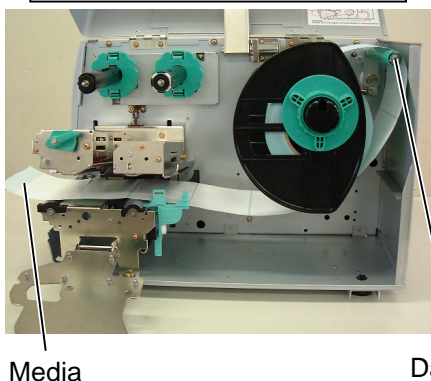

In case of a label rolled with the print side facing outside.

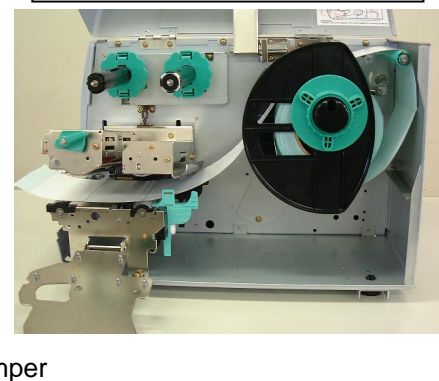

8. Place the media between the Media Guides, adjust the Media Guides to the media width, and tighten the Locking Screw.
9. Check that the media path through the printer is straight. The media should be centered under the Print Head.

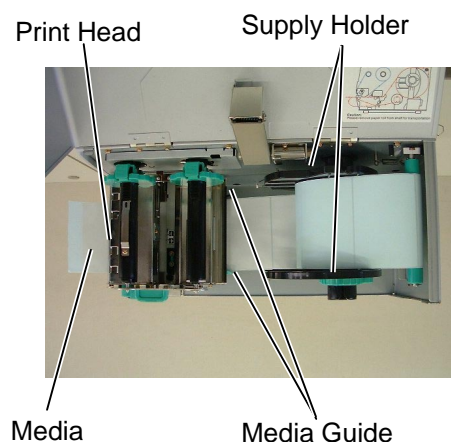
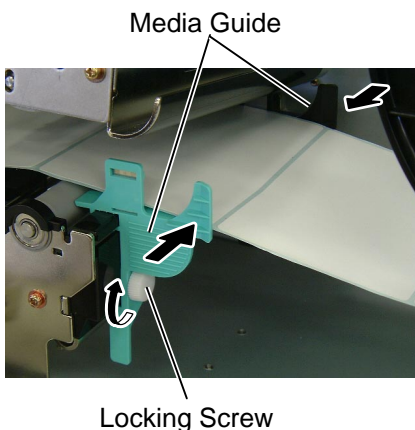

2.7 Loading the Media (Cont.)

NOTE:

Be sure to set the black mark sensor to detect the centre of the black mark, otherwise a paper jam or no paper error may occur.

10. Lower the Print Head Block until it stops.
11. After loading the media, it may be necessary to set the Media Sensors used to detect the print start position for label or tag printing.

Setting the Feed Gap Sensor position

- (1) Remove the Locking Screw that secures the Media Sensor.
- (2) Manually move the Media Sensor so that the Feed Gap Sensor is positioned at the center of the labels. (↕ indicates the position of the Feed Gap Sensor).
- (3) Tighten the Locking Screw.

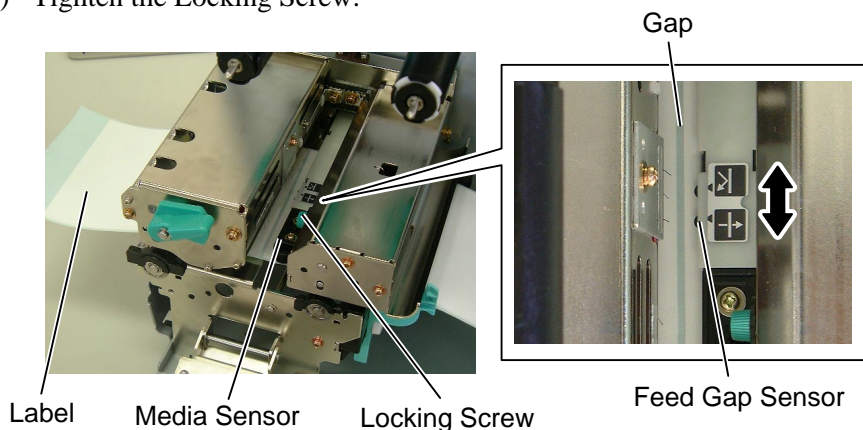

Setting the Black Mark Sensor position

- (1) Remove the Locking Screw that secures the Media Sensor.
- (2) Pull about 500 mm of media out of the front of the printer, turn the media back on itself and feed it under the Print Head past the sensor so that the black mark can be seen from above.
- (3) Manually move the Media Sensor so that the Black Mark Sensor is in line with the center of the black mark on the media. (↕ indicates the position of the Black Mark Sensor).
- (4) Tighten the Locking Screw.

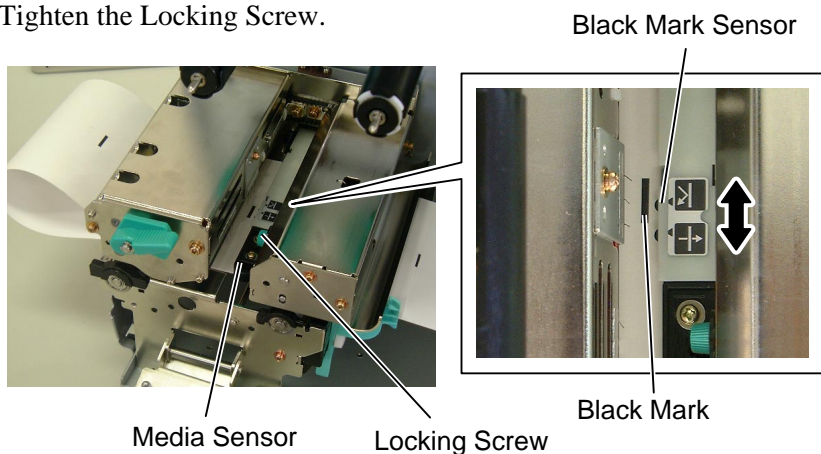

2.7 Loading the Media (Cont.)

12. There are four issue modes available on this printer. How to set the media for each mode is provided below.

Batch mode

In the batch mode, the media is continuously printed and fed until the number of labels/tags specified in the issue command have been printed.

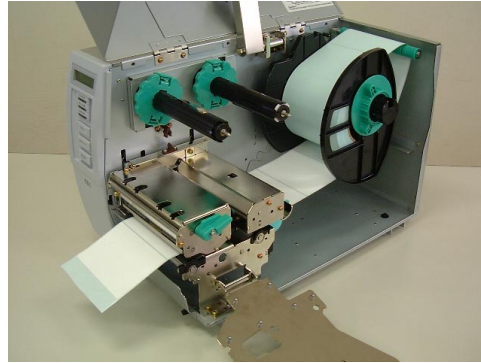

NOTES:

1. Be sure to set the Selection Switch to **STANDARD/PEEL OFF** position.
2. The backing paper is easier to feed back to the Take-Up Spool if the Front Plate is removed.
3. Fit the Take-Up Clip so that the longer side of the clip is fitted into the shallow groove in the Take-Up Spool.
4. The backing paper can be wound directly onto the Take-up Spool or a paper core. When using the Take-up Spool, detach the Holder Stopper by removing the B-3x4 screw. Otherwise, it may be difficult to pull out the wound backing paper roll.

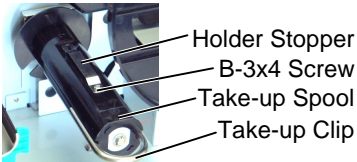

When using a paper core, put the core on the Take-up Spool with the Holder Stopper on it, and attach the top edge of the backing paper to the core with adhesive tape. The Take-up Clip is not necessary. This winding method is applicable to the Built-in Rewinder mode.

Strip mode

When the optional Strip Module is fitted, the backing paper is automatically removed from the label at the Strip Plate as each label is printed.

- (1) Remove enough labels from the leading edge of the media to leave 500mm of backing paper free.
- (2) Insert the backing paper under the Strip Plate.
- (3) Wind the backing paper onto the Take-up Spool and fix it in position with the Take-up Clip. (Wind the paper counterclockwise around the spool as this is the direction it rotates.)
- (4) Rotate the Take-up Spool anti-clockwise a few times to remove any slack in the backing paper.
- (5) Set the Selection Switch mounted on the Rewinder Assembly to **STANDARD/PEEL OFF** position.

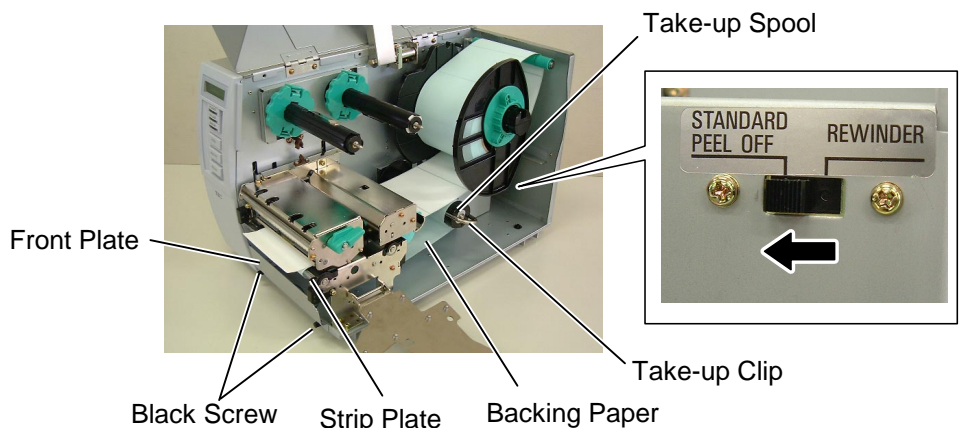

2.7 Loading the Media (Cont.)

NOTE:

Be sure to set the Selection Switch to **REWINDER** position.

ADJUSTMENT:

If the media skews when using the Built-in Rewinder, turn the Adjustment Knob of the Rewinder Guide Plate to correct the media feed. Clockwise turn moves the Rewinder Guide Plate forward and counter-clockwise moves it backward.

When the media skews to the right:

Loosen the SM-4x8 screw, turn the Adjustment Knob clockwise, and then tighten the SM-4x8 screw when the Rewinder Guide Plate is positioned correctly.

When the media skews to the left:

Loosen the SM-4x8 screw, turn the Adjustment Knob counterclockwise, and tighten the SM-4x8 screw when the Rewinder Guide Plate is positioned correctly.

WARNING!

The cutter is sharp, so care must be taken not to injure yourself when handling the cutter.

CAUTION!

1. Be sure to cut the backing paper of the label. Cutting labels will cause the glue to stick to the cutter which may affect the cutter quality and shorten the cutter life.
2. Use of tag paper when the thickness exceeds the specified value may affect the cutter life.

NOTE:

When using the Rotary Cutter, be sure to install the Ribbon Saving Module (B-9904-R-QM). Failure to do this may cause a paper jam or ribbon error.

Build-in rewinder mode

The Rewinder Assembly of the Strip Module can be used in batch mode to take up the printed media as a Built-in Rewinder.

- (1) Remove the two Black Screws to detach the Front Plate.
- (2) Attach the Rewinder Guide Plate enclosed with the optional Strip Module to the Strip Plate with the SMW-4x8 sems screws.
- (3) Insert the media under the Rewinder Guide Plate.
- (4) Wind the media onto the Take-up Spool and fix it in position with the Take-up Clip.
- (5) Rotate the Take-up Spool counterclockwise a few times to remove any slack in the media.
- (6) Set the Selection Switch mounted on the Rewinder Assembly to **REWINDER** position.

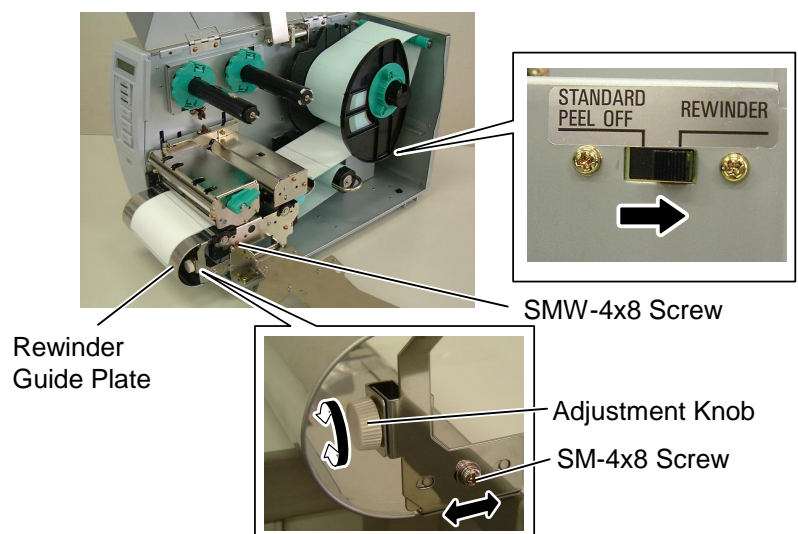

Cut mode

When the optional Cutter Module is fitted, the media is automatically cut. A swing cutter and a rotary cutter are available as an option, but they are used in the same way.

Insert the leading edge of the media into the Media Outlet of the Cutter Module.

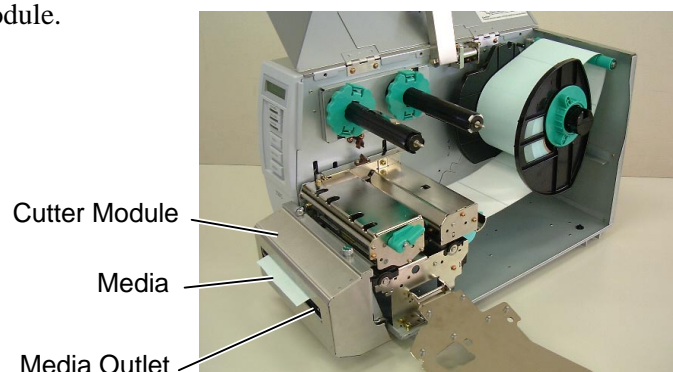

13. If the loaded media is direct thermal media (a chemically treated surface), the media loading procedure is now completed. Close the Ribbon Shaft Holder Plate, and turn the Head Lever to **Lock** position to close. Then, close the Top Cover. If the media is thermal transfer media, it is also necessary to load a ribbon. Refer to Section 2.8 Loading the Ribbon.

2.8 Loading the Ribbon

WARNING!

1. Do not touch any moving parts. To reduce the risk of fingers, jewellery, clothing, etc., being drawn into the moving parts, be sure to load the ribbon once the printer has stopped moving completely.
2. The print head becomes hot immediately after printing. Allow it to cool before loading the ribbon.
3. To avoid injury, be careful not to trap your fingers while opening or closing the cover.

CAUTION!

Be careful not touch the Print Head Element when raising the Print Head Block. Failure to do this may cause missing dots by static electricity or other print quality problems.

NOTES:

1. When attaching the ribbon stoppers, make sure that the pinchers face into the printer
2. Be sure to remove any slack in the ribbon when printing. Printing with a wrinkled ribbon will lower the print quality.
3. The Ribbon Sensor is mounted on the rear of the Print Head Block to detect a ribbon end. When a ribbon end is detected, "NO RIBBON" message will appear on the display and the ERROR LED will illuminate.

There are two types of media available for printing on: these are thermal transfer media and direct thermal media (a chemically treated surface). DO NOT LOAD a ribbon when using a direct thermal media.

1. Grasp the tabs on the top and bottom of the Ribbon Stoppers and move the Ribbon Stoppers back to the end of the Ribbon Shaft.

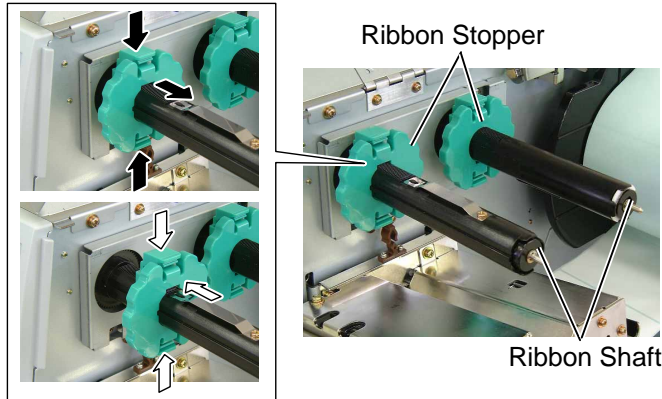

2. Leaving plenty of slack between the ribbon spools, place the ribbon onto the Ribbon Shafts as shown below.

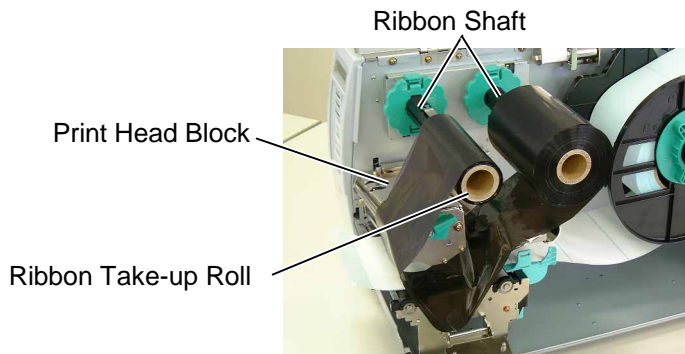

CAUTION!

When loading or replacing the media or a ribbon, be careful not to damage the print head with a hard object like a watch or a ring.

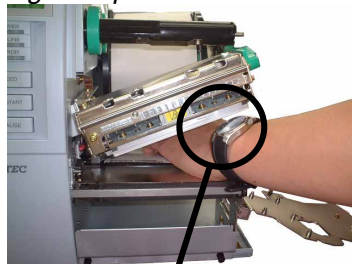

Care must be taken not to allow the metal or glass part of a watch to touch the print head edge.

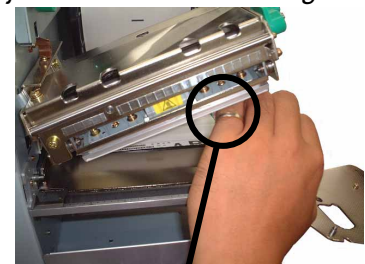

Care must be taken not to allow a metal object like a ring to touch the print head edge.

Since the print head element can be easily damaged by shock, please treat it carefully by not hitting a hard object against it.

2.8 Loading the Ribbon (Cont.)

3. Slide the Ribbon Stoppers along the Ribbon Shafts to a position where the ribbon is centred when fitted.
4. Lower the Print Head Block and set the Ribbon Shaft Holder Plate aligning its holes with the Ribbon Shafts.
5. Take up any slack in the ribbon. Wind the leading tape onto the ribbon take-up roll until the ink ribbon can be seen from the front of the printer.

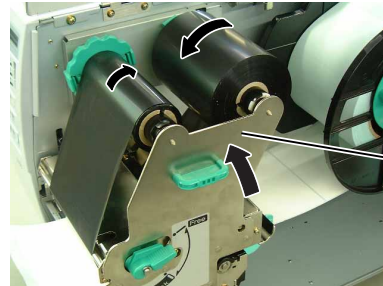

Ribbon Shaft
Holder Plate

6. Turn the Head Lever to **Lock** position to close the Print Head.
7. Close the Top Cover.

■ Auto Ribbon Saving Mode

When the auto ribbon saving function is selected, it will be activated to reduce ribbon loss when a no print area extends more than 20 mm (3 or 6 ips) or 30 mm (10 ips). For further information on this function, please ask a TOSHIBA TEC authorised service representative.

NOTE:

Ribbon loss per ribbon saving varies according to the relation between the outer roll diameter of the used ribbon and the print speed.

Print speed	Ribbon loss/Ribbon saving
3"/sec.	Approx. 6 mm
6"/sec.	Approx. 10 mm
10"/sec.	Approx. 20 mm

2.9 Inserting the Optional PCMCIA Cards

When the optional PCMCIA Interface Board is installed into the printer, there will be two PCMCIA slots available as shown in the figure below. This allows the use of Flash Memory type Cards or I/O Cards such as LAN Cards. The following paragraphs outline how to insert PCMCIA cards.

CAUTION!

1. To protect PC cards, discharge static electricity from your body by touching the metal cabinet of the printer before touching the card.
2. Before inserting or removing a PCMCIA card make sure that the printer's power is turned off.
3. Be sure to protect PCMCIA Cards when not in use by putting them into their protective covers.
4. Do not subject the card to any shocks or excessive force nor expose the card to extremes in temperature or humidity.
5. The card may be inserted into the slot halfway even in the wrong orientation. However, the slot is safety designed so that the card will not seat against the connector pins.

1. Make sure that the printer's Power Switch is in the OFF position.
2. Hold the PCMCIA Card so that the side with the model name faces left. Insert the card into the proper slot until the Eject Button pops out.

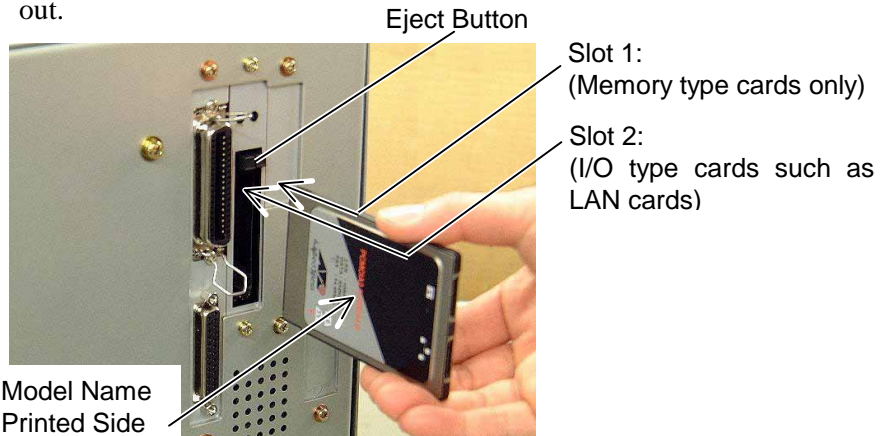

3. Slightly pull and fold the Eject Button upward.

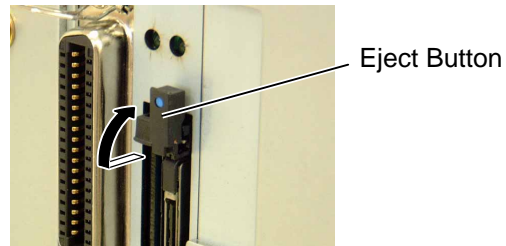

4. The following PCMCIA cards can be used.

Type	Maker	Description	Remarks
ATA Card	San Disk, Hitachi	A card conforming to the PC card ATA standard	-----
LAN Card	3 COM	3CCE589ET Series	Install into the slot (2) only. (This card installed into the slot (1) will not work.)
Flash Memory Card (4 MB)	Maxell	EF-4M-TB CC	Read/Write
	Maxell	EF-4M-TB DC	
	Centennial Technologies INC.	FL04M-15-11119-03	Read (See NOTE.)
	INTEL	IMC004FLSA	
	Simple TECHNOLOGY	STI-FL/4A	
	Mitsubishi	MF84M1-G7DAT01	
	PC Card KING MAX	FJN-004M6C	
	Centennial Technologies Inc.	FL04M-20-11138-67	
Flash Memory Card (1 MB)	PC Card	FJP-004M6R	Read (See NOTE.)
	Mitsubishi	MF84M1-GMCAV01	
	Maxell	EF-1M-TB AA	
	Mitsubishi	MF81M1-GBDAT01	

NOTE:

Reading a read-only-type flash memory is possible if it has been used on the TOSHIBA TEC printer, such as B-472 and B-572.

2.10 Test Print

A print test should be performed to check that the printer is operating correctly.

The following paragraphs guide you through the diagnostic procedure for test label printing. Please follow the step-by-step procedures exactly for best results.

1. Use label stock for the test print. For best results, use labels that are 76 mm or longer in length.
2. Press and hold the **[FEED]** and **[PAUSE]** keys while turning on the printer power switch. The LCD Message Display will show the following message.

```
<1>DIAG.    1.0A
```

3. Press the **[FEED]** key three times to advance to the test print mode as indicated by the following message in the LCD Message Display.

```
<4>TEST PRINT
```

4. Press the **[PAUSE]** key and the print condition setting display will appear.

```
<4>TEST PRINT  
PRINT CONDITION
```

5. Press the **[PAUSE]** key and the issue count setting display will appear. Set the issue count with the **[FEED]** or **[RESTART]** key.

```
<4>TEST PRINT  
ISSUE COUNT    1
```

6. Press the **[PAUSE]** key and the print speed setting display will appear. Set the print speed with the **[FEED]** or **[RESTART]** key.

```
<4>TEST PRINT  
PRINT SPEED 6"/s
```

7. Press the **[PAUSE]** key and the sensor type setting display will appear. Select the sensor type with the **[FEED]** or **[RESTART]** key.

```
<4>TEST PRINT  
SENSOR TRANS.
```

8. Press the **[PAUSE]** key and the print mode setting display will appear. Select the print mode with the **[FEED]** or **[RESTART]** key.

```
<4>TEST PRINT  
PRT TYPE TRANSFR
```

NOTES:

1. Select the sensor type which matches the media being used. Basically, the Reflective Sensor (Black Mark Sensor) is for tag paper, and the Transmissive Sensor (Feed Gap Sensor) is for labels.
2. Select the print mode which matches the media being used. Basically, the thermal transfer is with ribbon, and the thermal direct is without ribbon.

2.10 Test Print (Cont.)

NOTE:
When PAPER FEED is selected, the printer feeds the media to the correct print start position. If the print start position adjustment is unnecessary, select PAPER NO FEED and save the media.

9. Press the **[PAUSE]** key and the issue mode setting display will appear. Select the issue mode with the **[FEED]** or **[RESTART]** key.

```
<4>TEST PRINT
TYPE [S]NO CUT
```

10. Press the **[PAUSE]** key and the media size setting display will appear. Select the media size with the **[FEED]** or **[RESTART]** key.

```
<4>TEST PRINT
LABEL LEN. 76mm
```

11. Press the **[PAUSE]** key and the paper feed setting display will appear. Select whether or not a paper feed is performed with the **[FEED]** or **[RESTART]** key.

```
<4>TEST PRINT
PAPER FEED
```

12. When the **[PAUSE]** key is pressed, one blank media will be issued. Then the LCD Message Display will return to showing the test print start message.

```
<4>TEST PRINT
```

13. Press the **[PAUSE]** key and then **[FEED]** key. When pressing the **[PAUSE]** key, the printer will print the specified issue counts of the slant lines (1 dot).

```
<4>TEST PRINT
SLANT LINE (1DOT)
```

14. Press the **[FEED]** key and **[PAUSE]** key, and the printer will print the specified issue counts of the slant lines (3 dots).

```
<4>TEST PRINT
SLANT LINE (3DOT)
```

15. Press the **[FEED]** key and **[PAUSE]** key, and the printer will print the specified issue counts of the characters of various sizes.

```
<4>TEST PRINT
CHARACTERS
```

16. Press the **[FEED]** key and **[PAUSE]** key, and the printer will print the specified issue counts of the bar codes.

```
<4>TEST PRINT
BARCODE
```

17. Press the **[FEED]** key and **[PAUSE]** key, and the printer will print the specified issue counts of blank labels.

```
<4>TEST PRINT
NON PRINTING
```

18. Press the **[PAUSE]** key and the LCD Message Display will return to showing the test print start message.

NOTE:
If the **[FEED]** key is pressed after the blank labels are printed, the printer will enter the Factory Test mode. To exit from the Factory Test mode, press the **[PAUSE]** key.

2.10 Test Print (Cont.)

- 19. When you have finished performing the test print operation, turn the printer's power OFF then back to ON and check that the LCD Message Display shows ON LINE and that the ON LINE and POWER LED lights are illuminated.

Sample of the slant line (1 dot) test print label

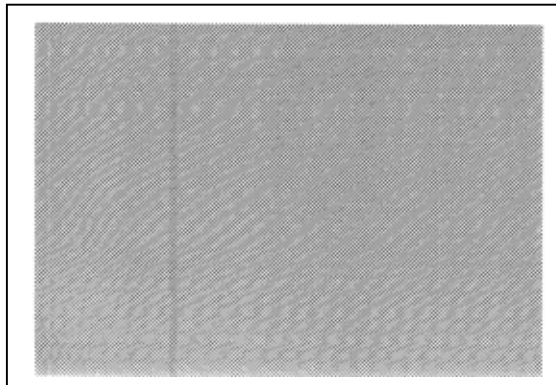

Sample of the slant line (3 dots) test print label



Sample of the character test print label



2.10 Test Print (Cont.)

Sample of the bar code test print label



Sample of the factory test label

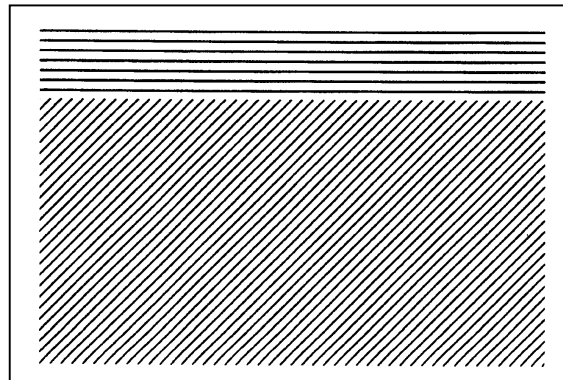

3. ON LINE MODE

This chapter describes usage of the keys on the Operation Panel in On Line mode.

When the printer is in On Line mode and connected to a host computer, the normal operation of printing images on labels or tags can be accomplished.

3.1 Operation Panel

- The figure below illustrates the operation panel and key functions.

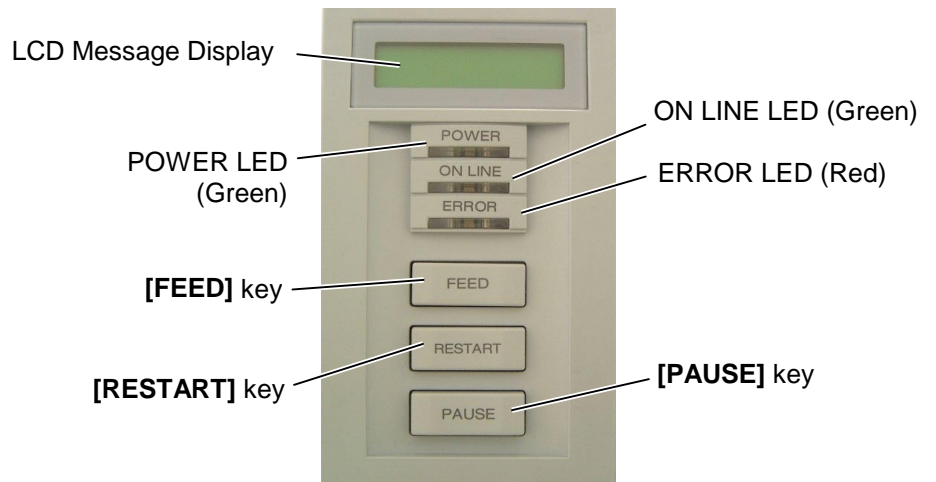

The LCD Message Display shows messages in alphanumeric characters and symbols to indicate the printer's current status. Up to 32 characters can be displayed on two lines.

There are three LED lights on the operation panel.

LED	Illuminates when...	Flashes when...
POWER	The printer is turned on.	-----
ON LINE	The printer is ready to print.	The printer is communicating with your computer.
ERROR	Any error occurs with the printer.	The ribbon is nearly over. (See NOTE.)

NOTE:
Flashes only when the Ribbon Near End Detection function is selected.

There are three keys on the operation panel.

PAUSE	Used to stop printing temporarily.
RESTART	Used to restart printing.
FEED	Used to feed the media.

NOTE:
Use the **[RESTART]** key to resume printing after a pause, or after clearing an error.

3.2 Operation

When the printer is turned on, the "ON LINE" message appears on the LCD Message Display. It is shown during standby or normal printing.

1. The printer is turned on, standing by, or printing.

```
ON LINE
B-SX4T      V1.0A
```

2. If any error occurs during printing, an error message appears. The printer stops printing automatically. (The number on the right side shows the remaining number of media to be printed.)

```
NO PAPER    125
B-SX4T      V1.0A
```

3. To clear the error, press the **[RESTART]** key. The printer resumes printing.

```
ON LINE
B-SX4T      V1.0A
```

4. If the **[PAUSE]** key is pressed during printing, the printer stops printing temporarily. (The number on the right side shows the remaining number of media to be printed.)

```
PAUSE       52
B-SX4T      V1.0A
```

5. When the **[RESTART]** key is pressed, the printer resumes printing.

```
ON LINE
B-SX4T      V1.0A
```

3.3 Reset

A reset operation clears the print data sent from the computer to the printer, and returns the printer to an idle condition.

1. The printer is turned on, standing by, or printing.

```
ON LINE
B-SX4T      V1.0A
```

2. To stop printing, or clear the data sent from the computer, press the **[PAUSE]** key. The printer stops printing.

```
PAUSE       52
B-SX4T      V1.0A
```

3. Press and hold the **[RESTART]** key for 3 seconds or longer.

```
<1>RESET
```

4. Press the **[PAUSE]** key. The data sent from the computer will be cleared, and the printer returns to an idle condition.

```
ON LINE
B-SX4T      V1.0A
```

NOTE:

If the **[RESTART]** key is held for less than 3 seconds when the printer is in an error or pause state, the printer restarts printing. However, when a communication error or command error occurs, the printer returns to an idle condition.

3.4 Dump Mode

In Dump mode, any characters sent from the host computer will be printed. Received characters are expressed in hexadecimal values. This allows the user to verify programming commands and debug the program.

For details, please refer to your nearest TOSHIBA TEC service representative.

4. MAINTENANCE

WARNING!

1. Be sure to disconnect the power cord before performing maintenance. Failure to do this may cause an electric shock.
2. To avoid injury, be careful not to pinch your fingers while opening or closing the cover and print head block.
3. The print head becomes hot immediately after printing. Allow it to cool before performing any maintenance.
4. Do not pour water directly onto the printer.

This chapter describes how to perform routine maintenance.

To ensure the continuous high quality operation of the printer, you should perform a regular maintenance routine. For high throughput it should be done on a daily basis. For low throughput it should be done on a weekly basis.

4.1 Cleaning

To maintain the printer performance and print quality, please clean the printer regularly, or whenever the media or ribbon is replaced.

4.1.1 Print Head/Platen/Sensors

CAUTION!

1. Do not use any volatile solvent including thinner and benzene, as this may cause discoloration to the cover, print failure, or breakdown of the printer.
2. Do not touch the Print Head Element with bare hands, as static may damage the Print Head.
3. Be sure to use the Print Head Cleaner enclosed with this printer. Failure to do this may shorten the Print Head life.

1. Turn off the power and unplug the printer.
2. Open the Top Cover.
3. Turn the Head Lever to **Free** position, then release the Ribbon Shaft Holder Plate.
4. Open the Print Head Block.
5. Remove the ribbon and media.

CAUTION!

When cleaning the print head, be careful not to damage the print head with a hard object like a watch or a ring.

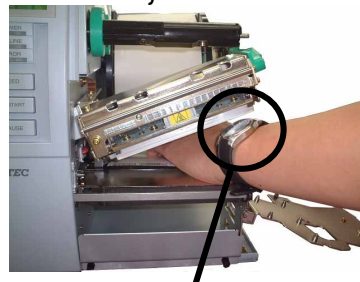

Care must be taken not to allow the metal or glass part of a watch to touch the print head edge.

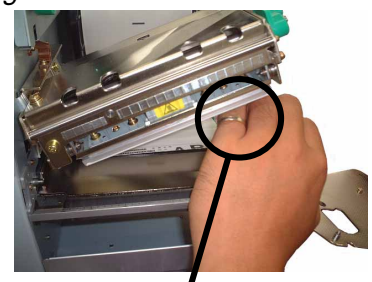

Care must be taken not to allow a metal object like a ring to touch the print head edge.

Since the print head element can be easily damaged by shock, please treat it carefully by not hitting a hard object against it.

4.1.1 Print Head/Platen/Sensors (Cont.)

NOTE:

Please purchase the Print Head Cleaner (P/No. 24089500013) from your authorised TOSHIBA TEC service representative.

6. Clean the Print Head Element with a Print Head Cleaner or a cotton swab or soft cloth slightly moistened with alcohol.

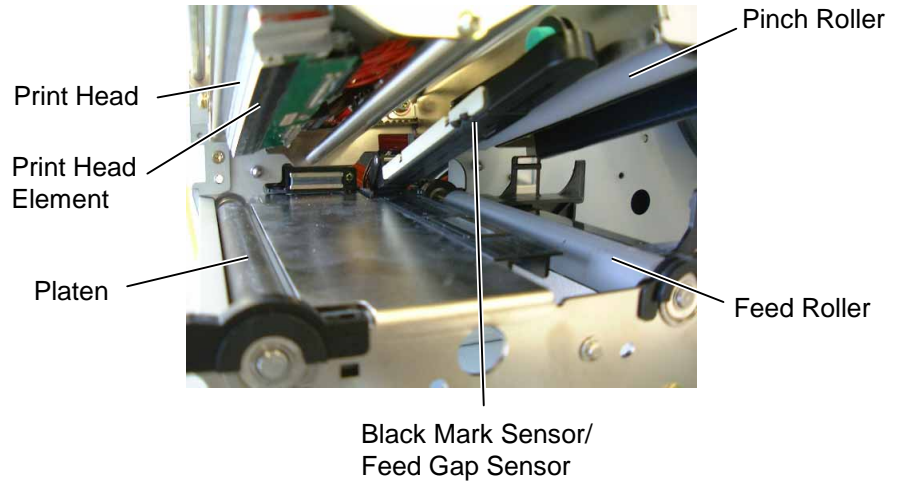

7. Wipe the Platen, Feed Roller, and Pinch Roller with a soft cloth slightly moistened with alcohol. Remove dust or foreign substances from the internal part of the printer.
8. Wipe the Feed Gap Sensor and Black Mark Sensor with a dry soft cloth.

4.1.2 Covers and Panels

CAUTION!

1. DO NOT POUR WATER directly onto the printer.
2. DO NOT APPLY cleaner or detergent directly onto any cover or panel.
3. NEVER USE THINNER OR OTHER VOLATILE SOLVENT on the plastic covers.
4. DO NOT clean the panel, covers, or the supply window with alcohol as it may cause them to discolour, loose their shape or develop structural weakness.

Wipe the covers and panels with a dry soft cloth or a cloth slightly moistened with mild detergent solution.



4.1.3 Optional Cutter Module**WARNING!**

1. Be sure to turn the power off before cleaning the Cutter Module.
2. As the cutter blade is sharp, care should be taken not to injure yourself when cleaning.

The swing cutter and rotary cutter are available as an option. They are both cleaned in the same way. When removing the Cutter Cover of the rotary cutter unit, remove the screws from the bottom of the cover.

1. Loosen the two screws to remove the Cutter Cover.
2. Remove the Plastic Head Screw to detach the Media Guide.
3. Remove the jammed paper.
4. Clean the Cutter with a soft cloth slightly moistened with alcohol.
5. Reassemble the Cutter Module in the reverse order of removal.

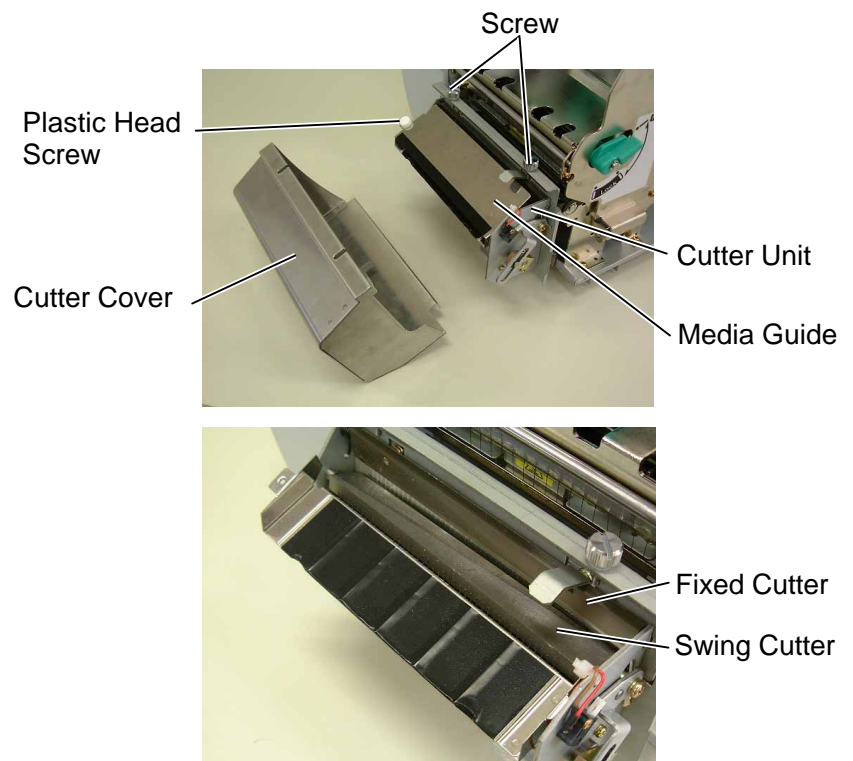
**4.2 Care/Handling of the Media and Ribbon****CAUTION!**

Be sure to carefully review and understand the Supply Manual. Use only media and ribbons that meet specified requirements. Use of non-specified media and ribbons may shorten the head life and result in problems with bar code readability or print quality. All media and ribbons should be handled with care to avoid any damage to the media, ribbons or printer. Read the guidelines in this section carefully.

- Do not store the media or ribbon for longer than the manufacturer's recommended shelf life.
- Store media rolls on the flat end. Do not store them on the curved sides as this might flatten that side causing erratic media advance and poor print quality.
- Store the media in plastic bags and always reseal after opening. Unprotected media can get dirty and the extra abrasion from the dust and dirt particles will shorten the print head life.
- Store the media and ribbon in a cool, dry place. Avoid areas where they would be exposed to direct sunlight, high temperature, high humidity, dust or gas.
- The thermal paper used for direct thermal printing must not have specifications which exceed Na^+ 800 ppm, K^+ 250 ppm and Cl^- 500 ppm.
- Some ink used on pre-printed media may contain ingredients which shorten the print head's product life. Do not use labels pre-printed with ink which contain hard substances such as carbonic calcium (CaCO_3) and kaolin ($\text{Al}_2\text{O}_3, 2\text{SiO}_2, 2\text{H}_2\text{O}$).

For further information, please contact your local distributor or your media and ribbon manufacturers.

5. TROUBLESHOOTING

This chapter lists the error messages, possible problems, and their solutions.

WARNING!

If a problem cannot be solved by taking the actions described in this chapter, do not attempt to repair the printer. Turn off and unplug the printer, then contact an authorised TOSHIBA TEC service representative for assistance.

5.1 Error Messages

NOTES:

- If an error is not cleared by pressing the **[RESTART]** key, turn the printer off and then on.
- After the printer is turned off, all print data in the printer is cleared.
- "****" indicates the number of unprinted media. Up to 9999 (in pieces).

Error Messages	Problems/Causes	Solutions
HEAD OPEN	The Print Head Block is opened in Online mode.	Close the Print Head Block.
HEAD OPEN ****	Feeding or printing has been attempted with the Print Head Block open.	Close the Print Head Block. Then press the [RESTART] key.
COMMS ERROR	A communication error has occurred.	Make sure the interface cable is correctly connected to the printer and the host, and the host is turned on.
PAPER JAM ****	<ol style="list-style-type: none"> 1. The media is jammed in the media path. The media is not fed smoothly. 2. A wrong Media Sensor is selected for the media being used. 3. The Black Mark Sensor is not correctly aligned with the Black Mark on the media. 4. Size of the loaded media is different from the programmed size. 5. The Feed Gap Sensor cannot distinguish the print area from a label gap. 	<ol style="list-style-type: none"> 1. Remove the jammed media, and clean the Platen. Then reload the media correctly. Finally press the [RESTART] key. 2. Turn the printer off and then on. Then select the Media Sensor for the media being used. Finally resend the print job. 3. Adjust the sensor position. Then press the [RESTART] key. 4. Replace the loaded media with one that matches the programmed size then press the [RESTART] key, or turn the printer off and then on, select a programmed size that matches the loaded media. Finally resend the print job. 5. Refer to Section 5.4 to set the threshold. If this does not solve the problem, turn off the printer, and call a TOSHIBA TEC authorised service representative.
CUTTER ERROR **** (Only when the cutter module is installed on the printer.)	The media is jammed in the cutter.	Remove the jammed media. Then press the [RESTART] key. If this does not solve the problem, turn off the printer, and call a TOSHIBA TEC authorised service representative.

5.1 Error Messages (Cont.)

Error Messages	Problems/Cause	Solutions
NO PAPER ****	<ol style="list-style-type: none"> The media has run out. The media is not loaded properly. The media is slack. 	<ol style="list-style-type: none"> Load new media. Then press the [RESTART] key. Reload the media correctly. Then press the [RESTART] key. Take up any slack in the media.
RIBBON ERROR ****	The ribbon is not fed properly.	Remove the ribbon, and check the status of the ribbon. Replace the ribbon, if necessary. If the problem is not solved, turn off the printer, and call a TOSHIBA TEC authorised service representative.
NO RIBBON ****	The ribbon has run out.	Load a new ribbon. Then press the [RESTART] key.
REWIND FULL ****	The Built-In Rewinder Unit is full.	Remove the backing paper from the Built-In Rewinder Unit. Then press the [RESTART] key.
EXCESS HEAD TEMP	The Print Head has overheated.	Turn off the printer, and allow it to cool down (about 3 minutes). If this does not solve the problem, call a TOSHIBA TEC authorised service representative.
HEAD ERROR	There is a problem with the Print Head.	Replace the Print Head.
Other error messages	A hardware or software problem may have occurred.	Turn the printer off and then on. If this does not solve the problem, turn off the printer again, and call a TOSHIBA TEC authorised service representative.

5.2 Possible Problems

This section describes problems that may occur when using the printer, and their causes and solutions.

Possible Problems	Causes	Solutions
The printer will not turn on.	<ol style="list-style-type: none"> The Power Cord is disconnected. The AC outlet is not functioning correctly. The fuse has blown, or the circuit breaker has tripped. 	<ol style="list-style-type: none"> Plug in the Power Cord. Test with a power cord from another electric appliance. Check the fuse or breaker.
The media is not fed.	<ol style="list-style-type: none"> The media is not loaded properly. The printer is in an error condition. 	<ol style="list-style-type: none"> Load the media properly. Solve the error in the message display. (See Section 5.1 for more detail.)
Nothing is printed on the media.	<ol style="list-style-type: none"> The media is not loaded properly. The ribbon is not loaded properly. The print head is not installed properly. The ribbon and media are not matched. 	<ol style="list-style-type: none"> Load the media properly. Load the ribbon properly. Install the print head properly. Close the Print Head Block. Select an appropriate ribbon for the media type being used.
The printed image is blurred.	<ol style="list-style-type: none"> The ribbon and media are not matched. The Print Head is not clean. 	<ol style="list-style-type: none"> Select an appropriate ribbon for the media type being used. Clean the print head using the Print Head Cleaner or a cotton swab slightly moistened with ethyl alcohol.
The cutter does not cut.	<ol style="list-style-type: none"> The Cutter Cover is not attached properly. The media is jammed in the Cutter. The cutter blade is dirty. 	<ol style="list-style-type: none"> Attach the Cutter Cover properly. Remove the jammed paper. Clean the cutter blade.

5.3 Removing Jammed Media

CAUTION!

Do not use any tool that may damage the Print Head.

This section describes in detail how to remove jammed media from the printer.

1. Turn off and unplug the printer.
2. Open the Top Cover.
3. Turn the Head Lever to **Free** position, then open the Ribbon Shaft Holder Plate.
4. Open the Print Head Block.
5. Remove the ribbon and media.

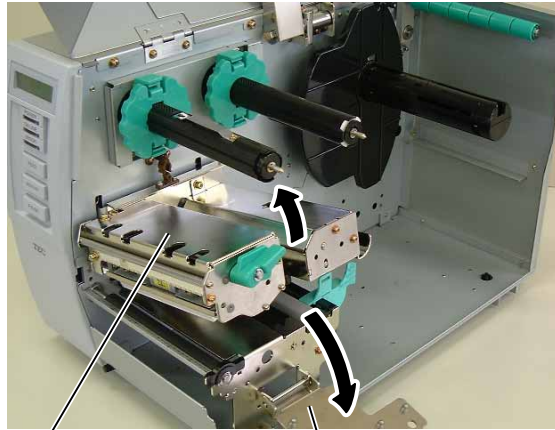

Print Head Block

Ribbon Shaft Holder Plate

6. Remove the jammed media from the printer. **DO NOT USE** any sharp implements or tools as these could damage the printer.
7. Clean the Print Head and Platen, then remove any further dust or foreign substances.
8. Paper jams in the Cutter Unit can be caused by wear or residual glue from label stock on the cutter. Do not use non-specified media in the cutter.

NOTE:

If you get frequent jams in the cutter, contact a TOSHIBA TEC authorised service representative.

CAUTION!

When removing the jammed media, be careful not to damage the print head with a hard object like a watch or a ring.

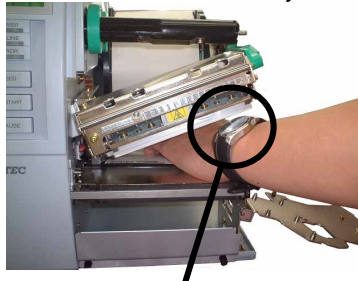

Care must be taken not to allow the metal or glass part of a watch to touch the print head edge.

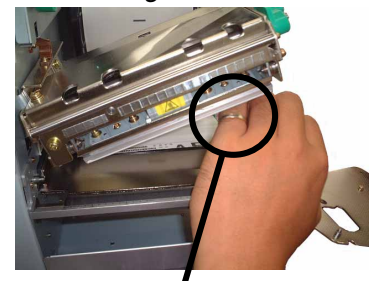

Care must be taken not to allow a metal object like a ring to touch the print head edge.

Since the print head element can be easily damaged by shock, please treat it carefully by not hitting a hard object against it.

5.4 Threshold Setting

NOTES:

1. If the **[PAUSE]** key is released within 3 seconds while in the pause state, the paper will not feed.
2. Failure to feed more than 1.5 labels may result in an incorrect threshold setting.
3. While the Print Head Block is raised, the **[PAUSE]** key does not work.
4. A paper end error cannot be detected during paper feed.
5. Selecting the Transmissive Sensor (for pre-printed labels) within software commands allows the printer to detect the proper print start position even when using pre-printed labels.
6. If using the Transmissive Sensor and the printer continues to print out of position even after setting the threshold, contact a TOSHIBA TEC service representative.

To maintain a constant print position the printer uses the Transmissive Sensor to detect the gap between labels by measuring the amount of light passing through the media. When the media is pre-printed, the darker (or more dense) inks can interfere with this process causing paper jam errors. To get around this problem a minimum threshold can be set for the sensor in the following way.

■ Threshold setting procedure

1. Turn the power ON. The printer is in stand by mode.

```
ON LINE
B-SX4T      V1.0A
```

2. Load a pre-printed media roll.

3. Press the **[PAUSE]** key.

```
PAUSE
B-SX4T      V1.0A
```

4. The printer enters the pause mode.

5. Press and hold the **[PAUSE]** key for at least 3 seconds in the pause state.

```
TRANSMISSIVE
B-SX4T      V1.0A
```

6. The sensor type is displayed.

7. Select the sensor to be adjusted by pressing the **[FEED]** key.

```
REFLECTIVE
B-SX4T      V1.0A
```

Black mark sensor

↑
[FEED] key

```
TRANSMISSIVE
B-SX4T      V1.0A
```

↓
Feed gap sensor

8. Press and hold the **[PAUSE]** key until more than 1.5 labels (tags) have been issued.

The media will continue to be fed until the **[PAUSE]** key is released. (Threshold setting for the selected sensor is completed by this operation.)

```
PAUSE
B-SX4T      V1.0A
```

9. Press the **[RESTART]** key.

```
ON LINE
B-SX4T      V1.0A
```

10. The printer is in stand-by.

11. Send an issue command from the PC to the printer.

```
ON LINE
B-SX4T      V1.0A
```

APPENDIX 1 SPECIFICATIONS

Appendix 1 describes the printer specifications and supplies for use on the B-SX4T printer.

A1.1 Printer

The following is the printer specifications.

Item	Model	B-SX4T-GS10-QQ/QQ-US	B-SX4T-GS10-QP
Supply voltage		AC100 – 120V, 50/60 Hz±10%	AC220 – 240V, 50 Hz±10%
Power consumption			
During a print job		1.6 A, 133 W maximum	1.0 A, 134 W maximum
During standby		0.18 A, 14 W maximum	0.13 A, 14 W maximum
Operating temperature range		5°C to 40°C (40°F to 104°F)	
Relative humidity		25% to 85% RH (no condensation)	
Resolution		8 dots/mm (203 dpi)	
Printing method		Thermal transfer or Thermal direct	
Printing speed		76.2 mm/sec. (3 inches/sec.) 152.4 mm/sec (6 inches/sec.) 254.0 mm/sec (10 inches/sec.)	
Available media width (including backing paper)		30.0 mm to 112.0 mm (1.2 inches to 4.4 inches)	
Effective print width (max.)		104.0 mm (4.1 inches)	
Issue mode		Batch Cut (Cut mode is enabled only when the optional Cutter Module is installed.) Strip (Strip mode is enabled only when the optional Strip Module is installed.)	
LCD Message display		16 characters × 2 lines	
Dimension (W × D × H)		291 mm × 460 mm × 308 mm (11.5" × 18.1" × 12.1")	
Weight		39.7 lb (18 kg) (Media and ribbon are not included.)	
Available bar code types		JAN8, JAN13, EAN8, EAN8+2 digits, EAN8+5 digits, EAN13, EAN13+2 digits, EAN13+5 digits, UPC-E, UPC-E+2 digits, UPC-E+5 digits, UPC-A, UPC-A+2 digits, UPC-A+5 digits, MSI, ITF, NW-7, CODE39, CODE93, CODE128, EAN128, Industrial 2 to 5, Customer Bar Code, POSTNET, KIX CODE, RM4SCC (ROYAL MAIL 4STATE CUSTOMER CODE), RSS14	
Available two-dimensional code		Data Matrix, PDF417, QR code, Maxi Code, Micro PDF417, CP Code	
Available font		Times Roman (6 sizes), Helvetica (6 sizes), Presentation (1 size), Letter Gothic (1 size), Prestige Elite (2 sizes), Courier (2 sizes), OCR (2 types), Gothic (1 size), Outline font (4 types), Price font (3 types)	
Rotations		0°, 90°, 180°, 270°	
Standard interface		Serial interface (RS-232C) Parallel interface (Centronics)	
Optional interface		PCMCIA interface (B-9700-PCM-QM) USB interface (B-9700-USB-QM) LAN interface (B-9700-LAN-QM) Expansion I/O interface (B-7704-IO-QM)	

NOTES:

- Data Matrix™ is a trademark of International Data Matrix Inc., U.S.
- PDF417™ is a trademark of Symbol Technologies Inc., US.
- QR Code is a trademark of DENSO CORPORATION.
- Maxi Code is a trademark of United Parcel Service of America, Inc., U.S.

A1.2 Options

Option Name	Type	Description
Swing cutter module	B-4205-QM	A stop and cut swing cutter.
Rotary cutter module	B-8204-QM	Rotary cutter
Strip module	B-9904-H-QM	This allows use of on-demand (peel-off) operation or to take-up labels and backing paper together when using the rewind guide plate. To purchase the strip module, please inquire at your local distributor.
Ribbon saving module	B-9904-R-QM	This module moves the print head up and down by using a solenoid to minimise ribbon usage as far as possible.
Expansion I/O interface board	B-7704-IO-QM	Installing this board in the printer allows connection to an external device with the exclusive interface.
PCMCIA interface board	B-9700-PCM-QM	This board enables the use of the following PCMCIA cards. LAN card: 3 COM 3CCE589ET (recommended) ATA card: Conforming to PC card ATA standard Flash memory card: 1MB and 4MB cards (See Section 2.9.)
Built-in LAN interface board	B-9700-LAN-QM	This board enables the printer to be used in a LAN network.
USB interface board	B-9700-USB-QM	Installing this board enables a connection to a PC which has a USB interface.

NOTE:

To purchase the optional kits, please contact the nearest authorised TOSHIBA TEC representative or TOSHIBA TEC Head Quarters.

A1.3 Media

Please make sure that the media being used is approved by TOSHIBA TEC. The warranty does not apply when a problem is caused by using media that is not approved by TOSHIBA TEC.

For information regarding TOSHIBA TEC approved media, please contact a TOSHIBA TEC authorised service representative.

A1.3.1 Media Type

Two types of media can be loaded for this thermal transfer and direct thermal printer: label or tag. The table below shows size and shape of the media available for this printer.

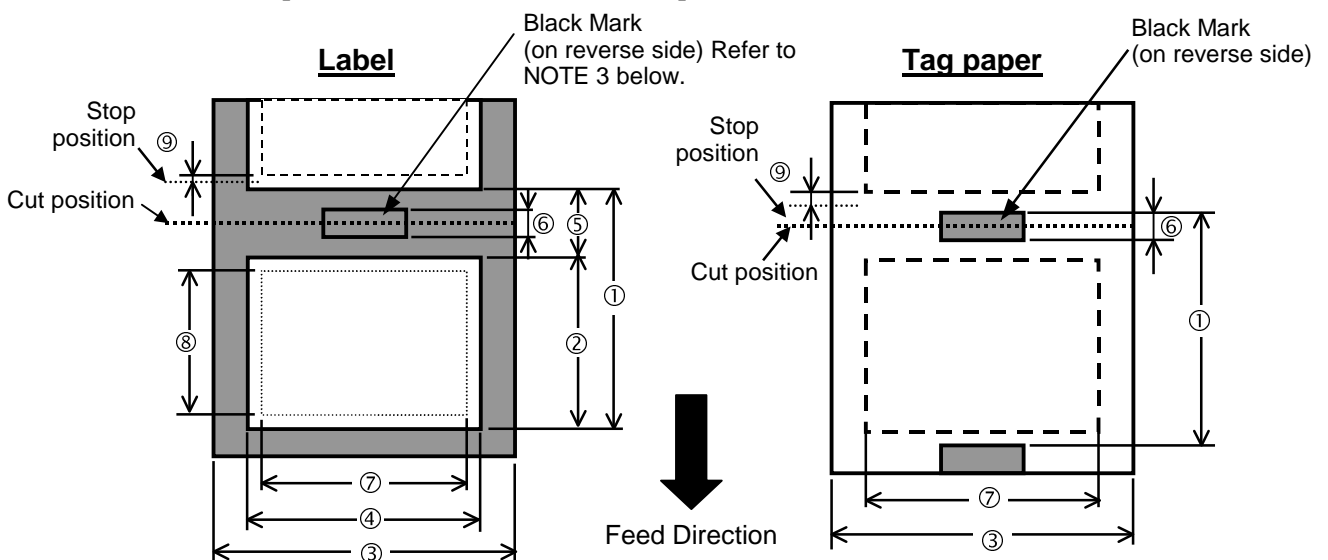

A1.3.1 Media Type (Cont.)

[Unit: mm]

Item	Label dispensing mode	Batch mode	Strip mode	Cut mode	
				Rotary cutter (*2)	Swing cutter
① Media pitch	Label	10.0 – 1500.0	25.4 – 1500.0	3"/sec., 6"/sec.: 38.0 - 1500.0	38.0 – 1500.0
	Tag	10.0 – 1500.0	----	3"/sec., 6"/sec.: 30.0 – 1500.0	25.4 – 1500.0
② Label length		8.0 – 1498.0	23.4 – 1498.0	3"/sec., 6"/sec.: 32.0 – 1494.0	25.0 – 1494.0(*1)
③ Width including backing paper (See NOTE 5.)		30.0 – 112.0	50.0 – 112.0	30.0 – 112.0	
④ Label width (See NOTE 5.)		27.0 – 109.0	47.0 – 109.0	27.0 – 109.0	
⑤ Gap length		2.0 – 20.0		6.0 – 20.0	
⑥ Black mark length (Tag paper)		2.0 – 10.0			
⑦ Effective print width		10.0 – 104.0±0.2			
⑧ Effective print length	Label	6.0 – 1496.0	21.4 – 1496.0	3"/sec., 6"/sec.: 30.0 – 1492.0	23.0 – 1492.0
	Tag	8.0 – 1498.0	----	3"/sec., 6"/sec.: 28.0 – 1496.0	23.0 – 1496.0
⑨ Print speed up/slow down area		1.0			
Thickness	Label	0.13 – 0.17			
	Tag	0.15 – 0.29			
Maximum effective length for on the fly issue		1361.0			
Maximum outer roll diameter		Ø200			
Roll direction		Inside			
Inner core diameter		Ø76.2±0.3			

NOTES:

1. To ensure print quality and print head life use only TOSHIBA TEC specified media.
2. The media length specifications for use of the cutter are:
 - *1: When issuing a label using the swing cutter, label length should be 35.0 mm – (Gap length/2).
 - *2: The rotary cutter does not support the print speed of 10"/sec.
When using the Rotary Cutter, be sure to install the Ribbon Saving Module (B-9904-R-QM). Failure to do this may cause a paper jam or ribbon error.
3. When marking black marks on the label rolls, they should be marked at the gaps.
4. "On the fly issue" means that the printer can feed and print without stopping between labels.
5. There are restrictions in use of the media which is narrower than 50 mm. For details, refer to TOSHIBA TEC service representative.

A1.3.2 Detection Area of the Transmissive Sensor

The Transmissive Sensor is movable from the centre to the left edge of media.
The Transmissive Sensor detects a gap between labels, as illustrated below.

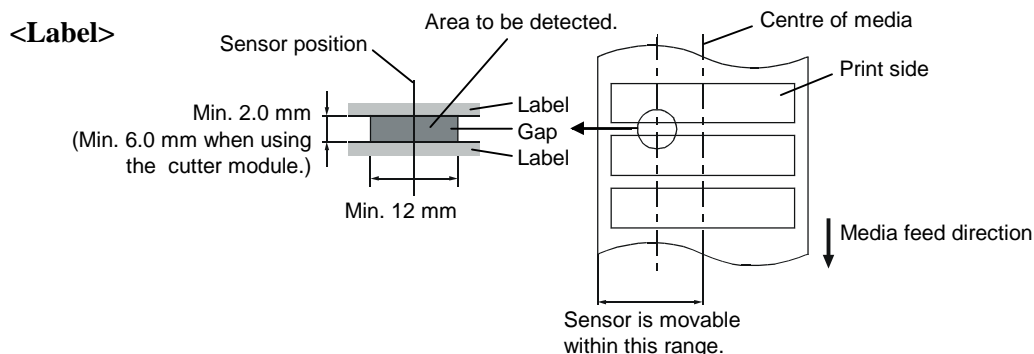

A1.3.2 Detection Area of the Transmissive Sensor (Cont.)

<Tag paper with square holes>

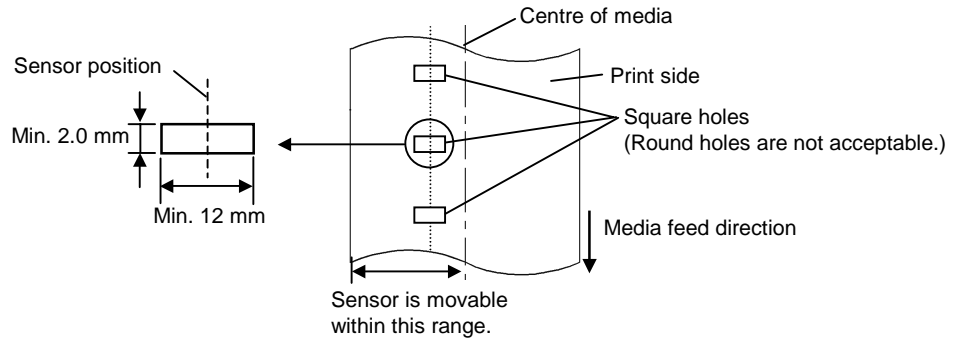

NOTE:
Round holes are not acceptable.

A1.3.3 Detection Area of the Reflective Sensor

The Reflective Sensor is movable from the centre to the left edge of media.
The reflection factor of the Black Mark must be 10% or lower with a waveform length of 950 nm.
The Reflective Sensor should be aligned with the centre of the Black Mark.

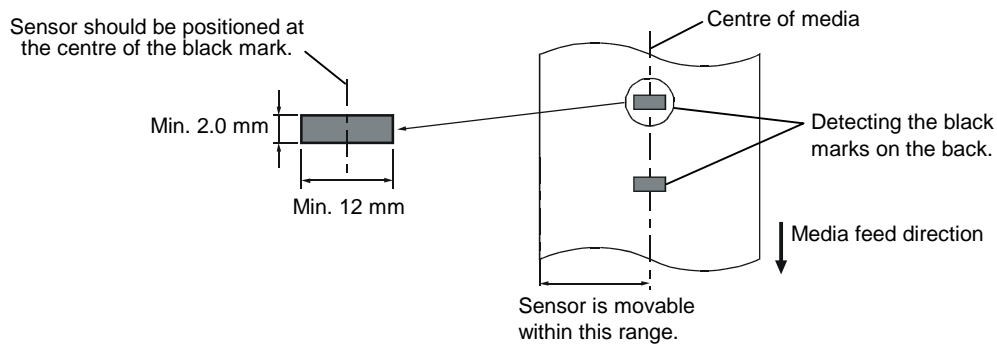

A1.3.4 Effective Print Area

The figure below illustrates the relation between the head effective print width and media width.

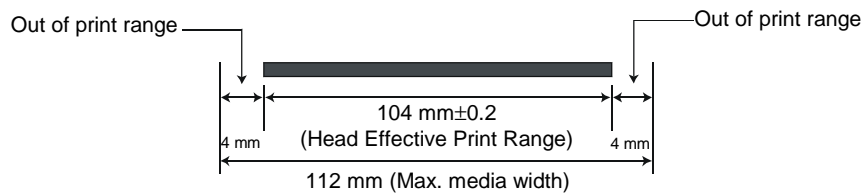

A1.3.4 Effective Print Area (Cont.)

The figure below shows the effective print area on the media.

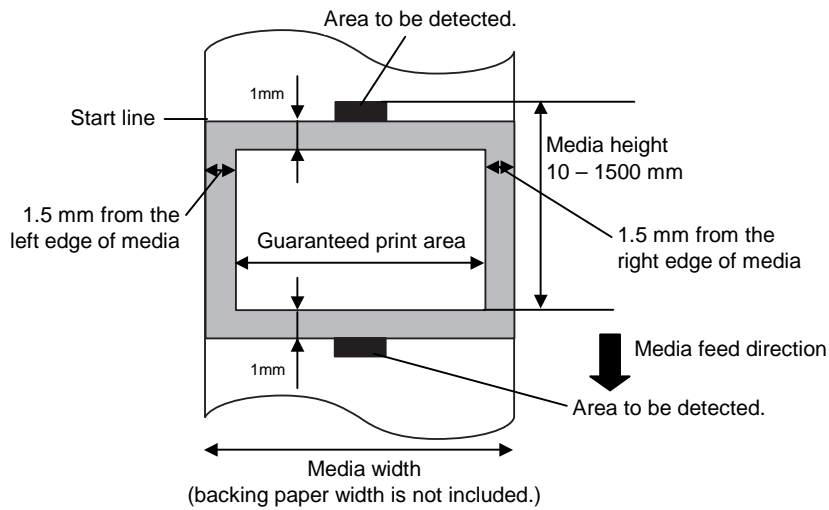

NOTES:

1. Be sure not to print on the 1.5-mm wide area from the media edges (shaded area in the above figure). Printing this area may cause ribbon wrinkles, resulting in a poor print quality of the guaranteed print area.
2. The centre of media is positioned at the centre of the Print Head.
3. Print quality in the 3-mm area from the print head stop position (including 1-mm non-printable area for print speed slow down) is not guaranteed.

A1.4 Ribbon

Please make sure that the ribbon being used is approved by TOSHIBA TEC. The warranty does not apply to any problem caused by using non-approved ribbons.

For information regarding TOSHIBA TEC approved ribbon, please contact a TOSHIBA TEC service representative.

Type	Spool type
Width	41 – 112 mm Recommended width is 41, 50, 68, 84, and 112 mm.
Length	600 m
Outside Diameter	φ90 mm (max.)

The table below shows the correlation between ribbon width and media width (backing paper is not included.)

Ribbon width	Media width	Ribbon width	Media width
41 mm	30 – 36 mm	84 mm	63 – 79 mm
50 mm	36 – 45 mm	112 mm	71 – 112 mm
68 mm	45 – 63 mm		

NOTES:

1. To ensure print quality and print head life use only TOSHIBA TEC specified ribbons.
2. To avoid ribbon wrinkles use a ribbon that is wider than the media by 5 mm or more. However, too much difference in width between the two may cause wrinkles.
3. When using a 112 mm wide media, be sure to use a 108 mm wide ribbon. Use of other ribbons may cause ribbon wrinkles.

APPENDIX 2 MESSAGES AND LEDS

Appendix 2 describes the LCD messages displayed on the operation panel.

Symbols in the message

- 1: ○: The LED is illuminated. ⊙: The LED is flashing. ●: The LED is unlit.
- 2: ****: the number of unprinted media. Up to 9999 (in pieces)
- 3: %%%: ATA Card's remaining memory 0 to 999999 (in K bytes)
- 4: ###: Flash memory card remaining memory for PC save area: 0 to 895 (in K bytes)
- 5: &&&: Remaining flash memory capacity for storing writable characters 0 to 3147 (in K bytes)

No.	LCD Message	LED Indication			Printer Status	Restoration by RESTART key Yes/No	Acceptance of Status Request Reset Command Yes/No
		POWER	ONLINE	ERROR			
1	ON LINE	○	○	●	In online mode	----	Yes
	ON LINE	○	⊙	●	In online mode (The printer in communication)	----	Yes
2	HEAD OPEN	○	●	●	The print head block is opened in online mode.	----	Yes
3	PAUSE ****	○	●	●	The printer is paused.	Yes	Yes
4	COMMS ERROR	○	●	○	A parity, overrun, or framing error has occurred during communication through the RS-232C.	Yes	Yes
5	PAPER JAM ****	○	●	○	The media is jammed during paper feed.	Yes	Yes
6	CUTTER ERROR****	○	●	○	A problem has occurred with the cutter module.	Yes	Yes
7	NO PAPER ****	○	●	○	The media has run out, or the media is not loaded properly.	Yes	Yes
8	NO RIBBON ****	○	●	○	The ribbon has run out.	Yes	Yes
9	HEAD OPEN ****	○	●	○	Feed or printing was attempted with the print head block open.	Yes	Yes
10	HEAD ERROR	○	●	○	There is a problem with the print head.	Yes	Yes
11	EXCESS HEAD TEMP	○	●	○	The print head is overheated.	No	Yes
12	RIBBON ERROR****	○	●	○	The ribbon has been torn. A problem has occurred with the sensor that determines the torque for the ribbon motor.	Yes	Yes
13	REWIND FULL ****	○	●	○	An overflow error has occurred in the rewinder unit.	Yes	Yes
14	SAVING%%%%%%%% or SAVING ###&&&	○	○	●	In writable character or PC command save mode	----	Yes
15	FLASH WRITE ERR.	○	●	○	An error has occurred while writing to flash memory or ATA card.	No	Yes
16	FORMAT ERROR	○	●	○	An erase error has occurred in formatting the flash memory or ATA card.	No	Yes
17	FLASH CARD FULL	○	●	○	Data cannot be stored because the flash memory or ATA card is full.	No	Yes
18	Display of error message (See Notes.)	○	●	○	A command error has occurred in analyzing the command.	Yes	Yes
19	POWER FAILURE	○	●	○	A power failure has occurred.	No	No
20	INITIALIZING...	○	●	●	A flash memory card is being initialised.	----	----
21	100BASE LAN INITIALIZING...	○	●	●	100 Base LAN Board is being initialized.	----	----

NOTES:

- If a command error is found in the command received, 16 bytes of the command error, starting from the command code, will be displayed. (However, [LF] and [NUL] will not be displayed.)

Example 1

[ESC] T20 G30 [LF] [NUL]
 └─── Command error

The following message appears.

```
T20G30
B-SX4T      V1.0A
```

Example 2

[ESC] XR; 0200, 0300, 0450, 1200, 1, [LF] [NUL]
 └─── Command error

The following message appears.

```
XR;0200,0300,045
B-SX4T      V1.0A
```

Example 3

[ESC] PC001; 0A00, 0300, 2, 2, A, 00, B [LF] [NUL]
 └─── Command error

The following message appears.

```
PC001;0A00,0300,
B-SX4T      V1.0A
```

- When the error command is shown, "? (3FH)" appears for codes other than codes 20H to 7FH and A0H to DFH.

APPENDIX 3 INTERFACE

■ Interface Cables

To prevent radiation and reception of electrical noise, the interface cables must meet the following requirements:

- Fully shielded and fitted with metal or metallised connector housings.
- Keep as short as possible.
- Should not be bundled tightly with power cords.
- Should not be tied to power line conduits.

■ RS-232C Cable description

The serial data cable used to connect the printer to the host compute should be one of the following two types:

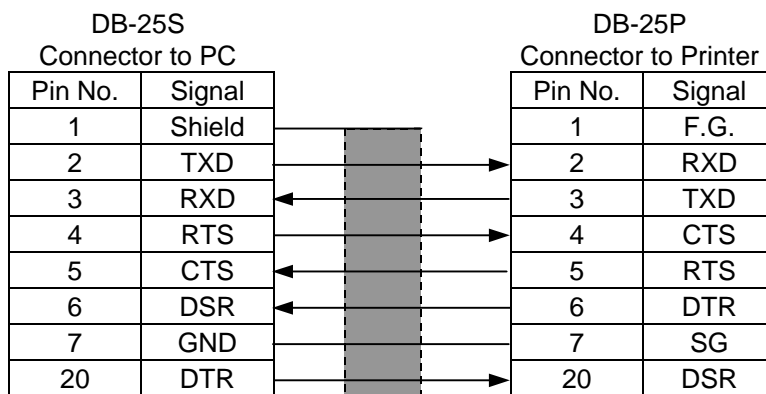
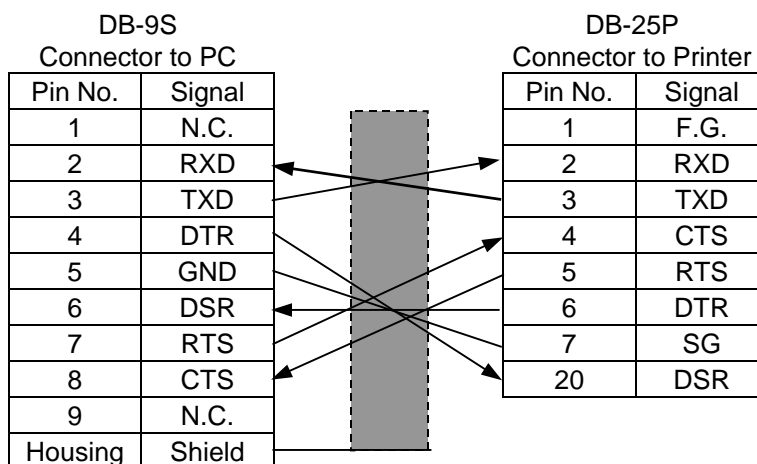

NOTE:

Use an RS-232C cable with the connector including inch type securing screws for the QQ model or metric type securing screws for the QP model.

APPENDIX 4 PRINT SAMPLES

■ Font

<A>Times Roman medium:12point

Times Roman medium:15point

<C>Times Roman bold:15point

<D>Times Roman bold:18point

<E>Times Roman bold:21point

<F>Times Roman italic:18point

<G>Helvetica medium:9point

<H>Helvetica medium:15point

<I>Helvetica medium:18point

<J>Helvetica bold:18point

<K>Helvetica bold:21point

<L>Helvetica italic:18point

<M>PRESENTATION BOLD:27POINT

<N>Letter Gothic medium:14.3point

<O>Prestige Elite medium:10.5point

<P>Prestige Elite bold:15point

<Q>Courier medium:15point

<R>Courier bold:18point

<S>OCR-A 12POINT

<T>OCR-B 12POINT

<q>Gothic 725 Black:6point

<Outline Font:A> **Helvetica bold**

<Outline Font:B> **Helvetica bold(P)**

<Outline Font:E> *0123456789, ¥ \$*

<Outline Font:F> **0123456789, ¥ \$**

<Outline Font:G> **0123456789, ¥ \$**

<Outline Font:H> **Dutch 801 bold**

<Outline Font:I> *Brush 738 regular*

<Outline Font:J> **Gothic 725 Black**

APPENDIX 4 PRINT SAMPLES (Cont.)

■ Bar codes

JAN8, EAN8



Interleaved 2 of 5



NW7



UPC-E



EAN13+5 digits



CODE39 (Full ASCII)



UPC-E+2 digits



EAN8+2 digits



UPC-A



MSI



CODE39 (Standard)



JAN13, EAN13



EAN13+2 digits



CODE128



CODE93



UPC-E+5 digits



EAN8+5 digits



UPC-A+2 digits



APPENDIX 4 PRINT SAMPLES (Cont.)

UPC-A+5 digits



UCC/EAN128



Industrial 2 of 5



POSTNET



Customer bar code



Customer bar code of high priority



KIX Code



RM4SCC



RSS-14



RSS-14 Stacked



RSS-14 Stacked Omnidirectional



RSS Limited



RSS Expanded



Data Matrix



PDF417



QR code



Micro PDF417



MaxiCode



CP Code



GLOSSARIES

Bar code

A code which represents alphanumeric characters by using a series of black and white stripes in different widths. Bar codes are used in various industrial fields: Manufacturing, Hospitals, Libraries, Retail, Transportation, Warehousing, etc. Reading bar codes is a fast and accurate means of capturing data while keyboard entry tends to be slow and inaccurate.

Batch mode

Issue mode that continuously prints media until the specified number of media has been printed.

Black mark

A mark printed on the media so that the printer can maintain a constant print position by detecting this mark.

Black mark sensor

A reflective sensor which detects the difference of potential between the black mark and print area to find the print start position.

Built-in rewinder mode

Printer mode of operation where an optional strip module is installed to take up printed media onto the build-in rewinder.

Cut mode

Printer mode of operation where an optional cutter module is installed to automatically cut media from the supply roll after they are printed. The print command can specify to cut every media or to cut after a set number of media have been printed.

Cutter module

A device used to cut the media.

DPI

Dot Per Inch

The unit used to express print density.

Expansion I/O interface

An optional interface circuit that may be installed into printer to allow the printer to be connected to an external device such as a wrapping machine and to receive feed, print start, and pause signals from the external device and to send back print, pause, and error status signals to the external device.

Feed gap sensor

A transmissive sensor which detects the difference of potential between the gap between labels and the label to find the print position of the label.

Font

A complete set of alphanumeric characters in one style of type. E.g. Helvetica, Courier, Times

Gap

Clearance between labels

IPS

Inch per second

The unit used to express print speed.

Label

A type of media with adhesive backing.

LCD

Liquid Crystal Display

Installed on the operation panel and displays operation modes, error message and so on.

Media

Material on which data is printed by the printer. Label, tag paper, fanfold paper, perforated paper, etc.

PCMCIA interface

An optional interface circuit that may be installed into the printer to allow the use of the small credit card sized PC cards such as flash memory cards and LAN cards. PCMCIA is the acronym for Personal Computer Memory Card International Association.

Pre-printed media

A type of media on which characters, logos, and other designs have been already printed.

Print head element

The thermal print head consists of a single line of tiny resistive elements and when current is allowed to flow through each element it heats up causing a small dot to be burned onto thermal paper or a small dot of ink to be transferred from a thermal ribbon to ordinary paper.

Print speed

The speed at which printing occurs. This speed is expressed in units of ips (inches per second).

Reflective sensor

See Black mark sensor.

Resolution

The degree of detail to which an image can be duplicated. The minimum unit of divided image is called a pixel. As the resolution becomes higher, the number of pixels increased, resulting in more detailed image

Ribbon

An inked film used to transfer an image onto the media. In the thermal transfer printing, it is heated by the thermal print head, causing an image to be transferred onto the media

Strip mode

A device used to remove labels from the backing paper.

Supply

Media and ribbon

Tag

A type of media with no adhesive. Usually tags are made of cardboard or other durable material.

Thermal direct printing

A printing method using no ribbon, but thermal media which reacts to heat. The thermal print head heats the thermal media directly, causing print image to be printed on the media.

Thermal print head

A print head using thermal transfer or thermal direct printing method.

Thermal transfer printing

A printing method that the thermal print head heats an ink or resin coating on the ribbon against the media, causing the ink/resin to transfer onto the media.

Threshold setting

A sensor setting operation to have the printer maintain a constant print position of pre-printed media.

Transmissive sensor

See Feed gap sensor.

USB (Universal Serial Bus)

An interface that is used to connect peripherals, such as a printer, keyboard, mouse. The USB allows disconnection of a USB device without turning off the power.

INDEX

A

Auto ribbon saving 2-12

B

Backing paper A1-3
Bar code A1-1
Batch mode 2-9
Black mark 2-8, A1-2, A1-4
Black mark length A1-3
Black mark sensor 2-8, 4-2
Built-in rewinder 2-10

C

Centronics 1-3, 2-3
Cut mode 2-10
Cutter module 2-10, 4-3, A1-2

D

Dimensions 1-3

E

Effective Print length A1-3
Effective print width A1-3
ERROR LED 1-4, 3-1
Error message 5-1
Expansion I/O interface 1-3, 2-3
Expansion I/O interface board A1-2

F

Fan filter 2-2
Feed gap sensor 2-8, 4-2
FEED key 1-4, 3-1
Flash memory card 2-13

G

Gap 2-8, A1-3
Gap length A1-3
Guaranteed print area A1-5

H

Head lever 1-4, 2-6

I

Interface 2-3, A1-1, A3-1
Issue mode 2-9, A1-1

J

Jammed media 5-3

L

Label 2-6, A1-2, A1-3
LCD message display 1-3, 1-4, 3-1

M

Media 2-6, 4-3, A1-2
Media length A1-3
Media pitch A1-3
Media sensor 2-8

O

ON LINE LED 1-4, 3-1
Operation Panel 1-3, 1-4, 3-1

P

Parallel interface 1-3
Parallel port 2-3
PAUSE key 1-4, 3-1
PCMCIA card 2-13
PCMCIA interface board 2-13, A1-2
Platen 1-4, 4-2
Power consumption A1-1
Power cord 1-2, 2-4
POWER LED 1-4, 3-1
Power switch 1-3, 2-4, 2-5
Pre-printed media 4-3, 5-4
Print head 1-4, 4-1, 4-2
Print head block 1-4
Printing method A1-1
Printing speed A1-1

R

Reflective sensor 2-14, A1-4
Resolution A1-1
RESTART key 1-4, 3-1
Ribbon 2-11, 4-3, A1-5
Ribbon shaft 1-4, 2-11
Ribbon stopper 1-4, 2-11
Ribbon width A1-5
Rotation A1-1
RS-232C 1-3, 2-3, A3-1

S

Serial interface 1-3
Strip mode 2-9
Strip module 2-9, A1-2
Supply voltage A1-1

T

Tag A1-2
Test print 2-14
Thermal direct 2-14, A1-1
Thermal transfer 2-14, A1-1
Threshold setting 5-4
Transmissive sensor 2-14, A1-3
Two-dimensional code A1-1

U

USB interface 1-3, 2-3, A1-2

W

Weight A1-1



TEC

TOSHIBA TEC CORPORATION

M EO1-33034B

Free Manuals Download Website

<http://myh66.com>

<http://usermanuals.us>

<http://www.somanuals.com>

<http://www.4manuals.cc>

<http://www.manual-lib.com>

<http://www.404manual.com>

<http://www.luxmanual.com>

<http://aubethermostatmanual.com>

Golf course search by state

<http://golfingnear.com>

Email search by domain

<http://emailbydomain.com>

Auto manuals search

<http://auto.somanuals.com>

TV manuals search

<http://tv.somanuals.com>