

TOSHIBA



OWNER'S MANUAL

DLP™ Projection Television

COLORSTREAM® SRS WOW THEATERWIDE HD HDTV MONITOR

46HM84

52HM84

62HM84

Owner's Record

The model number and serial number are on the back of your TV. Record these numbers in the spaces below. Refer to these numbers whenever you communicate with your Toshiba dealer about this TV.

Model:

Serial No.:

Introduction

Connecting your TV

Using the Remote Control

Setting up your TV

Using the TV's Features

Appendix

Index



© 2004 TOSHIBA CORPORATION
All Rights Reserved

Dear Customer,

Thank you for purchasing this Toshiba TV. This manual will help you use the many exciting features of your new TV. **Before operating the TV, please read this manual completely**, and keep it nearby for future reference.

Safety Precautions

WARNING

TO REDUCE THE RISK OF FIRE OR ELECTRIC SHOCK, DO NOT EXPOSE THIS APPLIANCE TO RAIN OR MOISTURE.



WARNING
RISK OF ELECTRIC SHOCK
DO NOT OPEN



WARNING: TO REDUCE THE RISK OF ELECTRIC SHOCK, DO NOT REMOVE COVER (OR BACK). NO USER-SERVICEABLE PARTS INSIDE. REFER SERVICING TO QUALIFIED SERVICE PERSONNEL.

 The lightning symbol in the triangle tells you that the voltage inside this product may be strong enough to cause an electric shock. **DO NOT TRY TO SERVICE THIS PRODUCT YOURSELF.**

 The exclamation mark in the triangle tells you that important operating and maintenance instructions follow this symbol.

NOTE TO CATV INSTALLERS

This is a reminder to call the CATV system installer's attention to Article 820-40 of the NEC, which provides guidelines for proper grounding and, in particular, specifies that the cable ground shall be connected to the grounding system of the building, as close to the point of cable entry as practical. For additional antenna grounding information, see items 27 and 28 on page 4.

Lamp Unit Replacement



CAUTION: HOT SURFACE!
The temperature of the lamp immediately after use exceeds 392°F (200°C).
Touching the lamp before it has cooled will result in severe burns. **ALLOW THE LAMP TO COOL FOR AT LEAST ONE (1) HOUR BEFORE REPLACING IT.**

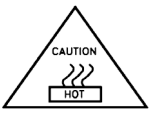

The lamp in this product has a limited service life. The length of service life varies depending on product use and user settings. If you use the lamp beyond its service life:

- you may notice a reduction in the colors and/or brightness of the picture, at which time you should replace the lamp unit; and
- the strength of the quartz glass in the lamp will be reduced and the lamp may rupture. If the lamp ruptures, the TV will not operate until the lamp unit is replaced.

Note: The lamp unit is designed so broken lamp glass remains securely inside the lamp unit.

See "Appendix" on pages 56-60.

- Dispose of the used lamp unit by the approved method for your area.

 **Note:** The lamp unit contains mercury, the disposal of which may be regulated due to environmental considerations. For disposal or recycling information, contact your local authorities or the Electronics Industries Alliance (www.eiae.org).

Child Safety

It Makes A Difference Where Your TV Stands



Congratulations on your purchase! As you enjoy your new TV, keep these safety tips in mind:

The Issue

- If you are like most consumers, you have a TV in your home. Many homes, in fact, have more than one TV.
- The home theater entertainment experience is a growing trend, and larger TVs are popular purchases; however, they are not always supported on the proper TV stands.
- Sometimes TVs are improperly secured or inappropriately situated on dressers, bookcases, shelves, desks, audio speakers, chests, or carts. As a result, TVs may fall over, causing unnecessary injury.

Toshiba Cares!

- The consumer electronics industry is committed to making home entertainment enjoyable and safe.
- The Consumer Electronics Association formed the Home Entertainment Support Safety Committee, comprised of TV and consumer electronics furniture manufacturers, to advocate children's safety and educate consumers and their families about television safety.

Tune Into Safety

- One size does NOT fit all! Use appropriate furniture large enough to support the weight of your TV (and other electronic components).
- Use appropriate angle braces, straps, and anchors to secure your furniture to the wall (but never screw anything directly into the TV).
- Carefully read and understand the other enclosed instructions for proper use of this product.
- Do not allow children to climb on or play with furniture and TVs.
- Avoid placing any item on top of your TV (such as a VCR, remote control, or toy) that a curious child may reach for.
- Remember that children can become excited while watching a program and can potentially push or pull a TV over.
- Share our safety message about this hidden hazard of the home with your family and friends. Thank you!



2500 Wilson Blvd.
Arlington, VA 22201 U.S.A.
Tel. 703-907-7600 Fax 703-907-7690
www.CE.org

CEA is the Sponsor, Producer and Manager of the International CES®

Important Safety Instructions

- 1) **Read these instructions.**
- 2) **Keep these instructions.**
- 3) **Heed all warnings.**
- 4) **Follow all instructions.**



- 5) **Do not use this apparatus near water.**
- 6) **Clean only with a dry cloth.**
- 7) **Do not block any ventilation openings.** Install in accordance with the manufacturer's instructions.
- 8) **Do not install near any heat sources** such as radiators, heat registers, stoves, or other apparatus (including amplifiers) that produce heat.
- 9) **Do not defeat the safety purpose of the polarized or grounding type plug.** A polarized plug has two blades with one wider than the other. A grounding type plug has two blades and a third grounding prong. The wide blade or the third prong are provided for your safety. If the provided plug does not fit into your outlet, consult an electrician for replacement of the obsolete outlet.

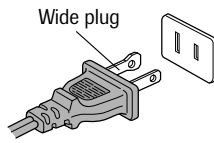

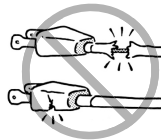

- 10) **Protect the power cord** from being walked on or pinched, particularly at plugs, convenience receptacles, and the point where it exits the apparatus.
- 11) **Only use attachments/accessories specified by the manufacturer.**
- 12) **Use only with the cart, stand, tripod, bracket, or table specified by the manufacturer, or sold with the apparatus.** When a cart is used, use caution when moving the cart/apparatus combination to avoid injury from tip-over.
- 13) **Unplug this apparatus during lightning storms or when unused for long periods of time.**
- 14) **Refer all servicing (except as specified on pages 56–60 in this manual) to qualified service personnel.** Servicing is required when the apparatus has been damaged in any way, such as the power supply cord or plug is damaged, liquid has been spilled or objects have fallen into the apparatus, or the apparatus has been exposed to rain or moisture, does not operate normally, or has been dropped.
- 15) **CAUTION:** To reduce the risk of electric shock, do not use the polarized plug with an extension cord, receptacle, or other outlet unless the blades can be inserted completely to prevent blade exposure.
- 16) **WARNING: This product contains a lamp to project the picture, and requires special safety precautions:**
 - See pages 56–60 for instructions on lamp unit replacement.
 - **DO NOT attempt to service this product except as specified on pages 56–60.** The only user-serviceable items in this product are the lamp unit.



Installation, Care, and Service

Installation

Follow these recommendations and precautions and heed all warnings when installing your TV:

- 17) Never modify this equipment. Changes or modifications may void: a) the warranty, and b) the user's authority to operate this equipment under the rules of the Federal Communications Commission.
- 18) **DANGER: RISK OF SERIOUS PERSONAL INJURY, DEATH, OR EQUIPMENT DAMAGE!** Never place the TV on an unstable cart, stand, or table. The TV may fall, causing serious personal injury, death, or serious damage to the TV.  
- 19) Never place or store the TV in direct sunlight; hot, humid areas; areas subject to excessive dust or vibration; or locations with temperatures at or below 41°F (5°C).
- 20) Always place the TV on the floor or a sturdy, level, stable surface that can support the weight of the unit.
- 21) Never expose the apparatus to dripping or splashing or place items such as vases, aquariums, any other item filled with liquid, or candles on top of the TV.
- 22) Always place the back of the television at least one (1) inch away from any vertical surface (such as a wall) to allow proper ventilation.
- 23) Never block or cover the slots or openings in the TV cabinet back, bottom, and sides. Never place the TV:
 - on a bed, sofa, rug, or similar surface;
 - too close to drapes, curtains, or walls; or
 - in a confined space such as a bookcase, built-in cabinet, or any other place with poor ventilation.The slots and openings are provided to protect the TV from overheating and to help maintain reliable operation of the TV.
- 24) Never allow anything to rest on or roll over the power cord, and never place the TV where the power cord is subject to wear or abuse.
- 25) Never overload wall outlets and extension cords.
- 26) Always operate this equipment from a 120 VAC, 60 Hz power source only.

(continued on next page)

Installation (cont. from previous page)

- 27) Always make sure the antenna system is properly grounded to provide adequate protection against voltage surges and built-up static charges (see Section 810 of the National Electric Code).

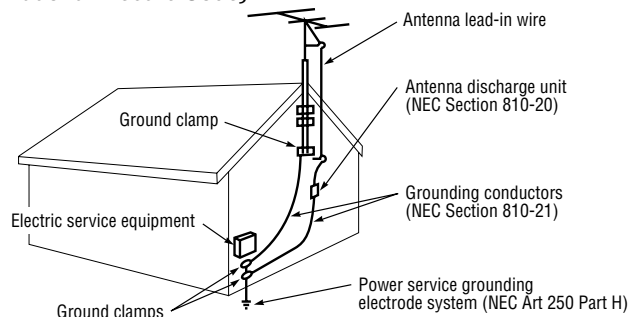



- 28)  **DANGER: RISK OF SERIOUS PERSONAL INJURY OR DEATH!**
- Use extreme care to make sure you are never in a position where your body (or any item you are in contact with, such as a ladder or screwdriver) can accidentally touch overhead power lines. Never locate the antenna near overhead power lines or other electrical circuits.
 - Never attempt to install any of the following during lightning activity:
 - a) an antenna system; or
 - b) cables, wires, or any home theater component connected to an antenna or phone system.

Care

For better performance and safer operation of your TOSHIBA TV, follow these recommendations and precautions:

- 29) Always sit approximately 10–25 feet away from the TV and as directly in front of it as possible. The picture can appear dull if you sit too far to the left or right of the TV, or if sunlight or room lights reflect on the screen. Turn the TV off to check for reflections on the screen, and then remove the source of reflections while viewing the TV.

- 30) Always unplug the TV before cleaning. Never use liquid or aerosol cleaners. Clean only with a dry cloth. Do not spray volatile compounds such as insecticide on the cabinet. This may cause a discoloration or damage of the cabinet.

- 31)  **WARNING: RISK OF ELECTRIC SHOCK!**  Never spill liquids or push objects of any kind into the TV cabinet slots.

- 32) If the air temperature rises suddenly (for example, when the TV is first delivered), condensation may form on the lenses. This can make the picture appear distorted or the color appear faded. If this happens, turn off the TV for 6 to 7 hours to allow the condensation to evaporate.

Care (cont. from previous column)

- 33) For added protection of your TV from lightning and power surges, always unplug the power cord and disconnect the antenna from the TV if you leave the TV unattended or unused for long periods of time.

- 34) During normal use, the TV may make occasional snapping or popping sounds. This is normal, especially when the unit is being turned on or off. If these sounds become frequent or continuous, unplug the power cord and contact a Toshiba Authorized Service Center.

35) Special care for DLP™ (digital light processing) units:

- **Lamp**—The lamp in this product has a limited service life. The length of service life varies depending on product use or user settings. If you use the lamp beyond its service life:



- you may notice a reduction in the colors and/or brightness of the picture, at which time you should replace the lamp unit; and
- the strength of the quartz glass in the lamp will be reduced and the lamp may rupture. If the lamp ruptures, the TV will not operate until the lamp unit is replaced.

See "Appendix" on pages 56–60.

Note:

- *The lamp unit is designed so broken lamp glass remains securely inside the lamp unit.*
-  *The lamp unit contains mercury. Disposal of mercury may be regulated due to environmental considerations. For disposal or recycling information, please contact your local authorities or the Electronics Industries Alliance (www.eiae.org).*
- *Dispose of the used lamp unit by the approved method for your area.*

Service

- 36)  **WARNING: RISK OF ELECTRIC SHOCK!**  Never attempt to service the TV yourself, except as specified on pages 56–60. Opening and removing the covers may expose you to dangerous voltage or other hazards. Failure to follow this WARNING may result in death or serious injury. Refer all servicing not specified in this manual to a Toshiba Authorized Service Center.

- 37) If you have the TV serviced:

- Ask the service technician to use only replacement parts specified by the manufacturer.
- Upon completion of service, ask the service technician to perform routine safety checks to determine that the TV is in safe operating condition.

- 38) When the TV reaches the end of its useful life, ask a qualified service technician to properly dispose of the TV.

Note: *The lamp unit contains mercury. Disposal of mercury may be regulated due to environmental considerations. For disposal or recycling information, please contact your local authorities or the Electronics Industries Alliance (www.eiae.org).*

Important notes about your DLP™ projection TV

- 1) The light source for this TV is a projection lamp unit with a limited service life. When the lamp wears out, the picture may become dark or black, or the lamp may fail, at which time you must replace the lamp unit. See "Lamp unit replacement" on pages 56-60.
- 2) Each time you turn on the TV, it may take up to several seconds to go from no picture to full picture brightness.
- 3) The display on this TV is manufactured using an extremely high level of precision technology; however, an occasional pixel (dot of light) may show constantly on the screen. This is a structural property of micro-display projection TV and is not a sign of malfunction. Such pixels are not visible when the picture is viewed from a normal viewing distance (see item 29 on page 4).
- 4) Depending on the media you are viewing, it is possible, although unlikely, that a limited number of viewers may see a "rainbow effect" on the screen, which can, in rare instances, result in eye fatigue. This is a rare occurrence and is not a sign of TV malfunction.
- 5) Always sit approximately 10-25 feet away from the TV and as directly in front of it as possible. The picture quality may be affected by your viewing position and length of viewing time. If you sit too closely to the TV for too long, you may suffer from eye fatigue. See item 29 on page 4.
- 6)  This TV contains several cooling fans to moderate the internal temperature. You may be able to hear the fans for several minutes after the TV is turned off. This is a function of the Quick Restart standby mode and is not a TV malfunction. You can set the Quick Restart feature to stop the fans as soon as the TV is turned off. See "Selecting the Quick Restart" on page 25.
- 7) The green and red LED lights on the control touchpad (on the lower right corner of the TV screen) indicate your TV's current status. If either light flashes, see "LED indications" on page 60 for details.
- 8) Review all safety and operating information in this owner's manual before you use your TV.

The DLP™ logo and DLP™ medallion are trademarks of Texas Instruments.

Important Safety Information	2-5		
Introduction	7		
Welcome to Toshiba	7		
Exploring your new TV	7		
Connecting your TV	8		
Connecting a VCR	9		
Connecting a cable converter box	9		
Connecting a cable converter box and VCR	10		
Connecting a DVD player or satellite receiver and a VCR	11		
Connecting a DVD player with ColorStream® (component video) and a VCR	12		
Connecting a DTV receiver/set-top box with ColorStream® (component video) and a VCR	13		
Connecting two VCRs	14		
Connecting a camcorder	14		
Connecting an HDMI™ or a DVI device to the HDMI input	15		
Connecting an audio system	16		
Using the remote control	17		
Preparing the remote control for use	17		
Installing the remote control batteries	17		
Remote control effective range	17		
Programming the remote control to operate a cable converter box, satellite receiver, VCR, DVD player, or HTIB (home theater in a box)	18		
Remote control codes	18		
Remote control codes (cont.)	19		
Using the remote control to operate a cable converter box, satellite receiver, VCR, DVD player, or HTIB (home theater in a box)	20		
Learning about the remote control	21		
Setting up your TV	22		
Learning about the menu system	22		
Changing the on-screen display language	23		
Selecting the antenna input	23		
Adding channels to the TV's memory	24		
Programming channels automatically	24		
Adding and erasing channels manually	25		
Changing channels	25		
Selecting the Quick Restart	25		
Using the TV's features	26		
Adjusting the channel settings	26		
Switching between two channels using Channel Return	26		
Switching between two channels using SurfLock™	26		
Programming your favorite channels	26		
Labeling channels	28		
Viewing the wide-screen picture formats (480i, 480p and 1080i signals only)	29		
Selecting the picture size	29		
Scrolling the Theater Wide picture (Theater Wide 2 and 3 only)	31		
Using the AUTO ASPECT feature	32		
Using the POP double-window feature	33		
Switching the main and POP pictures	34		
Switching the speaker audio (main or POP)	34		
Double-Window aspect ratio	35		
Using the programmed channel search function	35		
Using the favorite channel search function	36		
About the auto favorite feature	36		
Using the LOCKS menu	37		
Entering the PIN code	37		
If you cannot remember your PIN code	37		
Using the V-CHIP menu	37		
ENABLE BLOCKING	38		
TV RATING (Independent rating system for broadcasters)	38		
MPAA RATING (Independent rating system for movies)	39		
BLOCKING OPTION	39		
Unlocking programs temporarily	40		
Locking channels	40		
Locking the video inputs	42		
Changing the PIN code	42		
Adjusting the picture	43		
Selecting the picture mode	43		
Adjusting the picture quality	43		
Saving new preference	44		
Selecting the color temperature	44		
Using the CableClear™ DNR feature	45		
Resetting picture adjustments	45		
Selecting the lamp mode	46		
Selecting the cinema mode	46		
Selecting the video input source	47		
Labeling the video input sources	47		
Using the closed caption feature	48		
Setting the ON timer	49		
Setting the sleep timer	49		
Setting the clock	50		
Adjusting the sound	51		
Muting the sound	51		
Selecting stereo/SAP broadcasts	51		
Using the WOW™ surround sound feature	52		
Adjusting the sound quality	52		
Resetting your audio adjustments	53		
Using the StableSound® feature	53		
Turning off the built-in speakers	54		
Selecting the Audio OUT sound	54		
Selecting the background of the menu display	55		
Displaying on-screen information	55		
Understanding the auto power off feature	55		
Understanding the last mode memory feature	55		
Appendix	56		
Lamp unit replacement	56		
When to replace the lamp unit	56		
How to replace the lamp unit	57		
Lamp unit disposal	60		
LED indications	60		
Specifications	61		
Troubleshooting	62		
Limited United States Warranty	63		
Limited Canada Warranty	64		
Index	65		

Introduction

See "Important notes about your DLP™ projection TV" on page 5.

Welcome to Toshiba

Congratulations! You have purchased one of the finest DLP™ projection TVs on the market. The goal of this manual is to guide you through setting up and operating your Toshiba TV as quickly as possible.

This manual applies to models 46HM84, 52HM84 and 62HM84. The model and serial numbers are on the back of your TV. Write these numbers in the space provided on the front cover of this manual for your records.

Instructions in this manual are based on using the remote control. You can also use the controls on the TV if they have the same name as those on the remote control.

Please read all the safety and operating instructions carefully, and keep the manual for future reference.

Exploring your new TV

You can operate your TV using the control touchpad on the TV front or the remote control. The back panel and side panel (behind the door) provide all the terminal connections you will need to connect other equipment to your TV. See "Connecting your TV" on page 8.

Illustrations represent 52HM84.

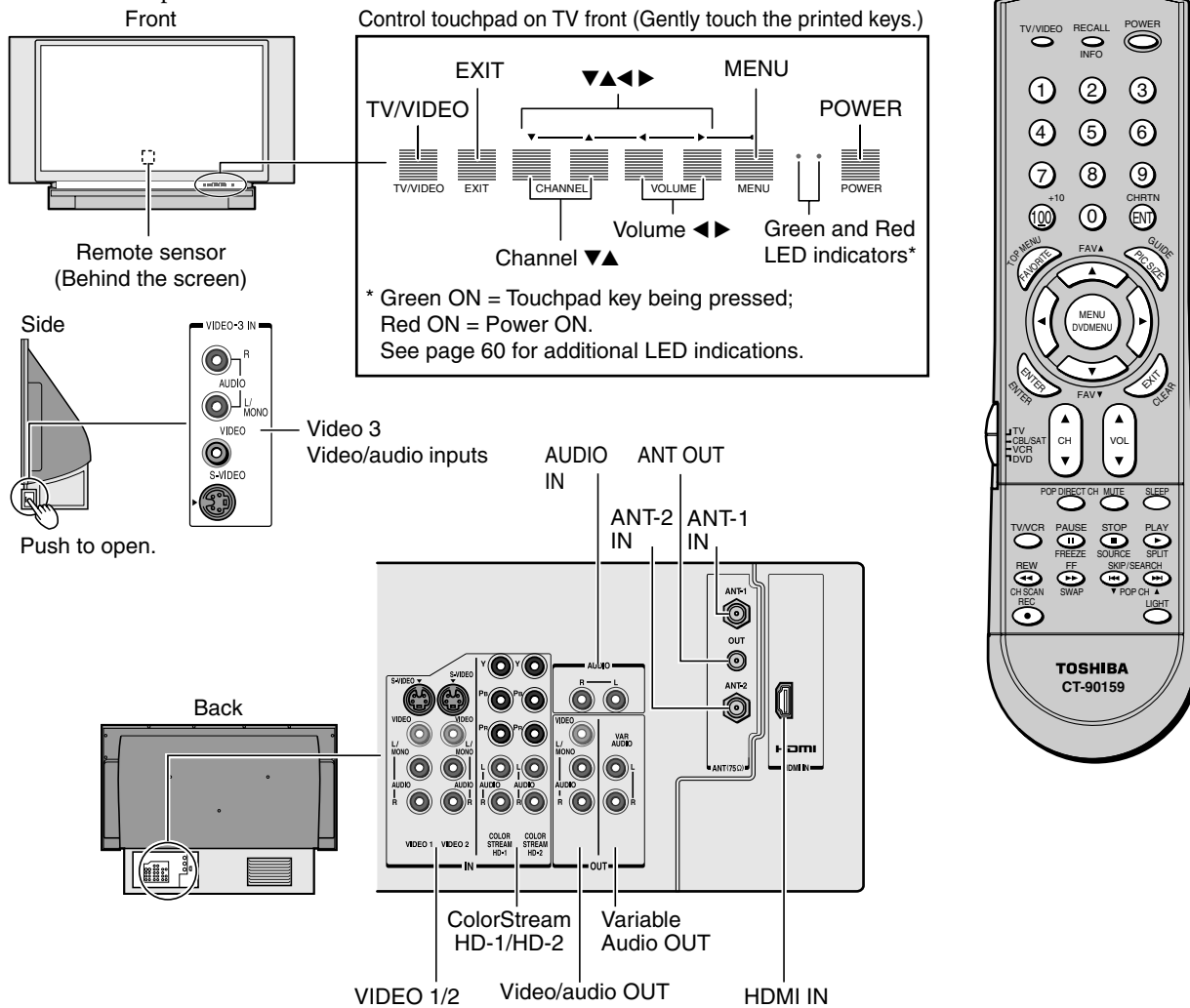

Introduction

Connecting your TV

Using the Remote Control

Setting up your TV

Using the TV's Features

Appendix

Index

Connecting your TV

Note: Cables are not supplied with your TV.

- **Coaxial cable** is the cable that comes in from your antenna, cable TV service, or cable converter box. Coaxial cable uses “F” connectors.
- **Standard A/V (audio/video) cables** usually come in sets of three, and are typically color-coded according to use: yellow for video, red for stereo right audio, and white for stereo left (or mono) audio. On your TV's back panel, the standard A/V inputs are color-coded in the same manner as the cables.
- **S-Video cable** is for use with video equipment that has an S-Video input.
- **Component video cables** come in sets of three, and are for use with video equipment that has component video inputs. (ColorStream® is Toshiba's brand of component video.)
- **HDMI** is for use with video equipment that has an HDMI type A connector (see page 15).

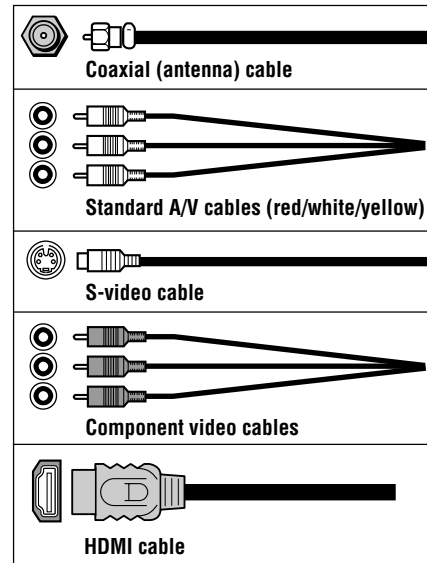

This connection allows you to watch TV programs or basic cable channels.

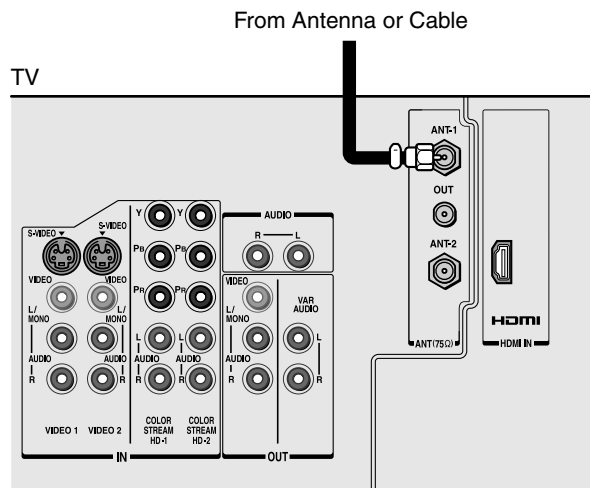

WARNING:
RISK OF ELECTRIC SHOCK!
Never plug in any power cords until you have finished connecting all equipment.

Connecting a VCR

This connection allows you to watch local channels and video programs, play or record on the VCR while watching TV, and record from one channel while watching another channel.

You will need:

- two coaxial cables
- one set of standard A/V cables

From Cable Box or Antenna

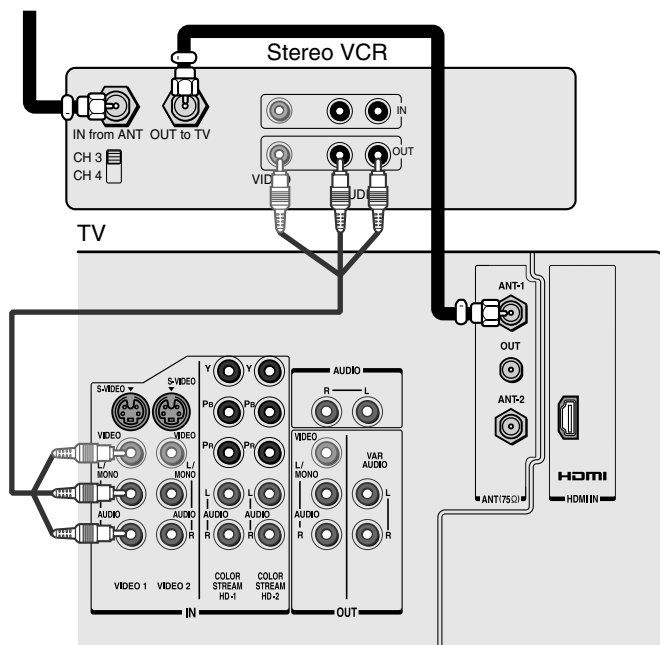

Note:

If you have a mono VCR, connect L/Mono to VCR Audio OUT using only one audio cable.

If you have a VCR with S-video, use an S-video cable (in the S-video jacks) instead of the standard video cable.

Do not connect a standard video cable and an S-video cable to Video-1 (or Video-2) at the same time, or the picture performance will be unacceptable.

The unauthorized recording, use, distribution, or revision of television programs, videotapes, DVDs, and other materials is prohibited under the Copyright Laws of the United States and other countries, and may subject you to civil and criminal liability.

Connecting a cable converter box

This connection allows you to watch basic and premium cable channels.

To watch basic cable and use the TV's features, select ANT-1. To view premium channels, select ANT-2, tune the TV to channel 3 or 4 (whichever channel is vacant in your area), and use the converter box to change channels.

You will need:

- three coaxial cables

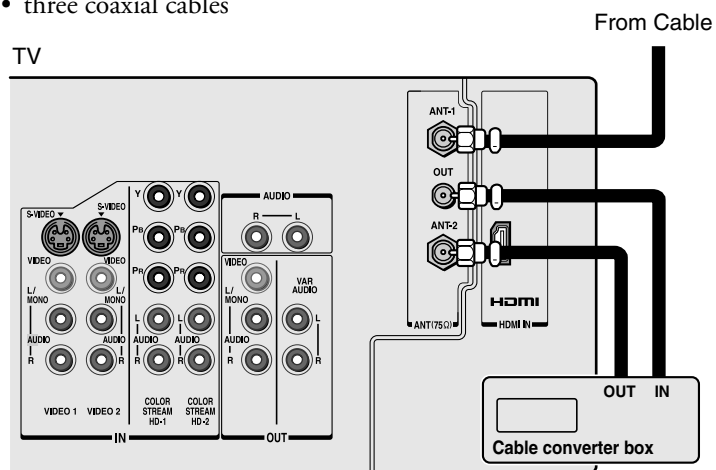

Note:

When you use a converter box with your TV, the remote control will not operate some features, such as programming your favorite channels, labeling channels, and locking channels.

Connecting a cable converter box and VCR

This connection allows you to watch and record basic and premium cable channels, watch videotapes, and record one channel while watching another channel. To watch basic cable and use the TV's features, select ANT-1.

To view premium channels or record with the VCR, select ANT-2, tune the TV to channel 3 or 4 (whichever channel is vacant in your area), and use the converter box to change channels.

You will need:

- four coaxial cables
- one set of standard A/V cables

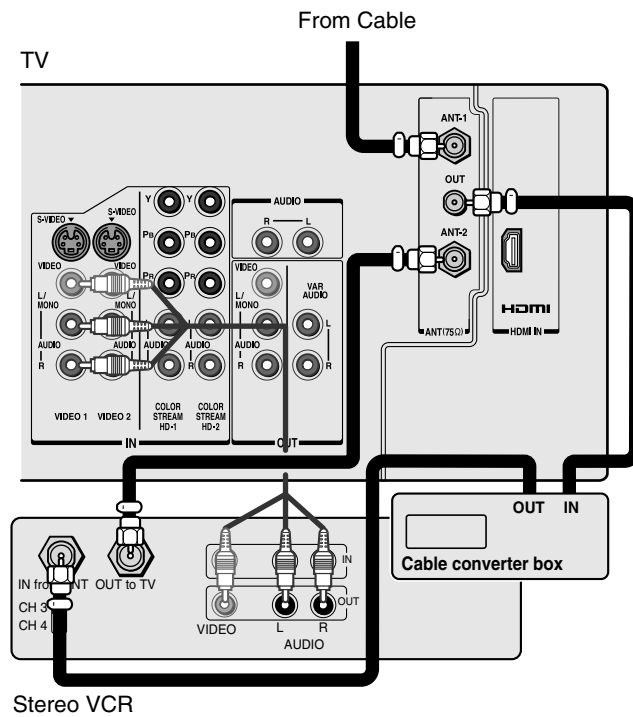

Note:

If you have a mono VCR, connect L/Mono to VCR Audio OUT using only one audio cable.

If you have a VCR with S-video, use an S-video cable (in the S-video jacks) instead of a standard video cable. Do not connect a standard video cable and an S-video cable to Video-1 (or Video-2) at the same time, or the picture performance will be unacceptable.

When you use a converter box with your TV, the remote control will not operate some features, such as programming your favorite channels, labeling channels, and locking channels.

The unauthorized recording, use, distribution, or revision of television programs, videotapes, DVDs, and other materials is prohibited under the Copyright Laws of the United States and other countries, and may subject you to civil and criminal liability.

Connecting a DVD player or satellite receiver and a VCR

This connection allows you to watch DVD/satellite, VCR, and TV programs, and record one TV channel while watching another channel.

You will need:

- two (or three, if satellite receiver is used) coaxial cables
- one set of standard A/V cables (between the TV and VCR) (plus one additional set of standard A/V cables if satellite receiver is used)
- one S-video cable (between the TV and DVD player/satellite receiver)
- one pair of standard audio cables (between the TV and DVD player/satellite receiver)

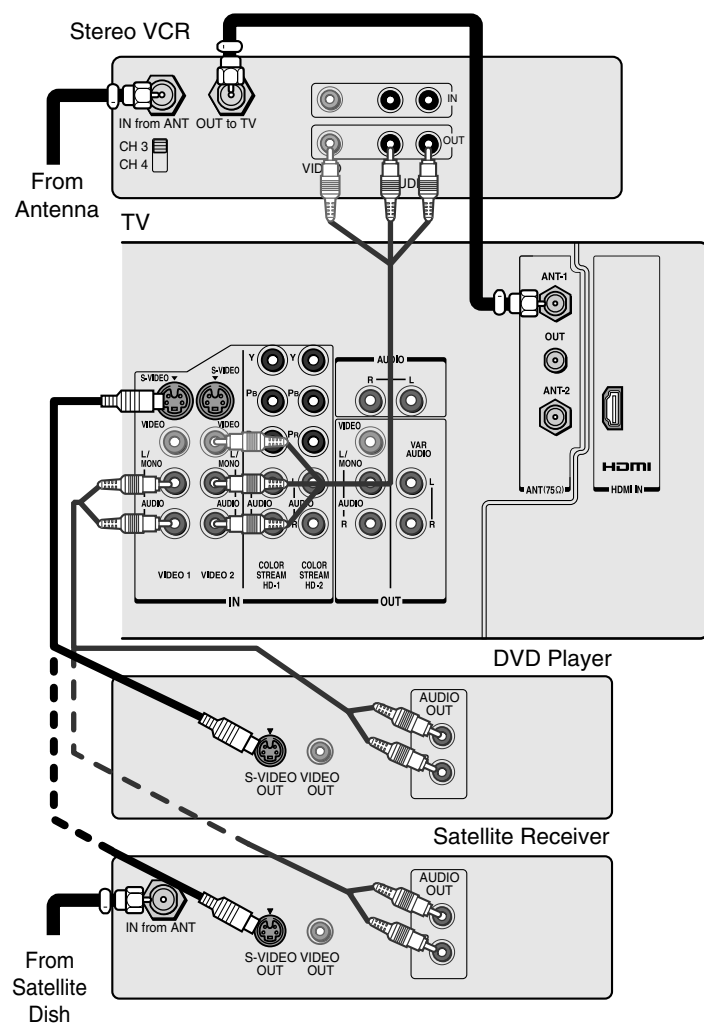

Note:

For the highest possible picture quality from a DVD player or satellite receiver without component video or HDMI, use an S-video cable. (If your DVD player has component video, see page 12. If your DVD player or satellite receiver has HDMI or DVI, see page 15.)

Do not connect both an S-video cable and a standard video cable between the TV and DVD player/satellite receiver at the same time or the picture performance will be unacceptable.

Do not connect the DVD player/satellite receiver and VCR to the same set of Video input on the TV. (See the illustrations, which show the DVD player/satellite receiver connected to Video-1 on the TV, and the VCR connected to Video-2 on the TV.)

The unauthorized recording, use, distribution, or revision of television programs, videotapes, DVDs, and other materials is prohibited under the Copyright Laws of the United States and other countries, and may subject you to civil and criminal liability.

Connecting a DVD player with ColorStream® (component video) and a VCR

This connection allows you to watch DVD, VCR, and TV programs, and record TV programs.

Your TV has ColorStream® (component video) inputs. Connecting your TV to a DVD player with component video inputs (such as a Toshiba DVD player with ColorStream®) can greatly enhance picture quality and realism.

- To record one TV program while watching another TV program, tune the VCR to the channel to record, and tune the TV to the channel to watch.
- To record a TV program while watching a DVD, tune the VCR to the channel to record, and select ColorStream HD1 on the TV (see "Selecting the antenna input" on page 23).

You will need:

- two coaxial cables
- one set of standard A/V cables
- one pair of standard audio cables
- one set of component video cables (one S-video cable for a DVD player without component video inputs; see notes at right)

Note:

For the highest possible picture quality, use component video cables (or an HDMI cable) between the TV and DVD player.

You can connect the component video cables to either set of ColorStream jacks on the TV (HD1 or HD2).

For HDMI or DVI connection, see page 15.

The ColorStream HD1/HD2 and HDMI jacks can be used with Progressive (480p, 720p) and Interlaced (480i, 1080i) scan systems; however, a 1080i signal will provide the best picture performance.

If your DVD player is not compatible with component video, HDMI or DVI, use the S-video connections (plus the standard audio connections) instead (see page 11).

The unauthorized recording, use, distribution, or revision of television programs, videotapes, DVDs, and other materials is prohibited under the Copyright Laws of the United States and other countries, and may subject you to civil and criminal liability.

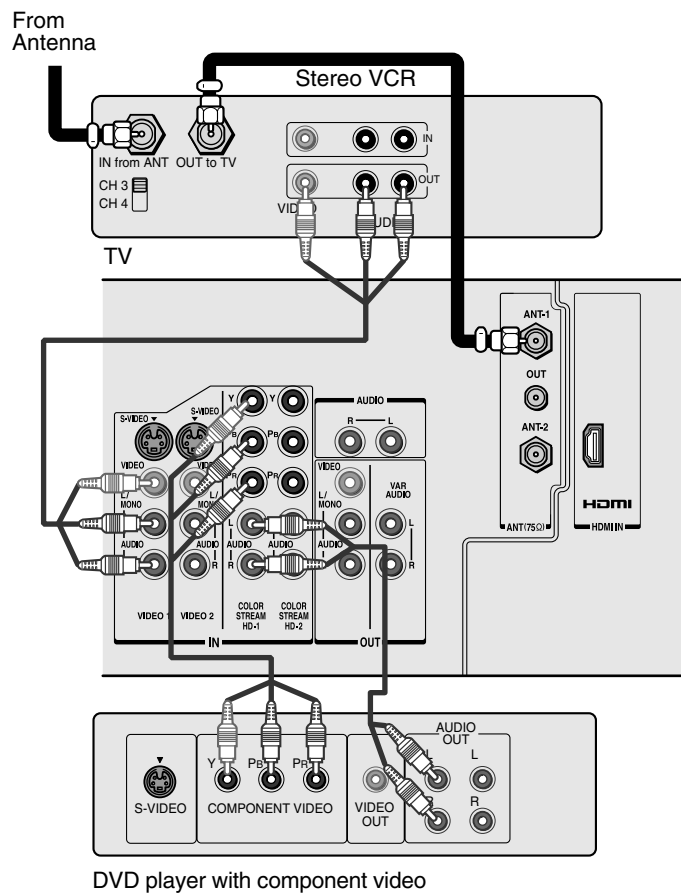

Connecting a DTV receiver/set-top box with ColorStream® (component video) and a VCR

This connection allows you to watch DTV (digital TV), VCR, and TV programs, and record DTV and TV programs.

Your TV has ColorStream (component video) inputs. Connecting your TV to a DTV receiver with component video inputs can greatly enhance picture quality and realism.

- To record and watch a DTV program, select LINE IN on the VCR, and select ColorStream HD2 (or VIDEO 1 for a non-ColorStream connection) on the TV (see "Selecting the antenna input" on page 23).
- To record a TV program while watching a DTV program, tune the VCR to the channel to record, and select ColorStream HD2 on the TV.
- To record and watch the same TV program, tune the VCR to the channel to record, and select VIDEO 1 on the TV.
- To record one TV program while watching another TV program, tune the VCR to the channel to record, and tune the TV to the channel to watch.

You will need:

- three coaxial cables
- two sets of standard A/V cables
- one pair of standard audio cables
- one set of component video cables (one S-video cable for a DTV receiver without component video; see notes at right)

Note:

For the highest possible picture quality, use component video cables (or an HDMI cable) between the TV and DTV receiver/set-top box.

You can connect component video cables to either set of ColorStream jacks on the TV (HD1 or HD2).

For HDMI or DVI connection, see page 15.

The ColorStream HD1/HD2 and HDMI jacks can be used with Progressive (480p, 720p) and Interlaced (480i, 1080i) scan systems; however, a 1080i signal will provide the best picture performance.

If your DTV receiver or set-top box is not compatible with component video or HDMI, use the S-video connections (plus the standard audio connections) instead (see page 11).

The unauthorized recording, use, distribution, or revision of television programs, videotapes, DVDs, and other materials is prohibited under the Copyright Laws of the United States and other countries, and may subject you to civil and criminal liability.

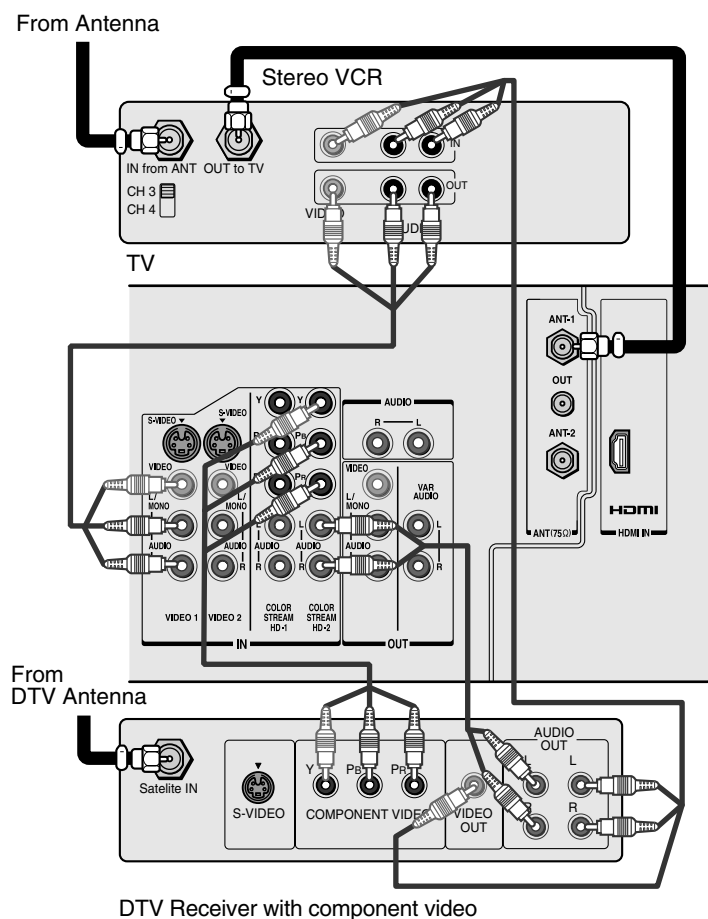

Connecting two VCRs

This connection allows you to record (dub/edit) from one VCR to another VCR while watching a videotape. You can also record from one TV channel while watching another TV channel.

You will need:

- two coaxial cables
- two sets of standard A/V cables

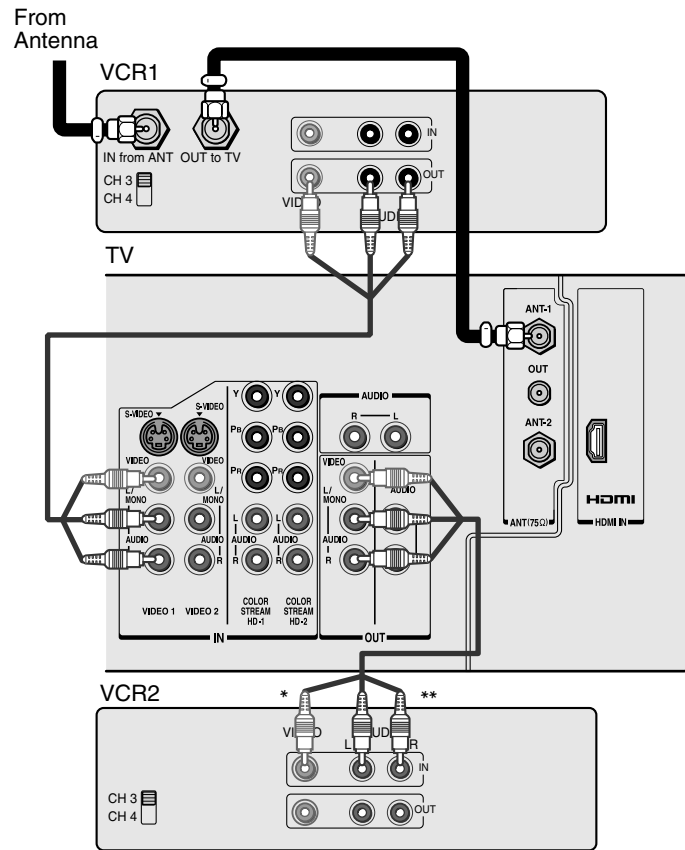

Note:

If you have VCRs with S-video, use S-video cables instead of standard video cables for better picture performance. Do not connect both a standard video cable and an S-video cable to Video-1 (or Video-2) at the same time, or the picture performance will be unacceptable.

Do not connect the same VCR to the output and input jacks on the TV at the same time. To dub or edit, VCR 2 must select Line IN, and the TV must select VIDEO 1 (see "Selecting the antenna input" on page 23).

* The Video OUT jack does not output the POP picture.

** The Audio OUT jacks can output the sound of either the Main or POP picture (see "Selecting the Audio OUT sound" on page 54).

The unauthorized recording, use, distribution, or revision of television programs, videotapes, DVDs, and other materials is prohibited under the Copyright Laws of the United States and other countries, and may subject you to civil and criminal liability.

Connecting a camcorder

This connection allows you to watch video materials recorded on a camcorder.

You will need:

- one set of standard A/V cables

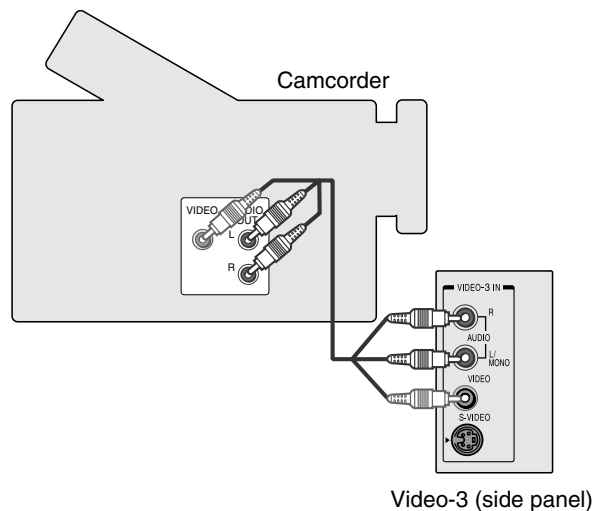

Note:

If you have a camcorder with S-video, use an S-video cable instead of a standard video cable for better picture performance. Do not connect both a standard video cable and an S-video cable at the same time, or the picture performance will be unacceptable.

Connecting an HDMI™ or a DVI device to the HDMI input

The HDMI^[1] input on your TV receives digital audio and uncompressed digital video from an HDMI device or uncompressed video from a DVI^[2] device.

This input is designed to accept HDCP^[3] program material in digital form from EIA/CEA-861/861B-compliant^[4] consumer electronic devices (such as a set-top box or DVD player with HDMI or DVI output).

The HDMI input is designed for best performance with 1080i high-definition video signals, but will also accept and display 480i, 480p, and 720p signals.

Note: This TV is not intended for connection to and should not be used with a PC (personal computer).

To connect an HDMI device, you will need:

- one HDMI cable (type A connector)

For proper operation, it is recommended that you use a shorter HDMI cable. You should not encounter difficulty if you use an HDMI cable which is shorter than 16.4ft (5m).

HDMI cable transfers both video and audio. Separate analog audio cables are not required (see illustration below). Some CDVs (Video CDs) may not output digital audio signals. In that case, you may hear a sound by connecting analog audio cables. However, if you connect analog audio cables with this connection, the HDMI terminal on the TV will not receive the HDMI digital audio signal and you will hear analog audio only.

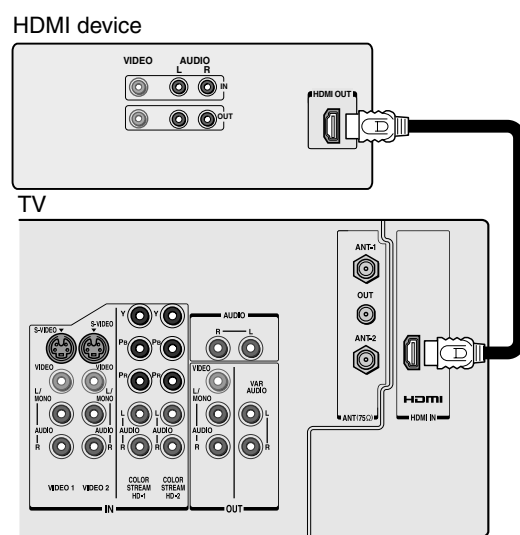

HDMI, the HDMI logo, and High-Definition Multimedia Interface are trademarks or registered trademarks of HDMI Licensing, LLC.

[1] HDMI = High-Definition Multimedia Interface.

[2] DVI = Digital Video Interface.

[3] HDCP = High-bandwidth Digital Content Protection.

[4] EIA/CEA-861/861B compliance covers the transmission of uncompressed digital video with high-bandwidth digital content protection, which is being standardized for reception of high-definition video signals. Because this is an evolving technology, it is possible that some devices may not operate properly with the TV.

To ensure that the HDMI or DVI device is reset properly, it is recommended that you follow these procedures:

- When turning on your electronic components, **turn on the TV first**, and then the HDMI or DVI device.
- When turning off your electronic components, **turn off the HDMI or DVI device first**, and then the TV.

To connect a DVI device, you will need:

- one HDMI-to-DVI adapter cable (HDMI type A connector)

For proper operation, the length of an HDMI-to-DVI adapter cable should not exceed 9.8 ft (3m). The recommended length is 6.6 ft (2m).

- one pair of standard analog audio cables

An HDMI-to-DVI adapter cable transfers only video. Separate analog audio cables are required (see illustration below).

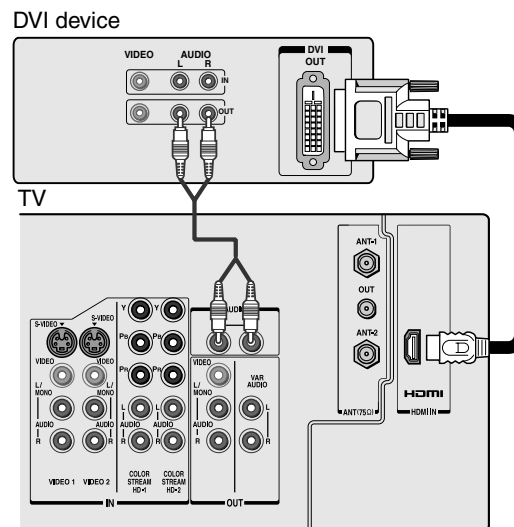

Connecting an audio system

This connection allows you to adjust the audio level by using the TV's remote control.

To control the audio, turn on the TV and the stereo amplifier, and turn off the built-in speakers (see "Turning off the built-in speakers" on page 54).

You will need:

- one pair of standard audio cables

Note:

To hear sound when using an external audio amplifier, the volume of both the TV and the amplifier must be set above 0 (zero).

For example, if the volume of the TV is set to 0, you will not be able to hear any sound, even the volume of the amplifier is at its highest level.

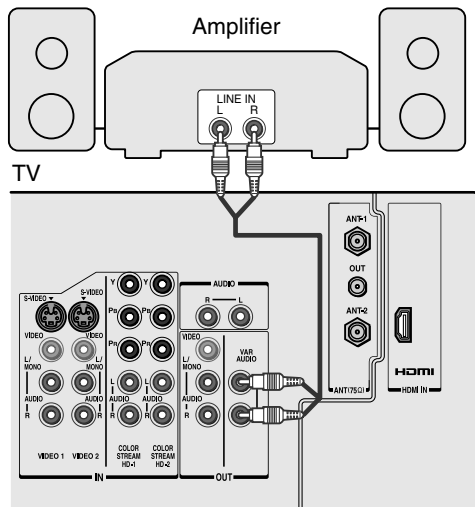

Using the remote control

Preparing the remote control for use

Your TV remote control can operate your TV and many cable converter boxes, satellite receivers, VCRs, DVD players, and HTIBs (home theater in a box), even if they are different brands.

If you have a Toshiba device:

Your TV remote control is preprogrammed to operate most Toshiba devices. See page 20.

If you have a non-Toshiba device or a Toshiba device that the remote control is not preprogrammed to operate:

You can program the TV remote control so it will operate the other device. See pages 18–20.

Installing the remote control batteries

1. Remove the battery cover from the back of the remote control.

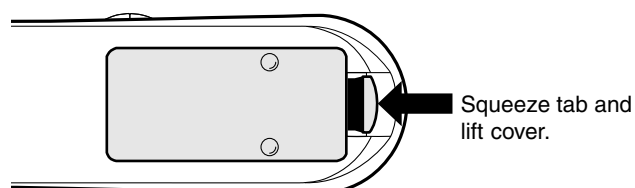

2. Install two "AA" size batteries, making sure to match the + and – signs on the batteries to the signs on the battery compartment.

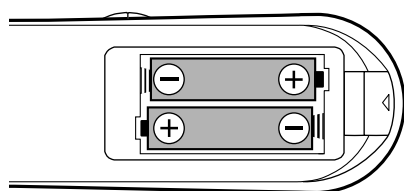

3. Reinsert the battery cover in the remote control until the tab snaps.

Remote control effective range

For optimum performance, aim the remote control directly at the TV and be sure there is no obstruction between the remote control and the TV.

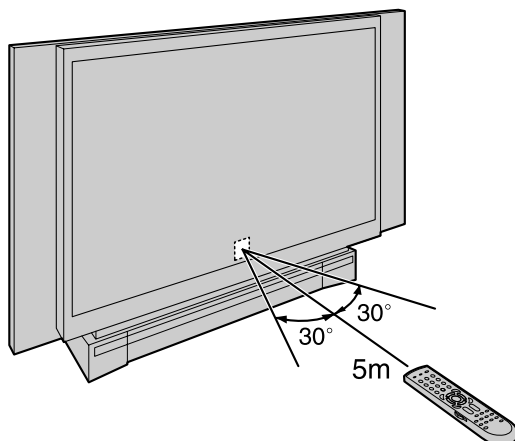

Caution:

- Do not mix battery types or combine used batteries with new ones.
- Do not throw batteries into a fire.

Note:

- If your Toshiba TV remote control does not operate all the features of your other device, use the original remote control for that device.
- Dispose of batteries in a designated disposal area.
- Attention should be drawn to the environmental aspects of battery disposal.
- If the remote control does not operate correctly, or if the operating range becomes reduced, replace both batteries with new ones.
- If the batteries are dead or if you will not use the remote control for a long time, remove the batteries to prevent battery acid from leaking into the battery compartment.

Programming the remote control to operate a cable converter box, satellite receiver, VCR, DVD player, or HTIB (home theater in a box)

Your Toshiba TV remote control is preprogrammed to operate most Toshiba devices. To program your TV remote control to operate a non-Toshiba device (or a Toshiba device that it is not preprogrammed to operate), follow the steps below. For details on using the remote control to operate the device, see page 20.

1. In the remote control code table (below and on the next page), find the code for your device. If more than one code is listed, try each one separately until you find one that works.
2. Set the Device Switch to the type of device you are programming the remote control to operate — **CBL/SAT** (for a cable converter box or satellite receiver), **VCR** (for a VCR or TV/VCR combo), or **DVD** (for a DVD player or HTIB [home theater in a box]).
3. While holding down **RECALL**, press the **Channel Number** buttons to enter the 3-digit code for your device.
4. To test the code, turn on the device, point the remote control at it, and press **POWER**. *See note at right.*
 - If the correct code was entered, the device will turn off.
 - If the device does not respond, repeat steps 1 – 4 using another code.
 - If the device does not respond to another code, you will need to use the remote control that came with the device.
5. Remember to set the **Device Switch** back to **TV** to control the TV.
6. For future reference, write down the code(s) you used:

DEVICE	CODE	DEVICE	CODE

Remote control codes

In some cases you may not be able to operate your device with the TV remote control. Your other device may use a code that is not recognized by the TV remote control. If this happens, use the device's remote control.

Cable converter box	ABC: 061, 062, 063, 082, 084, 087, 091, 092, 096, 098	Hamlin: 093	RCA: 064, 081	U. S. Electronics: 087, 096, 098	General Instruments: 010, 011, 012, 022, 023, 031, 049
	Archer: 065, 092, 097, 099	Jasco: 097	Realistic: 065	United Cable: 082	Hitachi: 033
	Cableview: 064, 094	Jerrold: 062, 069, 071, 082, 086, 089, 091, 096	Recoton: 102	Universal: 065, 092, 097, 099, 102, 103	Hughes: 033
	Century: 092	Magnavox: 072, 096	Samsung: 077, 090	Wards: 096	Hughes Network Systems: 019
	Citizen: 090, 092, 097	Memorex: 091, 092, 104	Scientific Atlanta: 063, 078, 079, 080, 088, 098, 101, 105		Intersat: 048
	Contec: 083, 085, 086, 088, 093, 098	Multi Canal: 090	Sears: 095		Janeil: 027
	Diamond: 093	Novavision: 101	Signature: 062		JVC: 017, 057
	Eagle: 091	Panasonic: 081, 083, 085	Signature 2000: 096		Kenwood: 029
	GE: 061, 062	Philco: 087	Sprucer: 081, 085		Magnavox: 060
	Gemini: 069, 070, 094	Philips: 066, 067, 068, 070, 072, 073, 074, 075, 091, 092	Starcom: 069, 082, 087, 096, 103, 104		Optimus: 058
	General Instruments: 062, 089, 096	Pioneer: 076, 077	Stargate: 069, 090		Pansat: 036, 052
		Proscan: 061, 062	Sylvania: 095, 100		Primestar: 015, 042
		Radio Shack: 092, 097, 099	TeleView: 090		Proscan: 008, 009, 013
			Texscan: 100		Radio Shack: 022, 023, 030
			Tocom: 071, 084, 085		
			Satellite receiver		
			Alphastar: 038, 059		
			Chaparral: 034		
			DISH Network: 057		
			Drake: 020, 040, 044, 046, 050, 053		
			Echostar: 018, 041, 051		
			Express Vu: 057		
			Fujitsu: 027		
			GE: 008, 009, 013		

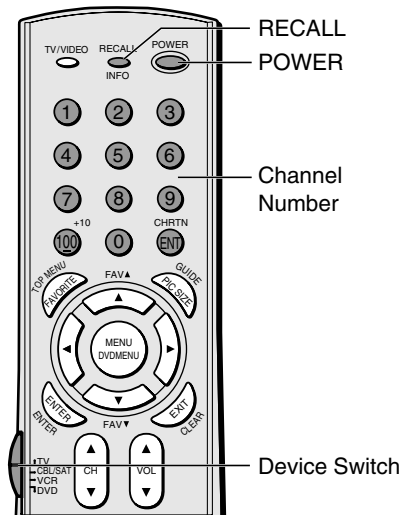

Note:

- In addition to **POWER**, confirm that all necessary keys on the TV remote control operate your device. If some keys are not operational, repeat the device code setup using another code (if other codes are listed for your device). If, after trying all listed codes, the necessary keys do not operate your device, use the device's original remote control.
- Every time you change the batteries, you will need to reprogram the remote control.
- Some newer VCRs respond to either of two codes. These VCRs have a switch labeled "VCR1/VCR2." If your VCR has this kind of switch and does not respond to the codes for your VCR brand, set the switch to the other position ("VCR1" or "VCR2") and reprogram the remote control.

Remote control codes (cont.)

Satellite receiver (cont.)

RCA: 008, 009, 013, 016
 Realistic: 030
 Samsung: 059
 Sony: 014, 055
 Star Choice: 057
 Star Trak: 025, 026, 037, 054
 STS: 024
 Toshiba: 000, 001, 002, 003, 004, 005, 006, 007, 020, 031, 056
 Uniden: 021, 028, 030, 032, 035, 039, 043, 045, 047, 058
 Zenith: 027

TV/VCR Combo

Action: 078
 GE: 059, 062
 Goldstar: 065
 Panasonic: 065
 Precision: 078
 Quasar: 065
 Realistic: 079
 Sony: 074
 Toshiba: 057
 Zenith: 065

DVD/VCR Combo

Go Video:
 DVD=087, VCR=081
 JVC:
 DVD=088, VCR=082
 RCA:
 DVD=089, VCR=083
 Samsung:
 DVD=090, VCR=084
 Sanyo:
 DVD=091, VCR=085
 Zenith:
 DVD=092, VCR=086

DVD player

Aiwa: 006, 015
 Apex: 016, 017
 BOSE: 097
 Broksonic: 018
 Clarion: 019
 Classic: 020
 Daewoo: 021
 Denon: 022, 023, 024, 025
 Emerson: 026, 027
 Fisher: 028
 Funai: 027
 GE: 001, 029, 030
 Go Video: 087
 GPX: 031

Hitachi: 005, 032, 033, 034, 035
 JVC: 003, 007, 036, 042, 088
 Kenwood: 037
 Konka: 008, 009
 Magnavox: 004, 038
 Memorex: 039
 Mintek: 040
 NAD: 026
 Nakamichi: 041
 Norcent: 043
 Onkyo: 044
 Oratron: 058
 Panasonic: 010, 045, 046, 047, 048, 049, 050
 Philips: 004, 051
 Pioneer: 052, 053, 054, 055
 Proscan: 001, 056
 Qwestar: 057, 058
 RCA: 001, 002, 059, 089
 Sampo: 060
 Samsung: 061, 062, 086, 090
 Sansui: 073
 Sanyo: 063, 091
 Sharp: 064, 067
 Sherwood: 074
 Sony: 011, 012, 065, 066, 068, 069, 070
 Sylvania: 027
 Teac: 071
 Technics: 072
 Techwood: 075
 Toshiba: 000, 013, 076, 077, 078
 Yamaha: 079, 080, 081
 Zenith: 014, 082, 092

Portable DVD player

Aiwa: 093
 Audiovox: 094, 095
 Panasonic: 024, 096, 099
 RCA: 098

VCR

Admiral: 049
 Aiko: 019
 Aiwa: 018
 Akai: 003, 004, 037, 038, 039, 058, 069
 Audiovox: 010
 Bell & Howell: 007, 068
 Broksonic: 008, 017
 Calix: 010
 Carver: 026
 CCE: 019
 Citizen: 009, 010, 011, 012, 013, 014, 015, 019, 057, 073
 Colortyme: 005
 Craig: 009, 010, 016, 061, 065, 079
 Curtis Mathes: 001, 005, 009, 012, 014, 040, 048, 053, 056, 057
 Daewoo: 011, 013, 015, 017, 018, 019, 057, 078
 Daytron: 078
 Denon: 063
 Dimensia: 001, 048
 Electrohome: 010, 020, 065
 Emerson: 003, 008, 010, 011, 017, 018, 020, 028, 039, 054, 057, 062, 065, 068, 072
 Fisher: 007, 016, 021, 022, 023, 057, 064, 068, 070, 071, 079
 Fuji: 004, 041
 Funai: 018, 073
 Garrard: 018
 GE: 001, 002, 009, 040, 042, 048, 056
 Go Video: 056, 059, 061, 081
 Goldstar: 005, 010, 014, 054, 056, 065, 067
 Gradiente: 018, 065
 Harman Kardon: 005
 Hitachi: 024, 025, 035, 037, 042, 063, 070, 080
 JBL: 076
 JC Penney: 005, 006, 007, 008, 009, 010, 023, 024, 025, 026, 035, 056, 061, 063, 065
 Jensen: 024, 025, 037, 050
 JVC: 005, 006, 007, 014, 037, 043, 050, 062, 063, 068, 082
 Kenwood: 005, 006, 007, 012, 014, 037, 043, 050, 053, 068, 071
 Kodak: 010
 LG: 010
 Lloyds: 053, 073, 079
 Logik: 061
 LXI: 010
 Magnasonic: 061, 065, 078
 Magnavox: 026, 027, 034, 044, 057, 061, 072
 Marantz: 005, 006, 007, 012, 014, 026, 053, 067

Memorex: 007, 009, 010, 016, 018, 034, 049, 063, 065, 066, 068, 075, 079
 MGA: 020, 028, 039
 MGN: 056
 Minolta: 024, 025, 035, 063
 Mitsubishi: 020, 024, 025, 028, 039, 043, 065
 Montgomery Ward: 049
 Motorola: 049
 MTC: 009, 046, 061
 Multitech: 009, 012, 018
 NEC: 005, 006, 007, 012, 014, 037, 043, 053, 054, 067, 070
 Nikko: 010
 Noblex: 009
 Optimus: 010, 049, 065
 Optonica: 031
 Orion: 054, 057, 062, 065, 068, 072
 Panasonic: 036, 045, 046, 057, 061, 072, 079
 Pentax: 012, 024, 025, 035, 042, 053, 063
 Pentex Research: 014
 Philco: 026, 027, 063
 Philips: 026, 031, 044, 057
 Pioneer: 006, 024, 043, 055
 Portland: 012, 013, 015
 Proscan: 001, 002, 048
 Proton: 061
 Quasar: 045
 Radio Shack: 010, 031, 065
 Radio Shack/Realistic: 007, 009, 010, 016, 018, 020, 021, 022, 031, 049
 Radix: 010
 RCA: 001, 002, 003, 009, 024, 025, 029, 035, 040, 042, 045, 048, 055, 056, 063, 071, 083
 Realistic: 007, 009, 010, 011, 016, 018, 020, 021, 022, 031, 049, 051, 056, 060, 065, 075, 079
 Ricoh: 047
 Runco: 034
 Samsung: 009, 011, 038, 056, 073, 084
 Sansui: 006, 037, 043, 061

Sanyo: 007, 009, 016, 054, 064, 068, 071, 075, 079, 085
 Scott: 008, 011, 017, 028, 030, 057, 065, 072
 Sears: 007, 010, 016, 021, 022, 023, 024, 025, 035, 053, 057, 063, 064, 065, 068, 071, 075, 079
 Sharp: 013, 020, 031, 049, 051, 060, 066
 Shintom: 004, 025, 032, 061
 Signature: 049
 Signature 2000: 075
 Singer: 047, 061
 Sony: 004, 032, 033, 041, 052, 058, 070, 074, 076, 077, 080
 STS: 035
 Sylvania: 018, 026, 027, 028, 044, 072
 Symphonic: 018, 050, 051, 053, 073, 079
 Tandy: 007
 Tashiko: 010
 Tatung: 037
 Teac: 018, 029, 037
 Technics: 036
 Teknika: 010, 018, 065
 Toshiba: 000, 011, 021, 023, 024, 028, 030, 039, 057, 074, 078, 079
 Totevision: 009, 010, 065
 Unitech: 073
 Unitech: 009
 Vector Research: 005, 006, 011, 012, 053
 Video Concepts: 005, 006, 011, 012, 039, 053
 Wards: 009, 010, 011, 016, 018, 020, 024, 025, 031, 035, 049, 051, 056, 057, 060, 065, 066, 079
 White Westinghouse: 073
 XR-1000: 018
 Yamaha: 005, 006, 007, 014, 037, 053
 Zenith: 004, 032, 034, 041, 047, 069, 086

HTIB

Lasonic: 083
 Panasonic: 084
 Venturer: 085

Introduction

Connecting your TV

Using the Remote Control

Setting up your TV

Using the TV's Features

Appendix

Index

Using the remote control to operate a cable converter box, satellite receiver, VCR, DVD player, or HTIB (home theater in a box)

If you have a non-Toshiba device or a Toshiba device that the remote control is not preprogrammed to operate, you must first program the remote control to recognize the device (if you have not already done so). See pages 18 and 19.

To use your TV remote control to operate a:

- cable converter box or satellite receiver, set the **Device Switch** to CBL/SAT.
- VCR, set the **Device Switch** to VCR.
- DVD player or HTIB, set the **Device Switch** to DVD.

Note:

Even after the TV remote control is programmed, it may not operate certain features on your other device. If this happens and you wish to use those features, you will need to use the device's original remote control.

Using the Remote Control

Point the remote control directly at the device.

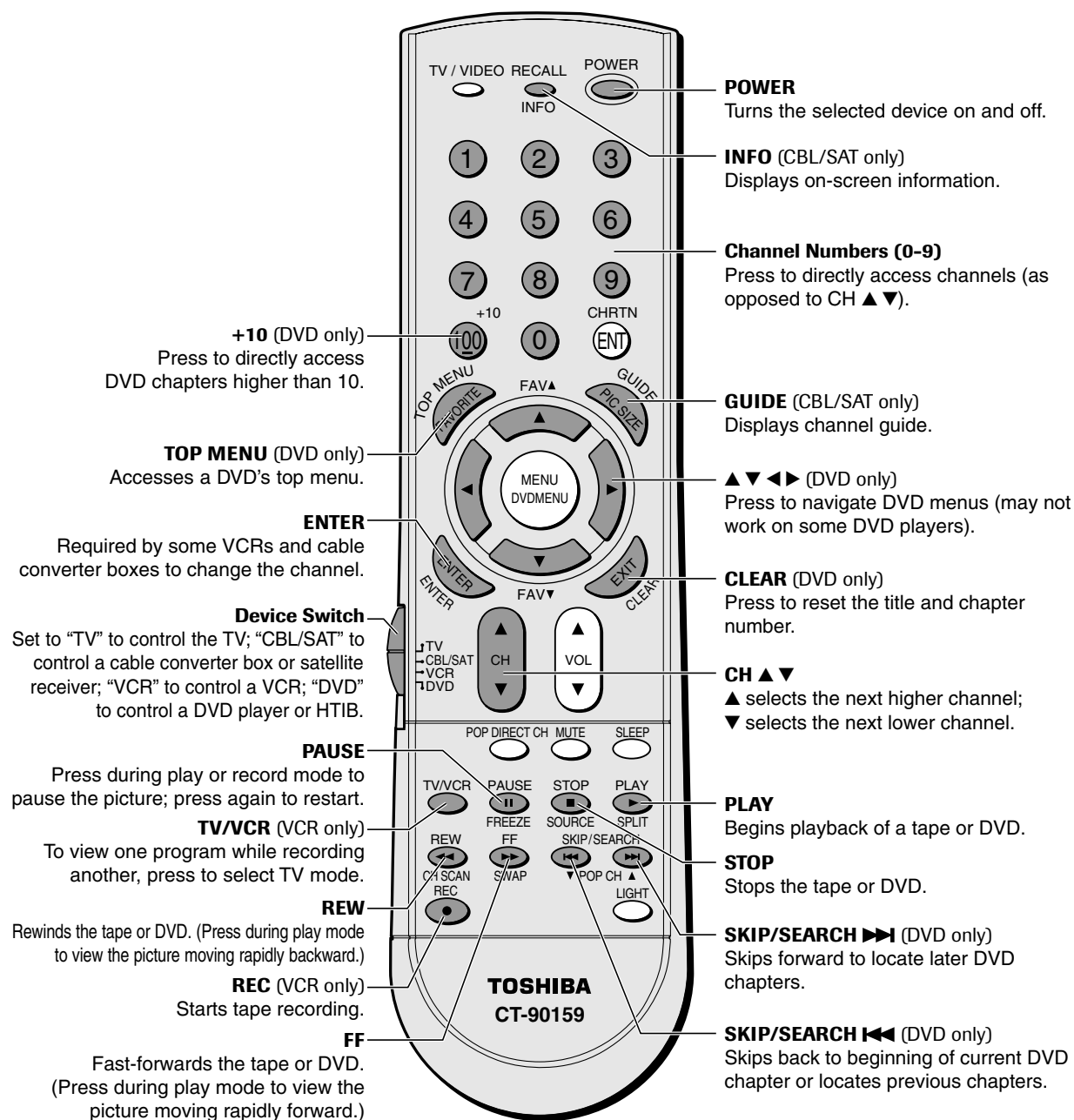

Learning about the remote control

The buttons used for operating the TV only are described here.

POWER turns the TV on and off.

Press **POWER** to turn the TV on. The Red LED indicator will be illuminated.

Press **POWER** again to turn the TV off.

Note:

If the Quick Restart feature is in ON mode, it can take up to several seconds for the picture to appear. See page 25 for details.

RECALL displays screen information (page 55)

SLEEP sets the TV to turn off at a specific time (page 49)

TV/VIDEO selects video input source (page 47)

MUTE mutes the sound (page 51)

Device Switch switches between TV, CBL/SAT, VCR, and DVD (Pages 18-20)
Set to "TV" to control the TV.

CH (channel) ▲ ▼ cycles through programmed channels (page 25)

Channel Numbers (0-9, 100) allow direct access to channels (page 25)

VOL (volume) ▲ ▼ adjusts the volume level

CH RTN returns to the memorized channel (page 26)

MENU allows access to on-screen programming menus (page 22)

ENTER activates the function settings in the menu (page 22)

▲ ▼ ◀ ▶ select or adjust programming menus (page 22)

POP CH ▲ ▼ selects the POP (picture-out-picture) channel (page 33)

FAV ▲ ▼ cycles through favorite channels (page 27)

FAVORITE allows access to the favorite channel search function (page 36)

PIC SIZE cycles through the five picture sizes: Natural, Theater Wide 1, 2, 3, and Full (page 29)

EXIT exits programming menus (page 22)

SPLIT turns the POP feature on and off (page 33)

SOURCE selects the POP picture source (page 33)

FREEZE freezes the picture. Press again to restore the picture.

SWAP switches the main and POP pictures (page 34)

POP DIRECT CH allows direct access to POP channels (page 33)

CH SCAN allows access to the programmed channel search function (page 35)

LIGHT illuminates the keypad for five seconds

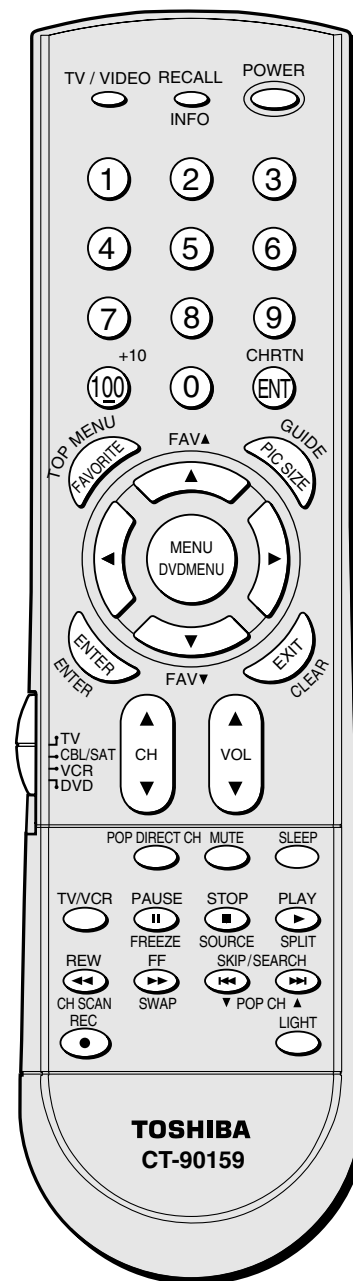

Note:

The error message "Not Available" will appear if you press a key for a function that is not available.

Introduction

Connecting your TV

Using the Remote Control

Setting up your TV

Using the TV's Features

Appendix

Index

Setting up your TV

Learning about the menu system

After you have installed the batteries and programmed the remote control, you will need to set some preferences on the TV by using the menu system. You can access the menu system by using the control touchpad on the TV front or the remote control.

1. Press MENU to display the menu system.
2. Press ◀ or ▶ to select menu.
3. Press ▲ or ▼ to select an item, then press ENTER.
4. Press ▲ or ▼ to select or adjust a setting.
5. Press ENTER to activate the settings.
6. To close the menu, press EXIT.

If you do not make a selection within 15 seconds, the menu display will disappear automatically.

Control touchpad on TV front

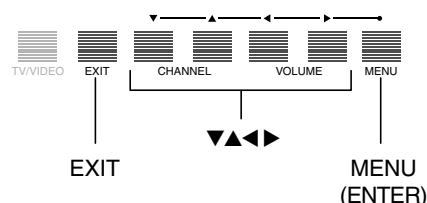

Setting up your TV

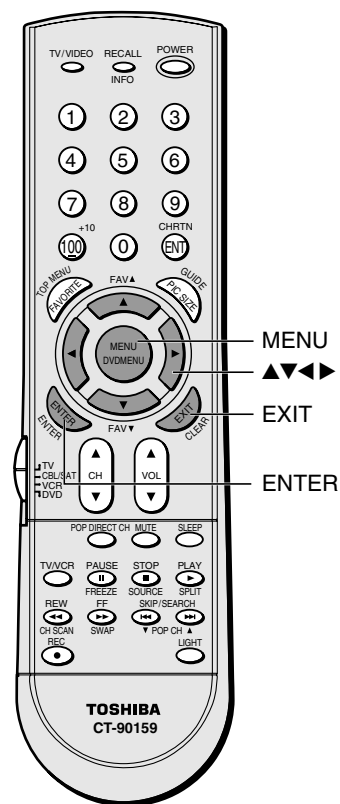
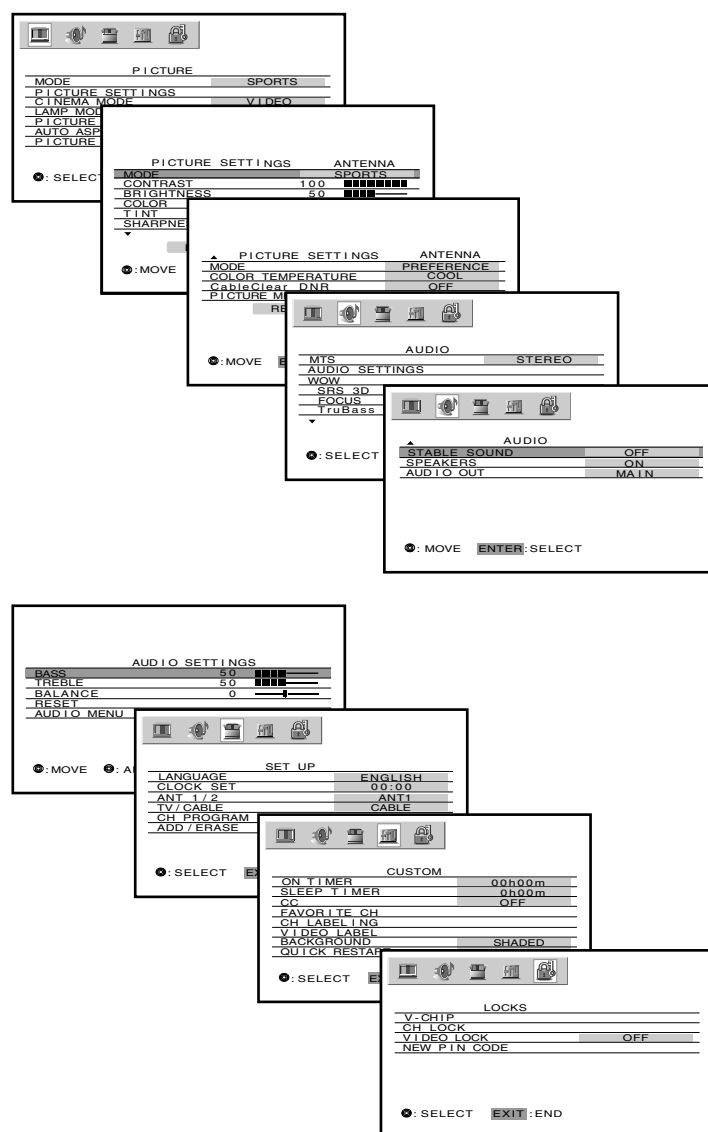

Note:
You can change the background of the menu. See page 55 for details.

Changing the on-screen display language

You can choose from three different languages (English, French and Spanish) for the on-screen display of adjustment menus and messages.

To select a language:

1. Press MENU, and then press ◀ or ▶ until the SET UP menu appears.
2. Press ▲ or ▼ to highlight LANGUAGE, and then press ENTER to display the pull-down menu.

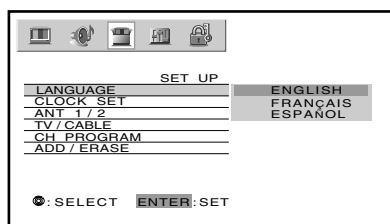

3. Press ▲ or ▼ to highlight your desired language.

Selecting the antenna input

You can connect to two different antenna input sources (ANT 1 or ANT 2).

To select the antenna input using the menu system:

1. Press MENU, and then press ◀ or ▶ to highlight the SET UP menu.
2. Press ▲ or ▼ to highlight ANT 1/2, and then press ENTER to display the pull-down menu.

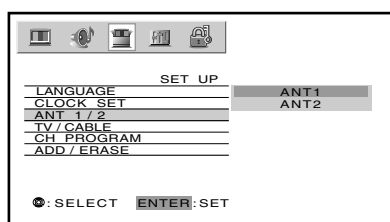

3. Press ▲ or ▼ to highlight either ANT 1 or ANT 2, depending on the antenna terminal you wish to use.

To select the antenna input by using the TV/VIDEO button:

1. Press the TV/VIDEO button on the remote control or TV (see illustrations at right). The current signal source displays in purple.
2. Continue pressing the TV/VIDEO button to select ANT 1 or ANT 2.

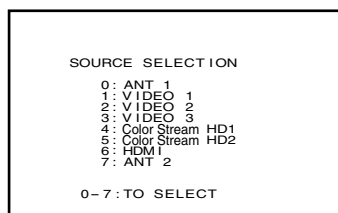

Pressing TV/VIDEO on the remote control displays the current signal source (press TV/VIDEO again or 0-7 to change)

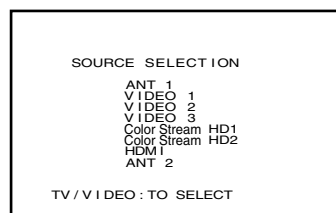

Pressing TV/VIDEO on the TV changes the current signal source

Control touchpad on TV front

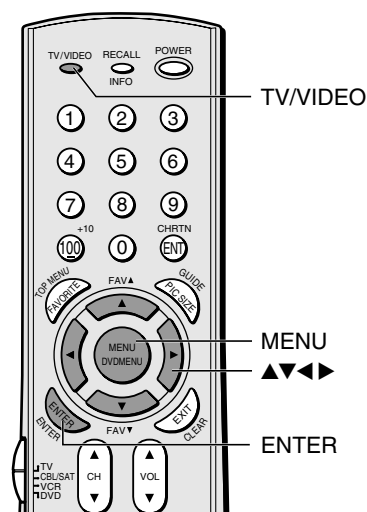
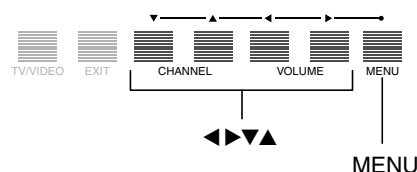

Control touchpad on TV front

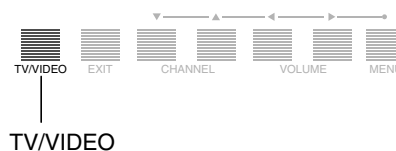

Adding channels to the TV's memory

When you press Channel ▲ or ▼, your TV will stop only on the channels stored in the TV's channel memory.

Follow the steps below and on the next page to program all active channels into the TV's memory.

Programming channels automatically

Your TV can automatically detect all active channels in your area and store them in its memory. After the channels are stored automatically, you can manually add or erase individual channels (see page 25).

To program channels automatically:

1. Press MENU, and then press ◀ or ▶ until the SET UP menu appears.
2. Press ▲ or ▼ until the TV/CABLE is highlighted, and then press ENTER to display the pull-down menu.
3. Press ▲ or ▼ to highlight either TV or CABLE, depending on which you use. If you use an antenna, highlight TV; if you use cable, highlight CABLE.

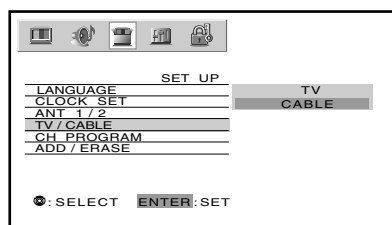

4. Press ENTER.
5. Press ▼ to select CH PROGRAM.

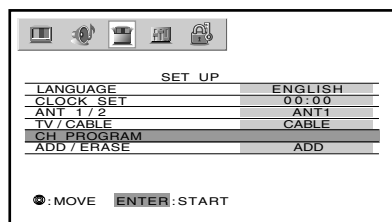

6. Press ENTER to start channel programming. The TV will automatically cycle through all the TV or Cable channels (depending on which you selected), and store all active channels in the channel memory.

While the TV is cycling through the channels, the message "Programming Now—Please Wait" appears.

7. When channel programming is complete, the message "Completed" appears.
8. Press Channel ▲ or ▼ to view the programmed channels.

Note:

To tune the TV to a channel not programmed in the channel memory, you must use the Channel Number buttons on the remote control.

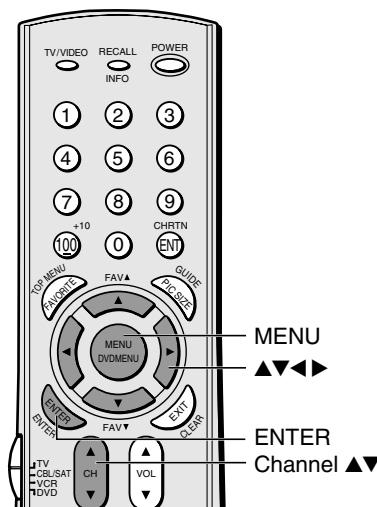

Adding and erasing channels manually

After you have programmed the channels automatically, you can manually add or erase specific channels.

To add or erase channels:

1. Select the channel you want to add or erase. If you are adding a channel, you must select the channel using the Channel Number buttons.
2. Press MENU, and then press ◀ or ▶ until the SET UP menu appears.
3. Press ▲ or ▼ to highlight ADD/ERASE, and then press ENTER to display the pull-down menu.

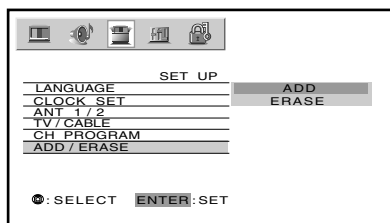

4. Press ▲ or ▼ to select ADD or ERASE, depending on the function you want to perform.
5. Repeat steps 1-4 for other channels you want to add or erase.

Changing channels

To change to a specific channel (programmed or unprogrammed):

Press the Channel Number buttons (0–9 and 100).

For channels 100 and higher, press the 100 button, and then the next two numbers. For example, to select channel 125, press 100, 2, 5.

To change to the next programmed channel:

Press Channel ▲ or ▼ on the TV or remote control.

Selecting the Quick Restart

With the Quick Restart feature set to ON, the TV stays in standby mode for several minutes after the TV is turned off.

If the TV is turned on from standby mode, the full picture appears immediately.

1. Press MENU, and then press ◀ or ▶ until the CUSTOM menu appears.
2. Press ▲ or ▼ to highlight QUICK RESTART, and then press ENTER.
3. Press ▲ or ▼ to select ON or OFF, and then press ENTER.

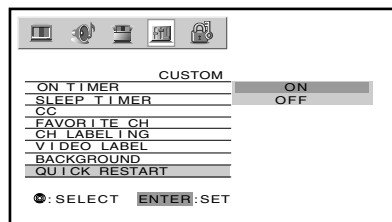

Control touchpad on TV front

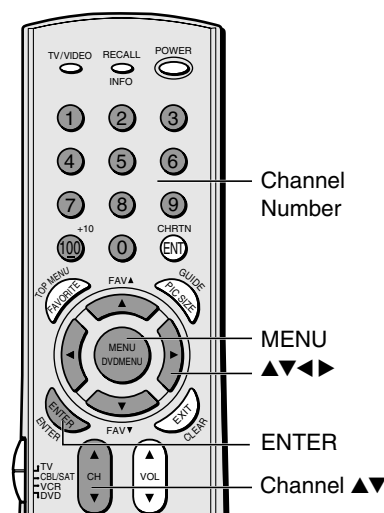
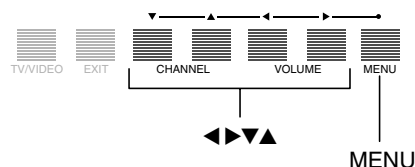

Note:

If Quick Restart is set to OFF and you turn off the TV, it can take up to several seconds for the picture to appear when you turn on the TV again.

If Quick Restart is set to ON and you turn off the TV, the following will occur for a few minutes:

- The screen (lamp) lights dimly.
- The fans continue to run.

This is a function of the Quick Restart feature (standby mode) and is not a TV malfunction. If you do not prefer this, set the Quick Restart feature to OFF.

When in the Quick Restart OFF mode, if you continue to switch the TV ON and OFF in a short time, the useful service life for the lamp may be shorter than the average useful service life.

See "Appendix" on page 56.

Using the TV's features

Adjusting the channel settings

Switching between two channels using Channel Return

The Channel Return feature allows you to switch between two channels without entering an actual channel number each time.

1. Select the first channel (or video mode) you want to view.
2. Select a second channel by using the Channel Number buttons (0–9, 100).
3. Press CH RTN. The previous channel will display.

Each time you press CH RTN, the TV will switch back and forth between the last two channels that were selected.

Switching between two channels using SurfLock™

The SurfLock™ feature temporarily “memorizes” one channel in the CH RTN button, so you can return to that channel quickly from any other channel by pressing CH RTN.

To memorize a channel in the CH RTN button:

1. Select the channel you want to program into the CH RTN button.
2. Press and hold CH RTN for about 2 seconds until the message “Channel Memorized” appears on the screen. The channel has been programmed into the CH RTN button.
3. Continue to change channels until your desired channel is selected.
4. Press CH RTN. The memorized channel will be selected.

The TV will return to the memorized channel one time only. Once you press CH RTN and then change channels again, the CH RTN button memory will be cleared and the button will function as Channel Return, by switching back and forth between the last two channels that were selected.

Programming your favorite channels

You can preset up to 12 of your favorite channels using the Favorite Channel Programming feature. Because this feature scans through only your favorite channels, it allows you to skip other channels you do not normally watch.

To program your favorite channels:

1. Press MENU, and then press ◀ or ▶ until the CUSTOM menu appears.
2. Press ▲ or ▼ to highlight FAVORITE CH.

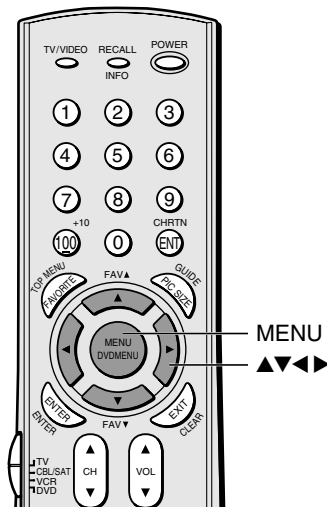
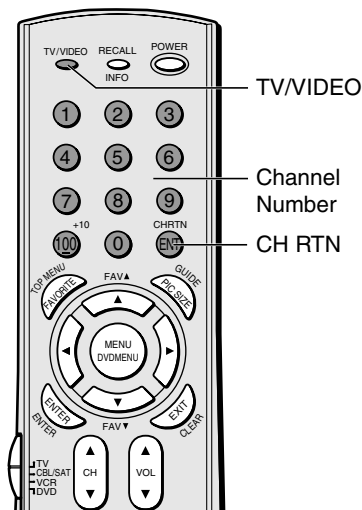
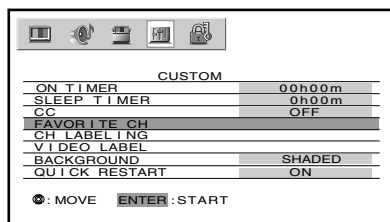

(continued on next page)

- Press ENTER to display the FAVORITE CH menu. CH INPUT will be highlighted.

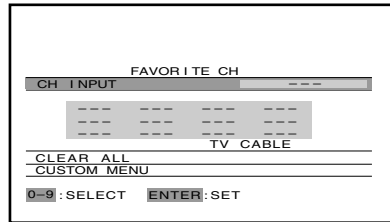

- Press the Channel Number buttons to enter one of your favorite channels.
- Press ENTER.
- Repeat steps 4 and 5 for other channels.

To select your favorite channels:

Press FAV ▼ or ▲.

To quickly scan through your favorite channels in a twelve-picture multi-window:

Press FAVORITE (see page 36 for details).

To clear a favorite channel:

- Press MENU, and then press ◀ or ▶ until the CUSTOM menu appears.
- Press ▲ or ▼ to highlight FAVORITE CH.
- Press ENTER to display the FAVORITE CH menu.

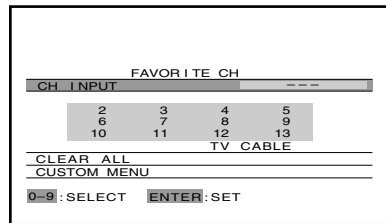

- Press ▲▼◀▶ to highlight the channel you want to clear, then press ENTER.

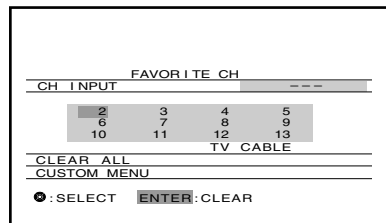

- Repeat step 4 for other channels.

To clear all favorite channels at once:

Press ▲ or ▼ to highlight CLEAR ALL in step 4 above, and then press ENTER to clear all favorite channels at once.

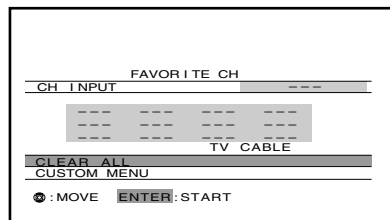

Note:

- The FAV ▼▲ buttons operate as MENU ▼▲ buttons when a menu is on-screen.
- The favorite channel feature is not available in ANT2 mode.

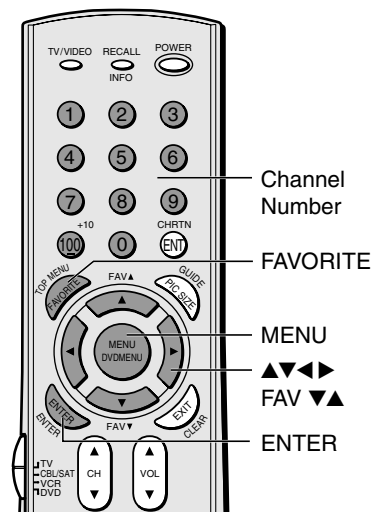

Labeling channels

Channel labels appear above the on-screen channel number display each time you turn on the TV, change a channel, or press RECALL. You can choose any four characters to identify a channel.

To create channel labels:

1. Press MENU, and then press ◀ or ▶ until the CUSTOM menu appears.
2. Press ▲ or ▼ to highlight CH LABELING.
3. Press ENTER to display the CH LABELING menu.
CH INPUT will be highlighted.

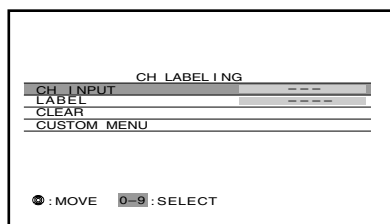

4. Press the Channel Number buttons to select a channel you want to label.
5. Press ▼ to highlight LABEL.
6. Press ◀ or ▶ repeatedly to select a character for the first space, and then press ENTER.

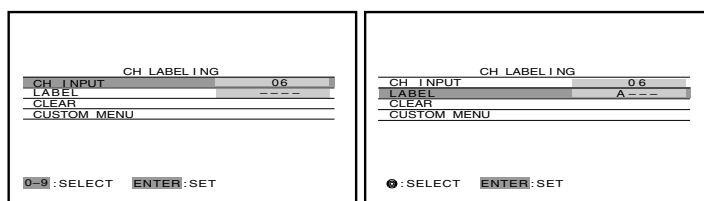

7. Repeat step 6 to enter the rest of the characters.
If you would like a blank space in the label name, you must choose an empty space from the list of characters. Otherwise, a dash “-” will appear in that space.
8. Repeat steps 4–7 for other channels. You can assign labels to a maximum of 32 channels.

To erase channel labels:

1. Press MENU, and then press ◀ or ▶ until the CUSTOM menu appears.
2. Press ▲ or ▼ to highlight CH LABELING.
3. Press ENTER to display the CH LABELING menu.
4. Press ▼ to highlight CH INPUT, then select the channel you want to clear with the Channel Number buttons.
5. Press ▼ or ▲ to highlight CLEAR.
6. Press ENTER to erase the channel label.
7. Repeat steps 4–6 to erase other channel labels.

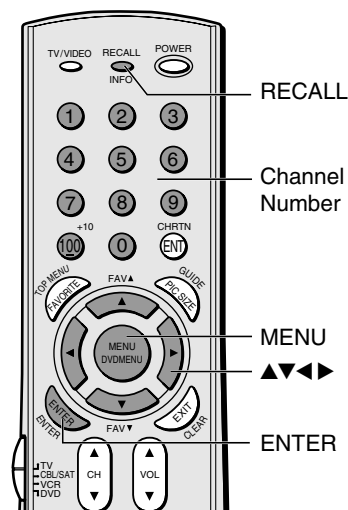
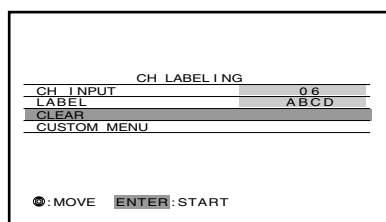

Viewing the wide-screen picture formats (480i, 480p and 1080i signals only)

You can view 480i, 480p and 1080i format programs in a variety of picture sizes—Natural, Theater Wide 1, Theater Wide 2, Theater Wide 3, and Full. (The Full picture size is not selectable for 1080i format program.)

The way the image displays in any of the picture sizes will vary depending on the format of the program you are viewing. Select the picture size that displays the current program the way that looks best to you.

Selecting the picture size

1. Press PIC SIZE on the remote control.
2. Press the corresponding number button (0-4) to select the desired picture size, as described below and on the next page.

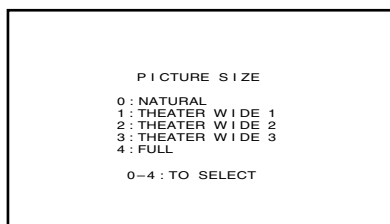

Natural picture size

- The image is displayed close to its originally formatted proportion. Some program formats will display with side bars and/or bars at the top and bottom.

Natural picture size example: The way the image displays will vary depending on the format of the program you are currently watching.

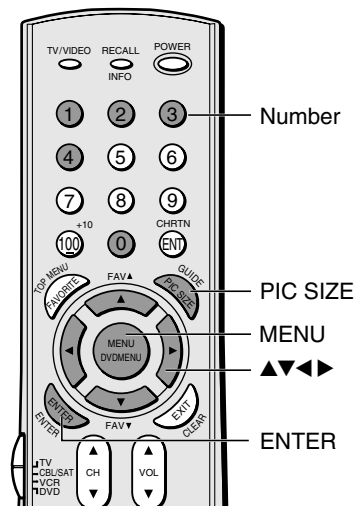
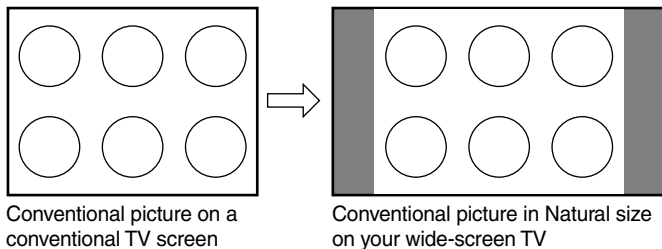

Note:

You also can change the picture size by selecting PICTURE SIZE in the PICTURE menu.

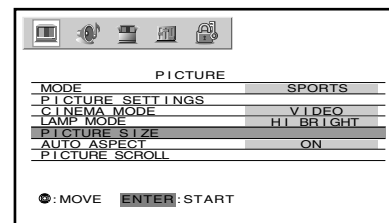

Introduction

Connecting your TV

Using the Remote Control

Setting up your TV

Using the TV's Features

Appendix

Index

(continued on next page)

Theater Wide 1 picture size (For 4:3 format program)

- The picture is non-uniformly enlarged—the center of the picture remains close to its original proportion, but the left and right edges are stretched wider to fill the screen.
- A small part of the picture at the top and bottom is hidden; however, this mode cannot be scrolled.

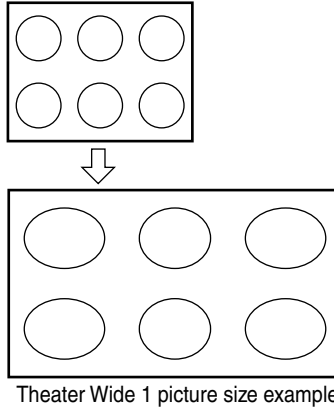

Note:

- To select the picture size, press *PIC SIZE* on the remote control or select *PICTURE SIZE* in the *PICTURE* menu.
- The *PICTURE SIZE* feature is not available for some program formats (such as 1080i or 720p). Such formats will display in *Natural* picture size (see page 29).
- If you select *Theater Wide 2* or *3*, the top and bottom edges of the picture may be hidden. To see the hidden edges, either scroll the picture (see page 31) or try viewing the program in *Full* picture size.

Theater Wide 2 picture size (For Letter box program)

- The entire picture is uniformly enlarged—it is stretched the same amount both wider and taller (retains its original proportion).
- Part of the picture at the top and bottom is hidden. To view the hidden areas, see “Scrolling the Theater Wide picture” on page 31.

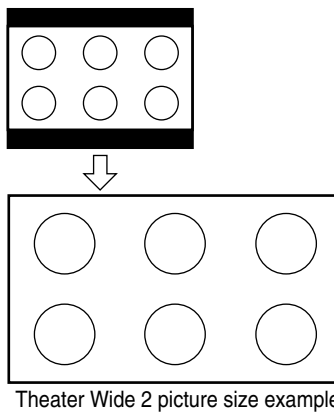

Theater Wide 3 picture size (For Letter box program with subtitles)

- The picture is non-uniformly enlarged—it is stretched wider to fill the width of the screen, but only slightly stretched taller.
- A small part of the picture at the top and bottom is hidden. To view the hidden areas (such as subtitles or captions), see “Scrolling the Theater Wide picture” on page 31.

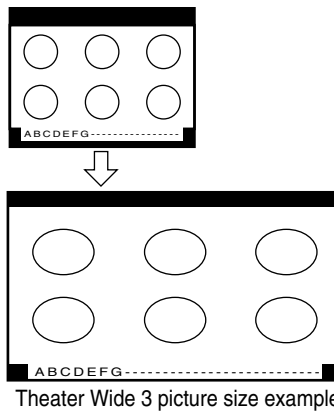

Note:

Using these functions to change the picture size (i.e., changing the height/width ratio) for any purpose other than your private viewing may be prohibited under the Copyright Laws of the United States and other countries, and may subject you to civil and criminal liability.

Full picture size (For 16:9 source program)

- The picture is non-uniformly enlarged—if receiving 4:3 format program, it is stretched wider to fill the width of the screen, but not stretched taller.
- None of the picture is hidden.

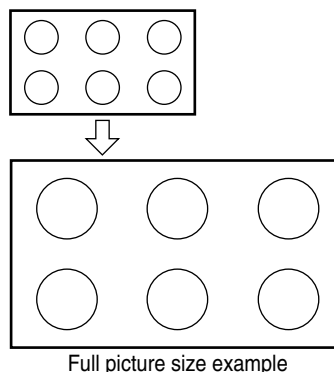

Scrolling the Theater Wide picture (Theater Wide 2 and 3 only)

1. Press PIC SIZE to select the Theater Wide 2 or 3 mode.
2. Press MENU, and then press ◀ or ▶ until PICTURE menu appears.
3. Press ▲ or ▼ to highlight PICTURE SCROLL.

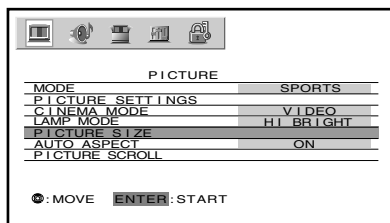

4. Press ENTER to display the Scroll Adjustment mode.

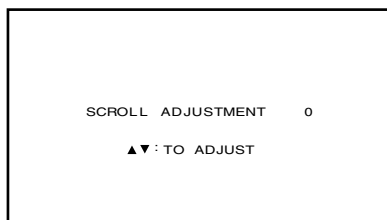

5. Press ▲ or ▼ to adjust the vertical position of the picture.
 - Normal (center) position

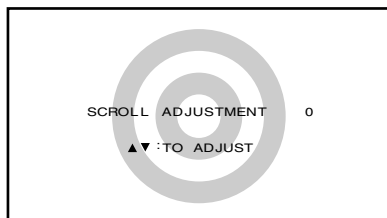

- To raise the picture, press ▲.

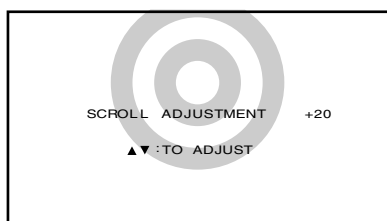

- To lower the picture, press ▼.

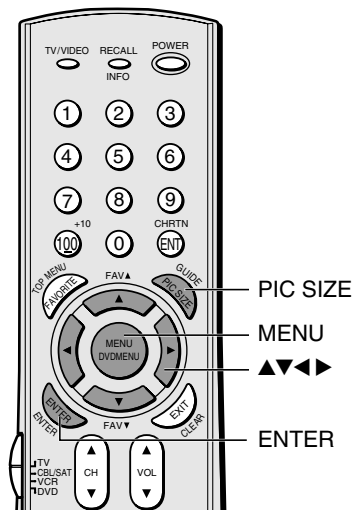
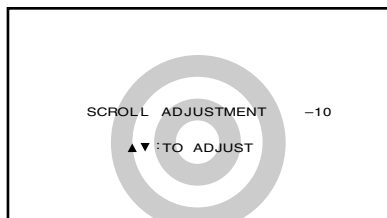

Note:

You can scroll the picture in Theater Wide 2 and Theater Wide 3 only. The scroll amounts are as follows:

- 480i/480p/1080i signal source:
 - Wide 1 : Not adjustable
 - Wide 2 : -10 to +20
 - Wide 3 : -10 to +20

Using the AUTO ASPECT feature

When the AUTO ASPECT feature is set to ON and the TV receives a 480i signal, the picture size is automatically selected (as described in the following table).

Aspect ratio of signal source	Automatic aspect size (automatically selected when AUTO ASPECT is ON)
4:3 Normal	Natural
16:9 Full	Full
4:3 Letter box	Theater wide 2
Not defined (no ID-1 data)	User-set mode

If the signal does not include aspect information, the picture size you selected on pages 29–30 is displayed.

To turn on the AUTO ASPECT feature:

1. Press MENU, and then press ◀ or ▶ until the PICTURE menu appears.

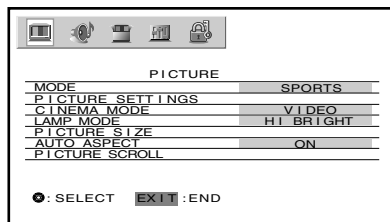

2. Press ▲ or ▼ to highlight AUTO ASPECT, and then press ENTER.

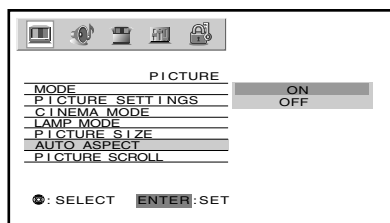

3. Press ▲ or ▼ to select ON, and then press ENTER.

Note:

- The AUTO ASPECT is also available when viewing HDMI input source of 480i or other format.
- The AUTO ASPECT operates according to aspect information indicated in the digital signal of HDMI (not ID-1 signal).

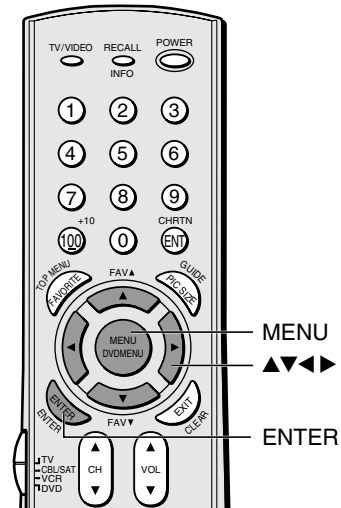

Using the POP double-window feature

The POP (picture-out-picture) feature splits the screen into a double window that allows you to watch two programs at the same time. The POP program can come from a TV broadcast or an external source, such as a VCR.

To display a TV broadcast in the POP window:

1. Press SPLIT to display the POP window.

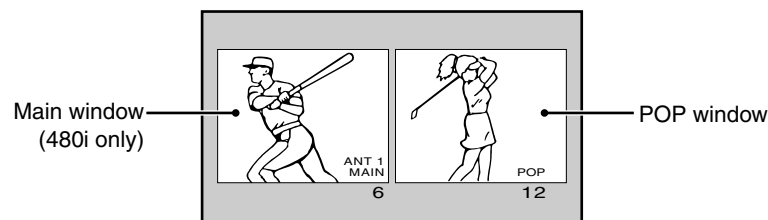

2. Select POP channels in the following two ways:

- To change to a specific channel, press POP DIRECT CH. While "POP" is on the screen, press the Channel Number buttons (0-9 and 100).
- To change to the next programmed channel, press POP CH ▼▲.

If the V-CHIP feature is active and you try to watch a TV program that exceeds your set rating limits, the program will be blocked (see "Using the V-CHIP menu" on page 37).

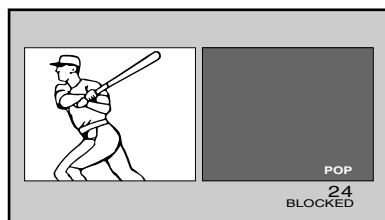

To display a picture from an external source in the POP window:

1. Connect the external source equipment (see "Connecting your TV" on page 8).
2. Select the TV program you want to watch in the main window.
3. Press SPLIT to display the POP window.
4. Repeatedly press SOURCE to select the input source for the POP window (VIDEO 1, VIDEO 2, VIDEO 3, ColorStream HD1, ColorStream HD2 or HDMI). The current source will display in purple.
5. You can play a tape as the POP picture, or select a channel for the POP window using the VCR's channel keys.

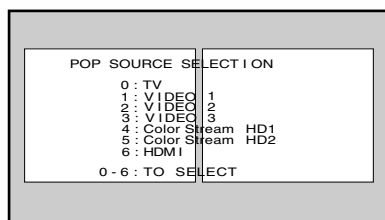

While the above menu is on the screen, you can select the desired signal input source by pressing the corresponding number button (0-6).

To close the POP window:

Press SPLIT again or EXIT.

Note:

- The SPLIT buttons on the remote control operate the TV's POP features.
- You can display only 480i format program in the main window. Only the audio signal is output.
- You cannot display the ANT-2 signal source in the POP window.
- You can choose to output the sound of either the main or POP program through the AUDIO OUT jacks (see "Selecting the Audio OUT sound" on page 54).
- You can choose to hear either the main or POP audio through the TV speakers. (See "Switching the speaker audio (main or POP)" on page 34.)

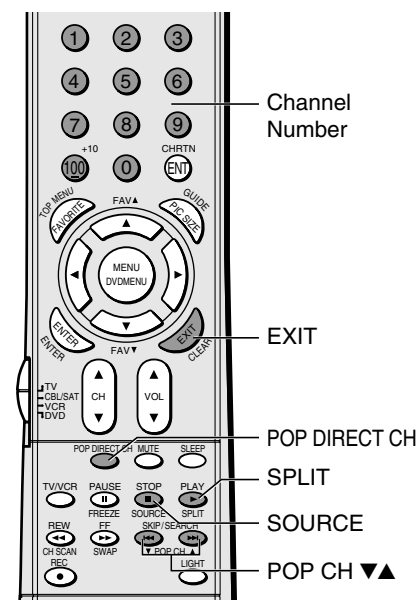

Switching the main and POP pictures

Press SWAP while you are using the POP feature to switch the main and POP pictures.

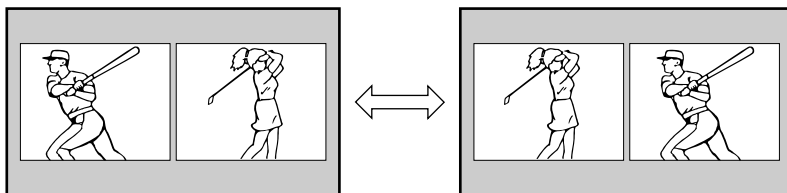

Switching the speaker audio (main or POP)

Press ◀ or ▶ while you are using the POP feature to switch the sound (main or POP) from the speakers. The POP sound in the TV mode is monaural only.

The selected audio source indicator is displayed in purple.

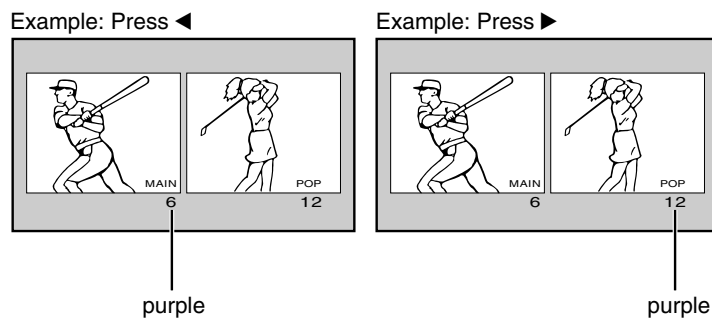

Note:

If the POP program is not 480i format, it will not display in the main window when you press SWAP.

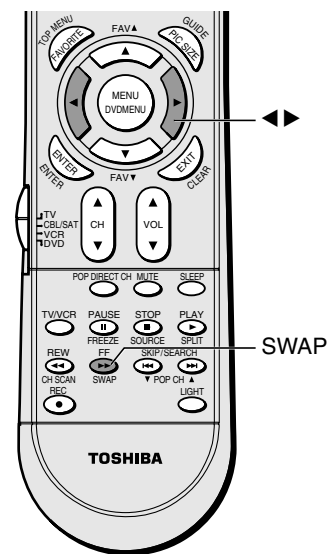

Double-Window aspect ratio

The Double-Window feature displays each picture according to its input signal aspect ratio, as illustrated below.



Using the programmed channel search function

You can use the programmed channel search function to quickly scan the channels you programmed into the TV's memory (page 24).

1. Press CH SCAN.
The TV automatically enters multi-window mode, and begins a twelve-picture scan of your programmed channels in the multi-window.

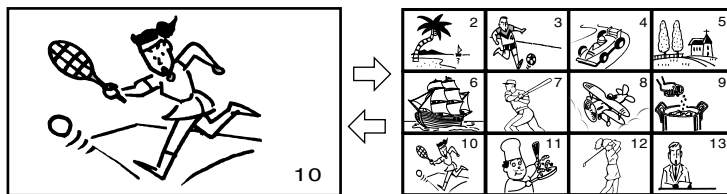

2. Press CH ▲▼ or Channel Number buttons to select one of the twelve pictures.

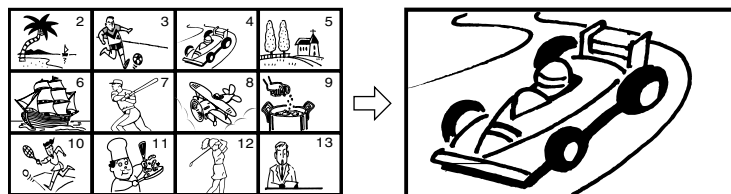

Note:

- The **AUTO ASPECT** feature (page 32) does not operate in double-window mode.
- Aspect ratio is the ratio of width to height of the picture.

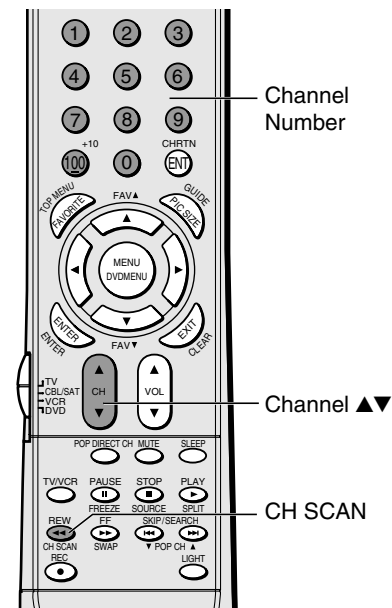

Note:

During the programmed channel search, multi-windows display in 4:3 aspect ratio, regardless of the signal format. The sound is not output.

Using the favorite channel search function

You can use the favorite channel search function to quickly scan your favorite channels (see "Programming your favorite channels" on page 26).

1. Press FAVORITE.
The TV automatically enters multi-window mode, and begins a twelve-picture scan of your favorite channels in the multi-window. (Press FAVORITE again to return to a normal picture.)

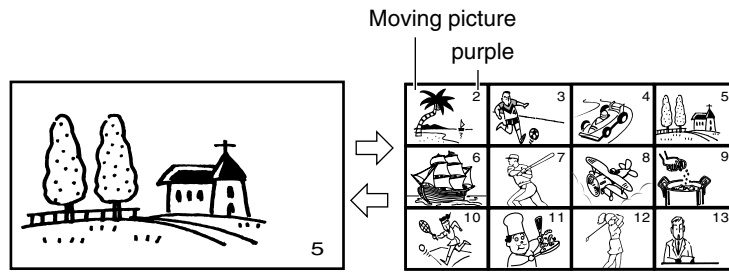

2. Press ▲▼◀▶ to select one of the twelve pictures (becomes a moving picture). The selected channel number is in purple and the monaural sound of the selected channel is output.
3. Press ENTER to display the channel you selected in step 2 as a normal picture.

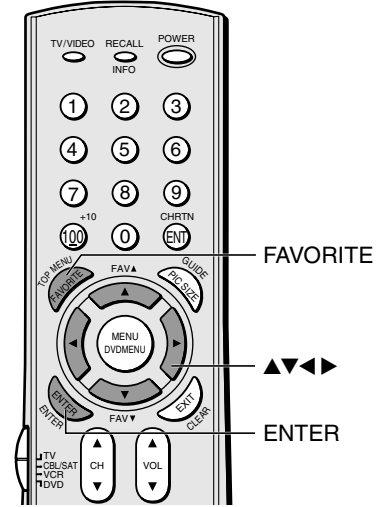
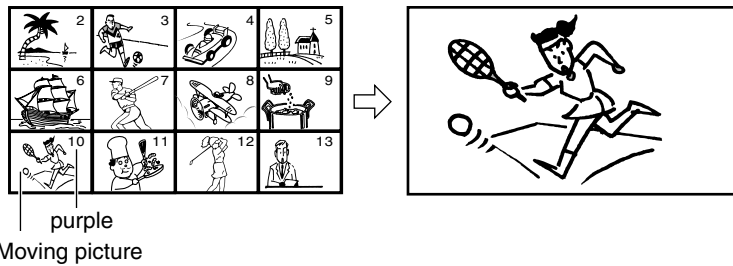

About the auto favorite feature

If your TV is in the program lock mode, after 4 seconds, the TV starts the auto favorite channel search function. See page 40 for details.

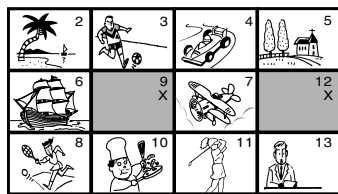

Using the LOCKS menu

The LOCKS menu includes the V-Chip, CH Lock, Video Lock, and New PIN Code functions. You can use these functions after entering the correct PIN code.

Entering the PIN code

1. Press MENU, and then press ◀ or ▶ until the LOCKS menu appears.

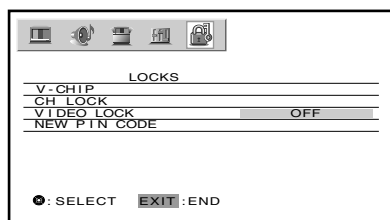

2. Press ▲ or ▼ to display the PIN code entering mode.

- Blocking Reset status: Set a new 4-digit code by pressing the Number buttons (0-9).
- When the PIN code is already stored: Press the Number buttons (0-9) to enter your 4-digit PIN code used for blocking channels.

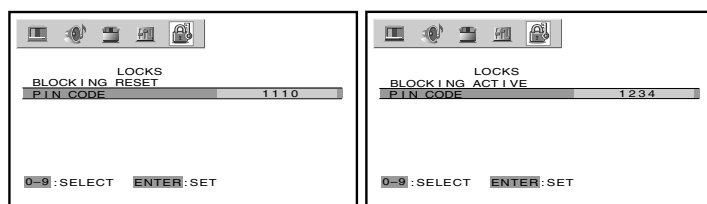

If the wrong PIN code is entered, the message "Incorrect" appears. Enter the code again, and then press ENTER.

If you cannot remember your PIN code

1. While the PIN code entering screen is displayed, press RECALL four times within five seconds. The PIN code will be released (Blocking Reset status restored).
2. Enter a new 4-digit code, and then press ENTER. The LOCKS menu appears.

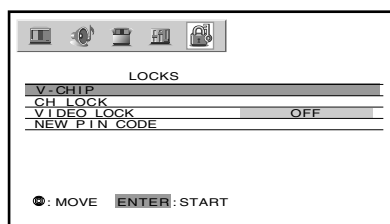

Continue to set each item following the steps on pages 38-41.

Using the V-CHIP menu

Some TV programs and movies include signals that classify the content of the program (violence, sex, dialog, language). The V-CHIP control feature in this TV detects the signals and blocks the programs according to your selections. To use this feature, perform the following setup.

(continued on next page)

Note:

The V-Chip function is available only for the U.S. V-Chip system. The Canadian V-Chip system is not supported.

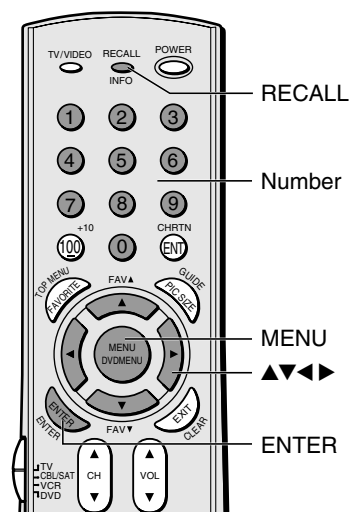

ENABLE BLOCKING

- From the LOCKS menu, press ▼ or ▲ to highlight V-CHIP, and then press ENTER.

The V-CHIP menu appears.

- Press ▼ or ▲ to highlight ENABLE BLOCKING, and then press ENTER.

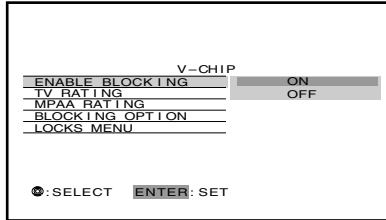

- Press ▲ or ▼ to select ON or OFF.
ON : To enable your setting (Lock)
OFF: To release your setting (Unlock)

Note: The CH LOCK function is not affected by this setting.

TV RATING (Independent rating system for broadcasters)

- From the V-CHIP menu, press ▼ or ▲ to highlight TV RATING, and then press ENTER.

The TV RATING menu appears.

- Press ▼ or ▲ to select an item.
- Press ► to lock (displays "X").
Press ◀ to unlock (displays "✓").
- Repeat steps 2 and 3 to set the next item.

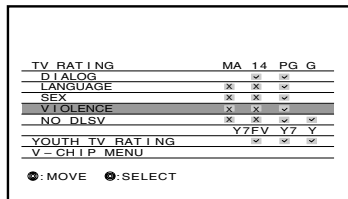

The TV age-based ratings and content themes you can be lock are listed in the table below.

Ratings	Description and Content themes
MA	Mature Audience Only (This program is specifically designed to be viewed by adults and therefore may be unsuitable for children under 17.) L) Crude or indecent language S) Explicit sexual activity V) Graphic violence
14	Parents Strongly Cautioned (This program contains some material that many parents would find unsuitable for children under 14 years of age.) D) Intensely suggestive dialog L) Strong, coarse language S) Intense sexual situations V) Intense violence
PG	Parental Guidance Suggested (This program contains material that parents may find unsuitable for younger children.) D) Some suggestive dialog L) Infrequent coarse language S) Some sexual situations V) Moderate violence
G	General Audience (Most parents would find this program suitable for all ages.)
Y7, Y7FV	Directed to Older Children (This program is designed for children age 7 and above. Note: Programs in which fantasy violence may be more intense or more combative than other programs in this category are designated Y7FV.)
Y	All Children (This program is designed to be appropriate for all children.)

LOCKS menu

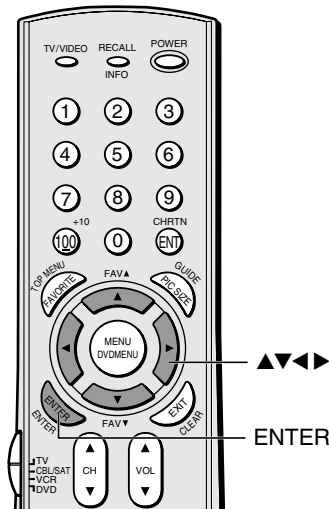
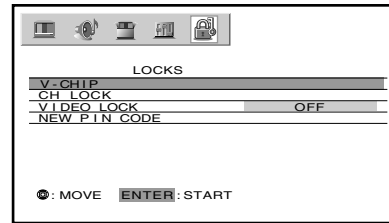

Press RECALL to display the rating of the TV program you are currently watching.

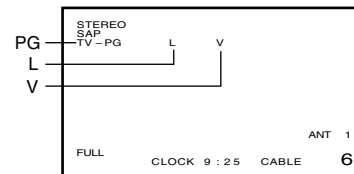

MPAA RATING (Independent rating system for movies)

- From the V-CHIP menu, press ▼ or ▲ to highlight MPAA RATING, and then press ENTER. MPAA RATING menu appears.
- Press ▲ or ▼ to highlight MPAA RATING.
- Press ► to lock ("X") or press ◀ to unlock ("✓").

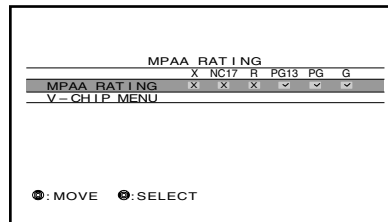

V-CHIP menu

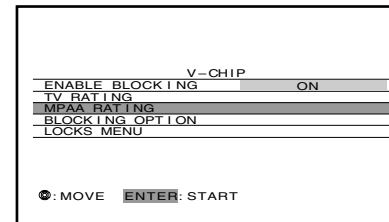

The movie ratings you can lock are described as follows:

- X : X-rated (For adults only)
- NC17: Not intended for anyone 17 and under
- R : Restricted (Under 17 requires accompanying parent or adult guardian.)
- PG13 : Parents Strongly Cautioned (Some material may be inappropriate for children under 13.)
- PG : Parental Guidance Suggested (Some material may not be suitable for children.)
- G : General Audience (Appropriate for all ages)

BLOCKING OPTION

- From the V-CHIP menu, press ▼ or ▲ to highlight BLOCKING OPTION, and then press ENTER. The BLOCKING OPTION menu appears.
- Press ▲ or ▼ to select item.

MPAA UNRATED :

- Highlight MPAA UNRATED, and then press ENTER.
- Press ▲ or ▼ to select ON (Lock) or OFF (Unlock) for unrated programs in the MPAA rating system, and then press ENTER.

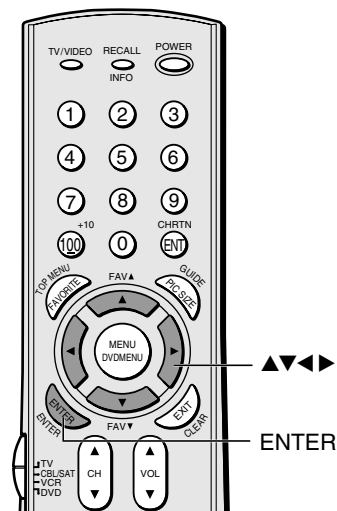
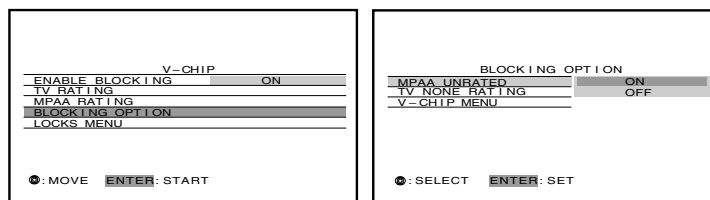

TV NONE RATING :

- Highlight TV NONE RATING, and then press ENTER.
- Press ▲ or ▼ to select ON (Lock) or OFF (Unlock) for programs rated NONE in the TV PARENTAL GUIDELINES, then press ENTER.

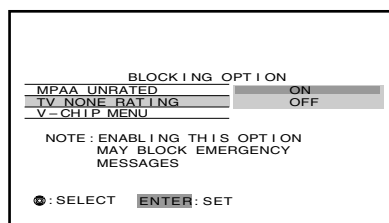

V-CHIP MENU :

Highlight V-CHIP menu, then press ENTER to return to the V-CHIP menu.

Caution

Be aware that setting the TV None Rating to ON may block the broadcast of emergency information. The menu will display the note, "Enabling this option may block emergency messages" to warn you of this possibility.

Unlocking programs temporarily

1. If you try to watch a TV program that exceeds the rating limits you set, the TV enters program lock mode. After 4 seconds, the TV starts the auto favorite channel search function (see page 36). You can either unlock the program temporarily (see steps 2-4) or select a non-locked program to watch.

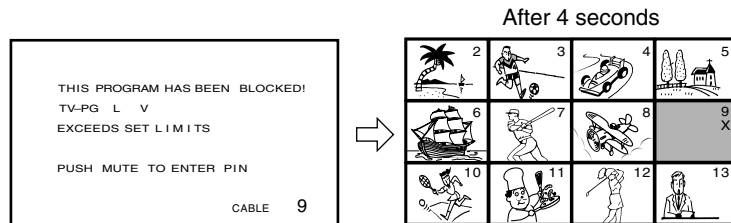

2. To temporarily unlock the program, press MUTE while the message is on the screen.
3. Press the Number buttons (0-9) to enter your 4-digit PIN code.

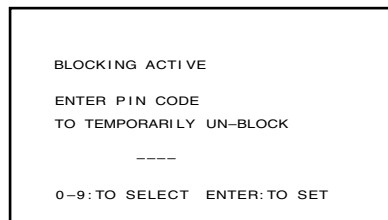

4. Press ENTER. If the correct code is entered, the program lock mode is released and the normal picture appears. All locking is disabled until the TV is turned off, and will be enabled when the TV is turned on again.

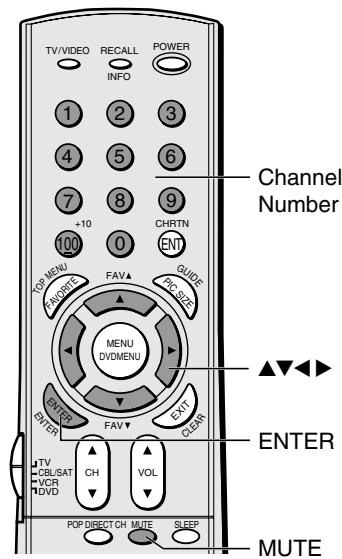

Locking channels

With the CH LOCK feature, you can lock specific channels. The TV will not be able to tune locked channels with the Channel ▲▼ buttons or Channel Number buttons, unless you clear the setting. You can lock a maximum of nine channels.

To lock channels:

1. From the LOCKS menu, press ▲ or ▼ to highlight CH LOCK, and then press ENTER. CH LOCK menu appears, and CH INPUT will be highlighted.
2. Press the Channel Number buttons to enter the channel you want to lock.
3. Press ENTER.

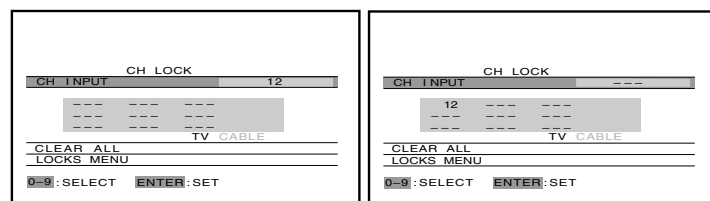

4. Repeat steps 2 and 3 for other channels.

LOCKS menu

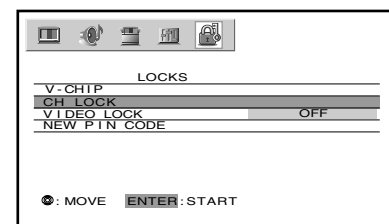

To unlock individual channels:

1. From the LOCKS menu, press ▲ or ▼ to highlight CH LOCK, then press ENTER.
CH LOCK menu appears.
2. Press ▲▼◀▶ to highlight the channel you want to unlock, and then press ENTER.

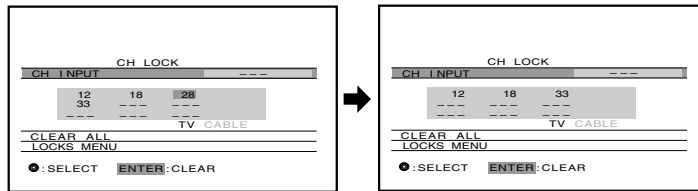

3. Repeat step 2 for other channels.

To unlock all locked channels at once:

Press ▲ or ▼ to highlight CLEAR ALL, and then press ENTER.

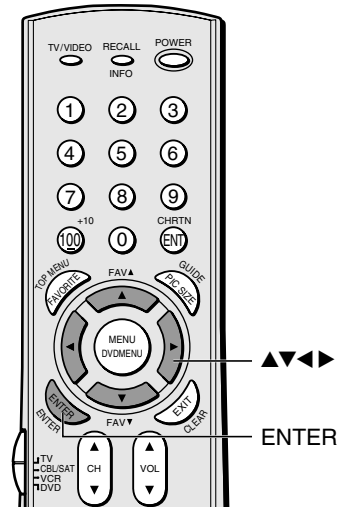
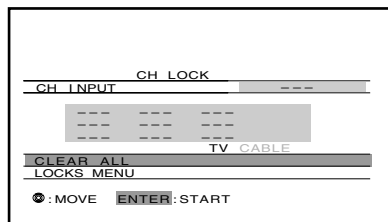

Locking the video inputs

With the VIDEO LOCK feature, you can lock out the input sources (Video 1, Video 2, Video 3, ColorStream HD1, ColorStream HD2, HDMI) and channels 3 and 4.

You will not be able to select the input sources with the TV/VIDEO button or Channel buttons unless you clear the setting.

To set up the video lock:

1. From the LOCKS menu, press ▲ or ▼ to highlight VIDEO LOCK, then press ENTER.
2. Press ▲ or ▼ to highlight the level of video locking you want (Video, Video+, or Off), as follows:
 VIDEO : Locks Video 1, Video 2, Video 3, ColorStream HD1, HD2 and HDMI.
 VIDEO+ : Locks Video 1, Video 2, Video 3, ColorStream, HD1/HD2, HDMI and channels 3 and 4. This option should be used if you use the antenna terminal to play a video tape.

Note: Make sure the POP is not on channel 3 or 4.

OFF : Unlocks all video input sources.

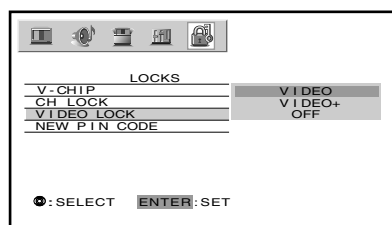

3. Press ENTER.

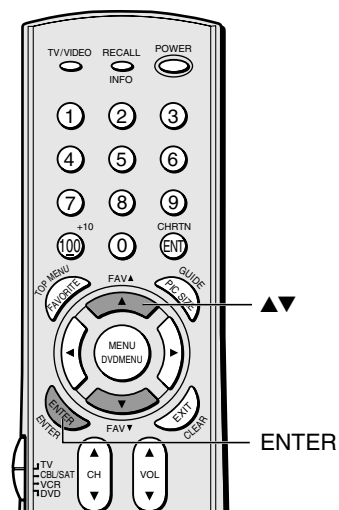

Changing the PIN code

1. From the LOCKS menu, press ▲ or ▼ to highlight NEW PIN CODE.
2. Press the Number buttons (0-9) to enter a 4-digit code. The numbers you enter will replace the dashes in the display.

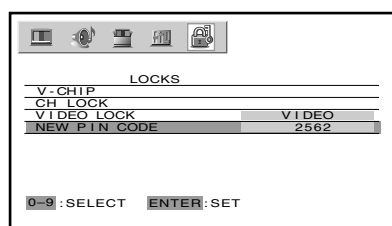

3. Press ENTER. The new PIN code is now active.

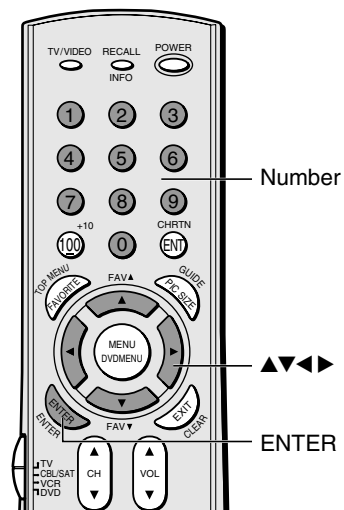

Adjusting the picture

Selecting the picture mode

You can select your desired picture type from four picture modes: Sports, Standard, Movie, and Preference.

Mode	Picture Quality
Sports	Bright and dynamic picture (factory setting)
Standard	Standard picture setting (factory setting)
Movie	Movie-like picture setting (factory setting)
Preference	Your personal preference*

*(see "Saving new preference" on page 44.)

To select the picture mode:

1. Press MENU, and then press ◀ or ▶ until the PICTURE menu appears.
2. Press ▼ or ▲ to highlight MODE, and then press ENTER.
3. Press ▼ or ▲ to select the mode you prefer, then press ENTER.

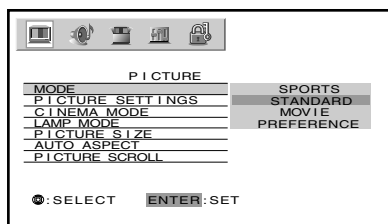

Adjusting the picture quality

You can adjust the picture quality to your personal preferences, including the contrast, brightness, color, tint, sharpness, and color temperature.

Selection	Pressing	
	◀	▶
contrast	lower	higher
brightness	darker	lighter
color	paler	deeper
tint	reddish	greenish
sharpness	softer	sharper
color temperature	cool	medium warm

To adjust the picture quality:

1. Press MENU, and then press ◀ or ▶ until the PICTURE menu appears.
2. Press ▼ or ▲ to highlight PICTURE SETTINGS, then press ENTER. PICTURE SETTINGS menu appears.
3. Press ▲ or ▼ until the item you want to adjust is highlighted, then press ENTER.
4. Press ◀ or ▶ to adjust the level.

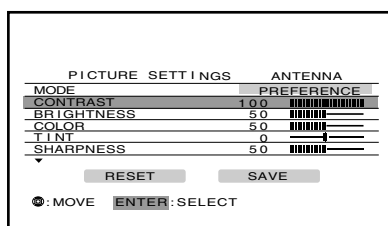

The PICTURE qualities you adjusted can be saved in the TV's memory (see page 44). You can keep these settings or choose factory set options, as described under "Selecting the picture mode" above.

Note:

If you select one of the factory-set picture modes (SPORTS, STANDARDS, or MOVIE) and then change a picture quality setting (for example, increase the contrast), the picture mode automatically changes to PREFERENCE in the Picture menu.

To save your new picture quality settings, you must select SAVE (see page 44) before closing the Picture menu or the TV will return to the previous picture mode.

Control touchpad on TV front

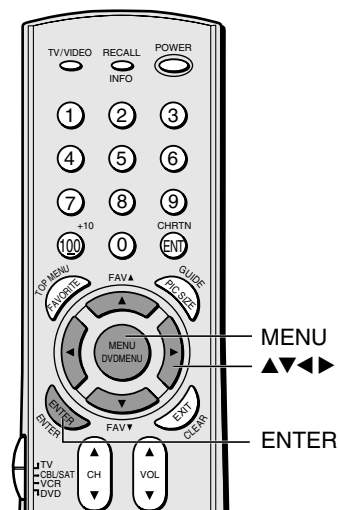
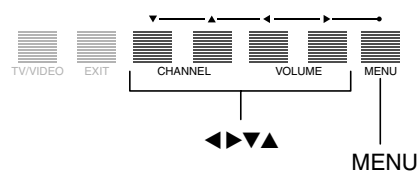

Saving new preference

You can save the PICTURE qualities (contrast, brightness, color, tint, sharpness, color temperature and CableClear DNR) you adjusted in the picture preference mode.

To save your new preferences:

1. Press MENU, and then press ◀ or ▶ until the PICTURE menu appears.
2. Press ▲ or ▼ to highlight PICTURE SETTINGS, and then press ENTER.
PICTURE SETTINGS menu appears.
3. Press ▲▼◀▶ to highlight SAVE, and then press ENTER.
When complete, SAVE changes to "DONE".

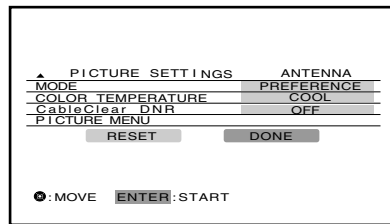

The picture mode automatically changes to PREFERENCE (see "Selecting the picture mode" on page 43).

Selecting the color temperature

You can change the quality of the picture by selecting from three preset color temperatures: cool, medium, and warm.

To select the color temperature:

1. Press MENU, and then press ◀ or ▶ until the PICTURE menu appears.
2. Press ▲ or ▼ to highlight PICTURE SETTINGS, and then press ENTER.
PICTURE SETTINGS menu appears.
3. Press ▲ or ▼ to highlight COLOR TEMPERATURE, and then press ENTER.

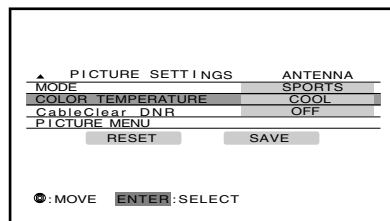

4. Press ◀ or ▶ to select the mode you prefer.

Mode	Picture Quality
cool	bluish
medium	neutral
warm	reddish

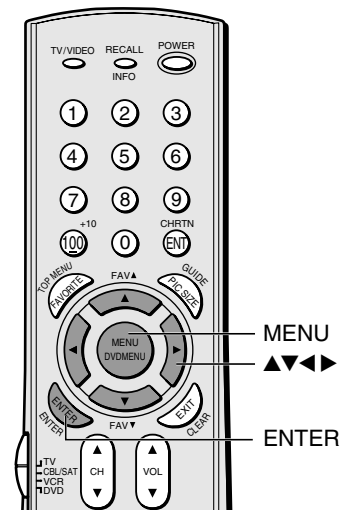

Using the CableClear™ DNR feature

CableClear™ DNR reduces visible interference in your TV picture. This is useful when receiving a broadcast with a weak signal (especially a Cable channel) or playing a video cassette or disc damaged by repeated use.

To turn on CableClear™ DNR:

1. Press MENU, and then press ◀ or ▶ until the PICTURE menu appears.
2. Press ▲ or ▼ to highlight PICTURE SETTINGS, and then press ENTER.
PICTURE SETTINGS menu appears.
3. Press ▲ or ▼ to highlight CableClear DNR, and then press ENTER.

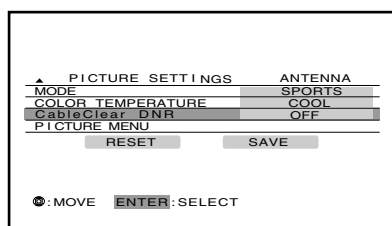

4. Press ◀ or ▶ to select AUTO.

To turn off CableClear DNR:

Select OFF in step 4 above.

Resetting picture adjustments

The RESET function adjusts the picture qualities to the following factory settings:

Mode	sports	Tint	center (0)
Contrast	max (100)	Sharpness	center (50)
Brightness	center (50)	Color temperature	cool
Color	center (50)	CableClear DNR	auto

To reset the picture adjustments:

1. Press MENU, and then press ◀ or ▶ until the PICTURE menu appears.
2. Press ▲ or ▼ to highlight PICTURE SETTINGS, and then press ENTER. PICTURE SETTINGS menu appears.
3. Press ▲ or ▼ to highlight RESET.
4. Press ENTER until the RESET changes to "DONE".

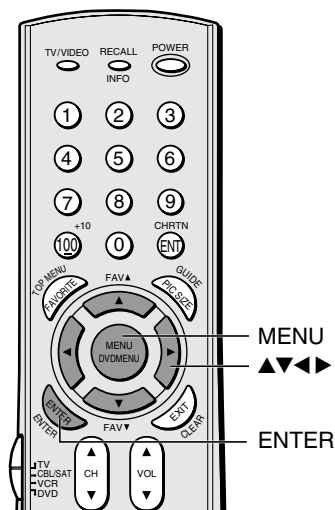
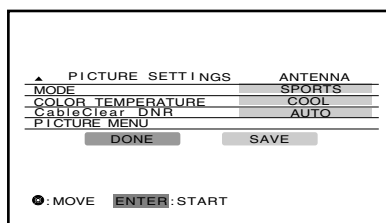

Note:

When in ColorStream or HDMI mode, "CableClear DNR" display will change to "DNR". DNR is not selectable in the HDMI mode.

Selecting the Lamp mode

You can select either the Hi bright or Low power mode. The Hi bright mode is useful for situations where additional picture brightness is desired (such as in a room with bright lighting). The Low power mode reduces wear on the projection lamp and using it should result in longer lamp life. See "Lamp unit replacement" on page 56.

1. Press MENU, and then press ◀ or ▶ until the PICTURE menu appears.
2. Press ▲ or ▼ to highlight LAMP MODE, and then press ENTER.
3. Press ▲ or ▼ to select HI BRIGHT or LOW POWER as you desire.

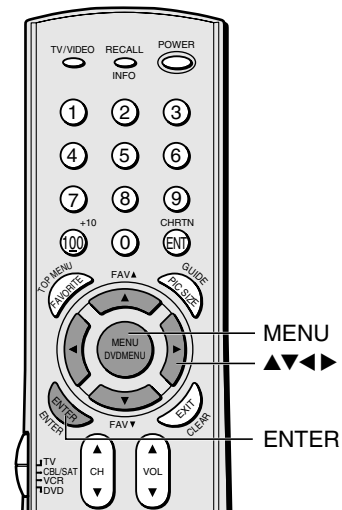
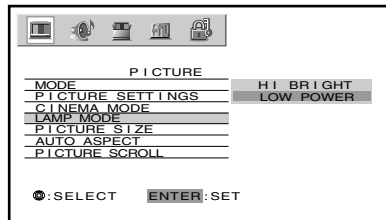

Selecting the cinema mode

When you view a DVD movie (3:2 pulldown processed) from a DVD player connected to the ColorStream (component video) inputs on the TV, smoother and more natural motion can be obtained by setting the CINEMA MODE to FILM (auto).

To set the CINEMA MODE to FILM (auto):

1. Press MENU, and then press ◀ or ▶ until the PICTURE menu appears.
2. Press ▲ or ▼ to highlight CINEMA MODE, and then press ENTER.
3. Press ▲ or ▼ to select FILM (auto).

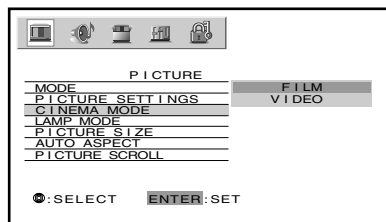

To set the CINEMA MODE to VIDEO (off):

Press ▲ or ▼ to select VIDEO in step 3 above.

Selecting the video input source

Press the TV/VIDEO on the remote control or the TV to view a signal from another device connected to your TV, such as a VCR or DVD player (see illustrations below). You can select ANT 1, VIDEO 1, VIDEO 2, VIDEO 3, ColorStream HD1, ColorStream HD2, HDMI, or ANT 2 depending on which input jacks are used for connecting the devices (see "Connecting your TV" on page 8).

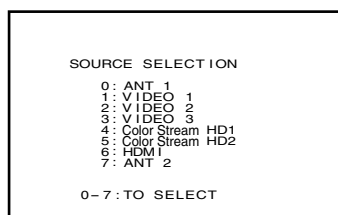

Pressing TV/VIDEO on the remote control displays the current signal source (press TV/VIDEO again or 0-7 to change)

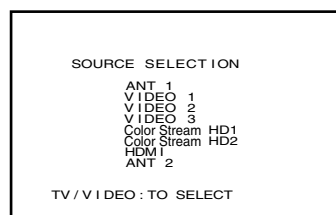

Pressing TV/VIDEO on the TV changes the current signal source

Labeling the video input sources

The video label feature allows you to label each input source for your TV from the following preset list of labels:

- : Uses the default label name
- VCR : Video cassette recorder
- DVD : DVD video
- DTV : Digital TV set-top box
- SAT : Satellite box
- CBL : Cable box

To label the video input sources:

1. Press MENU, and then press ◀ or ▶ until the CUSTOM menu appears.
2. Press ▲ or ▼ to highlight VIDEO LABEL.

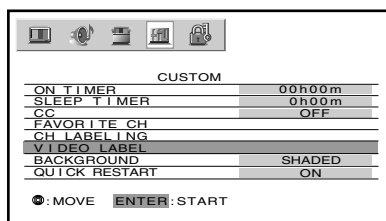

3. Press ENTER to display the VIDEO LABEL menu.
4. Press ▲ or ▼ to highlight the video source you want to label and then press ENTER.
5. Press ▲ or ▼ to select the desired label for that input source.

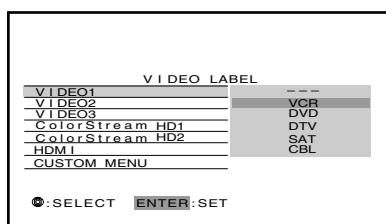

6. Finish labeling the other video sources as desired. To return to the previous menu, press ▲ or ▼ to highlight CUSTOM MENU, and then press ENTER.
7. To exit the menu, press EXIT.

Note:

- When ColorStream HD 1 or HD 2 is selected, the video OUT jack does not output a signal. To receive a video OUT signal, use a video or S-video IN connection instead of the ColorStream connection.
- If you select ColorStream HD1 or ColorStream HD2 while the POP picture is active, the image signals other than 480i format are muted.

Please note the following regarding the HDMI source selection:

This TV is not intended for connection to and should not be used with a PC (personal computer). See "Connecting an HDMI or DVI device to the HDMI input" on page 15 for details.

Control touchpad on TV front

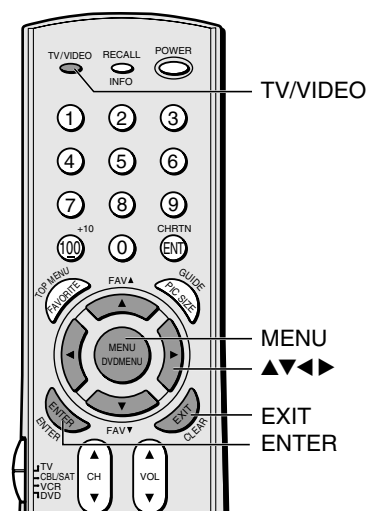
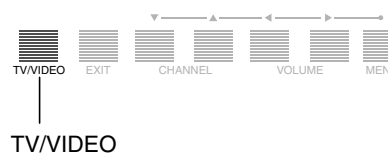

Using the closed caption feature

The closed caption feature has two options:

- Captions—An on-screen display of the dialogue, narration, and sound effects of TV programs and videos that are closed captioned (usually marked as “CC” in TV listings).
- Text—An on-screen display of information not related to the current program, such as weather or stock data (when provided by individual stations).

To view captions or text:

1. Tune the TV to the desired program.
2. Press MENU, and then press ◀ or ▶ to display CUSTOM menu.
3. Press ▲ or ▼ to highlight CC, and then press ENTER.

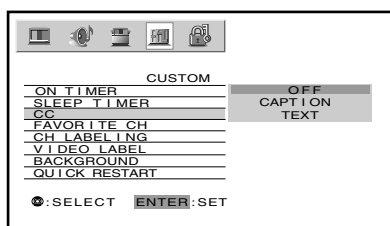

4. Press ▲ or ▼ to highlight CAPTION or TEXT, and then press ENTER.

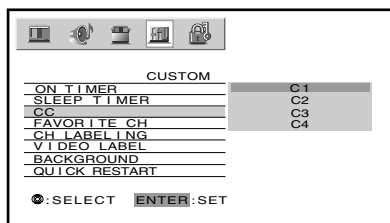

- To view captions, highlight C1, C2, C3, or C4 (C1 displays translation of the primary language in your area).

Note: If the program or video you selected is not closed captioned, no captions will display on the screen.



- To view text, highlight T1, T2, T3, or T4.

Note: If text is not available in your area, a black rectangle may appear on your screen. If this happens, turn the Closed Caption feature OFF.

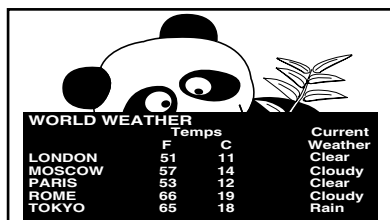

To turn off the Closed Caption feature:
Highlight OFF in step 4.

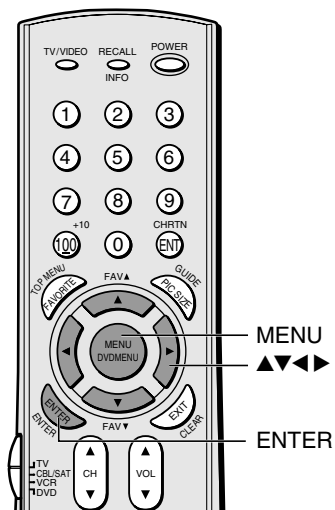

Note:

A closed caption signal may not display in the following situations:

- when a videotape has been dubbed
- when the signal reception is weak
- when the signal reception is nonstandard

Setting the ON timer

To set the ON timer to turn the TV on automatically:

1. Press MENU, and then press ◀ or ▶ until the CUSTOM menu appears.
2. Press ▲ or ▼ to highlight ON TIMER, and then press ENTER.
3. Press the Number buttons (0-9) to enter the length of time until the TV turns on automatically.
You can set the ON timer in 10 minute increments, up to 12h00m.
4. Press ENTER.

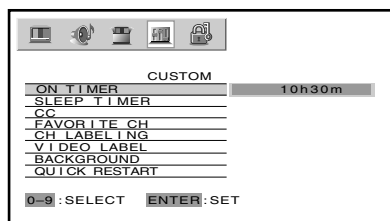

5. Press POWER to turn off the TV. (ON timer will start.)
The TV will turn on automatically after the length of time you set in the ON Timer.

Setting the sleep timer

To set the sleep timer to turn the TV off automatically:

1. Press SLEEP to set the length of time until the TV turns off.

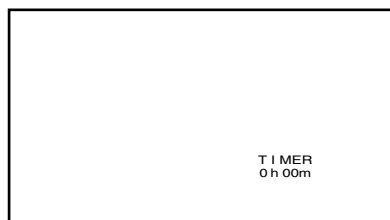

Every time you press the button, the time display will increase by 10 minutes, up to 3 hours.

0h00m → 0h10m → 0h20m → ... → 2h50m → 3h00m → 0h00m

To cancel the sleep timer:

Press SLEEP until it is set to 0h00m.

The timer can also be set using the on-screen menu:

1. Press MENU, and then press ◀ or ▶ until the CUSTOM menu appears.
2. Press ▲ or ▼ to highlight SLEEP TIMER, and then press ENTER.
3. Press the Number buttons (0-9) to enter the length of time until the TV turns off automatically.
4. Press ENTER to start the timer.

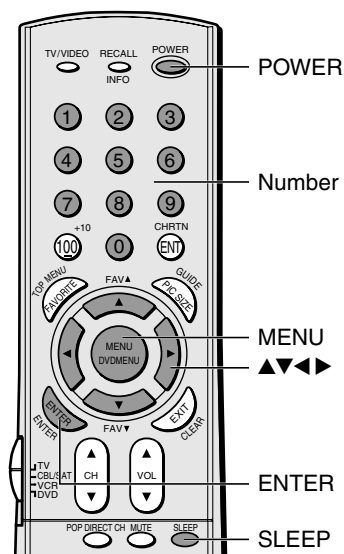
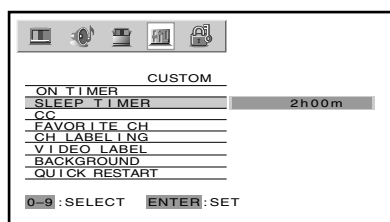

Note :

- When an instant power failure occurs, the ON timer and sleep timer settings may be cleared.
- To display the amount of time left until the TV turns on or off automatically, press RECALL.

Setting the clock

To set the clock:

1. Press MENU, and then press ◀ or ▶ until the SET UP menu appears.
2. Press ▲ or ▼ to highlight CLOCK SET, and then press ENTER.
3. Press the Number buttons (0-9) to enter the correct time. The clock operates on a 24-hour cycle.
4. Press ENTER to start the clock.

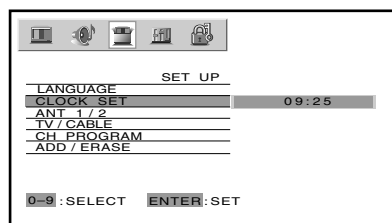

To display the time on-screen:
Press RECALL.

Note :

If the TV's power source is interrupted (the power cord is unplugged or a power failure occurs), the clock must be reset.

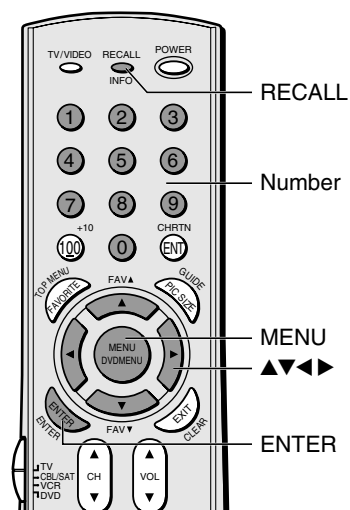

Adjusting the sound

Muting the sound

Press MUTE to temporarily reduce (1/2 MUTE) or turn off (MUTE) the sound. While the sound is off, the screen will display “1/2 MUTE” or “MUTE” in the lower right corner. Every time you press the button, the mute mode will change in the following order.

→ Normal → 1/2 MUTE → MUTE →

When you select “MUTE” mode, the closed caption feature is automatically activated. To deactivate this feature, deactivate MUTE. This feature works only when the closed caption mode is set to OFF. See “Using the closed caption feature” on page 48 for more information.

Selecting stereo/SAP broadcasts

The multi-channel TV sound (MTS) feature allows you to listen to high-fidelity stereo sound while watching TV. MTS can also transmit a second audio program (SAP) containing a second language, music, or other audio information (when provided by individual stations).

When the TV receives a stereo or SAP broadcast, the word STEREO or SAP appears on-screen every time the TV is turned on, the channel is changed, or the RECALL button is pressed.

The MTS feature is not available when the TV is in VIDEO mode.

To listen to stereo sound:

1. Press MENU, and then press ◀ or ▶ until the AUDIO menu appears.
2. Press ▲ or ▼ to highlight MTS, and then press ENTER.
3. Press ▲ or ▼ to highlight STEREO, and then press ENTER.

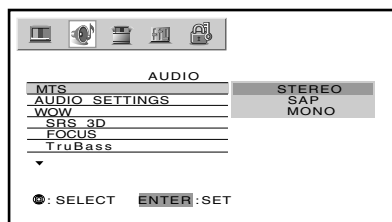

You can leave your TV in STEREO mode because it will automatically output the type of sound being broadcast (stereo or monaural). The word “STEREO” or “SAP” displays in yellow in the menu when the TV receives the signal.

If the stereo sound is noisy, select MONO to reduce the noise.

To listen to SAP (if available):

1. Press MENU, and then press ◀ or ▶ until the AUDIO menu appears.
2. Press ▲ or ▼ to highlight MTS, and then press ENTER.
3. Press ▲ or ▼ to highlight SAP, and then press ENTER. You will hear the station's second audio program (if available) from the speakers, while viewing the original program's picture (see note at right).

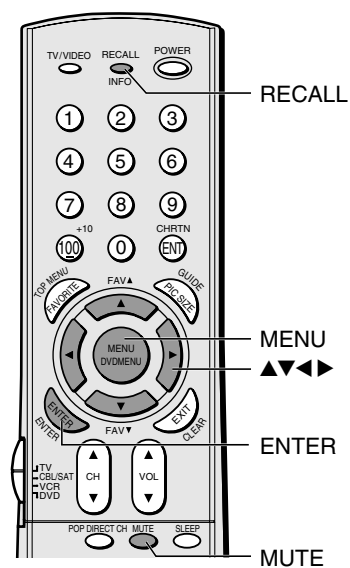

Control touchpad on TV front

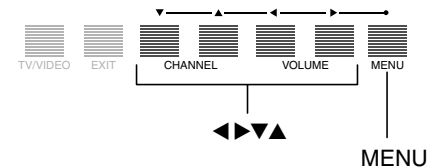

Note :

A second audio program (SAP) can be heard only on those TV stations that offer it.

For example, a station might broadcast music as a second audio program. If you have SAP on, you will see the current program on the screen but hear music instead of the program's normal audio.

However, if you have SAP on, and the station you are watching is not currently broadcasting a second audio program, the station's normal audio will be output; however, occasionally there is no sound at all in SAP mode. If this happens, set the MTS feature to STEREO mode.

Using the WOW™ surround sound feature

WOW is a special combination of SRS Labs audio technologies that creates a thrilling surround sound experience with deep, rich bass from stereo sound sources. Your TV's audio will sound fuller, richer, and wider. WOW consists of three features; SRS3D, FOCUS, and TruBass, being turned on.

To adjust the WOW feature:

1. Select STEREO mode (see “selecting stereo/SAP broadcasts” on page 51).
2. Press MENU, and then press ◀ or ▶ until the AUDIO menu appears.
3. Press ▲ or ▼ to highlight the desired WOW feature you want to adjust, then press ENTER.
 - SRS 3D — To turn on or off the surround sound effect.
 - FOCUS — To turn on or off the vocal emphasis effect.
 - TruBass — To select your desired bass expansion level (HIGH, LOW or OFF).

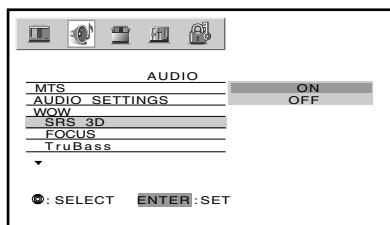

4. Press ▲ or ▼ to adjust the item, then press ENTER.

Adjusting the sound quality

You can change the quality of your TV's sound by adjusting the bass, treble, and balance.

To adjust the sound quality:

1. Press MENU, and then press ◀ or ▶ until the AUDIO menu appears.
2. Press ▲ or ▼ to highlight AUDIO SETTINGS, and then press ENTER.

AUDIO SETTINGS menu appears.

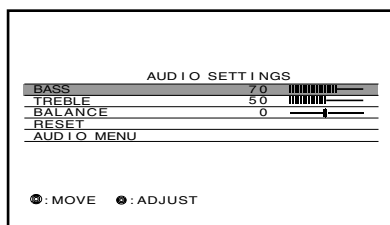

3. Press ▲ or ▼ to highlight the item you want to adjust.
4. Press ◀ or ▶ to adjust the level.
 - ◀ makes the sound quality weaker or decreases the balance in the right channel, depending on the item selected.
 - ▶ makes the sound quality stronger or decreases the balance in the left channel, depending on the item selected.

Note:

If the broadcast is monaural, the WOW SRS 3D surround sound effect will not work.

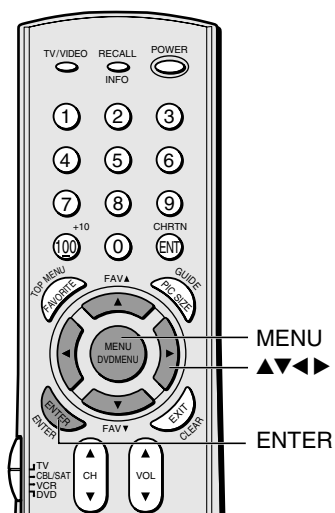

Resetting your audio adjustments

The RESET function returns the audio adjustments to the following factory settings:

- Bass center (50)
- Treble center (50)
- Balance center (0)

To reset the audio adjustments:

1. Press MENU, and then press ◀ or ▶ until the AUDIO menu appears.
2. Press ▲ or ▼ to highlight AUDIO SETTINGS, and then press ENTER. AUDIO SETTINGS menu appears.
3. Press ▲ or ▼ to highlight RESET, and then press ENTER.

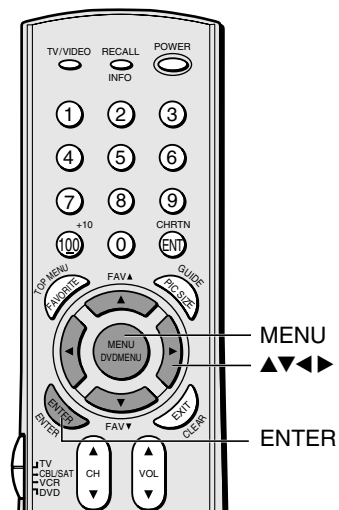
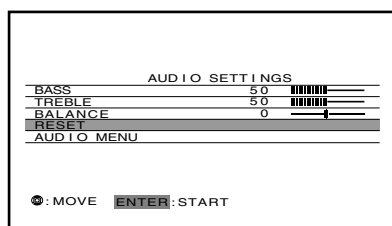

Using the StableSound® feature

When the signal source is changed, the StableSound feature limits the highest volume level to prevent extreme changes in volume (for example, to prevent the sudden increase in volume that often happens when a TV program switches to a commercial).

To turn on the StableSound feature:

1. Press MENU, and then press ◀ or ▶ until the AUDIO menu appears.
2. Press ▲ or ▼ to highlight STABLE SOUND, and then press ENTER.
3. Press ▲ or ▼ to select ON, and then press ENTER.

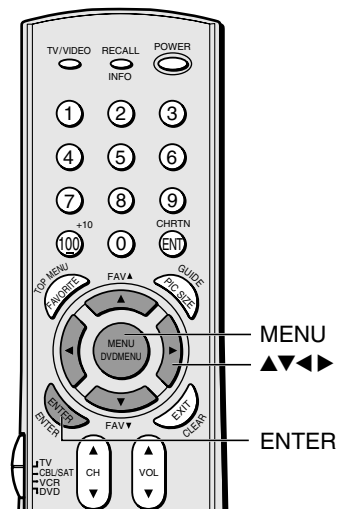
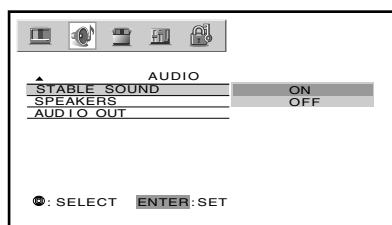

To turn off the StableSound feature:

Select OFF in step 3 above.

Turning off the built-in speakers

Use this feature to turn the TV speakers off when you connect an audio system (see “Connecting an audio system” on page 16).

To turn off the built-in speakers:

1. Press MENU, then press ◀ or ▶ until AUDIO menu appears.
2. Press ▲ or ▼ to highlight SPEAKERS, and then press ENTER.
3. Press ▲ or ▼ to select OFF, and then press ENTER.

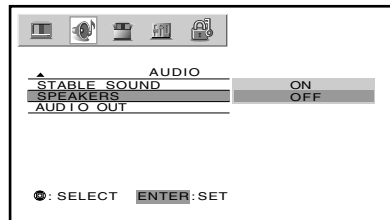

To turn on the built-in speakers:

Select ON in step 3 above.

Selecting the Audio OUT sound

This feature allows you to select the sound source (MAIN or POP) that is output from the Audio OUT terminals (for example, see “Connecting two VCRs” on page 14).

This is useful when amplifying or recording the POP sound with external equipment while listening to the sound of the main picture through the built-in speakers.

To select the Audio OUT sound:

1. Press MENU, and then press ◀ or ▶ until the AUDIO menu appears.
2. Press ▲ or ▼ to highlight AUDIO OUT, and then press ENTER.
3. Press ▲ or ▼ to select MAIN or POP, and then press ENTER.

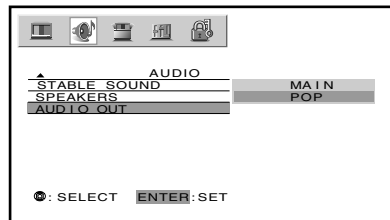

- MAIN: Outputs the sound of the main (left window) program.
- POP : Outputs the sound of the POP (right window) program.

Note:

Make sure the volume control of your audio amplifier is set to a moderate listening level.

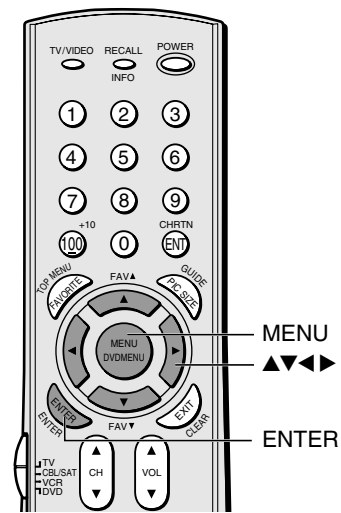

Note:

When the POP window is closed, the sound of the main program is output through the AUDIO OUT terminals, even if POP is selected in the AUDIO OUT menu.

Selecting the background of the menu display

You can change the background of the menu display by selecting from two preset types: shaded and solid (gray).

To select the background:

1. Press MENU, and then press ◀ or ▶ until the CUSTOM menu appears.
2. Press ▲ or ▼ to highlight BACKGROUND, and then press ENTER.
3. Press ▲ or ▼ to select either a SHADED or SOLID background, and then press ENTER.

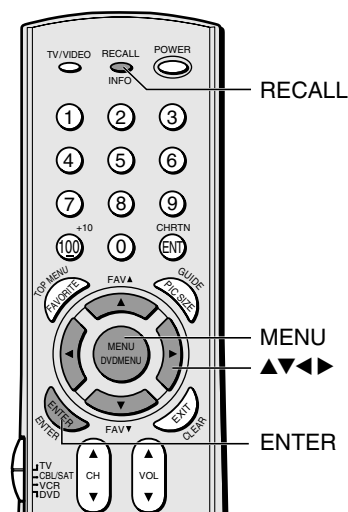
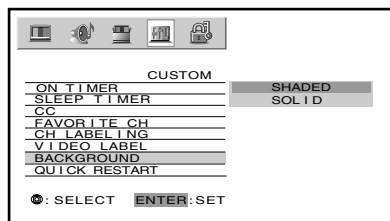

Displaying on-screen information

Press RECALL to display the following information on-screen:

- Antenna mode (when in TV mode)
- Channel number or VIDEO mode selected
- Time (if set)
- Remaining time of ON/SLEEP timer (if set)
- Channel label (if set)
- Video label (when in video mode)
- Stereo or SAP audio status
- V-CHIP rating status
- Picture size
- Lamp mode selected (when in the Hi Bright mode)

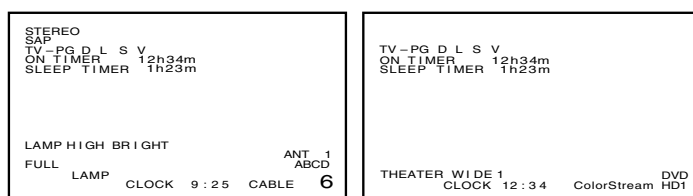

Understanding the auto power off feature

The TV will automatically turn itself off after approximately 15 minutes if it is tuned to a vacant channel or a station that completes its broadcast for the day. This feature does not work in VIDEO mode.

Understanding the last mode memory feature

If the power is cut off while you are viewing the TV, the Last Mode Memory feature turns the TV on automatically when the power is resupplied.

If the power is going to be off for a long time and you are going to be away from your TV, unplug the power cord to prevent the TV from turning on in your absence.

Appendix

Lamp unit replacement (User-replaceable component)

The light source for this TV is a mercury lamp with internal atmospheric pressure that increases during use. The lamp has a limited service life that varies depending on product use and user settings. As is generally the case with all projection TV's that use projection lamps as a light source, the brightness of the lamp in this TV may vary somewhat over the expected service life and will generally decrease over time. The average useful service life for the lamp is approximately [8,000] hours in "LOW POWER" mode or [6,000] hours in "HI BRIGHT" mode. See "Selecting the Lamp mode" on page 46 for information on switching the lamp mode. Because these are averages, some lamps will require earlier replacement.

If you use the lamp beyond its service life:

- you may notice a reduction in the colors and/or brightness of the picture; and
- the strength of the quartz glass in the lamp will be reduced and the lamp may rupture (often making a loud noise when this happens). If the lamp ruptures, the TV will not operate until the lamp unit is replaced.

Note: The lamp unit is designed so broken lamp glass remains securely inside the lamp unit.

 **CAUTION: Always handle the lamp unit with care.** The lamp unit in this TV was designed for safe replacement by consumers; however, if the lamp unit is subjected to intentional abuse (such as excessive mechanical abuse or handling by children or pets), the unit may break, exposing sharp edges or pinch points.

When to replace the lamp unit

You should replace the lamp unit:

- if the picture darkens and/or colors fade;
- if the screen (lamp) does not light (LED Indication 3); or
- if you hear a loud noise and the picture goes black, which may indicate a lamp rupture (LED Indication 3). See "LED indications" on page 60.

To obtain a replacement lamp unit:



- In the U.S.,

	Web	Contact to
In-warranty	www.tacp.toshiba.com/service	toll-free 1-800-631-3811
Out-warranty	www.ceaccessories.toshiba.com	Consult your consumer electronics dealer for availability.

- In Canada, contact a Toshiba parts distributor by directing your web browser to www.toshiba.ca; click "Home Entertainment," and then click "Support."

Use the replacement lamp unit model listed below only. Using any other lamp may cause damage to the set, to the lamp, or both.

 **CAUTION: Always replace with same type lamp unit – Model No. TB25-LMP (Stock no. 23311083)**

 **WARNING: RISK OF ELECTRIC SHOCK!** 
TO REDUCE THE RISK OF ELECTRIC SHOCK, **NEVER REMOVE TV COVERS, EXCEPT AS SPECIFIED HEREIN.** REFER ALL SERVICING NOT SPECIFIED IN THIS MANUAL TO QUALIFIED SERVICE PERSONNEL. Failure to follow this WARNING may result in death or serious injury.

Note :

The lamp is warranted only for the periods and to the extent set forth in the Limited Warranty applicable to this set, which is a substantially shorter period of time than the average useful service period. See "Limited United States Warranty" on page 63 or "Limited Canada Warranty" on page 64 as applicable.



How to replace the lamp unit

Required tool: Manual Phillips screwdriver, gloves.
Optional tool: 5/32" or 4mm Allen wrench.

1. Turn off the TV and unplug the power cord.

 **WARNING:** Eye damage may result from directly viewing the light produced by this lamp. Always turn off the TV and unplug the power cord before opening the lamp unit door.

2. **STOP!** Allow the lamp to cool for at least one (1) hour before replacing it.

 **CAUTION: HOT SURFACE**  The temperature of the lamp immediately after use exceeds 392°F (200°C). Touching the lamp before it has cooled will result in severe burns. **ALLOW THE LAMP TO COOL FOR AT LEAST ONE (1) HOUR BEFORE REPLACING IT.**

3. On the lamp unit door on the side of the TV, loosen the thumb screw by hand or by using a 5/32" or 4mm Allen wrench, and then remove the lamp unit door.

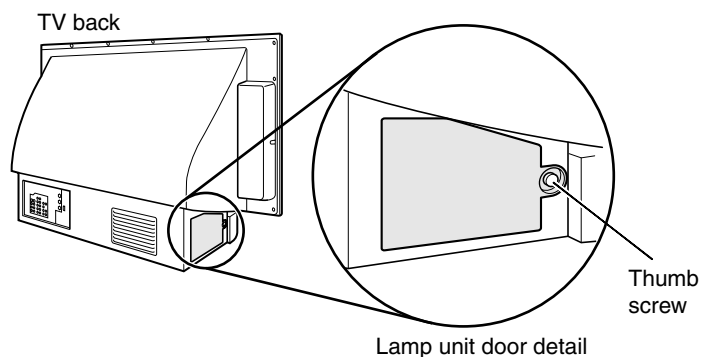

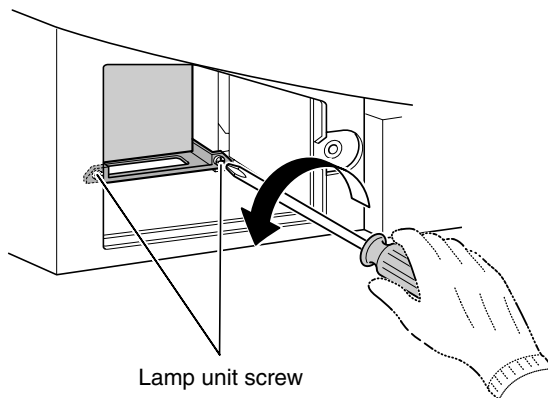

 **WARNING:** The lamp unit door is provided with an interlock to reduce the risk of electric shock and excessive ultraviolet radiation. **Never defeat its purpose or attempt to service without removing the lamp unit door completely.** Failure to follow this WARNING may result in death or serious injury.

4. Using a manual Phillips screwdriver, loosen two screws on the lamp unit.



(Continued on next page)

 **WARNING: RISK OF ELECTRIC SHOCK!** 
TO REDUCE THE RISK OF ELECTRIC SHOCK, **NEVER REMOVE TV COVERS, EXCEPT AS SPECIFIED HEREIN.** REFER ALL SERVICING NOT SPECIFIED IN THIS MANUAL TO QUALIFIED SERVICE PERSONNEL. Failure to follow this WARNING may result in death or serious injury.

Introduction

Connecting your TV

Using the Remote Control

Setting up your TV

Using the TV's Features

Appendix

Index

How to replace the lamp unit (continued)

5. Grasp the lamp unit handle and gently pull the lamp unit straight out of the TV. Set the old lamp unit aside (see "Lamp unit disposal" on page 60).

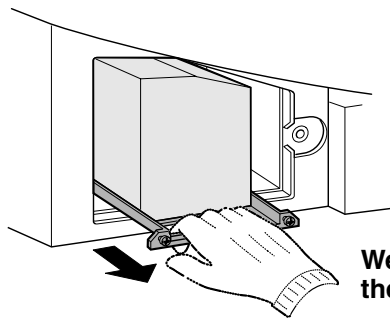

Wear gloves when replacing the lamp unit.

6. Carefully insert the new lamp unit straight into the TV until it is fully seated.

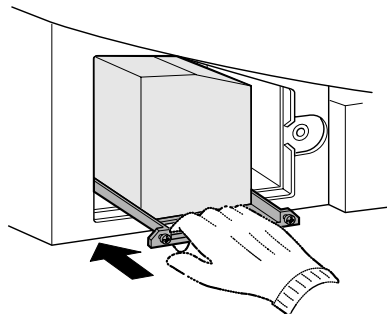

Note :

- Never subject the lamp unit to excessive shock.
- Never touch the lamp unit glass or otherwise get it dirty. Doing so may affect the image quality and reduce the service life of the lamp. See "Cleaning the lamp unit glass" at right.

7. Using a manual Phillips screwdriver, tighten two lamp unit screws.

Note: Hand-tighten only. Do not use an electric screwdriver.

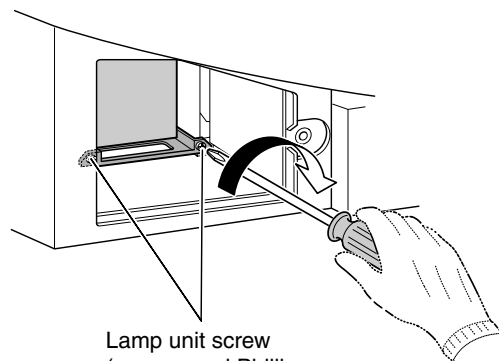

Lamp unit screw
(use manual Phillips
screwdriver only)



NOTE : Make sure the lamp unit and screw are installed securely; otherwise, the TV may not turn on and the lamp life may be shortened.

Cleaning the lamp unit glass

If you accidentally touch the lamp unit glass or otherwise get it dirty, wipe it with a lint-free lens cleaning cloth (such as a cloth for cleaning camera lenses or eyeglasses).



CAUTION: NEVER clean a hot lamp with any type of flammable liquid or aerosol cleaning agent. Many ordinary cleaning agents (such as glass cleaners) contain chemicals that may be flammable at certain temperatures. If the lamp unit is not allowed to cool for at least one (1) hour, such chemicals may ignite.

How to replace the lamp unit (continued)

8. Reattach the lamp unit door, making sure to insert the hooks on the left side of the lamp unit door inside the opening in the TV cabinet.

Insert the hooks inside the TV cabinet opening.

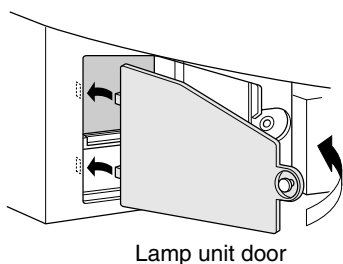

9. Replace the thumb screw and hand-tighten.

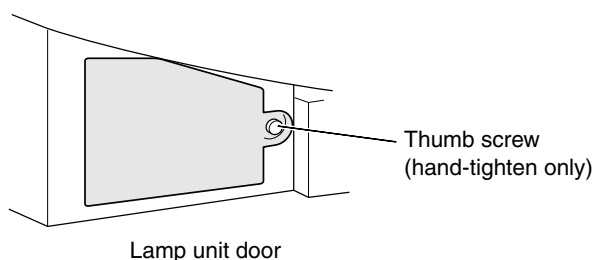

NOTE : Make sure the lamp unit and door is installed securely; otherwise, the TV may not turn on.

10. Plug in the power cord and turn on the TV. After the initial warmup period (which may take up to several seconds for full picture brightness), the TV should operate normally. If any of the following conditions exist, turn off the TV, unplug the power cord, and repeat steps 1–9 to ensure that the lamp unit and lamp unit door are installed correctly:

- No picture
- Dark picture
- TV will not turn on

If, after repeating steps 1–9, the problem still exists:

- In the U.S., call Customer Service at 1-800-631-3811.
- In Canada, locate the nearest Toshiba authorized service depot by directing your web browser to www.toshiba.ca; click “Home Entertainment,” and then click “Support.”

Lamp unit disposal

- Place the used lamp unit in the empty box from the new lamp unit.
- Keep the lamp unit out of reach of children and pets.

CAUTION: Always handle the lamp unit with care.
 The lamp unit in this TV was designed for safe replacement by consumers; however, if the lamp unit is subjected to intentional or accidental abuse (such as excessive mechanical abuse or handling by children or pets), the unit may break, exposing sharp edges or pinch points.

- Dispose of the used lamp unit by the approved method for your area.

NOTE : The lamp unit contains mercury, the disposal of which may be regulated due to environmental considerations. For disposal or recycling information, contact your local authorities or the Electronics Industries Alliance (www.eiae.org).

LED indications

The green and red LED lights on the TV control touchpad (on the lower right corner of the TV screen) indicate the TV's current status, as follows:

- Green ON = Control touchpad being pressed.
- Red ON = Power ON.
- Green and/or Red blinking (see table below for condition and solution).

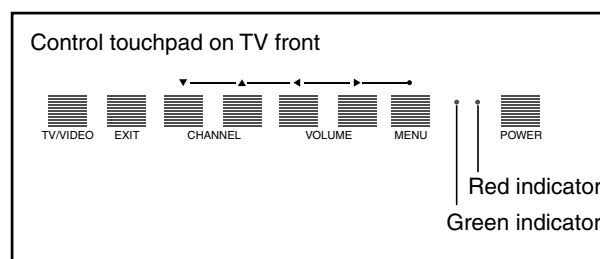

LED Indication	Condition	Solution
1) Green lights solid and Red blinks at 0.5-second intervals.	The lamp unit door is not seated properly.	Turn the POWER OFF and unplug the power cord. Review "How to replace the lamp unit" on pages 57-59 to ensure that the lamp unit door is installed securely. If the problem persists, contact a Toshiba Authorized Service Center.
2) Green blinks at 0.3-second intervals; Red lights solid.	The lamp is not working properly.	The TV automatically will try to restart itself eight times.
3) Green and Red blink at 1-second intervals.	The lamp is not working properly after the eighth automatic restart (see item #2).	Turn the POWER OFF and then ON again. If the problem persists, replace the lamp unit (see pages 57-59). If the problem still persists, contact a Toshiba Authorized Service Center.
4) Red blinks and Green off.	For service personnel only.	Turn the POWER OFF and unplug the power cord. If the problem persists, contact a Toshiba Authorized Service Center.
5) Red and Green blinks three times.	An abnormal temperature increase has occurred.	Do not block or cover the slots or openings in the TV cabinet. If the problem persists consult a Toshiba Authorized Service Center.

Specifications

- Design and specifications are subject to change without notice.



WARNING: RISK OF ELECTRIC SHOCK !

Never attempt to service the TV yourself. Opening and removing the covers may expose you to dangerous voltage or other hazards. Refer all servicing to a Toshiba Authorized Service Center.

Television System

NTSC standard

Channel Coverage

VHF: 2 through 13

UHF: 14 through 69

Cable TV: Mid band (A-8 through A-1, A through I)

Super band (J through W)

Hyper band (AA through ZZ, AAA, BBB)

Ultra band (65 through 94, 100 through 125)

Power Source

120 V AC, 60 Hz

Power Consumption

190 W (average)

Audio Power

20 W + 20 W

Speaker Type

Main: Two 4 inches (10 cm) round

Tweeter: Two 1-5/8 inches (4 cm) round

Video/Audio Terminals

S-VIDEO INPUT

Y : 1 V(p-p), 75 ohms, negative sync.

C : 0.286 V(p-p) (burst signal), 75 ohms

VIDEO/AUDIO INPUT

VIDEO: 1 V(p-p), 75 ohms, negative sync.

AUDIO: 150 mV(rms) (30% modulation equivalent, 22 k ohms or more)

ColorStream® (component video) INPUT

Y : 1V(p-p), 75 ohms

PR: 0.7 V(p-p), 75 ohms

PB: 0.7 V(p-p), 75 ohms

AUDIO: 150 mV(rms), 22 k ohms or more

VIDEO/AUDIO OUTPUT

VIDEO: 1 V(p-p), 75 ohms, negative sync.

AUDIO: 150 mV(rms) (30% modulation equivalent, 2.2 k ohms or less)

VARIABLE AUDIO OUTPUT

0–300 mV(rms) (30% modulation equivalent,

2.2 k ohms or less)

HDMI INPUT:

HDMI compliant (type A connector)

HDCP compliant

E-EDID* compliant

Suggested scan rates: 1080i, 480p, 480i, 720p

HDMI Audio: 2-channel PCM

32/44.1/48 kHz sampling frequency

16/20/24 bits per sample

Dimensions

46HM84: Width 53-1/8 inches (1,349 mm)

Height 31-13/16 inches (808 mm)

Depth 15-1/4 inches (387 mm)

52HM84: Width 58-3/8 inches (1,483 mm)

Height 35-1/16 inches (890 mm)

Depth 15-1/4 inches (387 mm)

62HM84: Width 67-1/16 inches (1,703 mm)

Height 40-15/16 inches (1,040 mm)

Depth 18-3/16 inches (462 mm)

Mass

46HM84: 78 lbs (35.0 kg)

52HM84: 83 lbs (38.0 kg)

62HM84: 99 lbs (45.0 kg)

Supplied Accessories

Remote Control with 2 size “AA” alkaline batteries

Owner’s Manual (this book)

Important notes sheet

Optional TV Stand

46HM84: ST4684

52HM84: ST5284

62HM84: ST6284

Operating condition

Temperature: 41°F–95°F (5°C–35°C)

* E-EDID = Enhanced-Extended Display Identification

Troubleshooting

Before calling a service technician, please check the following table for a possible cause of the symptom and some solutions.

Symptom	Solution
TV will not turn on	<ul style="list-style-type: none">• Make sure the power cord is plugged in, then press POWER.• The remote control batteries may be dead. Replace the batteries.• If you have recently replaced the lamp unit, make sure the lamp unit and lamp unit door are installed properly.• The lamp unit may need to be replaced. (See “LED indications” on page 60.)
No picture or too dark	<ul style="list-style-type: none">• The lamp unit may need to be replaced.
No picture, no sound	<ul style="list-style-type: none">• Check the antenna/cable connections.
No sound, picture OK	<ul style="list-style-type: none">• The sound may be muted. Press VOLUME.• The station may have broadcast difficulties. Try another channel.• Check that the SPEAKERS function in AUDIO menu is set properly.
Poor picture, sound OK	<ul style="list-style-type: none">• Check the antenna connections.• The station may have broadcast difficulties. Try another channel.• Adjust the PICTURE menu.
Poor reception of broadcast channels	<ul style="list-style-type: none">• The station may have broadcast difficulties. Try another channel.• Check the antenna connections.• If you are using a VCR, make sure the TV/VCR button is set correctly.
Cannot receive above channel 13	<ul style="list-style-type: none">• Make sure the TV/CABLE switch is set to the mode that corresponds with the signal source type (cable company or outside antenna).
Black box appears on the screen	<ul style="list-style-type: none">• The closed caption feature may be set to one of the Text modes (T1, T2, T3, or T4). Turn closed captioning OFF.
Unable to select a certain channel	<ul style="list-style-type: none">• The channel may be locked out with the CH LOCK feature, or erased with the ADD/ERASE feature.
Multiple images	<ul style="list-style-type: none">• The station may have broadcast difficulties. Try another channel.• Antenna reception may be poor. Use a highly directional outdoor antenna.
Poor color or no color	<ul style="list-style-type: none">• The station may have broadcast difficulties. Try another channel.• Adjust the TINT and/or COLOR in the PICTURE menu.• The lamp unit may need to be replaced.
No stereo or SAP sound from a known MTS broadcast	<ul style="list-style-type: none">• Make sure the MTS feature is set properly.
The screen lights dimly and the fan continues to run when the power is OFF.	<ul style="list-style-type: none">• The Quick Restart feature may be in ON mode. Set to OFF you do not prefer this.
The remote control does not operate	<ul style="list-style-type: none">• Check whether the appropriate device mode is selected.• Remove all obstructions between the remote control and the remote control sensor in the TV.• The remote control batteries may be dead. Replace the batteries.
Cannot access signal input sources (Video1, Video2, Video3, ColorStream HD1/HD2, HDMI) and/or Channels 3 and 4.	<ul style="list-style-type: none">• Check the VIDEO LOCK feature. (See page 42.)

Limited United States Warranty for DLP Television Models

Toshiba America Consumer Products, L.L.C. ("TACP") makes the following limited warranties to original consumers in the United States.

THESE LIMITED WARRANTIES EXTEND TO THE ORIGINAL CONSUMER PURCHASER OR ANY PERSON RECEIVING THIS DLP TELEVISION AS A GIFT FROM THE ORIGINAL CONSUMER PURCHASER AND TO NO OTHER PURCHASER OR TRANSFEREE.

PRODUCTS PURCHASED IN THE U.S.A. AND USED IN CANADA ARE NOT COVERED BY THESE WARRANTIES.

PRODUCTS PURCHASED IN CANADA AND USED IN THE U.S.A. ARE NOT COVERED BY THESE WARRANTIES.

Limited One (1) Year Warranty on Parts and Labor*

TACP warrants this DLP television and its parts against defects in materials or workmanship for a period of one (1) year after the date of original retail purchase. DURING THIS PERIOD, TACP WILL, AT TACP'S OPTION, REPAIR OR REPLACE A DEFECTIVE PART WITH A NEW OR REFURBISHED PART WITHOUT CHARGE TO YOU FOR PARTS OR LABOR. TACP Authorized Service Station personnel will come to your home when warranty service is required. Depending on the type of repair required, either the service will be performed in your home or the set will be taken to the TACP Authorized Service Station for repair and returned to your home at no cost to you.

Limited One (1) Year Warranty on Lamp Unit*

TACP warrants the lamp unit in this DLP television against defects in materials or workmanship for a period of one (1) year after the date of original retail purchase. DURING THIS PERIOD, TACP WILL, AT TACP'S OPTION, REPLACE A DEFECTIVE LAMP UNIT WITH A NEW OR REFURBISHED LAMP UNIT WITHOUT CHARGE TO YOU. LABOR CHARGES FOR LAMP UNIT REPLACEMENT ARE NOT COVERED UNDER WARRANTY. The lamp unit is a user-replaceable component.

Rental Units

The warranty for rental units begins with the date of first rental or thirty (30) days from the date of shipment to the rental firm, whichever comes first.

*Limited Warranty for Commercial Units

TACP warrants DLP televisions sold and used for commercial purposes as follows: all parts are warranted against defects in materials or workmanship for a period of ninety (90) days after the date of original purchase. DURING THIS PERIOD, TACP WILL, AT TACP'S OPTION, REPAIR OR REPLACE A DEFECTIVE PART WITH A NEW OR REFURBISHED PART WITHOUT CHARGE TO YOU.

Owner's Manual and Product Registration

Read this owner's manual thoroughly before operating this DLP television.

Complete and mail the enclosed product registration card or register your product online at www.tacp.toshiba.com/service as soon as possible. By registering your product you will enable TACP to provide you with better customer service and improved product support. Failure to register your product does not diminish your rights under this warranty.

Your Responsibility

THE ABOVE WARRANTIES ARE SUBJECT TO THE FOLLOWING CONDITIONS:

- (1) You must provide your bill of sale or other proof of purchase.
- (2) All warranty servicing of this DLP television must be performed by an Authorized TACP Service Station.
- (3) These warranties from TACP are effective only if the DLP television is purchased and operated in the U.S.A. or Puerto Rico.
- (4) Labor charges for installation, setup, adjustment of customer controls, and installation or repair of antenna systems are not covered by these warranties. Reception problems caused by inadequate antenna systems are your responsibility.
- (5) Warranties extend only to defects in materials or workmanship as limited above, and do not extend to any DLP television or parts that have been lost or discarded by you or to damage to the DLP television or parts caused by fires, misuse, accident, Acts of God (such as lightning or fluctuations in electric power), improper installation, improper maintenance, or use in violation of instructions furnished by TACP; use or malfunction through simultaneous use of this product and connected equipment; or to units that have been modified or had the serial number removed, altered, defaced, or rendered illegible.

How to Obtain Warranty Services

If, after following all of the operating instructions in this manual and checking the "Troubleshooting" section, you find that service is needed:

- (1) To find the nearest TACP Authorized Service Station, visit TACP's web site at www.tacp.toshiba.com/service or call toll free 1-800-631-3811.
- (2) Present your bill of sale or other proof of purchase to the Authorized Service Station.

**For additional information, visit TACP's web site:
www.tacp.toshiba.com**

ALL WARRANTIES IMPLIED BY THE LAW OF ANY STATE OF THE U.S.A., INCLUDING THE IMPLIED WARRANTIES OF MERCHANTABILITY AND FITNESS FOR A PARTICULAR PURPOSE, ARE EXPRESSLY LIMITED TO THE DURATION OF THE LIMITED WARRANTIES SET FORTH ABOVE. WITH THE EXCEPTION OF ANY WARRANTIES IMPLIED BY THE LAW OF ANY STATE OF THE U.S.A. AS HEREBY LIMITED, THE FOREGOING WARRANTY IS EXCLUSIVE AND IN LIEU OF ALL OTHER WARRANTIES, GUARANTEES, AGREEMENTS, AND SIMILAR OBLIGATIONS OF TACP WITH RESPECT TO THE REPAIR OR REPLACEMENT OF ANY PARTS. IN NO EVENT SHALL TACP BE LIABLE FOR CONSEQUENTIAL OR INCIDENTAL DAMAGES (INCLUDING, BUT NOT LIMITED TO, LOST PROFITS, BUSINESS INTERRUPTION, OR MODIFICATION OR ERASURE OF RECORDED DATA CAUSED BY USE, MISUSE, OR INABILITY TO USE THIS PRODUCT).

No person, agent, distributor, dealer, or company is authorized to change, modify, or extend the terms of these warranties in any manner whatsoever. The time within which action must be commenced to enforce any obligation of TACP arising under this warranty or under any law of the United States or of any state thereof is hereby limited to 90 days from the date you discover, or should have discovered, the defect. This limitation does not apply to implied warranties arising under the law of any state of the U.S.A.

THIS WARRANTY GIVES YOU SPECIFIC LEGAL RIGHTS, AND YOU MAY ALSO HAVE OTHER RIGHTS, WHICH MAY VARY FROM STATE TO STATE IN THE U.S.A. SOME STATES OF THE U.S.A. DO NOT ALLOW LIMITATIONS ON THE DURATION OF AN IMPLIED WARRANTY, LIMITATIONS ON THE TIME WITHIN WHICH AN ACTION MAY BE BROUGHT, OR THE EXCLUSION OR LIMITATION OF INCIDENTAL OR CONSEQUENTIAL DAMAGES; THEREFORE, THE ABOVE LIMITATIONS OR EXCLUSIONS MAY NOT APPLY TO YOU UNDER SUCH CIRCUMSTANCES.

051704

Introduction

Connecting
your TV

Using the
Remote Control

Setting up
your TV

Using the TV's
Features

Appendix

Index

Limited Canada Warranty

for DLP Television Models

Toshiba of Canada Limited ("TCL") makes the following limited warranties to original consumers in Canada.

THESE LIMITED WARRANTIES EXTEND TO THE ORIGINAL CONSUMER PURCHASER OR ANY PERSON RECEIVING THIS DLP TELEVISION AS A GIFT FROM THE ORIGINAL CONSUMER PURCHASER AND TO NO OTHER PURCHASER OR TRANSFEREE.

PRODUCTS PURCHASED IN THE U.S.A. AND USED IN CANADA ARE NOT COVERED BY THESE WARRANTIES.

PRODUCTS PURCHASED IN CANADA AND USED IN THE U.S.A. ARE NOT COVERED BY THESE WARRANTIES.

Limited One (1) Year Warranty on Parts and Labor*

TCL warrants this DLP television television and its parts against defects in materials or workmanship for a period of one (1) year after the date of original retail purchase. DURING THIS PERIOD, TCL WILL, AT TCL'S OPTION, REPAIR OR REPLACE A DEFECTIVE PART WITH A NEW OR REFURBISHED PART WITHOUT CHARGE TO YOU FOR PARTS OR LABOR. TCL Authorized Service Depot personnel will come to your home when warranty service is required. Depending on the type of repair required, either the service will be performed in your home or the set will be taken to the TCL Authorized Service Depot for repair and returned to your home at no cost to you. IN-HOME SERVICE ONLY APPLIES WITHIN 100 KILOMETERS OF AN AUTHORIZED TCL SERVICE DEPOT.

Limited One (1) Year Warranty on Lamp Unit*

TCL warrants the lamp unit in this DLP television against defects in materials or workmanship for a period of one (1) year after the date of original retail purchase. DURING THIS PERIOD, TCL WILL, AT TCL'S OPTION, REPLACE A DEFECTIVE LAMP UNIT WITH A NEW OR REFURBISHED LAMP UNIT WITHOUT CHARGE TO YOU. LABOR CHARGES FOR LAMP UNIT REPLACEMENT ARE NOT COVERED UNDER WARRANTY. The lamp unit is a user-replaceable component.

Rental Units

The warranty for rental units begins with the date of first rental or thirty (30) days from the date of shipment to the rental firm, whichever comes first.

*Limited Warranty for Commercial Units

TCL warrants DLP televisions sold and used for commercial purposes as follows: all parts are warranted against defects in materials or workmanship for a period of ninety (90) days after the date of original purchase. DURING THIS PERIOD, TCL WILL, AT TCL'S OPTION, REPAIR OR REPLACE A DEFECTIVE PART WITH A NEW OR REFURBISHED PART WITHOUT CHARGE TO YOU. ON-SITE SERVICE ONLY APPLIES WITHIN 100 KILOMETERS OF AN AUTHORIZED TCL SERVICE DEPOT.

Owner's Manual and Product Registration

Read this owner's manual thoroughly before operating this DLP television.

Register your product online at www.toshiba.ca as soon as possible. By registering your product you will enable TCL to provide you with better customer service and improved product support. Failure to register your product does not diminish your rights under this warranty.

Your Responsibility

THE ABOVE WARRANTIES ARE SUBJECT TO THE FOLLOWING CONDITIONS:

- (1) You must provide your bill of sale or other proof of purchase.
- (2) All warranty servicing of this DLP television must be performed by an Authorized TCL Service Depot.
- (3) These warranties from TCL are effective only if the DLP television is purchased in Canada from an authorized TCL dealer and operated in Canada.
- (4) Labor charges for installation, setup, adjustment of customer controls, and installation or repair of antenna systems are not covered by these warranties. Reception problems caused by inadequate antenna systems are your responsibility.
- (5) Warranties extend only to defects in materials or workmanship as limited above, and do not extend to any DLP television or parts that have been lost or discarded by you or to damage to the television or parts caused by fires, misuse, accident, Acts of God (such as lightning or fluctuations in electric power), improper installation, improper maintenance, or use in violation of instructions furnished by TCL; use or malfunction through simultaneous use of this product and connected equipment; or to units that have been modified or had the serial number removed, altered, defaced, or rendered illegible.

How to Obtain Warranty Services

If, after following all of the operating instructions in this manual and checking the "Troubleshooting" section, you find that service is needed:

- (1) To find the nearest TCL Authorized Service Depot, visit TCL's web site at www.toshiba.ca.
- (2) Present your bill of sale or other proof of purchase to the Authorized Service Depot.

**For additional information, visit TCL's web site:
www.toshiba.ca**

ALL WARRANTIES IMPLIED BY THE LAW OF ANY PROVINCE OF CANADA, INCLUDING THE IMPLIED WARRANTIES OF MERCHANTABILITY AND FITNESS FOR A PARTICULAR PURPOSE, ARE EXPRESSLY LIMITED TO THE DURATION OF THE LIMITED WARRANTIES SET FORTH ABOVE. WITH THE EXCEPTION OF ANY WARRANTIES IMPLIED BY THE LAW OF ANY PROVINCE OF CANADA AS HEREBY LIMITED, THE FOREGOING WARRANTY IS EXCLUSIVE AND IN LIEU OF ALL OTHER WARRANTIES, GUARANTEES, AGREEMENTS, AND SIMILAR OBLIGATIONS OF TCL WITH RESPECT TO THE REPAIR OR REPLACEMENT OF ANY PARTS. IN NO EVENT SHALL TCL BE LIABLE FOR CONSEQUENTIAL OR INCIDENTAL DAMAGES (INCLUDING, BUT NOT LIMITED TO, LOST PROFITS, BUSINESS INTERRUPTION, OR MODIFICATION OR ERASURE OF RECORDED DATA CAUSED BY USE, MISUSE, OR INABILITY TO USE THIS PRODUCT).

No person, agent, distributor, dealer, or company is authorized to change, modify, or extend the terms of these warranties in any manner whatsoever. The time within which action must be commenced to enforce any obligation of TCL arising under this warranty or under any law of Canada or of any province thereof is hereby limited to 90 days from the date you discover, or should have discovered, the defect. This limitation does not apply to implied warranties arising under the law of any province of Canada.

THIS WARRANTY GIVES YOU SPECIFIC LEGAL RIGHTS, AND YOU MAY ALSO HAVE OTHER RIGHTS, WHICH MAY VARY FROM PROVINCE TO PROVINCE IN CANADA. SOME PROVINCES OF CANADA DO NOT ALLOW LIMITATIONS ON THE DURATION OF AN IMPLIED WARRANTY, LIMITATIONS ON THE TIME WITHIN WHICH AN ACTION MAY BE BROUGHT, OR THE EXCLUSION OR LIMITATION OF INCIDENTAL OR CONSEQUENTIAL DAMAGES; THEREFORE, THE ABOVE LIMITATIONS OR EXCLUSIONS MAY NOT APPLY TO YOU UNDER SUCH CIRCUMSTANCES.

051704

Index

- A**
A/V cables (standard) 8
ANT 1/2 23
Antenna cables (coaxial) 8
AUDIO OUT sound, selecting 54
Audio system connection 16
Auto aspect 32
Auto favorite 36, 40
Auto power off 55
- B**
BACKGROUND selection 55
Back of the TV 7
- C**
CableClear™ DNR 45
Cable converter box connection 10
Camcorder connection 14
CH ▲▼ buttons 25
Channel Return 26
CH LABELING 28
CH LOCK 40
CH RTN button 26
Channel Number buttons 25
Channel programming
 ADD/ERASE 25
 Automatic programming 24
 TV/CABLE selection 24
Cinema mode 46
Clock, setting 50
Closed caption 48
Color temperature 44
ColorStream (component) cables 8
- D**
Double-window ("POP") feature 33
DTV receiver connection 13
DVD connection 11, 12
- F G H**
FAV ▲▼ buttons 27
FAVORITE button 36
Favorite channels, programming 26
Front of the TV 7
HDMI™ connection 15
- L M**
Labeling channels 28
Labeling video inputs 47
Lamp mode 46
Lamp unit replacement 56-60
Language selection 23
Last mode memory 55
Locking channels 40
Locking video inputs 42
Locks menu 37
Menu system 22
MTS feature 51
MUTE button 51
- O P**
ON timer 49
- Picture adjustments
 COLOR TEMPERATURE 44
 Picture mode 43
 Picture quality 43
Picture-out-picture (POP)
 CH SCAN button 35
 POP CH ▲▼ buttons 33
 POP DIRECT CH button 33
 SOURCE button 33
 SPLIT button 33
 SWAP button 34
Picture scroll 33
Picture size selection 29
POP Window 33
POWER button 21
- Q R**
Quick restart 25
RECALL button 55
Remote control
 Battery installation 17
 Learning about the buttons 21
 Programming 18
RESET 45, 53
- S**
SAP sound 51
Satellite receiver connection 11
Scrolling the Theater Wide picture 31
Set-top box 13
Sleep timer 49
Sound quality adjustments 52
SPEAKERS on/off 54
Specifications 61
SRS 3D surround 52
StableSound® 53
Stereo sound 51
SurfLock™ 26
S-video cables 8
- T**
Theater wide picture 30
Troubleshooting 62
TV/VIDEO button 26, 47
- V**
V-CHIP
 BLOCKING OPTION 39
 ENABLE BLOCKING 38
 MPAA RATING 39
 NEW PIN CODE 42
 TV RATING 38
 Unlocking programs temporarily 40
VCR connection 9
VIDEO LABEL 47
VIDEO LOCK 42
- W**
Warranty 63, 64
WOW surround sound feature 52

Introduction

Connecting
your TV

Using the
Remote Control

Setting up
your TV

Using the TV's
Features

Appendix

Index



66

#01E66-67_46,52,62HM84

66

5/31/04, 12:20 PM

Black

(E) 46HM84, 52HM84, 62HM84





TOSHIBA AMERICA CONSUMER PRODUCTS, L.L.C.

HEAD OFFICE: 82 TOTOWA ROAD, WAYNE, NJ 07470, U.S.A.
NATIONAL SERVICE DIVISION: 1420-B TOSHIBA DRIVE, LEBANON, TN 37087, U.S.A.

TOSHIBA OF CANADA LTD.

HEAD OFFICE: 191 McNABB STREET, MARKHAM, ONTARIO, L3R 8H2, CANADA – TEL: (905) 470-5400

SERVICE CENTERS:

TORONTO: 191 McNABB STREET, MARKHAM, ONTARIO L3R 8H2, CANADA – TEL: (905) 470-5400
MONTREAL: 18050 TRANS CANADA, KIRKLAND, QUEBEC, H9J 4A1, CANADA – TEL: (514) 390-7766
VANCOUVER: 22171 FRASERWOOD WAY, RICHMOND, B.C., V6W 1J5, CANADA – TEL: (604) 303-2500

MANUFACTURED BY

TOSHIBA AMERICA CONSUMER PRODUCTS, L.L.C.

ColorStream, StableSound, and TheaterWide are registered trademarks of Toshiba America Consumer Products, L.L.C.
CableClear and SurfLock are trademarks of Toshiba America Consumer Products, L.L.C.
The DLP™ logo and DLP™ medallion are trademarks of Texas Instruments.

TOSHIBA

PRINTED IN USA
(04-06)

23566346

Free Manuals Download Website

<http://myh66.com>

<http://usermanuals.us>

<http://www.somanuals.com>

<http://www.4manuals.cc>

<http://www.manual-lib.com>

<http://www.404manual.com>

<http://www.luxmanual.com>

<http://aubethermostatmanual.com>

Golf course search by state

<http://golfingnear.com>

Email search by domain

<http://emailbydomain.com>

Auto manuals search

<http://auto.somanuals.com>

TV manuals search

<http://tv.somanuals.com>