

TOSHIBA

Satellite® P100/P105 Series User's Guide

If you need assistance:

- ❖ Toshiba's Support Web site
pcsupport.toshiba.com
- ❖ Toshiba Global Support Centre
Calling within the United States (800) 457-7777
Calling from outside the United States (949) 859-4273

For more information, see “If Something Goes Wrong” on page 181 in this guide.

PMAD00064011
02/06

▲ WARNING

Handling the cord on this product will expose you to lead, a chemical known to the State of California to cause birth defects or other reproductive harm. ***Wash hands after handling.***

Model: Satellite® P100/P105 Series

Recordable and/or ReWritable Drive(s) and Associated Software Warranty

The computer system you purchased may include Recordable and/or ReWritable optical media drive(s) and associated software, among the most advanced data storage technologies available. As with any new technology, you must read and follow all set-up and usage instructions in the applicable user guides and/or manuals enclosed or provided electronically. If you fail to do so, this product may not function properly and you may lose data or suffer other damage. TOSHIBA AMERICA INFORMATION SYSTEMS, INC. (“TOSHIBA”), ITS AFFILIATES AND SUPPLIERS DO NOT WARRANT THAT OPERATION OF THE PRODUCT WILL BE UNINTERRUPTED OR ERROR FREE. YOU AGREE THAT TOSHIBA, ITS AFFILIATES AND SUPPLIERS SHALL HAVE NO RESPONSIBILITY FOR DAMAGE TO OR LOSS OF ANY BUSINESS, PROFITS, PROGRAMS, DATA, NETWORK SYSTEMS OR REMOVABLE STORAGE MEDIA ARISING OUT OF OR RESULTING FROM THE USE OF THE PRODUCT, EVEN IF ADVISED OF THE POSSIBILITY THEREOF.

Protection of Stored Data

For your important data, please make periodic back-up copies of all the data stored on the hard disk or other storage devices as a precaution against possible failures, alteration, or loss of the data. **IF YOUR DATA IS ALTERED OR LOST DUE TO ANY TROUBLE, FAILURE OR MALFUNCTION OF THE HARD DISK DRIVE OR OTHER STORAGE DEVICES AND THE DATA CANNOT BE RECOVERED, TOSHIBA SHALL NOT BE LIABLE FOR ANY DAMAGE OR LOSS OF DATA, OR ANY OTHER DAMAGE RESULTING THEREFROM. WHEN COPYING OR TRANSFERRING YOUR DATA, PLEASE BE SURE TO CONFIRM WHETHER THE DATA HAS BEEN SUCCESSFULLY COPIED OR TRANSFERRED. TOSHIBA DISCLAIMS ANY LIABILITY FOR THE FAILURE TO COPY OR TRANSFER THE DATA CORRECTLY.**

Critical Applications

The computer you have purchased is not designed for any “critical applications.” “Critical applications” means life support systems, medical applications, connections to implanted medical devices, commercial transportation, nuclear facilities or systems or any other applications where product failure could lead to injury to persons or loss of life or catastrophic property damage.

ACCORDINGLY, TOSHIBA, ITS AFFILIATES AND SUPPLIERS DISCLAIM ANY AND ALL LIABILITY ARISING OUT OF THE USE OF THE COMPUTER PRODUCTS IN ANY CRITICAL APPLICATIONS. IF YOU USE THE COMPUTER PRODUCTS IN A CRITICAL APPLICATION, YOU, AND NOT TOSHIBA, ASSUME FULL RESPONSIBILITY FOR SUCH USE.

FCC Notice “Declaration of Conformity Information”

This equipment has been tested and found to comply with the limits for a Class B digital device, pursuant to Part 15 of the FCC rules. These limits are designed to provide reasonable protection against harmful interference in a residential installation.

This equipment generates, uses and can radiate radio frequency energy and, if not installed and used in accordance with the instructions, it may cause harmful interference to radio communications. However, there is no guarantee that interference will not occur in a particular installation. If this equipment does cause harmful interference to radio or television reception, which can be determined by turning the equipment off and on, the user is encouraged to try to correct the interference by one or more of the following measures:

- ❖ Reorient or relocate the receiving antenna.
- ❖ Increase the separation between the equipment and receiver.
- ❖ Connect the equipment to an outlet on a circuit different from that to which the receiver is connected.
- ❖ Consult the dealer or an experienced radio/TV technician for help.

NOTE

Only Peripherals complying with the FCC Class B limits may be attached to this equipment. Operation with noncompliant peripherals or peripherals not recommended by Toshiba is likely to result in interference to radio and TV reception. Shielded cables must be used between the external devices and the computer's parallel port, monitor port, USB port, PS/2 port®, i.LINK® port and microphone jack. Changes or modifications made to this equipment not expressly approved by Toshiba or parties authorized by Toshiba could void the user's authority to operate the equipment.

This device complies with Part 15 of the FCC Rules. Operation is subject to the following two conditions:

- ❖ This device may not cause harmful interference.
- ❖ This device must accept any interference received, including interference that may cause undesired operation.

Contact either:

- ❖ Toshiba's Support Web site at pcsupport.toshiba.com.
- ❖ Or call the Toshiba Global Support Centre:
Within the United States at (800) 457-7777
Outside the United States at (949) 859-4273

Industry Canada Requirement

This Class B digital apparatus complies with Canadian ICES-003.

Cet appareil numérique de la classe B est conforme à la norme NMB-003 du Canada.

FCC requirements

The following information is pursuant to FCC CFR 47, Part 68 and refers to internal modems.

This equipment complies with Part 68 of the FCC rules. On the bottom of this equipment is a label that contains, among other information, the FCC registration number and ringer equivalence number (REN) for this equipment. If requested, the information must be provided to the telephone company.

The modem connects to the telephone line by means of a standard jack called the USOC RJ11C.

A plug and jack used to connect this equipment to the premises wiring and telephone network must comply with the applicable FCC part 68 rules and requirements adopted by the ACTA. It is designed to be connected to a compatible modular jack that is also compliant.

The REN is used to determine the number of devices that may be connected to a telephone line. Excessive RENs on a telephone line may result in the devices not ringing in response to an incoming call. In most but not all areas, the sum of RENs should not exceed five (5.0). To be certain of the number of devices that may be connected to a line, as determined by the total RENs, contact the local telephone company. For products approved after July 23, 2001, the REN for this product is part of the product identifier that has the format US:AAAEQ##TXXXX. The digits represented by the ## are the REN without a

decimal point (e.g., 03 is a REN of 0.3). For earlier products, the REN is separately shown on the label.

Connection to party line service is subject to state tariffs. Contact the state public utility commission, public service commission or corporation commission for information.

Telephone Company Procedures

The goal of the telephone company is to provide you with the best service it can. In order to do this, it may occasionally be necessary for them to make changes in their equipment, operations or procedures. If these changes might affect your service or the operation of your equipment, the telephone company will give you notice, in writing, to allow you to make any changes necessary to maintain uninterrupted service.

If Problems Arise

If this equipment causes harm to the telephone network, the telephone company will notify you in advance that temporary discontinuance of service may be required. But if advanced notice is not practical, the telephone company will notify the customer as soon as possible. Also, you will be advised of your right to file a complaint with the FCC if you believe it is necessary.

If trouble is experienced with this equipment, for repair or limited warranty information, please contact Toshiba Corporation, Toshiba America Information Systems, Inc. or an authorized representative of Toshiba, or the Toshiba Support Centre within the United States at (800) 457-7777 or Outside the United States at (949) 859-4273. If the equipment is causing harm to the telephone network, the telephone company may request that you disconnect the equipment until the problem is resolved.

Disconnection

If you should ever decide to permanently disconnect your modem from its present line, please call the telephone company and let them know of this change.

Fax Branding

The Telephone Consumer Protection Act of 1991 makes it unlawful for any person to use a computer or other electronic device, including Fax machines, to send any message unless such message clearly contains in a margin at the top or bottom of each transmitted page or on the first page of the transmission, the date and time it is sent and an identification of the business or other entity, or other individual sending the message and the telephone number of the sending machine or such business, other entity, or individual. (The telephone number

provided may not be a 900 number or any other number for which charges exceed local or long-distance transmission charges.)

In order to program this information into your fax transmission, refer to the fax software instructions installed on this computer.

Alarm Equipment

If your home has specially wired alarm equipment connected to the telephone line, ensure the installation of this equipment does not disable your alarm equipment. If you have questions about what will disable alarm equipment, consult your telephone company or a qualified installer.

Instructions for IC CS-03 Certified Equipment

- 1** NOTICE: The Industry Canada label identifies certified equipment. This certification means that the equipment meets certain telecommunications network protective, operational and safety requirements as prescribed in the appropriate Terminal Equipment Technical Requirements document(s). The Department does not guarantee the equipment will operate to the user's satisfaction.

Before installing this equipment, users should ensure that it is permissible to be connected to the facilities of the local telecommunications company. The equipment must also be installed using an acceptable method of connection. The customer should be aware that compliance with the above conditions may not prevent degradation of service in some situations.

Repairs to certified equipment should be coordinated by a representative designated by the supplier. Any repairs or alterations made by the user to this equipment, or equipment malfunctions, may give the telecommunications company cause to request the user to disconnect the equipment.

Users should ensure for their own protection that the electrical ground connections of the power utility, telephone lines and internal metallic water pipe system, if present, are connected together. This precaution may be particularly important in rural areas.

Caution: Users should not attempt to make such connections themselves, but should contact the appropriate electric inspection authority, or electrician, as appropriate.

- 2** The user manual of analog equipment must contain the equipment's Ringer Equivalence Number (REN) and an explanation notice similar to the following:

The Ringer Equivalence Number (REN) of this device can be found on the label affixed to your computer.

NOTICE: The Ringer Equivalence Number (REN) assigned to each terminal device provides an indication of the maximum number of terminals allowed to be connected to a telephone interface. The termination on an interface may consist of any combination of devices subject only to the requirement that the sum of the Ringer Equivalence Numbers of all the devices does not exceed 5.

- 3 The standard connecting arrangement (telephone jack type) for this equipment is jack type(s): USOC RJ11C.

Wireless Interoperability

The TOSHIBA Wireless LAN Mini PCI Card products are designed to be interoperable with any wireless LAN product that is based on Direct Sequence Spread Spectrum (DSSS) radio technology, and is compliant to:

- ❖ The IEEE 802.11 Standard on Wireless LANs (Revision A/B/G), as defined and approved by the Institute of Electrical and Electronics Engineers.
- ❖ The Wireless Fidelity (Wi-Fi) certification as defined by the Wi-Fi Alliance. The “Wi-Fi CERTIFIED” logo is a certification mark of the Wi-Fi Alliance.

CAUTION

Bluetooth[®] and Wireless LAN devices operate within the same radio frequency range and may interfere with one another. If you use *Bluetooth* and Wireless LAN devices simultaneously, you may occasionally experience a less than optimal network performance or even lose your network connection.

If you should experience any such problem, immediately turn off your *Bluetooth* or Wireless LAN device.

Please contact Toshiba PC product support on Web site <http://www.toshiba-europe.com/computers/tnt/bluetooth.htm> in Europe or pcsupport.toshiba.com in the United States for more information.

CAUTION

Radio Frequency Interference Requirements

This device is restricted to indoor use due to its operation in the 5.15 GHz to 5.25 GHz frequency range. FCC requires this product to be used indoors for frequency range 5.15 GHz to 5.25 GHz to reduce the potential for harmful interference to co-channel Mobile Satellite systems.

High power radars are allocated as primary users of the 5.25 GHz to 5.35 GHz and 5.65 GHz to 5.85 GHz bands. These radar stations can cause interference with and/or damage this device.

Wireless LAN and Your Health

Wireless LAN products, like other radio devices, emit radio frequency electromagnetic energy. The level of energy emitted by Wireless LAN devices however is far much less than the electromagnetic energy emitted by wireless devices like for example mobile phones.

Because Wireless LAN products operate within the guidelines found in radio frequency safety standards and recommendations, TOSHIBA believes Wireless LAN is safe for use by consumers. These standards and recommendations reflect the consensus of the scientific community and result from deliberations of panels and committees of scientists who continually review and interpret the extensive research literature.

In some situations or environments, the use of Wireless LAN may be restricted by the proprietor of the building or responsible representatives of the organization. These situations may for example include:

- ❖ Using the Wireless LAN equipment on board airplanes, or
- ❖ In any other environment where the risk of interference to other devices or services is perceived or identified as harmful.

If you are uncertain of the policy that applies on the use of wireless devices in a specific organization or environment (e.g. airports), you are encouraged to ask for authorization to use the Wireless LAN device prior to turning on the equipment.

CAUTION

Exposure to Radio Frequency Radiation

The radiated output power of the TOSHIBA Wireless LAN Mini PCI Card is far below the FCC radio frequency exposure limits. Nevertheless, the TOSHIBA Wireless LAN Mini PCI Card shall be used in such a manner that the potential for human contact during normal operation is minimized. In normal operating configuration, the LCD in the upright position, the distance between the antenna and the user should not be less than 20 cm. The antenna(s) used for this transmitter must not be co-located or operating in conjunction with any other antenna or transmitter. Antenna(s) used in 5.15 GHz to 5.25 GHz frequency band must be integral antenna which provide no access to the end user.

Refer to the Regulatory Statements as identified in the documentation that comes with those products for additional information.

Regulatory Information

The TOSHIBA Wireless LAN Mini PCI Card must be installed and used in strict accordance with the manufacturer's instructions as described in the user

documentation that comes with the product. This device complies with the following radio frequency and safety standards.

Canada – Industry Canada (IC)

This device complies with RSS 210 of Industry Canada.

CAUTION

The installer of this radio equipment must ensure that the antenna is located or pointed such that it does not emit RF field in excess of Health Canada limits for the general population; consult Safety Code 6, obtainable from Health Canada's Web site www.hc-sc.gc.ca/rpb. The RF device shall not be co-located with any other transmitter that has not been tested with this device.

Operation is subject to the following two conditions: (1) this device may not cause interference, and (2) this device must accept any interference, including interference that may cause undesired operation of this device.

L'utilisation de ce dispositif est autorisée seulement aux conditions suivantes: (1) il ne doit pas produire de brouillage et (2) l'utilisateur du dispositif doit être prêt à accepter tout brouillage radioélectrique reçu, même si ce brouillage est susceptible de compromettre le fonctionnement du dispositif.

The term "IC" before the equipment certification number only signifies that the Industry Canada technical specifications were met.

To prevent radio interference to the licensed service, this device is intended to be operated indoors and away from windows to provide maximum shielding. Equipment (or its transmit antenna) that is installed outdoors is subject to licensing.

Pour empêcher que cet appareil cause du brouillage au service faisant l'objet d'une licence, il doit être utilisé à l'intérieur et devrait être placé loin des fenêtres afin de fournir un écran de blindage maximal. Si le matériel (ou son antenne d'émission) est installé à l'extérieur, il doit faire l'objet d'une licence.

CAUTION

This device is restricted to indoor use due to its operation in the 5.15 GHz to 5.25 GHz frequency range. Industry Canada requires this product to be used indoors for frequency range 5.15 GHz to 5.25 GHz to reduce the potential for harmful interference to co-channel Mobile Satellite systems.

High power radars are allocated as primary users of the 5.25 GHz to 5.35 GHz and 5.65 GHz to 5.85 GHz bands. These radar stations can cause interference with and/or damage this device.

EU Declaration of Conformity

TOSHIBA declares, that the product: PLU10* conforms to the following Standards:



Supplementary *The product complies with the
Information: requirements of the Low Voltage Directive
72/23/EEC, the EMC Directive 89/336/
EEC and/or the R&TTE Directive 1999/
05/EEC.

This product is carrying the CE-Mark in accordance with the related European Directives. Responsible for CE-Marking is TOSHIBA Europe, Hammfelddamm 8, 41460 Neuss, Germany.

VCCI Class B Information

この装置は、情報処理装置等電波障害自主規制協議会（VCCI）の基準に基づくクラスB情報技術装置です。この装置は、家庭環境で使用することを目的としていますが、この装置がラジオやテレビジョン受信機に近接して使用されると、受信障害を引き起こすことがあります。
取扱説明書に従って正しい取り扱いをして下さい。

Modem Warning Notice

Conformity Statement

The equipment has been approved to [Commission Decision “CTR-21”] for pan-European single terminal connection to the Public Switched Telephone Network (PSTN).

However, due to differences between the individual PSTNs provided in different countries/regions the approval does not, of itself, give an unconditional assurance of successful operation on every PSTN network termination point.

In the event of problems, you should contact your equipment supplier in the first instance.

NOTE

The above Caution information applies to products that operate with an 802.11a device.

Taiwan

Article 14	Unless approved, for any model accredited low power radio frequency electric machinery, any company, trader or user shall not change the frequency, increase the power or change the features and functions of the original design.
Article 17	Any use of low power radio frequency electric machinery shall not affect aviation safety and interfere with legal communications. In the event interference is caused, the use of such electric machinery shall be immediately discontinued. Operation of such products can be resumed only when they are modified and can no longer cause interference.

The legal communications mentioned in the above item refer to radio communications operated in accordance with telecommunication laws and regulations.

Low power radio frequency electric machinery shall resist against interference from legal communications or from industrial, scientific and medical radio emission electric machinery.

Using this Equipment in Japan

In Japan, the frequency bandwidth of 2,400 MHz to 2,483.5 MHz for second generation low-power data communication systems such as this equipment overlaps that of mobile object identification systems (premises radio station and specified low-power radio station).

1. Sticker

Please put the following sticker on devices incorporating this product.

The frequency bandwidth of this equipment may operate within the same range as industrial devices, scientific devices, medical devices, microwave ovens, licensed radio stations and non-licensed specified low-power radio stations for mobile object identification systems (RFID) used in factory product lines (Other Radio Stations).

1. Before using this equipment, ensure that it does not interfere with any of the equipment listed above.
2. If this equipment causes RF interference to other radio stations, promptly change the frequency being used, change the location of use, or turn off the source of emissions.
3. Contact TOSHIBA Direct PC if you have problems with interference caused by this product to Other Radio Stations.

2. Indication

The indication shown below appears on this equipment.

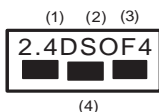

- 1** 2.4: This equipment uses a frequency of 2.4 GHz.
- 2** DS: This equipment uses DS-SS modulation.
OF: This equipment uses OFDM modulation.
- 3** The interference range of this equipment is less than 40m.
- 4** ■ ■ ■ This equipment uses a frequency bandwidth from 2,400 MHz to 2,483.5 MHz.

It is possible to avoid the band of mobile object identification systems.

3. TOSHIBA Direct PC

Monday – Friday: 10:00 – 17:00

Toll Free Tel: 0120-13-1100

Direct Dial: 03-3457-5916

Fax: 03-5444-9450

Device Authorization

This device obtains the Technical Regulation Conformity Certification and the Technical Conditions Compliance Approval, and it belongs to the device class of radio equipment of low-power data communication system radio station stipulated in the Radio Law and the Telecommunications Business Law of Japan.

The Name of the radio equipment: refer to the equipment label provided on the computer

JAPAN APPROVALS INSTITUTE FOR TELECOMMUNICATIONS
EQUIPMENT

Approval Number: D01-1128JP

TELECOM ENGINEERING CENTER Approval Number: 03NY.A0018,
03GZDA0017

The following restrictions apply:

- ❖ Do not disassemble or modify the device.
- ❖ Do not install the embedded wireless module into other device.
- ❖ 5.17 GHz to 5.23 GHz for indoor use only.

Radio Approvals for Wireless Devices

NOTE The following information is dependent on what type of wireless device is in your computer.

Approved Countries/Regions for use for the Atheros AR5BMB-43/44 and AR5BMB5 Mini PCI Wireless Network Adapters

This equipment is approved to the radio standard by the countries/regions in the following table.

CAUTION Do not use this equipment except in the countries/regions in the following table.

NOTE This device works on passive scan only.
A peer-to-peer mode is not available in 802.11a and Turbo Mode.

802.11b (2.4 GHz)

Australia	Austria	Belgium
Canada	Denmark	Finland
France	Germany	Greece
Ireland	Italy	Liechtenstein
Luxembourg	Netherlands	New Zealand
Norway	Portugal	Sweden
Switzerland	UK	USA

Europe - Restrictions for use of 2.4 GHz Frequencies in European Community Countries

België/ Belgique:	For private usage outside buildings across public grounds over less than 300m no special registration with IBPT/BIPT is required. Registration to IBPT/BIPT is required for private usage outside buildings across public grounds over more than 300m. For registration and license please contact IBPT/BIPT.
	Voor privé-gebruik buiten gebouw over publieke grond over afstand kleiner dan 300m geen registratie bij BIPT/IBPT nodig; voor gebruik over afstand groter dan 300m is wel registratie bij BIPT/IBPT nodig. Voor registratie of licentie kunt u contact opnemen met BIPT.
	Dans le cas d'une utilisation privée, à l'extérieur d'un bâtiment, au-dessus d'un espace public, aucun enregistrement n'est nécessaire pour une distance de moins de 300m. Pour une distance supérieure à 300m un enregistrement auprès de l'IBPT est requise. Pour les enregistrements et licences, veuillez contacter l'IBPT.
Deutschland:	License required for outdoor installations. Check with reseller for procedure to follow.
	Anmeldung im Outdoor-Bereich notwendig, aber nicht genehmigungspflichtig. Bitte mit Händler die Vorgehensweise abstimmen.
France:	Restricted frequency band: only channels 1 to 7 (2400 MHz and 2454 MHz respectively) may be used outdoors in France. Please contact A.R.T. (http://www.art-telecom.fr) for applicable procedures to follow.
	Bande de fréquence restreinte: seuls les canaux 1- 7 (2400 et 2454 MHz respectivement) doivent être utilisés endroits extérieur en France. Vous pouvez contacter l'Autorité de Régulation des Télécommunications (http://www.art-telecom.fr) pour la procédure à suivre.
Italia:	License required for indoor use. Use with outdoor installations not allowed.
	E' necessaria la concessione ministeriale anche per l'uso interno. Verificare con i rivenditori la procedura da seguire.
Nederland:	License required for outdoor installations. Check with reseller for procedure to follow.
	Licentie verplicht voor gebruik met buitenantennes. Neem contact op met verkoper voor juiste procedure.

802.11a (5 GHz)

Australia	Austria	Belgium
Canada	Denmark	Finland
France	Germany	Greece
Ireland	Italy	Liechtenstein
Luxembourg	Netherlands	New Zealand
Norway	Portugal	Sweden
Switzerland	UK	USA

Turbo Mode (5 GHz)

Canada	USA	
--------	-----	--

Europe - Restrictions for use of 5 GHz Frequencies in European Community Countries

European Community Countries	5150-5250 MHz Channels: 36, 40, 44, 48 Indoor Only	5250-5350 MHz Channels: 52, 56, 60, 64 Indoor Only	5470-5725 MHz Channels: 100, 104, 108, 112, 116, 120, 124, 128, 132, 136, 140 Indoor/Outdoor
Austria	O	x	x
Belgium, France, Switzerland/Liechtenstein	O	O	x
Denmark, Finland, Germany, Greece, Ireland, Italy, Luxembourg, Netherlands, Norway, Portugal, Sweden, UK	O	O	O
Iceland, Spain	O	O	O

O: allowed x: forbidden

- ❖ To remain in conformance with European spectrum usage laws for Wireless LAN operation, the above 2.4 GHz and 5 GHz channel limitations apply. The user should use the wireless LAN utility to check the current channel of operation. If operation is occurring outside of the allowable frequencies as listed above, the user must cease operating the Wireless LAN at that location and consult the local technical support staff responsible for the wireless network.
- ❖ The 5 GHz Turbo mode feature is not allowed for operation in any European Community country.

- ❖ This device must not be operated in ad-hoc mode using channels in the 5 GHz bands in the European Community. Ad-hoc mode provides a direct communication between two client devices without a Wireless LAN Access Point.
- ❖ This device must be used with Access Points that have employed and activated a radar detection feature required for European Community operation in the 5 GHz bands. This device will operate under the control of the Access Point in order to avoid operating on a channel occupied by any radar system in the area. The presence of nearby radar operation may result in temporary interruption of operation of this device. The Access Point's radar detection feature will automatically restart operation on a channel free of radar. You may consult with the local technical support staff responsible for the wireless network to ensure the Access Point device(s) are properly configured for European Community operation.

Approved Countries/Regions for use for the Atheros AR5001X Mini PCI Wireless Network Adapter

This equipment is approved to the radio standard by the countries/regions in the following table.

CAUTION

Do not use this equipment except in the countries/regions in the following table.

NOTE

This device works on passive scan only.

A peer-to-peer mode is not available in 802.11a and Turbo Mode.

802.11b (2.4 GHz)

Australia	Austria	Belgium
Canada	Denmark	Finland
France	Germany	Greece
Ireland	Italy	Liechtenstein
Luxembourg	Netherlands	New Zealand
Norway	Portugal	Sweden
Switzerland	UK	USA

802.11a (5 GHz)

Australia	Austria	Belgium
Canada	Denmark	Finland
France	Germany	Greece
Ireland	Italy	Liechtenstein
Luxembourg	Netherlands	New Zealand
Norway	Portugal	Sweden
Switzerland	UK	USA

Turbo Mode (5 GHz)

Canada	USA	
--------	-----	--

Approved Countries/Regions for use for the Intel® PRO/ Wireless LAN 2100 3B Mini PCI Adapter

This equipment is approved to the radio standard by the countries/regions in the following table.

CAUTION

Do not use this equipment except in the countries/regions in the following table.

Argentina	Australia	Austria
Belgium	Brazil	Canada
Chile	Denmark	Finland
France	Germany	Greece
Iceland	Ireland	Italy
Japan	Liechtenstein	Luxembourg
Mexico	Netherlands	New Zealand
Norway	Peru	Portugal
Singapore	Spain	Sweden
Switzerland	UK	Uruguay
USA	Venezuela	

Approved Countries/Regions for use for the Toshiba Mini PCI Wireless LAN Card

This equipment is approved to the radio standard by the countries/regions in the following table.

CAUTION

Do not use this equipment except in the countries/regions in the following table.

Australia	Austria	Belgium
Canada	Denmark	Finland
France	Germany	Greece
Hong Kong	Iceland	Ireland
Italy	Japan	Liechtenstein
Luxembourg	Malaysia	Netherlands
New Zealand	Norway	Philippines
Portugal	Singapore	Spain
Sweden	Switzerland	Thailand
UK	USA	

Approved Countries/Regions for use for the INPROCMM IPN2220 Wireless Network Adapter

This equipment is approved to the radio standard by the countries/regions in the following table.

CAUTION

Do not use this equipment except in the countries/regions in the following table.

EU	Canada	Japan
USA	Australia	New Zealand

Bluetooth® Wireless Technology Interoperability

Bluetooth® Cards from TOSHIBA are designed to be interoperable with any product with Bluetooth wireless technology that is based on Frequency Hopping Spread Spectrum (FHSS) radio technology, and is compliant to:

- ❖ Bluetooth Specification as defined and approved by The Bluetooth Special Interest Group.

-
- ❖ Logo certification with *Bluetooth* wireless technology as defined by The *Bluetooth* Special Interest Group.
-

CAUTION

Bluetooth wireless technology is a new innovative technology, and TOSHIBA has not confirmed compatibility of its *Bluetooth* products with all PCs and/or equipment using *Bluetooth* wireless technology other than TOSHIBA portable computers.

Always use *Bluetooth* cards from TOSHIBA in order to enable wireless networks over two or more (up to a total of seven) TOSHIBA portable computers using these cards. Please contact TOSHIBA PC product support on Web site <http://www.toshiba-europe.com/computers/tnt/bluetooth.htm> in Europe or pcsupport.toshiba.com in the United States for more information.

When you use *Bluetooth* cards from TOSHIBA close to 2.4 GHz Wireless LAN devices, *Bluetooth* transmissions might slow down or cause errors. If you detect certain interference while you use *Bluetooth* cards from TOSHIBA, always change the frequency, move your PC to the area outside of the interference range of 2.4 GHz Wireless LAN devices (40 meters/43.74 yards or more) or stop transmitting from your PC. Please contact TOSHIBA PC product support on Web site <http://www.toshiba-europe.com/computers/tnt/bluetooth.htm> in Europe or pcsupport.toshiba.com in the United States for more information.

Bluetooth and Wireless LAN devices operate within the same radio frequency range and may interfere with one another. If you use *Bluetooth* and Wireless LAN devices simultaneously, you may occasionally experience a less than optimal network performance or even lose your network connection. If you should experience any such problem, immediately turn off either one of your *Bluetooth* or Wireless LAN. Please contact Toshiba PC product support on Web site <http://www.toshiba-europe.com/computers/tnt/bluetooth.htm> in Europe or pcsupport.toshiba.com in the United States for more information.

***Bluetooth*[®] Wireless Technology and Your Health**

The products with *Bluetooth* wireless technology, like other radio devices, emit radio frequency electromagnetic energy. The level of energy emitted by devices with *Bluetooth* wireless technology however is far much less than the electromagnetic energy emitted by wireless devices like for example mobile phones.

Because products with *Bluetooth* wireless technology operate within the guidelines found in radio frequency safety standards and recommendations, TOSHIBA believes *Bluetooth* wireless technology is safe for use by consumers. These standards and recommendations reflect the consensus of the scientific

community and result from deliberations of panels and committees of scientists who continually review and interpret the extensive research literature.

In some situations or environments, the use of *Bluetooth* wireless technology may be restricted by the proprietor of the building or responsible representatives of the organization. These situations may for example include:

- ❖ Using the equipment with *Bluetooth* wireless technology on board airplanes, or
- ❖ In any other environment where the risk of interference to other devices or services is perceived or identified as harmful.

If you are uncertain of the policy that applies on the use of wireless devices in a specific organization or environment (e.g. airports), you are encouraged to ask for authorization to use the device with *Bluetooth* wireless technology prior to turning on the equipment.

CAUTION**Exposure to Radio Frequency Radiation**

The radiated output power of the *Bluetooth* Card from TOSHIBA is far below the FCC radio frequency exposure limits. Nevertheless, the *Bluetooth* Card from TOSHIBA shall be used in such a manner that the potential for human contact during normal operation is minimized.

In order to comply with FCC radio-frequency radiation exposure guidelines for an uncontrolled environment, the *Bluetooth* Card from TOSHIBA has to be operated while maintaining a minimum body to antenna distance of 20 cm.

Refer to the Regulatory Statements as identified in the documentation that comes with those products for additional information.

The *Bluetooth* Card from TOSHIBA is far below the FCC radio frequency exposure limits.

Nevertheless, it is advised to use the *Bluetooth* Card from TOSHIBA in such a manner that human contact during normal operation is minimized.

Regulatory statements

This product complies with any mandatory product specification in any country/region where the product is sold. In addition, the product complies with the following:

European Union (EU) and EFTA

This equipment complies with the R&TTE directive 1999/5/EC and has been provided with the CE mark accordingly.

Canada — Industry Canada (IC)

This device complies with RSS 210 of Industry Canada.

Taiwan

Article 14	Unless approved, for any model accredited low power radio frequency electric machinery, any company, trader or user shall not change the frequency, increase the power or change the features and functions of the original design.
Article 17	Any use of low power radio frequency electric machinery shall not affect aviation safety and interfere with legal communications. In the event interference is caused, the use of such electric machinery shall be immediately discontinued. Operation of such products can be resumed only when they are modified and can no longer cause interference.

The legal communications mentioned in the above item refer to radio communications operated in accordance with telecommunication laws and regulations.

Low power radio frequency electric machinery shall resist against interference from legal communications or from industrial, scientific and medical radio emission electric machinery.

Using this Equipment in Japan

In Japan, the frequency bandwidth of 2,400 MHz to 2,483.5 MHz for second generation low-power data communication systems such as this equipment overlaps that of mobile object identification systems (premises radio station and specified low-power radio station).

1. Sticker

Please put the following sticker on devices incorporating this product.

The frequency bandwidth of this equipment may operate within the same range as industrial devices, scientific devices, medical devices, microwave ovens, licensed radio stations and non-licensed specified low-power radio stations for mobile object identification systems (RFID) used in factory product lines (Other Radio Stations).

1. Before using this equipment, ensure that it does not interfere with any of the equipment listed above.
2. If this equipment causes RF interference to other radio stations, promptly change the frequency being used, change the location of use, or turn off the source of emissions.
3. Contact TOSHIBA Direct PC if you have problems with interference caused by this product to Other Radio Stations.

2. Indication

The indication shown below appears on this equipment.

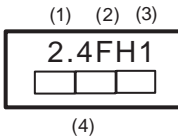

- 1** 2.4: This equipment uses a frequency of 2.4 GHz.
- 2** FH: This equipment uses FH-SS modulation.
- 3** The interference range of this equipment is less than 10m.
- 4** This equipment uses a frequency bandwidth from 2,400 MHz to 2,483.5 MHz. It is impossible to avoid the band of mobile object identification systems.

3. TOSHIBA Direct PC

Monday – Friday: 10:00 – 17:00

Toll Free Tel: 0120-13-1100

Direct Dial: 03-3457-5916

Fax: 03-5444-9450

Device Authorization

This device obtains the Technical Regulation Conformity Certification, and it belongs to the device class of radio equipment of low-power data communication system radio station stipulated in the Radio Law of Japan.

The Name of the radio equipment: EYXF2CS

TELECOM ENGINEERING CENTER

Approval Number: 01NYDA1305

The following restrictions apply:

- ❖ Do not disassemble or modify the device.
- ❖ Do not install the embedded wireless module into other device.

CD-RW/DVD-ROM or Multi-function Drive Safety Instructions

⚠ DANGER

The DVD-ROM and multi-function drives employ a laser system. To ensure proper use of this product, please read this instruction manual carefully and retain for future reference.

Never attempt to disassemble, adjust or repair a CD/DVD drive, CD-RW drive, Multi-drive or any other optical drive. You could damage the drive. You would also be exposed to laser light or other safety hazards, resulting in serious injury. Always contact an authorized Toshiba service provider, if any repair or adjustment is required.

Location of the Required Label

(Sample shown below. Location of the label and manufacturing information may vary.)

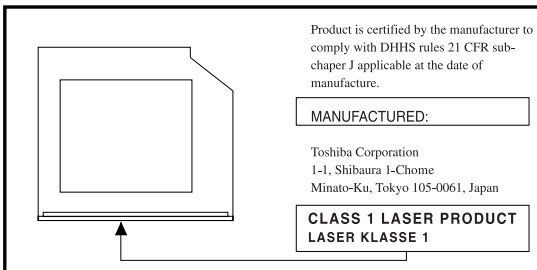

⚠ DANGER

This appliance contains a laser system and is classified as a CLASS 1 LASER PRODUCT. To use this model properly, read the user's guide carefully and keep it for your future reference.

Never attempt to disassemble, adjust or repair a CD/DVD drive, CD-RW drive, Multi-drive or any other optical drive. You could damage the drive. You would also be exposed to laser light or other safety hazards, resulting in serious injury. Always contact an authorized Toshiba service provider, if any repair or adjustment is required.

CLASS 1 LASER PRODUCT
LASER KLASSE 1

Copyright

This guide is copyrighted by Toshiba America Information Systems, Inc. with all rights reserved. Under the copyright laws, this guide cannot be reproduced in any form without the prior written permission of Toshiba. No patent liability is assumed, however, with respect to the use of the information contained herein.

©2006 by Toshiba America Information Systems, Inc. All rights reserved.

Export Administration Regulation

This document contains technical data that may be controlled under the U.S. Export Administration Regulations, and may be subject to the approval of the U.S. Department of Commerce prior to export. Any export, directly or indirectly, in contravention of the U.S. Export Administration Regulations is prohibited.

Notice

The information contained in this manual, including but not limited to any product specifications, is subject to change without notice.

TOSHIBA CORPORATION AND TOSHIBA AMERICA INFORMATION SYSTEMS, INC. (TOSHIBA) PROVIDES NO WARRANTY WITH REGARD TO THIS MANUAL OR ANY OTHER INFORMATION CONTAINED HEREIN AND HEREBY EXPRESSLY DISCLAIMS ANY IMPLIED WARRANTIES OF MERCHANTABILITY OR FITNESS FOR ANY PARTICULAR PURPOSE WITH REGARD TO ANY OF THE FOREGOING. TOSHIBA ASSUMES NO LIABILITY FOR ANY DAMAGES INCURRED DIRECTLY OR INDIRECTLY FROM ANY TECHNICAL OR TYPOGRAPHICAL ERRORS OR OMISSIONS CONTAINED HEREIN OR FOR DISCREPANCIES BETWEEN THE PRODUCT AND THE MANUAL. IN NO EVENT SHALL TOSHIBA BE LIABLE FOR ANY INCIDENTAL, CONSEQUENTIAL, SPECIAL, OR EXEMPLARY DAMAGES, WHETHER BASED ON TORT, CONTRACT OR OTHERWISE, ARISING OUT OF OR IN CONNECTION WITH THIS MANUAL OR ANY OTHER INFORMATION CONTAINED HEREIN OR THE USE THEREOF.

Trademarks

Satellite is a registered trademark of Toshiba America Information Systems, Inc. and/or Toshiba Corporation.

Microsoft and Windows are registered trademarks of Microsoft Corporation in the United States and/or other countries.

DirectX, Active Desktop, DirectShow, and Windows Media are registered trademarks of Microsoft Corporation.

ConfigFree is a trademark of Toshiba Corporation.

Wi-Fi is a registered trademark of the Wi-Fi Alliance.

Dolby - Manufactured by Toshiba under license from Dolby Laboratories/ Dolby and the double-D symbol are trademarks of Dolby Laboratories.

Bluetooth word mark and logos are owned by the Bluetooth SIG, Inc. and any use of such marks by Toshiba is under license. Other trademarks and trade names are those of their respective owners.

All other brand and product names are trademarks or registered trademarks of their respective companies.

Computer Disposal Information

This product contains mercury. Disposal of this material may be regulated due to environmental considerations. For disposal, reuse or recycling information, please contact your local government or the Electronic Industries Alliance at www.eiae.org.

Contents

Introduction.....	34
This guide	35
Safety icons	36
Other icons used	37
Other documentation	37
Service options	38
Chapter 1: Getting Started.....	39
Selecting a place to work	39
Creating a computer-friendly environment.....	39
Keeping yourself comfortable	40
Precautions	40
Important information on your computer's cooling fan	43
Setting up your computer	43
Setting up your software.....	44
Registering your computer with Toshiba	45
Adding external devices	46
Connecting to a power source	47
Using the main battery.....	50

Using the computer for the first time	51
Opening the display panel	51
Your computer's features and specifications	52
Turning on the power	52
Adding memory (optional)	53
Installing a memory module	54
Removing a memory module	59
Using the TouchPad™	61
Scrolling with the TouchPad™	62
Control buttons	62
Disabling or enabling the TouchPad	62
Using the Dual Mode Pad	64
Scrolling with the Dual Mode Pad	65
Using the Control buttons	65
Using Tap Zones	65
Using the Virtual Buttons	66
Disabling or enabling the Dual Mode Pad	67
Using external display devices	68
Directing the display output when you turn on the computer	69
Adjusting the quality of the external display	70
Using an external keyboard	70
Using a mouse	71
Connecting a printer	71
Setting up your printer	72
Connecting an optional external diskette drive	73
Turning off the computer	74
Options for turning off the computer	74
Using the Turn Off Computer or Shut Down commands	77
Using and configuring Hibernation mode	78
Using and configuring Standby mode	79
Closing the display panel	80
Caring for your computer	81

Cleaning the computer	81
Moving the computer	81
Using a computer lock	81
Chapter 2: Learning the Basics	83
Computing tips	83
Using the keyboard	85
Character keys	85
Ctrl, Fn, and Alt keys	85
Function keys	86
Windows special keys	86
Starting a program	87
Starting a program from the Start menu	87
Starting a program from Windows® Explorer	88
Starting a program from the Run dialog box	89
Saving your work	90
Saving files	90
Printing your work	92
Backing up your work	93
Restoring your work	94
Using the CD-RW/DVD-ROM or multi-function drive	94
CD-RW/DVD-ROM or multi-function drive components	95
Media Control Buttons	96
Inserting a compact disc	97
Playing an audio CD	99
Playing CDs using Auto-Run	101
Creating a CD	101
Removing a disc with the computer on	102
Removing a disc with the computer off	103
Caring for CD or DVD Discs	103
Toshiba's online resources	104

Chapter 3: Mobile Computing.....	105
Toshiba's energy-saver design.....	105
Running the computer on battery power	105
Battery Notice	106
Power management	107
Using additional batteries	107
Charging batteries.....	108
Charging the main battery.....	108
Charging the RTC battery.....	109
Monitoring main battery power.....	110
Determining remaining main battery power....	112
What to do when the main battery runs low ...	114
Setting battery alarms.....	114
Conserving battery power	115
Power Schemes	116
Using a hot key to set the Power Scheme.....	117
Changing the main battery	118
Removing the battery from the computer	119
Inserting a charged battery	120
Taking care of your battery	122
Safety precautions	122
Maximizing battery life	123
Disposing of used batteries	124
Traveling tips	125
Chapter 4: Exploring Your Computer's Features.....	126
Exploring the desktop	126
Finding your way around the desktop	127
Setting up for communications.....	129
Connecting the modem to a telephone line	131
Connecting your computer to a network.....	132
An overview of using the Internet	134
The Internet	135
The World Wide Web	135

Internet Service Providers.....	135
Connecting to the Internet	136
Surfing the Internet.....	136
Internet features.....	137
Uploading to, and downloading files from, the Internet	138
Exploring audio features	138
Recording sounds.....	138
Using external speakers or headphones.....	140
Using the i.LINK® port	141
Using PC Cards.....	141
Inserting a PC Card	142
Removing a PC Card	143
Setting up a PC Card for your computer	143
Using an ExpressCard™	144
Inserting an ExpressCard	144
Removing an ExpressCard	145
Using the Bridge Media Adapter Slot	146
Inserting memory media	146
Removing memory media.....	147
Chapter 5: Toshiba Utilities.....	148
TOSHIBA Assist	149
Connect.....	150
Secure.....	150
Protect & Fix	151
Optimize.....	152
TOSHIBA SD™ Memory Card Format Utility.....	153
Setting passwords	154
Using an instant password.....	154
Using a supervisor or user password	155
TOSHIBA Password Utility	157
PC Diagnostic Tool Utility	159
TOSHIBA Hotkey Utility.....	160

Mouse Utility	161
TOSHIBA Hardware Setup	162
TOSHIBA Zooming Utility	164
TOSHIBA Button Controls	165
CD/DVD Drive Acoustic Silencer	166
TOSHIBA Accessibility	167
Fingerprint Authentication Utility	168
Fingerprint utility limitations	168
Fingerprint Enrollment	168
Fingerprint Logon	170
Power-on Security	170
Control Center	172
Password Bank	174
Care and maintenance of your fingerprint sensor	178
Fingerprint sensor limitations	180
Chapter 6: If Something Goes Wrong	181
Problems that are easy to fix	181
Problems when you turn on the computer	183
The Windows® operating system is not working	185
Using Startup options to fix problems	186
Internet problems	187
The Windows® XP operating system can help you	187
Resolving a hardware conflict	188
A plan of action	188
Resolving hardware conflicts on your own	189
Fixing a problem with Device Manager	190
Memory problems	192
Power and the batteries	193
Keyboard problems	195
Display problems	196

Disk drive problems	198
CD-RW/DVD-ROM or multi-function drive problems.....	201
Sound system problems	202
PC Card problems	203
Printer problems	206
Modem problems.....	207
Wireless networking problems.....	208
DVD operating problems.....	211
Develop good computing habits	214
Data and system configuration backup in Windows XP	215
If you need further assistance	221
Before you contact Toshiba	221
Contacting Toshiba	222
Other Toshiba Internet Web sites.....	223
Toshiba's worldwide offices.....	223
Appendix A: Hot Keys.....	225
Volume Mute	225
Password security	226
Without a password	226
With a password	226
Maintaining security when the battery is not fully charged	227
Power usage	228
Standby mode.....	229
Hibernation mode	230
Display modes	231
Display brightness	232
Disabling or enabling the TouchPad or Dual Mode Pad.....	232
Zooming applications in/out	232
Keyboard hot keys	233

Appendix B: Power Cord/Cable Connectors.....	234
Appendix C: Using ConfigFree™ with your Toshiba	
Computer.....	235
Getting Started	236
Starting ConfigFree	236
ConfigFree Utilities	238
Connectivity Doctor	238
Search for Wireless Devices	241
Profile Settings	246
ConfigFree SUMMIT.....	250
Quick Connect.....	254
Using the Automatic Switch.....	257
Semi-Automatic Switch Feature	257
Glossary.....	259
Index.....	274

Introduction

Welcome to the world of powerful, portable, multimedia computing. With your Toshiba notebook computer, your work and entertainment can accompany you wherever you go.

NOTE

Certain Microsoft® software product(s) included with this computer may use technological measures for copy protection. IN SUCH EVENT, YOU WILL NOT BE ABLE TO USE THE PRODUCT IF YOU DO NOT FULLY COMPLY WITH THE PRODUCT ACTIVATION PROCEDURES. Product activation procedures and Microsoft's privacy policy will be detailed during initial launch of the product, or upon certain reinstallations of the software product(s) or reconfigurations of the computer, and may be completed by Internet or telephone (toll charges may apply).

Some software may differ from its retail version (if available), and may not include user manuals or all program functionality.

NOTE

The product specifications and configuration information are designed for a product Series. Your particular model may not have all the features and specifications listed or illustrated. For more detailed information about the features and specifications on your particular model, please visit Toshiba's Web site at pcsupport.toshiba.com.

While Toshiba has made every effort at the time of publication to ensure the accuracy of the information provided herein, product specifications, configurations, prices, system/component/options availability are all subject to change without notice. For the most up-to-date product information about your computer, or to stay current with the various computer software or hardware options, visit Toshiba's Web site at pcsupport.toshiba.com.

This guide

This guide introduces the computer's features. You can:

- ❖ Read the entire guide from beginning to end.
- ❖ Skim through and stop when a topic interests you.
- ❖ Use the table of contents and the index to find specific information.

Safety icons

This manual contains safety instructions that must be observed to avoid potential hazards that could result in personal injuries, damage to your equipment, or loss of data. These safety cautions have been classified according to the seriousness of the risk, and icons highlight these instructions as follows:

⚠ DANGER

Indicates an imminently hazardous situation which, if not avoided, will result in death or serious injury.

⚠ WARNING

Indicates a potentially hazardous situation which, if not avoided, could result in death or serious injury.

⚠ CAUTION

Indicates a potentially hazardous situation which, if not avoided, may result in minor or moderate injury.

CAUTION

Indicates a potentially hazardous situation which, if not avoided, may result in property damage.

NOTE

Provides important information.

Other icons used

Additional icons highlight other helpful or educational information:



TECHNICAL NOTE: This icon indicates technical information about the computer.



HINT: This icon indicates helpful hints and tips.



DEFINITION: This icon indicates the definition of a term used in the text.

Other documentation

Your computer comes with the following documentation:

- ❖ An electronic version of the user's guide
- ❖ It may also contain guides for other programs that may come with your system.

For accessory information, visit Toshiba's Web site at accessories.toshiba.com.

Service options

Toshiba offers a full line of optional service programs to complement its limited warranty. Toshiba's standard limited warranty, extended warranty, and service upgrade terms and conditions are available at warranty.toshiba.com.

To stay current on the most recent software and hardware options for your computer, and for other product information, be sure to regularly check the Toshiba Web site at pcsupport.toshiba.com.

If you have a problem or need to contact Toshiba, see “[If Something Goes Wrong](#)” on page 181.

Chapter 1

Getting Started

This chapter provides tips for working comfortably, summarizes how to connect components, and explains what to do the first time you use your notebook computer.

Selecting a place to work

Your computer is portable and designed to be used in a variety of circumstances and locations.

Creating a computer-friendly environment

Place the computer on a flat surface that is large enough for the computer and any other items you are using, such as a printer. Leave enough space around the computer and other equipment to provide adequate ventilation. Otherwise, they may overheat.

To keep your computer in prime operating condition, protect your work area from:

- ❖ Dust, moisture, and direct sunlight.
- ❖ Equipment that generates a strong electromagnetic field, such as stereo speakers (other than speakers that are connected to the computer) or speakerphones.
- ❖ Rapid changes in temperature or humidity and sources of temperature change such as air conditioner vents or heaters.
- ❖ Extreme heat, cold, or humidity.
- ❖ Liquids and corrosive chemicals.

Keeping yourself comfortable

The Toshiba Instruction Manual for Safety and Comfort, that shipped with your computer, contains helpful information for setting up your work environment and tips for working comfortably throughout the day.

Precautions

Your computer is designed to provide optimum safety and ease of use, and to withstand the rigors of travel. You should observe certain precautions to further reduce the risk of personal injury or damage to the computer.

- ❖ Avoid prolonged physical contact with the underside or surface of the computer.

▲ WARNING

Never allow any liquids to spill into any part of your computer, and never expose the computer to rain, water, seawater or moisture. Exposure to liquid or moisture can cause electric shock or fire, resulting in damage or serious injury. If any of these eventualities should accidentally occur, immediately:

1. Turn off the computer.
2. Disconnect the AC adapter from the power plug socket and computer.
3. Remove the battery pack.

Failure to follow these instructions could result in serious injury or permanent damage to the computer.

Do not turn on the power again until you have taken the computer to an authorized service center.

▲ WARNING

If you experience discomfort while operating the computer, stop immediately and rest. Continuous operation for long periods without adequate rest may cause pain in the arms, wrists, hands, neck or other part of the body. If pain persists despite rest, consult your doctor.

▲ CAUTION

PC base and palm rest can become hot! Avoid prolonged contact to prevent heat injury to skin.

Read the enclosed Instruction Manual for Safety and Comfort.

▲ CAUTION

Some PC Cards can become hot with prolonged use. Overheating of a PC Card can result in errors or instability in its operation.

Before you remove a PC Card, always wait for it to cool. You could get burned removing a hot PC Card.

CAUTION

Never place a heavy object on the computer and be careful not to drop a heavy object onto the computer. It could damage the computer or cause system failure.

- ❖ Never turn off the computer if a drive light indicates a drive is active.

Turning off the computer while it is reading from or writing to a disk may damage the disk, the drive, or both.

- ❖ Keep the computer and disks away from objects that generate strong magnetic fields, such as large stereo speakers.

Information on disks is stored magnetically. Placing a magnet too close to a disk can erase important files.

CAUTION

Handle discs carefully. Avoid touching the surface of the disc. Grasp it by its center hole and edge. If you handle the disc incorrectly, you could damage the disc and possibly lose data.

- ❖ Scan all new files for viruses.

This precaution is especially important for files you receive via email or download from the Internet. Occasionally, even new programs you buy from a supplier may contain a computer virus. You need a special program to check for viruses. Ask your dealer to help you.

Important information on your computer's cooling fan

Your computer may have a CPU cooling fan that cools the CPU by drawing outside air into the computer. The cooling fan may be located on the bottom of the computer.

CAUTION

To prevent possible overheating of the CPU, make sure the air intake on the cooling fan is not blocked. The fan draws in air by creating a vacuum. If the fan is blocked, it could cause the CPU to run at a lower performance level or cause the computer to shut down. Loose items such as notebook and tissue paper, plastic wrappers, or other similar materials can block the air intake, preventing air from reaching the CPU. Do not use the computer on surfaces with objects that can be drawn in by the cooling fan.

NOTE

The cooling fan location will vary depending on the computer.

Setting up your computer



TECHNICAL NOTE: You must complete all setup steps up to and including "Setting up your software" on page 44 before adding external or internal components to your computer. These components include, but are not limited to, a mouse, keyboard, printer, memory, and PC cards.

Your computer contains a rechargeable main battery that needs to be charged before you can use it.

To use external power or to charge the battery you must attach the AC adapter. See ["Connecting to a power source" on page 47](#).

To register your computer online or to sign up for an Internet account, you must either connect the built-in modem to a telephone line or establish a Local Area Network (LAN) connection. See [“Connecting the modem to a telephone line”](#) on page 131.

Setting up your software

NOTE The names of windows displayed, and the order in which windows appear, may vary according to your software setup choices.

The first time you turn on your computer, the Setup Wizard guides you through steps to set up your software.

- 1 From the welcome screen click **Next** to enter the Setup Wizard.
- 2 Confirm acceptance of Microsoft’s End User License Agreement and click **Next**.
- 3 Select the appropriate option from the Help protect your computer screen and click **Next**.
- 4 Enter the computer name and description and click **Next** or **Skip**.
- 5 Select how your computer will connect to the Internet and click **Next**.

The computer will pause for a moment while checking for an Internet connection.

If an Internet connection could not be found, a window will display the message: “An Internet connection could not be chosen.” Click **Next** to continue.

NOTE

If you are connecting your computer to a network, consult your system administrator before you choose your computer name and network settings.

- 6 Follow the remaining screen prompts to complete the setup process.

Once you click the final screen, your computer restarts automatically.

Registering your computer with Toshiba

Product registration is strongly recommended, and allows Toshiba to send the Customer periodic updates, announcements, and special offers applicable to the product. Product registration can be completed during the initial start up process of your computer. If you opt not to register at that time, you can either double-click the icon on your desktop or go to the Toshiba Web site at register.toshiba.com. Customer failure to complete Product Registration will not diminish Customer rights under this limited Warranty.

NOTE

To register online, you must be connected to the Internet via your computer's modem and a voice-grade telephone line, or by a Local Area Network.

Adding external devices

NOTE

Before adding external devices or memory, Toshiba recommends setting up your software. See [“Setting up your software” on page 44](#).

After starting your computer for the first time you may want to:

- ❖ Add more memory (see [“Adding memory \(optional\)” on page 53](#)).
- ❖ Connect a mouse (see [“Using a mouse” on page 71](#)).
- ❖ Connect a full-size keyboard (see [“Using an external keyboard” on page 70](#)).
- ❖ Connect an external monitor (see [“Using external display devices” on page 68](#)).
- ❖ Connect a local printer (see [“Connecting a printer” on page 71](#)).
- ❖ Connect an external CD/DVD drive (see [“Using the CD-RW/DVD-ROM or multi-function drive” on page 94](#)).
- ❖ Install PC Cards (see [“Using PC Cards” on page 141](#)).

Connecting to a power source

Your computer requires power to operate. Use the power cord/cable and AC adapter to connect the computer to a live electrical outlet, or to charge the computer's battery.

▲ WARNING

Never pull on a power cord/cable to remove a plug from a socket. Always grasp the plug directly. Failure to follow this instruction may damage the cord/cable, and/or result in a fire or electric shock, possibly resulting in serious injury.

▲ WARNING

When you connect the AC adapter to the computer, always follow the steps in the exact order as described in the User's Guide. Connecting the power cord/cable to a live electrical outlet should be the last step; otherwise, the adapter DC output plug could hold an electrical charge and cause an electrical shock or minor bodily injury when touched. As a general safety precaution, avoid touching any metal parts.

▲ CAUTION

Always use the Toshiba AC adapter that was provided with your computer, or use Toshiba recommended alternate models to avoid any risk of fire or other damage to the computer. Use of an incompatible AC adapter could cause fire or damage to the computer, possibly resulting in serious injury.

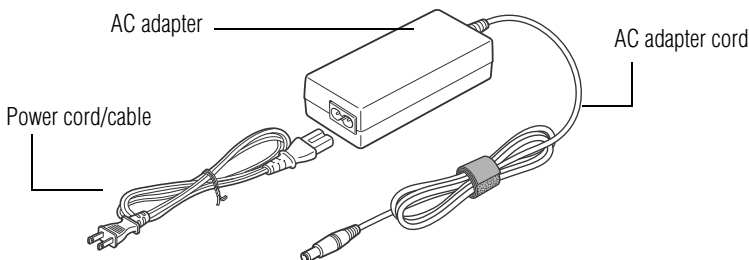

Sample power cord/cable and AC adapter

To connect AC power to the computer:

- 1 Connect the power cord/cable to the AC adapter.

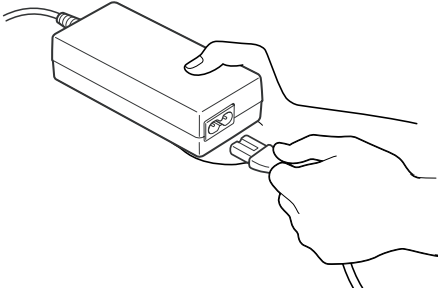

Sample connecting the power cord/cable to the AC adapter

⚠ WARNING

Handling the cord on this product will expose you to lead, a chemical known to the State of California to cause birth defects or other reproductive harm. **Wash hands after handling.**

- 2 Plug the AC adapter into the DC-IN on the back of the computer.

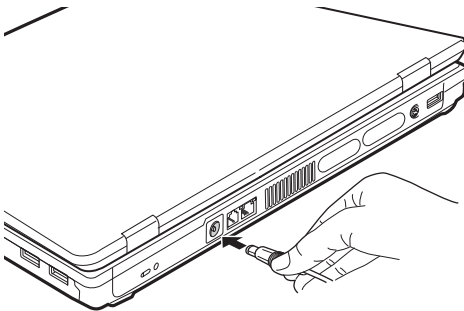

Sample connecting the AC adapter to the computer

- 3 Connect the power cord/cable to a live electrical outlet.



The AC power light on the indicator panel glows blue.

▲ WARNING

Never tamper with the cord/cable or plug; never splice or alter a cord/cable; never bend or twist a cord/cable; never place heavy objects on a cord/cable; never place a cord/cable near a heat source; never run a cord/cable through a pinch point such as a door or window; never use nails, staples or similar objects to fasten or attach cord in place; never attempt to disassemble or repair an AC adapter or a Battery Charger. Doing any of the above may damage the cables, and/or result in a fire or electric shock, possibly resulting in serious injury.

▲ WARNING

Never attempt to connect or disconnect a power plug with wet hands. Failure to follow this instruction could result in an electric shock, possibly resulting in serious injury.



The computer's main battery light gives you an indication of the main battery's current charge:

- ❖ Glows amber while the main battery is being charged (AC adapter connected)
- ❖ Glows blue when the main battery is fully charged
- ❖ Is unlit when the main battery has discharged, the battery is not charging, or the AC adapter is not plugged into the computer or AC outlet

- ❖ Flashes amber when the main battery charge is low and it is time to recharge the main battery or plug in the AC adapter
-

NOTE

If the AC power light flashes amber during charging, either the main battery is malfunctioning, or it is not receiving correct input from the AC power supply.

Disconnect the AC power cord/cable and remove the main battery pack. See [“Changing the main battery” on page 118](#) for information on replacing the main battery.

Using the main battery

Your computer came with its main battery already installed. Before using the main battery to power the computer you must first charge it.

To charge the main battery, leave the computer plugged into a live wall outlet for several hours with the computer turned off. After that, the main battery will be completely charged and ready to power the computer.



TECHNICAL NOTE: The RTC battery does not charge while the computer is turned off, even when AC power is attached.

The RTC battery charges when the computer is powered on.

For more information about installing or removing the main battery, see [“Changing the main battery” on page 118](#).

Using the computer for the first time

The computer is now ready for you to turn it on and begin using it.

Opening the display panel

- 1 Slide the display latch to the right.
- 2 Lift the display panel.

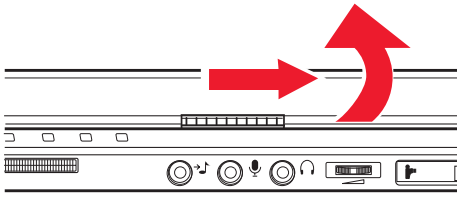

Sample opening the display panel

CAUTION

To avoid damaging the display panel, do not force it beyond the point where it moves easily and never lift the computer by the display panel.

Small bright dots may appear on your screen display when you turn on your PC. Your display contains an extremely large number of thin-film transistors (TFT) and is manufactured using high-precision technology. Any small bright dots that may appear on your display are an intrinsic characteristic of the TFT manufacturing technology. Over a period of time, and depending on the usage of the computer, the brightness of the screen will deteriorate. This is also an intrinsic characteristic of the screen technology. When the computer is operated on battery power, the screen will dim and you may not be able to increase the brightness of the screen while on battery power.

Your computer's features and specifications

Certain notebook chassis are designed to accommodate all possible configurations for an entire product Series. Your select model may not have all the features and specifications corresponding to all of the icons or switches shown on the notebook chassis, unless you have selected all those features.

This information applies to all the features and icons described in this guide.

Below are examples of some of the many possible icons used on your computer:



Sample system icons

Turning on the power

To turn on the computer:

- 1** Make sure any external devices (such as the AC adapter, if you plan to use AC power rather than battery power) are properly connected and ready.
- 2** Check to ensure that all drives are empty.



- 3 Press and hold the power button in until the on/off light on the system indicator panel glows blue—about one second.

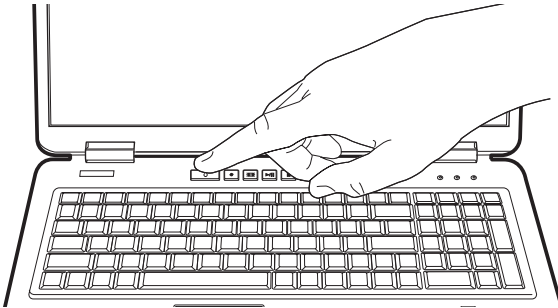

Sample turning on the power

The preinstalled operating system will load automatically.

CAUTION

When you turn on the computer for the first time, do not turn off the power again until the operating system has loaded completely.

Adding memory (optional)



HINT: To purchase additional memory modules, see the accessories information packaged with your system or visit accessories.toshiba.com.

Your computer comes with enough memory to run most of today's popular applications. You may want to increase the computer's memory if you use complex software or process large amounts of data.

For more information on memory options, check the accessories information that came with your computer, or visit accessories.toshiba.com.

NOTE

Before adding external devices or memory, Toshiba recommends setting up your software. See “Setting up your software” on page 44.

Installing a memory module

Additional memory modules can be installed in the memory module slots on the base of the computer. You will need a standard Phillips No. 1 screwdriver for this procedure.

CAUTION

If you use the computer for a long time, the memory module will become hot. If this happens, let the module cool to room temperature before you replace it.

CAUTION

To avoid damaging the computer's screws, use a standard Phillips No. 1 screwdriver that is in good condition.

CAUTION

Installing a memory module with the computer's power on may damage the computer, the module, or both.

The computer has two memory module slots. You can install one or two memory modules.

CAUTION

Before you install or remove a memory module, turn off the computer using the Start menu. If you install or remove a memory module while the computer is in Standby or Hibernation mode, data will be lost.

If the computer is on, begin at step 1; otherwise, skip to step 3.

- 1 If the computer is on, click **Start, Turn off** (or Shut Down, depending on the system).

The Turn off computer window appears.

- 2 Click **Turn Off**.

The operating system turns off the computer.

- 3 Unplug and remove any cables connected to the computer, including the AC adapter.

- 4 Remove the main battery. For information on removing the main battery, see [“Changing the main battery”](#) on page 118.

- 5 Close the display panel and turn the computer upside down to locate the memory module slot cover.

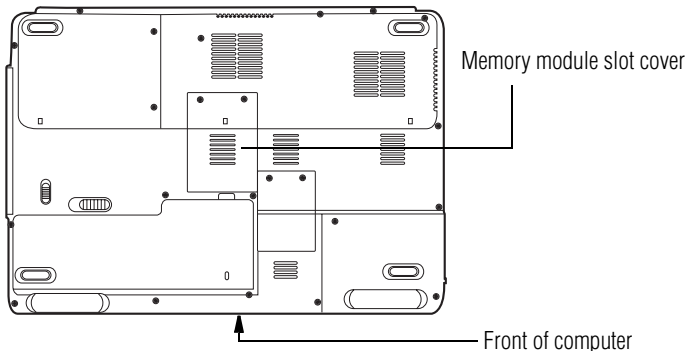

Sample locating the memory module slot cover

-
- Using a standard Phillips No. 1 screwdriver, unscrew the screw that secures the memory module slot cover.

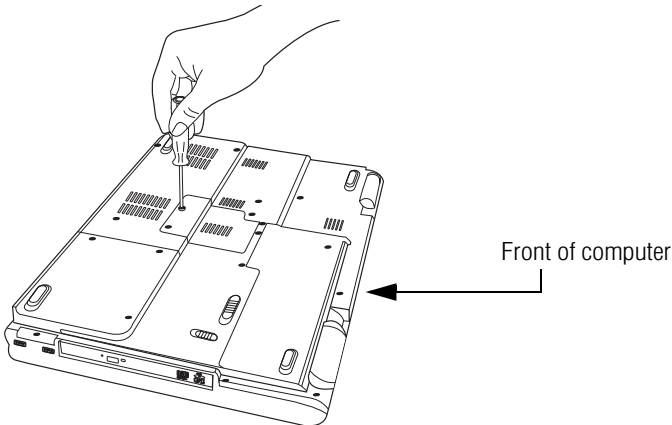

Sample unscrewing the memory module slot cover

- Remove the memory slot cover.
- Place the screw and the cover in a safe place so that you can retrieve them later.

CAUTION

Static electricity can damage the memory module. Before you handle the module, touch a grounded metal surface to discharge any static electricity you may have built up.

To avoid damaging the memory module, be careful not to touch its pin connector on the side you insert into the computer.

-
- Remove the new memory module from its antistatic packaging.

CAUTION

Avoid touching the connectors on the memory module or on the computer. Grease or dust on the connectors may cause memory access problems.

- 10 Insert the memory module into the socket on the underside of the computer.

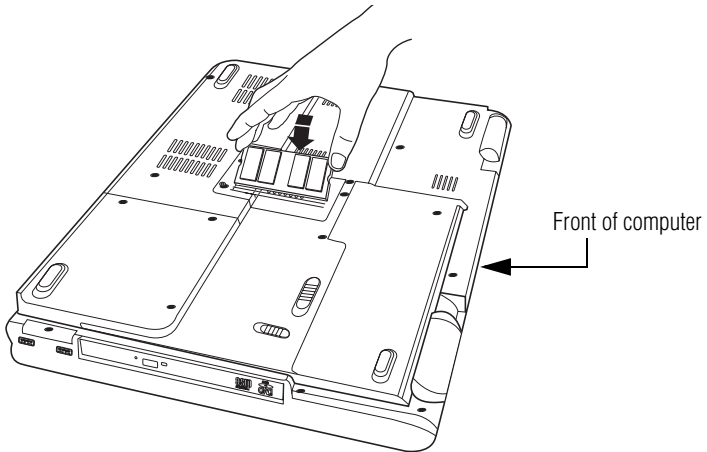

Sample inserting the memory module into the slot

- 11 Hold the memory module by its edges so that the gold connector bar faces the slot, at approximately a 45° angle to the socket.

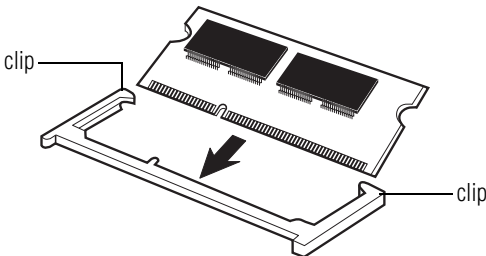

Sample inserting the memory module into the socket

- 12 Check that the module is inserted completely into the socket and lined up squarely with the socket clip.

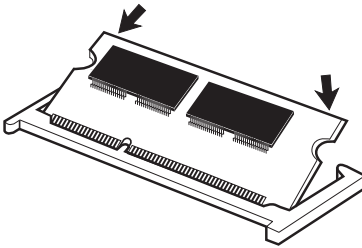

Sample aligning the module into the socket

- 13** Gently press down on the memory module connector until the clips snap into place.

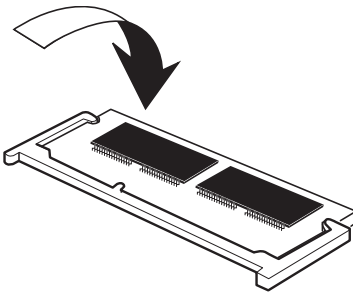

Sample pressing down on the memory module

Do not force the memory module into position. The memory module should be completely inserted into the socket and level when secured in place.

The clips on either side of the memory module snap into place when the memory module is properly inserted.

- 14** Replace the memory module slot cover and tighten the screw.
- 15** Re-insert the main battery. For more information on inserting the main battery, see [“Changing the main battery”](#) on page 118.
- 16** Turn the computer right side up.
- 17** Reconnect the cables.

18 Restart the computer.

TECHNICAL NOTE: You must have at least one memory module installed for the computer to work.

You can now continue setting up the computer. When the operating system has loaded, you can verify that the computer has recognized the additional memory module.

If you are adding an extra memory module after setting up the computer, verify that the computer has recognized it correctly as described in [“Checking total memory” on page 61](#).

Removing a memory module

If you need to remove a memory module:

- 1 Complete steps 1–8 in [“Installing a memory module” on page 54](#) to shut down the computer and open the memory module slot cover.

CAUTION

Do not try to remove a memory module with the computer turned on. You can damage the computer and the memory module.

Do not remove the memory module while the computer is in Standby or Hibernation mode. The computer could hang up the next time you turn it on and data in memory will be lost. In either of the above cases, the Standby configuration will not be saved.

The following message appears when you turn on the power:

Warning: Resume Failure
Press Any Key To Continue

If the computer hangs up when you turn it on, perform the following: Press the power button and hold it down for at least ten seconds, then turn the power on again.

- 2 Pull the clips away from the memory module.
The memory module pops up slightly.
- 3 Gently lift the memory module to a 45 degree angle and slide it out of the slot.

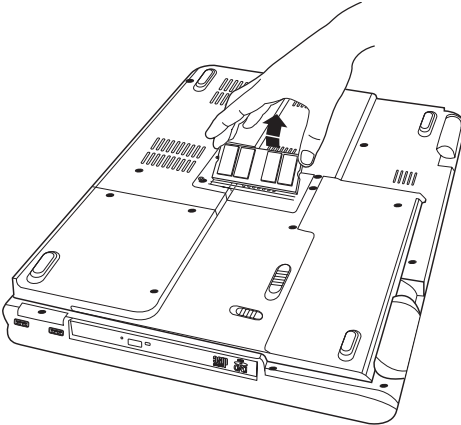
*Sample removing the memory module*

- 4 Replace the memory module slot cover and tighten the screw.
- 5 Re-insert the main battery. For more information on inserting the main battery, see [“Changing the main battery”](#) on page 118.
- 6 Turn the computer right side up.
- 7 Reconnect the cables.
- 8 Restart the computer.



TECHNICAL NOTE: You must have at least one memory module installed for the computer to work.

Checking total memory

When you add or remove a memory module, you can check that the computer has recognized the change. To do this:

- 1 Click **Start, Control Panel, Performance and Maintenance**, and then **System**.
- 2 The **General** tab view automatically appears and shows total memory.

If the computer does not recognize the memory configuration, turn off the computer, remove the memory slot cover, and check that the module is inserted completely into the socket and lined up squarely with the socket clips.

Using the TouchPad™

The TouchPad, the small, smooth square cutout located in front of the keyboard, is sensitive to touch and enables you to move the cursor with the stroke of a finger. Simply move your finger on the TouchPad in the direction you would like to move the cursor:

- ❖ To move the cursor to the top of the page, push your finger forward on the TouchPad.
- ❖ To move the cursor to the bottom of the page, drag your finger toward yourself.
- ❖ To move the cursor to the right side of the page, slide your finger across the TouchPad from left to right.
- ❖ To move it to the left side, slide your finger from right to left.

NOTE

Because the TouchPad is much smaller than the display screen, moving your cursor across the screen often means having to move your finger several times across the TouchPad in the preferred direction.

Once you have positioned your cursor, you can click it into place by either double-tapping the TouchPad or clicking the control buttons.

Scrolling with the TouchPad™

There are two active regions on the TouchPad that allow you to scroll as you would with any wheel device on a mouse or trackball.

To scroll vertically, run your finger up or down along the right edge of the TouchPad. To scroll horizontally, run your finger along the bottom edge of the TouchPad. This feature can be disabled or changed in the Mouse Properties dialog box.

Control buttons

When a step instructs you to click or choose an item, move the cursor to the item, then press and release the primary (left-hand) button. To double-click, press the primary button twice in rapid succession. The primary button usually corresponds to the left mouse button.

The function of the secondary (right-hand) button depends on the program you are using. It usually corresponds to the right mouse button. Check your program's documentation to find whether it uses the right mouse button.

Disabling or enabling the TouchPad

The TouchPad is enabled by default. To change the enable/disable TouchPad setting:

- 1 Click **Start**, and then **Control Panel**.
The Control Panel window appears.
- 2 Click **Printers and Other Hardware**.
- 3 Click the **Mouse** icon.
- 4 Click the **TouchPAD ON/OFF** tab.

The TouchPAD ON/OFF tab view window appears.

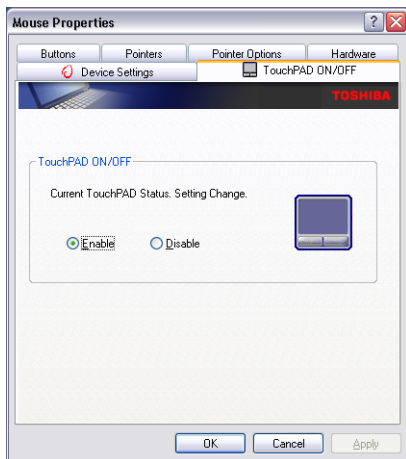

Sample TouchPAD ON/OFF screen

- 5 Select **Disable** or **Enable**, whichever is appropriate.
- 6 Click **Apply**.
- 7 Click **OK**.

The Mouse Properties window closes.

- 8 Close the Printers and Other Hardware window.
- 9 Close the Control Panel window.

You can also use a hot key to disable or enable the TouchPad. See “Disabling or enabling the TouchPad or Dual Mode Pad” on page 232.

Using the Dual Mode Pad

(Available on certain models)

The Dual Mode Pad (available on certain models), the small square cutout located in front of the keyboard, is sensitive to touch. To move the cursor, simply move your finger on the Dual Mode Pad in the direction you would like to move the cursor:

- ❖ To move the cursor to the top of the page, push your finger forward on the Dual Mode Pad.
- ❖ To move the cursor to the bottom of the page, drag your finger toward yourself.
- ❖ To move the cursor to the right side of the page, slide your finger across the Dual Mode Pad from left to right.
- ❖ To move it to the left side, slide your finger from right to left.

NOTE

Because the Dual Mode Pad is much smaller than the display screen, moving your cursor across the screen often means having to move your finger several times across the Dual Mode Pad in the desired direction.

You can avoid this by enabling EdgeMotion™. When this feature is enabled, the cursor continues moving when your finger reaches the edge of the Dual Mode Pad, and stops moving when you lift your finger. EdgeMotion™ can be enabled or changed in the Mouse Properties dialog box.

Once you have positioned your cursor, you can either click it into place by double-tapping the Dual Mode Pad or clicking the control buttons.

Scrolling with the Dual Mode Pad

There are two active regions on the Dual Mode Pad that allow you to scroll as you would with any wheel device on a mouse or trackball.

To scroll vertically, run your finger up or down along the right edge of the Dual Mode Pad. To scroll horizontally, run your finger along the bottom edge of the Dual Mode Pad.

The Dual Mode Pad also supports coasting, which helps you to scroll easily through long documents. When coasting is enabled, scrolling continues after you lift your finger from the Dual Mode Pad, then stops when you touch the Dual Mode Pad surface again.

The scrolling and coasting features can be disabled or changed in the Mouse Properties dialog box.

Using the Control buttons

When a step instructs you to click or choose an item, move the cursor to the item, then press and release the primary (left-hand) button. To double-click, press the primary button twice in rapid succession. The primary button usually corresponds to the left mouse button.

The function of the secondary (right-hand) button depends on the program you are using. It usually corresponds to the right mouse button. Check your program's documentation to determine if it uses the right mouse button.

Using Tap Zones

The four corners of the Dual Mode Pad are called tap zones. You can configure each tap zone to perform one of the following actions when tapped:

- ❖ Open the Start Menu
- ❖ Open the current application's menu
- ❖ Minimize the current application

- ❖ Maximize the current application
- ❖ Run a program of your choice

Tap zones can be enabled or changed in the Mouse Properties dialog box.

Using the Virtual Buttons

The Dual Mode Pad has six virtual buttons and a volume control bar. Each virtual button can be configured to start an application. The volume control bar is used to adjust the system volume level.

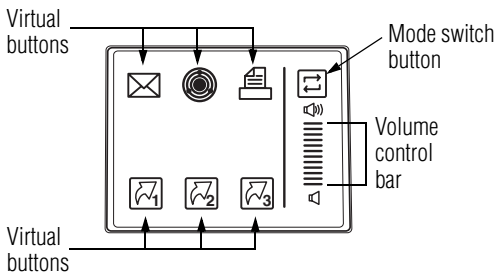

Sample Virtual buttons on the Dual Mode Pad

The virtual buttons at the top of the Dual Mode Pad have the following default settings:

- ✉ ❖ Left button: Opens the default email application
- 🎯 ❖ Middle button: Opens the ConfigFree utility
- 🖨️ ❖ Right button: Prints the active window

The other three virtual buttons have no default settings. You must configure these buttons before they can be used.

In order to use the virtual buttons you must first enable dual mode. After that, you use the virtual buttons as follows:

- 1** Tap the mode switch button to enable the virtual buttons.

- 2 Tap the virtual button assigned to the application you wish to launch, or slide your finger on the volume control bar to adjust the volume to the desired level.
- 3 When the operation is complete, the Dual Mode Pad automatically disables the virtual buttons.

The virtual buttons cannot be used until the mode switch button is tapped again.

The virtual buttons and dual mode can be enabled or changed in the Mouse Properties dialog box.

Disabling or enabling the Dual Mode Pad

The Dual Mode Pad is enabled by default. To change the Dual Mode Pad setting:

- 1 Click **Start, Control Panel**.
The Control Panel window appears.
- 2 Click **Printers and Other Hardware**.
- 3 Click **Mouse Properties**.
The Mouse Properties window appears.
- 4 Click the **Dual Mode Pad ON/OFF** tab.
The Dual Mode Pad ON/OFF tab appears.
- 5 Select **Disable** or **Enable**, whichever is appropriate.
- 6 Click **Apply**.
- 7 Click **OK**.
The Mouse Properties window closes.
- 8 Close the Printers and Other Hardware window.

-
- 9 Close the Control Panel window.
-

NOTE

The Fn + F9 shortcut can be used to disable or enable the Dual Mode Pad (see [“Disabling or enabling the TouchPad or Dual Mode Pad”](#) on page 232).

Using external display devices

Your computer comes with a built-in LCD display, but you can also connect an external display device to the available video ports:

- ❖ An external monitor or projector via the RGB (monitor) port.
- ❖ A standard television, projector, or VCR/DVD recorder/player via the S-video Out port.
- ❖ A projector or a monitor via the DVI video port (DVI video port is available on some models).

NOTE

DVI stands for Digital Visual Interface, and is a standard for connecting computers to digital monitors.

Before connecting a television, video projector, monitor or other external display device, configure your computer for the type of device you are connecting. To do this, refer to the documentation for your operating system and the device.

Connecting an external monitor or projector

You can easily attach an external monitor or projector to your computer if you need a larger screen. To do this:



- 1 Connect the monitor's video cable to the RGB (monitor) port on the back of the computer.
- 2 Connect the device's power cable to a live electrical outlet.

- 3 Turn on the external device.
- 4 Set the display mode by pressing Fn + F5, or by configuring the Display Properties settings.

Directing the display output when you turn on the computer

Once you have connected an external display device, you can choose to use the internal display only, the external device only, or both simultaneously. The quickest way to change the display output settings is to use the display hot key (Fn + F5):

- 1 Press Fn and F5 simultaneously.
- 2 While holding down Fn, press F5 repeatedly until the setting you want takes effect. Briefly pause each time you press the F5 key to allow time for the display to change.

This hot key cycles through the settings in the following order:

- ❖ Built-in display only
- ❖ Built-in display and external monitor simultaneously
- ❖ External monitor only
- ❖ TV
- ❖ TV and built-in display
- ❖ DVI appears if you have a projector or a monitor connected to the DVI video port (DVI is available on some models)

3 Release the Fn key.

TECHNICAL NOTE: You can also change these settings using the Display Properties Box.

Set the option for the video controller by clicking Start, Control Panel, Appearance and Themes, and then Display. Choose the Settings tab, click the Advanced button, select Display Device, select the applicable Monitor type, and click Apply or OK.

Adjusting the quality of the external display

To obtain the best picture quality from your television (or other video display device), you may need to adjust the video settings. See the video device documentation for additional configuration steps.



TECHNICAL NOTE: To use one of the simultaneous modes, you must set the resolution of the internal display panel to match the resolution of the external display device. The external display device must support a resolution of 800 X 600 or higher.

Using an external keyboard

If you prefer to use a full-size keyboard, you can attach one to your computer. The computer's USB ports support any USB-compatible keyboard.

Using a mouse

You may want to use a mouse instead of the computer's built-in Dual Mode Pad. You can use a USB-compatible mouse.

NOTE

After logging on to your system, the mouse cursor may move to the upper-right side of the screen. If this occurs, push the Esc or Windows key to return it to its original position.

Connecting a printer

NOTE

Your printer documentation may require you to install the printer software before physically connecting the printer to your computer. If you do not install the software as instructed by the printer manufacturer, the printer may not function correctly.

Read the documentation that came with your printer. Follow the manufacturer's instructions when connecting a local printer.

You can connect a USB-compatible printer to your computer through the USB ports. To determine if the printer is USB-compatible, check its documentation.

To make the connection, you need a suitable USB cable which may come with your printer. If a USB cable was not included with your printer, you can purchase one from a computer or electronics store.

If your printer supports Plug and Play, your computer will automatically recognize the printer; the printer is then ready for use. Refer to your printer documentation for further instructions.



TECHNICAL NOTE: To determine if your printer supports Plug and Play, check its documentation.

If your printer does not support Plug and Play, you must set up the printer as described in the “[Setting up your printer](#)” on page 72.

To connect a USB printer to your computer:



- 1 Connect the printer cable to the printer and then connect the other end to one of the computer’s USB ports.
- 2 Plug the printer’s power cable into a live electrical outlet.

Setting up your printer

NOTE

Some printers require a specific installation process. Refer to your printer installation guide for instructions before completing the following procedure.

If your printer does not support Plug and Play, follow these steps to set it up for the first time. You only need to set up the printer once.

- 1 Click **Start, Printers and Faxes**.

The Printers and Faxes window appears.

- 2 Click **Add a printer**.

The Add Printer Wizard appears.



Sample Add Printer Wizard

- 3 Follow the on-screen instructions to set up your printer.

Connecting an optional external diskette drive

Some operations, such as creating a password service diskette, require a diskette drive designed for use with 3.5-inch diskettes.

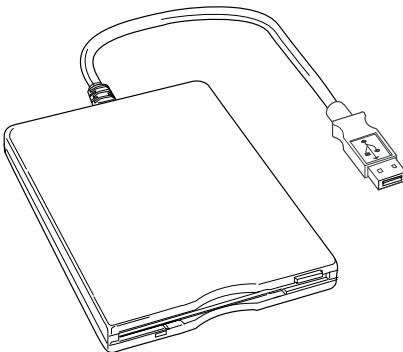

Sample optional external USB diskette drive

To connect an optional external USB diskette drive, connect the cable to one of the computer's USB ports.

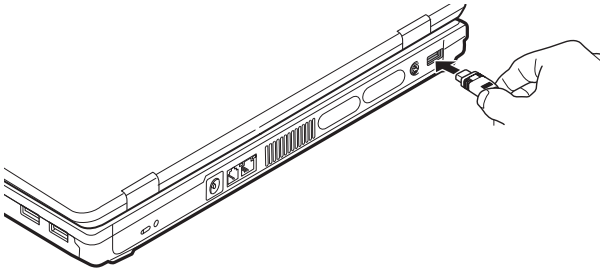

Sample connecting an optional external USB diskette drive

Turning off the computer

CAUTION

Pressing the power button before shutting down the Windows® operating system could cause you to lose your work. Make sure the system indicator panel's disk light and the drive-in-use light are off. If you turn off the power while a disk is being accessed, you may lose data or damage the disk and/or drive.

It is a good idea to turn off your computer when you are not using it for a while.

If you are using the computer for the first time, leave the computer plugged into a power source (even though the computer is off) to fully charge the main battery.

Options for turning off the computer

Depending on the operating system installed, you have up to four options when you turn off the computer: Turn Off or Shut Down, Hibernate, and Standby. Each option has its advantages.

Turn Off or Shut Down

Factors to consider when choosing either Turn Off or Shut Down:

- ❖ Use the Turn Off command if you are using Windows® XP Home, or either Windows® XP Professional or Windows® XP Media Center Edition (MCE) and are not connected to a domain server.
- ❖ Use the Shut Down command if you are using Windows® XP Professional or Windows® XP Media Center Edition (MCE) and are connected to a domain server.
- ❖ If you have work in progress and are not connected to a network, use the Windows® Standby or Hibernate commands to save your system settings so that when you turn on the computer again, you will automatically return to where you left off.



TECHNICAL NOTE: Before using any of these options to shut down or turn off your computer, save your files and make sure the disk activity lights are off.

If you change your mind and decide to continue working after all, wait a few seconds before turning the computer on again.

Hibernation mode

Hibernation mode shuts the computer down completely, but it first saves the current state of the computer to the hard disk. Since Hibernation mode does not require power to maintain the saved information, system settings are retained indefinitely.

Factors to consider when choosing Hibernation:

- ❖ While in Hibernation mode, the computer uses no main battery power.

- ❖ Because the state of the system is stored on the hard disk, no data is lost if the main battery discharges.
- ❖ When starting up again, Hibernation takes less time and consumes less main battery power than does turning off the computer.
- ❖ Since information is being retrieved from the hard disk rather than from memory, restarting from Hibernation takes a little more time and consumes more main battery power to start up than when restarting from Standby.
- ❖ When starting up again, the computer returns to the state in which you left it, including all open programs and files you were using.

For information on placing your computer into, and configuring your computer for, Hibernation mode see [“Using and configuring Hibernation mode”](#) on page 78.

Standby mode

The Standby command places the computer into a power-saving mode. Standby holds the current state of the computer in system memory (RAM) so that, when you restart the computer, you can continue working from where you left off.

Factors to consider when choosing Standby:

- ❖ While in Standby mode, the computer uses some main battery power.
- ❖ The Standby command does not store unsaved information on your hard disk. You should save your work before putting your computer on Standby.
- ❖ Restarting from Standby takes less time and consumes less main battery power than restarting from turning off the computer or using Hibernation mode.

- ❖ When starting up again, the computer returns to the mode in which you left it, including all open programs and files you were using.

CAUTION

If you power down using the Standby command and the main battery discharges fully, your unsaved information will be lost. Be sure to save your work first.

For information on using Standby, see “Using and configuring Standby mode” on page 79.

Using the Turn Off Computer or Shut Down commands

Depending on the operating system installed, use the following steps to turn off your computer.

Turn Off

For Windows® XP operating system when not connected to a domain server, follow these steps to turn off the computer:

- 1 Click **Start**, select **Turn off computer**.

The Turn off computer dialog box appears.

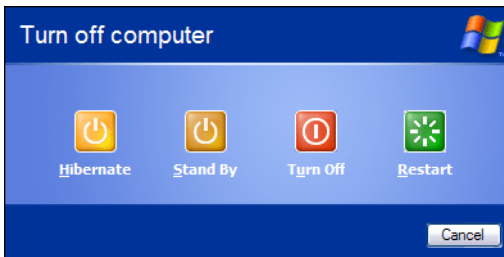

Sample Turn off computer Windows® dialog box

- 2 Click **Turn Off**.

The computer shuts down completely.

Shut Down

For Windows® XP Professional or Windows® XP MCE when connected to a domain server, follow these steps to turn off the computer:

- 1 Click the **Start** button, then **Shut down**.

The Shut Down Windows® dialog box appears.

- 2 Select **Shut down** from the drop-down list.
- 3 Click **OK**.

The computer shuts down completely.

Restarting your computer

To start the computer up again, press the power button until the on/off light glows blue.

If you turn off the computer by closing the display panel, you can start it again by opening the display panel.

Using and configuring Hibernation mode

To turn off the computer using the Hibernation command, click **Start**, **Turn off computer**, and select **Hibernate**.

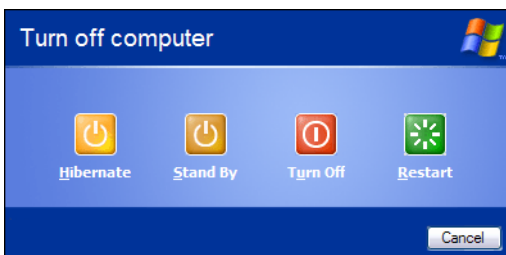

Sample Turn off computer Windows® dialog box

The computer saves the state of all open programs and files, turns off the display, and then turns off.

Configuring Hibernation mode options

You can place the computer into Hibernation mode by either pressing the power button or closing the display panel. You can also specify an amount of time after which the computer automatically goes into Hibernation mode.

To use any of these methods, you first need to enable them in the Power Options Properties window. For information on configuring the power options, see [“Power Schemes” on page 116](#).

Once the computer is configured, you can place it into Hibernation mode by either pressing the power button or closing the display panel, depending on the Hibernation options set.

Starting again from Hibernation mode

To start up the computer from Hibernation mode, press the power button until the on/off light glows blue. The computer returns to the screen(s) you were using.

If you put the computer in Hibernation mode by closing the display panel, you can start it again by opening the display panel.

Using and configuring Standby mode

To turn off the computer using the Standby command, click **Start, Turn off computer**, and select **Stand By**.

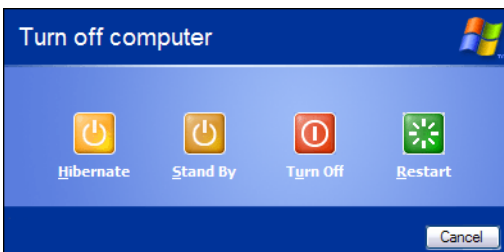

Sample Turn off computer Windows® dialog box

The computer saves the status of all open programs and files, turns off the display, and enters into a low-power mode. The on/off light blinks amber indicating the computer is in Standby mode.

Configuring Standby mode options

You can place the computer into Standby mode by either pressing the power button or closing the display panel. You can also specify an amount of time after which the computer automatically goes into Standby mode.

To use any of these methods, you first need to enable them in the Power Options Properties window. For information on configuring the power options, see [“Power Schemes” on page 116](#).

Once the computer is configured, you can place it into Standby mode by either pressing the power button or closing the display panel, depending on the Standby options set.

Starting again from Standby mode

To start up the computer from Standby mode, press the power button until the on/off light glows blue. The computer returns to the screen(s) you were using.

If you place the computer in Standby mode by closing the display panel, you can start it again by opening the display panel.

Closing the display panel

After you have turned off the computer, close the display panel to keep dust and dirt out of the computer.

Caring for your computer

This section gives tips on cleaning and moving your computer. For information about taking care of your computer's battery, see “Running the computer on battery power” on page 105.

Cleaning the computer

CAUTION Keep liquids, including cleaning fluid, out of the computer's keyboard, speaker grille, and other openings. Never spray cleaner directly onto the computer. Never use harsh or caustic chemical products to clean the computer.

To keep your computer clean, gently wipe the display panel and exterior case with a lightly dampened cloth.

Moving the computer

Before moving your computer, even across the room, make sure all disk activity has ended (the drive in-use light stops glowing) and all external peripheral cables are disconnected.

CAUTION Do not pick up the computer by its display panel or by the back (where the ports are located). Doing so could damage the system.

Using a computer lock

You may want to secure your computer to a heavy object such as your desk. The easiest way to do this is to purchase an optional computer lock cable. For more information on purchasing a cable lock, visit accessories.toshiba.com.

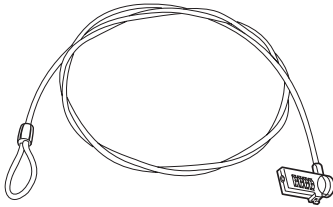

Sample computer lock cable

To secure the computer:

- 1** Wrap the cable through or around some part of a heavy object.

Make sure there is no way for a potential thief to slip the cable off the object.

- 2** Pass the locking end through the loop.



- 3** Insert the cable's locking end into the security lock slot on the back of your computer, then engage the locking device.

The computer is now securely locked.

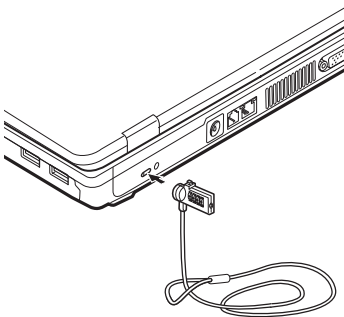

Sample locking the computer

Chapter 2

Learning the Basics

This chapter gives some computing tips and provides important information about basic features.

Computing tips

- ❖ Save your work frequently.

Your work stays in the computer's temporary memory until you save it to the disk. If the network you are using goes down and you must restart your computer to reconnect, or your battery runs out of charge while you are working, you will lose all work since you last saved.

See [“Saving your work” on page 90](#) for further information.



HINT: Some programs have an automatic save feature that can be activated. This feature saves your file to the hard disk at preset intervals. See your software documentation for details.

- ❖ Back up your files to disks (or other removable media) on a regular basis. Label the backup copies clearly and store them in a safe place.

It is easy to put off backing up because it takes time. However, if your hard disk suddenly fails, you will lose all the data on it unless you have a separate backup copy.

- ❖ Use Error-checking and Disk Defragmenter regularly to conserve disk space and improve performance.
- ❖ Scan all new files for viruses.
- ❖ This precaution is especially important for files you receive via diskette, email, or download from the Internet.
- ❖ Take frequent breaks to avoid repetitive-motion injuries and eyestrain.
- ❖ Do not turn off the computer if a drive indicator light indicates a drive is active.

Turning off the computer while it is reading from or writing to a disk may damage the disk, the drive, or both.

- ❖ Before turning off the computer, use the Turn off computer command or Standby command. See [“Turning off the computer” on page 74](#) to learn more about Standby.

NOTE

The Windows® XP operating system records information, such as your desktop setup, during its shutdown procedure. If you do not let the Windows® XP operating system shut down normally, details such as new icon positions may be lost.

Using the keyboard

Your computer's keyboard contains character keys, control keys, function keys, and special Windows® keys, providing all the functionality of a full-size keyboard.

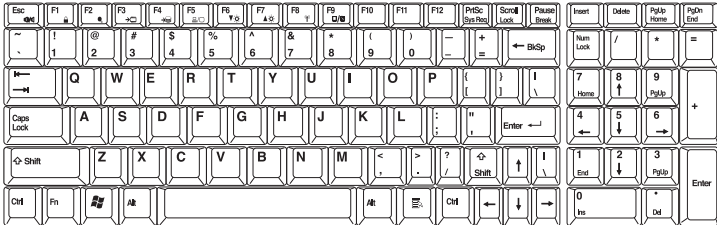

Sample keyboard

Character keys

Typing with the character keys is very much like typing on a typewriter, except that:

- ❖ The space bar creates a space character instead of just passing over an area of the page.
- ❖ The lowercase letter l (el) and the number 1 are not interchangeable.
- ❖ The uppercase letter O and the number 0 are not interchangeable.

Ctrl, Fn, and Alt keys



Sample Ctrl, Fn, and Alt keys

The Ctrl, Fn, and Alt keys do different things depending on the program you are using. For more information, see your program documentation.

Function keys

The function keys (not to be confused with the Fn key) are the 12 keys at the top of the keyboard.



Sample function keys

F1 through F12 are called function keys because they execute programmed functions when pressed. Used in combination with the Fn key, function keys marked with icons execute specific functions on the computer. For example, Fn+F9 turns off the Dual Mode Pad. For more information, see [“TOSHIBA Hotkey Utility”](#) on page 160, or [“Hot Keys”](#) on page 225.

Windows special keys



Sample Windows special keys

Your computer’s keyboard has two keys that have special functions in Windows:

- ❖ **Windows key**—Opens the Start menu
- ❖ **Application key**—Has a similar function as the secondary mouse button

Starting a program

The easiest way to start a program is to double-click the name of the file that contains the information you want to work on. To find the file, use My Computer or Windows® Explorer.

If you prefer to open the program first, you have four options. You can:

- ❖ Double-click the icon for the program on your desktop
- ❖ Use the Start menu
- ❖ Use Windows® Explorer or My Computer to locate the program file
- ❖ Use the Run dialog box

The next three sections explain how to start a program from the Start menu, Explorer and the Run dialog box.

Starting a program from the Start menu

When you install a program, the operating system usually puts an icon in the All Programs menu. To start a program that has an icon in the All Programs menu, follow these steps, which use the Windows® WordPad program as an example:

- 1** Click **Start**, then **All Programs**.

The Windows® XP operating system displays the All Programs menu, which lists programs and program groups. If your program is listed, go to step 3, otherwise, continue with step 2.

- 2** Point to the program group, in this example, **Accessories**. The Accessories menu is displayed.

If a program is not listed in the All Programs menu, you can start it from Windows® Explorer. Windows® Explorer gives you a view of your computer's contents as a hierarchy or "tree." You can easily see the content of each drive and folder on your computer. To use this method, you should know the file name and location of the program's executable file (this file ends with .exe).

- 3 Click the program, in this example, **WordPad**.

WordPad opens.



To close the program, click the **Close** button in the upper-right corner of the program's window.

Starting a program from Windows® Explorer

If a program is not listed in the All Programs menu, you can start it from Windows® Explorer. Windows® Explorer gives you a view of your computer's contents as a hierarchy or "tree." You can easily see the contents of each drive and folder on your computer. To use this method, you should know the file name and location of the program's executable file (this file ends with .exe).

This example opens WordPad using Windows Explorer.

- 1 Click **Start**, then **All Programs**.
- 2 Click **Accessories**.
- 3 Click **Windows Explorer**.
- 4 Click **My Computer** to expand the window.
- 5 In the left part of the window, click the line that ends in "(C:)."
- 6 In the left part of the window, under the C: icon, double-click the folder containing the program, in this case **Program Files**.

Windows® Explorer shows the contents of the Program Files folder on the right side of the window. The left side of the window shows all the folders contained within the Program Files folder.

7 In the left part of the window, click **Windows NT**.

8 Click **Accessories**.

Windows® Explorer shows the contents of the **Accessories** folder on the right side of the window.

9 In the right part of the window, double-click **WordPad**.

The operating system opens WordPad.

 To close the program, click the **Close** button in the upper-right corner of the program's window.

Starting a program from the Run dialog box

This example uses the Run command to start WordPad:

1 Click **Start**, then **Run**.

The Run dialog box appears.

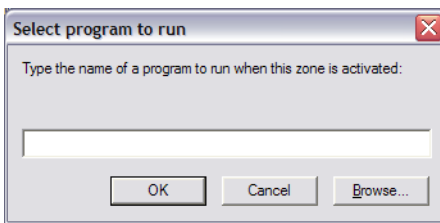

Sample Run dialog box

2 In the Run dialog box:

- ❖ For a program in the Windows® NT folder, type just the program name. Otherwise, if you know the program's location, type the full file path. Then click **OK**.

-
- ❖ If you do not know the program's location, you can search for it by clicking **Start**, and then **Search**. When the Search screen displays, follow the displayed instructions.

- 3 Type WordPad in the **Open** text box and press Enter.



HINT: To run the same program again, click the arrow to the right of the text box and select the command line from the drop-down list.

Saving your work

Before you turn off the computer, save your work on the hard disk drive or diskette/CD. This is one of the most important rules of computing.



TECHNICAL NOTE: Save your data even when you are using the Standby command, in case the main battery discharges before you return to work.

Saving documents is quick and easy, so it is a good idea to get in the habit of saving frequently.

Many programs offer a feature that saves documents at regular intervals. Check your program's documentation to see if it has an automatic save feature.

Saving files

- 1 On the **File** menu of your Windows® program, click **Save**.

If you are working with a document that already has a file name, this is all you need to do. If you created a new document, your program displays a Save As dialog box.

Use this dialog box to specify where to store the document and to give it a file name.

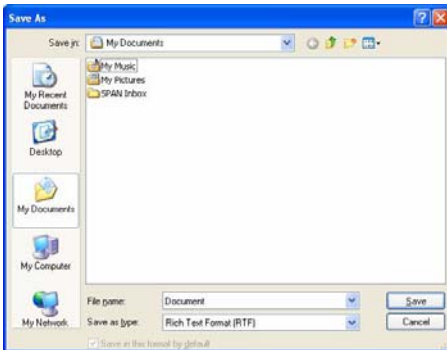

Sample Save As dialog box

- 2 Choose the drive and folder where you want your file to be stored.
- 3 Type a file name, then click **Save**.



HINT: To make another copy of the file you are currently working with, choose Save As from the File menu and give the new file a different name.

File names

The Windows XP operating system supports long file names which can contain up to 255 characters and can include spaces. Some applications do not support long file names and require file names limited to no more than eight characters.

You may use all the letters and numbers on the keyboard plus these characters: _ ^ \$ ~ ! # % & { } () @ and '. File names are not case-sensitive.

Using a file extension

Most programs assign an extension to the file name that identifies the file as being created in the program with a particular format. For example, Microsoft Word saves files with a .doc extension. Any file name with an extension of “.doc” is assumed to be a Microsoft Word file. Creating your own extension is usually unwise, since the program is unlikely to recognize a strange extension and may refuse to handle your file correctly.



TECHNICAL NOTE: By default, the Windows® XP operating system does not show file extensions. For information on showing or hiding file extensions, see your Windows® XP online help.

Printing your work

Ensure the operating system is set up for your printer as described in [“Setting up your printer” on page 72](#).



HINT: You only need to set up the printer the first time you connect it. If you use more than one printer or are changing printers, you will need to set up the Windows® XP operating system to run with the additional printer(s).

To print a file:

- 1 If your printer is not on, turn it on.
- 2 Open the **File** menu of your Windows® program and click **Print**.

The program displays a Print dialog box.

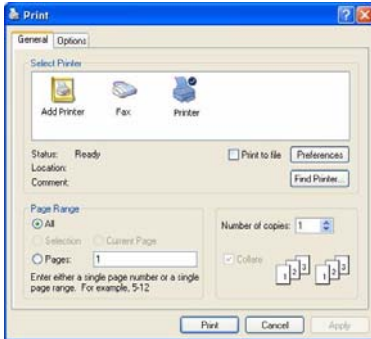

Sample Print dialog box

- 3 Specify the print parameters. For example, the range of pages and number of copies to print.
- 4 Click **Print**.

Backing up your work

Back up all the files you create in case something happens to your computer. You can back up your files to different types of media such as CDs, DVDs, diskettes, or to a network, if available.

To back up several files at one time, use the Microsoft® Windows® backup program preinstalled on the computer's hard disk. For more information, see [“Backing up your data to CDs with Windows XP” on page 217](#).



HINT: Backing up all the files on your hard disk may take a considerable amount of time and multiple CDs/DVDs. You may prefer to use a high-capacity backup system, such as an external hard drive.

Small files can be backed up on diskettes if an optional external diskette drive is available.

Restoring your work

To restore information from your backup media to your hard disk, use the Restore page in the backup program. Look in the online Help or your operating system documentation for information on restoring files.



TECHNICAL NOTE: When restoring files, the backup program prompts you if you try to overwrite a file that already exists on the hard disk. Make sure the backup version is the one you want before overwriting the existing file.

Using the CD-RW/DVD-ROM or multi-function drive

Optical storage has become the preferred medium for software, music, and video. Digital versatile discs (DVDs) provide a significant increase in data storage and support features that are not available on any other video platform. These features include wide-screen movies, multiple language tracks, digital surround sound, multiple camera angles, and interactive menus.

For these reasons, your computer may come with a CD-RW/DVD-ROM or multi-function drive.



TECHNICAL NOTE: Your CD-RW/DVD-ROM or multi-function drive is set to play region 1 (North America) DVD-ROMs. If you play a DVD disc from another region, the drive will automatically change to play in the format of the other region. The drive will allow you to change regions four times. On the fourth change, the region will be “locked in.” That is, the drive will only play DVDs from that last region. Note that changing from region 1 to region 2 and back to region 1 is counted as two changes.

NOTE

For optimum DVD performance, it is recommended that you play DVDs while running the computer on AC power.

CD-RW/DVD-ROM or multi-function drive components

The CD-RW/DVD-ROM or multi-function drive is located on the right side of the computer.

Your CD-RW/DVD-ROM or multi-function drive may look like this:

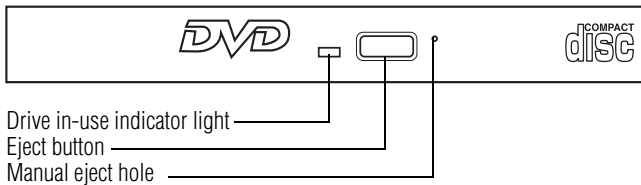

Sample CD-RW/DVD-ROM or multi-function drive

Drive in-use indicator light—Indicates when the drive is in use.

Eject button—Press to release the disc tray.

CAUTION

Do not press the eject button or turn off the computer while the Drive in-use indicator light is glowing. Doing so could damage the disc or the drive.

When the disc tray is open, be careful not to touch the lens or the area around it. Doing so could cause the drive to malfunction.

Manual eject hole—Use if you need to release the disc tray when the power is off. Use a straightened paper clip or other narrow object to press the manual eject button located inside the hole.

CAUTION

Never use a pencil to press the manual eject button. Pencil lead can break off inside the computer and damage it.

Media Control Buttons

The CD/DVD control buttons located above the keyboard let you power on the computer, access the Internet when the computer is on, and play audio CDs or DVD movies when the computer is off. You can also use them to play CDs and DVDs when the computer is on.

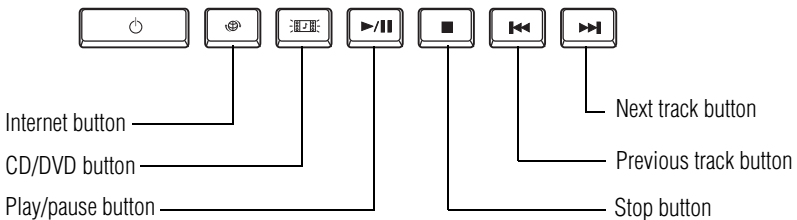

Sample Media Control Buttons

The **Internet button** lets you access the Internet when the computer is on.

The **CD/DVD button** activates a media playing application that can play audio CDs or DVD movies.

The following chart describes the CD/DVD button functionality.

Power is off or the computer is in Hibernation mode and you press the CD/DVD button	If a CD is in the drive, the system operates as a stand-alone CD player. If a DVD is in the drive, the system operates as a stand-alone DVD movie player
Operating system is running or the computer is in Standby mode and you press the CD/DVD button	If a CD is in the drive, the Windows Media® Player starts and the audio CD begins to play. If a DVD is in the drive, WinDVD™ starts and the DVD begins to play.

The **play/pause button** starts playing the disc or makes it pause if currently playing.

The **stop** button stops a disc that is currently playing.

The **previous track button** returns to the preceding track on the disc.

The **next track button** skips to the following track on the disc.

Inserting a compact disc

To insert a compact disc into the drive:

- 1 Make sure the computer is turned on.
- 2 Make sure the in-use indicator light is off.
- 3 Press the drive's eject button.

The disc tray slides partially out of the drive (about 1 inch).



HINT: The drive will not open if the computer's power is off.

- 4 Grasp the tray and pull it fully open.

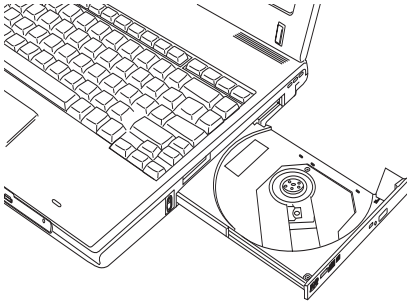

Sample drive tray fully extended

- 5 Hold the disc by its edges and check that it is free of dust.
If the disc is dusty, clean it as described in “Caring for CD or DVD Discs” on page 103.
- 6 Place the disc carefully in the disc tray, label side up.

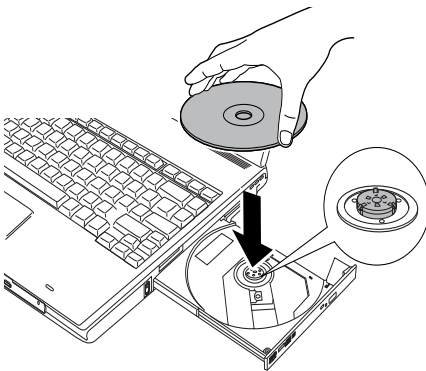

Sample positioning the disc in the drive

- 7 Gently press the disc onto the center spindle until it clicks into place.
-

CAUTION

Handle DVDs and CDs carefully, making contact only with the center hole and edge. Do not touch the surface of the disc. Do not stack discs. If you incorrectly handle the discs, you could lose data.

- 8 Make sure the disc is completely on the spindle and is lying flat on the tray.
-

CAUTION

If you insert the disc incorrectly, it may jam the drive. If this happens, contact Toshiba support for assistance.

- 9 Push the disc tray in by pressing gently on the center of the tray until it clicks into place.

You are ready to use the disc.

Playing an audio CD

Insert an audio CD and close the disc tray.

If the computer is turned on, Windows Media® Player opens and the CD begins to play. You can use the Windows Media Player program to control the CD.

To access the Windows Media Player, you can open it through the Start menu or activate it from the taskbar.

NOTE

When using Windows Media Player, your system may not be able to activate Standby or Hibernation modes. To prevent this from occurring, close Windows Media Player before you select Standby or Hibernation mode.

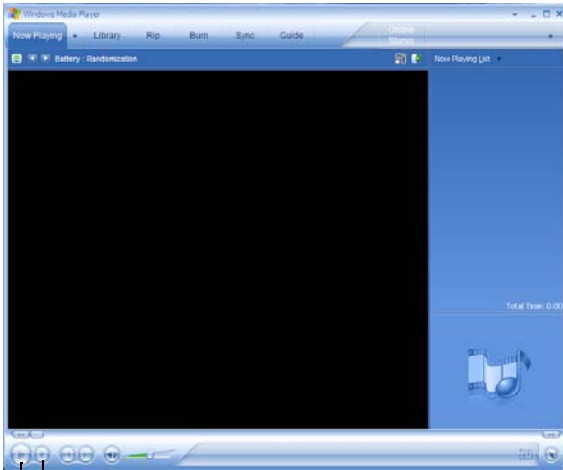

— Stop button
— Play/pause button

Sample Windows Media Player screen

The Windows Media Player control panel works much like an ordinary compact disc player:

- ❖ To play the CD or to pause, click the **Play/pause** button.
- ❖ To stop the CD, click the **Stop** button.

CAUTION

Before putting on headphones to listen to an audio CD, turn the volume dial down. Do not set the volume too high when using the headphones. Continuous exposure to loud sound can harm your hearing.

Playing CDs using Auto-Run

If you insert a CD into the CD-RW/DVD-ROM or multi-function drive and the Auto-Run feature does not automatically start your disc, try launching the CD manually.

To do this, follow these steps:

- 1 Open the **Start** menu and select **My Computer**.
- 2 Click the CD-RW/DVD-ROM or multi-function drive icon.

The disc drive will run the CD.

If your disc does not run using this method, try using an application that is associated with the media on the disc. For example, if it is a music CD, open Windows® Media Player and use it to select and then play the CD. For other types of media, use the associated software to open the files on the disc.

Creating a CD

Depending on the configuration, your computer may come with a multi-function drive that allows you to:

- ❖ Play pre-recorded DVDs
- ❖ Play pre-recorded CDs
- ❖ Read and write data (depending on your system configuration) and music files to CD-Recordable (CD-R) and CD-Rewritable (CD-RW) discs; and DVD±R/±RW or DVD RAM discs.

NOTE

Due to manufacturing and quality variations in third party optical media (e.g., CD or DVD) or optical media players/recorders, in certain cases, your Toshiba optical drive may not record on certain optical media that bear the applicable logo, or playback optical media recorded by other PCs or optical media recorders. Additionally, certain optical media recorded on your optical drive may not playback or operate properly on other PCs or optical media players. These problems are not due to any defect in your Toshiba PC or optical drive. Please refer to your PC's product specification for listing of specific format compatibilities.

Copy protection technology may also prevent or limit recording or viewing of certain optical media.

For details on how to use the software, please refer to the respective Online Help menus.

Removing a disc with the computer on

To remove a compact disc (CD or DVD) with the computer turned on:

- 1 Press the eject button on the drive.
-

CAUTION

Do not press the eject button while the in-use indicator light is glowing. Doing so could damage the disc or the drive.

Also, if the disc is still spinning when you open the disc tray, wait for it to stop spinning before you remove it.

- 2 Pull the tray out until it is fully open, remove the disc, and place it in its protective cover.

- 3 Gently push the tray in to close it.

Removing a disc with the computer off

- 1 Insert a slender object, such as a straightened paper clip, into the manual eject hole.

The disc tray slides partially out of the drive (about 1 inch).

CAUTION

Never use a pencil to press the manual eject button. Pencil lead can break off inside the computer and damage it.

- 2 Pull the tray out until it is fully open, remove the disc, and place it in its protective cover.
- 3 Gently push the tray in to close it.

Caring for CD or DVD Discs

- ❖ Store your discs in their original containers to protect them from scratches and keep them clean.
- ❖ Do not bend a disc or place heavy objects on top of it.
- ❖ Do not apply a label to or otherwise mar the surface of a disc.
- ❖ Hold a disc by its outside edge. Fingerprints on the surface can prevent the CD-RW/DVD-ROM or multi-function drive from reading the data properly.
- ❖ Do not expose discs to direct sunlight or extreme heat or cold.

- ❖ To clean a disc that is dirty, wipe it with a clean, dry cloth. The most efficient method to clean it is to start from the center of the disc and wipe toward the outward edge (not in a circle). If necessary, moisten the cloth with water or a neutral cleaner (not benzine or rubbing alcohol). Let the disc dry completely before inserting it in the drive.

Toshiba's online resources

Toshiba maintains a number of online sites to which you can connect. These sites provide information about Toshiba products, give help with technical questions and keep you up to date with future upgrades. For more information, see [“Contacting Toshiba” on page 222](#).

Chapter 3

Mobile Computing

This chapter covers all aspects of using your computer while traveling.

Toshiba's energy-saver design

Your computer enters a low-power suspension mode when it is not being used, thereby conserving energy and saving money in the process. It has a number of other features that enhance its energy efficiency.

Many of these energy-saving features have been set by Toshiba. We recommend you leave these features active, allowing your computer to operate at its maximum energy efficiency, so that you can use it for longer periods while traveling.

Running the computer on battery power

-  The computer contains a removable Lithium-Ion (Li-Ion) high-capacity battery that provides power when you are away from an AC outlet. You can recharge it many times.

Battery Notice

Battery life may vary considerably from specifications depending on product model, configuration, applications, power management settings and features utilized, as well as the natural performance variations produced by the design of individual components. Published battery life numbers are achieved on select models and configurations tested by Toshiba at the time of publication. Recharge time varies depending on usage. Battery may not charge while the computer is consuming full power.

After a period of time, the battery will lose its ability to perform at maximum capacity and will need to be replaced. This is normal for all batteries. To purchase a new battery pack, see the accessories information that shipped with your computer or visit the Toshiba Web site at accessories.toshiba.com.

To ensure that the battery maintains its maximum capacity, operate the computer on battery power at least once a month until the battery is fully discharged. Please see “[Maximizing battery life](#)” on page 123 for procedures. If the computer is continuously operated on AC power, either through an AC adapter or a docking station (if applicable to your system), for an extended period (more than a month), the battery may fail to retain a charge. This may shorten the life of the battery, and the battery light may not indicate a low-battery condition.

NOTE

For optimum DVD performance, it is recommended that you play DVDs while running the computer on AC power.

The computer also has an internal real-time-clock (RTC) battery.

The RTC battery powers the RTC memory that stores your system configuration settings and the current time and date information. It maintains this information for up to a month while the computer is turned off.



TECHNICAL NOTE: The RTC battery does not charge while the computer is turned off, even when the AC adapter is charging the computer.

The RTC battery charges only while the computer is powered on.

Power management

Your computer ships with the power management options preset to a configuration that will provide the most stable operating environment and optimum system performance for both AC power and battery modes.

CAUTION

Changes to these settings may result in system performance or stability issues. Users who are not completely familiar with the power management component of the system should use the preset configuration. For assistance with setup changes, contact Toshiba's Global Support Centre.

Using additional batteries

In addition to the main battery, you may also have an optional second battery (not included with your computer). If you travel and need to work for many hours without an AC power source you can purchase an optional battery module. You can then replace a discharged main battery and continue working.

For more information on batteries and accessories, see accessories.toshiba.com.

Charging batteries

The main battery needs to be charged before you can use it to power the computer.

CAUTION

Never leave batteries in the battery charger for more than a week at a time. Doing so may reduce the potential charge of the battery.

Use only battery chargers designed to work with your notebook computer. You can order a Toshiba battery charger from Toshiba's Web site at accessories.toshiba.com.

NOTE

Battery charge time may vary depending on the applications, power management settings, and features used.

Charging the main battery

To charge the main battery while it is in your computer, plug the computer into a live electrical outlet. The main battery charges whether the computer is on or off.



TECHNICAL NOTE: When your computer is using all of the power provided by the AC adapter to run applications, features, and devices, the recharging of the battery cannot occur. Your computer's Power Options Properties can be used to select a power level setting that reduces the power required for system operation and will allow the battery to recharge.

The main battery may not start charging immediately under the following conditions:

- ❖ The battery is extremely hot or cold.

To ensure that the battery charges to its full capacity, wait until it reaches room temperature (50 to 80 degrees Fahrenheit, 10 to 26 degrees Celsius).

- ❖ The battery is almost completely discharged.

Leave the power connected and the battery should begin charging after a few minutes.



HINT: Once the battery is fully charged, we recommend that you operate your computer on battery power until the battery discharges completely. Doing this extends battery life and helps ensure accurate monitoring of battery capacity.

Charging the RTC battery

Your computer has an internal real-time clock (RTC) battery. The RTC battery powers the System Time Clock and BIOS memory used to store your computer's configuration settings. When fully charged, it maintains this information for up to a month when the computer is powered off.

The RTC battery may have become completely discharged while your computer was shipped, resulting in the following error message during startup:

```
BAD RTC BATTERY  
BAD CHECKSUM (CMOS)  
CHECK SYSTEM
```

NOTE

The above error message may vary by computer model.

The RTC battery does not charge while the computer is turned off even when the AC adapter is charging the computer. The RTC battery charges when the computer is powered on.

If the RTC battery is low, the real-time clock and calendar may display the incorrect time and date, or stop working.

To recharge the RTC battery, plug the computer into a live electrical outlet and leave the computer powered on for 24 hours.

NOTE

It is seldom necessary to charge the RTC battery because it charges while the computer is on. If the RTC battery is low, the real-time clock and calendar may display the incorrect time and date or stop working.

When Hibernation mode is enabled and the RTC battery is completely discharged, a warning prompts you to reset the real-time clock.

The computer can be used while the RTC battery is being charged, although the charging status of the RTC battery cannot be monitored.

Monitoring main battery power



The computer's main battery light gives you an indication of the main battery's current charge:

- ❖ Glows amber while the main battery is being charged (AC adapter connected).
- ❖ Glows blue when the main battery is fully charged.

- ❖ Is unlit when the battery has discharged, the battery is not charging, or the AC adapter is not plugged into the computer or AC outlet.
-

NOTE

Battery life and charge time may vary, depending upon power management settings, applications and features used.

- ❖ Flashes amber when the main battery charge is low and it is time to recharge the main battery or plug in the AC adapter.
-

NOTE

If the AC power light flashes amber during charging, either the battery pack is malfunctioning, or it is not receiving correct input from the AC power supply.

Disconnect the AC power cord/cable and remove the battery pack. See [“Changing the main battery” on page 118](#) for information on replacing the main battery.



HINT: Be careful not to confuse the battery light (☐) with the on/off light (⏻).

When the on/off light flashes amber, it indicates that the system is suspended (using the Windows® operating system Standby command).

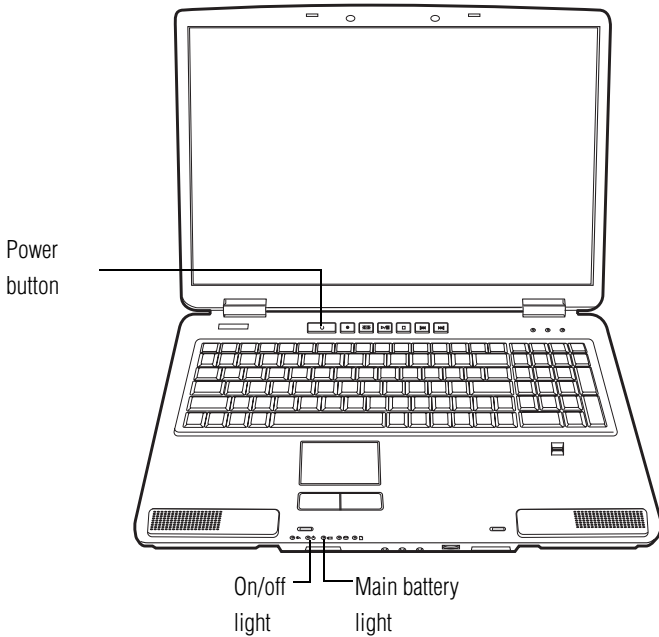

Sample power and main battery light locations

Determining remaining main battery power

NOTE

Wait at least 16 seconds after turning on the computer before trying to monitor the remaining battery power. The computer needs this time to check the battery's remaining capacity and perform its calculations.



- 1 Click **Start, Control Panel**.
- 2 Double-click the **Power Options** icon.
The Power Options Properties window appears.
- 3 Click the **Power Meter** tab.

The current power source and battery power remaining section displays the current charge state of the battery. The value displays as a percentage of remaining battery charge.

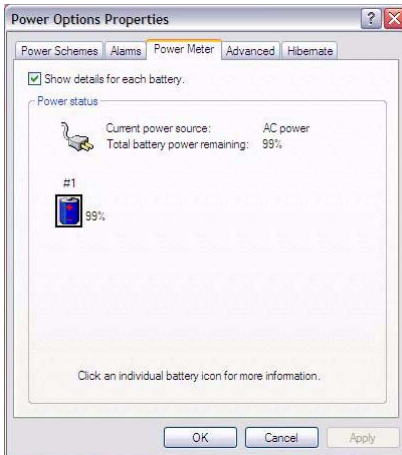

Sample Power Meter tab of Power Options Properties



TECHNICAL NOTE: The computer drains the battery faster at low temperatures. Check your remaining charge frequently if you are working in temperatures below 50 degrees Fahrenheit.

The computer calculates the remaining battery charge based on your current rate of power use and other factors such as the age of the battery.

What to do when the main battery runs low

When the main battery runs low you can:

- ❖ Plug the computer into an external power source and recharge the main battery
- ❖ Place the computer into Hibernation mode and replace the main battery with a charged spare
- ❖ Connect the computer to an optional high capacity battery (if available for your computer)
- ❖ Save your work and turn off the computer

If you do not manage to do any of these things before the main battery completely runs out of power, the computer automatically enters Hibernation mode and turns itself off. Hibernation mode keeps track of where you were, so that when you turn on the power again, you can continue where you left off.

If you have Hibernation mode enabled (the default), the computer copies the details of your open programs and files to the hard disk before shutting down. For more information on using Hibernation, see [“Using and configuring Hibernation mode”](#) on page 78.

Setting battery alarms

Your computer can be configured to warn you when the battery is running low.

You can set multiple alarms. Each alarm can be set to alert you when a specified percentage of remaining battery power has been reached. You can set how the warning occurs: sound an alarm, display a message, both, or none. You can also set the computer to enter Standby mode or Hibernate mode or to completely power down when the alarm goes off.

To set an alarm:

- 1 Click **Start, Control Panel**.
- 2 Double-click the **Power Options** icon.
The Power Options Properties window appears.
- 3 Click the **Alarms** tab and set the alarm as desired.

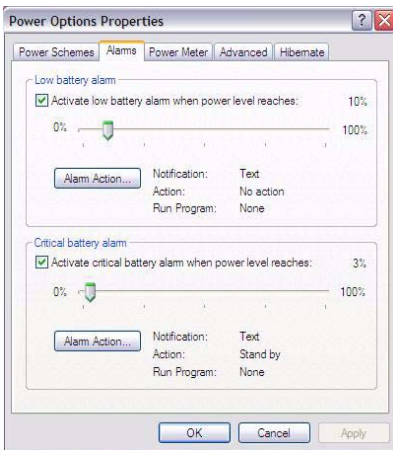

Sample Alarms tab in Power Options Properties

Conserving battery power

How long a fully charged battery pack lasts when you are using the computer depends on a number of factors, such as:

- ❖ How the computer is configured
- ❖ How much you use the hard disk, CD-RW/DVD-ROM or multi-function drive, diskette drives, or other optional devices

- ❖ Where you are working, since operating time decreases at low temperatures

There are various ways in which you can conserve power and extend the operating time of your battery:

- ❖ Enable Standby or Hibernation, which saves power when you turn off the computer and turn it back on again
- ❖ Use the power schemes in the Power Options Properties

These power-saving options control the way in which the computer is configured. By using them, you can greatly increase the length of time you can use the computer before you need to recharge the battery.

These options are combined into preset power schemes that let you choose between maximum power savings and peak system performance. You may also set individual power-saving options to suit your own needs.

Power Schemes

You can choose a power scheme, and either use its predefined settings, or customize the settings as you require. To do this:

- 1 Click **Start, Control Panel**.
- 2 Double-click the **Power Options** icon.



The Power Options Properties window appears.

- 3 Click the **Power Schemes** tab and select a power scheme.

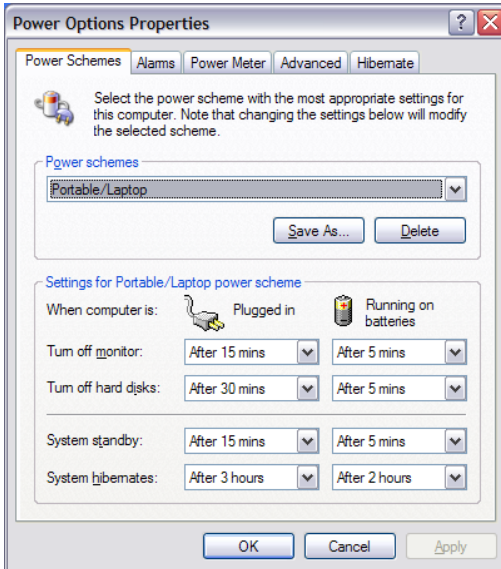

Sample Power Schemes tab in Power Options Properties

You can configure your computer's power usage using the drop down lists. You can choose one of the provided power schemes or select your own custom settings. For more information, see your Windows documentation.

Using a hot key to set the Power Scheme

You may use a hot key to set the power scheme.

To set the power scheme using a hot key:

- 1 Press Fn and F2 simultaneously.

The Power Schemes tab of the Power Options Properties window appears.

You can configure your computer's power usage using the drop down lists. You can choose one of the provided power schemes or select your own custom settings. For more information, see your Windows documentation.

Changing the main battery

▲ WARNING

Never short circuit the battery pack by either accidentally or intentionally bringing the battery terminals in contact with another conductive object. This could cause serious injury or fire, and could also damage the battery pack.

▲ WARNING

Never expose a battery pack to abnormal shock, vibration or pressure. The battery pack's internal protective device could fail, causing it to overheat or ignite, resulting in caustic liquid leakage, or explosion or fire, possibly resulting in death or serious injury.

When your main battery has run out of power, you have two options: plug in the AC adapter or install a fresh main battery.



TECHNICAL NOTE: To avoid losing any data, save your files and then either completely shut down your computer, or put it into Hibernation mode before changing the main battery.

Removing the battery from the computer

To remove the battery:

- 1 Save your work.
- 2 Power off the computer or place it in Hibernation mode according to the instructions in “[Hibernation mode](#)” on [page 75](#).
- 3 Unplug and remove any cables connected to the computer, including the AC adapter.
- 4 Close the display panel and turn the computer upside down with the front of the computer facing you.
- 5 Slide the battery release lock to the unlocked position.

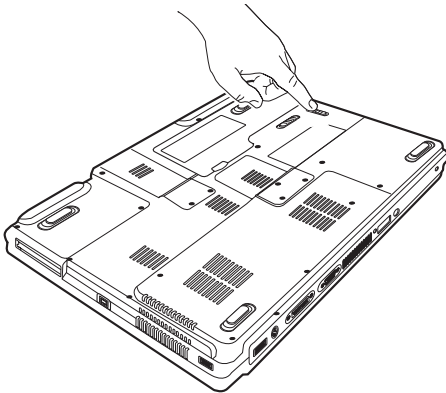

Sample removing the battery

- 6 Slide the battery release latch to release the battery.
- 7 Pull the discharged battery out of the computer.

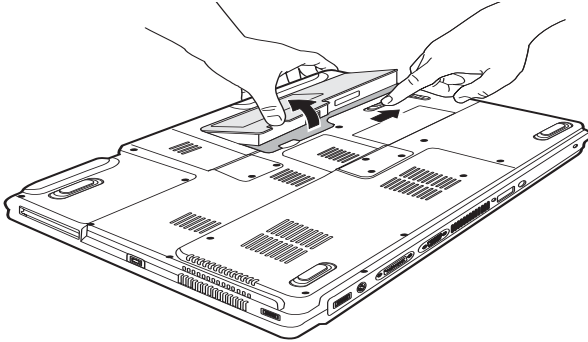

Sample removing the battery

▲ WARNING

If the battery is leaking or its case is cracked, put on protective gloves to handle it, and discard it immediately. Always dispose of used battery packs in compliance with all applicable laws and regulations. Put insulating tape, such as cellophane tape, on the electrode during transportation to avoid a possible short circuit, fire or electric shock. Failure to do so could possibly result in serious injury.

Inserting a charged battery

To insert a battery:

- 1 Wipe the terminals of the charged battery with a clean cloth to ensure a good connection.

-
- 2 Insert the charged battery into the slot until the latch clicks.

The battery pack has been designed so that you cannot install it with reverse polarity.

CAUTION

If the battery does not slide into the slot easily, move the battery release lock to the unlocked position and try again. Do not force the battery into position.

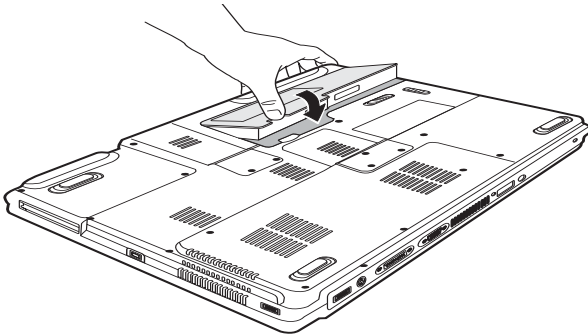

Sample inserting the battery

- 3 Slide the battery release lock to the locked position.
- 4 Turn the computer right side up.
- 5 Reconnect any cables that were removed in step 3 of “Removing the battery from the computer” on page 119.
- 6 Restart the computer.

Taking care of your battery

The following sections offer tips on how to take care of your battery and prolong its life.

Safety precautions

- ❖ If the battery pack produces an odor, overheats or changes color or shape while it is being used or charged, turn off the computer's power immediately and disconnect the power cord/cable from the power socket. Carefully remove the battery pack from the computer.
- ❖ Do not try to disassemble a battery pack.
- ❖ Do not overcharge or reverse charge a battery. Overcharging will shorten its life, and reverse charging could damage it.
- ❖ Avoid touching the metal terminals of the battery with another metal object. Short-circuiting the battery can cause it to overheat and may cause damage to the battery or the computer.
- ❖ Do not incinerate a spent battery, as this could cause it to explode and release caustic liquid.
- ❖ If a battery is leaking or damaged, replace it immediately. Use protective gloves when handling a damaged battery.
- ❖ To replace the main battery, use an identical battery that you can purchase through the Toshiba Web site at accessories.toshiba.com.
- ❖ A reverse polarity condition should be avoided with all batteries. The main battery is designed so that it cannot be installed in reverse polarity.
- ❖ Charge the battery only in the computer or in a battery charger designated as an approved option.
- ❖ When you install the battery pack, you should hear a click when it is seated properly.

- ❖ Do not expose the battery pack to fire. The battery pack could explode.

Maximizing battery life

To maximize the life of your battery pack:

- ❖ At least once a month, disconnect the computer from a power source and operate it on battery power until the battery pack fully discharges. Before doing so, follow the steps below:
 - 1 Turn off the computer's power.
 - 2 Disconnect the AC adapter and turn on the computer's power. If it does not turn on, go to step 4.
 - 3 Operate the computer on battery power for five minutes. If the battery pack has at least five minutes of operating time, continue operating until the battery pack is fully discharged. If the battery light flashes or there is some other warning to indicate a low battery, go to step 4.
 - 4 Connect the AC adapter to the computer and the power cord/cable to a power outlet. The DC-IN or AC power-light should glow blue, and the battery light should glow amber to indicate that the battery pack is being charged. If the DC-IN or AC power-light indicator does not glow, power is not being supplied. Check the connections for the AC adapter and power cord/cable.
 - 5 Charge the battery pack until the battery light glows blue.
- ❖ If you have extra battery packs, rotate their use.
- ❖ If you will not be using the system for an extended period, more than one month, remove the battery pack.
- ❖ Disconnect the AC adapter when the battery is fully charged. Overcharging makes the battery hot and shortens its life.

- ❖ If you are not going to use the computer for more than eight hours, disconnect the AC adapter.
- ❖ Store spare battery packs in a cool dry place out of direct sunlight.

Disposing of used batteries

The life of a battery pack depends on usage. When the battery pack needs replacing, the main battery light flashes amber shortly after you have fully recharged the battery.

You must discard a battery if it becomes damaged.

▲ WARNING

Never attempt to dispose of a battery pack by burning or by throwing it into a fire, and never allow exposure to a heating apparatus (e.g., microwave oven). Heat can cause a battery pack to explode and possibly cause serious injury.

Always dispose of used battery packs in compliance with all applicable laws and regulations. Put insulating tape, such as cellophane tape, on the electrode during transportation to avoid a possible short circuit, fire or electric shock. Failure to do so could possibly result in serious injury.

▲ WARNING

Always use the battery pack supplied as an accessory or an equivalent battery pack specified in the User's Manual. Other battery packs have different voltage and terminal polarities. Use of non-conforming battery packs could generate smoke or cause fire or rupture, possibly resulting in serious injury.

After repeated use, the batteries will finally lose their ability to hold a charge and you will need to replace them. Under certain applicable laws and regulations, it may be illegal to dispose of old batteries by placing them in the trash.

Please be kind to our shared environment. Check with your local government authority for details regarding where to recycle old batteries or how to dispose of them properly. If you cannot find the information you need elsewhere, call Toshiba at: (800) 457-7777.

Traveling tips

The environmental precautions listed in [“Selecting a place to work” on page 39](#), also apply while traveling.

- ❖ Never leave your computer on a sunny ledge or in a place where it could get wet or covered in dust.
- ❖ Always travel with the computer in a carrying case. Toshiba offers a choice of carrying cases for the computer. They all provide plenty of extra space for manuals, power cords, and compact discs. Contact your authorized Toshiba representative for more information.



TECHNICAL NOTE: When traveling by air, you may be required to pass your notebook through airport security equipment. The X-ray equipment will not harm your computer.

NOTE

Before using your computer aboard an aircraft, make sure the Wi-Fi® switch is set to the Off position if your computer has wireless LAN capability.

Chapter 4

Exploring Your Computer's Features

In this chapter, you will explore some of the special features of your notebook computer.

Exploring the desktop

The desktop is the launching pad for everything you can do in the Windows® XP operating system. You use its features to start programs, find documents, set up system components, and perform most other computing tasks.



HINT: The illustrated examples in this guide may appear slightly different from the screens displayed by your system. The differences are not significant and do not indicate any change in the functionality of your system.



TECHNICAL NOTE: If you delete a file from a diskette, it does not go into the Recycle Bin. For more information on the Recycle Bin, see Windows online Help.



Internet Explorer — The Microsoft® browser that provides access to the Internet.

NOTE

If you place the cursor over an icon, a popup description of the file contents appears.

Your desktop may contain other icons depending on your configuration. See Windows® XP online help for more specific information on each icon and how to use it.

Start button

You use the Start button to:

- ❖ Start programs
- ❖ Access Microsoft® Windows® XP operating system update information
- ❖ Open documents
- ❖ Adjust system settings
- ❖ Find files
- ❖ Access Windows® Help
- ❖ Run programs
- ❖ Suspend system activity and shut down the computer

Taskbar

Each time you open a program, a button associated with that program appears on the taskbar. With some programs, a button appears on the taskbar for each document or window you open. You can use these buttons to quickly switch between the programs or windows.

To make a program or window the currently active one, click the associated taskbar button.

System tray

The System tray displays icons of tasks or programs that run continuously in the background. To learn more about each task, position the cursor over the icon for a few moments and a short description of the task appears.

Typical tasks in the System tray are Current time, Power usage mode, Mouse properties, and speaker volume.

To activate a specific task, double-click the appropriate System tray icon.

Setting up for communications

To connect to the Internet, use an online service, or communicate across the telephone lines with another computer, you need:

- ❖ A modem (one comes with your computer)
- ❖ A telephone line
- ❖ A browser or communications program
- ❖ An Internet Service Provider (ISP) or online service if you plan to use the Internet

Determining the COM port

Your modem is connected to one of the computer's COM (communications) ports. The default setting for the modem is COM3.

The following procedure is intended to support you if you need to either upgrade your modem or reset the port to the default settings.

If you are having trouble connecting through the modem, you may need to determine the current COM port name and possibly change it.

To find out which port your modem is connected to:

- 1 Click **Start, Control Panel, Printers and Other Hardware**, and then **Phone and Modem Options**.

The **Phone and Modem Options** Properties dialog box displays.

- 2 Fill in the **Local Information** text boxes and click **OK**.
- 3 Click the **Modems** tab.

Your modem should be listed next to one of the computer's COM ports.

- 4 Make a note of the COM port number.
- 5 To verify that the modem is set up properly, select the modem you wish to check, and then click **Properties** to bring up the dialog box with information specific to that modem.

Windows XP communicates with the modem and displays identifying information reported by the modem. If Windows XP cannot communicate with the modem, it displays an error message. Consult the troubleshooting sections of your modem and operating system documentation.

- 6 Click **OK** to close the properties dialog box for that specific modem.
- 7 Click **OK** to close the Modem Properties dialog box.
- 8 Close the Control Panel.

Connecting the modem to a telephone line

Before you can communicate using the modem, you need to connect it to a telephone line. Your computer's built-in modem port provides an RJ-11 jack, allowing you to connect the modem to a standard voice-grade telephone line.

- 1 Plug one end of a telephone cable (purchased separately) into the modem port on the back of the computer.

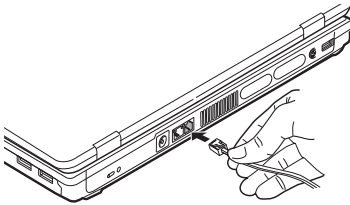

Sample connecting the telephone cable to the modem port

- 2 Connect the other end to the RJ-11 wall jack.

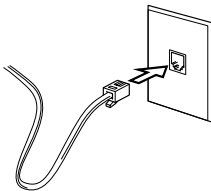

Sample connecting to a wall jack

CAUTION

The modem is designed for use with a standard analog telephone line. Do not connect the modem to a digital telephone line. A digital line will damage the modem.

Now you are ready to send a fax or use the modem to connect to an online service or the Internet.

For more detailed information regarding your computer's modem, visit Toshiba's Web site at accessories.toshiba.com.

Connecting your computer to a network

You can connect your computer to a network to increase its capabilities and functionality using one of its communication ports.

Accessing a network

To access a network:

- ❖ At the office, connect an Ethernet cable to the RJ45 jack on your computer. For specific information about connecting to the network, consult your network administrator.
- ❖ While you are at home or traveling, you need a dial-up connection. Ask your network administrator for the telephone number of the network.

Setting up the connection

To set up an office connection, consult your network administrator for network settings and additional considerations.

To set up a dial-up connection, use the New Connection Wizard:

- 1** Click **Start, All Programs, Accessories, Communications,** and then **New Connection Wizard**.
- 2** Enter the phone number of your network connection and let the program dial the number.

The computer connects to the network.

Using the Ethernet LAN Port

When your computer starts, Windows attempts to contact a Dynamic Host Configuration Protocol (DHCP) server. If the computer is not connected to a network, it may pause a few minutes as it waits for a reply. To avoid this delay, you can reconfigure Windows to disable the LAN port.

To disable the LAN port:

- 1 Click **Start, Control Panel, Performance and Maintenance**, and then **System**.
- 2 Click the **Hardware** tab, and then **Device Manager**.
- 3 Select the appropriate network adapter.
- 4 Click **Actions**.
- 5 Select the **Properties** icon.
- 6 Select the **Do not use this device (disable)** option from the **Device usage** drop-down.
- 7 Click **OK**.

Your LAN port is now disabled.

To enable the Ethernet LAN port, repeat steps one through four. Select the **Use this device (enable)** check box, and click **OK**.

Using Wireless LAN Connectivity

NOTE

Wireless connectivity and some features may require you to purchase additional software, external hardware or services. Availability of public wireless LAN access points may be limited.

Your system may come with an optional wireless LAN module. This is a technology that expands wireless communication beyond networking equipment, and can connect many different kinds of electronic devices without the need for cables.

For information on how to set up a wireless connection, refer to your wireless networking device documentation or your network administrator.

To use your wireless communication, slide the wireless on/off switch to the On position.

NOTE

When the Wi-Fi antenna switch is on, the wireless indicator light on the front of the computer will be lit.

For help with common Wi-Fi networking problems, see [“Wireless networking problems”](#) on page 208.

An overview of using the Internet

The following sections give a quick introduction to the Internet and some of its exciting features, under these headings:

- ❖ [The Internet](#)
- ❖ [The World Wide Web](#)
- ❖ [Internet Service Providers](#)
- ❖ [Connecting to the Internet](#)

-
- ❖ Surfing the Internet
 - ❖ Internet features
 - ❖ Uploading to, and downloading files from, the Internet

The Internet

The Internet is an association of thousands of networks and millions of computers around the world connected by communications lines. They all work together to share information.

The World Wide Web

The World Wide Web (or “Web”) is a subset of the Internet — a collection of interlinked documents (located on computers connected to the Internet) that work together using a specific Internet protocol called Hypertext Transfer Protocol (HTTP).

The World Wide Web offers information as text, images, audio, or video to be referenced from anywhere in the world. Special programs called Web browsers are specifically designed to work with HTTP. They make it easier to connect to a particular network address and send and receive information.

Internet Service Providers

To connect a computer directly to the Internet, many people and businesses use an Internet Service Provider (ISP). An ISP is a company that has the equipment and the telecommunication lines necessary to maintain an Internet connection.

You can connect to the Internet by using a telephone and modem or through other higher-speed communication methods such as Digital Subscriber Lines (DSL), cable, and satellite links.

Connecting to the Internet

To connect to the Internet, you need:

- ❖ A modem and telephone line, or a LAN connection
- ❖ A Web browser
- ❖ An Internet Service Provider (ISP) account

The Microsoft® Web browser Internet Explorer is automatically configured on your system so that when you first start it, it guides you through signing up for a new ISP account, or assists you in setting up your computer to work with your existing ISP.

Once you have established an ISP account, you can connect to the Internet.

- 1 Connect your computer's modem to a telephone line. For more information on connecting a modem, see [“Connecting the modem to a telephone line”](#) on page 131.



- 2 Start your Web browser. Have your modem dial the ISP's telephone number, and establish a connection with the ISP's computer.

If you are using your computer at the office, then you probably connect to the Internet through your company's network. See your network administrator about connecting to the Internet.

Surfing the Internet

Once connected to the Internet, the Web browser displays a home page, for example, your ISP's home page on the Internet or your company's Web site home page.

To visit a desired Web site, type in the Web address. The Web address, or Uniform Resource Locator (URL), is a unique identifier for that computer system linked to the Internet. Web addresses can also appear within a Web page's text, and are known as links. Clicking a link automatically transfers your Web browser to that site.

You can also use a Search Engine, a Web site specifically designed to help you look for information.

Internet features

The Internet offers many types of communication tools to help you perform many tasks.

❖ **Internet email**

To send and receive email of your own, you need a mailbox on the Web or an email address.

If you have an account with an ISP, you can probably set up an email address at the same time you sign up for the service.

❖ **Internet chat rooms**

A chat room is a Web site that offers a place where people with similar interests and ideas communicate in real-time, one-on-one or in groups, by typing messages which are instantly viewed by others on their computer screens.

❖ **Internet news groups**

A news group is similar to a chat room, but instead of using a dedicated site to converse about a specialized subject with others in real-time, it uses a Web site as a clearinghouse where all the messages are placed, like a gigantic bulletin board.

❖ **Online shopping**

Many Web sites offer products and services for sale.

Uploading to, and downloading files from, the Internet

Transferring files from one computer to another is termed uploading (transferring data from your computer to a site on the Web), or downloading (transferring data from a site on the Web to your computer).

There are several ways to upload or download data. It can be as simple as attaching a file or document to an email, or you can use the File Transfer Protocol (FTP) features of your Web browser to transfer large amounts of data.

Exploring audio features

You can use your computer to record sounds using an external microphone. You can play .wav sound files or audio CDs using the built-in speakers, headphones, or external speakers. For more information on playing audio CDs, see “Playing an audio CD” on page 99.

Recording sounds

You may record sounds as .wav files by connecting an external microphone or other sound source to the microphone jack.



TECHNICAL NOTE: If you record MP3 files, you will only be able to play them on a device capable of playing MP3 files.

Using a microphone



- 1 Connect an external microphone to the computer.
- 2 Click **Start, All Programs, Accessories, Entertainment**, and then **Sound Recorder**.

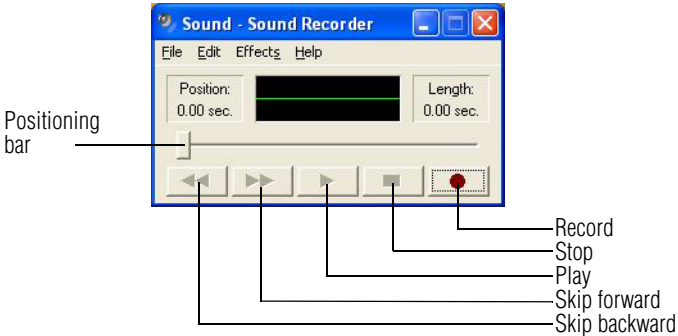

Sample Sound Recorder screen



- 3 Click the **Record** button.

- 4 Speak normally into the microphone.



- 5 When you have finished recording, click the **Stop** button.

The Sound Recorder window displays the new sound file as a waveform.

NOTE

You can only record 60 seconds at a time.



- 6 To hear what you just recorded, click the **Play** button.

- 7 To save the file, select **Save** from the **File** menu.

NOTE

The microphone setting on your computer might be set to Mute. To check this, click **Start, All Programs, Accessories, Entertainment**, and then **Volume Control**.

Using external speakers or headphones

Your computer is equipped with a full stereo sound system with internal speakers. Instead of using the internal speakers, you can connect an external audio device to one of the jacks on the front of the computer. These jacks and the types of audio devices they support are:

❖ **Optional headphone and S/PDIF jack**

This jack lets you connect either an optical digital audio-out cable (optional) directly to your digital stereo receiver port or a stereo headphone (16 Ohm minimum).

NOTE

The optional headphone and S/PDIF jack is used for both the headphone and S/PDIF functions. You can use only one function at a time.

❖ **Audio out jack**

This jack lets you connect a pair of external stereo speakers.

When you connect an optical digital audio-out cable (optional) directly to your digital stereo receiver port or stereo headphone jack, the internal speakers of your computer are disabled.

CAUTION

Before putting on headphones to listen to an audio CD, turn the volume dial down. Do not set the volume too high when using the headphones. Continuous exposure to loud sound can harm your hearing.



TECHNICAL NOTE: Use amplified speakers that require an external power source. Other types of speakers will be inadequate to produce sound from the computer.

To play back sound files through external speakers or headphones:



- 1 Locate the headphone or audio out jack on the front of the computer.
- 2 Using any necessary adapters, plug the cable from the headphones or external speakers into the jack.

The headphone jack requires a 16-ohm stereo mini-jack.

To adjust the volume:

- ❖ For external speakers, use the volume controls on each speaker.
- ❖ For headphones, use the computer's volume control dial.

Using the i.LINK® port

The i.LINK® port on the left side of the computer provides an extremely fast data transfer rate.

In addition to high speed, the i.LINK® port also supports isochronous data transfer (the delivery of data at a guaranteed rate). This makes it ideal for devices that transfer high levels of data in real-time, such as video devices.

As with USB ports, the i.LINK® port supports both Plug-and-Play (automatic configuration) and hot swapping (the ability to connect and disconnect devices while the computer is on).

Using PC Cards

Your computer comes with one PC Card slot and supports two types of PC Cards:

- ❖ Type I cards—You can install one of these cards.
- ❖ Type II cards—You can install one of these cards.



TECHNICAL NOTE: For PCMCIA-compatible PC Cards, check the package to make sure they conform to the PCMCIA 2.1 standard (or later). Other cards may work with your computer, but are likely to be much more difficult to set up and use.

Inserting a PC Card

Before you insert a PC Card, refer to the documentation that comes with the card to see if you need to do anything before you insert it.

CAUTION

You can only use PC Cards in the top slot or ExpressCards in the bottom slot. You cannot insert a PC Card into the ExpressCard slot (the bottom slot), nor can you insert an ExpressCard into the PC card slot (the top slot).

To insert a PC Card:

- 1 Locate the PC Card slot on the left side of the computer.
- 2 Insert the PC Card.

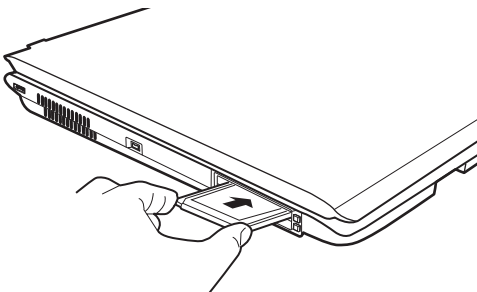

Sample inserting a PC Card

- 3 When the card is almost all the way into the slot, push firmly but gently to ensure a firm connection with the computer. Do not force the card into position.

Removing a PC Card



Prepare the card for removal by right-clicking on the Safely Remove Hardware icon on the system tray and then selecting the card or device you want to remove. If the system is unable to prepare the card for safe removal, a message will tell you to try again later. If the card can be removed now, the system displays **Safe to Remove Hardware**.

- 1 Locate the PC Card eject button.
- 2 Press the PC Card eject button once to pop it out slightly, then push it in to remove the PC Card.

The PC Card ejects slightly from the slot.

- 3 Grasp the edges of the PC Card and slide it out of the slot.

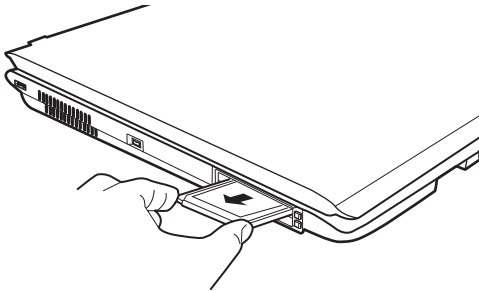

Sample removing a PC Card

Setting up a PC Card for your computer

Some PC Cards are ready to use as soon as you install them. Others, such as hard disk cards, network cards, and SCSI adapters, may need to be set up to work with your computer. To set up your PC Card, refer to the documentation that came with the card or refer to your operating system manual or online help.

Using an ExpressCard™

The ExpressCard slot supports the use of ExpressCard media. The slot also supports hot swapping, which allows you to replace one ExpressCard with another while the computer is on.

Inserting an ExpressCard

Before you insert an ExpressCard, refer to the documentation that comes with the card to see if you need to do anything before you insert it.

CAUTION

You can only use PC Cards in the top slot or ExpressCards in the bottom slot. You cannot insert a PC Card into the ExpressCard slot (the bottom slot), nor can you insert an ExpressCard into the PC card slot (the top slot).

To insert an ExpressCard:

- 1 Locate the ExpressCard slot just below the PC Card slot on the left side of the computer.
- 2 Insert the ExpressCard.

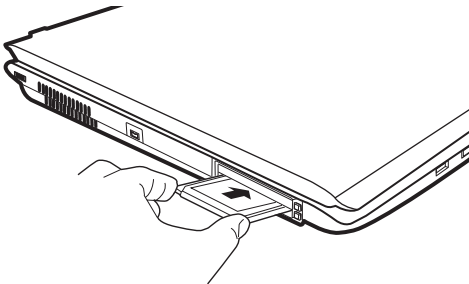

Sample inserting an ExpressCard

- 3 When the card is almost all the way into the slot, push firmly, but gently, to ensure a firm connection with the computer. Do not force the card into position.

Removing an ExpressCard



Prepare the card for removal by right-clicking on the Safely Remove Hardware icon on the system tray and then selecting the card or device you want to remove. If the system is unable to prepare the card for safe removal, a message will tell you to try again later. If the card can be removed now, the system displays **Safe To Remove Hardware**.

- 1 Locate the ExpressCard eject button.
- 2 Press the ExpressCard eject button once to extend it, and push it in to remove the ExpressCard.

The ExpressCard ejects slightly from the slot.

- 3 Grasp the edges of the ExpressCard and slide it out of the slot.

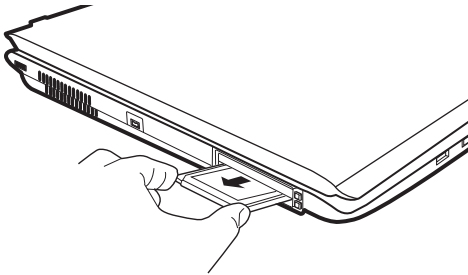

Sample removing an ExpressCard

Using the Bridge Media Adapter Slot

The Bridge Media Adapter Slot supports the use of Memory Stick™ or Memory Stick™ PRO media, Secure Digital™ (SD™) Cards, MMC (MultiMedia Card), or xD-Picture Cards. This media can be used with a variety of digital products: digital music players, cellular phones, PDAs, digital cameras, digital video camcorders, etc.

NOTE

Do not use the Copy Disk function for this type of media. To copy data from one media to another, use the drag-and-drop feature of Windows.

Inserting memory media

The following instructions apply to all types of supported media devices.

- 1 Turn the media so that the contacts (metal areas) are face down.
- 2 Push the media into the adapter slot until it locks in place.

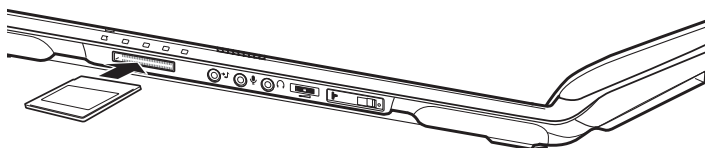

Sample inserting memory media

CAUTION

When inserting memory media, do not touch the metal contacts. You could expose the storage area to static electricity, which can destroy data.

Removing memory media



Prepare the media for removal by right-clicking on the Safely Remove Hardware icon on the system tray and then selecting the card or device you want to remove. If the system is unable to prepare the media for safe removal, a message will tell you to try again later. If the media can be removed now, the system displays **Safe to Remove Hardware**.

- 1 Gently press the card inward to release it.

The card pops out slightly.

- 2 Grasp the card and pull it straight out.

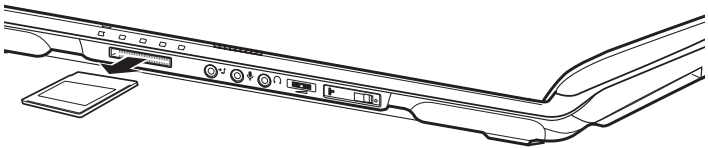

Sample removing a memory media card

CAUTION

Do not remove memory media while data is being written or read. Even when the Windows message "copying..." disappears, writing to the media might still be in progress and your data could be destroyed. Wait for the indicator light to go out.

Chapter 5

Toshiba Utilities

Your computer includes several utilities designed to help you to reconfigure your system to best meet your individual needs. Together, these allow you to determine certain system details, set additional options, or change default options. This chapter describes the utilities supplied by Toshiba:

- ❖ TOSHIBA Assist
- ❖ Supervisor password
- ❖ User password
- ❖ TOSHIBA Password Utility
- ❖ PC Diagnostic Tool Utility
- ❖ TOSHIBA Hotkey Utility
- ❖ TOSHIBA SD™ Memory Card Format Utility
- ❖ Mouse Utility
- ❖ TOSHIBA Hardware Setup
- ❖ TOSHIBA Zooming Utility
- ❖ CD/DVD Drive Acoustic Silencer
- ❖ TOSHIBA Accessibility
- ❖ Fingerprint Authentication Utility

TOSHIBA Assist

The TOSHIBA Assist provides quick access to computer functions and allows you to customize a range of computer settings.

To access TOSHIBA Assist, do one of the following:



- ❖ Double-click the TOSHIBA Assist shortcut icon on the desktop.
- ❖ Click **Start, All Programs, Toshiba, Utilities**, then click **Toshiba Assist**.

The TOSHIBA Assist window appears.



Sample TOSHIBA Assist window

The TOSHIBA Assist offers four categories of options:

- ❖ **Connect**
- ❖ **Secure**
- ❖ **Protect & Fix**
- ❖ **Optimize**

Connect

The features available in this category are:

- ❖ ConfigFree™ Connectivity Doctor
- ❖ ConfigFree
- ❖ Bluetooth® Settings (available on some models)
- ❖ Bluetooth Local COM Settings (available on some models)



Sample TOSHIBA Assist – Connect tab

Secure

The features available in this category are:

- ❖ User password
- ❖ Supervisor password
- ❖ TOSHIBA Password Utility



Sample TOSHIBA Assist window – Secure tab

Protect & Fix

The feature available in this category is:

- ❖ PC Diagnostic Tool Utility

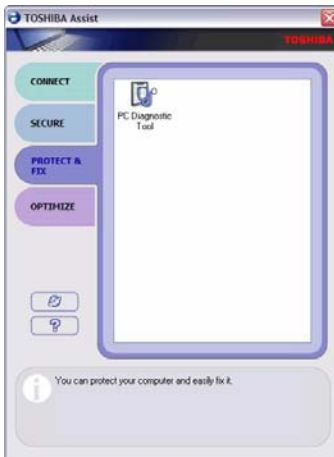

Sample TOSHIBA Assist window – Protect & Fix tab

Optimize

The features available in this category are:

- ❖ TOSHIBA SD™ Memory Card Format Utility
- ❖ Mouse Utility
- ❖ TOSHIBA Accessibility
- ❖ TOSHIBA Zooming Utility
- ❖ TOSHIBA Button Controls
- ❖ CD/DVD Drive Acoustic Silencer
- ❖ TOSHIBA Hardware Setup



Sample TOSHIBA Assist window – Optimize tab

TOSHIBA SD™ Memory Card Format Utility

This utility is used to format SD cards used with the Bridge Media Adapter Slot.

To format an SD memory card using this utility:



- 1 Click **Start**, **All Programs**, **Toshiba**, **Utilities**, **SD Memory Card Format** utility, or double-click the **SD Memory Card** icon in the **Optimize** tab of TOSHIBA Assist.

The SD Memory Card Format screen appears.

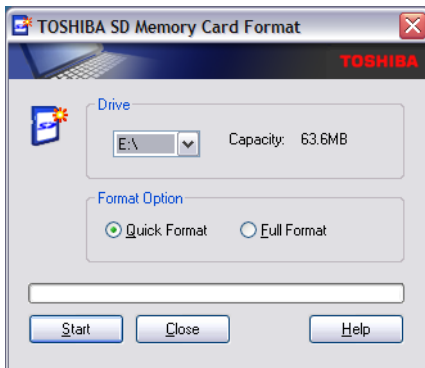

Sample SD Memory Card Format screen

- 2 Select the drive corresponding to the SD memory card.
- 3 Select the formatting option:
 - ❖ **Quick Format**
 - ❖ **Full Format**
- 4 Click **Start** to begin formatting. The formatting progress is displayed in the horizontal bar in the window.
- 5 When formatting is completed, click **Close** to exit the utility.

Setting passwords

Setting a password lets you walk away from your computer, secure in the knowledge that nobody can access your files. When you set a password, you must enter the password before you can work on your computer again.

Toshiba supports several types of passwords on your computer:

- ❖ An instant password—Secures your open programs and files when leaving the computer temporarily (the user password supports this function).
- ❖ A supervisor password—Prohibits unauthorized users from accessing certain functions such as TOSHIBA HW Setup. This is useful if more than one person uses the computer.

When setting up the various passwords, keep the following in mind:

- ❖ The user password can be set up under the supervisor password.
- ❖ The supervisor password must be set before the user password, or the user password must be deleted and then re-entered after the supervisor password is set.

Using an instant password

An instant password secures your system with a single keystroke. Use this feature when you leave your desk for a few minutes and do not want to turn off the computer.

To use an instant password, press Fn, then press F1. An instant password has no effect on an optional USB mouse or trackball.

To unlock your system, press any key or touch the pointing device and the Windows Logon screen will appear. Select your user name and enter your password, if any.

Using a supervisor or user password

A supervisor password prevents other users from changing hardware configuration options.

Setting a supervisor password

CAUTION

If you choose to set a supervisor password, Toshiba strongly recommends that you save your password in a location where you can later access it should you not remember it.

Toshiba is not responsible for any losses that may occur to you, your organization or others as a result of the inability to access the computer.

To register a password for the power-on password functions:

- 1 Start **TOSHIBA Assist**.
- 2 Click the **Secure** tab, then double-click the **Supervisor Password** icon.
- 3 Click **Set**.
- 4 Enter your password in the **Input** box, then enter it again to verify.
- 5 Click **Set**.
- 6 Click **OK** if you want to save the password to a text file on a diskette or media of your choice, or click **Cancel** if you do not want to save the password to a text file.
- 7 Click **OK**.

Deleting a supervisor password

To cancel the power-on password function:

- 1 Click **Start**, **All Programs**, **Toshiba**, **Utilities**, then click **Toshiba Assist**.

The TOSHIBA Assist window appears.

- 2 On the left side, select **Secure**.
- 3 Select the **Supervisor Password** icon.
- 4 Select **Not Registered**.
- 5 Type the correct password.
- 6 Click **OK**.

Setting a user password

CAUTION

If you choose to set a user password, Toshiba strongly recommends that you save your password in a location where you can later access it should you not remember it.

Toshiba is not responsible for any losses that may occur to you, your organization or others as a result of the inability to access the computer.

To register a password for the power-on password functions:

- 1 Start **TOSHIBA Assist**.
- 2 Click the **Secure** tab, then double-click the **User Password** icon.
- 3 Click **Set**.
- 4 Enter your password in the **Input** box, then enter it again to verify.
- 5 Click **Set**.

- 6 Click **OK** if you want to save the password to a text file on a diskette or media of your choice, or click **Cancel** if you do not want to save the password to a text file.
- 7 Click **OK**.

Disabling a user password

To cancel the power-on password function:

- 1 Click **Start, All Programs, Toshiba, Utilities**, then click **Toshiba Assist**.
The TOSHIBA Assist window appears.
- 2 On the left side, select **Secure**.
- 3 Select the **User Password** icon.
- 4 Select **Not Registered**.
- 5 Type the correct password.
- 6 Click **OK**.

TOSHIBA Password Utility

The TOSHIBA Password Utility allows you to set a user-level password in TOSHIBA Assist or in System Setup.

To use the TOSHIBA Password utility:

- 1 Start [TOSHIBA Assist](#).

- 2 Click the **Secure** tab, then double-click the **User Password** icon.

The TOSHIBA Password Utility window appears.

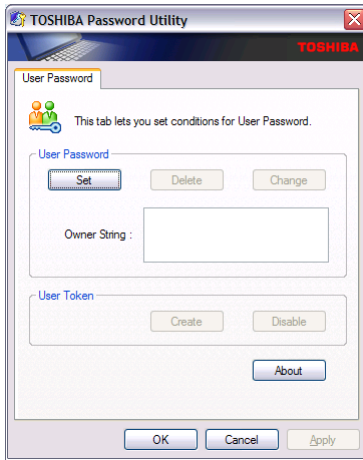

Sample TOSHIBA Password Utility window

- 3 Click **Set**.
- 4 Enter a password, then enter it again to verify.
- 5 Click **Set**.
- 6 Click **OK** if you want to save the password to a text file on a diskette or media of your choice. Click **Cancel** if you do not want to save the password to a text file. This is known as the password service diskette.
- 7 Click **OK** to exit.

CAUTION

If you choose to set a supervisor or user password, Toshiba strongly recommends that you save your password in a location where you can later access it should you not remember it.

Toshiba is not responsible for any losses that may occur to you, your organization or others as a result of the inability to access your computer.

PC Diagnostic Tool Utility

This utility can help diagnose problems with devices in your computer. Refer to the online help documentation within the application for additional help.

To use the PC Diagnostic Tool utility:



- 1 Click **Start, All Programs, Toshiba, Utilities**, then **PC Diagnostic Tool**, or double-click the **PC Diagnostic Tool** icon in the **Protect & Fix** tab of **TOSHIBA Assist**.

The PC Diagnostic Tool window appears.

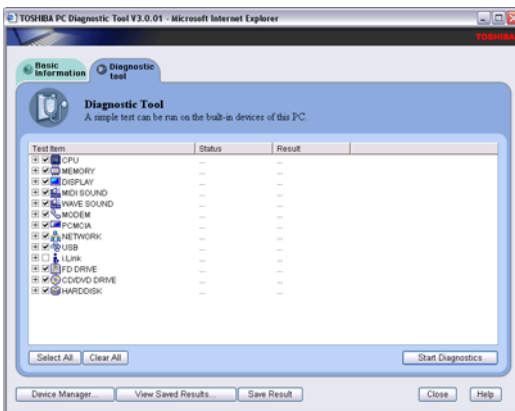

Sample PC Diagnostic Tool window

- 2 Select the devices that you would like to test by clicking the check box that appears to the left of the device.

NOTE

Click the + (plus) and - (minus) symbols to expand and collapse the categories.

- 3 Click **Start Diagnostics** when you are ready to begin the tests.

TOSHIBA Hotkey Utility

The TOSHIBA Hotkey utility allows you to receive a confirmation message when you use the Hotkey combination for Standby [Fn+F3] and Hibernation [Fn+F4].

To activate the Hotkey utility:



- 1 Click **Start, All Programs, Toshiba, Utilities, Hotkey utility**, or double-click the **Hotkey** icon in the **Optimize** tab of **TOSHIBA Assist**.

The Toshiba Hotkey window appears.

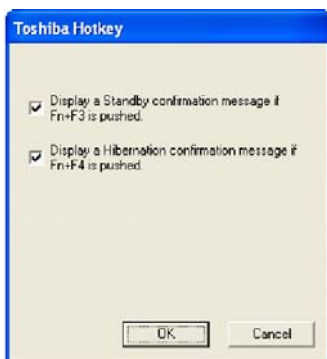

Sample TOSHIBA Hotkey utility window

- 2 Select the desired option(s).
- 3 Click **OK**.

Mouse Utility

The Mouse utility allows you to change your pointing device or mouse settings.

To access the Mouse utility:



- 1 Click **Start**, **Control Panel**, **Mouse**, or double-click the **Mouse** icon in the **Optimize** tab of **TOSHIBA Assist**.

The Mouse Properties screen appears.

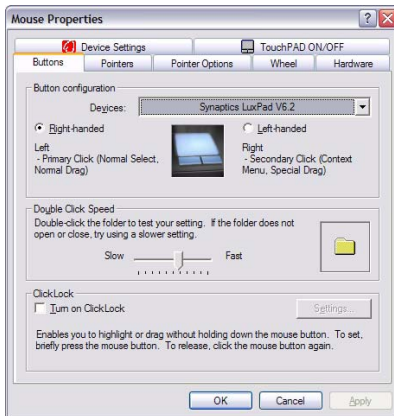

Sample Mouse Properties screen

The settings you can change are divided into these categories:

- ❖ Buttons
- ❖ Pointers
- ❖ Pointer options
- ❖ Wheel
- ❖ Hardware

You may see additional categories depending on your particular pointing device. For information on these settings, see “Using the Dual Mode Pad” on page 64.

- 2 Adjust the settings as desired, then click **OK**.

TOSHIBA Hardware Setup

TOSHIBA Hardware Setup is the Toshiba configuration management tool. To access it:



- ❖ Click **Start, All Programs, Toshiba, Utilities, Assist**, or double-click the **TOSHIBA Hardware Settings** icon in the **Optimize** tab of **TOSHIBA Assist**.

The TOSHIBA HW Setup screen appears.



Sample TOSHIBA HW Setup screen – Password tab options

The TOSHIBA HW Setup screen has the following tabs:

- ❖ **General**—Allows you to view the current BIOS version or change certain settings back to their default values.
- ❖ **Password**—Allows you to set or reset the user password for power-on.

-
- ❖ **Display**—Allows you to change various default settings for the built-in LCD display
-

NOTE

When the computer restarts, it remembers the last configuration. If data does not appear on the display you are using after starting in Standby Mode, press Fn + F5.

- ❖ **Boot Priority**—Allows you to change the sequence in which your computer searches the drives for the operating system.

You can also manually choose the Boot Priority by pressing the power button, then quickly pressing the F12 key, or the right or left arrow keys.

Select the boot device icon by pressing the right or left arrow keys, then pressing the Enter key.

NOTE

Since the system is a quick-booting system, you must press the arrow keys immediately after pressing the power button.

- ❖ **Keyboard**—Allows you to configure an external PS/2 keyboard to emulate the Fn function key and access the wake-on keyboard function.
- ❖ **USB**—Allows you to enable or disable USB Legacy Emulation.
- ❖ **LAN**—Allows you to set networking functions.

By changing any of the options that appear in the dialog boxes and clicking **Apply**, you can reconfigure that function. Any options that you change will become default settings when you restart your system.

TOSHIBA Zooming Utility

This utility allows you to select which applications will work with the zoom in/out hot keys (see “[Zooming applications in/out](#)” on page 232). Click **All Programs** to select every application. Click **Custom** to select any subset of the applications listed below:

- ❖ Microsoft® Internet Explorer
- ❖ Microsoft® Office
- ❖ Windows Media® Player
- ❖ Adobe® Reader®
- ❖ Icons on the desktop

To access the Zooming utility:

- 1 Click **Start, All Programs, Toshiba, Utilities, TOSHIBA Zooming Utility**, or double-click the **Zooming Utility** icon in the **Optimize** tab of **TOSHIBA Assist**.



The TOSHIBA Zooming Utility Properties screen appears.

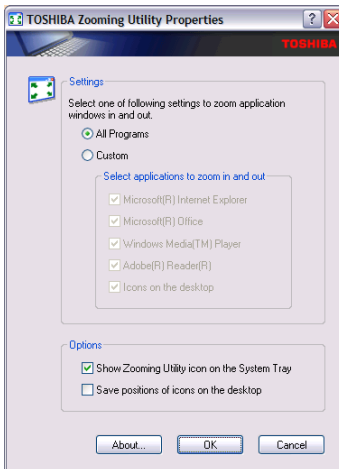

Sample TOSHIBA Zooming Utility Properties screen

- 2 Select the desired option(s).
- 3 Click **OK**.

The zoom in and zoom out hot keys will now work with the applications you selected.

To zoom in, hold down the Fn key and press 2; to zoom out, hold down the Fn key and press 1.

For more information about how to use the TOSHIBA Zooming utility, right click the  icon in the taskbar and then click **Help**.

TOSHIBA Button Controls

The TOSHIBA Button Controls allow you to customize the TOSHIBA Assist and TOSHIBA Presentation buttons. Those buttons are located just above the function keys at the top of the keyboard.

To access TOSHIBA Button Controls:



- 1 Click the **TOSHIBA Button Control** icon in the **Optimize** tab of **TOSHIBA Assist**.

The TOSHIBA Controls Properties window appears.



Sample TOSHIBA Button Controls screen

- 2 Select the button whose function is to be customized.
- 3 Make the desired selections.
- 4 Click **Apply**, then click **OK**.

CD/DVD Drive Acoustic Silencer

This utility can slow the speed of your optical drive to make it run more quietly. You can use this utility to make listening to music CDs more enjoyable.

NOTE

When you change the CD/DVD drive to “Quiet” mode, the setting is only valid for the current Windows session. If you shut down, restart, log off, or resume from hibernation, the setting will revert back to Normal speed. The setting can also be changed by CD burning software or other applications that can set the drive speed.

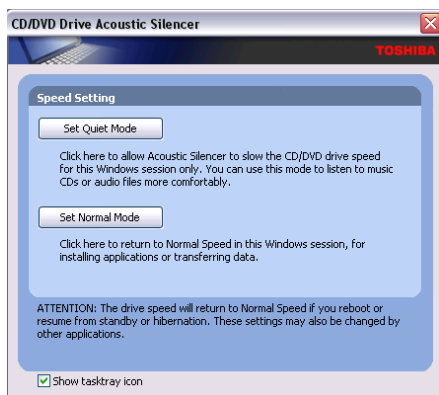

Sample CD/DVD Drive Acoustic Silencer screen



- 1 Double-click the icon in the task tray, or double-click the **CD/DVD Drive** icon in the **Optimize** tab of **TOSHIBA Assist**.

The CD/DVD Drive Acoustic Silencer screen appears.

- 2 Click **Set Quiet Mode** to make the drive run more slowly and quietly, for listening to music or audio files on a CD.
- 3 Click **Set Normal Mode** to run the drive at normal speed, for transferring data.

TOSHIBA Accessibility

The TOSHIBA Accessibility utility allows you to use the Fn key to create a hot key combination with one of the function keys without pressing the two keys simultaneously as is usually required. Using Accessibility lets you make the Fn key a *sticky key*, meaning you can press it once, release it, and then press a function key to activate the hot key function.

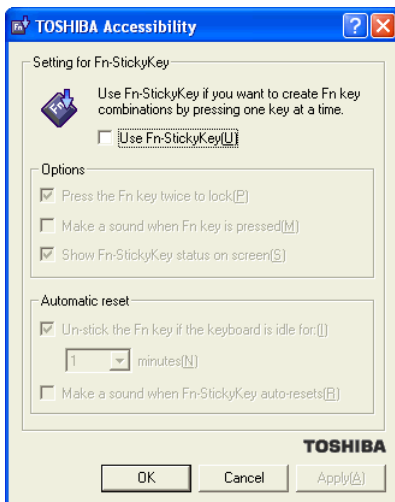

Sample TOSHIBA Accessibility window

To use TOSHIBA Accessibility:



- 1 Click the TOSHIBA Assist shortcut icon on your desktop.
- 2 Click the **Optimize** tab.
- 3 Click the **TOSHIBA Accessibility** icon.

The TOSHIBA Accessibility window appears.

- 4 Check the **Use Fn-StickyKey** box.
- 5 Put a check mark next to the desired option.
- 6 Click **OK**.

Fingerprint Authentication Utility

(Available on certain models)

The fingerprint authentication utility (available on certain models) can be used to replace the keyboard-based user/BIOS password authentication system when booting up.

The fingerprint authentication utility can also be used for user logon. The user's fingerprint is read; if the system recognizes the fingerprint, the user is automatically logged on.

Fingerprint utility limitations

Toshiba does not guarantee that the fingerprint utility technology will be completely secure or error-free. Toshiba does not guarantee that the fingerprint utility will accurately screen out unauthorized users at all times. Toshiba is not liable for any failure or damage that might arise out of the use of the fingerprint software or utility.

Fingerprint Enrollment

Use the **Enroll or Edit Fingerprints** wizard to enroll new fingerprints or to update existing fingerprint samples.

NOTE

It is recommended that you complete the Fingerprint tutorial before starting fingerprint enrollment. The fingerprint tutorial shows how to achieve the highest quality fingerprint samples.

To enroll a new fingerprint:

- 1 Click the **Fingerprints** topic in the Control Center. Click the **Enroll or Edit fingerprints** wizard.

- 2 Enter your credentials.
 - 3 Complete the fingerprint tutorial.
 - 4 Click the button above the finger you want to enroll.
 - 5 Swipe your finger on the sensor.
A sample will be created and indicated by a fingerprint icon.
 - 6 Repeat the previous step. Swipe the same finger on the sensor two more times to create two more samples.
 - 7 The final template will be created from these three samples.
-

NOTE

If you do not use a Windows password, you will be prompted to define a new (non-empty) one. This is not necessary, but a password improves the security of your software.

If your system supports power-on security, a Power-on button is also displayed above each enrolled fingerprint. This button is shown pressed by default, indicating that your finger is automatically added for power-on authentication.

During fingerprint enrollment, the system displays icons as prompts, notifications, and warnings. These icons and their meanings are as follows:



- ❖ Sensor ready. The sensor is waiting to read your fingerprint. Swipe your finger when you are ready.



- ❖ Sensor busy. Wait for the sensor to complete its operation.



- ❖ Problem with operation. The sensor could not read your fingerprint. Swipe your finger again.



- ❖ Operation succeeded. The sensor successfully read or verified your fingerprint.



- ❖ Failed to verify the user. The fingerprint could not be matched.



- ❖ Error reading fingerprint—the finger was too far to the left or right. Center your finger and swipe it again.



- ❖ Error reading fingerprint—the movement was skewed. Swipe your finger again in a straight line.



- ❖ Error reading fingerprint—the movement was too fast. Swipe your finger again at a slower speed.



- ❖ Error reading fingerprint—the movement was too short. Swipe your finger again using a longer motion.

Fingerprint Logon

The fingerprint utility enables logon to your computer using fingerprints. During user enrollment, fingerprint samples are saved and associated with the user's Windows® user account. When the user attempts to log on again, the user's fingerprint is read and compared with the user's enrolled fingerprints; if the fingerprint is recognized, user logon is completed.

The Fast User Switching feature of Windows® XP is also supported. If user A is logged on and the fingerprint utility verifies the fingerprint of user B (who is already enrolled), the utility recognizes the fingerprint and switches the users.

If your system supports power-on security, existing fingerprint samples can be used also for power-on authentication.

Power-on Security

The power-on security feature prevents unauthorized access to your computer when it is turned off by requiring the user to pass fingerprint authentication. If fingerprint authentication fails, the user will not be able to start the computer.

When power-on security is enabled, the system asks you to authenticate your fingerprint. You have 40 seconds to swipe your fingerprint.

If the authentication fails, the system tries again up to two more times. If authentication fails after the third attempt, the system shuts down.

Enabling Power-on Security

Options for power-on security are displayed only if your computer supports this feature. In most configurations, power-on security is enabled automatically after the first user fingerprints are enrolled.

To disable/enable power-on security:

- 1 Open the **Control Center** and go to **Settings - Power-on Security**. (This wizard is displayed only if your system supports power-on security.)
- 2 Check the option **Replace the power-on and hard drive passwords with the fingerprint reader**.

Power-on security can be configured to operate with the fingerprint logon feature. If a fingerprint used for power-on security matches a fingerprint in an existing passport, the corresponding user is logged on automatically without having to enter the Windows® logon password.

NOTE Your hardware must support Power-on security to use the single logon feature. You must have administrative privileges to change settings.

To enable power-on security single logon:

- 1 Open the **Control Center** and go to **Settings - System Settings**.
- 2 Select **Logon**.
- 3 Check the **Allow power-on security single sign-on** check box. (Logon support must be enabled for this option to be accessible.)

Fingerprint Management

Fingerprints are stored in memory during enrollment. After a finger is enrolled, it is displayed with a power-on button above it. The button appears “pressed in” by default, indicating that the corresponding finger will be used for power-on security. If you do not want to use a fingerprint for power-on security but only for logon, click the Boot button to delete the fingerprint from the fingerprint device memory.

The fingerprint device memory can typically hold up to 21 fingerprints. The number of slots remaining is displayed in the enrollment wizard.

Control Center

The Control Center contains various functions for fingerprint management and for setting up your fingerprint software. Available options depend on the software status, used hardware, and installed applications.

Fingerprints

- ❖ **Enroll or Edit Fingerprints**—Runs the fingerprint enrollment wizard. You can enroll/delete fingerprints for the current user and, if power-on security is implemented, control whether they are stored in the fingerprint device memory. After you enroll your fingerprints, they are associated with your user name and password. The next time you log in, you can use your fingerprints instead of your user name and password.
- ❖ **Delete**—In convenient mode, deletes all fingerprints for the current user. In secure mode, only administrators can delete data for users.
- ❖ **Import or Export User Data**—Existing fingerprints can be exported to a *.vtp file and imported back to your fingerprint software. The *.vtp file is encrypted and protected by a password that is defined during export.

Settings

- ❖ System Settings—Opens the Settings dialog containing various options for setting up the product. Most of these settings can be modified only by administrators and affect all users.
- ❖ User Settings—Opens the User Settings dialog containing user-specific options for setting up the product.
- ❖ Power-on Security—The memory of the fingerprint device is limited (typical capacity is 21 fingerprints). You can decide which fingerprints are present in the device memory and can be used for verification on computer startup, or create new fingerprints to be used only for power-on authentication.
- ❖ Fingerprint Storage Inspector—Opens the Fingerprint Storage Inspector dialog where you can see the contents of your fingerprint storage.

Help

- ❖ Introduction—Displays the Introduction dialog with basic information about product features.
- ❖ Tutorial—Runs the fingerprint tutorial which shows you how to enroll your fingerprints. This tutorial is highly recommended for first-time users of this technology. The quality of enrolled fingerprints is extremely important for your satisfaction with the product.
- ❖ Help icon—Displays this help. The help files in other languages (depending on your installation) are located in the mui subfolder of your installation folder.
- ❖ About icon—Displays version information.

Password Bank

The Password Bank stores registration and logon information for Web sites and dialogs, helping to automate the task of entering this information.

You enter the required information only once, during Web page or dialog registration. When the window is displayed again, all the data is entered automatically when you scan your fingerprint on the sensor. Registered Web pages can also be accessed directly from the Biomenu.

Biomenu

Biomenu provides access to the utility's features and settings. It is available in several variants or skins. To view or select other Biomenu skins, open the Control Center and select **Settings, User Settings**.

Swipe your finger to open Biomenu. If finger verification is configured to invoke another action (e.g., display a registered page), press and hold the Shift key while swiping your finger.

The Biomenu contains the following menu options:

- ❖ Lock computer—Locks your computer. Use the sensor to unlock the computer again.
- ❖ Registered Sites—Displays a list of your Web pages registered by Password Bank. To display and fill in a registered page in your default Web browser, click it in the list.
- ❖ Register—Registers a new window (dialog or Web page).
- ❖ Lock/unlock My Safe—Opens or closes My Safe folder.
- ❖ Control Center—Displays Control Center.
- ❖ Help—Displays this help file.

Registering a new Web page or dialog

You are logged on to the computer and want to register a new Web page.

To create a new registration:

- 1 Display a Web page you want to register.
- 2 Fill in the data you want to replay the next time you access this Web page.
- 3 Use the sensor to display the Biomenu.
- 4 Select Register.

Password Bank recognizes pages containing a password field and displays a hint that the page can be registered. These hints can be turned off in the Settings dialog.

A wizard will assist you through your first registration.

Replaying a registered Web page or dialog

You are logged on to the computer and want to replay a registered Web page.

To replay a registration:

- 1 Swipe your enrolled finger to display the Biomenu.
- 2 Select Registered Sites.
- 3 Select a page you want to display and replay, or simply verify your finger if the page is already displayed.

If you directly access a registered page from your browser without using the Biomenu's Registered Sites option, Password Bank displays a hint that the page is registered and can be replayed. These hints can be turned off in the **Password bank** tab of the **User Settings** dialog.

Replaying registrations with multiple forms

Password Bank registers forms, not pages. If a page contains several forms, each form requires a separate registration. If a page contains several forms, replaying works as follows:

- ❖ If only one form is registered for the page (regardless of how many forms the page has), that registration is replayed.
- ❖ If the page has multiple registered forms, and one of the registered forms is active, the active form is replayed.
- ❖ If the page has multiple registered forms, but there is no active form, all existing registered forms for the page are displayed. You then select the one to be replayed.

Replaying a registered dialog

You are logged on to the computer and want to replay a registered dialog.

To replay a registration:

- 1 Display the dialog to be replayed.
- 2 Use the sensor.
- 3 Optional—If the hint for replaying dialogs is displayed, confirm that you want to replay the registration.
- 4 The registration is replayed.

Editing an existing registration

Sometimes it is useful to edit an existing registration. For example, your company's address may have changed and you want to update your registrations.

To edit an existing registration:

- 1 Click the **Settings** topic in the Control Center.
- 2 Click **User Settings**. Verify your fingerprint.
- 3 Select **Registrations**.

- 4 Select a registration.
- 5 Click **Edit**.
You can change the value of an item or delete the item.
- 6 Select the **Auto submit** check box to submit the selected registration automatically after replaying the registration. A warning is displayed if you attempt to register a form or dialog that may be incompatible or not work properly with automatic submittal.

Deleting a registration

You are logged on to the computer and want to delete an existing registration.

To delete an existing registration:

- 1 Click the **Settings** topic in the Control Center.
- 2 Click **User Settings**. Verify your fingerprint.
- 3 Select **Registrations**.
- 4 Select a registration.
- 5 Click **Delete**.

How to Delete the Fingerprint Data

Fingerprint data is stored in the non-volatile memory. If the computer changes ownership, Toshiba recommends the following procedure:

- 1 Click **Start, All Programs, Protector Suite QL** then click **Control Center**.

The Protector Suite Software screen is displayed.

- 2 Click **Fingerprints** then **Delete**.
- 3 Click **Settings** then **Fingerprint Storage Inspector**.

The Fingerprint Storage Inspector screen is displayed.

- 4 If other fingerprint data is still displayed on the list, hold down the Control key and select each fingerprint until they are all selected, then click **Remove**.
- 5 Click **OK** to make the changes permanent.
- 6 Check that all Fingerprint data was deleted on the Fingerprint Storage Inspector screen.

Care and maintenance of your fingerprint sensor

Failure to follow these guidelines and/or procedures might result in (1) damage to the sensor or cause sensor failure, (2) finger recognition problems, or lower finger recognition success rate.

- ❖ Do not scratch or poke the sensor with your nails or any hard or sharp objects.
- ❖ Do not press the sensor with too much pressure.
- ❖ Do not touch the sensor with a wet finger or any wet objects. Keep sensor surface dry and free of water vapor.
- ❖ Do not touch the sensor with a soiled finger. Minute foreign particles on a soiled or dirty finger may scratch the sensor.
- ❖ Do not paste stickers or write on the sensor.
- ❖ Do not touch the sensor with a finger or any object with built-up static electricity.

Observe the following before you swipe your finger on the sensor, whether for fingerprint enrollment/registration or recognition.

- ❖ Wash and dry your hands thoroughly.
- ❖ Remove static electricity from your fingers by touching any metal surface. Static electricity is a common cause of sensor failures, especially during dry seasons such as winter.
- ❖ Clean the sensor with a lint-free cloth. Do not use detergent to clean the sensor.

- ❖ Avoid the following finger conditions for enrollment or recognition as they may result in fingerprint enrollment errors or a drop in the fingerprint recognition success rate.
 - ❖ Soaked or swollen finger (e.g. after taking bath)
 - ❖ Injured finger
 - ❖ Wet finger
 - ❖ Soiled or oily finger
 - ❖ Extremely dry skin condition on finger

Observe the following to improve the fingerprint recognition success rate.

- ❖ Enroll two or more fingers.
- ❖ Enroll additional fingers if recognition failure occurs often using enrolled fingers.
- ❖ Check your finger condition. Changed conditions, such as injured, rough, extremely dry, wet, soiled, dirty, oily, soaked or swollen fingers, may lower the recognition success rate. Also if the fingerprint is worn down or the finger becomes thinner or fatter, the recognition success rate may be lowered.
- ❖ The fingerprint for each finger is different and unique. Please ensure that only the registered or enrolled fingerprint or fingerprints are used for identification.
- ❖ Check sliding position (see illustration below).

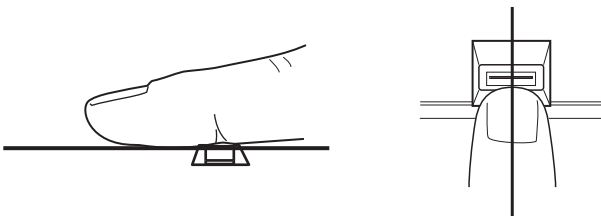

Sample aligning the finger on the sensor

Fingerprint sensor limitations

- ❖ The fingerprint sensor compares and analyzes the unique characteristics in a fingerprint. However, there may be instances where certain users are unable to register their fingerprints due to insufficiently unique characteristics in their fingerprints.
- ❖ A warning message will be displayed when recognition is abnormal or recognition is not successful within a fixed duration.
- ❖ The recognition success rate may differ from user to user.
- ❖ Toshiba does not guarantee that this fingerprint recognition technology will be error-free.
- ❖ Toshiba does not guarantee that the fingerprint sensor will recognize the enrolled user or accurately screen out unauthorized users at all times. Toshiba is not liable for any failure or damage that might arise out of the use of this fingerprint recognition software or utility.

Chapter 6

If Something Goes Wrong

Some problems you may encounter when using your computer are relatively easy to identify and solve. Others may require help from your network administrator or the manufacturer of a software program.

This chapter aims to help you solve many problems by yourself. It covers the problems you are most likely to encounter.

If all else fails, contact Toshiba. You will find information on Toshiba's support services at the end of this chapter.

Problems that are easy to fix

Your program stops responding.

If you are working with a program that suddenly freezes all operations, chances are the program has stopped responding. You can exit the failed program without shutting down the operating system or closing other programs.

To close a program that has stopped responding:

- 1 Press Ctrl, Alt, and Del simultaneously (once).

The Windows Task Manager window appears.

- 2 Click the **Applications** tab.

If a program has stopped responding, the words “not responding” appear beside its name in the list.

- 3 Select the program you want to close, then click **End Task**.

Closing the failed program should allow you to continue working. If it does not, continue with the next step.

- 4 Close the remaining programs one by one by selecting the program name, then **End Task**.

To power off your computer, do one of the following:

If you are not connected to a domain server:

- 1 Click **Start, Turn off computer**.

The Turn off computer window appears.

- 2 Click **Turn Off**.

The computer turns off.

If you are connected to a domain server:

- 1 Click **Start, Shut down**.

The Shut Down window appears.

- 2 Select **Shut down** from the drop-down list.

- 3 Click **OK**.

The computer shuts down completely.

Your program performs an illegal operation.

If you receive the message, “Your program has performed an illegal operation,” close the window and continue working. If it happens again, record the details of the message and consult the software manufacturer.

To record the details:

- 1 Click the **Details** button and select the text the operating system displays.
The Details button displays information that the software manufacturer needs to help you solve your problem.
- 2 Press Ctrl and c simultaneously to copy the text to the clipboard.
- 3 Open Notepad (click **Start, All Programs, Accessories** and then click **Notepad**).
- 4 Press Ctrl and v simultaneously to paste the details into Notepad.
- 5 Add a paragraph break and type some notes describing what you were doing when you received the message and how the error can be reproduced.
- 6 Save the file and refer to it when you contact the software manufacturer.

Problems when you turn on the computer

These problems may occur when you turn on the power.

The computer will not start.

Make sure you attached the AC adapter and power cord/cable properly or installed a charged battery.

Press and hold the power switch for at least 10 seconds.

If you are using the AC adapter, check that the wall outlet is working by plugging in another device, such as a lamp.

Verify that the computer is on by looking at the on/off indicator. If the indicator is glowing, the computer is on.

If you are using an AC adapter, verify that the computer is receiving power from the external power source by looking at the AC power light. If the indicator is glowing, the computer is connected to a live external power source.

The computer starts but when you press a key nothing happens.

Verify that the active program accepts text input. Try clicking your mouse on an area where you can type text and try typing again.

Your computer may be in Standby mode and have a software or resource conflict. When this happens turning the power on returns you to the problem instead of restarting the system. To clear the condition, press Ctrl, Alt, and Del simultaneously.

Clearing the condition may get the computer running, but it will not solve a resource conflict. Read the documentation that came with the conflicting device and [“Resolving a hardware conflict” on page 188.](#)

The computer is not accessing the hard disk or the optional external diskette drive.

Your computer normally loads the operating system from the hard disk. If you have a hard disk problem, you will not be able to start the computer. Insert a system diskette into the optional external diskette drive and press F12 when the machine starts and use the arrow keys to select the boot-up device.

The computer displays the WARNING RESUME FAILURE message.

The computer was placed in Standby mode and the battery has discharged. Data stored in the computer’s memory has been lost. Data stored in the computer’s hard drive may not be affected.

Always save your data even when you are using Standby. If your battery fully discharges, information that has not been saved will be lost. Your computer can be configured to warn you when the battery is running low see [“What to do when the main battery runs low” on page 114.](#)

If you are running on battery power, it is recommended that you do not leave the computer in Standby mode for long periods of time.

To charge the battery, leave the computer plugged into a live wall outlet for several hours. For more information see [“Charging batteries” on page 108.](#)

The computer displays the Non-System disk or disk error message.

Make sure there is no diskette in the optional external diskette drive. If there is a diskette in the drive, remove it and press any key to continue. If pressing any key does not work, press Ctrl, Alt, and Del to restart the computer. For more information see [“The computer is not accessing the hard disk or the optional external diskette drive.” on page 184.](#)

The Windows® operating system is not working

Once you are familiar with the desktop and used to the way the operating system responds to your work routine, you can easily detect if the operating system is not working correctly. For example:

- ❖ The operating system fails to start after the Starting Windows XP message appears.
- ❖ The operating system takes a long time to start.
- ❖ The operating system responds differently from the normal routine.
- ❖ The screen does not look right.

Unless a hardware device has failed, problems usually occur when you change the system in some way such as installing a new program or adding a device.

If you experience any of these problems, use the options in the Startup menu to fix the problem.

Using Startup options to fix problems

If the operating system fails to start properly, you may have to change your system's configuration or verify the startup procedure to fix the problem. To do this, use the options in the Startup menu.

To open the Startup menu:

- 1 Restart your computer.
- 2 Press F8 when your computer starts and before Windows starts loading.

The Windows® Advanced Options menu displays these options:

- ❖ Safe Mode
- ❖ Safe Mode (with Networking)
- ❖ Safe Mode (with Command Prompt)
- ❖ Enable Boot Logging
- ❖ Enable VGA Mode
- ❖ Last known good configuration (your most recent settings that worked)
- ❖ Directory Services Restore Mode (Windows® domain controllers only)
- ❖ Debugging Mode
- ❖ Start Windows® normally
- ❖ Reboot
- ❖ Return to OS Choices (menu)

See your Windows® documentation for further explanation.

NOTE

If your computer is connected to a network, the Startup menu may display different versions of Safe mode.

Internet problems

My Internet connection is very slow.

Many factors contribute to the speed with which you can surf the Internet. They include: modem speed, telephone line conditions, time of day (when everyone else is surfing, your access can be slow) and popularity of the sites you are trying to access. If accessing a particular site is very slow, try later.

My browser cannot find the URL address I typed in.

Make sure you separated the domain names of the address with the forward slash (/). Check the spelling of each name and the syntax of the address carefully. A single incorrect letter or missed character will make it impossible for your browser to locate the site.

My browser cannot find a site I bookmarked.

The World Wide Web is constantly changing. A site you bookmarked yesterday may not be available today or its server may be down for temporary repair. Try again later.

The Windows® XP operating system can help you

If the operating system has started properly but you still have a problem using your computer, the online Help can assist you in troubleshooting the problem.

To access Windows® XP Help and Support:

- 1** Click **Start**, then click **Help and Support**.

The Help and Support window appears.

- 2** Then do one or both of the following:

- ❖ In the search field, type in the topic for which you need help and follow the on-screen instructions.
- ❖ Click a problem you would like help with from the listings and follow the on-screen instructions.

You can connect to Support Online by clicking **Support** from the menu or by going to pcsupport.toshiba.com.

Resolving a hardware conflict

If you receive an error message telling you there is a device driver conflict or a general hardware problem, try using Windows® Help and Support to troubleshoot the problem first.

For help on hardware conflicts:

- 1 Click **Start**, then click **Help and Support**.
- 2 Click the **Hardware** link in the window's left pane.
A list of category links appear.
- 3 Click the **Fixing a hardware problem** link.
- 4 Choose from specific topics and follow the steps.

If there is still a problem, the operating system should display a message that explains what the conflict is.

A plan of action

The smooth operation of the system depends on the interaction of all devices, programs, and features. If the system or one of its attached devices is not working, resolving the problem can be time-consuming and frustrating.

The recommended procedure for getting multiple devices to work together is to add and set up one device at a time. After you add each device, test it to make sure it and all previously connected devices work.

The device most recently connected to the system is the one most likely to be causing a hardware conflict.

Resolving hardware conflicts on your own

Computer components need resources to accomplish a task. A device, such as a disk drive or a modem, needs a channel to the computer's Central Processing Unit (CPU). It also needs a direct channel to the computer's memory to store information as it works. These channels of communication are commonly referred to as system resources.

Interrupt Request Channel

The channel to the CPU is called an Interrupt Request (IRQ) because it interrupts what the processor is doing and requests some of the processor's time. If two or more devices use the same IRQ, the processor does not know which device is asking for attention. This causes a hardware conflict.

Direct Memory Access

Similarly, the data required by the device is stored in a specific place or address in memory called the Direct Memory Access (DMA). The DMA provides a dedicated channel for adapter cards to bypass the microprocessor and access memory directly. If two or more devices use the same DMA, the data required by one device overwrites the data required by the other, causing a hardware conflict.

Plug and Play

With Plug and Play and the operating system, avoiding hardware conflicts is easy. Plug and Play is a computer standard that helps the system BIOS (basic input/output system) and the operating system to automatically assign system resources to Plug and Play-compliant devices. In theory, if every device connected to the computer is Plug and Play-compliant, no two devices will compete for the same system resources. Plug in the device and turn on your computer. The operating system is automatically set up to accommodate the new device.

If you install an older (legacy) device that the operating system cannot recognize, the operating system may have difficulty assigning resources to it. As a result, a hardware conflict can occur.

Resolving conflicts

There are several things you can do to resolve hardware conflicts:

- ❖ Get the most recent drivers from the manufacturer.
- ❖ Disable the device.
For an older device, remove it from the computer.
- ❖ Disable another system component and use its resources for the new device. See [“Fixing a problem with Device Manager”](#) on page 190.
- ❖ Reconfigure the device so that its requirements do not conflict. Refer to the device’s documentation for instructions about changing settings on the device.

Fixing a problem with Device Manager

Device Manager provides a way to check and change the configuration of a device.

CAUTION

Changing the default settings using Device Manager can cause other conflicts that make one or more devices unusable. Device Manager is a configuration tool for advanced users who understand configuration parameters and the ramifications of changing them.

Disabling a device

- 1 Click **Start, Control Panel**, then click **Performance and Maintenance**.
- 2 Click the **Administrative Tools** icon.
- 3 Double-click **Computer Management**, then click **Device Manager**.
- 4 Select the specific device from the device category. To expand a device category, double-click the category.
- 5 In the toolbar, look to the far right for an icon of a monitor with a strike mark through a circle on the front. This is the disable feature.
- 6 Click the icon.
You are given the option of disabling the device.
- 7 Click **Yes** to disable the device or **No** to cancel.

Checking device properties

Device Manager provides a way to view the properties of a device. Properties include the name of the manufacturer, the type of device, the drivers installed, and the system resources assigned to the device.

To check a device's properties:

- 1 Click **Start, Control Panel**, then click **Performance and Maintenance**.
- 2 Click the **Administrative Tools** icon.
- 3 Double-click **Computer Management**, then click **Device Manager**.
- 4 To view the device(s) installed, double-click the device type.
- 5 To view the properties, double-click the device.

The operating system displays the Device Properties dialog box, which provides an array of tabs. They may include:

- ❖ The **General** tab, which provides basic information about the device.
- ❖ The **Resource** tab, which lists resources assigned to the monitor, optional external DVD-ROM, optional external diskette drive, and other power-using functions. This tab does not appear if the device is not using resources.
- ❖ The **Driver** tab, which displays the drivers being used by the device.

The tabs that appear in the dialog box vary from one device to another. A Troubleshooting button is also present.

6 Click Troubleshoot...

A Help and Support window for that device appears.

For more information about Device Manager, refer to Windows® XP online help.

Memory problems

Incorrectly connected or faulty memory modules may cause errors that seem to be device-related. It is worthwhile checking for these first:

1 Click Start, Turn off computer.

2 Click Turn Off.

The operating system shuts down and turns off the computer automatically.

3 Remove the memory module, following the instructions in [“Removing a memory module” on page 59.](#)

4 Reinstall the memory module, following the instructions in [“Installing a memory module” on page 54,](#) and making sure the module is seated properly.

-
- 5 Check for the error again.
 - 6 If the error recurs, remove the memory module entirely and check for the error again.

If removing the memory module eliminates the error, the memory module may be faulty. If the error recurs without the memory module installed, the error is not caused by the memory module.



TECHNICAL NOTE: You must have at least one memory module installed for the computer to work.

Power and the batteries

Your computer receives its power through the AC adapter and power cord/cable or from the system batteries (battery, optional high-capacity battery and real-time clock (RTC) battery). Power problems are interrelated. For example, a faulty AC adapter or power cord/cable will neither power the computer nor recharge the batteries.

Here are some typical problems and how to solve them:

The AC power light does not come on when you plug in the AC adapter and power cord/cable.

Make sure the AC adapter and power cord/cable are firmly plugged into both the wall outlet and the computer.

If the AC power light still does not come on, check that the wall outlet is working properly by plugging in a lamp or other appliance.

The AC adapter and power cord/cable work correctly, but the battery will not charge.

The battery does not charge while the computer is consuming full power. Try turning off the computer.

The battery may not be inserted correctly in the computer. Turn off the computer, remove the battery, clean the contacts with a soft dry cloth (if necessary) and replace the battery. See [“Removing the battery from the computer”](#) on page 119.

The battery may be too hot or too cold to charge properly. If you think this is the probable cause, let the battery reach room temperature and try again.

If the battery has completely discharged, it will not begin charging immediately. Leave the AC adapter and power cord/cable connected, wait 20 minutes and see if the battery is charging.

If the battery light is glowing after 20 minutes, let the computer continue charging the battery for at least another 20 minutes before you turn on the computer.

If the battery light does not glow after 20 minutes, the battery may have reached the end of its useful life. Try replacing it.

The battery appears not to power the computer for as long as it usually does.

If you frequently recharge a partially charged battery, it may not charge fully. Let the battery discharge completely, then try charging it again.

Check the power options using the Power Management utility. Have you added a device, such as a PC Card or memory module, that takes its power from the battery? Is your software using the hard disk more? Is the display power set to turn off automatically? Was the battery fully charged to begin with? All these conditions affect how long the charge lasts.

After a period of time, the battery will lose its ability to perform at maximum capacity and will need to be replaced. This is normal for all batteries. To purchase a new battery pack, see your accessories information that shipped with your computer, or visit the Toshiba Web site at accessories.toshiba.com. Refer to this site often to stay current on the most recent software and hardware options for your computer, and for other product information.

For more information on maximizing battery power see “Charging batteries” on page 108.

Keyboard problems

If, when you type, strange things happen or nothing happens, the problem may be related to the keyboard itself.

The keyboard produces unexpected characters.

A keypad overlay may be on. If the numlock light or cursor control mode light is on, press Fn and F10 simultaneously to turn off the cursor control mode light or Fn and F11 simultaneously to turn off the numlock light.

If the problem occurs when both the keypad overlays are off, make sure the software you are using is not remapping the keyboard. Refer to the software documentation and check that the program does not assign different meanings to any of the keys.

You have connected an external keyboard and the operating system displays one or more keyboard error messages.

The keyboard you connected may be defective or incompatible with the computer. Try using a different make of keyboard.

Nothing happens when you press the keys on the external keyboard.

You may have plugged the external keyboard in while the computer was turned on. Click **Start**, **Shut Down** or **Turn off computer**, and **Restart the computer** using the Dual Mode Pad on the internal keyboard. The computer will restart and recognize the device.

Display problems

Here are some typical display problems and their solutions:

The screen is blank.

Display Auto Off may have gone into effect. Press any key to activate the screen.

You may have activated the instant password feature by pressing Fn and F1 simultaneously. If you have registered a password, press any key, type the password and press Enter. If no password is registered, press any key. The screen reactivates and allows you to continue working.

If you are using the built-in screen, make sure the display priority is not set for an external monitor. To do this, press Fn and F5 simultaneously (once). If this does not correct the problem, press Fn and F5 simultaneously again to return the display priority to its previous setting.



HINT: Holding the Fn key and pressing the F5 key several times will advance you through the display options.

If you are using an external monitor:

- ❖ Check that the monitor is turned on.
- ❖ Check that the monitor's power cord/cable is firmly plugged into a working power outlet.
- ❖ Check that the cable connecting the external monitor to the computer is firmly attached.

- ❖ Try adjusting the contrast and brightness controls on the external monitor.
- ❖ Press Fn and F5 simultaneously to make sure the display priority is not set for the built-in screen.

The screen does not look right.

You can change the display settings by clicking a blank area of the desktop with the secondary control button, then clicking **Properties**. This opens the Display Properties dialog box. The **Appearance** tab of this dialog box allows you to choose the colors for the screen. The **Settings** tab allows you to choose the screen resolution.

The built-in screen flickers.

Some flickering is a normal result of the way the screen produces colors. To reduce the amount of flickering, try using fewer colors.

To change the number of colors displayed:

- 1** Point at the desktop and click with the secondary button.
- 2** Click **Properties**, and then the **Settings** tab.
- 3** Change the Colors option and click **OK**.

For more information see Windows® Help.

A message tells you that there is a problem with your display settings and that the adapter type is incorrect or the current settings do not work with your hardware.

Reduce the size of the color palette to one that is supported by the computer's internal display.

To change the display properties:

- 1** Point at the desktop and click with the secondary button.
The Display Properties window appears.
- 2** Click **Properties**, then click the **Settings** tab.
- 3** Adjust the screen resolution and/or color quality.

4 Click OK.**The display mode is set to Simultaneous and the external display device does not work.**

Make sure the external monitor is capable of displaying at resolutions of 800 x 600 or higher. Devices that do not support this resolution will only work in Internal/External mode, and not simultaneous mode.

Small bright dots appear on your TFT display when you turn on your computer.

Small bright dots may appear on your screen display when you turn on your PC. Your display contains an extremely large number of thin-film transistors (TFT) and is manufactured using high-precision technology. Any small bright dots that may appear on your display are an intrinsic characteristic of the TFT manufacturing technology. Over a period of time, and depending on the usage of the computer, the brightness of the screen will deteriorate. This is also an intrinsic characteristic of the screen technology. When the computer is operated on battery power, the screen will dim and you may not be able to increase the brightness of the screen while on battery power.

Disk drive problems

Problems with the hard disk or with a diskette drive usually show up as an inability to access the disk or as sector errors. Sometimes a disk problem may cause one or more files to appear to have garbage in them. Typical disk problems are:

You are having trouble accessing a disk, or one or more files appear to be missing.

Make sure you are identifying the drive by its correct name (A: or C:).

Error-checking

Run Error-checking, which analyzes the directories, files and File Allocation Table (FAT) on the disk and repairs any damage it finds:

To run Error-checking:

- 1 Click **Start**, then click **My Computer**.
- 2 Right-click the drive you want to check.
- 3 On the pop-up menu, click **Properties**.

The drive's Properties box appears.

NOTE This feature is not available for CD/DVD drives.

- 4 Click the **Tools** tab.
- 5 Click the **Check now** button.
The Check Disk All Apps box appears.
- 6 You can choose one or both options:
 - ❖ Automatically fix file system errors
 - ❖ Scan for and attempt recovery of bad sectors
- 7 Click **Start**.

Error-checking tests and repairs the disk.

Your hard disk seems very slow.

If you have been using your computer for some time, your files may have become fragmented. Run Disk Defragmenter. To do this, click **Start**, then click **All Programs**, point to **Accessories** and **System Tools**, and click **Disk Defragmenter**.

Your data files are damaged or corrupted.

Refer to your software documentation for file recovery procedures. Many software packages automatically create backup files.

You may also be able to recover lost data using utility software. Consult your network administrator.

Some programs run correctly but others do not.

This is probably a configuration problem. If a program does not run properly, refer to its documentation and check that the hardware configuration meets its needs.

A diskette will not go into the optional external diskette drive.

You may already have a diskette in the drive. Make sure the drive is empty.

You may be inserting the diskette incorrectly. Hold the diskette with the hub side facing down, and insert it so that the metal head window cover goes into the drive first.

The metal cover or a loose label may be obstructing the path into the drive. Carefully inspect the diskette. If the metal cover is loose, replace the diskette. If the label is loose, replace the label and try inserting the diskette again.

The computer displays the Non-system disk or disk error message.

If you are starting the computer from a diskette, the diskette in the drive does not have the files necessary to start the computer. Replace it with a bootable diskette.

The drive cannot read a diskette.

Try another diskette. If you can access the second diskette, the first diskette (not the drive) is probably causing the problem. Run Error-checking on the faulty diskette (for instructions see [“Disk drive problems” on page 198](#)).

CD-RW/DVD-ROM or multi-function drive problems

You cannot access a disc in the drive.

If the CD-RW/DVD-ROM or multi-function drive is an external drive, make sure that the drive's cable is properly connected to the computer.

Make sure the tray which holds the CD-ROM or DVD-ROM is closed properly. Press gently until it clicks into place.

Open the tray and remove the disc. Make sure the tray is clean. Any dirt or foreign object can interfere with the laser beam.

Examine the disc to see if it is dirty. If necessary, wipe it with a clean cloth dipped in water or a neutral cleaner.

Replace the disc in the tray. Make sure that the disc is lying flat, label side uppermost. Close the tray carefully, making sure it has shut completely.

You press the disc eject button, but the drive tray does not slide out.

Make sure the computer is connected to a power source and turned on. The CD-RW/DVD-ROM or multi-function drive eject mechanism requires power to operate.

Make sure a program is not accessing the drive and preventing it from ejecting.

If you need to remove a disc and cannot turn on the computer (for example, if the battery is completely discharged), use a narrow object, such as a straightened paper clip, to press the manual eject button. This button is in the small hole next to the DVD-ROM eject button on the face of the DVD-ROM tray.

CAUTION

Never use a pencil to press the manual eject button. Pencil lead can break off inside the computer and damage it.

Some discs run correctly but others do not.

Check the type of disc you are using. The CD-RW/DVD-ROM or multi-function drive supports the Digital Versatile Disc (DVD) formats DVD-ROM, DVD-R (read-only), plus CD-ROM, CD-R (read-only), and CD-RW (read-only).

If the problem is with a data CD or DVD, refer to the software's documentation and check that the hardware configuration meets the program's needs.

The disc will not come out of the drive when you click the eject button on the screen.

Press the button on the CD-RW/DVD-ROM or multi-function drive itself. For additional information see [“You press the disc eject button, but the drive tray does not slide out.” on page 201.](#)

Sound system problems**You do not hear any sound from the computer.**

Adjust the volume control.

Try pressing Fn + Esc to see if volume mute is disabled.

If you are using external headphones or speakers, check that they are securely connected to your computer.

The computer emits a loud, high-pitched noise.

This is feedback between the microphone and the speakers. It occurs in any sound system when input from a microphone is fed to the speakers and the speaker volume is too loud. Adjust the volume control.

PC Card problems

PC Cards (PCMCIA-compatible) include many types of devices, such as a removable hard disk, additional memory, or a pager.

Most PC Card problems occur during installation and setup of new cards. If you are having trouble getting one or more of these devices to work together, several sections in this chapter may apply.

Resource conflicts can cause problems when using PC Cards. See [“Resolving a hardware conflict” on page 188](#).

Card Information Structure

When you insert a PC Card into a slot, the computer attempts to determine the type of card and the resources it requires by reading its Card Information Structure (CIS). Sometimes the CIS contains enough information for you to use the card immediately.

Other cards must be set up before you can use them. Use the Windows[®] XP PC Card (PCMCIA) Wizard to set up the card. Refer to your Microsoft[®] documentation for more information, or refer to the documentation that came with the PC Card.

Some card manufacturers use special software called *enablers* to support their cards. Enablers result in nonstandard configurations that can cause problems when installing the PC Card.

If your system does not have built-in drivers for your PC Card and the card did not come with an operating system driver, it may not work under the operating system. Contact the manufacturer of the PC Card for information about using the card under the operating system.

PC Card checklist

- ❖ Make sure the card is inserted properly into the slot.
- ❖ Make sure all cables are securely connected.
- ❖ Occasionally a defective PC Card slips through quality control. If another PCMCIA-equipped computer is available, try the card in that machine. If the card malfunctions again, it may be defective.

Resolving PC Card problems

Here are some common problems and their solutions:

The slot appears to be dead. PC Cards that used to work no longer work.

Check the PC Card status:

- 1** Click **Start**.
- 2** Click **My Computer** icon with the secondary button, then click **Properties**.

The System Properties dialog box appears.

- 3** Click the **Hardware** tab.
- 4** Click the **Device Manager** button.
- 5** Double-click the **PCMCIA adapter**.
- 6** Double-click the appropriate PC Card.

The operating system displays your PC Card's Properties dialog box, which contains information about your PC Card configuration and status.

The computer stops working (hangs) when you insert a PC Card.

The problem may be caused by an I/O (input/output) conflict between the PCMCIA socket and another device in the system. Use Device Manager to make sure each device has its own I/O base address. See [“Fixing a problem with Device Manager” on page 190](#) for more information.

Since all PC Cards share the same socket, each card is not required to have its own address.

Hot swapping (removing one PC Card and inserting another without turning the computer off) fails.

Follow this procedure before you remove a PC Card:



- 1** Double-click the **Safely Remove Hardware** icon on the System tray.
- 2** Select the item you wish to remove.
- 3** Click **Stop**.
- 4** Remove the device when prompted to do so.
- 5** Click **OK** three times to close the **Safely Remove Hardware** screen.

CAUTION

Never swap modules when the computer is in Hibernation or Standby mode. This is known as “warm swapping” and is not supported with this computer. For more information on Hibernation and Standby modes see [“Hibernation mode” on page 75](#) and [“Standby mode” on page 76](#).

The system does not recognize your PC Card.

Refer to the PC Card documentation.

Removing a malfunctioning card and reinstalling it can correct many problems.

A PC Card error occurs.

Reinsert the card to make sure it is properly connected.

If the card is attached to an external device, check that the connection is secure.

Refer to the card's documentation, which should contain a troubleshooting section.

Printer problems

This section lists some of the most common printer problems:

The printer will not print.

Check that the printer is connected to a working power outlet, turned on and ready (on line).

Check that the printer has plenty of paper. Some printers will not start printing when there are just two or three sheets of paper left in the tray.

Make sure the printer cable is firmly attached to the computer and the printer.

Run the printer's self-test to check for any problem with the printer itself.

Make sure you installed the proper printer drivers as shown in ["Setting up your printer" on page 72](#) or in the instructions that came with the printer.

You may have connected the printer while the computer is on. Disable Standby mode, turn off the computer, and turn off the printer. Turn the printer back on, make sure it is on line, then turn the computer back on.

Try printing another file. For example, you could create and attempt to print a short test file using Notepad. If a Notepad file prints correctly, the problem may be in your original file.

If you cannot resolve the problem, contact the printer's manufacturer.

The printer will not print what you see on the screen.

Many programs display information on the screen differently from the way they print it. See if your program has a print preview mode. This mode lets you see your work exactly as it will print. Contact the software manufacturer for more information.

Modem problems

This section lists common modem problems:

The modem will not receive or transmit properly.

Make sure the cable from the modem to the telephone line is firmly connected to the computer's modem port and the telephone line jack.

Check the port settings to make sure the hardware and software are referring to the same COM port. See [“Determining the COM port” on page 130](#).

Check the communications parameters (baud rate, parity, data length and stop bits) specified in the communications program. It should be set up to transmit at 300, 1200, 2400, 4800, 9600, 14400, 28800, 33600 bps (bits per second) or higher. Refer to the program's documentation and the modem manual for information on how to change these settings.

The modem is on, set up properly and still will not transmit or receive data.

Make sure the line has a dial tone. Connect a telephone handset to the line to check this.

The other system may be busy or off line. Try making a test transmission to someone else.

For more information regarding your system's V.92 modem, visit the Toshiba Web site at pcsupport.toshiba.com.

Wireless networking problems

NOTE

This section provides general troubleshooting tips for networking problems, specifically wireless (Wi-Fi) networking.

The terms and concepts used assume a basic understanding of networks, and may be for more advanced users. If you need assistance or if you are not familiar with the terminology, please see Windows Help and Support or contact your computer technician.

- ❖ If your computer is equipped with an internal Wi-Fi adapter, verify that the Wi-Fi antenna switch is on (the light next to the wireless antenna on/off switch will be lit.)
-

NOTE

To determine if your computer has an internal Wi-Fi adapter, check the device list in Device Manager (part of the Windows Control Panel). Some Toshiba models may have a Wi-Fi antenna switch even though they do not have an internal Wi-Fi adapter.

- ❖ Verify that signal strength is good using the utility provided with the Wi-Fi adapter.
- ❖ If another computer is on the same network, verify that it has network access, and can connect to the Internet. If, for example, the other computer cannot browse to a public Web site, the ISP's (Internet Service Provider) service may be disrupted.
- ❖ Verify that the Service Set Identifier (SSID), or network name, is correct—i.e., that it matches the SSID assigned to the access point you are attempting to connect through. SSIDs are case-sensitive. Toshiba provides a Client Manager utility for setting and managing SSIDs.

- ❖ Check Control Panel's Device Manager to verify that the Wi-Fi adapter is recognized by Windows®, and that the driver is loaded. Carefully note any error messages—these will be very helpful if you should confer with a support technician at a later time.
- ❖ Verify that the network connection is configured to obtain its Internet Protocol (IP) address dynamically:
 - 1 Click **Start, Control Panel**.
 - 2 Double-click **Network Connections**.
 - 3 Right-click the name of your wireless network connection, then click **Properties**.
 - 4 Select **Internet Protocol (TCP/IP)**, then click **Properties**.
 - 5 Select **Obtain an IP address automatically**.
 - 6 Click **OK**, then click **Close**.
- ❖ Use IPCONFIG to verify that the computer has a useful IP address—one other than the private address of 169.254.xxx.xxx assigned by Windows.
 - ❖ Click **Start**, then click **Run...**
 - ❖ Enter **Cmd** and press **Enter**.
 - ❖ Enter **"IPCONFIG /ALL"** and press **Enter**.
 - ❖ The IP address for each active network adapter will be displayed.
- ❖ Connect your computer directly to your router or broadband modem, by plugging a standard CAT5 Ethernet patch cable (sold separately) into your computer's RJ45 Ethernet port. If your connection problem disappears, the problem lies in the Wi-Fi part of your network.

- ❖ Use the PING command to verify a connection to the gateway at 192.168.1.1 (a default gateway for most wireless routers).
 - ❖ Click **Start**, then click **Run...**
 - ❖ Enter **Cmd** and press **Enter**.
 - ❖ Enter **PING 192.168.1.1** at the command prompt, and press **Enter**.
 - ❖ If “Request Timed Out” or another error message appears in response, then the problem is probably Wi-Fi-related.
- ❖ If you have enabled any security provisions (closed system, MAC address filtering, Wired Equivalent Privacy (WEP), etc.), check the access point vendor's Web site for recent firmware upgrades. Problems with WEP keys, in particular, are frequently addressed in new firmware releases.

Special considerations for Windows XP

Wired Equivalent Privacy (WEP) encryption is not enabled on the wireless access point.

When you install a wireless access point device, Windows XP checks whether WEP encryption is enabled on the device. If it is not enabled, Windows XP adds the device to its list of available wireless networks, but does not create a wireless connection using the device, since the connection would not be secure. You can still, however, use the access point. To use an access point without WEP encryption, follow these steps:

- ❖ Right-click the **Wireless Network** icon in the System Tray (far-right portion of the Windows Taskbar).
- ❖ Click **View Available Wireless Networks**.
- ❖ Select **Allow me to connect to the selected wireless network, even though it is not secure**.
- ❖ Windows XP will now try to establish a wireless connection.

The Windows XP wireless management facility does not work.

If you are using an external Wi-Fi adapter (a PC Card, USB adapter, or other variety), check if the adapter comes with its own management utility. If it does, the utility may be disabling the Windows XP wireless management facility, in which case you must use the adapter's management utility. If the documentation that accompanies the adapter does not provide enough information to determine if this is the case, contact that vendor's support group for further advice.

DVD operating problems

If you experience a problem playing DVDs, you may be able to fix the problem yourself.

For general problems playing a DVD title, try the following steps:

- 1 Verify that the disc is in a format that the drive supports.
- 2 Ensure that the disc is properly inserted in the drive tray.
- 3 Ensure that the Display properties are not True Color (24-bit). If it is set to 24-bit color, there may be a video format error. To verify your display settings:
 - ❖ Click **Start, Control Panel, Appearance and Themes**, and double-click **Display**.
 - ❖ Click on the **Settings tab** and check the **Color Palette**. It should be set to **High Color** (16-bit).
 - ❖ If it is not set to High Color, change the settings to **16-bit color** and click **OK**.
- 4 Clean the disc and try again.

A dirty drive can also cause audio problems. If you have tried several discs and all fail, consider sending your drive to an authorized service provider to get it cleaned.

- 5 Verify that your computer recognizes your CD-RW/DVD-ROM or multi-function drive. To do this:
Double-click the **My Computer** icon on the desktop. The CD-RW/DVD-ROM or multi-function drive should appear in the list.
- 6 See “[Checking device properties](#)” on page 191 for instructions on using Device Manager to view the DVD-ROM properties.
- 7 Check the Toshiba Web site for new information on DVD-ROM drives and their operation.

A blank screen appears while watching a DVD-ROM movie or title.

Disable the Shut off Monitor feature in the Display Properties using the following steps:

- 1 Click the secondary mouse button on a blank area of the desktop.
- 2 Click **Properties**.
- 3 Click the **Screen Saver** tab.
- 4 Deselect **Shut off Monitor**.

Jumping video lines appear around the DVD-ROM video window.

To change the screen’s display resolution:

- 1 Click **Start, Control Panel**.
The Control Panel window appears.
- 2 Click **Appearance and Themes**, and double-click the **Display** icon.
The Display Properties dialog box appears.
- 3 Click the **Settings** tab.
- 4 Next to the words **Desktop Area**, move the slider to a lower setting, such as 800 x 600 or 640 x 480.

- 5 Click **OK**.

DVD titles, games, or applications appear distorted.

Having Stretch enabled when your video resolution is set to 640 x 480 or 800 x 600 can cause distortion. To disable Stretch, follow the instructions below:

- 1 Right-click the **Desktop**, select **Properties**.
- 2 Select the **Settings** tab.
- 3 Select the **Advanced Flat Panel** tab.
- 4 Click **Disable Display Stretch Feature**.
- 5 Click **OK**.

The screen saver runs while you are watching a movie or title.

If the screen saver is enabled, it runs on top of any movie or title you are watching. To disable the screen saver:

- 1 Click **Start, Control Panel**.
The Control Panel window appears.
- 2 Click **Appearance and Themes**, and double-click the **Display** icon.
The Display Properties dialog box appears.
- 3 Click the **Screen Saver** tab.
In the Screen Saver list, the current screen saver is highlighted.
- 4 Click the down arrow at the right of the current screen saver name.
A list of screen savers displays.
- 5 Click and hold the up arrow by the list or move the slide to the top.
- 6 Click **None**.
- 7 Click **OK**.

Develop good computing habits

Save your work frequently.

You can never predict when your computer will lock, forcing you to close a program and lose unsaved changes. Many software programs build in an automatic backup, but you should not rely solely on this feature. Save your work! See [“Computing tips” on page 83](#) for instructions.

On a regular basis, back up the information stored on your hard disk.

Here are some ways you can do this:

- ❖ Copy files to diskette.
- ❖ Connect a tape drive to the system and use specialized software to copy everything on the hard disk to a tape.
- ❖ Connect your computer to the office network and copy files to your network partition.

Some people use a combination of these methods, backing up all files to tape weekly and copying critical files to diskette on a daily basis.

If you have installed your own programs, you should back up these programs as well as your data files. If something goes wrong that requires you to reformat your hard disk and start again, reloading all your programs and data files from a backup source will save time.

Read the user’s guides.

It is very difficult to provide a fail-safe set of steps you can follow every time you experience a problem with the computer. Your ability to solve problems will improve as you learn about how the computer and its software work together.

Get familiar with all the user’s guides provided with your computer, as well as the manuals that come with the programs and devices you purchase.

Your local computer store or book store sells a variety of self-help books you can use to supplement the information in the manuals.

Data and system configuration backup in Windows XP

Windows XP offers some easy-to-use features for backing up your Windows settings and your data – documents and other important files. Take advantage of these features to protect yourself from much more difficult and time-consuming restoration procedures, and to safeguard your valuable data from loss.

Saving system configuration with Restore Points

The System Restore feature of Windows XP quickly creates Restore Points—‘snapshots’ of your Windows configuration—and saves them for later recall. If you experience problems after installing some new hardware or software, you can easily select a previously established Control Point to ‘turn back the clock,’ restoring Windows to the state it was in just prior to the installation. This is much easier and more effective than uninstalling the hardware or software, which often leaves behind unwanted files and settings. It is also easy to undo a Restore Point selection, if you change your mind.

Follow these steps to create a Restore Point using the System Restore utility:

- 1** Click **Start**.
- 2** Click **Help and Support**.
- 3** Under **Pick a Task**, click **Undo changes to your computer with System Restore**.
- 4** Click **Create a restore point**, and then click **Next**.
- 5** In the **Restore point description** field, enter a name that is descriptive enough to be easily understood in the future, such as “Before installing Brand X Accounting app.” Then click **Create**.

- 6 Windows creates the Restore Point and automatically stamps it with the current date and time.

Then, at a later time, you can re-establish your Windows configuration using the saved Restore Point. To do this:

- 1 Click **Start**.
- 2 Click **Help and Support**.
- 3 Under **Pick a Task**, click **Undo changes to your computer with System Restore**.
- 4 Click **Restore my computer to an earlier time**, then click **Next**.
- 5 A calendar will be presented, showing a month at a time. Each date for which a Restore Point has been set will be marked as bold. When a boldfaced date is clicked, a description of the Restore Point will appear in a list to the right.

NOTE

This list may contain Restore Points that you did not create. Restore Points labeled System Checkpoint were automatically created by Windows XP. Other Restore Points may have been created automatically by applications when they were installed.

- 6 Select the desired Restore Point from the list, and then click **Next**.
- 7 Your Windows configuration will now be restored to the state it was in when the chosen Restore Point was created.

Backing up your data to CDs with Windows XP

For most of us, by far the most valuable component of our computer system is the data we have created with it, and stored on its hard disk drive. Since problems with either hardware or software can make the data inaccessible or even destroy it, the next most valuable component of your computer system may be a recent backup of your data.

Fortunately, Windows XP offers a convenient way to back up your important data files to CDs, a relatively high-capacity storage media. No additional software is required. Most of the CD and DVD drives built into recent Toshiba portable computer models can write to (or ‘burn’) as well as read from CDs. External CD and DVD writers are also widely available.

Follow these steps to back up files in the **My Documents** folder to one or more CDs:

- 1** Put a blank CD-R (CD-recordable) disc into the computer’s CD or CD-RW/DVD or multi-function drive.
- 2** A menu of options will appear. Select **Open writable CD folder using Windows Explorer**, and click **OK**.
- 3** A Windows Explorer window will open for the blank CD. This window will be referred to as “the CD window.”
- 4** Open a second Windows Explorer window, by clicking **Start**, then **My Computer**.
- 5** In this second window, browse to the files you wish to back up. Click the down-pointing arrow at the upper right of the window (to the left of the **Go** button) to see a list of locations that includes **My Documents**—a likely location of your data.
- 6** Drag and drop folders or individual files from this window into the CD window. If the files do not immediately appear in the CD window, press **F5** (or click **View, Refresh**) to prompt Windows to display them.

NOTE

Documents and other data files that you create as you work are typically stored in the My Documents folder. You may also wish to back up other important data files stored elsewhere on your hard disk drive, for example:

- ❖ E-mail files and settings—for Outlook, Outlook Express, or other e-mail apps. Visit the vendors' Web sites (www.microsoft.com, for example) for detailed instructions.
- ❖ Newsgroup files and settings—for Outlook Express, or other newsgroup readers. Visit the vendors' Web sites for detailed instructions.
- ❖ Other data files. If you do not find an application's data files in any of the folders within the My Documents folder, check the application's options or preferences settings to discover the locations of the files.

- 7 When you have finished copying files to the CD window, click **File, Write these files to CD**.
- 8 A CD Writing Wizard will appear, prompting for a name for the CD. You may accept the default name, or enter a new (more descriptive) name. Click **Next** to continue.
- 9 The CD Writing Wizard will now write the selected files to the CD. It is best not to use the computer for any other tasks during this operation, so as not to interrupt it.
- 10 Finally, click **Finish**. The CD will be ejected. It should contain all of the files you have selected, but you may easily verify this by placing the CD back into the drive, and viewing the list of files.

Favorites (bookmarks) for Internet Explorer and other Web browsers

Follow these steps to back up your Favorites for Internet Explorer (ver 5.0 or newer):

- 1** In Internet Explorer, click **File, Import and Export**.
- 2** The Import/Export Wizard will appear. Click **Next**.
- 3** Click **Export Favorites, Next**. (To restore the Favorites to the hard disk drive later you would select **Import Favorites** from this list.)
- 4** A list of your Favorites folders will appear, with the top-level Favorites folder selected (highlighted). Click **Next** to back up all of your Favorites, or select a particular Favorites folder to back up, then click **Next**.
- 5** In the Export Favorites Destination window, use the Browse button to browse to the **My Documents** folder. Click **Save** in the Select Bookmark file window, and then click **Next**.
- 6** Click **Finish**. The message “**Successfully exported favorites**” should appear.
- 7** Follow the steps above for backing up files from the **My Documents** folder to a CD.

Each CD has room for 650-700 megabytes of data. Follow this same set of steps any number of times to back up any number of files to as many CDs as is required to hold them.

Windows XP also includes a Backup utility, though it does not directly support writing to CDs. For more information, click **Start, Help and Support**, or start the Backup utility by clicking **Start, All Programs, Accessories, System Tools, Backup**.

General tips for installing hardware and software

Here are a few tips to help insure safe and easy installation of new hardware (printers, pointing devices, external hard drives, DVD writers, scanners, etc.) and software (applications like Microsoft Office or utility software such as special toolbars for your Web browser).

- ❖ Create a Restore Point (see [“Saving system configuration with Restore Points” on page 215](#)). Before installing anything, use the System Restore utility to set a Restore Point (see the section titled Restore Points). If anything goes wrong, you will then be able to easily restore Windows to the state it was in prior to the installation, undoing any changes the installation process introduced.
- ❖ Back up your critical data (see [“Backing up your data to CDs with Windows XP” on page 217](#)).
- ❖ Have your factory Restore/Reconfiguration CD(s) on hand in case you need any files from them.
- ❖ Do not guess; follow directions carefully! It is often necessary to run an installation utility first—before connecting a new hardware item to the computer. If the device is connected first, it may be very difficult to complete the installation successfully. Always carefully follow the installation instructions that accompany the hardware or software.
- ❖ Restart Windows. Always restart Windows after each installation, even if the installation utility does not prompt you to do so. This will insure that the installation is completed, and will clean up anything that the installation utility left behind.
- ❖ Do one installation at a time. If you have several new items to add to your computer system, install just one at a time, creating Restore Points immediately before each successive installation. This will make it much easier to determine the origin of any new problems. For best results, follow this sequence:

- 1** Back up critical data.
- 2** Create a Restore Point.
- 3** Install one item of hardware or software.
- 4** Restart Windows.
- 5** Use the new hardware or software for a while, noting any new problems. Make sure that your critical applications (e-mail, business apps, etc.) are working correctly, and verify that important devices are still functioning.
- 6** For each additional hardware or software item, repeat these steps, starting at step 1 if any of your critical data has changed, or starting at step 2 if no critical data has changed.

If you need further assistance

If you have followed the recommendations in this chapter and are still having problems, you may need additional technical assistance. This section contains the steps to take to ask for help.

Before you contact Toshiba

Since some problems may be related to the operating system or the program you are using, it is important to investigate other sources of assistance first.

Try the following before you contact Toshiba:

- ❖ Review the troubleshooting information in your operating system documentation.
- ❖ If the problem occurs while you are running a program, consult the program's documentation for troubleshooting suggestions. Contact the software company's technical support group for their assistance.
- ❖ Consult the dealer from whom you purchased your computer and/or program. Your dealer is your best source for current information.

Detailed system specifications are available at www.ts.toshiba.com by selecting your particular product and model number, clicking **GO**, and then clicking the **Detailed Specs** link from the menu on the left, or just refer to the computer documentation shipped with your product.

For the number of a Toshiba dealer near you in the United States, call: (800) 457-7777.

Contacting Toshiba

If you still need help and suspect that the problem is hardware-related, Toshiba offers a variety of resources to help you.

Toshiba's Technical Support Web site

For technical support, or to stay current on the most recent software and hardware options for your computer, and for other product information, be sure to regularly check the Toshiba Web site at pcsupport.toshiba.com.

Toshiba voice contact

Before calling Toshiba, make sure you have:

- ❖ Your computer's serial number
- ❖ The computer and any optional devices related to the problem
- ❖ Backup copies of your Windows® operating system and all other preloaded software on your choice of media
- ❖ Name and version of the program involved in the problem along with its installation media
- ❖ Information about what you were doing when the problem occurred
- ❖ Exact error messages and when they occurred

For technical support, call the Toshiba Global Support Centre:

Within the United States at (800) 457-7777

Outside the United States at (949) 859-4273

Other Toshiba Internet Web sites

toshiba.com	Worldwide Toshiba corporate site
computers.toshiba.com	Marketing and product information in the USA
accessories.toshiba.com	Accessories information in the USA
www.toshiba.ca	Canada
www.toshiba-Europe.com	Europe
www.toshiba.co.jp/index.htm	Japan
http://servicio.toshiba.com	Mexico and all of Latin America

Toshiba's worldwide offices

Australia

Toshiba (Australia) Pty. Limited
84-92 Talavera Road
North Ryde NSW 2113
Sydney
Australia

France

Toshiba Systèmes (France) S.A.
7, Rue Ampère; B. P. 131
92800 Puteaux Cédex
France

Canada

Toshiba Canada Ltd.
191 McNabb Street
Markham, Ontario
L3R - 8H2
Canada

Germany

Toshiba Europe GmbH
Leibnizstraße 2
D-93055 Regensburg
Germany

Italy

Centro Direzionale Colleoni
Palazzo Perseo
Via Paracelso 10
20041, Agrate Brianza
Milano, Italy

Latin America and Caribbean

Toshiba America Information
Systems
9740 Irvine Blvd.
Irvine, California 92618
USA

800-457-7777 (within the US)

949-859-4273 (outside of the US -
this call may incur long-distance
charges)

Spain

Toshiba Information Systems
(España) S.A.
Parque Empresarial San Fernando
Edificio Europa, 1a Planta
Escalera A
28831 (Madrid) San Fernando de
Henares
Spain

United States

Toshiba America Information
Systems, Inc.
9740 Irvine Boulevard
Irvine, California 92618
United States

Japan

Toshiba Corporation, PCO-IO
1-1, Shibaura 1-Chome
Minato-Ku, Tokyo, 105-8001
Japan

Mexico

Toshiba de México S.A. de C.V.
Sierra Candela No.111, 6to. Piso
Col. Lomas de Chapultepec.
CP 11000 Mexico, DF.

United Kingdom

Toshiba Information Systems
(U.K) Ltd.
Toshiba Court
Weybridge Business Park
Addlestone Road
Weybridge, Surrey KT15 2UL
United Kingdom

The Rest of Europe

Toshiba Europe (I.E.) GmbH
Hammfelddamm 8
D-4-1460 Neuss
Germany

For more information on additional Toshiba worldwide
locations, please visit: www.toshiba.co.jp/index.htm.

Appendix A

Hot Keys

Hot keys are keys that, when pressed in combination with the Fn key, turn system functions on and off. Hot keys have a legend on the key indicating the option or feature the key controls.

Volume Mute

Fn +



This hot key enables/disables volume mute on your computer.

When volume mute is enabled, no sound will come from the speakers or headphones.

Password security

Fn +



This hot key blanks the display.

Without a password

The Fn + F1 key combination turns off the display and activates instant security. Using the pointing device or any key will make the display's content reappear, if no password is set for the current user.

With a password

The Fn + F1 key combination turns off the display and activates instant security.

If you set a blank screen saver, pressing the Fn + F1 key combination to activate instant security will cause the screen to go blank. Using the pointing device or any key will make the display's content reappear. The Windows® operating system log-on screen will appear, prompting you for a password. After typing in the password for the current user, press Enter.

To activate the password feature:

- 1 Click **Start**, **Control Panel**, then click **Appearances and Themes**.
- 2 Click one of the following:
 - ❖ **Choose a screen saver** in the "Pick a task" section
 - ❖ **Display** in the "or pick a Control Panel icon" section

The Display Properties window appears.

- 3 If you clicked **Choose a screen saver**, the Screen Saver tab has already been selected. If it is not selected, click the **Screen Saver** tab.
- 4 Click the **On resume, password protected** check box.
- 5 Click **OK**.

Maintaining security when the battery is not fully charged

When the battery is not fully charged (even if the computer is operating on AC power) your display may reappear automatically after a short time. To protect your desktop, you must set up a screen saver with a password before activating the password feature.

To set up a password with a screen saver, go to Windows XP help for instructions:

- 1 Click **Start, Help and Support**.
- 2 In the **Search** field, type password screen saver.
- 3 Press Enter.
- 4 Click the **Protect your files with a screen saver password link** located under the suggested topics.

Follow the steps listed in the Windows help to set up your password-protected screen saver.

To ensure the password protection is activated after pressing Fn + F1 (to activate instant security), wait ten seconds before walking away from the computer.

Power usage

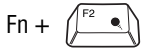

This hot key displays the Power Schemes tab of the Power Options Properties window.

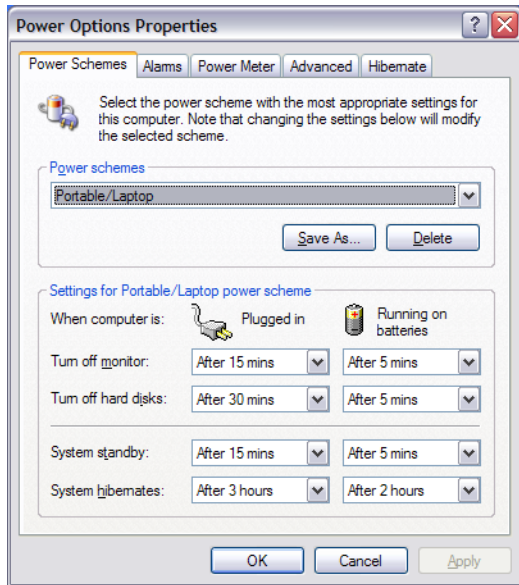

Sample Power Schemes tab in Power Options

You can configure your computer's power usage using the drop down lists. You can choose one of the provided power schemes or select your own custom settings. For more information, see your Windows documentation.

Standby mode



This hot key places the computer into Standby mode.

- ❖ A message box displays by default to confirm that the computer is entering Standby mode. You can choose not to display this message box.

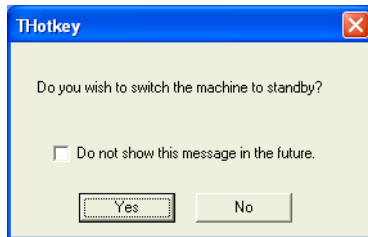

Sample Standby confirmation box

- ❖ For more information about Standby mode, please see [“Standby mode” on page 76](#).

Hibernation mode

Fn +



This hot key places the computer into Hibernation mode.

- ❖ If Hibernation mode is enabled (the default) a message box displays by default to confirm the computer is entering Hibernation mode. You can choose not to display this message box.

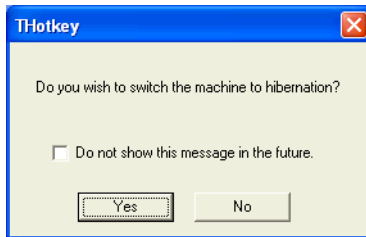

Sample Hibernation confirmation box

- ❖ If Hibernation mode is disabled, this hot key will not respond. For more information on Hibernation mode, see [“Hibernation mode”](#) on page 75.

Display modes

Fn +



This hot key cycles through the power-on display options.

The display modes are:

- ❖ Built-in display only
- ❖ Built-in display and external monitor simultaneously
- ❖ External monitor only
- ❖ TV
- ❖ TV and built-in display
- ❖ DVI appears if you have a projector or a monitor connected to the DVI video port (DVI is available on some models)

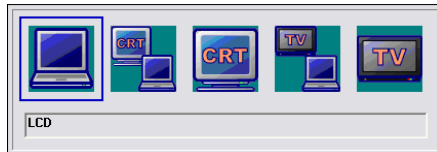

Sample display options window

In order to use a simultaneous mode, you must set the resolution of the internal display panel to match the resolution of the external display device.

Display brightness



This hot key decreases the screen brightness.

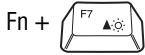

This hot key increases the screen brightness.

Disabling or enabling the TouchPad or Dual Mode Pad

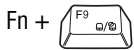

This hot key enables/disables either the TouchPad or Dual Mode Pad.

For more information on using the TouchPad, see [“Disabling or enabling the TouchPad” on page 62.](#) For more information on using the Dual Mode Pad, see [“Disabling or enabling the Dual Mode Pad” on page 67.](#)



Sample disable and enable TouchPad or Dual Mode Pad windows

Zooming applications in/out

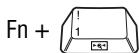

This hot key turns the Zooming utility to zoom-out. For more information, see [“TOSHIBA Zooming Utility” on page 164.](#)

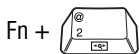

This hot key turns the Zooming utility to zoom-in. For more information, see [“TOSHIBA Zooming Utility” on page 164.](#)

Keyboard hot keys

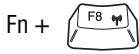

This hot key informs you when the Wireless antenna on-off switch is in the off position. (No message appears when the Wi-Fi antenna on-off switch is in the on position.)



[Spacebar]

This hot key switches screen or video modes.

Appendix B

Power Cord/Cable Connectors

The computer features a universal power supply you can use worldwide. This appendix shows the shapes of the typical AC power cord/cable connectors for various parts of the world.

USA and Canada



UL approved
CSA approved

Australia



AS approved

United Kingdom

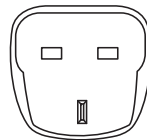

BS approved

Europe



VDA approved
NEMKO approved

Appendix C

Using ConfigFree™ with your Toshiba Computer

ConfigFree™ is a set of utilities that makes it easy to control communication devices and network connections. ConfigFree also lets you identify communication problems and create profiles for easy switching between locations and communication networks.

NOTE For more information on using ConfigFree, see the ConfigFree online Help.

The ConfigFree utilities include the following:

- ❖ **Connectivity Doctor**—The Connectivity Doctor utility is used to analyze network connections and fix networking problems with your notebook computer. For more information, see [“Connectivity Doctor” on page 238](#).
- ❖ **Search for Wireless Devices**—The Search for Wireless Devices utility searches for wireless LAN and *Bluetooth*® devices used in the neighborhood, and displays information about them on a virtual map. For more information, see [“Search for Wireless Devices” on page 241](#).

- ❖ Profile Settings—The Profiles utility lets you switch between network configurations. For more information, see “Profile Settings” on page 246.
- ❖ ConfigFree SUMMIT—The ConfigFree SUMMIT utility is used to connect with other ConfigFree users for file sharing. For more information, see “ConfigFree SUMMIT” on page 250.

ConfigFree also includes a screen saver that you can customize by adding identifying text to devices. Click **Options** on the Connectivity Doctor screen to access the screen saver option.



Getting Started

This section contains information about the ConfigFree main screen, and how to start and set up ConfigFree.

For more detailed information on setting up and using ConfigFree, see the Help File included in the application.

Starting ConfigFree

To start ConfigFree, be sure the computer has a wired or wireless connection. Then perform any of the following steps:

- ❖ (Microsoft® Windows® XP or 2000) Click the **Start** button, and select **All Programs, TOSHIBA, Networking, ConfigFree**.
- ❖ Double-click the **ConfigFree** icon  on the taskbar.
- ❖ Press the **TOSHIBA Assist** button (if applicable to your system) to open the TOSHIBA Assist, and then click the **ConfigFree** icon.
- ❖ Click the **ConfigFree** icon  on the taskbar, and then click the desired utility.

NOTE

If your computer is not connected to a network, the ConfigFree icon on the taskbar is displayed with an "X."

When you start a search for wireless devices, ConfigFree Launcher displays on your computer desktop. You can then click the appropriate icon on the Launcher to start the desired ConfigFree utilities.

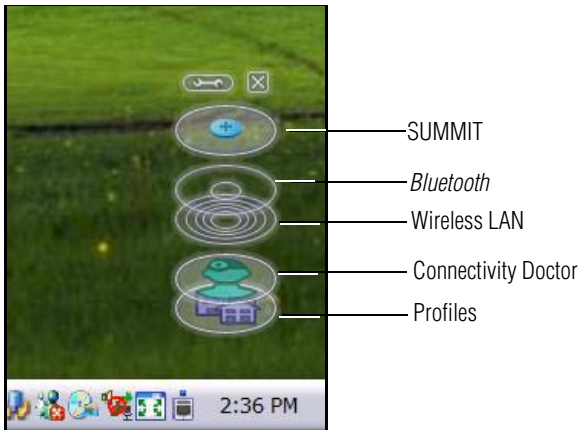

Sample ConfigFree Launcher

ConfigFree Launcher can be set to hide from view when it is not in use. When this setting is active (set the ConfigFree Launcher to Auto-hide mode), you can re-display ConfigFree Launcher by moving the mouse cursor to the right of the screen.



Sample ConfigFree Launcher Auto-hide mode setting

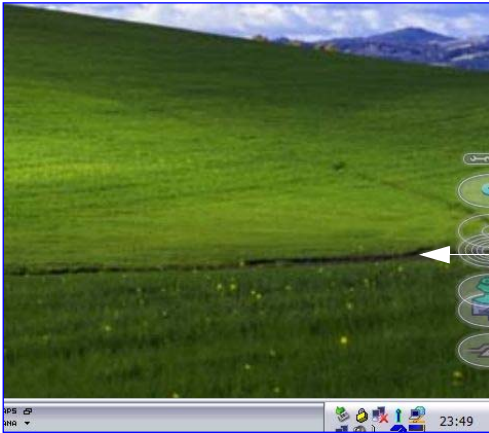

Sample ConfigFree Launcher coming back into view

ConfigFree Utilities

Connectivity Doctor

The Connectivity Doctor lets you analyze your network connections and fix network-connection problems. Using Connectivity Doctor, you can view detailed network information by simply moving the mouse pointer.

The Connectivity Doctor works with the following network devices:

- ❖ Wired and wireless network devices
- ❖ Routers, hubs, and bridges
- ❖ Access points

The Connectivity Doctor displays the following information:

- ❖ WEP (Used, not Used)
- ❖ Wired connection line (link speed)
- ❖ Wireless connection line (signal strength and link speed)

- ❖ Location of wireless communication switch (identified with a yellow arrow)
- ❖ Status of wireless communication switch (on or off)



- 1 **Wired Network Devices**
- 2 **Wireless Network Devices**
- 3 **Router/Hub/Bridge**
- 4 **Access Point**
- 5 **Display if WEP key is set**
This is not displayed if WEP is not set.
- 6 **Wired Connection Line**
Displays the link speed.
- 7 **Wireless Connection Line**
Displays the signal strength and link speed.
- 8 **Location of wireless communication switch**
Displayed with a yellow arrow.
- 9 **Status of wireless communication switch**
Displays whether the wireless communication switch is on or off.

Sample Connectivity Doctor screen

Moving the mouse pointer over a wired or wireless network device icon displays information about the device, such as its IP address, subnet mask, and MAC address. A wireless network device also shows information such as the network SSID and the device's Wired Equivalent Privacy (WEP) key settings.



Sample viewing device information

If a problem or potential problem is detected, in most cases, a screen automatically displays showing you the possible cause and solution for the problem.

A triangle containing an exclamation point also appears on the Connectivity Doctor screen and an orange frame describes the relevant location. You can also view the possible cause and solution for the problem by clicking the exclamation point. If multiple triangles display, you can toggle between each of their cause and solution information screens by clicking its exclamation point.

For example, if the connection to a wireless network cannot be established because the wireless communication switch is turned off, the problem description screen will normally display automatically when you start the Connectivity Doctor, and an exclamation point will appear next to the wireless communication switch.

The following checkboxes and buttons are provided on the Connectivity Doctor screen:

Stay on the task tray	When checked, the ConfigFree icon resides in the system tray.
Options	Displays ConfigFree setting screen.
Log	Lets you create a diagnostic log, view a history of log files, or delete the history. Log files are saved as CFhtmlxxxx.htm, where xxxx is the creation date and time. They reside in the folder: C:\Documents and Settings\username\Local Settings\Temp
About	Displays the version of Connectivity Doctor.
Help	Displays online help.
Close	Closes the Connectivity Doctor screen.

Search for Wireless Devices

The Search for Wireless Devices utility searches for wireless LAN and *Bluetooth* devices currently used in the neighborhood, and displays information about them on a virtual map.

To search for wireless devices:

- 1 Click the  icon in the system tray.
- 2 Click **Search for Wireless Devices**.

A virtual map appears with a graphical representation of the wireless devices that have been detected.

NOTE

Search for Wireless Devices can also be started from the ConfigFree Launcher.

For Wi-Fi networks, the intensity of a signal is displayed in five levels or “bands.” The signal from the connected access point is displayed in the bands surrounding the PC icon at the center of the map. The closer to the center, the stronger the connection. Placing the pointer over the displayed “point of light” shows detailed information about the wireless device.

NOTE

The wireless device shown near the center of the map is not necessarily near your notebook computer. If a wireless device located a distance away also has a strong signal, it appears near the center of the map as well.

The Search for Wireless Devices feature identifies if a device is IEEE 802.11a, b, or g. It also includes an option to display hidden access point availability.

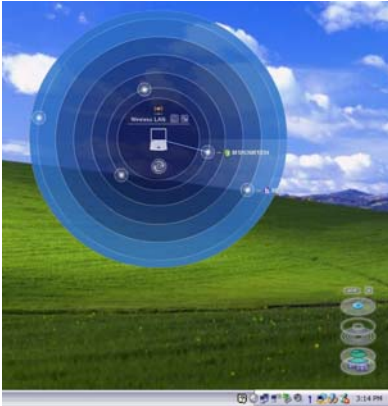

Sample viewing Wi-Fi devices

Creating a new wireless connection

NOTE This feature is only supported on systems running Windows XP SP2.

To add a new wireless connection to an Access Point:

- 1** Open the Search for Wireless Devices option from ConfigFree Launcher.
- 2** Drag and drop the device you want to connect to the PC icon at the center of the map. The Wireless Settings screen appears.



Sample dragging a device to the Access Point

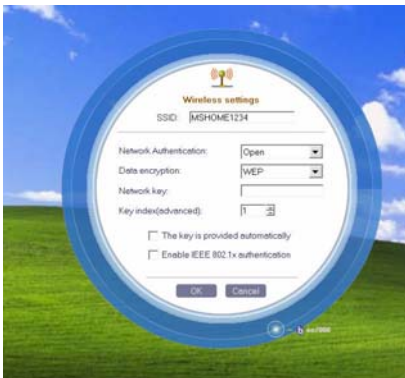

Sample Wireless settings screen

- 3 Enter the SSID/WEP information and connect to the device.

NOTE

After the Access Point is set up and added to the connection list, the system displays the Connection screen rather than the Wireless settings screen.

Creating a detected device wireless connection

The following screen shows an example of *Bluetooth* devices that are detected using the **Search for Wireless Devices** option. Moving the mouse cursor over a device icon displays information about the device.



Sample viewing Bluetooth devices

You can connect to devices shown on the *Bluetooth* map:

- 1 Drag and drop the device you want to connect to the PC icon at the center of the map.
- 2 Configured devices are automatically connected. Devices not yet configured launch the Add New Connection Wizard, where you can configure and connect to the device.

Transferring files using *Bluetooth*

There are several ways to use *Bluetooth* to send files to other devices.

To select the device using the *Bluetooth* radar screen:

- ❖ Open the *Bluetooth* radar screen, and drag and drop the file directly onto the icon for that *Bluetooth* device.



Sample dragging the file to the Bluetooth device icon

To be prompted for the device:

- 1 Drag and drop the file to the *Bluetooth* radar icon on the ConfigFree Launcher.



Sample dragging the file to the Bluetooth radar icon

Or, you can right click on the file and select **Send to Bluetooth Devices**.



Sample selecting Send to Bluetooth Devices option

- 2 Choose a file recipient.
- 3 Click **Send**.

NOTE

During a file transfer, connecting and disconnecting to the selected device will occur automatically.

Disconnecting from a *Bluetooth* device

To disconnect from a *Bluetooth* device:

- 1 Place the cursor on top of the connected line. The icon changes to a pair of scissors.
- 2 Click to disconnect from the device.

Profile Settings

The Profile Settings utility lets you save network settings in “profiles.” ConfigFree profiles are useful for easily switching network settings and devices. You can switch network settings simply by selecting the profile with the desired settings.

If you visit a client company occasionally, for example, you can set up a profile to match that environment and connect to the network. Similarly, users who access networks in the office and at home can set up profiles to handle these networking environments.

A profile contains the currently configured network settings on the computer, as well as information about any network devices. The following settings can be saved (or “captured”) in a profile:

- ❖ **Internet settings** — includes LAN settings (proxy server settings) and the address of a home page that opens automatically when Internet Explorer starts.
- ❖ **Devices** — lets you enable or disable settings of wired and wireless network devices, infrared devices, and set the power status of *Bluetooth* antennas.
- ❖ **TCP/IP settings** — includes DHCP, IP address, subnet mask, default gateway, DNS server, and WINS server settings.
- ❖ Personal firewall settings for Internet connections.
- ❖ Dial-up connection settings for the default connection.
- ❖ File and printer sharing settings.
- ❖ Printer settings for the default printer.
- ❖ *Bluetooth* Security Level (for example, high or medium).

To create a profile:

- 1 Click the  icon in the system tray.
- 2 Move the pointer to **Profile**.
- 3 Click **Add**. The Add Profile screen appears.
- 4 Select **Capture** and click **OK**. The Add Profile screen appears.
- 5 Enter the name of the profile you want to create.

- 6 Enter any optional comments, if desired.
- 7 Click **Change Icon** and select an icon for this profile.
- 8 Click the  icon at the bottom of the screen to display more capture options.
- 9 Under **Captured Items**, select the items you want to capture for this profile.
- 10 If connecting with a wireless network, select the desired **Auto Switch Settings**. (These options are unavailable if wireless devices have been disabled.)
- 11 Under **Execute this program after switching**, click the **Browse** button and select the program, file, or Web site URL that is to start after switching to this profile.

For example, to have Internet Explorer start in Windows XP after switching profiles, type:

C:\Program Files\Internet Explorer\IEXPLORE.EXE

- 12 Click **OK**.

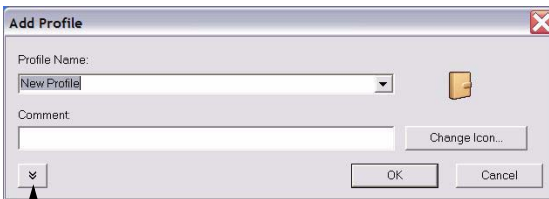

Press to show more capture options

Sample Add Profile screen

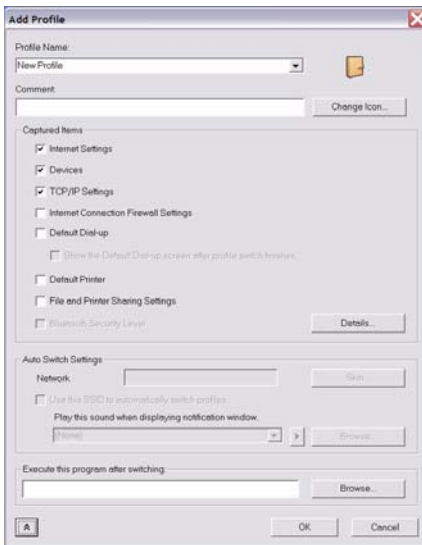

Sample expanded Add Profile screen

NOTE The online help provides real-world examples of setting up profiles for different networking environments.

After you set up one or more profiles, you can check their settings and fine-tune them as necessary. Profiles can also be imported and exported. This feature is useful when transferring profile settings to other computers. For more information about modifying, importing, and exporting profiles, refer to the online help.

ConfigFree SUMMIT

The ConfigFree SUMMIT utility is a convenient way to share files with other users and to transfer files between your computers at home and at work. This utility is faster and more dependable than sending the files via email.

Use this utility, which handles files regardless of size, to distribute presentations, reports, or music files to meeting attendees or to users at different locations.

The SUMMIT utility uses the following types of connections:

- ❖ Wireless LAN via Access Point
- ❖ Wireless LAN via Ad-Hoc
- ❖ LAN (same subnet)
- ❖ *Bluetooth* PAN/LAP
- ❖ Cross cable (Ethernet or Gbit Ethernet)

To host a ConfigFree SUMMIT, click the SUMMIT icon on the ConfigFree Launcher, select the users that you want to attend the SUMMIT meeting, and send them an invitation.

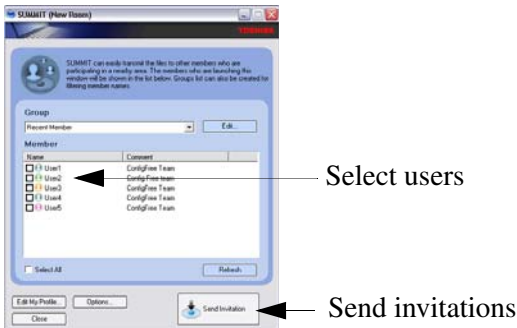

Sample of inviting users to SUMMIT meeting

When a user joins the SUMMIT, their icon appears on the SUMMIT table.



Sample of users attending SUMMIT meeting (user icons appear on SUMMIT table)

Files can be shared with one user or all users attending the meeting.

- ❖ To share a file with one user, drag and drop the file on the user's icon.

NOTE

Only the SUMMIT Host (the initiator) can share files with multiple users by this method. SUMMIT users can share a file with only one other user.



Sample of sharing a file with one user

- ❖ To share a file with all users, drag the file to the center of the SUMMIT table where users can access it as desired.

NOTE

If you are the Host of the summit, and drag a file to the center of the SUMMIT table, it will automatically be sent to all SUMMIT users who can then accept or decline the file as desired.



Sample of sharing a file with all users

NOTE

Participating users must be connected by LAN, wireless LAN, or *Bluetooth* (PAN). Firewall software may prevent ConfigFree SUMMIT from working.

Using ConfigFree SUMMIT

To host a ConfigFree SUMMIT:

- 1 Click the  icon in the system tray.
- 2 Click **SUMMIT**. Other users appear on the SUMMIT main window.

NOTE

SUMMIT can also be started from the ConfigFree Launcher.

- 3 Select the appropriate users and invite them to the SUMMIT meeting. As users join the SUMMIT, their icons appear on the SUMMIT table.
- 4 Use drag and drop to share documents with SUMMIT users:
 - ❖ To share a file with one user, drag the file to the user's icon.
 - ❖ To share a file with all users, drag the file to the center of the summit table.

There are other ways to send files to users.

To send files to all SUMMIT users:

- 1 Right click on the file and select **Send to SUMMIT Devices**.
- 2 Click **Send**.

To send files to a user without creating a SUMMIT meeting:

- 1 Drag and drop the file to the Wireless radar icon on the ConfigFree Launcher.
- 2 Right click on the file and choose a file recipient.
- 3 Click **Send**.

An Access Point may not always be available. To find out how to use Quick Connect to launch ConfigFree Summit, see [“Direct Link Toshiba Device” on page 256](#).

Quick Connect

The Quick Connect feature includes two options:

- ❖ **Toshiba Wireless Projector.** Switches the Wireless LAN connection to connect to a Toshiba Wireless Projector
- ❖ **Direct Link Toshiba Device.** Launches ConfigFree SUMMIT

Toshiba Wireless Projector

The Quick Connect feature switches the Wireless LAN connection to connect to a Toshiba Wireless Projector. Once the projector utility is installed, launching the Quick Connect utility automatically opens the Wireless Data Projector Application. There you can configure how you would like to use the projector.

To connect to a Toshiba Wireless Projector:

- 1 Click the  icon in the system tray.
- 2 Move the mouse pointer to **Toshiba Wireless Projector (DPJ)**, then click **Connect**.

Launching Quick Connect prevents you from using the network to connect to a Toshiba Wireless Projector when the wireless LAN Configuration is set to Ad hoc. If you are connected to an access point, the connection is broken and re-established later.

To review the current Toshiba Wireless Projector settings and change them if necessary:

- 1 Click the  icon in the system tray.
- 2 Move the mouse pointer to **Toshiba Wireless Projector (DPJ)**, then click **Settings**. The Quick Connect properties dialog box appears.
- 3 Complete the settings. Refer to the online help if necessary.
- 4 Click **OK**.

NOTE

The default connection setting is for Ad hoc mode, therefore, if the setting on the Toshiba Wireless Projector is in Infrastructure mode, it will not connect. However, you can change the settings to Infrastructure mode to match the settings on the projector.



Sample Projector icon when connected with Quick Connect

If the wireless mode for the wireless setting is set for 5 GHz (802.11a), Quick Connect changes this mode to 2.4 GHz (802.11b) and then connects to the projector.

The wireless LAN configuration returns to the settings that were last used before the Quick Connect function was started:

- ❖ If the Toshiba Wireless Projector utility is closed.
- ❖ If you select Toshiba Wireless Projector (DPJ) from the ConfigFree tray menu (this disconnects the wireless LAN connection).
- ❖ If you select a profile from the ConfigFree tray menu or when you disable a wireless device.
- ❖ If you close ConfigFree.

Direct Link Toshiba Device

When Access Point is not available, use the Direct Link Toshiba Device feature to connect your computer in ad-hoc (peer-to-peer) mode and use the Summit feature.

To use this feature:

- 1 Display the ConfigFree menu.
- 2 Select the ConfigFree Link option from the Direct Link Toshiba Device submenu. This action switches the computer's wireless network setting to ad-hoc mode, and launches the SUMMIT feature.

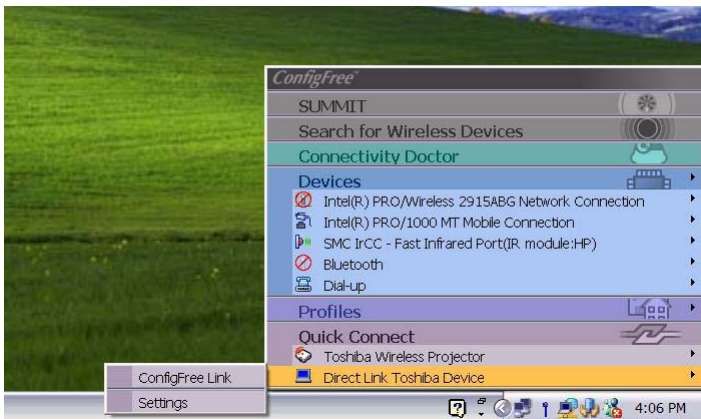

Sample using the Direct Link Toshiba Device feature

Using the Automatic Switch

The Automatic Switch feature allows the computer to automatically switch profiles the next time it is powered on. This feature is particularly useful if you want your computer to automatically switch from the network configuration you use in your office to the one you use at home.

The Auto Switch feature contains options for automatically switching between wired and wireless devices. With these options, the computer automatically switches to a wireless LAN network when the cable of the wired LAN network is removed from the computer. When the cable is reconnected, the connection to the wired LAN is re-established.

To use the Automatic Switch feature:

- 1 Right-click the  icon in the system tray.
- 2 Click **Auto Switch**. The Auto Switch dialog box appears.
- 3 Check **Enable Wireless when cable disconnect occurs**.
- 4 Click **OK**.

NOTE

If your computer is connected to multiple wireless LAN devices, the Auto Switch (SSID) feature is disabled. To enable this feature, only one wireless LAN device can be used.

Semi-Automatic Switch Feature

The Semi-Automatic feature alerts you when the computer connects to a Service Set Identifier (SSID) stored in a profile. When the computer connects to the designated SSID, a notification window appears. You can then click this window to connect using the settings specified in the profile.

To use the Semi-Automatic Switch feature:

- 1 Right-click the  icon in the system tray.
- 2 Click **Auto Switch**. The Auto Switch dialog box appears.
- 3 Select the **Auto Switch (SSID)** tab.
- 4 Select the profile to be automatically selected when the SSID is detected, then click **Add**. The profile is moved to the **List of target SSIDs and profiles**.
- 5 Repeat the previous step for each additional profile you want to select.
- 6 Select **Automatically switch profiles when connected to this SSID**.
- 7 Check **Automatically switch profile when connected to this SSID**.
- 8 Click **OK**.

The computer is now configured to use the Semi-Automatic Switch feature. When the computer connects to an SSID in a profile, a display notification window appears. You can then click **Switch** on the window to switch profiles. You can also set the option for having the switch be automatic without the need for a notification.

NOTE

Several profiles can be defined for a single SSID. In this case, several notification windows are displayed. By clicking these windows, you can switch to the profile for that location.

Glossary



TECHNICAL NOTE: Some features defined in this glossary may not be available on your computer.

Acronyms

These acronyms may appear in this user's guide.

AC	alternating current
BIOS	basic input/output system
bps	bits per second
CD	compact disc
CD-ROM	compact disc read-only memory
CD-RW	compact disc rewrite memory
CMOS	complementary metal-oxide semiconductor
COM1	communications port 1 (serial port)
COM2	communications port 2 (serial port)
CPU	central processing unit

DC	direct current
DMA	direct memory access
DIMM	dual inline memory module
DOS	disk operating system
DPI	dots per inch
DSTN	dual supertwist nematic
DVD	digital versatile (or video) disc
DVD-ROM	digital versatile (or video) disc read-only memory
ECP	enhanced capabilities port
EPROM	erasable programmable read-only memory
FAT	file allocation table
FCC	Federal Communications Commission
HDD	hard disk drive
HTML	Hypertext Markup Language
IEEE	Institute of Electrical and Electronics Engineers
I/O	input/output
IRQ	interrupt request
ISP	Internet service provider
LAN	local area network
LCD	liquid crystal display
LPT1	line printer port 1 (parallel port)
LSI	large-scale integration
MIDI	Musical Instrument Digital Interface
PC	personal computer
PCI	Peripheral Component Interconnect
PCMCIA	Personal Computer Memory Card International Association
RAM	random access memory
RFI	radio frequency interference
ROM	read-only memory

RTC	real-time clock
SCSI	small computer system interface
DDRAM	double data random access memory
SRAM	static random access memory
SVGA	super video graphics adapter
TFT	thin film transistor
USB	universal serial bus
URL	uniform resource locator
WAN	wide area network
www	World Wide Web

Terms

These terms may appear in this user's guide.

A

active-matrix display — A liquid crystal display (LCD) made from an array of liquid crystal cells using active-matrix technology. Also known as a “TFT display,” in its simplest form there is one thin film transistor (TFT) for each cell. This type of display works well with notebook computers because of its shallow depth and high-quality color. Active-matrix displays are viewable from wider angles than most passive-matrix displays.

adapter — A device that provides a compatible connection between two units. For example, the computer's internal display adapter receives information from the software and translates it into images on the screen. An adapter can take a number of forms, from a microprocessor to a simple connector. An intelligent adapter (one that is capable of doing some processing) may also be called a controller.

alternating current (AC) — The type of power usually supplied to residential and commercial wall outlets. AC reverses its direction at regular intervals. Compare *direct current (DC)*.

application — A computer program that you use to perform tasks of a specific type. Applications include word processors, spreadsheets, and database management systems. See also *program*.

- B**
- backup** — A copy of a file, usually on a removable disk, kept in case the original file is lost or damaged.
- basic input/output system (BIOS)** — See *BIOS*.
- baud rate** — The speed at which a communication device, such as a printer or modem, transmits information. Baud rate is the number of signal changes per second (not necessarily the same as bits per second). See also *bits per second*.
- BIOS (basic input/output system)** — Basic instructions, stored in read-only memory (ROM), containing the information the computer needs in order to check hardware and load the operating system when you start up the computer.
- bits per second (bps)** — A way of measuring the speed at which information is passed between two devices. The basic measure used in modem communications, bps is similar, but not identical, to the baud rate. See also *baud rate*.
- boot** — To start the computer. The term “boot” originates from bootstrap program (as in “pulling itself up by its bootstraps”), a program that loads and initializes the operating system. See also *reboot*.
- boot disk** — See *system disk*.
- boot priority (startup sequence)** — The order in which the computer accesses its disk drives to locate the startup files. Under the default startup sequence, the computer looks for the startup files in the diskette drive before checking the hard disk.
- bus** — An electrical circuit that connects the central processing unit (CPU) with other parts of the computer, such as the video adapter, disk drives, and ports. It is the pathway through which data flows from one device to another. See also *bus speed*, *frontside bus*.
- bus speed** — The speed at which the central processing unit (CPU) communicates with the other parts of the computer.
- C**
- cache** — A section of very fast memory in which frequently used information is duplicated for quick access. Accessing data from cache is faster than accessing it from the computer’s main memory. See also *CPU cache*, *L1 cache*, *L2 cache*.
- CD** — An individual compact disc. See also *CD-ROM*.

-
- CD-ROM (compact disc read-only memory)** — A form of high-capacity storage that uses laser optics instead of magnetic means for reading data. See also *CD*. Compare *DVD-ROM*.
- central processing unit (CPU)** — The chip that functions as the “brain” of the computer. It takes information from outside sources, such as memory or keyboard input, processes the information, and sends the results to another device that uses the information.
- character** — Any letter, number, or symbol you can use on the computer. Some characters are non-printing characters, such as a paragraph break in a word-processing program. A character occupies one byte of computer storage.
- chip** — A small piece of silicon containing computer logic and circuits for processing, memory, input/output, and/or control functions. Chips are mounted on printed circuit boards.
- click** — To press and release the Dual Mode Pad control button or mouse button without moving the cursor or mouse. In the Windows[®] operating system, this refers to the left mouse button or primary Dual Mode Pad control button, unless otherwise stated. See also *double-click*.
- color palette** — A set of specified colors that establishes the colors that can be displayed on the screen at a particular time.
- compatibility** — The extent to which computers, programs, or devices can work together harmoniously, using the same commands, formats, or language as another.
- configuration** — (1) The collection of components that make up a single computer system. (2) How parts of the system are set up (that is, configured).
- controller** — A device that controls the transfer of data from a computer to a peripheral device and vice versa. For example, disk drives, monitors, keyboards, and printers all require controllers.
- CPU** — See *central processing unit (CPU)*.

CPU cache — A section of very fast memory residing between the CPU and the computer's main memory that temporarily stores data and instructions the CPU will need to execute commands and programs. See also *cache*, *L1 cache*, *L2 cache*.

cursor — A symbol that indicates the current position on the screen. The shape of the cursor varies, depending on the program you are using and what you are doing.

D

default — The setting selected by a program when the user does not specify an alternative setting.

device — A component attached to the computer. Devices may be external (outside the computer's case) or internal (inside the computer's case). Printers, disk drives, and modems are examples of devices.

device driver — A program (called a "driver") that permits a computer to communicate with a device.

dialog box — An on-screen window displayed by the operating system or a program giving a direction or requesting input from the user.

direct current (DC) — The type of power usually supplied by batteries. DC flows in one direction. Compare *alternating current (AC)*.

direct memory access (DMA) — A dedicated channel, bypassing the CPU, that enables direct data transfer between memory and a device.

directory — See *folder*.

disable — To turn a computer option off. See also *enable*.

disc — A round, flat piece of metal, designed to be read from and written to by optical (laser) technology, and used in the production of optical discs, such as CDs and DVDs. Compare *disk*.

disk — A round, flat piece of material that can be magnetically influenced to hold information in digital form, and used in the production of magnetic disks, such as diskettes and hard disks. Compare *disc*. See also *diskette*, *hard disk*.

disk drive — The device that reads and writes information and programs on a diskette or hard disk. It rotates the disk at high speed past one or more read/write heads.

diskette — A thin, flexible disk in a protective jacket that stores magnetically encoded data. Diskettes can be removed from the computer and come in two sizes: 5.25-inch and 3.5-inch. Your computer uses 3.5-inch diskettes. See also *double-density diskette*, *high-density diskette*.

document — Any file created with an application and, if saved to disk, given a name by which it can be retrieved. See also *file*.

double-click — To press the Dual Mode Pad control button or mouse button rapidly twice without moving the cursor or mouse. In the Windows® operating system, this refers to the primary Dual Mode Pad control button or left mouse button, unless otherwise stated.

double-density diskette — A 3.5-inch diskette that can hold up to 720 KB of information (half the capacity of a high-density diskette). See also *diskette*, *high-density diskette*.

download — (1) In communications, to receive a file from another computer through a modem or network. (2) To send font data from the computer to a printer. See also *upload*.

drag — To hold down the Dual Mode Pad control button or mouse button while moving the cursor to drag a selected object. In the Windows® operating system, this refers to the primary Dual Mode Pad control button or left mouse button, unless otherwise stated.

driver — See *device driver*.

DVD — An individual digital versatile (or video) disc. See also *DVD-ROM*.

DVD-ROM (digital versatile [or video] disc read-only memory) — A very high-capacity storage medium that uses laser optics for reading data. Each DVD-ROM can hold as much data as several CD-ROMs. Compare *CD-ROM*.

E

emulation — A technique in which a device or program imitates another device or program.

enable — To turn on a computer option. See also *disable*.

executable file — A computer program that is ready to run. Application programs and batch files are examples of executable files. Names of executable files usually end with a .bat or .exe extension.

expansion device — A device that connects to a computer to expand its capabilities. Other names for an expansion device are port expander, port replicator, docking station, or network adapter.

extension — See *file extension*.

external device — See *device*.

F

file — A collection of related information, saved on disk with a unique name. A file may be a program, information used by a program, or a document. See also *document*.

file allocation table (FAT) — The section of a disk that keeps track of the location of files stored on the disk.

file name — A set of characters that uniquely identifies a file within a particular folder. It consists of two parts: the actual name and the file name extension. See also *file extension*.

file extension — The three characters following the period (pronounced “dot”) at the end of a file name. The extension indicates the type of file. Examples are .exe for program files and .hlp for help files. See also *file name*.

folder — Also called directory. A container for organizing files saved to a disk. A folder is symbolized on screen by a graphical image (icon) of a file folder. A folder can contain files and other folders.

format — (verb) To prepare a blank disk for use with the computer’s operating system. Formatting creates a structure on the disk so the operating system can write information to the disk or read information from it.

frontside bus — The primary pathway (bus) between the CPU and the computer’s main memory. Also called “system bus.” See also *bus*.

function keys — The keys labeled F1 through F12, typically located on the keyboard. Their function is determined by the operating system and/or individual programs.

G **ground** — A conductor to which all components of an electric circuit are connected. It has a potential of zero (0) volts, is connected to the earth, and is the point of reference for voltages in the circuit.

H **hard disk** — A storage device composed of a rigid platter or platters that can be magnetically coded with data. Hard disks hold much more information than diskettes and are used for long-term storage of programs and data. The primary (or only) hard disk in a computer is usually fixed, but some computers have secondary hard disks that are removable. By default, the hard disk is referred to as drive C.

hardware — The physical components of a computer system. Compare *software*.

Hibernation — A feature of many Toshiba notebook computers that saves to the hard disk the current state of your work, including all open files and programs, when you turn the computer off. When you turn on the computer again, your work is returned to the same state it was when the computer was turned off. See also *Standby*, *Suspend*.

high-density diskette — A 3.5-inch diskette that holds 1.44 MB of data. See also *diskette*.

hot key — (1) A feature in which certain keys in combination with the Fn key can set system options or control system parameters, such as the battery save mode. (2) A key or combination of keys that activates a memory resident program.

hot swapping — The ability to add or remove devices from a computer while the computer is running and have the operating system automatically recognize the change.

I **icon** — A small image displayed on the screen that represents a function, file, or program.

interlaced — A method of refreshing a computer screen, in which only every other line of pixels is refreshed. Interlaced monitors take two passes to create a complete screen image. Compare *non-interlaced*.

internal device — See *device*.

Internet — The decentralized, world-wide network of computers that provides electronic mail, the World Wide Web, and other services. See also *World Wide Web*.

K

keyboard shortcut — A key or combination of keys that you use to perform a task instead of using a pointing device such as the Dual Mode Pad.

L

L1 (level one) cache — Memory cache built into the processor to help improve processing speed. See also *cache*, *CPU cache*, *L2 cache*.

L2 (level two) cache — Memory cache installed on the motherboard to help improve processing speed. It is slower than L1 cache and faster than main memory. See also *cache*, *CPU cache*, *L1 cache*.

LAN (local area network) — A group of computers or other devices dispersed over a relatively limited area and connected by a communications link that enables any device to interact with any other on the network.

liquid crystal display (LCD) — A type of display that uses a liquid substance between two transparent electrode panels. When an electric current passes through the electrodes, the molecules in the liquid form a crystalline pattern that polarizes the light passing through it. A filter over the electrodes permits only non-polarized light to pass to the surface of the display, creating light and dark pixels.

load — To move information from a storage device (such as a hard disk) into memory for processing.

local area network — See *LAN*.

logical drive — A section of a disk that is recognized by the operating system as a separate disk drive. A system's logical drives may differ from its physical drives. For example, a single hard disk drive may be partitioned into two or more logical drives.

M

memory — Typically refers to the computer's main memory, where programs are run and data is temporarily stored and processed. Memory can be volatile and hold data temporarily, such as RAM, or it can be nonvolatile and hold data permanently, such as ROM. A computer's main memory is RAM. See *RAM*, *ROM*.

microprocessor — See *central processing unit (CPU)*.

MIDI (Musical Instrument Digital Interface) — A standard for connecting musical instruments, synthesizers, and computers. The MIDI standard provides a way of translating music into a form computers can use, and vice versa.

modem — Short for “modulator/demodulator.” A device that converts information from digital to analog and back to digital, enabling information to pass back and forth between digital computers and analog telephone lines.

motherboard — The main circuit board in the computer. It contains the processor, memory, and other primary components.

MS-DOS® prompt — See *system prompt*.

multi-function drive—A DVD drive that can read and write to CD and DVD media.

multimedia — A combination of two or more media, such as sound, animation, and video in a computer program or presentation.

Musical Instrument Digital Interface — See MIDI.

N

network — A collection of computers and associated devices that are connected by communications facilities. A network allows you to share data and peripheral devices, such as printers, with other users and to exchange electronic mail.

non-interlaced — A method of refreshing a computer screen, in which each pixel of every line is refreshed as the electron beam scans across and down the screen. Compare *interlaced*.

non-system disk — A disk for storing programs and data that cannot be used to start the computer. Compare *system disk*.

O

online — Available through the computer. Online may refer to information being read from your own computer’s hard disk, such as online documentation or online help, or to information coming from another company on a company network or the Internet.

operating system — A set of programs that controls how the computer works. Examples of operating systems are Windows® XP and Windows® 2000.

P

palette — See *color palette*.

parallel — Processes that occur simultaneously. In communications, it means the transmission of more than one bit of information at a time. On your computer, the parallel port provides a parallel communications interface between the computer and an appropriate device. Most modern printers are parallel. Compare *serial*.

password — A unique string of characters entered by a user to verify his or her identity to the computer or the network.

PC Card — A credit-card-sized expansion card designed to increase the capabilities of notebook computers. PC Cards provide functions such as modem, fax/modem, hard disk drive, network adapter, sound card, or SCSI adapter.

peripheral — Any device, such as a printer or joystick, that is attached to the computer and controlled by the computer's CPU.

pixel — Short for "picture element." The smallest dot that can be produced on a screen or printer.

Plug and Play — Generally, refers to the computer's ability to automatically configure itself to work with peripheral devices. When capitalized, refers to a standard that, when followed by a device manufacturer, allows a PC to configure itself automatically to work with the device.

pointing device — Any device, such as the Dual Mode Pad or a mouse, that enables you to move the cursor on the screen.

port — A socket on the computer where you plug in a cable for connection to a network or a peripheral device.

processor — See *central processing unit (CPU)*.

program — A set of instructions that can be executed by a computer. The general classes of programs (also called software) are operating system, application, and utility. See also *operating system, application, utility*.

properties — The attributes of an object or device. For example, the properties of a file include the file's type, size, and creation date.

-
- R**
- RAM (random access memory)** — Volatile memory that can be written to as well as read. By volatile, we mean that information in RAM is lost when you turn off your computer. This type of memory is used for your computer's main memory. See also *memory*. Compare *ROM*.
- random access memory** — See *RAM*.
- read-only memory** — See *ROM*.
- reboot** — See *boot*, *restart*.
- removable disk** — A disk that can be removed from a disk drive. A diskette is one example of a removable disk.
- resolution** — A measure of the sharpness of the images that can be produced by a printer or displayed on a screen. For a printer, resolution is expressed in dots per inch (dpi). For a screen, it is expressed as the number of pixels available horizontally and vertically.
- restart** — Synonymous with reboot. To reset the computer by reloading the operating system without turning the computer off. See also *boot*.
- RJ-11** — A modular connector used on most U.S. telephone systems and direct-connect modems. The RJ-11 connector is a 6-wire connector.
- ROM (read-only memory)** — Non-volatile memory that can be read but not written to. By non-volatile, we mean that information in ROM remains whether or not the computer is receiving power. This type of memory is used to store your computer's BIOS, which is essential instructions the computer reads when you start it up. See also *BIOS*, *memory*. Compare *RAM*.
- S**
- select** — To highlight or otherwise specify text, data, or graphics with the intent to perform some operation on it.
- serial** — Processes that occur one at a time. In communications, it means the transmission of one bit at a time sequentially over a single channel. On your computer, the serial port provides a serial interface between the computer and an appropriate device. Compare *parallel*.
- shortcut** — See *keyboard shortcut*.

software — See *program*. Compare *hardware*.

Standby — A feature of some Windows® operating systems that allows you to turn off the computer without exiting your open applications and to continue from where you left off when you turn the computer on again.

Suspend — A feature of some Windows® operating systems that allows you to turn off the computer without exiting your open applications and to continue from where you left off when you turn the computer on again.

system disk — A diskette that contains the operating system files needed to start the computer. Any diskette can be formatted as a system disk. A system disk is also called a “bootable disk” or a “startup disk.” Compare *non-system disk*.

system prompt — The symbol (in MS-DOS®, generally a drive letter followed by a “greater than” sign) indicating where users are to enter commands.

T U

TFT display — See *active-matrix display*.

universal serial bus (USB) — A serial bus that supports a data transfer rate of up to 480 Mbps (480 million bits per second). USB can connect up to 127 peripheral devices through a single all-purpose USB port. USB allows hot swapping of peripherals. See also *bus*, *hot swapping*, *serial*.

upload — To send a file to another computer through a modem or network. See also *download*.

USB — See *universal serial bus (USB)*.

utility — A computer program designed to perform a narrowly focused operation or solve a specific problem. Utilities are often related to computer system management.

W

Web — See *World Wide Web*.

Wi-Fi — A trademarked term by the Wi-Fi Alliance which stands for Wireless Fidelity, and is another term for the communication protocol to permit an Ethernet connection using wireless communication components.

World Wide Web (www) — The worldwide network of Web sites linked together over the Internet. A user of the Web can jump from site to site regardless of the location of the computer hosting the site. See also *Internet*.

Index

A

- AC adapter 47
- AC power cord/cable connectors 234
- AC power light 50
- accessories
 - memory 53
- adding external devices 46
- adding memory 53
- adjusting recording quality 139
- Alt keys 85
- audio
 - .wav files 138
- audio features 138
- Auto-Run 101

B

- backing up files 84
- battery
 - changing 118
 - charge indicator light 110
 - charge not lasting 194
 - charging 50

- conserving power 115
- disposal 124
- low charge 114
- monitoring power 110
- not charging 194
- power schemes hot key 117
- power usage mode 228
- real-time clock (RTC) 107
- removing 119

BIOS Setup

- see TOSHIBA Hardware Setup

Bridge Media slot 146

button

- power 53
- start 128

C

CD

- creating 101
- playing an audio 99
- playing using Auto-Run 101

CD/DVD button functionality 96

channels

- DMA 189

- IRQ 189
- character keys 85
- charging the battery 50
- checking device properties 191
- click 62, 65
- communications
 - network connection 132
 - system resources 189
- compact disc positioning 98
- compact discs
 - handling 99
 - inserting 97
 - removing 102, 103
- computer
 - non-system disk or disk error message 185
 - not accessing disk drives 184
 - running on battery power 105
 - setting up 43, 55
 - warning resume failure message 184
- computing tips 83
- connecting to a power source 47
- connection
 - set up 132
- control buttons 62, 65
- critical applications 3
- Ctrl keys 85
- D**
- desktop
 - creating new icon 127
 - major features 127
- desktop exploration 126
- desktop icons 127
- Device Manager 190
 - checking properties 191
 - disabling a device 191
- devices
 - keyboard 70
 - mouse 71
- Disk Defragmenter 199
- disk drive
 - corrupted/damaged data files 200
 - missing files/trouble accessing a disk 198
 - running slow 199
- disk light 74
- diskette drive
 - cannot insert a diskette 200
 - cannot read a diskette 200
 - connecting 73
 - external, connecting 73
- display
 - does not look normal/flickers 197
 - external monitor not working 198
 - screen is blank 196
- display device
 - external 68
- display output settings 69
- display, external
 - adjusting 70
- disposal information 25
- disposing of used batteries 124
- DMA (Direct Memory Access) 189
- double-click 62, 65
- drive in-use indicator light 95
- Drive light 42
- Drive-in-use light 74
- DVD player
 - general problems 211
- DVD-ROM drive
 - problems 201
 - troubleshooting 201
- DVD-ROM/multi-function drive
 - problems 201

DVI video port 68

E

environment

computer-friendly 39

error messages

device driver conflict 188

general hardware problem 188

non-system disk or disk error
185, 200

problem with display settings/
current settings not
working with hardware
197

program has performed an
illegal operation 182
warning resume failure 184

Error-checking 199

Ethernet LAN port 133

expansion memory slot 56

exploring the desktop 126

ExpressCard

inserting 144

external

monitor

not working 198

mouse 71

external devices 46

external diskette drive

connecting 73

external display, adjusting 70

F

FAT (File Allocation Table) 199

FCC Notice “Declaration of Con-
formity Information” 3

FCC requirements 4

file extensions 92

file, backing up 84

files

backing up 93

printing 92

restoring 94

saving 90

Fingerprint Authentication Utility
168

Fn keys 85

function keys 86

H

hard disk light 74

hardware conflicts 188
resolving 190

headphones

using 140

Help and Support

Windows XP 187

Hibernation mode 75

configuring 78

starting again from 79

hot key

display brightness 232

display modes 231

Hibernation mode 230

instant password security 226

keyboard 232

keyboard overlays 233

password security 226

power usage 228

power usage mode 228

Standby mode 229

volume mute 225

hot key power schemes 117

hot key utility 160, 161

hot keys 226

I

icon 127

desktop 127

Internet Explorer 128

- moving to desktop 127
- recycle bin 127
- safety 36
- Industry Canada requirement 4
- installation
 - memory module 54
- installing
 - memory modules 53
 - mouse 71
- instant passwords, using 154
- Internet
 - bookmarked site not found 187
 - connecting to 136
 - features 137
 - slow connection 187
 - surfing 136
 - uploading and downloading files 138
 - URL address not found 187
- Internet Explorer icon 128
- Internet Service Providers 135
- IRQ (Interrupt Request) 189
- ISPs 135

J

- jack
 - RJ-11 131

K

- keyboard
 - character keys 85
 - function keys 86
 - hot keys 233
 - not working 184
 - troubleshooting 195
- keyboard, external 70
- keyboard, PS/2-compatible 70

L

- light
 - drive in-use indicator 95

M

- main battery
 - removing 119
- Main battery light 49
- memory
 - adding 53
 - expansion slots 54
 - problem solving 192
 - removing expansion slot cover 56
- memory module
 - inserting 57
 - installation 54
 - removing 60
- microphone 139
- modem
 - determining COM port 130
 - problem solving 207
 - resetting port to default settings 130
 - upgrading 130
- modem default 130
- monitor 68
 - connecting 68
 - not working 196
- mouse
 - installing 71
 - serial 71

N

- network 132
 - accessing 132
- networking
 - wireless 132

O

- opening the display panel 51
- other documentation 37

P

- password
 - deleting a supervisor 156
 - disabling a user 157
 - supervisor
 - set up 155
 - types 154
- passwords
 - instant, using 154
 - setting 154
- PC Card
 - checklist 204
 - CIS (Card Information Structure) 203
 - computer stops working 205
 - configuring 143
 - errors 206
 - hot swapping fails 205
 - inserting 142
 - not recognized 205
 - problem solving 203, 204
 - removing 143, 145
 - setting up 143
- Plug and Play 189
- port
 - COM 130
 - Ethernet LAN 133
 - RGB 68
- power
 - computer will not start 183
 - energy-saving features 105
 - problem solving 193
 - turning on 52
 - universal power supply 234
- Power button 53
- power button 53
- power schemes
 - hot key 117
- power source 47
- power usage modes 116
- powering down
 - using Standby 78, 79
- precautions 40
- primary button 62, 65
- printer
 - local, connecting 71
 - problem solving 206, 207
- printing a file 92
- problem solving
 - AC power 193
 - accessing disk drives 184
 - battery charge does not last 194
 - battery not charging 194
 - cannot insert diskette in drive 200
 - cannot read a diskette 200
 - changing display properties 197
 - checking device properties 191
 - computer hangs when PC Card inserted 205
 - computer will not power up 183
 - contacting Toshiba 221, 222
 - corrupted/damaged data files 200
 - Device Manager 190
 - disabling a device 191
 - disk drive is slow 199
 - display is blank 196
 - external display not working 198
 - external monitor 196
 - faulty memory 192
 - hardware conflict 188, 189

- high-pitched noise 202
- illegal operation 182
- Internet bookmarked site not found 187
- Internet connection is slow 187
- keyboard
 - not responding 184
- missing files/trouble accessing a disk 198
- modem not receiving or transmitting 207
- no sound 202
- non-system disk or disk error 185, 200
- PC Card 203
 - checklist 204
 - error occurs 206
 - hot swapping fails 205
 - not recognized 205
 - slot appears dead 204
- power and batteries 193
- printer 206, 207
- program not responding 181
- program not working properly 200
- screen does not look right/flickers 197
- Startup options 186
- system resources 189
- URL address not found 187
- warning resume failure 184
- Windows will not start 184
- Windows XP not working 185

program, starting 87

programs

- not running correctly 200

projector 68

- connecting 68

protection of stored data 2

R

- real-time clock (RTC) battery 107
- recording
 - .wav files 138
 - sounds 138
- recording quality 139
- recording sounds 138
- recycle bin icon 127
- registering computer 45
- removing
 - main battery 119
- RGB (monitor) port 68
- RJ-11 jack 131
- Run dialog box 89
- running the computer on battery power 105

S

- safety
 - computer 125
 - disposing of batteries 124
 - icons 36
 - precautions 40
- saving files 90
- screen
 - blank 196
 - does not look normal/flickers 197
- secondary button 62, 65
- setting up
 - adding memory 53
 - computer 43, 55
- setting up a connection 132
- sound
 - problem solving 202
- sounds
 - recording 138
- speakers
 - using external 140

- Standby 76
- Standby mode
 - hot key 229
 - starting again from 80
- start button 128
- starting a program 87
 - Run dialog box 89
 - Windows Explorer 88
 - Windows Start menu 87
- starting up the computer
 - from Shut down 78
 - from Standby 80
- Startup menu
 - problem solving 186
- stored data protection 2
- supervisor password, deleting 156
- supervisor password, set up 155
- S-video port 68
- system tray 129

T

- taskbar 129
- television
 - adjusting display 70
- Toshiba
 - registering computer 45
 - worldwide offices 223
- Toshiba Assist 149
- Toshiba Hardware Setup 162
- Toshiba online resources 104
- Toshiba utilities 148
- traveling tips 125
- troubleshooting
 - DVD player
 - general problems 211
 - DVD-ROM drive 201
 - external keyboard 195
 - keyboard 195
 - keypad overlay 195
- Turning off computer

- Drive light 42
- turning on the computer 53
- turning on the power 52

U

- user password, disabling 157
- using a file extension 92

V

- video projector
 - adjusting display 70

W

- warranty
 - limited warranty 38
- Web sites 222
- Wi-Fi
 - antenna switch 134
 - wireless networking 132
- Wi-Fi antenna switch 208
- Windows Explorer 88
- Windows Media Player 99
- Windows Start menu 87
- Windows XP
 - Help and Support 187
 - problem solving 185
- Windows XP Professional desktop 126
- wireless
 - antenna switch 134, 208
 - indicator light 134
 - interoperability 7
 - networking 132
 - networking problems 208
- Wireless LAN Connectivity 134

X

- xD-Picture Card 146

Free Manuals Download Website

<http://myh66.com>

<http://usermanuals.us>

<http://www.somanuals.com>

<http://www.4manuals.cc>

<http://www.manual-lib.com>

<http://www.404manual.com>

<http://www.luxmanual.com>

<http://aubethermostatmanual.com>

Golf course search by state

<http://golfingnear.com>

Email search by domain

<http://emailbydomain.com>

Auto manuals search

<http://auto.somanuals.com>

TV manuals search

<http://tv.somanuals.com>