

# Owners Manual

**TEC LOAD CELL SCALE**  
(WITH LABEL PRINTER)

**MODEL SL57 SERIES**  
(US. Version)

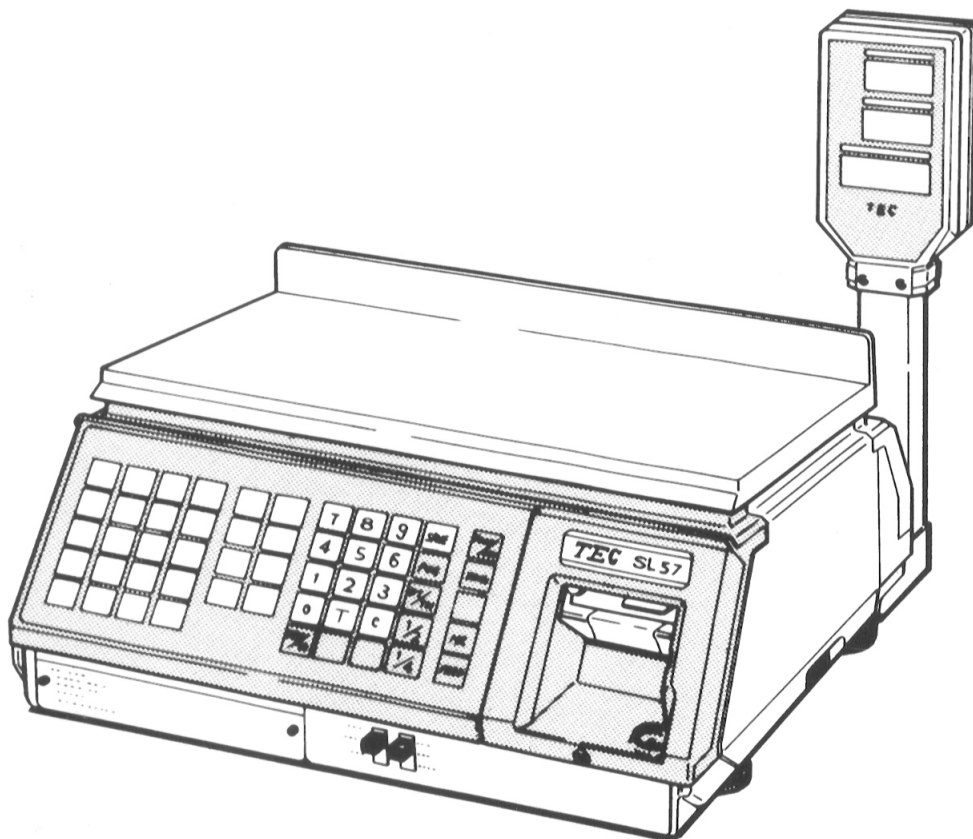

**TEC** TOKYO ELECTRIC CO., LTD.

**WARNING**

This equipment generates, uses, and can radiate radio frequency energy and if not installed and used in accordance with the instruction manual, may cause interference to radio communications. It has been tested and found to comply with the limits for a Class A computing device pursuant to Subpart J of Part 15 of FCC Rules, which are designed to provide reasonable protection against such interference when operated in a commercial environment. Operation of this equipment in a residential area is likely to cause interference in which case the user at his own expense will be required to take whatever measures may be required to correct the interference.

## TABLE OF CONTENTS

	Page
INTRODUCTION.....	1
PRECAUTIONS.....	1
1. SPECIFICATIONS.....	2
2. OVERVIEW.....	3
3. REMOTE DISPLAY.....	3
4. KEY ARRANGEMENT.....	4
5. KEY AND LAMP FUNCTIONS.....	4
6. LEVEL ADJUSTMENT.....	7
7. CLEANING THE PRINT HEAD.....	7
8. REMOVAL AND REPLACEMENT OF LABEL ROLL.....	8
9. NOTES BEFORE STARTING OPERATION.....	9
10. OPERATION PROCEDURES	
10-1. Weighed Article Registration.....	10
10-2. Fix Price Registration.....	11
10-3. By Count Registration.....	12
10-4. Tare Function Procedures.....	14
10-5. Save Function Procedures.....	16
10-6. Unit Price per 1/2, 1/4 lbs.....	18
10-7. Date Change.....	19
10-8. Shelf Life Date Setting.....	20
10-9. Print Test Label.....	20
11. TOTAL OPERATION PROCEDURES	
11-1. Individual Department Read.....	21
11-2. Grand Total Read.....	21
11-3. Individual Department Reset.....	22
11-4. Grand Total Reset.....	22
12. PROGRAMMING PROCEDURES	
12-1. Date and Time Setting.....	23
12-2. Unit Price Presetting or Changing.....	23
12-3. Name or Message Programming.....	23
12-4. Address or Message Programming (Bottom of label).....	24
12-5. Print Item ON/OFF Setting or Changing.....	24
13. ERROR MESSAGE TABLE.....	26
14. BEFORE YOU CALL FOR SERVICE.....	26

## INTRODUCTION

We thank you very much for purchasing our TEC Electronic SL57 Series Scale.



This series has been designed with TEC reliability and offer a cost efficient system for a modest investment.

And the SL57 (with thermal printer) takes advantage of the latest technology in microprocessors. Because of this, the decreased cabinet size permits the system to be placed virtually anywhere in your store.

Your deli, and specialty departments can enjoy these high quality reliable TEC products. Improve your operating effectiveness and watch the increased utilization of your front end scanning investment. This electronic Load Cell scale eliminates all moving parts and furnishes an accurate digital display of all information.

We believe that your needs will now be fully satisfied, and you will have total reliability in price calculation. This manual will help to acquaint you with the proper operation and care of the SL57 series scale. Please keep it handy for future reference.

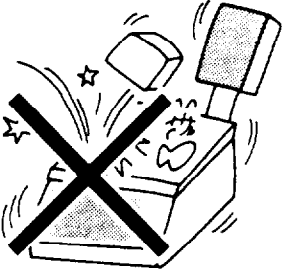
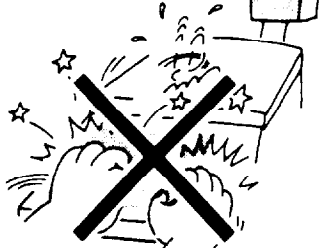
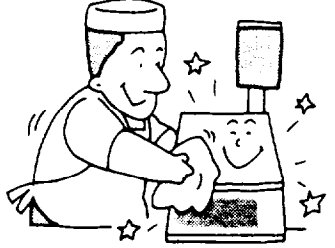
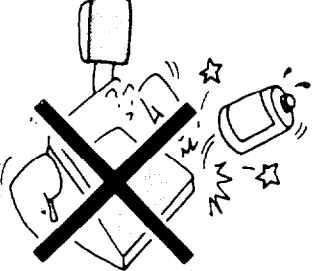
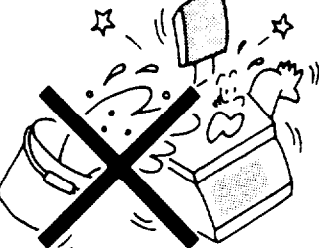
## PRECAUTIONS

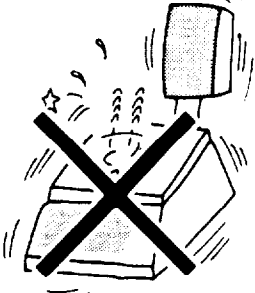
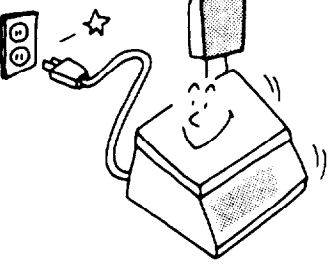
<p>1. DON'T SUBJECT the weighing platter to SUDDEN SHOCKS.</p> 	<p>2. DON'T PRESS THE KEYS TOO HARD. Keys will operate correctly if they are merely touched lightly.</p> 	<p>3. Clean the cover and platter by wiping with a dry cloth or a cloth soaked with detergent and wring out thoroughly.</p> 
<p>4. NEVER USE THINNER OR OTHER VOLATILE SOLVENT for cleaning.</p> 	<p>5. DON'T POUR WATER directly on scale.</p> 	<p>6. To insure scale is operating correctly, place a known weight on platter and check for correct computing.</p> 
<p>7. When in use, avoid locations subject to vibration and direct sunlight.</p>  		<p>8. After the end of daily work, turn the power OFF, clean and inspect the exterior of the scale to allow you to use the scale at its best condition.</p> 

# 1. SPECIFICATIONS

Items	SL57-30L-US
Maximum Capacity	30 lbs
Minimum Scale Division	0.01 lbs
Using Weight Range	0.20 ~ 30 lbs
Display Range	0 ~ 30.05 lbs
Tare	0.01 ~ 30 lbs
Unit Price Presetable	\$ 0.01 ~ 99.99
Minimum Price Display	\$ 0.01
Power Requirement	AC 120V $\pm$ 10%, 60 Hz
Current Consumption	120V · 1A, 60 Hz
Temperature Limits	23° ~ 104°F
Relative Humidity	35% ~ 85% RH (No condensation)
Weight	26.5 lbs
Remote Display:	
Weight	4 digits
Unit Price	4 digits
Total Price	5 digits
Display Designations	NET, PREPACK, ERROR
Remote Display Mode	Dual sides
Print Head	Thermal Print Head
Label	RICOH 120LA or equivalent

## Dimensions (approximate)

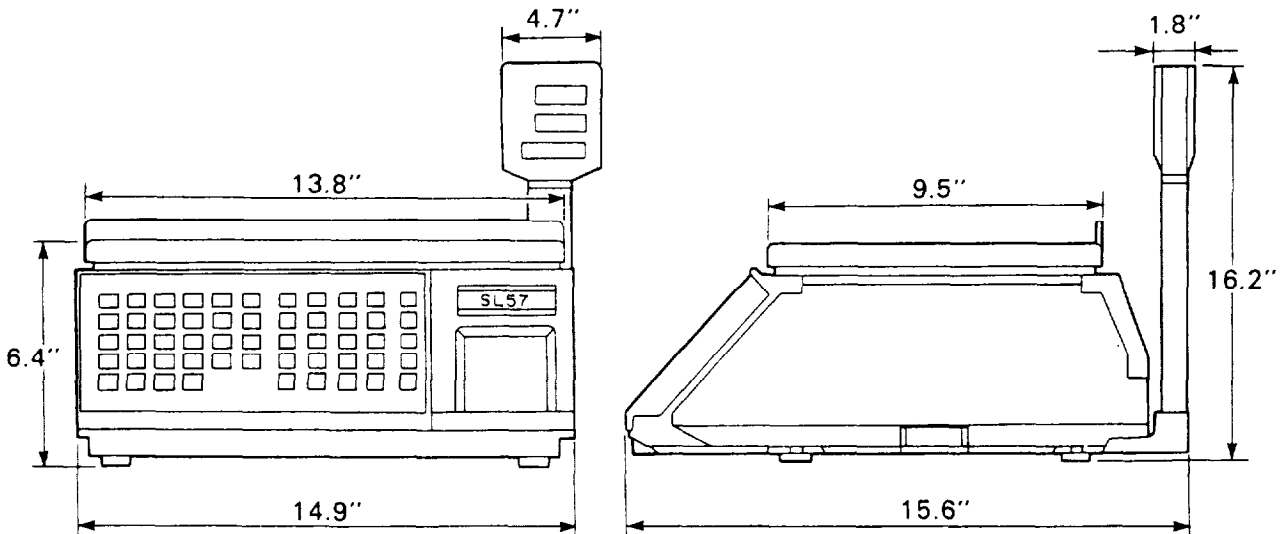

## 2. OVERVIEW

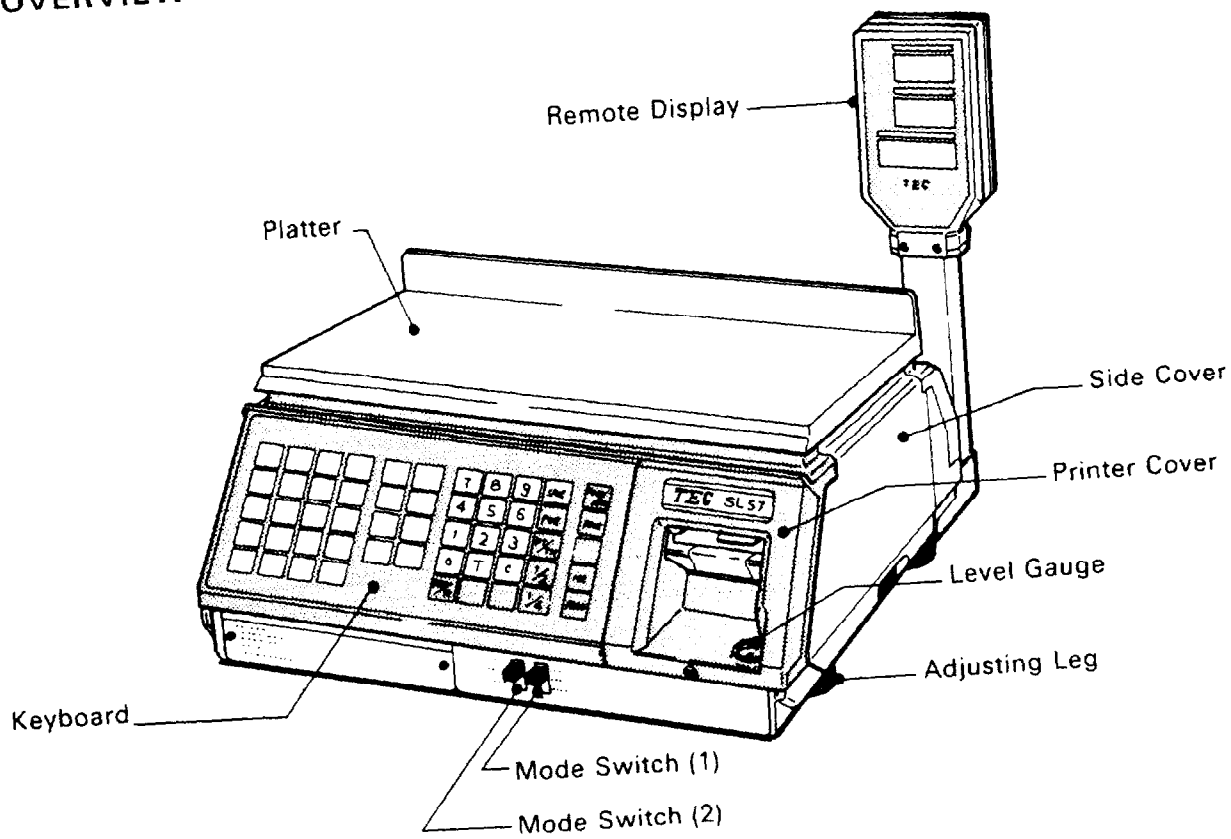

## 3. REMOTE DISPLAY

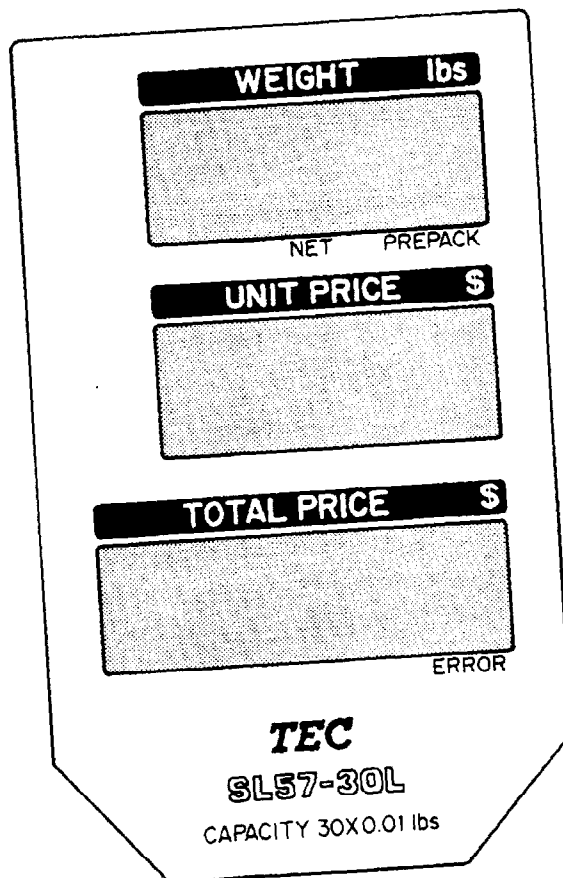



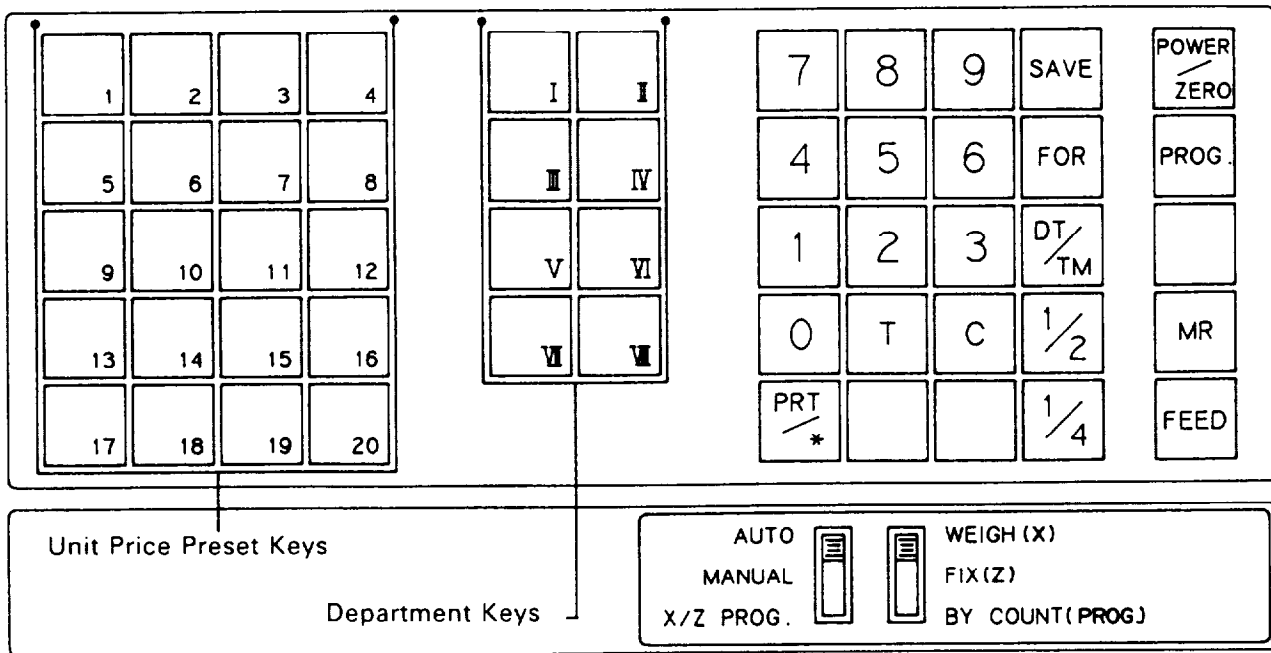





## 4. KEY ARRANGEMENT





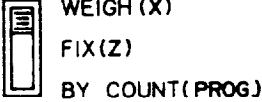





**NOTE:** The characters indicated on the Unit Price Preset keys and the Department keys are shown for the convenience of explanation in this manual. The indications on the actual unit are not as shown in this illustration.

## 5. KEY AND LAMP FUNCTIONS

Name of Key or Lamp	Function
<b>CLEAR Key</b> 	<ol style="list-style-type: none"> <li>This key is used for enter-clear of numeric key.</li> <li>This key is used to release the scale from the save or error mode.</li> </ol>
<b>DATE &amp; TIME Key</b> 	<ol style="list-style-type: none"> <li>This key is used to indicate the date on remote display.</li> <li>This key is used for temporary date change.</li> </ol>
<b>DEPARTMENT Keys</b> 8 keys 	<ol style="list-style-type: none"> <li>These keys are used to program the department name.</li> <li>These keys are used to register the sale items. At this time, the Department keys are also used as the Label Issue keys.</li> <li>In "X/Z" mode switch (2) position, these keys are used to generate the Department Total Reports.</li> </ol>
<b>FEED Key</b> 	This key is used to feed labels.

Name of Key or Lamp	Function
FOR Key 	<ol style="list-style-type: none"> <li>1. This key is used to issue the "BY COUNT" label with split price.</li> <li>2. In "X/Z" mode switch (2) position, this key is used to issue the TEST label.</li> </ol>
Mode Switch (1) 	<p><b>"WEIGH (X)" position:</b></p> <ol style="list-style-type: none"> <li>1. This position is used in weighing function of SL57.</li> <li>2. This position is used to read (X) all the accumulated sales totals stored in the unit when mode switch (2) is set to "X/Z PROG." position.</li> </ol> <p><b>"FIX (Z)" position:</b></p> <ol style="list-style-type: none"> <li>1. The unit price enters directly to total price, and that total price cannot be changed by any weighing after that.</li> <li>2. This position is used to reset (Z) all the accumulated sales totals stored in the unit when mode switch (2) is set to "X/Z PROG." position.</li> </ol> <p><b>"BY COUNT (PROG.)" position:</b></p> <ol style="list-style-type: none"> <li>1. It is possible to produce labels which contain information of quantity pricing, instead of weight.</li> <li>2. This position is used to set the various programs when mode switch (2) is set to "X/Z PROG." position.</li> </ol>
Mode Switch (2) AUTO MANUAL X/Z PROG. 	<p><b>"AUTO" position:</b></p> <ol style="list-style-type: none"> <li>1. This position is used to issue weighing label when mode switch (1) is set to "WEIGH" or "FIX" position.</li> <li>2. This position is used to issue By Count label when mode switch (1) is set to "BY COUNT" position. The label is issued in succession after peeling it.</li> </ol> <p><b>"MANUAL" position:</b> This position is used to issue a label by depressing the PRINT key or DEPARTMENT key.</p> <p><b>"X/Z PROG." position:</b></p> <ol style="list-style-type: none"> <li>1. This position is used to read (X) or reset (Z) all the accumulated sales totals in the unit when mode switch (1) is set to "WEIGH (X)" or "FIX (Z)" position.</li> <li>2. This position is used to set the various programs when mode switch (1) is set to "BY COUNT (PROG.)" position.</li> </ol>
MR Key 	<ol style="list-style-type: none"> <li>1. In "X/Z" mode switch (2) position, this key is used to generate the Grand Total Read Report.</li> <li>2. This key is used to select the items in programming.</li> </ol>
Numeric Keys 	These keys are used to enter the numeric data (Unit Price, Tare weight, etc.).
Per 1/2, 1/4 lbs Keys 	These keys are used to calculate the unit price by 1/2 lbs or 1/4 lbs. <b>NOTE:</b> When the 1/2(1/4) key is depressed, the unit price is multiplied by 2(4).



Name of Key or Lamp	Function
POWER/ZERO Key 	This key is used to supply power to the main circuit and to adjust "ZERO" point.
PRINT/VERIFY Key 	<ol style="list-style-type: none"> <li>1. This key has the function of label issue.</li> <li>2. During programming, data is input to the SL57 by using this key.</li> </ol>
PROGRAM Key 	This key is not used in SL57 system.
SAVE Key 	This key is used to save tare and unit price after taking off the commodity from the platter.
TARE Key 	<ol style="list-style-type: none"> <li>1. This key is used to subtract or clear the tare weight.</li> <li>2. This key is used to preset tare weight beforehand through the numeric keys.</li> </ol>
UNIT PRICE PRESET Keys 	These keys are used to set and call the unit price of frequently used commodities.
NET Lamp 	Lights when tare is subtracted.
PREPACK Lamp 	Lights when SAVE key is pressed.
ERROR Lamp 	Lights when this scale is improperly operated or has caused a function error.

## 6. LEVEL ADJUSTMENT



Correct



Incorrect

Set the scale on a stable and level surface.

Level the scale by turning the adjusting legs so that the air bubble comes to the center circle. For example, in the case of the condition shown in the left figure, turn the adjusting legs (1) and (2) in the direction shown so that the bubble comes to the center of the circle.

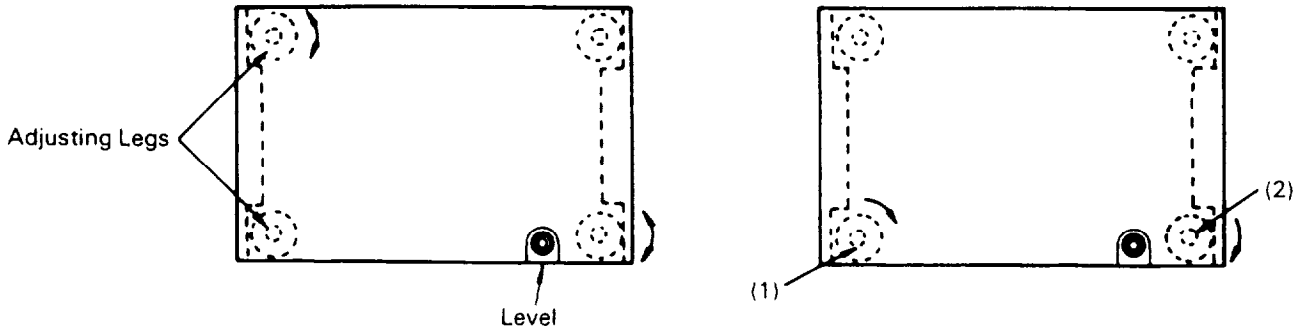

## 7. CLEANING THE PRINT HEAD

If the print head is dirty, clear printing is not performed. It is recommended to clean the head with thermal head cleaner everyday, before starting operation by following procedure:

<p>1. Remove the printer cover and side cover. Then pull the head-up lever to arrow direction.</p>	
<p>2. Wipe off the dirt on the [■ portion] with the thermal head cleaner. Then set the label, and push down the print head. <b>NOTE:</b> Do not damage the print head when cleaning.</p>	

## 8. REMOVAL AND REPLACEMENT OF LABEL ROLL

1. Remove the printer cover and side cover.  
Then pull the head-up lever to arrow direction.

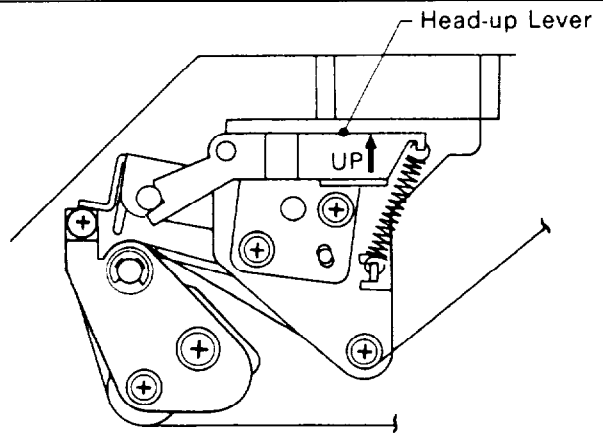

2. Remove the core of the label roll and the label backing paper.

**NOTE:** To remove the label backing paper, loosen the paper by turning the paper clockwise and remove the paper stopper. Be careful to never turn the paper winding shaft clockwise.

Referring to the figure on the right, set the label roll on the unit.

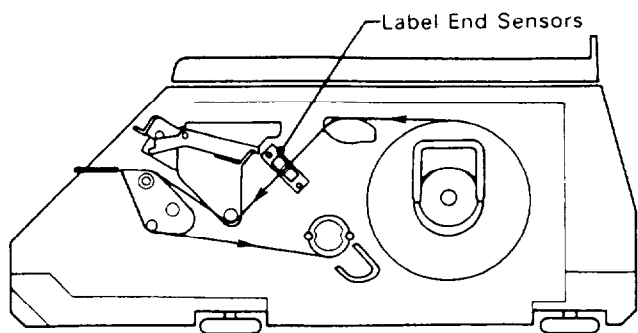

3. Push down the printer head, and close the covers.

**NOTE:** When the label roll is replaced, press the feed key to confirm that the label is issued correctly.

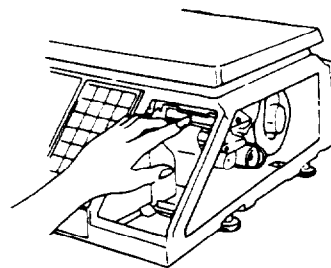

## 9. NOTES BEFORE STARTING OPERATION

- (1) Be sure to insert the power plug into AC outlet.
- (2) When the power key is turned on, the scale goes through the test scanning sequence, such as 0000,0000,00000, then 1111,1111,11111 .....and zeros appear on the displays. When the power key is turned on over about 16 seconds after the power plug is connected to the AC outlet, all "8"s appear on all displays for a moment, then zeros are displayed and the scale is ready for use.
- (3) While scale is in the test sequence, do not put anything on the platter.
- (4) Do not move the unit while it is in operation. Should it become necessary to move it at any time, turn the power switch to OFF position and be sure to readjust the level indicator after relocating the scale.
- (5) Should a power failure occur during operation, remove the commodity from the platter and insert the power plug into AC outlet again when power is restored.
- (6) If scale is used with an unrated power source, inaccurate scaling or other errors may occur.
- (7) If Zero Point has shifted during scaling, and no tare is displayed, adjust Zero Point by depressing Zero key twice.

# 10. OPERATION PROCEDURES

## 10-1. Weighed Article Registration [Mode SW. (1): WEIGH position]

### ★ Auto Mode [Mode SW. (2): AUTO position]

(1) Press unit price preset key or enter the unit price.

ex.) Unit price of \$ 2.50/lb.

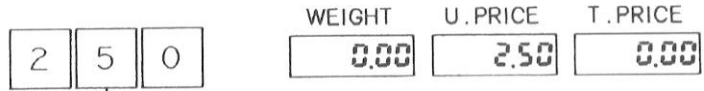

(2) Place an article on the platter.



(3) The label is issued automatically.

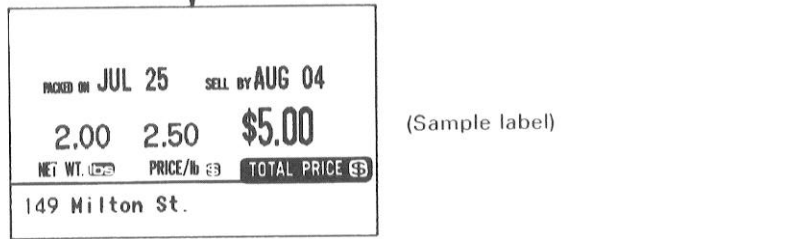

### ★ Manual Mode [Mode SW. (2): MANUAL position]

(1) Press unit price preset key or enter the unit price.

ex.) Unit price of \$ 2.50/lb is set in preset key **1**.

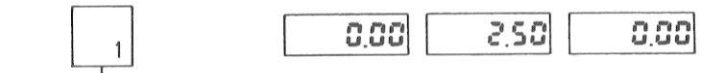

(2) Place an article on the platter.



(3) Press **PRT/\*** or department key for the article.

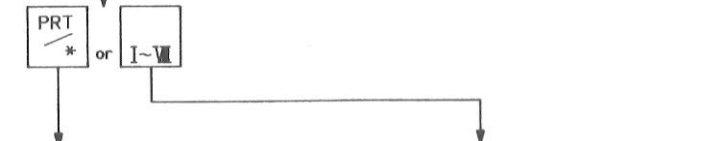

(4) The label is issued.

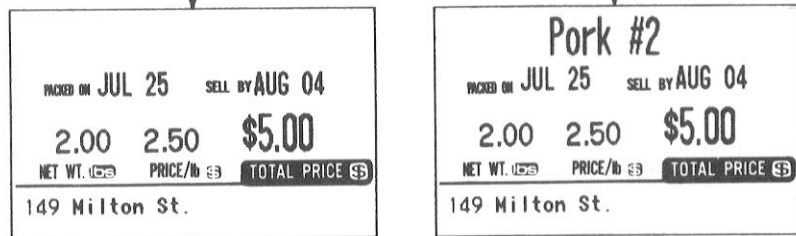

(Sample labels)

#### NOTE:

When the Mode SW. (2) is set to AUTO position, the character(s) registered in the department key is (are) printed in the department name area of the label.

When the **PRT/\*** key is pressed with the Mode SW. (2) set to MANUAL position, the character(s) printed in the department name area of the label is (are) also that (those) registered in advance in the department key. The data (Weight data, Item data, and Total Price data) of the issued label is added to the department No. 8 memory.

10-2. Fix Price Registration [Mode SW. (1): FIX position]

★ Auto Mode [Mode SW. (2): AUTO position]

- (1) Press unit price preset key or enter the unit price.

ex.) Unit price of \$ 3.00/lb is set in preset key [2].

- (2) Place an article on the platter.

- (3) The label is issued automatically.

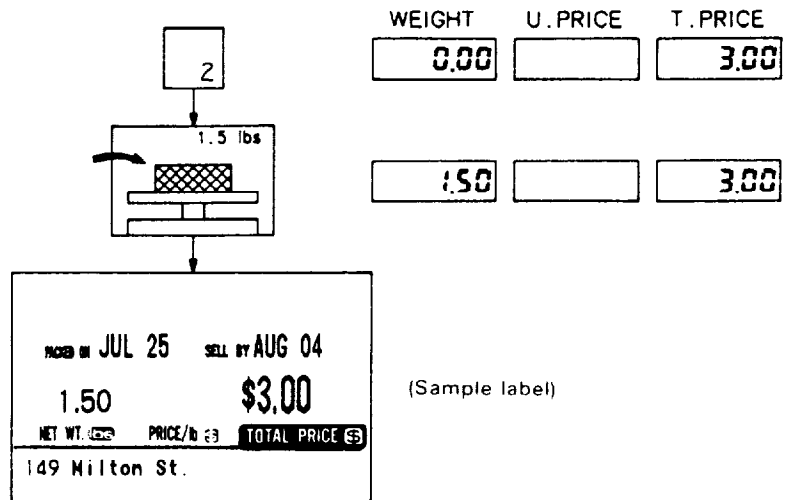

★ Manual Mode [Mode SW. (2): MANUAL position]

- (1) Press unit price preset key or enter the unit price.

ex.) Unit price of \$ 3.00/lb.

- (2) Place an article on the platter.

- (3) Press [PRT/\*] or department key for the article.

- (4) The label is issued.

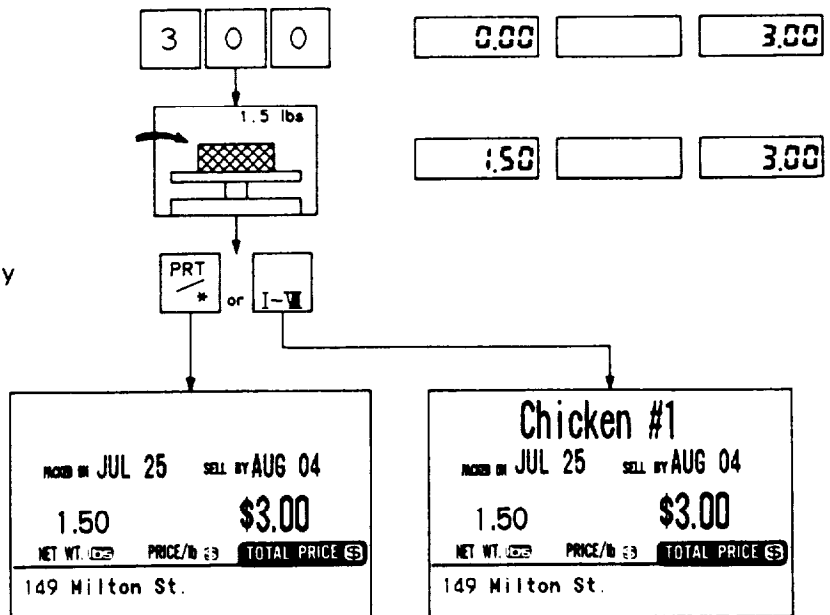

(Sample labels)

### 10-3. By Count Registration [Mode SW. (1): BY COUNT position]

#### ★ General Operation

(1) Enter the quantity of sale.  
(Max. 2 digits)

(2) Press **FOR**.

(3) Enter the total price or press the preset key.

(4) Press **PRT/\*** or department key for the article.

(5) When Mode SW.(2) is set to MANUAL position, single label is issued.

(6) When Mode SW.(2) is set to AUTO position, the label is issued in succession after peeling it.

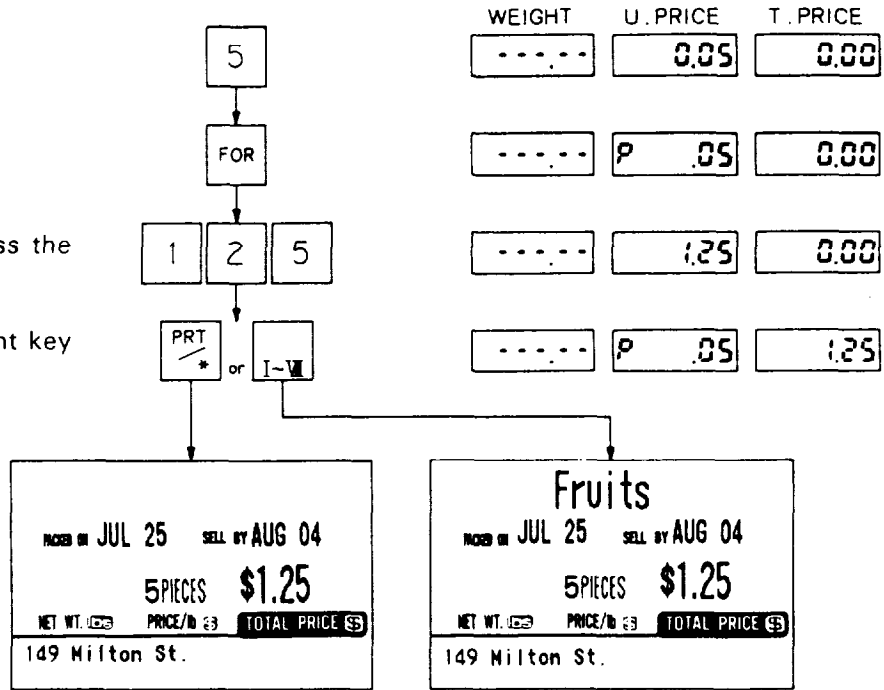

(Sample labels)

#### ★ Single Item Registration

(1) Enter the total price or press the preset key.

(2) Press **PRT/\*** or department key for the article.

(3) The label is issued.

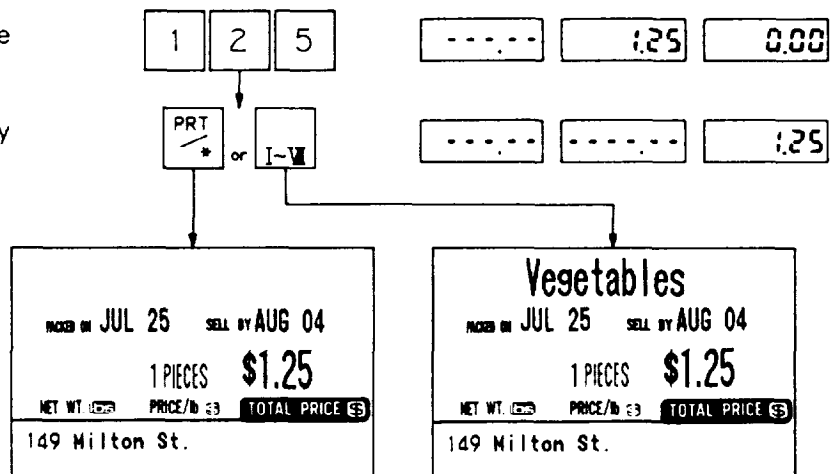

(Sample labels)

★ Split Price Operation

(1) Enter the quantity of sale.  
(Max. 2 digits)

1 0

WEIGHT	U. PRICE	T. PRICE
---.---	0.10	0.00

(2) Press **FOR**.

FOR

---.---	P .10	0.00
---------	-------	------

(3) Enter the quantity for that total price. (Max. 2 digits)

1 5

---.---	0.15	0.00
---------	------	------

(4) Press **FOR**.

FOR

---.---	P .15	0.00
---------	-------	------

(5) Enter the total price or press the preset key.

3 0 0

---.---	3.00	0.00
---------	------	------

(6) Press **PRT/\*** or department key for the article.

PRT/\* or I-VII

---.---	P .10	2.00
---------	-------	------

(7) The label is issued.

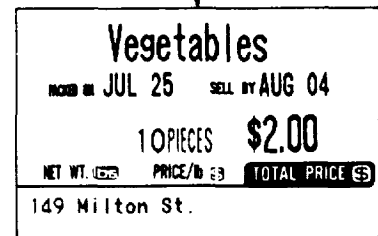
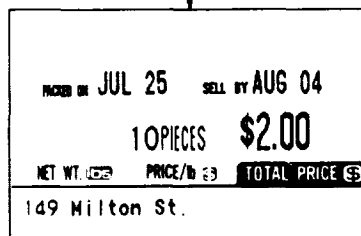

(Sample labels)



## 10-4. Tare Function Procedures

There are two kinds of tare subtraction procedures, one is "Direct tare", another is "Preset tare".

### ★ Direct Tare Subtraction [ Mode SW. (1): WEIGH or FIX ] [ Mode SW. (2): MANUAL ]

(1) Place tare weight on the platter.

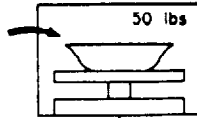

WEIGHT  
0.50

(2) Press **T**.



0.00

(3) Start the weighing or fix price operation.

Weighing or  
Fix Price  
operation

★ NET

(4) The label is issued.

The label  
is issued.

(5) Remove the article together with tare.



0.00

Tare weight  
is cleared  
automatically.

**NOTE:** Tare weight subtraction is available with up to 30 lbs. When tare weight subtraction is in operation, however, the scalable range for net weight becomes less by the amount of the tare.  
**(Net weight = Gross weight - Tare weight)**

**NOTE:** When the tare weight exceeds 0.20 lbs with the Mode SW.(2) set to AUTO position, one tare label will be issued automatically. To prevent this, set the Mode SW. (2) to MANUAL position.

★ Preset Tare Subtraction #1 [ Mode SW. (1): WEIGH  
Mode SW. (2): MANUAL ]

(1) Enter the tare weight.  
ex.)Tare weight of 0.50 lbs.

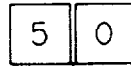

WEIGHT	U. PRICE	T. PRICE
0.00	0.50	0.00

(2) Press [T].



- 0.50	0.00	
--------	------	--

★ NET

(3) Place the tare of 0.50 lbs on the platter.

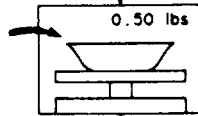

0.00	0.00	0.00
------	------	------

★ NET

(4) Start the weighing operation.

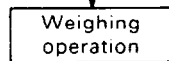

★ Preset Tare Subtraction #2 [ Mode SW. (1): FIX  
Mode SW. (2): MANUAL ]

(1) Enter the tare weight.  
ex.)Tare weight of 0.50 lbs.

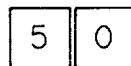

0.00		0.50
------	--	------

(2) Press [T].



- 0.50		0.00
--------	--	------

★ NET

(3) Place the tare of 0.50 lbs on the platter.

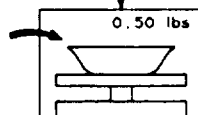

0.00		0.00
------	--	------

★ NET

(4) Start the fix price operation.

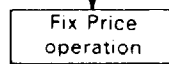

### 10-5. Save Function Procedures

Save key is used to save tare weight and unit price (or total price) after taking off the article from the platter.

#### ★ Weighed Article Mode Saving [Mode SW. (1): WEIGH]

(1) Place tare weight on the platter.

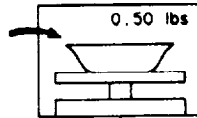

WEIGHT	U. PRICE	T. PRICE
0.50	0.00	0.00

(2) Press **T** key.



0.00	0.00	0.00
------	------	------

(3) Enter the unit price.

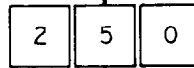

0.00	2.50	0.00
------	------	------

(4) Press **SAVE** key. Tare and Unit Price are saved.



0.00	2.50	0.00
------	------	------

(5) Place an article on.  
ex.) Weight of 2 lbs.

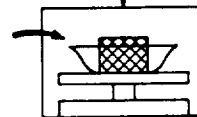

2.00	2.50	5.00
------	------	------

(6) When Mode SW. (2) is set to MANUAL position, press **PRT/\*** or department key.

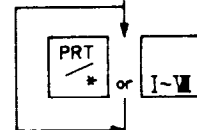

2.00	2.50	5.00
------	------	------

The label is issued.

(7) Remove the article together with tare.

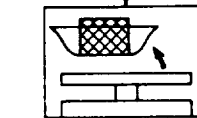

- 0.50	2.50	
--------	------	--

(8) Press **C** key.  
Clear the save mode and unit price.



- 0.50	0.00	
--------	------	--

(9) Press **O** key.



(10) Press **T** key.  
The scale is ready for use.



0.00	0.00	0.00
------	------	------

★ Fix Price Mode Saving [Mode SW. (1): FIX]

(1) Enter the tare weight.

5 0

WEIGHT	U. PRICE	T. PRICE
0.00		0.50

(2) Press **T** key.

T

- 0.50		0.00
--------	--	------

(3) Enter the total price.

3 0 0

\* NET

- 0.50		3.00
--------	--	------

(4) Press **SAVE** key. Tare weight and Total Price are saved.

SAVE

\* NET

- 0.50		3.00
--------	--	------

(5) Place an article together with tare.  
ex.) Article of 5 lbs and tare of 0.50 lbs.

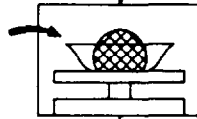

\* NET \* PREPACK

(6) When Mode SW. (2) is set to MANUAL position, Press **PRT/\*** or department key.

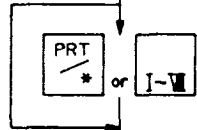

5.00		3.00
------	--	------

\* NET \* PREPACK

The label is issued.

(7) Press **C** key.

Clear the save mode and total price.

C

5.00		0.00
------	--	------

\* NET

(8) Remove the article together with tare.



0.00		0.00
------	--	------

Tare weight is cleared automatically.

**10-6. Unit Price per 1/2, 1/4 lbs [Mode SW. (1): WEIGH]**

**★ Per 1/2 lbs**

(1) Enter the unit price.

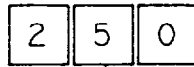

WEIGHT	U. PRICE	T. PRICE
0.00	2.50	0.00

(2) Press  $\frac{1}{2}$  key.



WEIGHT	U. PRICE	T. PRICE
0.00	5.00	0.00

(3) Place an article on the platter.

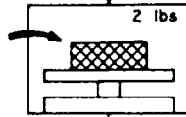

WEIGHT	U. PRICE	T. PRICE
2.00	5.00	10.00

(4) When Mode SW. (2) is set to AUTO position, the label is issued automatically.

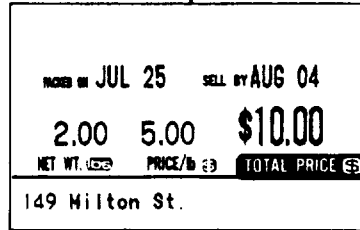

(Sample label)

**★ Per 1/4 lbs**

(1) Press unit price preset key.  
ex.) Unit price of \$ 0.75/lb is set in preset key  $\frac{3}{4}$ .



WEIGHT	U. PRICE	T. PRICE
0.00	0.75	0.00

(2) Press  $\frac{1}{4}$  key.



WEIGHT	U. PRICE	T. PRICE
0.00	3.00	0.00

(3) Place an article on the platter.

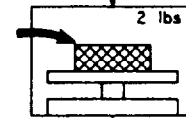

WEIGHT	U. PRICE	T. PRICE
2.00	3.00	6.00

(4) When Mode SW. (2) is set to AUTO position, the label is issued automatically.

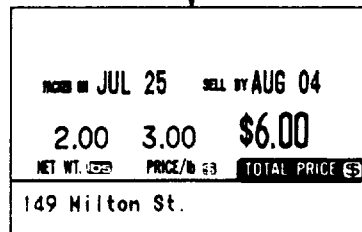

(Sample label)

**NOTE:** The SL57 will check details of unit price, if unit price after calculation (1/2 lbs: 2 times, 1/4 lbs: 4 times) is exceeded 4 digits then unit price will be cleared.

**NOTE:**  $\frac{1}{2}$  or  $\frac{1}{4}$  key should be depressed after key-in unit price.

### 10-7. Date Change [Mode SW.(2): AUTO or MANUAL]

The date can be changed temporarily.

(1) Press **DT/TM** key.

(2) Enter the new date.  
ex.) Aug. 10th. '87

(3) Press **PRT/\*** key.

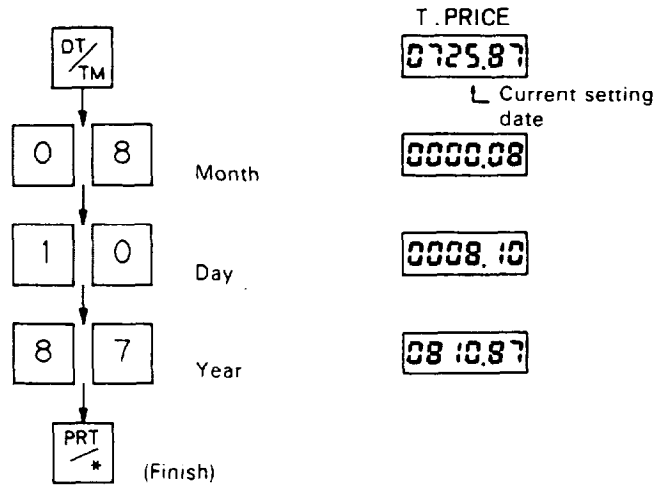

#### ★ When original date is desired.

(1) Press **DT/TM** key.

(2) Press **C** key.

(3) Press **PRT/\*** key.



### 10-8. Shelf Life Date Setting [Mode SW.(2): AUTO or MANUAL]

With the SL57 system, the shelf life date can be set for the article(s).

(1) Press **DT/TM** key.

(2) Press **SAVE** key.

(3) Enter new shelf life date.  
(Max. 3 digits)

(4) Press **PRT/\*** key.

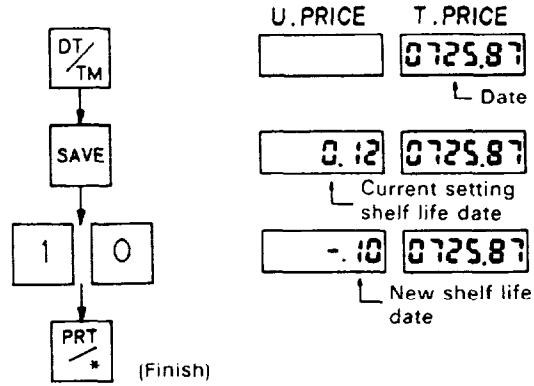

### 10-9. Print Test Label [Mode SW. (2): X/Z PROG.]

At the "X/Z PROG." position, depression of **F0R** key will issue a label indicating the area which is within the print matrix.

Please, check the condition of thermal head with this label everyday before starting operation.

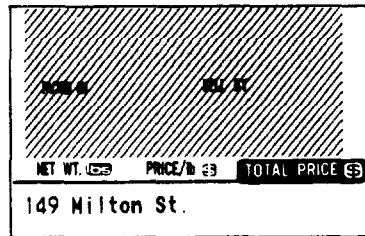

(Test label)

## 11. TOTAL OPERATION PROCEDURES [Mode SW.(2): X/Z PROG.]

The READ (X) reports allow to read the totals but not clear memories, while the RESET (Z) reports allow to read the totals and at the same time all the resettable memories will be cleared when the reports have been issued.

### 11-1. Individual Department Read [Mode SW. (1): WEIGH (X)]

(1) Press the required department key.

I

(2) The report is issued.

<b>Pork #2</b>		
NO. IN DPT-1 ◊    SELL BY JUL 25		
29.23	6	59.19
NET WT. (LBS)	PRICE/LB (\$)	TOTAL PRICE (\$)
149 Milton St.		

### 11-2. Grand Total Read [Mode SW. (1): WEIGH (X)]

(1) Press **MR** key.

MR

(2) The report is issued.

<b>GRAND TOTAL</b>		
NO. IN GRAND ◊    SELL BY JUL 25		
153.19	113	285.32
NET WT. (LBS)	PRICE/LB (\$)	TOTAL PRICE (\$)
149 Milton St.		

#### NOTES:

1. Read or Reset mark

DPT-n ◊: Department Read mark (n = 1 ~ 8)

DPT-n \*: Department Reset mark (n = 1 ~ 8)

GRAND ◊: Grand Total Read mark

GRAND \*: Grand Total Reset mark

2. Total Memory clear

	Total operation	Dept. Total Memory	Grand Total Memory
Read	Individual Department	Not cleared	Not cleared
	Grand Total	Not cleared	Not cleared
Reset	Individual Department	Cleared	Not cleared
	Grand Total	Cleared	Cleared



### 11-3. Individual Department Reset [Mode SW. (1): FIX (Z)]

(1) Press the required department key.

I

(2) The reset report is issued.

<b>Chicken #1</b>		
MODE IN DPT-2 * SELL BY JUL 25		
32.12	6	36.86
NET WT. (LBS)	PRICE/LB (¢)	TOTAL PRICE (¢)
149 Milton St.		

### 11-4. Grand Total Reset [Mode SW. (1): FIX (Z)]

(1) Press **MR** key.

MR

(2) The reset report is issued. Then all the resettable memories will be cleared.

<b>GRAND TOTAL</b>		
MODE IN GRAND * SELL BY JUL 25		
153.19	113	285.32
NET WT. (LBS)	PRICE/LB (¢)	TOTAL PRICE (¢)
149 Milton St.		

## 12. PROGRAMMING PROCEDURES [Mode SW.(1): BY COUNT (PROG.) [Mode SW.(2): X/Z PROG.]

In this chapter are described operations to add to or change the data already programmed in the "PROG" mode. To enable the programming operations in the "BY COUNT (PROG.)" position of the Mode SW.(1) and the "X/Z PROG." position of the Mode SW. (2).

### 12-1. Date and Time Setting

ex.) To set the date "July 25th. '87" and time "21:09":

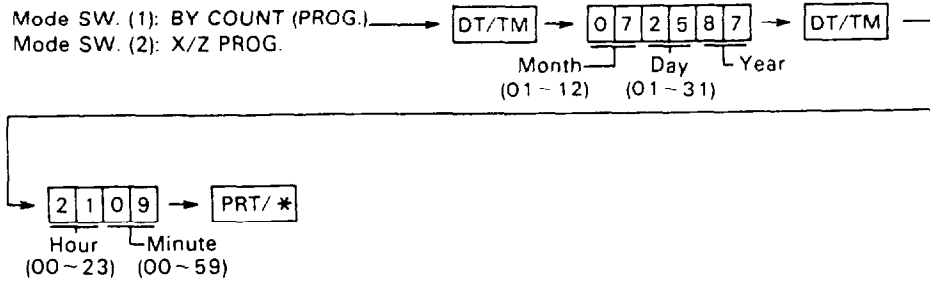

**NOTE:** The SL57 will check details of date (time) input, any wrong date (time) will result in error mode, and correct date (time) should be entered again.

### 12-2. Unit Price Presetting or Changing

ex.) To set \$ 2.50 to Preset key 1, and \$ 3.00 to Preset key 2:

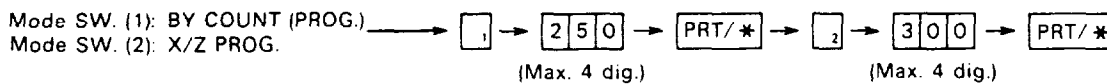

### 12-3. Name or Message Programming

(Department Name, Clerk Name, Article Name, or Commercial Message etc.)

ex.) To program "Beef #1" for Department key v.

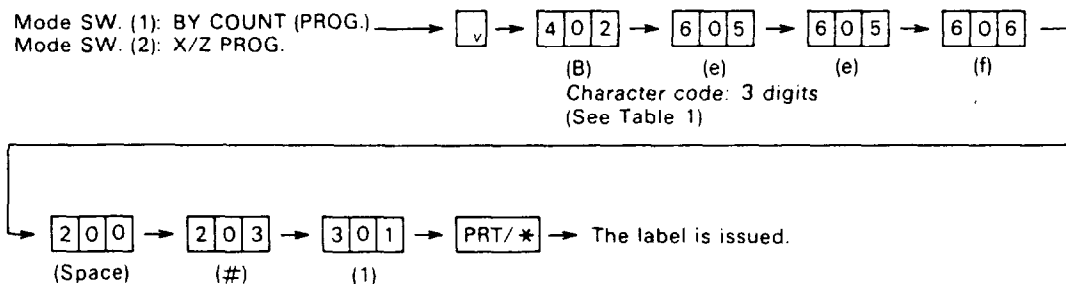

**NOTE:** Up to 20 regular-sized characters (including spaces) can be programmed on one line.

**12-4. Address or Message Programming (Bottom of label)  
(Store Address, Telephone No., Special Message etc.)**

ex.) To program the address "149 Milton St."

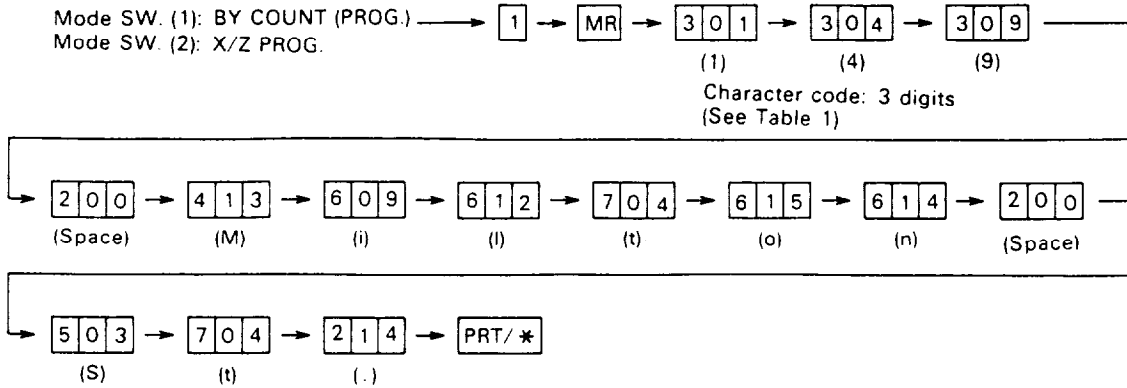

**NOTE:** Up to 26 small-sized characters (including spaces) can be programmed on one line.

**12-5 Print Item ON/OFF Setting or Changing**

This operation specifies whether each print item on the issued registration labels is to be printed or not.

ex.) To non-print the "PACKED ON date", "SELL BY date", and "Total Price".

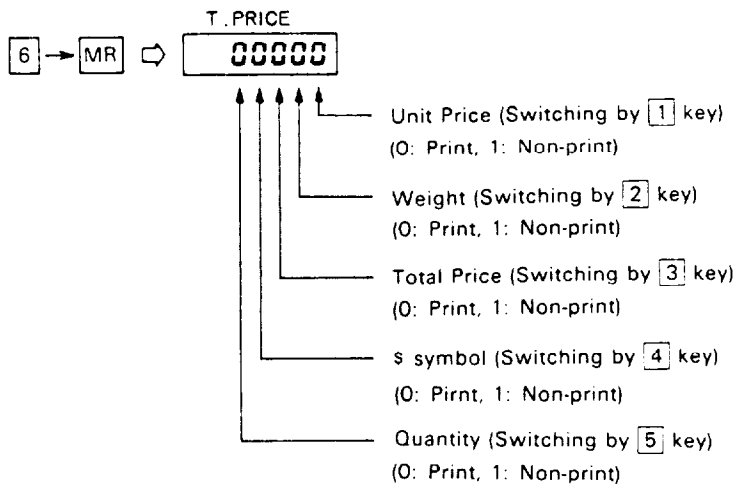
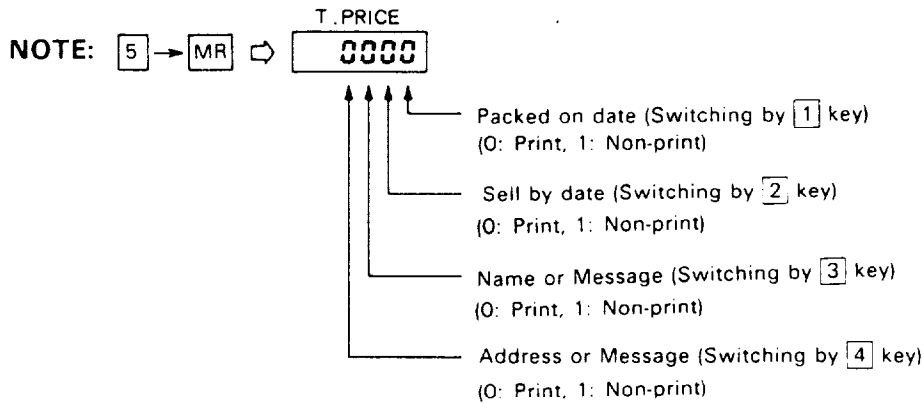
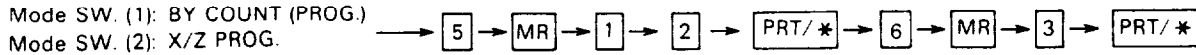

Table 1: Character Code Table

→ Column Code

↓ Row Code

Col Row	2	3	4	5	6	7	8	9
00	SP	Ø	@	P	▼	p	É	Ψ
01	!	1	A	Q	a	q	É	Δ
02	"	2	B	R	b	r	Â	Γ
03	#	3	C	S	c	s	Ê	Ξ
04	\$	4	D	T	d	t	Ö	Λ
05	%	5	E	U	e	u	ø	Π
06	&	6	F	V	f	v	Æ	Σ
07	'	7	G	W	g	w	Å	⊙
08	(	8	H	X	h	x	Ä	Ω
09	)	9	I	Y	i	y	Û	£
10	*	:	J	Z	j	z	œ	◇
11	+	:	K	[	k		Ñ	÷
12	,	<	L	\	l		! →	→
13	-	=	M	]	m		α	←
14	.	>	N	^	n	~	β	↓
15	/	?	O	_	o	☒	Φ	↑

ex.)

A



COL	ROW	
4	0	1

First enter the Column code and then the Row code for the required character. For example, to access "A", enter 401.

### 13. ERROR MESSAGE TABLE

Take the following action if an error message has appeared on the total price display with the buzzer sounding.

Message	Cause	Solution
H	Print head is not properly set.	Press <b>C</b> key, and set the print head.
L	The label has run out.	Press <b>C</b> key, and set a new label roll.
	The label is not placed over the label end sensors.	Press <b>C</b> key, and set the label correctly. (Refer to Section 8.)
P	The label interrupts the label issued sensors.	Press <b>C</b> key and <b>FEED</b> key. Then remove the label.

### 14. BEFORE YOU CALL FOR SERVICE

It is our primary concern to give you full satisfaction and better service. If, however, any problem arises in connection with the operation of this scale, please check the following points once more before calling for service:

- A) Is the power plug fully inserted into AC outlet?
- B) Is the power switch turned ON?
- C) Is AC power being properly supplied to outlet? (Check it using other electric appliance.)
- D) Check circuit breaker.
- E) Has there been a power failure of any sort?
- F) Has the operation been carried out in the correct order?

This scale has been manufactured under strict quality control. If you have trouble, however, DO NOT TRY TO FIX IT BY YOURSELF. Pull the power plug out of the AC outlet, and contact your TEC representative.

#### CAUTION:

The specifications are subject to change without notice.

***TEC***

PRINTED IN JAPAN  
E1-04316A 9509100 ①

## Free Manuals Download Website

<http://myh66.com>

<http://usermanuals.us>

<http://www.somanuals.com>

<http://www.4manuals.cc>

<http://www.manual-lib.com>

<http://www.404manual.com>

<http://www.luxmanual.com>

<http://aubethermostatmanual.com>

Golf course search by state

<http://golfingnear.com>

Email search by domain

<http://emailbydomain.com>

Auto manuals search

<http://auto.somanuals.com>

TV manuals search

<http://tv.somanuals.com>