

OWNER'S MANUAL

LCD TV/DVD Combination



THEATERWIDE **HD**

HDMI



23HLV85

Owner's Record

The model number and serial number are on the back of your TV/DVD. Record these numbers in the spaces below. Refer to these numbers whenever you communicate with your Toshiba dealer about this TV/DVD.

Model number:

Serial number:

Dear Customer,

Thank you for purchasing this Toshiba LCD TV/DVD Combination. This manual will help you use the many exciting features of your new TV/DVD Combination. **Before operating the TV/DVD Combination, please read this manual completely**, and keep it nearby for future reference.

Safety Precautions

WARNING: TO REDUCE THE RISK OF FIRE OR ELECTRIC SHOCK, DO NOT EXPOSE THIS APPLIANCE TO RAIN OR MOISTURE.



WARNING: TO REDUCE THE RISK OF ELECTRIC SHOCK, DO NOT REMOVE COVER (OR BACK). NO USER-SERVICEABLE PARTS INSIDE. REFER SERVICING TO QUALIFIED SERVICE PERSONNEL.



The lightning symbol in the triangle tells you that the voltage inside this product may be strong enough to cause an electric shock. **DO NOT TRY TO SERVICE THIS PRODUCT YOURSELF.**



The exclamation mark in the triangle tells you that important operating and maintenance instructions follow this symbol.

WARNING

To prevent injury, this apparatus must be securely attached to the floor/wall in accordance with the installation instructions. (See item 20 on page 4.)

WARNING: This product contains a laser beam. Do not attempt to stare at the beam through the DVD disc tray or the ventilation openings. Staring directly at the beam may cause permanent damage to your eyesight.

NOTE TO CATV INSTALLERS

This is a reminder to call the CATV system installer's attention to Article 820-40 of the NEC, which provides guidelines for proper grounding and, in particular, specifies that the cable ground shall be connected to the grounding system of the building, as close to the point of cable entry as practical. For additional antenna grounding information, see items 25 and 26 on page 4.

Location of the required Marking

The rating sheet and the safety caution are on the rear of the unit.

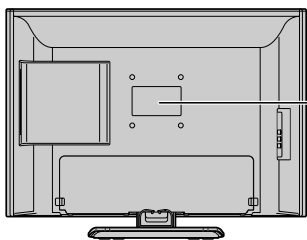

CERTIFICATION: COMPLIES WITH FDA RADIATION PERFORMANCE STANDARDS, 21 CFR SUBCHAPTER J.

FCC Declaration of Conformity Compliance Statement (Part 15):

The **Toshiba 23HLV85 LCD Color Televisions** comply with Part 15 of the FCC rules.

Operation is subject to the following two conditions: (1) this device may not cause harmful interference, and (2) this device must accept any interference that may cause undesired operation.

The party responsible for compliance to these rules is: Toshiba America Consumer Products, L.L.C.
82 Totowa Rd. Wayne, NJ 07470.
Ph: (973) 628-8000

Note: This equipment has been tested and found to comply with the limits for a Class B digital device, pursuant to Part 15 of the FCC rules. These limits are designed to provide reasonable protection against harmful interference in a residential installation. This equipment generates, uses, and can radiate radio frequency energy and, if not installed and used in accordance with the instructions, may cause harmful interference to radio communications. However, there is no guarantee that interference will not occur in a particular installation. If this equipment does cause harmful interference to radio or television reception, which can be determined by removing and applying power to the equipment, the user is encouraged to try to correct the interference by one or more of the following measures:

- Reorient or relocate the receiving antenna.
- Increase the separation between the equipment and the receiver.
- Connect the equipment into an outlet on a circuit different from that to which the receiver is connected.
- Consult the dealer or an experienced radio/TV technician for help.

CAUTION: Changes or modifications to this equipment not expressly approved by Toshiba could void the user's authority to operate this equipment.

CAUTION:

THIS DIGITAL VIDEO PLAYER EMPLOYS A LASER SYSTEM. TO ENSURE PROPER USE OF THIS PRODUCT, PLEASE READ THIS OWNER'S MANUAL CAREFULLY AND RETAIN FOR FUTURE REFERENCE. SHOULD THE UNIT REQUIRE MAINTENANCE, CONTACT AN AUTHORIZED SERVICE LOCATION.

USE OF CONTROLS, ADJUSTMENTS OR THE PERFORMANCE OF PROCEDURES OTHER THAN THOSE SPECIFIED HEREIN MAY RESULT IN HAZARDOUS RADIATION EXPOSURE.

TO PREVENT DIRECT EXPOSURE TO LASER BEAM, DO NOT TRY TO OPEN THE ENCLOSURE. VISIBLE LASER RADIATION MAY BE PRESENT WHEN THE ENCLOSURE IS OPENED. DO NOT STARE INTO BEAM.

Child Safety

It Makes A Difference Where Your TV Stands



Congratulations on your purchase! As you enjoy your new TV, keep these safety tips in mind:

The Issue

- If you are like most consumers, you have a TV in your home. Many homes, in fact, have more than one TV.
- The home theater entertainment experience is a growing trend, and larger TVs are popular purchases; however, they are not always supported on the proper TV stands.
- Sometimes TVs are improperly secured or inappropriately situated on dressers, bookcases, shelves, desks, audio speakers, chests, or carts. As a result, TVs may fall over, causing unnecessary injury.

Toshiba Cares!

- The consumer electronics industry is committed to making home entertainment enjoyable and safe.
- The Consumer Electronics Association formed the Home Entertainment Support Safety Committee, comprised of TV and consumer electronics furniture manufacturers, to advocate children's safety and educate consumers and their families about television safety.

Tune Into Safety

- One size does NOT fit all! Use appropriate furniture large enough to support the weight of your TV (and other electronic components).
- Use appropriate angle braces, straps, and anchors to secure your furniture to the wall (but never screw anything directly into the TV).
- Carefully read and understand the other enclosed instructions for proper use of this product.
- Do not allow children to climb on or play with furniture and TVs.
- Avoid placing any item on top of your TV (such as a VCR, remote control, or toy) that a curious child may reach for.
- Remember that children can become excited while watching a program and can potentially push or pull a TV over.
- Share our safety message about this hidden hazard of the home with your family and friends. Thank you!



2500 Wilson Blvd.
Arlington, VA 22201 U.S.A.
Tel. 703-907-7600 Fax 703-907-7690
www.CE.org

CEA is the Sponsor, Producer and Manager of the International CES®

Important Safety Instructions

- 1) **Read these instructions.**
- 2) **Keep these instructions.**
- 3) **Heed all warnings.**
- 4) **Follow all instructions.**



- 5) **Do not use this apparatus near water.**
- 6) **Clean only with dry cloth.**
- 7) **Do not block any ventilation openings.** Install in accordance with the manufacturer's instructions.

- 8) **Do not install near any heat sources** such as radiators, heat registers, stoves, or other apparatus (including amplifiers) that produce heat.

- 9) **Do not defeat the safety purpose of the polarized or grounding type plug.** A polarized plug has two blades with one wider than the other. A grounding type plug has two blades and a third grounding prong. The wide blade or the third prong are provided for your safety. If the provided plug does not fit into your outlet, consult an electrician for replacement of the obsolete outlet.

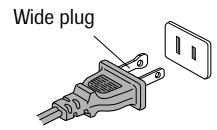

- 10) **Protect the power cord** from being walked on or pinched, particularly at plugs, convenience receptacles, and the point where they exit from the apparatus.

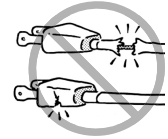

- 11) **Only use attachments/accessories specified by the manufacturer.**

- 12) **Use only with the cart, stand, tripod, bracket, or table specified by the manufacturer, or sold with the apparatus.** When a cart is used, use caution when moving the cart/apparatus combination to avoid injury from tip-over.



- 13) **Unplug this apparatus during lightning storms or when unused for long periods of time.**

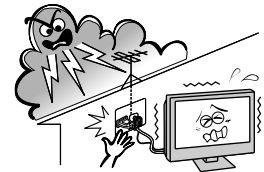

- 14) **Refer all servicing to qualified service personnel.** Servicing is required when the apparatus has been damaged in any way, such as power-supply cord or plug is damaged, liquid has been spilled or objects have fallen into the apparatus, the apparatus has been exposed to rain or moisture, does not operate normally, or has been dropped.

- 14a) **CAUTION:** If the TV is dropped and the cabinet or enclosure surface has been damaged or the TV does not operate normally, take the following precautions:

- ALWAYS turn off the TV and unplug the power cord to avoid possible electric shock or fire.
- NEVER allow your body to come in contact with any broken glass or liquid from the damaged television. The LCD panel inside the TV contains glass and a toxic liquid. If the liquid comes in contact with your mouth or eyes, or your skin is cut by broken glass, rinse the affected area thoroughly with water and consult your doctor.
- ALWAYS contact a service technician to inspect the TV any time it has been damaged or dropped.



- 15) The apparatus shall not be exposed to dripping or splashing and that no objects filled with liquids, such as vases, shall be placed on the apparatus.
- 16) **CAUTION:** To reduce the risk of electric shock, do not use the polarized plug with an extension cord, receptacle, or other outlet unless the blades can be inserted completely to prevent blade exposure.

Installation, Care, and Service

Installation

Follow these recommendations and precautions and heed all warnings when installing your TV:

- 17) Never modify this equipment. Changes or modifications may void: a) the warranty, and b) the user's authority to operate this equipment under the rules of the Federal Communications Commission.

- 18)  **DANGER: RISK OF SERIOUS PERSONAL INJURY, DEATH, OR EQUIPMENT DAMAGE!** Never place the TV on an unstable cart, stand, or table. The TV may fall, causing serious personal injury, death, or serious damage to the TV. 

- 19) Never place or store the TV in direct sunlight; hot, humid areas; or areas subject to excessive dust or vibration.

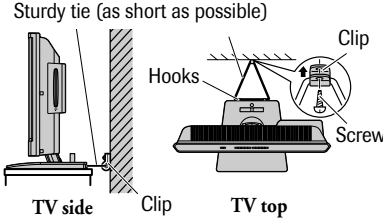
- 20) Always place the TV on the floor or a sturdy, level, stable surface that can support the weight of the unit. To secure the TV, use a sturdy tie from the hooks on the rear of the TV pedestal to a wall, pillar, or other immovable structure. Make sure the tie is tight, secure, and parallel to the floor.
- 

- 21) Never expose the apparatus to dripping or splashing liquid or place items such as vases, aquariums, any other item filled with liquid, or candles on top of the TV.

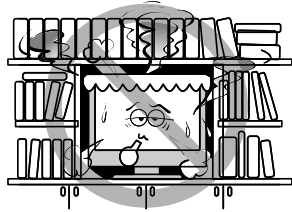
- 22) Never block or cover the slots or openings in the TV cabinet back, bottom, and sides. Never place the TV:
- on a bed, sofa, rug, or similar surface;
 - too close to drapes, curtains, or walls; or
 - in a confined space such as a bookcase, built-in cabinet, or any other place with poor ventilation.
- 

The slots and openings are provided to protect the TV from overheating and to help maintain reliable operation of the TV.

- 23) Never allow anything to rest on or roll over the power cord, and never place the TV where the power cord is subject to wear or abuse (5 inches for the DVD slot side).

- 24) Never overload wall outlets and extension cords.

- 25) Always operate the TV with a 100-240 V AC, 60Hz power source only.

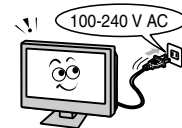

- 26) Always make sure the antenna system is properly grounded to provide adequate protection against voltage surges and built-up static charges (see Section 810 of the National Electric Code).

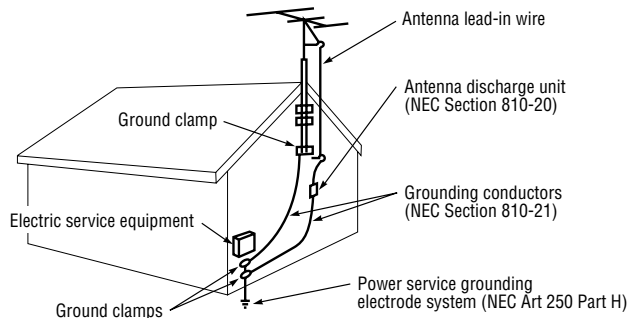

- 27)  **DANGER: RISK OF SERIOUS PERSONAL INJURY OR DEATH!**
- Use extreme care to make sure you are never in a position where your body (or any item you are in contact with, such as a ladder or screwdriver) can accidentally touch overhead power lines. Never locate the antenna near overhead power lines or other electrical circuits.

- Never attempt to install any of the following during lightning activity:
 - a) an antenna system; or
 - b) cables, wires, or any home theater component connected to an antenna or phone system.



Care

For better performance and safer operation of your TOSHIBA TV, follow these recommendations and precautions:

- 28) If you use the TV in a room whose temperature is 32 °F (0 °C) or below, the picture brightness may vary until the LCD warms up. This is not a sign of malfunction.

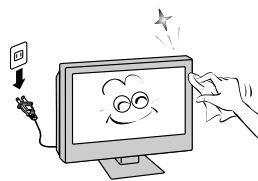
- 29) Always unplug the TV before cleaning. Wipe the display panel surface gently using only a soft cloth (cotton, flannel, etc.). A hard cloth may damage the surface of the panel. Avoid contact with alcohol, thinner, benzene, acidic or alkaline solvent cleaners, abrasive cleaners, or chemical cloths, which may damage the surface. Do not spray volatile compounds such as insecticide on the cabinet. This may cause a discoloration or damage the cabinet.
- 

- 30)  **WARNING: RISK OF ELECTRIC SHOCK!** Never spill liquids or push objects of any kind into the TV cabinet slots.

31) While it is thundering, do not touch the connecting cables or apparatus. Failure to follow this instruction may result in electric shock.

32) For added protection of your TV from lightning and power surges, always unplug the power cord and disconnect the antenna from the TV if you leave the TV unattended or unused for long periods of time.

33) During normal use, the TV may make occasional snapping or popping sounds. This is normal, especially when the unit is being turned on or off. If these sounds become frequent or continuous, unplug the power cord and contact a Toshiba Authorized Service Center.

34)  **WARNING: RISK OF SERIOUS PERSONAL INJURY OR EQUIPMENT DAMAGE!**



Never strike the screen with a sharp or heavy object.

35) • The LCD screen of this product can be damaged by Ultraviolet Radiation from the sun. When selecting a location for the television, avoid locations where the screen may be exposed to direct sunlight, such as in front of a window.

• Never touch, press, or place anything on the LCD screen. These actions will damage the LCD screen. If you need to clean the LCD screen, follow the instructions in item 29 on page 4.

Service

36)  **WARNING: RISK OF ELECTRIC SHOCK!** Never attempt to service the TV yourself. Opening and removing the covers may expose you to dangerous voltage or other hazards. Refer all servicing to a Toshiba Authorized Service Center.

37) If you have the TV serviced:

- Ask the service technician to use only replacement parts specified by the manufacturer.
- Upon completion of service, ask the service technician to perform routine safety checks to determine that the TV is in safe operating condition.

38) The cold cathode fluorescent lamp in the LCD panel contains a small amount of mercury. When the TV reaches the end of its useful life, dispose of the used TV by the approved method for your area, or ask a qualified service technician to properly dispose of the TV.

 **Note:** The lamp unit contains mercury, the disposal of which may be regulated due to environmental considerations. For disposal or recycling information, contact your local authorities or the Electronics Industries Alliance (www.eiae.org).

Important notes about your LCD TV

The following symptoms are technical limitations of LCD Display technology and are not an indication of malfunction. Therefore, TACP/TCL is not responsible for perceived defects resulting from these symptoms.

- 1) An afterimage (ghost) may appear on the screen if a fixed, non-moving image is displayed for a long period of time. The afterimage is not permanent and will disappear in a short period of time.
- 2) The LCD panel contained in this TV is manufactured using an extremely high level of precision technology; however, there may be an occasional pixel (dot of light) that does not operate properly (that does not light, that remains constantly lit, etc.). This is a structural property of LCD technology, is not a sign of malfunction, and is not covered under your warranty. Such pixels are not visible when the picture is viewed from a normal viewing distance.

Note: Interactive video games that involve shooting a “gun” type of joystick at an on-screen target may not work on this TV.

Precautions

Notes on moisture condensation

Moisture condensation damages the DVD player section. Please read the following carefully.

Moisture condensation occurs, for example, when you pour a cold drink into a glass on a warm day. Drops of water form on the outside of the glass. In the same way, moisture may condense on the optical pick-up lens inside DVD player, one of the most crucial internal parts of the DVD player.

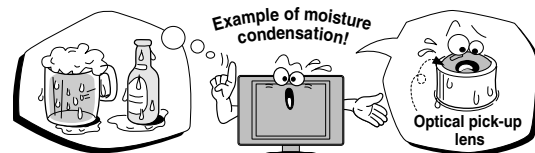

Moisture condensation occurs during the following cases.

- When you bring the TV directly from a cold place to a warm place.
- When you use the TV in a room where you just turned on the heater, or a place where the cold wind from the air conditioner directly hits the TV.
- In summer, when you use the TV in a hot and humid place just after you move the TV from an air conditioned room.
- When you use the TV in a humid place.

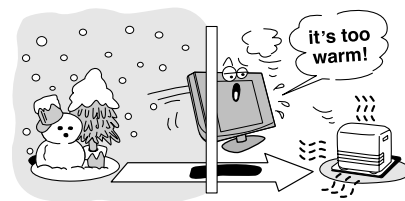

Do not use the TV when moisture condensation may occur.

If you use the TV in such a situation, it may damage discs and internal parts. Remove the disc, connect the power cord of the TV to the wall outlet, turn on the TV, and leave it for two or three hours. After two or three hours, the TV will have warmed up and evaporated any moisture. Keep the TV connected to the wall outlet and moisture condensation will seldom occur.

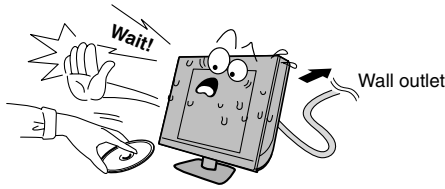

Notes on discs (DVD player section)

On handling discs

- Do not touch the playback side of the disc. For example, handle the disc so that it is shown in figure below.

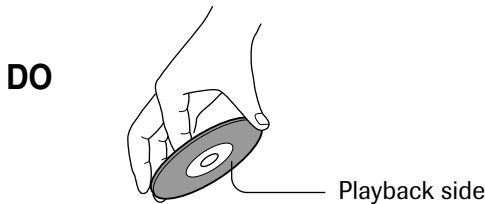

- Do not attach paper or tape to discs.



On cleaning discs

- Fingerprints and dust on the disc cause picture and sound deterioration. Wipe the disc from the center outwards with a soft cloth. Always keep the disc clean.

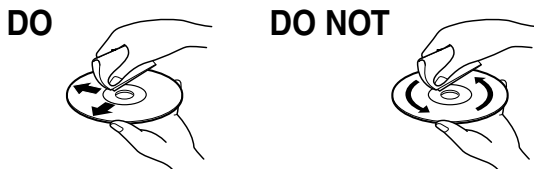

- Do not use any type of solvent such as thinner, benzene, commercially available cleaners or antistatic spray for vinyl LPs. It may damage the disc.

On storing discs

- Do not store discs in a place subject to direct sunlight or near heat sources.
- Do not store discs in places subject to moisture and dust such as a bathroom or near a humidifier.
- Store discs vertically in a case. Stacking or placing objects on discs outside of their case may cause warping.

On other notes

DISC SLOT

- Keep your fingers well clear of the disc slot as it is closing. It may cause serious personal injury.

VIBRATION

- Vibration or shock may disrupt DVD playback or cause scratches on the disc. Do not move or tilt or otherwise jolt the set when a disc is loaded. The playback sound may skip if the TV is dropped from a height of 4 cm (1.5 in) or more or if the set is installed at a greater angle than recommended.

LASER BEAM

- Do not look into the opening of the disc slot or ventilation opening of the product to see the source of the laser beam. It may cause sight damage.

DISC

- Do not use a cracked, deformed, or repaired disc. These discs are easily broken and may cause serious personal injury and product malfunction.

Structure of disc contents

Normally, DVD video discs are divided into titles, and the titles are sub-divided into chapters. Video CDs and Audio CDs are divided into tracks.

DVD video disc

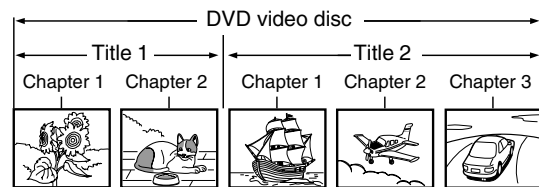

Video CD/Audio CD

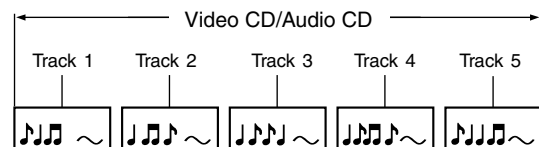

Each title, chapter or track is assigned a number, which is called "title number", "chapter number" or "track number" respectively.

There may be discs that do not have these numbers.

Notes on copyright

The unauthorized recording, use, distribution, or revision of television programs, videotapes, DVDs, and other materials is prohibited under the Copyright Laws of the United States and other countries, and may subject you to civil and criminal liability.

This product incorporates copyright protection technology that is protected by U.S. patents and other intellectual property rights. Use of this copyright protection technology must be authorized by Macrovision, and is intended for home and other limited viewing uses only unless otherwise authorized by Macrovision. Reverse engineering or disassembly is prohibited.



About this owner's manual

This owner's manual explains the basic instructions of DVD player. Some DVD video discs are produced in a manner that allows specific or limited operation during playback. As such, the DVD player may not respond to all operating commands. This is not a defect in the DVD player. Refer to instruction notes of discs.

"Ø" may appear on the TV screen during operation. A "Ø" means that the operation is not permitted by the DVD player or the disc.

For example, sometimes it is unable to stop the playback of copyright message of the disc when the STOP (■) button is pressed. Alternatively, the "Ø" may also indicate that the feature is not available for the disc.

Notes on region numbers

The region number of this DVD player of the TV is 1. If region numbers, which stand for their playable area, are printed on your DVD video disc and you do not find  or , disc playback will not be allowed by the player. (In this case, the TV will display a message on-screen.)

Some DVDs that have no region code label may still be subject to area restrictions and therefore not playable.

On Video CDs

The DVD player of the TV supports Video CDs equipped with the PBC (Version 2.0) function. (PBC is the abbreviation of Playback Control.) You can enjoy two playback variations depending on types of discs.

• Video CD not equipped with PBC function (Version 1.1)

Sound and movie can be played on this DVD player of the TV in the same way as an audio CD.

• Video CD equipped with PBC function (Version 2.0)

In addition to operation of a Video CD not equipped with the PBC function, you can enjoy playback of interactive software with search function by using the menu displayed on the TV screen (Menu Playback).

Some of the functions described in this owner's manual may not work with some discs.

Manufactured under license from Dolby Laboratories.

"Dolby" and the double-D symbol are trademarks of Dolby Laboratories.

Playable discs

This DVD player can play the following discs.

	Disc Mark	Contents	Disc Size	Maximum playback time
DVD video discs		Audio + Video (moving pictures)	12 cm	Approx. 4 hours (single sided disc)
				Approx. 8 hours (double sided disc)
			8 cm	Approx. 80 minutes (single sided disc)
				Approx. 160 minutes (double sided disc)
Video CDs		Audio + Video (moving pictures)	12 cm	Approx. 74 minutes
			8 cm	Approx. 20 minutes
Audio CDs		Audio	12 cm	Approx. 74 minutes
			8 cm (CD single)	Approx. 20 minutes

The following discs are also available.

- DVD-R/RW discs of DVD video format
 - CD-R/CD-RW discs of CD-DA, Video CD, MP3, WMA or JPEG format
 - Kodak Picture CD and FUJICOLOR CD format
- Some of these discs may be incompatible.

- When you play an 8 cm disc, you need the adapter (not supplied).
- You cannot play discs other than those listed above. You cannot play discs of DVD-RAM, DVD-ROM, Photo CD, etc., or non standardized discs even if they may be labeled as above.
- Some CD-R/RWs cannot be played back depending on the recording conditions.
- This TV uses the NTSC color system, and cannot play DVD video discs recorded in any other color system (PAL, SECAM, etc.).

Because of problems and errors that can occur during the creation of DVD and CD software and/or the manufacture of DVD and CD discs, Toshiba cannot guarantee that the DVD player contained in this TV/DVD will play every feature of every DVD bearing the DVD logo and/or every CD bearing the CD logo. As one of the creators of DVD technology, Toshiba DVD players are manufactured using the highest standards of quality, and as a result, such incompatibilities are rare. If you happen to experience any difficulty playing a DVD or a CD on the DVD player contained in this TV/DVD, please feel free to contact us via the methods listed in the "How to Obtain Warranty Service" sections on page 48-49 (as applicable).

Introduction.....	9	Using the V-Chip menu	27
Welcome to Toshiba	9	V-Chip rating and categories	27
Supplied accessories	9	V-Chip blocking (Parental control) setup	28
Connecting the power cord	9	Adjusting the picture	29
Exploring your new TV	10	Selecting the picture mode	29
Rear terminal cover	11	Adjusting the picture quality	29
Cable clamper	11	Using the closed caption feature	30
Adjusting the TV viewing angle	11	To turn on or off the Closed Caption feature	31
Connecting your TV	12	Using the Panel lock feature	31
Connecting an antenna or cable TV	12	Setting the sleep timer	31
Connecting a VCR	13	Adjusting the sound	32
Connecting a cable converter box	13	Muting the sound	32
Connecting a cable converter box and a VCR	13	Selecting stereo/SAP broadcasts	32
Connecting a DVD player with ColorStream®		Using the WOW surround sound feature	33
(component video) and a VCR	14	Selecting the sound mode	33
Connecting a DTV receiver/set-top box with		Adjusting the sound quality	34
ColorStream® (component video) and a VCR	15	Using the StableSound® feature	34
Connecting an HDMI™ or a DVI device to the		Using the PC setting feature	35
HDMI input	16	Using the Game Mode feature	36
Connecting an audio system	17	Using the Auto off feature	36
Connecting a digital audio system	17	Displaying on-screen information	36
Connecting a camcorder	17	Understanding the last mode memory feature	36
Connecting a personal computer (PC)	18	DVD Playback	37
Using the remote control	19	Learning about the remote control	37
Learning about the remote control	19	DVD & VCD Operation	38
Installing the remote control batteries	20	DVD Menu options	40
Remote control effective range	20	MP3/WMA files Playback options	42
Setting up your TV	21	Audio CD Playback options	43
Learning about the menu system	21	JPEG file viewing options	43
Changing the on-screen display language	22	Appendix	45
Adding channels to the TV's memory	22	Specifications	45
Programming channels automatically	22	Troubleshooting	46
Adding and erasing channels manually	23	Limited United States Warranty	48
Changing channels	23	Limited Canada Warranty	49
Programming your favorite channels	23	Index	50
Using the TV's features.....	24		
Switching between two channels using Channel			
Return	24		
Using the Blue screen feature	24		
Selecting the video input source	24		
Viewing the wide-screen picture formats	25		
Selecting the picture size	25		
Natural picture size	25		
TheaterWide 1 picture size	26		
TheaterWide 2 picture size	26		
TheaterWide 3 picture size	26		
Full picture size	26		

Introduction

Welcome to Toshiba

Thank you for purchasing this Toshiba LCD TV/DVD combination. The goal of this manual is to guide you through setting up and operating your Toshiba TV as quickly as possible.

The model and serial numbers are on the back of your TV. Write these numbers in the space provided on the front cover of this manual for your records.

Instructions in this manual are based on using the remote control. You also can use the controls on the TV if they have the same name as those referred to on the remote control.

Please read all the safety and operating instructions carefully, and keep this manual for future reference.

Supplied accessories

Check that you have the accessories and items shown.

Owner's Manual
(This book)

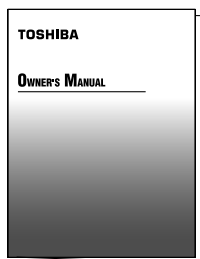

Remote control
Batteries R03 (AAA) × 2

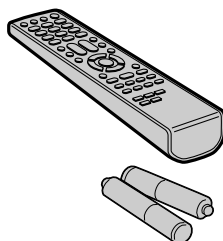

Power cord



Clip



Use this clip to attach the TV to a wall, pillar, or other immovable structure. See item 20 on page 4.

Connecting the power cord

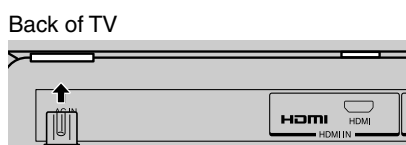

NOTE: RISK OF EQUIPMENT DAMAGE!

Never plug in any power cords until you have finished connecting all equipment (see page 12).

Wall outlet
100-240 V AC 60Hz



Power cord (supplied)

* The power cord supplied with this product is to be used in the United States and Canada only.

Exploring your new TV

You can operate your TV by using the buttons on the top panel or the remote control. The A/V terminals for connecting other equipment to your TV are on the back panel and side panel (see illustrations below). Also see "Connecting your TV" on pages 12-18.

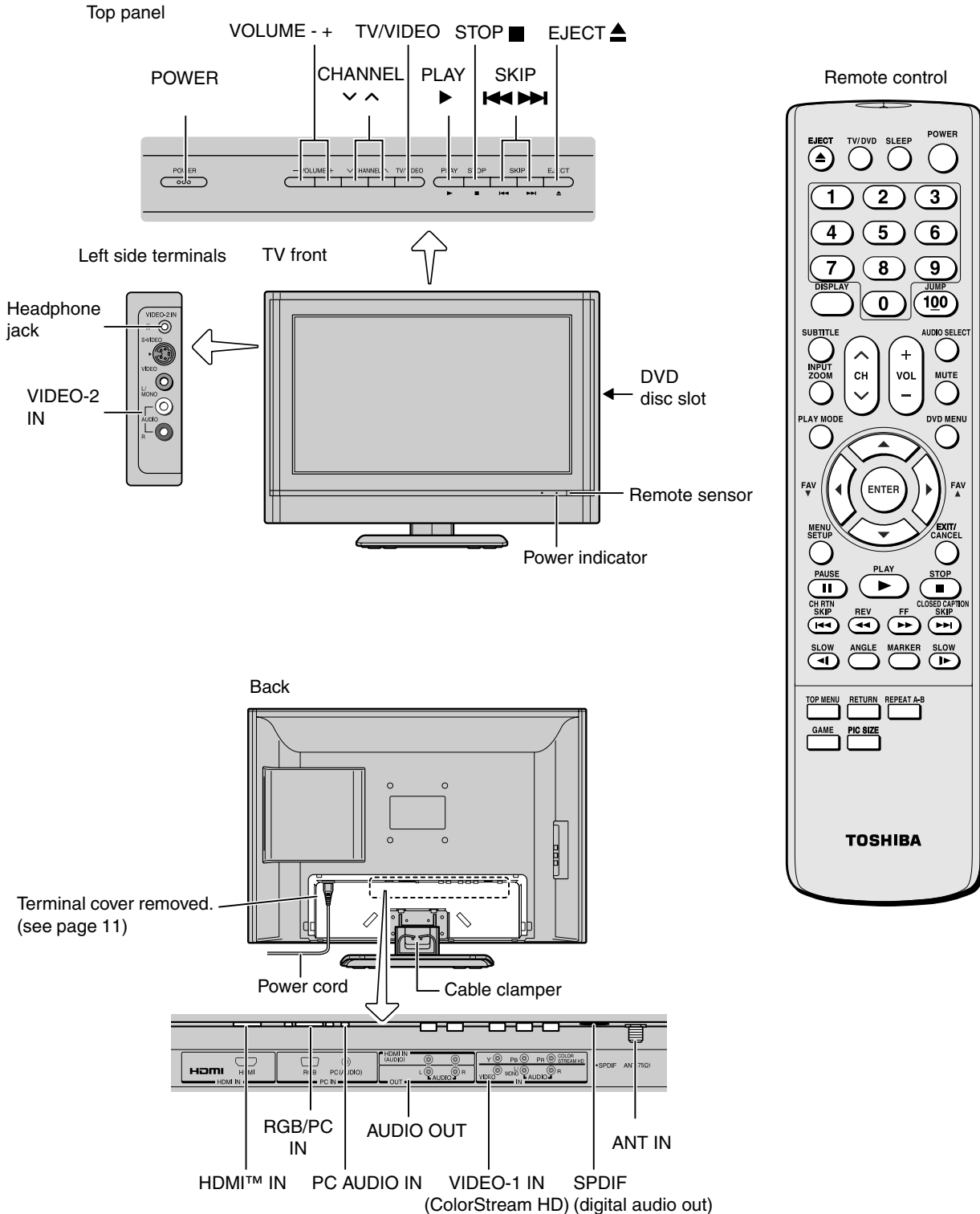

Rear terminal cover

The connection panel is hidden behind the terminal cover.

1. Remove the cover. Release the two hooks on the both sides of the cover.
2. Install cables as necessary.
3. Reinstall the cover. Align the holes on the TV back with the three tabs on the rear terminal cover as shown.
4. Close the cover.

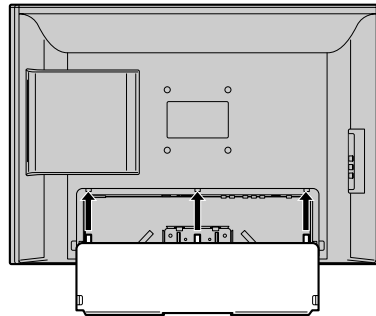
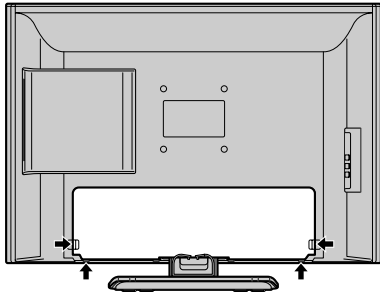

Cable clammer

The cable clammer can be used to bundle the connection cables (see page 12).

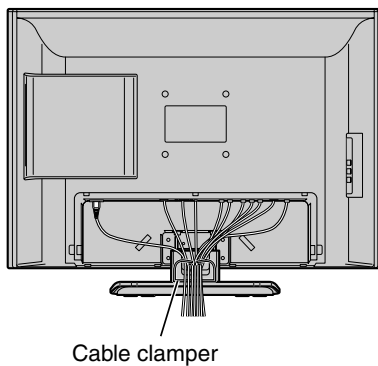

Cable clammer



WARNING: RISK OF SERIOUS PERSONAL INJURY OR EQUIPMENT DAMAGE!

Never grasp the cable clammer when moving or lifting the TV. The cable clammer could break, causing the TV to fall.

Adjusting the TV viewing angle

You can adjust the angle of the TV screen.

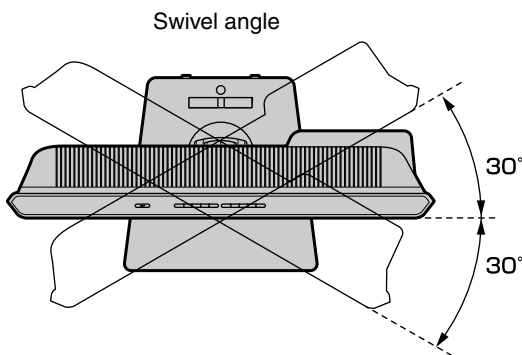

Swivel angle

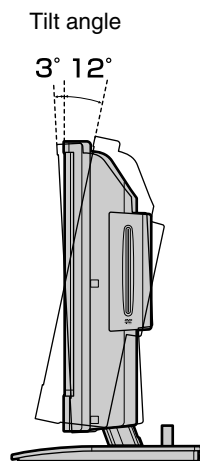

Tilt angle

3° 12°

Connecting your TV

Note: All required cables, if not provided with your other devices, can be purchased at many electronics accessory suppliers.

- **Coaxial (F-type) cable** is used for connecting your antenna, cable TV service, and/or cable converter box to the ANI 75 Ω RF input on your TV.
- **Standard A/V cables (composite video)** usually come in sets of three, and are for use with video devices with standard audio and standard (composite) video output. These cables (and the related inputs on your TV) are typically color-coded according to use: yellow for video, red for stereo right audio, and white for stereo left (or mono) audio.
- **S-video cable** is for use with video devices with S-video output. Separate audio cables are required for a complete connection.

Note: An S-video cable provides better picture performance than a standard (composite) video cable.

- **Component video cables** come in sets of three and are for use with video devices with component video output. These cables are typically color-coded red, green, and blue. (ColorStream® is Toshiba's brand of component video.) Separate audio cables are required for a complete connection.

Note: Component video cables provide better picture performance than a standard (composite) video or S-video cable.

- **HDMI cable** is for use with devices with uncompressed HDMI (high-definition multimedia interface) video and compressed audio output. HDMI cable delivers digital audio and video in its native format (see page 16). This cable carries both video and audio information; therefore, separate audio cables are not required for a complete connection.

Note: HDMI cable provides better picture performance than a standard (composite) video or S-video cable.

- **Mini D-sub 15-pin cable** is for use with a personal computer with an analog RGB (15-pin) output. A separate audio cable is required for a complete connection.
- **Optical audio cable** is for connecting receivers with PCM (pulse-code modulation) optical audio input to the TV's SPDIF (digital audio out) terminal. See page 17.

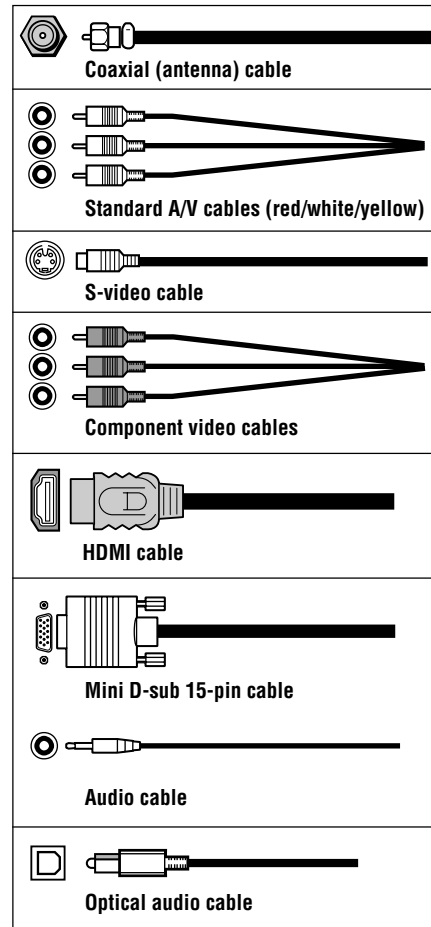

NOTE: RISK OF EQUIPMENT DAMAGE!

Never plug in any power cords until you have finished connecting all equipment.

Connecting an antenna or cable TV

This connection allows you to watch TV programs or basic cable channels.

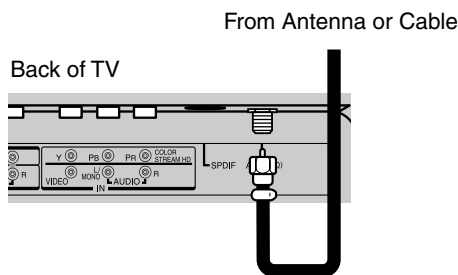

Connecting a VCR

This connection allows you to watch local channels and video programs, play or record on the VCR while watching TV, and record from one channel while watching another channel.

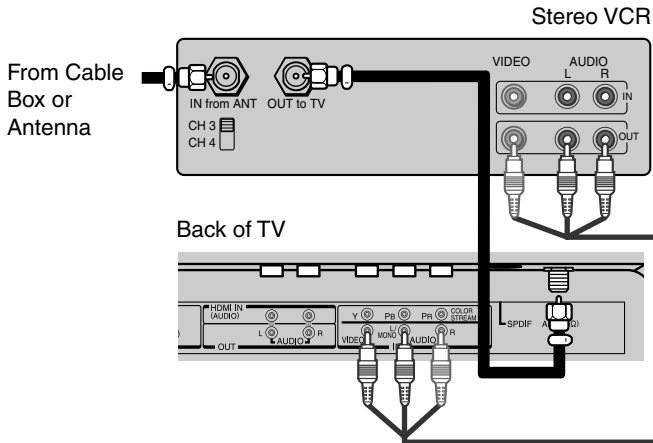

Note:

If you have a mono VCR, connect L to VCR Audio OUT using only one audio cable.

If you have a VCR with S-video, use an S-video cable (in the S-video jacks) instead of a standard video cable.

The TV side panel can be used to connect a VCR with S-video.

Connecting a cable converter box

This connection allows you to watch basic and premium cable channels. Tune the TV to channel 3 or 4 (whichever channel is vacant in your area), and use the converter box to change channels.

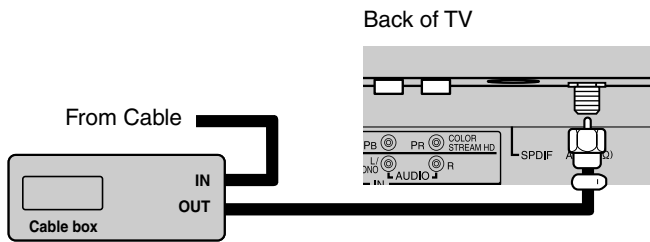

Note:

When you use a converter box with your TV, the remote control will not operate some features, such as favorite channel programming or channel return.

Connecting a cable converter box and a VCR

This connection allows you to watch and record basic and premium cable channels, as well as watch videotapes. Set the TV signal source to Video1 (page 24). Tune the VCR to channel 3 or 4 (the same channel as the converter box output switch), and use the cable converter box to change channels.

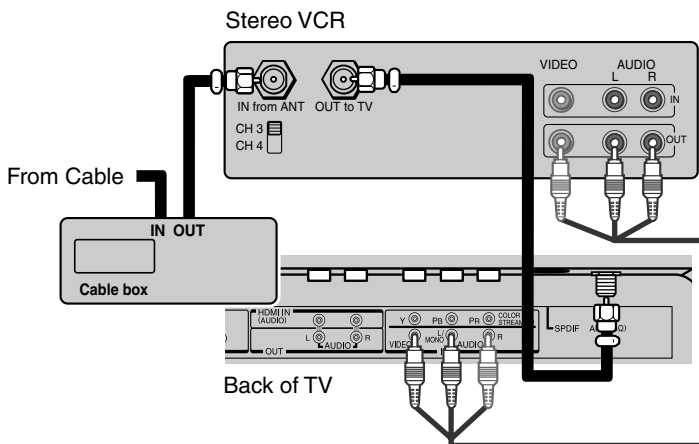

Note:

When you use a converter box with your TV, the remote control will not operate some features, such as favorite channel programming or channel return.

If you have a mono VCR, connect L to VCR Audio OUT using only one audio cable.

If you have a VCR with S-video, use an S-video cable (in the S-video jacks) instead of a standard video cable.

The TV side panel can be used to connect a VCR with S-video.

The unauthorized recording, use, distribution, or revision of television programs, videotapes, DVDs, and other materials is prohibited under the Copyright Laws of the United States and other countries, and may subject you to civil and criminal liability.

Connecting a DVD player with ColorStream® (component video) and a VCR

This connection allows you to watch DVD, VCR, and TV programs, and record TV programs.

Your TV has ColorStream® (component video) inputs. Connecting your TV to a DVD player with component video can greatly enhance picture quality and realism.

- To record one TV program while watching another TV program, tune the VCR to the channel to record, and tune the TV to the channel to watch.
- To record a TV program while watching a DVD, tune the VCR to the channel to record, and select Video1 on the TV (see “Selecting the video input source” on page 24).

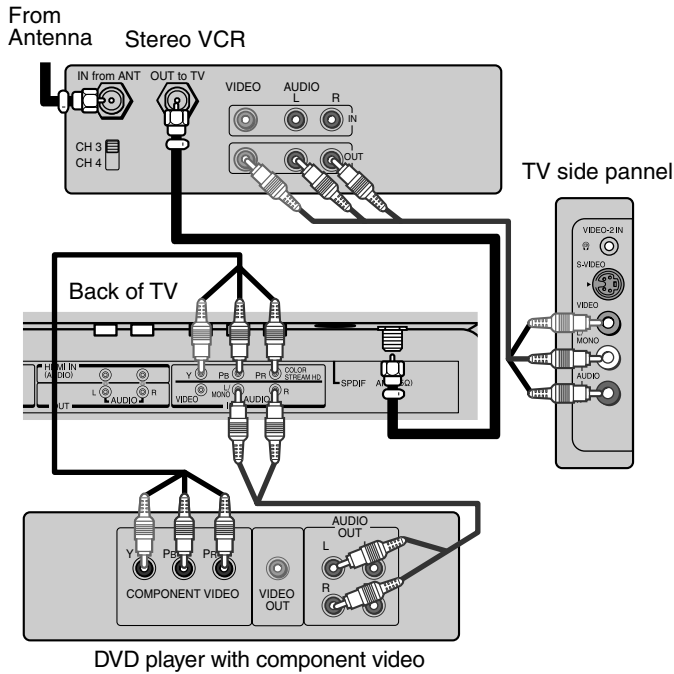

Note:

For the highest possible picture quality, use component video cables between the TV and DVD player.

The ColorStream jacks can be used with 480i and 480p scan system.

The TV side panel can be used to connect a VCR with S-video.

The unauthorized recording, use, distribution, or revision of television programs, videotapes, DVDs, and other materials is prohibited under the Copyright Laws of the United States and other countries, and may subject you to civil and criminal liability.

Connecting a DTV receiver/set-top box with ColorStream® (component video) and a VCR

This connection allows you to watch DTV (digital TV), VCR, and TV programs, and record DTV (composite video only) and TV programs.

Your TV has ColorStream® (component video) inputs. Connecting your TV to a DTV receiver with component video can greatly enhance picture quality and realism.

- To record and watch a DTV program, select LINE IN on the VCR, and select Video1 on the TV (see "Selecting the video input source" on page 24).
- To record a TV program while watching a DTV program, tune the VCR to the channel to record, and select Video1 on the TV.
- To record and watch the same TV program, tune the VCR to the channel to record, and select Video2 on the TV.
- To record one TV program while watching another TV program, tune the VCR to the channel to record, and tune the TV to the channel to watch.

Note:

For the highest possible picture quality, use component video cables between the TV and DTV receiver/set-top box.

The TV side panel can be used to connect a VCR with S-video.

The unauthorized recording, use, distribution, or revision of television programs, videotapes, DVDs, and other materials is prohibited under the Copyright Laws of the United States and other countries, and may subject you to civil and criminal liability.

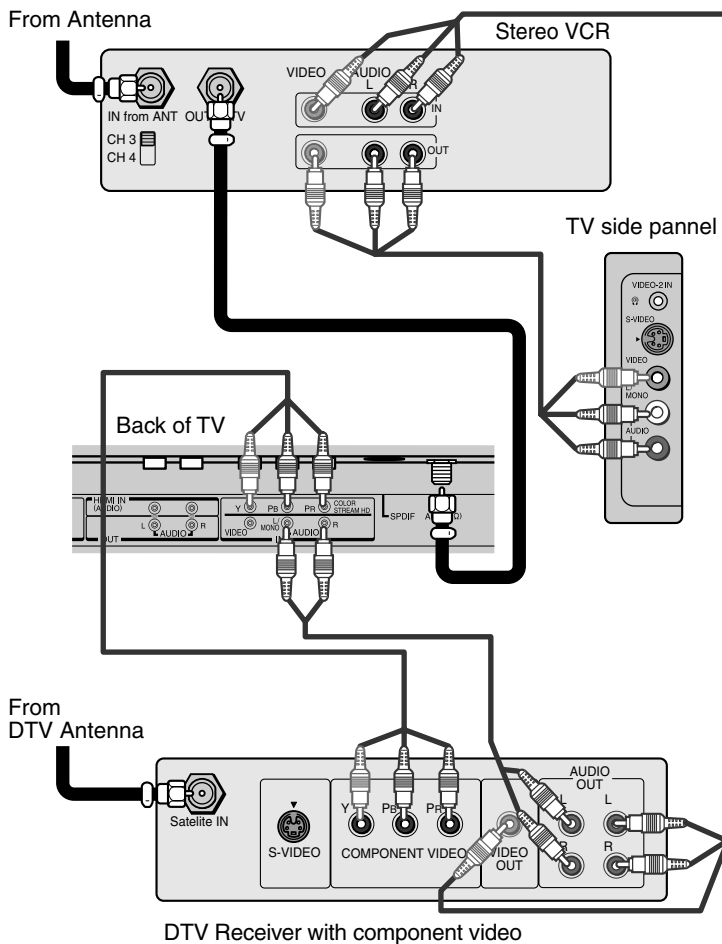

Connecting an HDMI™ or a DVI device to the HDMI input

The HDMI^[1] input on your TV receives digital audio and uncompressed digital video from an HDMI device or uncompressed digital video from a DVI^[2] device.

This input is designed to accept HDCP^[3] program material in digital form from EIA/CEA-861/861B-compliant^[4] consumer electronic devices (such as a set-top box or DVD player with HDMI or DVI output).

The HDMI input is designed for best performance with 1080i high-definition video signals, but will also accept and display 480i, 480p, and 720p signals.

Note: The HDMI jack is not intended for connection to and should not be used with a personal computer. For PC connection, see page 18.

To connect an HDMI device, you will need:

- one HDMI cable (type A connector)

For proper operation, it is recommended that you use a short HDMI cable.

HDMI cable transfers both video and audio. Separate analog audio cables are not required (see illustration below). Some CDVs (Video CDs) may not output digital audio signals, in which case you may be able to hear sound by connecting analog audio cables. However, if you connect analog audio cables with this connection, the HDMI terminal on the TV will not receive the HDMI digital audio signal and you will hear analog audio only.

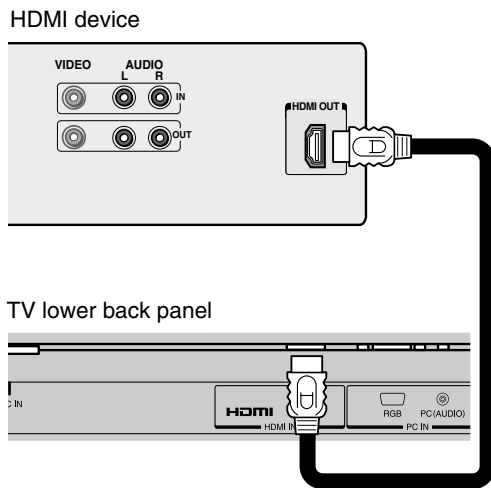

HDMI, the HDMI logo and High-Definition Multimedia Interface are trademarks or registered trademarks of HDMI Licensing LLC.

[1] HDMI = High-Definition Multimedia Interface.

[2] DVI = Digital Video Interface.

[3] HDCP = High-bandwidth Digital Content Protection.

[4] EIA/CEA-861/861B compliance covers the transmission of uncompressed digital video with high-bandwidth digital content protection, the technology of which is being standardized for reception of high-definition video signals. Because this is an evolving technology, it is possible that some devices may not operate properly with the TV.

To ensure that the HDMI or DVI device is reset properly, it is recommended that you follow these procedures:

- *When turning on your electronic components, **turn on the TV first**, and then the HDMI or DVI device.*
- *When turning off your electronic components, **turn off the HDMI or DVI device first**, and then the TV.*

To connect a DVI device, you will need:

- one HDMI-to-DVI adapter cable (HDMI type A connector)

For proper operation, the length of an HDMI-to-DVI adapter cable should not exceed 9.8 ft (3m). The recommended length is 6.6 ft (2m).

- one pair of standard analog audio cables

An HDMI-to-DVI adapter cable transfers only video. Separate analog audio cables are required (see illustration below).

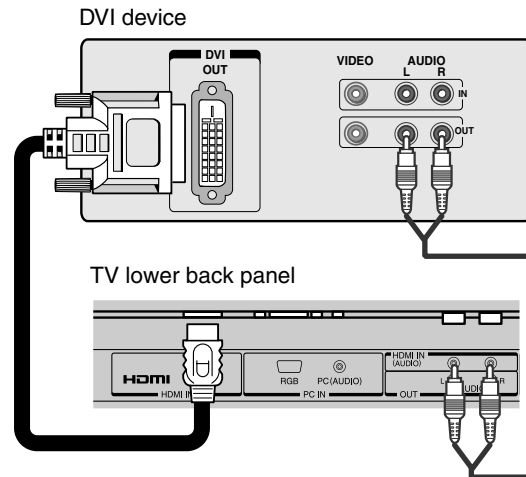

Connecting an audio system

This connection allows you to hear the TV sound through external speakers connected to an audio amplifier. The audio signal level (fixed) is not affected by pressing the volume buttons on the TV or the TV's remote control. To control the audio through the amplifier, use the audio system's remote control.

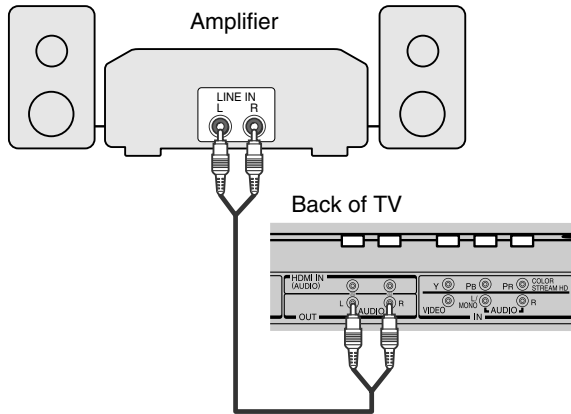

Connecting a digital audio system

During playback the DVD, the TV's SPDIF (digital audio out) terminal outputs a 2-channel down-mixed PCM (pulse-code modulation) signal for use with other external audio system with optical audio input.

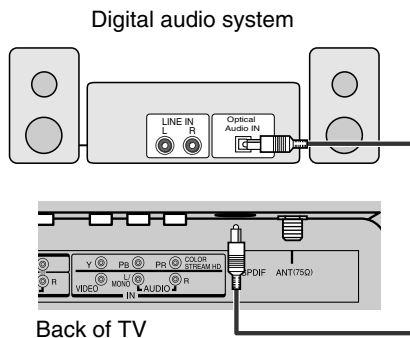

Connecting a camcorder

This connection allows you to watch video materials recorded on a camcorder.

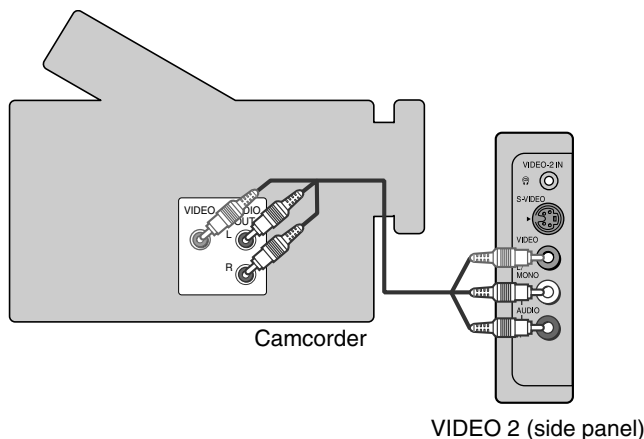

Note:

Set the TV's volume to the minimum level if necessary.

Note:

- Remove the cap from the SPDIF terminal before connecting an optical audio cable, otherwise leave the cap on for dust protection.
- The SPDIF terminal may not output some digital audio sources because of copy restrictions.

Note:

If you have a camcorder with S-video, use an S-video cable instead of a standard video cable for better picture performance.

Connecting a personal computer (PC)

This connection allows you to view the image of a personal computer (PC) on the TV screen. When connecting a PC to the TV, use an analog RGB (15-pin) computer cable and a PC audio cable.

– To use a PC, set the monitor output resolution on the PC before connecting it to the TV. The following signals can be displayed.

- XGA: VESA 1024 × 768 @ 60Hz

Other formats or non-standard signals may not be displayed correctly.

– To display the optimum picture, use the PC setting feature. (see “Using the PC setting feature” on page 35).

Note:

- Some PC models cannot be connected to this TV.
- An adapter is not needed for computers with a DOS/V compatible mini D-sub 15-pin terminal.
- Depending on the DVD's title and the specifications of the PC on which you are playing the DVD-Video, some scenes may be skipped or you may not be able to pause during multi-angle scenes.

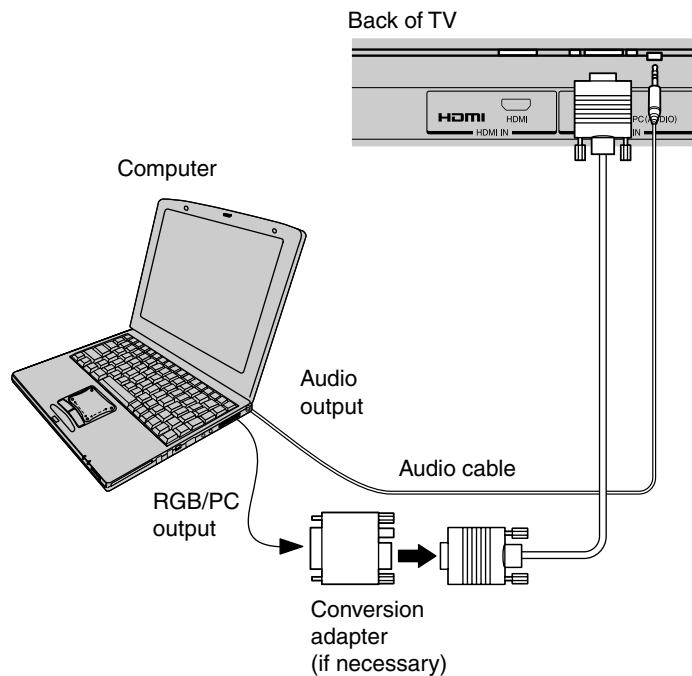

Using the remote control

Learning about the remote control

The buttons used for operating the TV only are described here.

POWER turns the TV on and off.

Press **POWER** to turn on the TV. Press **POWER** again to turn off the TV (standby mode*).

SLEEP sets the TV to turn off at a specific time (page 31)

TV/DVD switches to the DVD mode (page 37)

Channel Numbers (0-9, 100) allow direct access to channels (page 23)

DISPLAY displays TV settings on-screen (page 36)

AUDIO SELECT selects the MTS mode (page 32)

INPUT selects the video input source (page 24)

MUTE turns off the sound (page 32)

VOL (volume) + - adjusts the volume level

CH (channel) ^ v cycles through programmed channels (page 23)

ENTER activates the function settings in the menu or selects the next menu (page 21)

▲▼◀▶ (arrow buttons) select or adjust menu items (page 21)

FAV ▲▼ cycle through channels you programmed as favorite channels (page 23)

MENU/SETUP opens the menu system (page 21)

EXIT/CANCEL closes the menu system (page 21)

CH RTN switches between the last two viewed channels (page 24)

CLOSED CAPTION selects the Caption or Text mode (page 31)

GAME switches the Game Mode (page 36)

PIC SIZE cycles through the five picture sizes: Natural, TheaterWide 1/2/3, and Full (page 25)

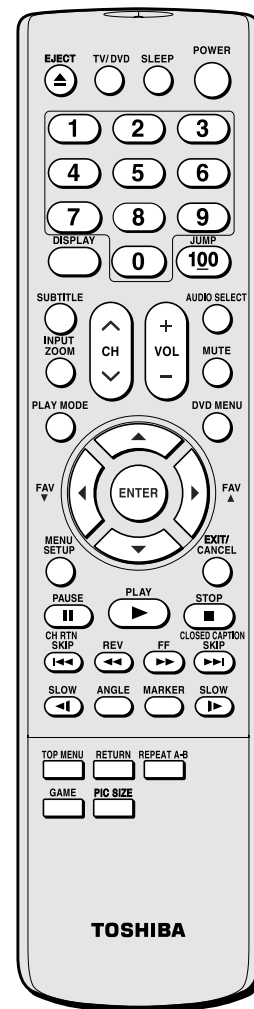

* The TV is in standby mode when the power is OFF but the power cord is still plugged into an outlet.

Note:

The error message "Not Available" will appear if you press a key for a function that is not available.

Installing the remote control batteries

To install the batteries:

1. Open the battery cover on the back of the remote control.
2. Install two batteries (R03 size “AAA”). Match the + and – signs on the batteries to the signs on the battery compartment.

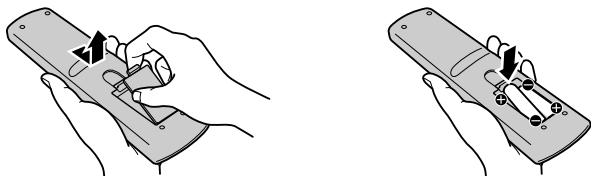

3. Replace the battery cover on the remote control until the lock snaps.

Remote control effective range

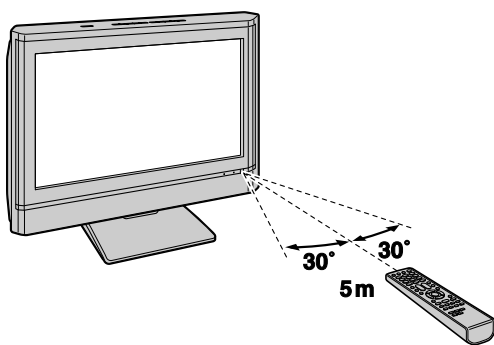

Caution:

Never throw batteries into a fire.

Note:

- Be sure to use AAA size batteries.
- Dispose of batteries in a designated disposal area.
- Batteries should always be disposed of with the environment in mind. Always dispose of batteries in accordance with applicable laws and regulations.
- If the remote control does not operate correctly, or if the operating range becomes reduced, replace batteries with new ones.
- When necessary to replace batteries in the remote control, always replace both batteries with new ones. Never mix battery types or use new and used batteries in combination.
- Always remove batteries from remote control if they are dead or if the remote control is not to be used for an extended period of time. This will prevent battery acid from leaking into the battery compartment.

Setting up your TV

Learning about the menu system

After you have installed the batteries, you will need to set some preferences on the TV by using the menu system. You can access the menu system using the buttons on the TV or remote control.

1. Press MENU to display the menu system.
2. Press ◀ or ▶ to select a menu.
3. Press ENTER, and then press ▲ or ▼ to select an item.
4. Press ENTER, and then press ▲ or ▼ to select or adjust a setting.
5. Press ENTER to save your menu settings.

To return to the previous menu, press EXIT/CANCEL.

To close the menu system, press MENU.

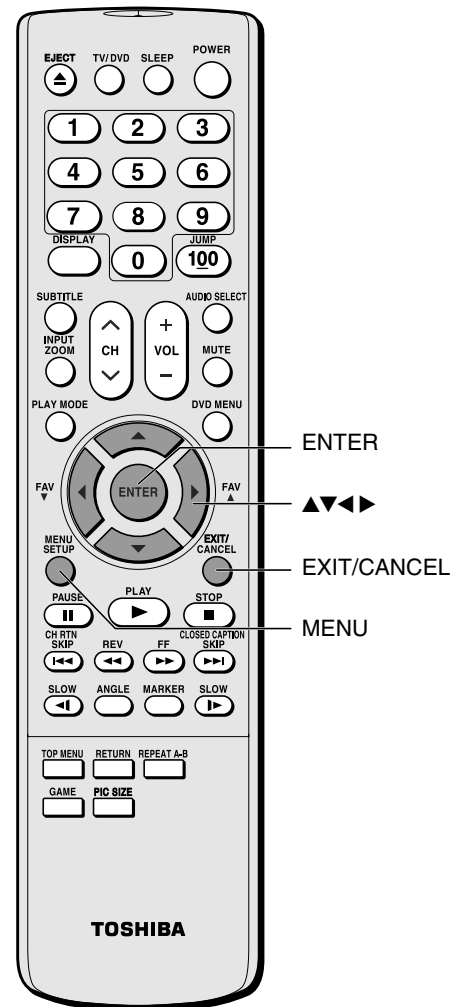
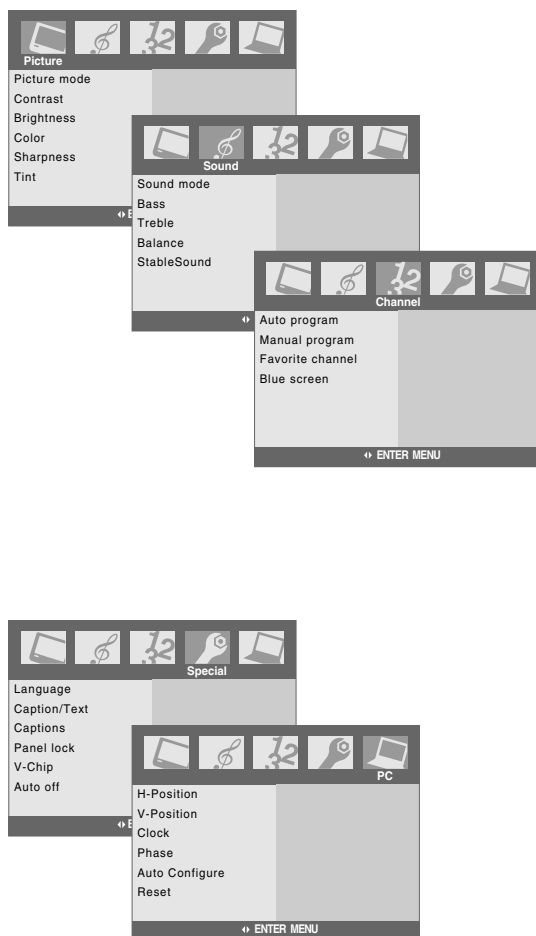

Note:

The PC mode is selectable only when the TV is in PC input mode and active picture is on-screen (see "Selecting the video input source" on page 24).

Changing the on-screen display language

You can choose from three different languages (English, Spanish and French) for the on-screen display of adjustment menus and messages.

To select a language:

1. Press MENU, and then press ◀ or ▶ until the Special menu appears.
2. Press ENTER, and then press ▲ or ▼ to highlight Language.
3. Press ENTER, and then press ▲ or ▼ to select your desired language.

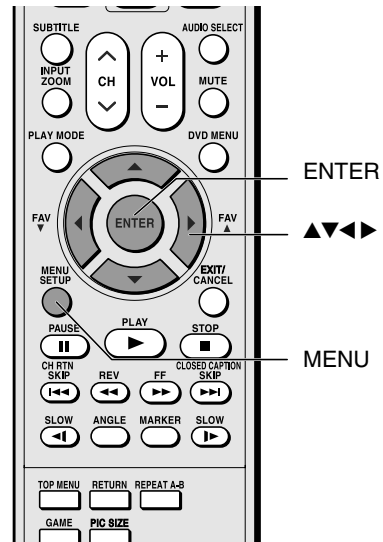

Adding channels to the TV's memory

When you press CH ▲ or CH ▼, your TV will stop only on the channels you program into the TV's channel memory.

Follow the steps below and on the next page to program all active channels into the TV's memory.

Programming channels automatically

Your TV can automatically detect all active channels in your area and store them in the channel memory. After the channels are programmed automatically, you can manually add or erase individual channels (see page 23).

To program channels automatically:

1. Press MENU, and then press ◀ or ▶ until the Channel menu appears.
2. Press ENTER, and then press ▲ or ▼ to highlight Auto program.



3. Press ENTER to start auto-programming. The TV will automatically cycle through all the TV and Cable channels, and store all active channels in the channel memory.

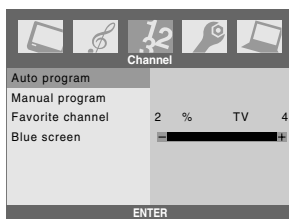

4. Press CH ▲ or CH ▼ to view the programmed channels.

Note:

- To tune the TV to a channel not programmed in the channel memory, you must use the Channel Number buttons on the remote control.
- If you press the ENTER button during auto-programming, the function will stop and only the channels programmed up to that time will be stored in the channel memory.

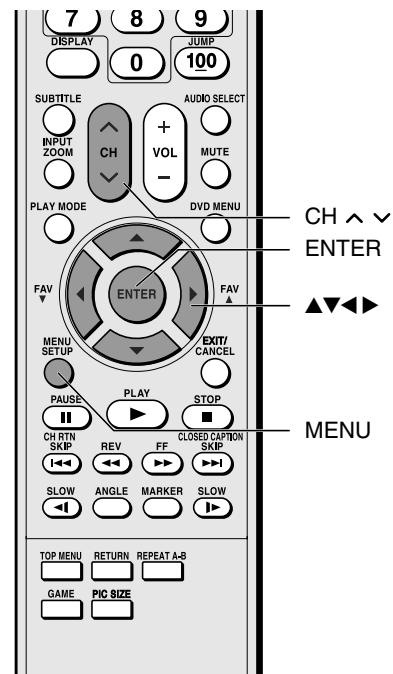

Adding and erasing channels manually

After you have automatically programmed the active channels into the TV's channel memory, you can manually add or erase specific channels.

To add or erase channels:

1. Press MENU, and then press ◀ or ▶ until the Channel menu appears.
2. Press ENTER, and then press ▲ or ▼ to highlight Manual program.
3. Press ENTER, and then press ◀ or ▶ to select a channel you want to add or erase.



4. Press ▼, and then press ◀ or ▶ to select Memory (add) or Erase. The current channel is added to Memory or erased from the channel list.

Changing channels

To change to a specific channel (programmed or unprogrammed):

Press the Channel Number buttons (0–9 and 100).

For channels 100 and higher, press the 100 button, and then the next two numbers. For example, to select channel 125, press 100, 2, 5.

To change to the next programmed channel:

Press CH ▲ or CH ▼ on the TV or remote control.

Programming your favorite channels

You can preset up to 8 of your favorite channels using the Favorite Channel Programming feature. Because this feature scans through only your favorite channels, it allows you to skip other channels you do not normally watch.

To program your favorite channels:

1. Press MENU, and then press ◀ or ▶ until the Channel menu appears.
2. Press ENTER, and then press ▲ or ▼ to highlight Favorite channel.
3. Press ENTER to display the Favorite Ch. menu.

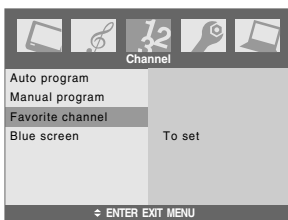

4. Press ▲ or ▼ to select the first favorite channel position.
5. Press ◀ or ▶ to set the desired channel number for the first favorite channel position.
6. Repeat steps 4 and 5 to program other channels.

To select your favorite channels:

Repeatedly press FAV ▲ or ▼ on the remote control.

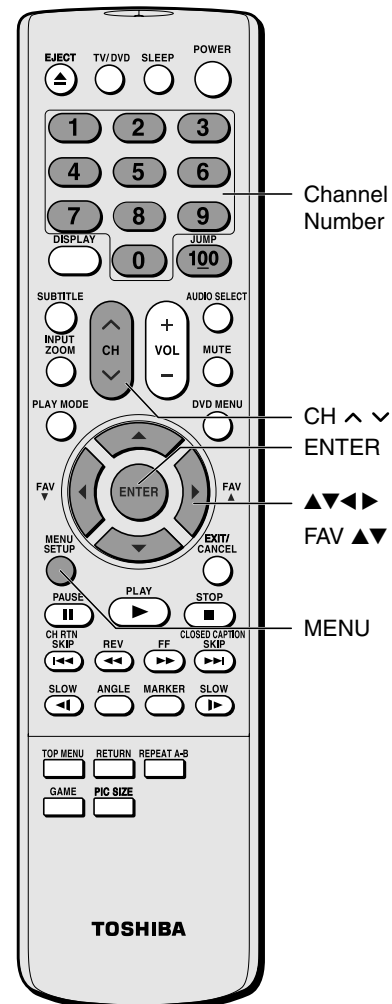
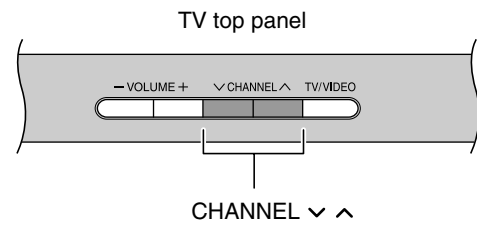

Using the TV's features

Switching between two channels using Channel Return

The Channel Return feature allows you to switch between two channels without entering an actual channel number each time.

To switch between two channels:

1. Select the first channel you want to view.
2. Select a second channel using the Channel Number buttons (0–9, 100).
3. Press CH RTN. The previous channel will be displayed.

Each time you press CH RTN, the TV will switch back and forth between the last two channels that were selected.

Using the Blue screen feature

With the Blue screen function On, the screen will automatically turn blue and the sound will be muted when no signal is received.

To turn on the Blue screen feature:

1. Press MENU, and then press ◀ or ▶ until the Channel menu appears.
2. Press ENTER, and then press ▲ or ▼ to highlight Blue screen.
3. Press ENTER, and then press ▲ or ▼ to select On.

Note: If the Blue screen appears repeatedly because of poor signal strength, select Off in step 3.

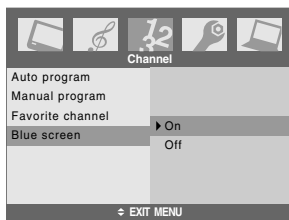

Selecting the video input source

Press INPUT on the remote control or press TV/VIDEO on the TV top panel to view a signal from another device connected to your TV, such as a VCR or DVD player. You can select Video1 (including ColorStream), Video2, PC or HDMI depending on which input jacks are used for connecting the devices (see "Connecting your TV" on page 12).

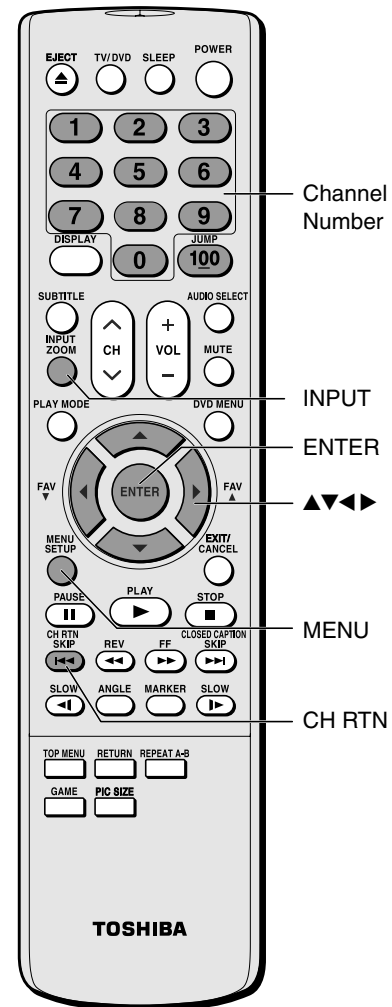
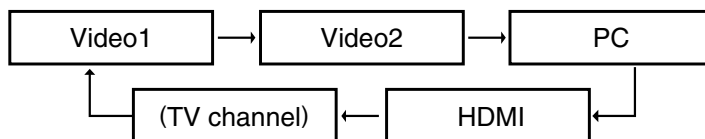

TV top panel

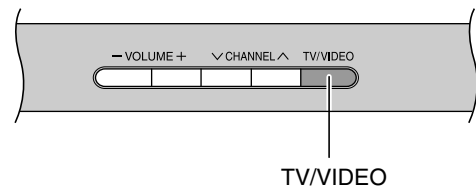

Viewing the wide-screen picture formats

You can view 480i, 480p, 720p, and 1080i format programs in a variety of picture sizes—Natural, TheaterWide 1, TheaterWide 2, TheaterWide 3, and Full.

The way the image displays in any of the picture sizes will vary depending on the format of the program you are viewing. Select the picture size that displays the current program the way that looks best to you.

Picture size \ Signal	Natural	Theater Wide 1	Theater Wide 2	Theater Wide 3	Full
480i	yes	yes	yes	yes	yes
480p	yes	yes	yes	yes	yes
720p	yes*	no	no	no	no
1080i	yes*	no	no	no	no

* Full picture size

Selecting the picture size

Repeatedly press PIC SIZE on the remote control to select the desired picture size, as described below and on the next page.

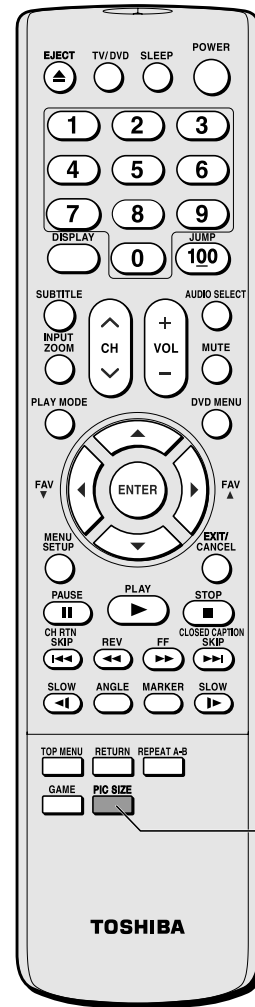
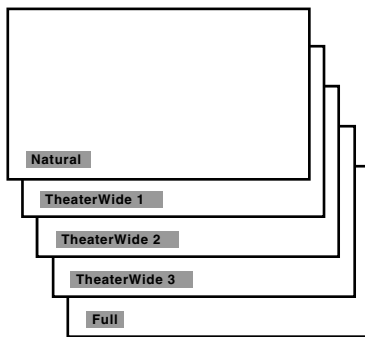

Natural picture size

- The image is displayed close to its originally formatted proportion. Some program formats will display with side bars and/or bars at the top and bottom.

Natural picture size example: The way the image displays will vary depending on the format of the program you are currently watching.

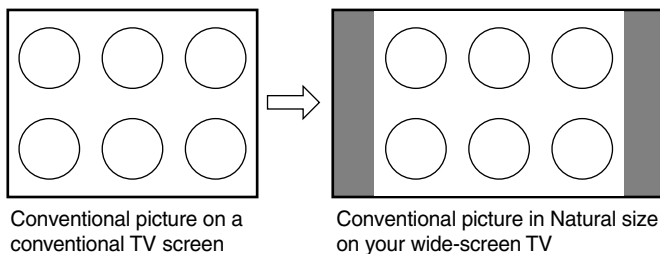

(continued on next page)

TheaterWide 1 picture size (For 4:3 format programs)

- The picture is non-uniformly enlarged—the center of the picture remains close to its original proportion, but the left and right edges are stretched wider to fill the screen.
- A small part of the picture at the top and bottom is hidden.

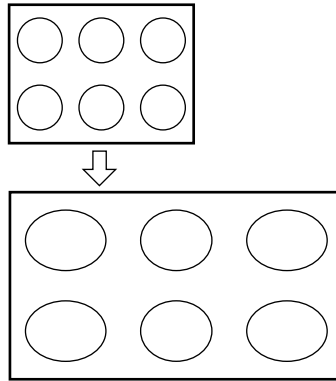

TheaterWide 1 picture size example

TheaterWide 2 picture size (For Letter box programs)

- The entire picture is uniformly enlarged—it is stretched the same amount both wider and taller (retains its original proportion).
- Part of the picture at the top and bottom is hidden.

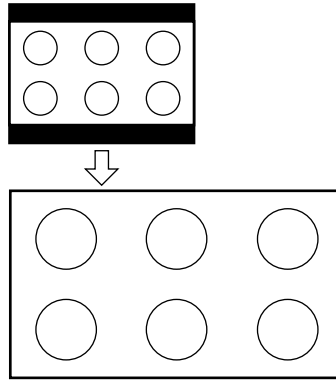

TheaterWide 2 picture size example

TheaterWide 3 picture size (For Letter box programs with subtitles)

- The picture is stretched wider to fill the width of the screen, but only slightly stretched taller.
- A small part of the picture at the top and bottom is hidden.

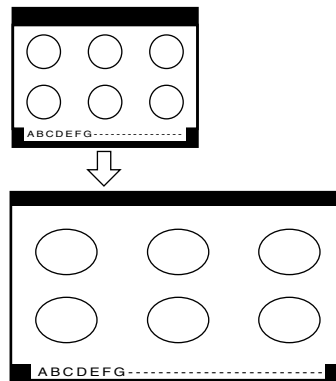

TheaterWide 3 picture size example

Note:

Using these functions to change the picture size (i.e., changing the height/width ratio) for any purpose other than your private viewing may be prohibited under the Copyright Laws of the United States and other countries, and may subject you to civil and criminal liability.

Full picture size (For 16:9 format programs)

- If you are receiving a 4:3 format program, the picture is stretched wider to fill the width of the screen, but not stretched taller.
- None of the picture is hidden.

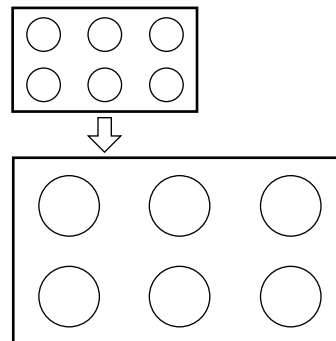

Full picture size example

Using the V-Chip menu

Some TV programs and movies include signals that classify the content of the program (violence, sex, dialog, language). The V-Chip control feature in this TV detects the signals and blocks the programs according to your selections. To use this feature, perform the following setup.

1. Enable the Lock.
2. Set a four-digit password.
3. Select the ratings and categories you want to block.

V-Chip rating and categories

Rating guidelines are provided by broadcast stations. Most television programs and television movies can be blocked by TV rating and/or category. Movies that have been shown at the theaters and direct-to-video movies use the MPAA movie rating system instead.

For Movies previously shown in theaters :

Movie Ratings :

- Unblocked
- G & above (general audience)
- PG & above (parental guidance suggested)
- PG-13 & above (13 years and older)
- R & above (restricted)
- NC-17 & above (18 years and older)
- X (adult)

If you select "PG-13 & above," all G and PG rated movies will be available, and all PG-13, R, NC-17 and X rated movies will be blocked.

For Television programs including made-for-TV movies:

General TV Ratings:

- Unblocked
- TV-G & above (general audience)
(individual categories do not apply)
- TV-PG & above (parental guidance suggested)
- TV-14 & above (14 years and older)
- TV-MA (mature audience)

Children TV Ratings:

- Unblocked
- TV-Y & above (youth)
(individual content categories do not apply)
- TV-Y7 (youth, 7 years and up)

Content Categories:

- Dialog - sexual dialogue (applies to TV-PG & above, TV-14)
- Language - adult language (applies to TV-PG & above, TV-14 & above, TV-MA)
- Sex - sexual situations (applies to TV-PG & above, TV-14 & above, TV-MA)
- Violence (applies to TV-PG & above, TV-14 & above, TV-MA)
- F. Violence - fantasy violence (applies only to TV-Y7)
- No Rating (blocks all viewing)

Note:

The V-Chip function is available for the U.S. V-Chip system only. The Canadian V-Chip system is not supported.

V-Chip blocking (Parental control) setup

1. Press MENU, and then press ◀ or ▶ until the Special menu appears.
2. Press ENTER, and then press ▲ or ▼ to highlight V-Chip. Press ENTER.

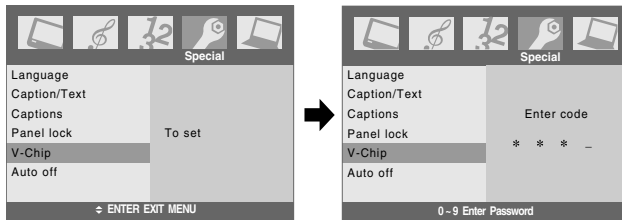

- If you already set a password, enter your four-digit password.
- If you have not created a password, the TV is initially set up with the password "0-0-0-0".
- If you cannot remember your password, press "7-7-7-7."

3. Enabling the Lock:

Press ▲ or ▼ to highlight Lock.
Press ENTER, and then press ▲ or ▼ to select On (Lock) or Off (Unlock).

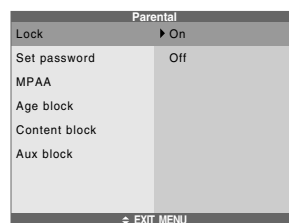

4. Set a password:

Press ▲ or ▼ to highlight Set password.
Press ENTER, and then enter a four-digit password.
Enter it again when requested.

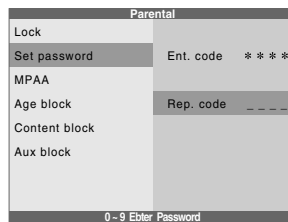

5. Press ▲ or ▼ to highlight the type of blocking to be set.
6. Press ENTER, and then press ▲ or ▼ to select the type of ratings to block.

- The age block and Content block menus also have sub-menus; therefore, you will need to repeat steps 5 and 6 to set the types of blocking and ratings in the sub-menus.

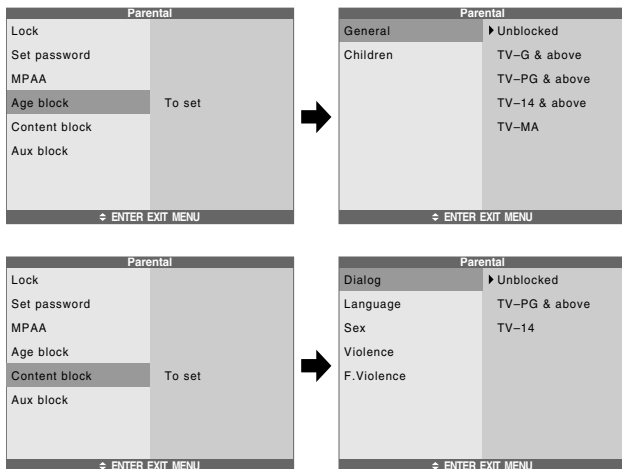

If you try to watch a TV program that exceeds the rating limits you set, the TV enters program lock mode.

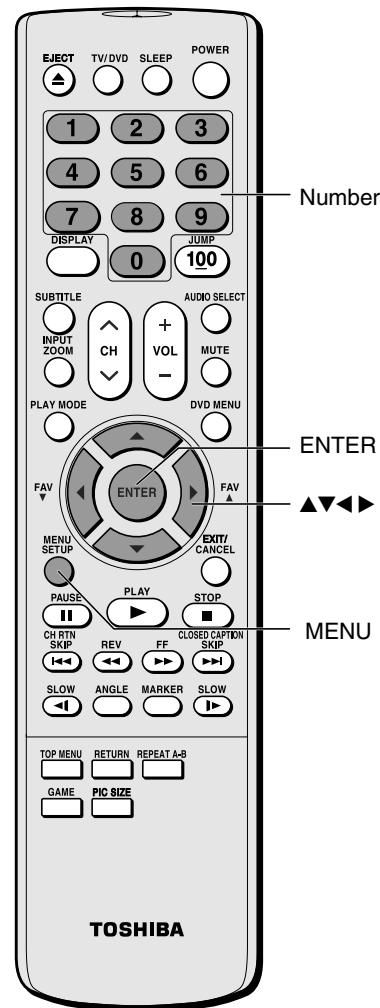

Adjusting the picture

Selecting the picture mode

You can select your desired picture type from four picture modes: Dynamic, Standard, Movie, or Memory.

Mode	Picture Quality
Dynamic	Bright and dynamic picture (factory setting)
Standard	Standard picture setting (factory setting)
Movie	Movie-like picture setting (factory setting)
Memory	Your personal preference

To select the picture mode:

1. Press MENU, and then press ◀ or ▶ until the Picture menu appears.
2. Press ENTER, and then press ▼ or ▲ to highlight Picture mode.
3. Press ENTER, and then press ▼ or ▲ to select the mode you prefer.

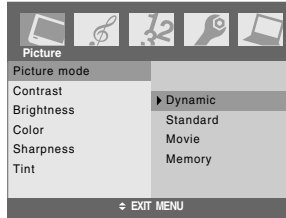

Adjusting the picture quality

You can adjust the picture quality to your personal preferences, including the contrast, brightness, color, sharpness, and tint.

Selection	Pressing	
Contrast	lower	higher
Brightness	darker	lighter
Color	paler	deeper
Sharpness	softer	sharper
Tint	reddish	greenish

To adjust the picture quality:

1. Press MENU, and then press ◀ or ▶ until the Picture menu appears.
2. Press ENTER, and then press ▲ or ▼ until the item you want to adjust is highlighted.
3. Press ENTER.
4. Press ◀ or ▶ to adjust the level.

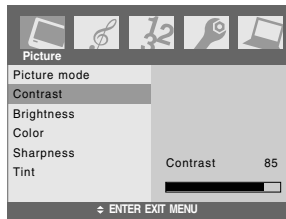

The Picture qualities you adjusted can be saved in the TV's Memory.

Note:

If you select one of the factory-set picture modes (Dynamic, Standard, or Movie) and then adjust a picture quality setting (for example, increase the contrast), the picture mode automatically changes to Memory in the Picture menu.

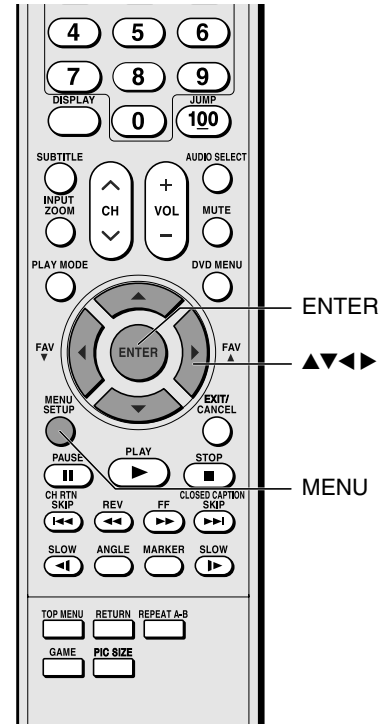

Note:

To continue adjusting the other items, press ▲ or ▼ in step 4.

Using the closed caption feature

The closed caption feature has two options:

- Captions—An on-screen display of the dialogue, narration, and sound effects of TV programs and videos that are closed captioned (usually marked as “CC” in TV listings).
- Text—An on-screen display of information not related to the current program, such as weather or stock data (when provided by individual stations).

To select captions or text:

1. Tune the TV to the desired program.
2. Press MENU, and then press ◀ or ▶ to display the Special menu.
3. Press ENTER, and then press ▲ or ▼ to highlight Caption/Text.

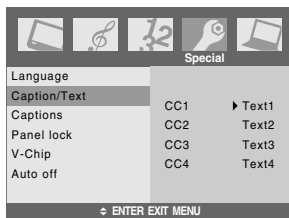

4. Press ENTER, and then press ▲ or ▼ to select the Caption or Text mode you prefer.

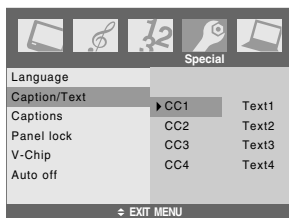

- To view captions, select CC1, CC2, CC3, or CC4 (CC1 displays captions in the primary language in your area).

Note: If the program or video you selected is not closed captioned, the captions will not display on the screen.



- To view text, select Text1, Text2, Text3, or Text4.

Note: If text is not available in your area, a black rectangle may appear on your screen. If this happens, turn the Closed Caption feature Off.

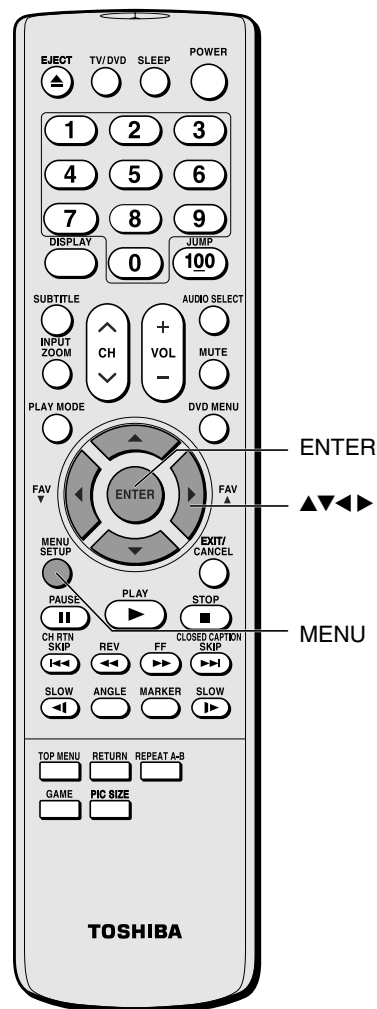
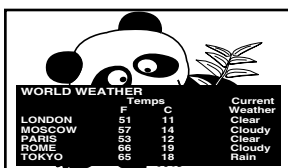

Note:

A closed caption signal may not display in the following situations:

- When a videotape has been dubbed
- When the signal reception is weak
- When the signal reception is nonstandard

To turn on or off the closed caption feature

1. Press MENU, and then press ◀ or ▶ to display the Special menu.
2. Press ENTER, and then press ▲ or ▼ to highlight Captions.
3. Press ENTER, and then press ▲ or ▼ to select On, Advanced mute or Off.
 - Advanced mute activates the selected Caption or Text mode when the TV sound is muted.

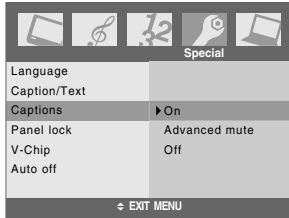

The CLOSED CAPTION button on the remote control can also be used to select On, Advanced mute (see page 32), or Off.

Using the Panel lock feature

You can lock the control buttons on the TV to prevent your settings from being changed accidentally (by children, for example).

When the Panel lock is On, no control buttons on the TV top panel will operate except POWER.

To lock the top panel:

1. Press MENU, and then press ◀ or ▶ to display the Special menu.
2. Press ENTER, and then press ▲ or ▼ to highlight Panel lock.
3. Press ENTER, and then press ▲ or ▼ to select On.

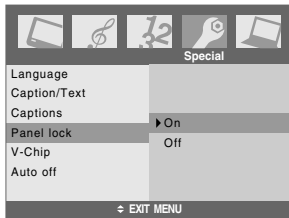

To unlock the top panel:
Select Off in step 3 above.

Setting the sleep timer

To set the sleep timer to turn off the TV automatically:

Repeatedly press SLEEP to set the length of time until the TV turns off.

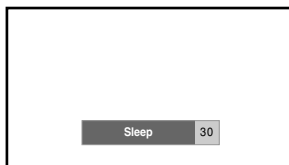

Every time you press SLEEP, the time display will increase by 30 minutes, up to 120 minutes.

30 → 60 → 90 → 120 → ---

To cancel the sleep timer:

Press SLEEP until "Sleep ---" appears.

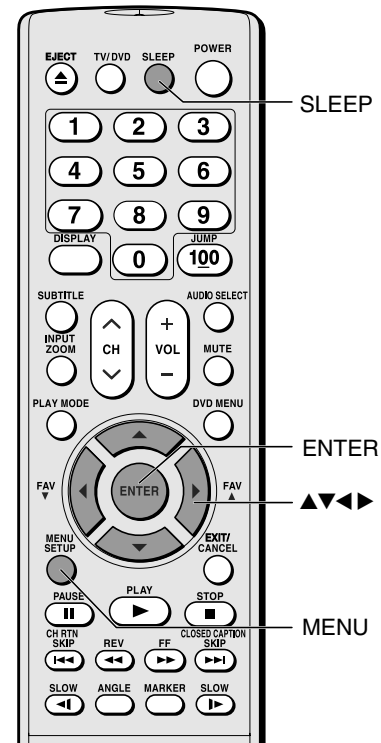
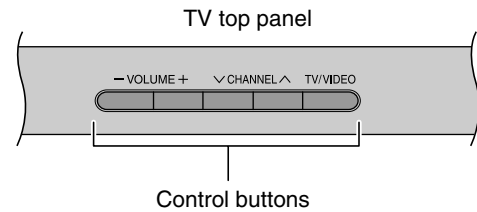
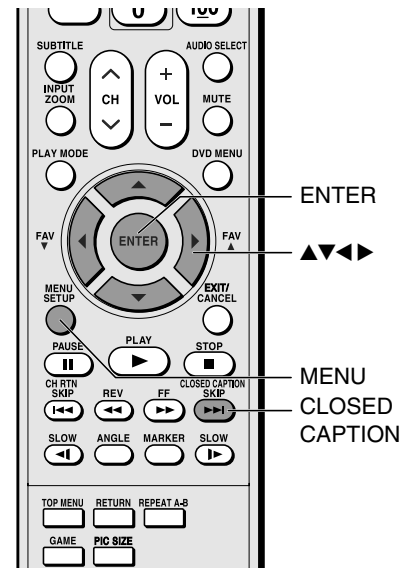

Note :

- When an instant power failure occurs, the sleep timer settings may be cleared.
- To display the amount of time left until the TV turns off automatically, press SLEEP once.

Adjusting the sound

Muting the sound

Press MUTE to temporarily turn off the sound. While the sound is off, the screen will display "Mute" in the lower left corner.

When you select "MUTE" mode, the closed caption feature is automatically activated. To deactivate this feature, deactivate MUTE. This feature works only when the closed caption mode is set to Advanced mute. See "Using the closed caption feature" on page 30 for more information.

Selecting stereo/SAP broadcasts

The multi-channel TV sound (MTS) feature allows you to listen to high-fidelity stereo sound while watching TV. MTS can also transmit a second audio program (SAP) containing a second language, music, or other audio information (when provided by individual stations).

When the TV receives a stereo or SAP broadcast, the word "ST.SAP", "Stereo" or "SAP" appears on-screen every time the TV is turned on, the channel is changed, or DISPLAY is pressed.

The MTS feature is not available when the TV is in Video mode.

To listen to stereo sound:

Repeatedly press AUDIO SELECT to select Stereo.

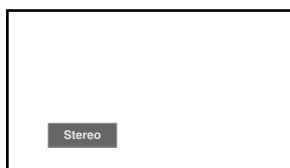

You can leave your TV in Stereo mode because it will automatically output the type of sound being broadcast (stereo or monaural).

If the stereo sound is noisy, select Mono to reduce the noise.

To listen to SAP (if available):

Press AUDIO SELECT repeatedly to select SAP.



You will hear the station's second audio program (if available) from the speakers, while viewing the original program's picture.

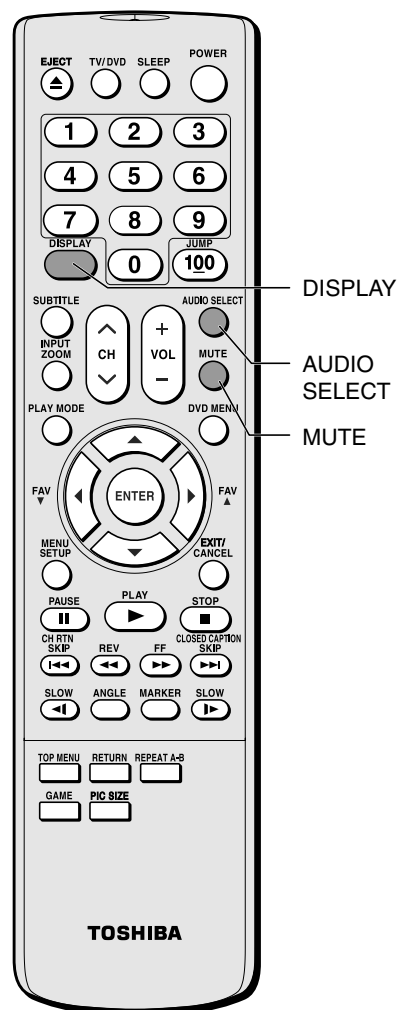

Using the WOW surround sound feature

WOW surround widens and deepens audio listening field to deliver exceptional sound from the TV's speakers. The feature uses stereo signals from a TV broadcast or video input.

To activate the WOW feature:

1. Select Stereo mode (see "Selecting stereo/SAP broadcasts" on page 32).
2. Press MENU, and then press ◀ or ▶ until the Sound menu appears.
3. Press ENTER, and then press ▲ or ▼ to highlight Sound mode.
4. Press ENTER, and then press ▲ or ▼ to select WOW.

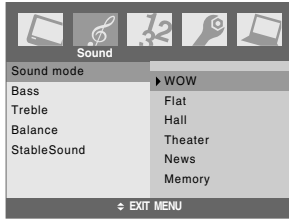

Selecting the sound mode

You can select your desired sound type from six sound modes: WOW, Flat, Hall, Theater, News, or Memory.

To select the sound mode:

1. Press MENU, and then press ◀ or ▶ until the Sound menu appears.
2. Press ENTER, and then press ▼ or ▲ to highlight Sound mode.
3. Press ENTER, and then press ▼ or ▲ to select the mode you prefer.

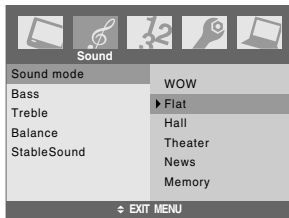

Mode	Sound Quality
WOW	see above
Flat	flat sound (factory setting)
Hall	a concert hall filled with a rich warm sound (factory setting)
Theater	a movie theater filled with a dynamic sound (factory setting)
News	news/dialogue (factory setting)
Memory	your personal preference

Note:

If the broadcast is monaural, the WOW sound effect will not work.

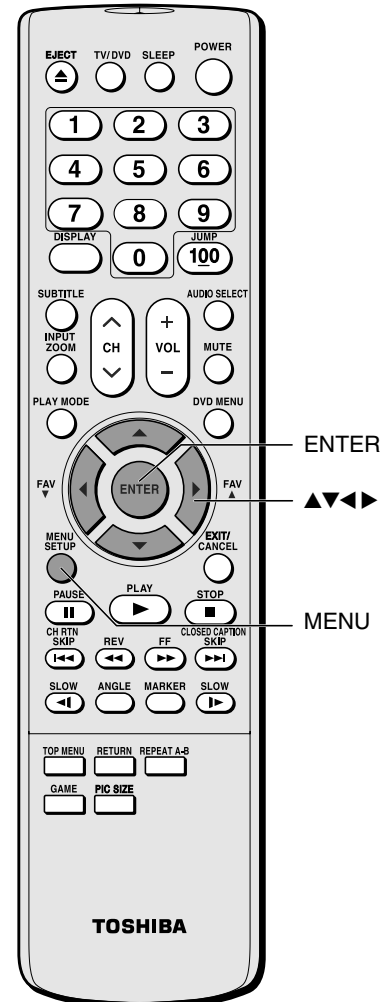

Note:

If you select one of the factory-set audio modes (WOW, Flat, Hall, Theater, or News) and then change a sound quality setting (for example, increase the bass), the sound mode automatically change to Memory mode.

Adjusting the sound quality

You can change the quality of your TV's sound by adjusting the bass, treble, and balance.

To adjust the sound quality:

1. Press MENU, and then press ◀ or ▶ until the Sound menu appears.
2. Press ENTER, and then press ▲ or ▼ to highlight the item you want to adjust.

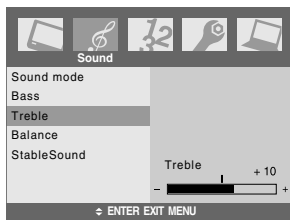

3. Press ENTER.
4. Press ◀ or ▶ to adjust the level.

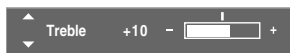

- ◀ makes the sound quality weaker or increases the balance in the left channel, depending on the item selected.
- ▶ makes the sound quality stronger or increases the balance in the right channel, depending on the item selected.

Note:

To continue adjusting the other items, press ▲ or ▼ in step 4.

Using the StableSound® feature

When the signal source is changed, the StableSound feature limits the highest volume level to prevent extreme changes in volume (for example, to prevent the sudden increase in volume that often happens when a TV program switches to a commercial).

To turn on the StableSound feature:

1. Press MENU, and then press ◀ or ▶ until the Sound menu appears.
2. Press ENTER, and then press ▲ or ▼ to highlight StableSound.
3. Press ENTER, and then press ▲ or ▼ to select On.

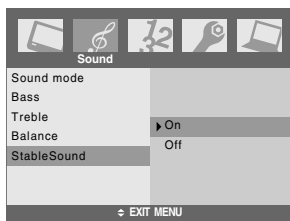

To turn off the StableSound feature:
Select Off in step 3 above.

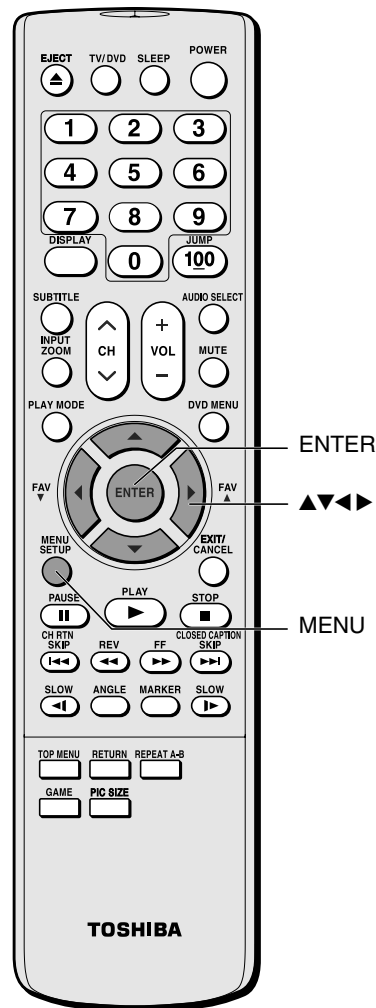

Using the PC setting feature

You can adjust the horizontal/vertical picture position, clock (to minimize vertical stripes on the screen), and phase (to remove horizontal noise and sharpen the picture).

You can auto-configure and reset these settings.

1. Confirm a PC is connected (see “Connecting a personal computer (PC)” on page 18).
2. Repeatedly press INPUT on the remote control (or press TV/ VIDEO on the TV top panel) to select PC input mode. (See “Selecting the video input source” on page 24.)
3. Press MENU, and then press ◀ or ▶ until the PC menu appears.
4. Press ENTER, and then press ▲ or ▼ to select an item.

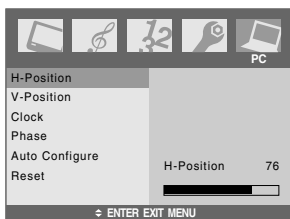

5. Press Enter.
6. Press ◀ or ▶ to make the appropriate adjustments.
 - H-position/V-position
Adjusts picture left/right and up/down. The adjustment range is 0–100. (The adjustable range may vary depending on the input mode.)
 - Clock
Minimizes any vertical bars or stripes appearing on the screen background. The adjustment range is 0–100. (The adjustable range may vary depending on the input mode.)
 - Phase
Reduces (or minimizes) any horizontal noise and clears up or sharpens the character images. The range adjustment is 0–100. (The adjustable range may vary depending on the input mode.)
 - Auto Configure
Automatically adjusts the screen position, clock, and phase. (The displayed image will disappear for a few seconds while auto-configuration is in progress.)
 - Reset
Returns to the default settings programmed at the factory. The values in the Reset function cannot be modified.

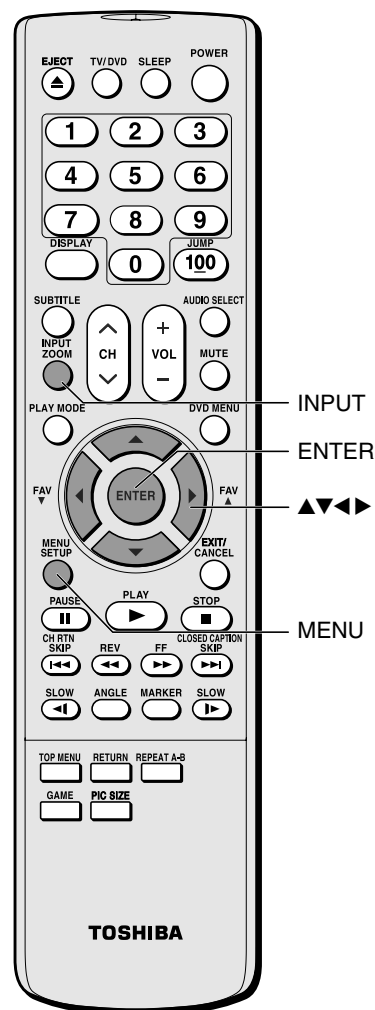
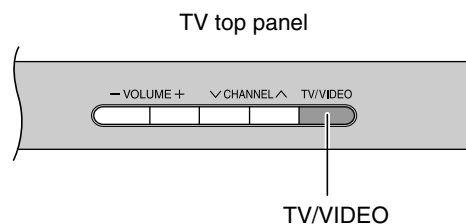

Using the Game Mode feature

You can use the Game Mode feature for shorter frame delays when playing a video game requiring split-second timing between the on-screen display and input from the controller (such as music creation and high-action games).

To turn on Game Mode:

Press GAME. The TV will switch to the Game Mode when the on-screen display closes.

Note:

If you adjust the volume or make any other adjustments that cause a menu or on-screen control panel to display, the Game Mode will be temporarily suspended until the on-screen display closes.

To turn off Game Mode:

You can change the video input in any of the following ways:

- pressing INPUT.
- changing the channel using the Number buttons or CH \wedge \vee .

Using the Auto off feature

When the Auto off feature is set to On, the TV will automatically turn itself off after approximately 15 minutes if it is tuned to a vacant channel or a station that completes its broadcast for the day. This feature does not work when the Blue screen mode is set to Off.

To activate the Auto off feature:

1. Press MENU, and then press \blacktriangleleft or \blacktriangleright until the Special menu appears.
2. Press ENTER, and then press \blacktriangle or \blacktriangledown to highlight Auto off.
3. Press ENTER, and then press \blacktriangle or \blacktriangledown to Select On.

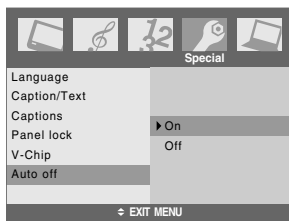

To deactivate the Auto off feature:

Select Off in step 3 above.

Displaying on-screen information

Press DISPLAY to display the following information on-screen:

- Channel number or Video mode selected
- Stereo or SAP audio status



Understanding the last mode memory feature

If the power is cut off while you are viewing the TV, the Last Mode Memory feature turns on the TV automatically when the power is resupplied.

If the power is going to be off for a long time and you are going to be away from your TV, unplug the power cord to prevent the TV from turning on in your absence.

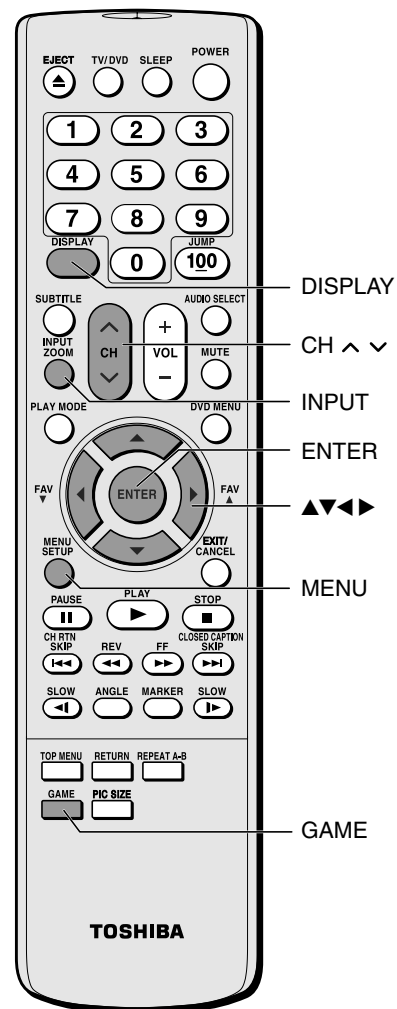

DVD Playback

Learning about the remote control

The buttons used for operating the DVD only are described here.

POWER turns the TV on and off.

TV/DVD switches to the DVD mode

EJECT ejects the DVD loaded in the disc slot (page 38)

Number buttons (0-9, 100) enters the numbers directly

JUMP jumps the desired title (page 39)

AUDIO SELECT changes the audio-related setting (page 39)

MUTE reduces or turns off the sound

VOL (volume) + - adjusts the volume level

DVD MENU accesses disc menus (page 39)

SUBTITLE selects the subtitle language or turns the subtitle off (page 40)

ZOOM enlarges or reduces the picture size (page 39)

PLAY MODE changes repeat mode (page 39)

ENTER activates the function settings in the menu (page 39)

▲▼◀▶ (arrow buttons) select or adjust menu items

MENU/SETUP opens the menu system (page 40)

EXIT/CANCEL closes the menu system

PAUSE || pauses the picture. To restart, press again (page 38)

PLAY ▶ begins playback of a DVD (page 38)

STOP ■ stops playback of a DVD (page 38)

REV ◀◀ rewinds the DVD. (Press during play mode to view the picture moving rapidly backward.) (page 38)

FF ▶▶ fast-forwards the DVD. (Press during play mode to view the picture moving rapidly forward.) (page 38)

SKIP ◀◀◀ skips back to beginning of current DVD chapter or locates previous chapters (page 38)

SKIP ▶▶▶ skips forward to locate later DVD chapters (page 38)

SLOW ◀▶ plays forward or reverse in slow-motion (page 38)

ANGLE changes the angle when playing back a DVD recorded with multi-angle facility (page 39)

MARKER accesses the bookmaker settings (page 39)

TOP MENU accesses a title menu (page 39)

RETURN returns to the previous MP3 file you were listening

REPEAT A-B allows you to repeat material between two selected points (page 39)

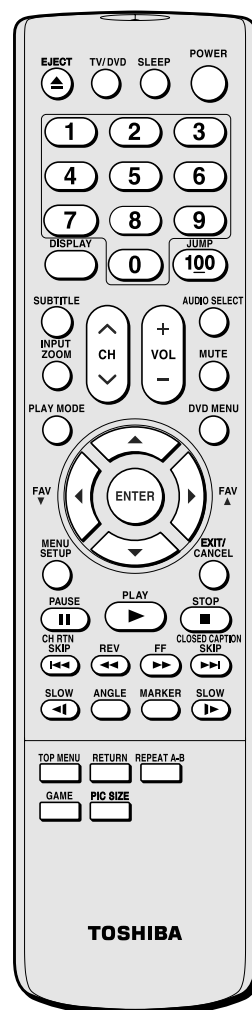

DVD & VCD Operation

Basic Playback

1. Press POWER.
2. Slide your chosen disc into the disc slot on the side panel. Be sure to face the top of the disc (with title etc.) toward the front of the screen. Playback starts.
3. Press EJECT to remove the disc.

Stop Playback

1. Press STOP ■ to stop playback. At this time, DVD video player stops playback temporarily and maintains the current playback position.
 - If PLAY ► is pressed, playback will resume from the location where you stopped playback.
2. Press STOP ■ again to stop playback fully. (At this time, if you press PLAY ►, disc playback start from the beginning.)

Pause Playback (Still mode)

1. Press PAUSE ■ during playback.
2. Press PLAY ► again to return to normal playback.

Note:

- Press PLAY ► to return to DVD mode from the TV, Video or PC mode.
- If you have a disc problem during playback, remove the disc by pressing and holding down EJECT on the top panel for more than 4 seconds.

Fast Forward/Backward

1. Press FF ►► or REV ◀◀ during playback. Each time you press FF ►► or REV ◀◀, the playback speed changes as shown.
 - FF ►► : ►► 2× → ►► 4× → ►► 8× → ►► 16× → ►► 32× → 1×.
 - REV ◀◀ : ◀◀ 2× → ◀◀ 4× → ◀◀ 8× → ◀◀ 16× → ◀◀ 32× → 1×.
2. Press PLAY ► to resume normal playback.

Slow Forward/Backward

1. Press SLOW ► or SLOW ◀ during playback. Each time you press SLOW ► or SLOW ◀, the playback speed changes as shown:
 - SLOW ► : ► 1/2 → ► 1/4 → ► 1/8 → ► 1/16 → 1×.
 - SLOW ◀ : ◀ 1/2 → ◀ 1/4 → ◀ 1/8 → ◀ 1/16 → 1×. (DVD only)
2. Press PLAY ► to resume normal playback.

Note:

There is no sound during fast or slow playback for DVDs or Video CDs.

Skip a Chapter or a Track

1. Press SKIP ►► or SKIP ◀◀ to locate a desired chapter during playback. Each time you press the button, a chapter or track is skipped.
 - Press SKIP ►► to locate succeeding chapters or tracks.
 - Press SKIP ►► twice in quick succession, playback will start from the beginning of the next chapter or track.
 - Press SKIP ◀◀ to go back to the beginning of the current chapter or track.
 - Press SKIP ◀◀ twice in quick succession, playback will start from the beginning of the previous chapter or track.

Frame by Frame Playback

1. Press SKIP ►► or SKIP ◀◀ in the still mode, one frame is displayed at a time. This function maybe operate differently depending on the disc type. (The backward frame function doesn't work in VCD disc.)

On-Screen Display

You can display the playback status on TV screen as follows: Title, Chapter number, Playing time.

1. Press DISPLAY during DVD playback. Title, Chapter information appears on screen. Each time you press DISPLAY, the OSD changes as follows.
 - DVD: Title Elapsed → Title Remain → Chapter Elapsed → Chapter Remain → Display off
 - VCD: Single Elapsed → Single Remain → Total Elapsed → Total Remain → Display off

DVD

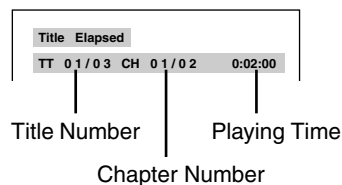

VCD

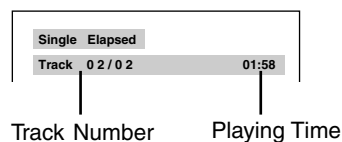

Note:

OSD display may different depending on the type of DVD disc.

Selecting disc menu

1. Press DVD MENU during playback.
2. Use ▲▼◀▶, or ENTER to select the desired menu option.

Selecting title menu





1. Press TOP MENU during playback.
2. Use ▲▼◀▶, or ENTER to select the desired item.

Note :

The unit may not be able to select the disc or title menu depending on the type of DVD disc.



Repeat playback

You can play a specific title, chapter, track, or segment repeatedly.

1. Press PLAY MODE during playback.
Each time you press PLAY MODE, the repeat mode changes as follows.
 - DVD :  Chapter →  Title →  ALL → Repeat Off
 - VCD :  Track →  ALL → Repeat Off

A-B repeat playback

A-B repeat playback allows you to repeat material between two selected points.

1. Press REPEAT A-B to select the start point during playback. “A” is displayed on TV screen and the starting point of your selected segment is set up.
2. Press REPEAT A-B again to select the end point. “AB” is displayed on TV screen and the ending point is set up.
Playback starts at the point that you selected. Playback stops at the end point, returns to Point A automatically, then starts again.
3. Repeatedly press REPEAT A-B again to resume normal playback.
“Off” appears on the screen.

Selecting camera angles

If the scene was recorded from multiple angles, you can easily change the camera angle of the scene you are currently watching.

1. Press ANGLE during playback.
2. Repeatedly press ANGLE to select the desired angle.

Note:

- You can only change the angle for DVDs that provide multiple angles of scenes.
- The angle function will not work on DVD video discs that do not contain scenes recorded at different angles.
- The number of angles varies from disc to disc.

Picture Size Zoom

When enlarging or reducing the picture, it may become distorted.

1. Press ZOOM during playback.
2. Each press of ZOOM changes the screen display as indicated below:
2×, 3×, 4×, 1/2, 1/3, 1/4, (Zoom off)
3. Adjust the main picture position using ▲▼◀▶ while in the enlarged picture mode.

JUMP

1. Press JUMP in the stop mode.
2. Use the number buttons to enter desired title. Playback will start from the beginning of the desired title.

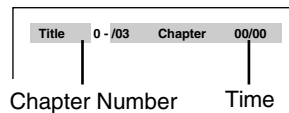

Note :

Depending on the disc, on-screen display may be different.

AUDIO SELECT

1. Press AUDIO SELECT to change the audio-related setting during DVD playback.
Each time you press it, the set value is changed.

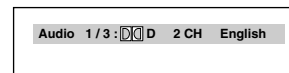

Note :

Depending on the disc, Audio setup may not be possible.

MARKER

1. Press MARKER during playback. The Bookmark picture appears as the DVD is playing.

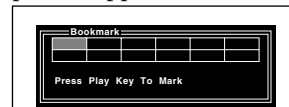

2. Press PLAY ► at any scenes where you want to place a mark.

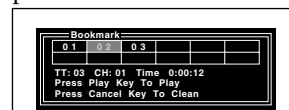

3. Press ▲▼◀▶, select a marker, and then press PLAY ►. Playback starts from the desired scene.

About DVD Screen Saver

If you pause or stop a picture of a DVD video disc and leave it still for approximately 2 minutes, the screen saver of the player automatically appears.

To turn off the screen saver, press any button related DVD on the remote control.

DVD Menu options

If you press SETUP in the stop mode, the DVD menu is displayed, and in the play or pause mode, the TV setup menu is displayed.

Selecting an audio language

Select your preferred audio language. If an audio language is selected, the selected audio language is played whenever you start a new disc playback. (The disc must contain the selected language)

1. Press SETUP in the stop mode, and then press ▲ or ▼ to select Audio Language.
2. Press ►, and then press ▲ or ▼ to select your desired language.



3. Press ENTER.
4. Press SETUP to resume normal playback.

Selecting a subtitle language

Select your preferred subtitle language. If a subtitle language is selected, the selected subtitle language is played whenever you start a new disc playback. (The disc must contain the selected language)

You can also select another available subtitle language during playback with SUBTITLE on the remote control during playback.

1. Press SETUP in the stop mode, and then press ▲ or ▼ to select Subtitle Language.
2. Press ►, and then press ▲ or ▼ to select your desired language.



3. Press ENTER.
4. Press SETUP to resume normal playback.

Disc menu language selection

Select your preferred language for the disc menus and DVD messages. (The disc must contain the selected language)

1. Press SETUP in the stop mode, and then press ▲ or ▼ to select Menu Language.
2. Press ►, and then press ▲ or ▼ to select your desired language.



3. Press ENTER.
The menus and on screen displays will appear in the selected language.
4. Press SETUP to resume normal playback.

Parental Control Setup

Use to block viewing of unsuitable discs.

1. Press SETUP in the stop mode, and then press ▲ or ▼ to select Rating Level.
2. Press ► and then use number buttons to key in a 4-digit password.
Be sure to remember the password!

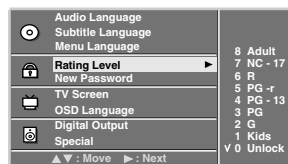

3. Press ▲ or ▼ to set the restriction level from 0 to 8. Viewing becomes more restricted as the number decreases.
 - 0: Unlock
 - 1: Kids
 - 2: G (General audience)
 - 3: PG (Parental guidance suggested)
 - 4: PG-13 (13 years and older)
 - 5: PG-r
 - 6: R (Restricted)
 - 7: NC-17 (18 years and older)
 - 8: Adult (Adults only)
4. Press SETUP to resume normal playback.

Note:

If you ever forget your password, key in '7'; '7'; '7'; '7' on the remote control.

Changing the password

1. Press SETUP in the stop mode, and then press ▲ or ▼ to select Rating Level.
2. Press ►, and then use number buttons to key in a 4-digit password.
3. Press ◀, and then press ▲ or ▼ to select New Password.

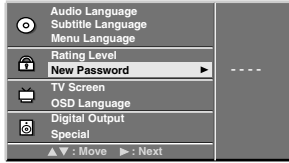

4. Press ►, and then enter a 4 digit password. Enter it again when requested.
5. Press SETUP to resume normal playback.

TV Screen

You can watch TV in various picture formats.

1. Press SETUP in the stop mode, and then press ▲ or ▼ to select TV Screen.
2. Press ►, and then press ▲ or ▼ to select 4 : 3 LB, 4 : 3 PS, or 16 : 9 Wide.



3. Press ENTER.
4. Press SETUP to resume normal playback.

Note :

Depending on the disc, the TV screen feature may not be available.

Disc OSD language selection

The on-screen display can be shown on the screen in your specified language.

1. Press SETUP in the stop mode, and then press ▲ or ▼ to select OSD Language.
2. Press ►, and then press ▲ or ▼ to select your desired language. All the on screen displays will appear in the selected language.
3. Press SETUP to resume normal playback.

Digital audio output

You can select the output for SPDIF (Sony/Philips Digital Interface).

1. Press SETUP in the stop mode, and then press ▲ or ▼ to select Digital Output.
2. Press ►, and then press ▲ or ▼ to select OFF, RAW (Original SPDIF signal), or PCM (Pulse Code Modulation: Encodes SPDIF signal to PCM).



3. Press ENTER.
4. Press SETUP to resume normal playback.

DRC (Dynamic Range Compression)

Confines the audio range to prevent excessively loud sound yet allows you to hear the low sounds clearly.

1. Press SETUP in the stop mode, and then press ▲ or ▼ to select Special.
2. Press ►, and then press ▲ or ▼ to select DRC Off (Decrease the DRC range) or DRC On (Reset the DRC range to original values).



3. Press ENTER.
4. Press SETUP to resume normal playback.

MP3/WMA files Playback options

MP3/WMA Files Playback

1. When inserted, the MP3 menu screen appears automatically depending on the MP3 disc's folder (directory) structure as shown to the below.
2. Press ▲ or ▼ to find desired folder and then press ENTER.
3. Press ▲ or ▼ to find the desired MP3 title and then press ENTER.

Stop/Pause Playback

Stop Playback

Press STOP ■ to stop playback.

Pause Playback

1. Press PAUSE ■ during playback.
2. Press PLAY ► again to return to normal playback.

Repeat playback

You can play a specific track repeatedly.

1. Press PLAY MODE during playback. Each time you press PLAY MODE, the repeat mode changes in the following order:
⌚ Track → ⌚ ALL → Off

A-B repeat playback

A-B repeat playback allows you to repeat material between two selected points.

1. Press REPEAT A-B to select the start point during playback. "⌚A" is displayed on TV screen and the starting point of your selected segment is set up.
2. Press REPEAT A-B again to select the end point. "⌚AB" is displayed on TV screen and the ending point is set up. Playback starts at the point that you selected. Playback stops at the end point, returns to Point A automatically, then starts again.
3. Repeatedly press REPEAT A-B until "Off" appears on the screen to resume normal playback.

Playable files

MP3/WMA disc compatibility with this player is limited as follows:

- Playable discs: CD-ROM, CD-R, CD-RW
- Sampling Frequency: 44,1 kHz, 48 kHz
- Bit rate: WMA: 48 kbps - 192 kbps(CBR)
MP3: 32 kbps - 320 kbps (CBR)
- CD physical format: Mode 1
- File system: ISO9660, UDF without interleave
- File name: File names are limited to eight characters or less and must incorporate "MP3" or "WMA" extension.
e.g. "*****.MP3", "*****.WMA"
File names cannot contain special characters such as "?!><+*}{[@]:; \ / , ." etc.
- File size: Less than 50 bytes
- Total number of files: Less than 650
- WMA codec version: V2, V7, V8, V9 (Stereo sound only)

Audio CD Playback options

On-Screen Display

You can display the Track, and Playback time status on the TV screen.

1. Press DISPLAY during CD playback. Track information appear on screen. Each time you press DISPLAY, the OSD changes as follows: Single Elapsed → Single Remain → Total Elapsed → Total Remain

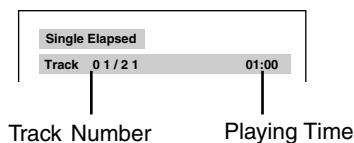

Stop Playback

1. Press STOP ■ to stop playback. At this time the DVD video player stops playback temporarily and maintains the current playback position.
 - If PLAY ► is pressed, playback will resume from the location where you stopped playback.
2. Press STOP ■ again to stop playback fully. (At this time if you press PLAY ►, disc playback starts from the beginning.)

Pause Playback (Still mode)

1. Press PAUSE ■ during playback.
2. Press PLAY ► again to return to normal playback.

Fast Forward/Backward

1. Press FF ►► or REV ◀◀ during playback. Each time you press FF ►► or REV ◀◀, the playback speed changes as shown.
 - FWD ►► : ►► 2x → ►► 4x → ►► 8x
→ ►► 16x → ►► 32x.
 - REV ◀◀ : ◀◀ 2x → ◀◀ 4x → ◀◀ 8x
→ ◀◀ 16x → ◀◀ 32x.
2. Press PLAY ► to resume normal playback.

Repeat playback

You can play a specific track repeatedly.

1. Press PLAY MODE during playback. Each time you press PLAY MODE, the repeat mode changes as indicated:
○ Track → ○ ALL → Repeat Off

Skip Tracks

1. Press SKIP ►► or SKIP ◀◀ to locate a desired track during playback. Each time you press the button, the unit skips to the next/previous track.

A-B repeat playback

A-B repeat playback allows you to repeat material between two selected points.

1. Press REPEAT A-B to select the start point during playback. "⌚A" is displayed on TV screen and the starting point of your selected segment is set up.
2. Press REPEAT A-B again to select the end point. "⌚AB" is displayed on TV screen and the ending point is set up. Playback starts at the point that you selected. Playback stops at the end point, returns to Point A automatically, then starts again.
3. Repeatedly press REPEAT A-B again to resume normal playback. "Off" appears on the screen.

JPEG file viewing options

As a JPEG file is loaded, the table of contents appears on the TV screen. 16 slide show transition modes are available.

Picture Selection

1. Press ▲ or ▼ to select the desired picture. The selected JPEG file appears on the right side of the screen.
2. Press ENTER to enlarge the JPEG file to fill the screen.
3. Press PLAY ► again to start slide show mode. Press STOP ■ to return to the menu.

Note:

If you press ENTER while playing a JPEG disc, the picture slide show starts.

Picture transition modes

1. Press ▲ or ▼ to select the desired picture, and then press PLAY ► to start the slide show.
2. Press EXIT/CANCEL to stop the slide show.

Image Rotation

Press ▲ or ▼ to rotate a picture. There are 2 modes to rotate picture:

- ▲ : invert.
- ▼ : mirror

Image Zoom

1. Press ZOOM and use FF ►► or REV ◀◀ to see the zoom mode at 50% - 200%.
2. Adjust the picture position using ▲▼◀► while in the enlarged picture mode.
To exit Zoom mode, press ZOOM one more time.
3. Press STOP ■ to return to the menu.

Repeat playback

You can show JPEG files repeatedly.

1. Press PLAY MODE during playback. Each time you press PLAY MODE, the repeat mode changes as indicated:
Repeat One → Repeat All → Repeat Off

JPEG files compatibility

Discs and pixels whose compatibility with this player has been confirmed by TOSHIBA are as follows.

Kodak Picture CD

JPEG disc compatibility with this player is limited as follows:

- Playable discs: CD-ROM, CD-R, CD-RW
- File system: ISO9660, UDF without interleave
- File name: File names are limited to eight characters or less and must incorporate "JPG" extension.
e.g. "*****.JPG"
File names cannot contain special characters such as "?!><+*}{[@];\ /,." etc.
- File size: Less than 10M bytes
- File format: BASELINE, PROGRESSIVE
- Resolution: Baseline JPG: 3072 × 2048
Progressive JPG:
width*(height + 128) < 3300000
Files with size < 20M bytes.

Appendix

Specifications

- This model complies with the specifications listed below.
- Designs and specifications are subject to change without notice.



WARNING: RISK OF ELECTRIC SHOCK !

Never attempt to service the TV yourself. Opening and removing the covers may expose you to dangerous voltage or other hazards. Refer all servicing to a Toshiba Authorized Service Center.

Television System
NTSC standard

Channel Coverage
VHF: 2 through 13
UHF: 14 through 69
Cable TV: Mid band (A-8 through A-1, A through I)
Super band (J through W)
Hyper band (AA through ZZ, AAA, BBB)
Ultra band (65 through 94, 100 through 125)

Power Source
100-240 V AC, 60 Hz

Power Consumption
95 W (110 V AC, Vol 30, DVD Play)
0.8 W in standby mode

Audio Power
5 W + 5 W

Video/Audio Terminals
S-VIDEO INPUT
Y : 1 V(p-p), 75 ohms, negative sync.
C : 0.286 V(p-p) (burst signal), 75 ohms
VIDEO/AUDIO INPUT
VIDEO: 1 V(p-p), 75 ohms, negative sync.
AUDIO: 400 mV(rms) (30% modulation equivalent,
22k ohms or greater)
ColorStream® HD (Component video) INPUT
Y : 1V(p-p), 75 ohms
PR: 0.7 V(p-p), 75 ohms
PB: 0.7 V(p-p), 75 ohms
AUDIO: 400 mV(rms), 22k ohms or greater
Suggested resolutions: 1080i, 480p, 480i, 720p
AUDIO OUTPUT
400 mV(rms) (30% modulation equivalent,
2.2k ohms or less)

HEADPHONE jack
3.5 mm stereo mini jack
PC INPUT

15-pin D-sub Analog RGB
PC AUDIO INPUT
3.5 mm stereo mini jack

HDMI™ INPUT:
HDMI compliant (type A connector)
HDCP compliant
E-EDID* compliant
Suggested scan rates: 1080i, 480p, 480i, 720p
HDMI Audio:
2-channel PCM;
32/44.1/48 kHz sampling frequency;
16/20/24 bits per sample
Note: This TV does not provide HDMI OUTPUT.
SPDIF (digital audio output):
Optical type

Dimensions (Including TV stand)
Width : 24-3/8 inches (619 mm)
Height : 18-5/8 inches (473 mm)
Depth : 11-1/8 inches (280 mm)

Mass (weight)
29.7 lbs (13.5 kg)

Operating conditions
Temperature: 32°F – 95°F (0°C – 35°C)
Humidity: 20 – 80% (no moisture condensation)

DVD/CD Player
Signal system NTSC
Applicable disc 1. DVD (12cm, 8cm [with Disc adapter])
2. CD (12cm, 8cm [with Disc adapter])
Pickup 1-Lens, 2-Beams system

*E-EDID = Enhanced-Extended Display Identification

Troubleshooting

Before calling a service technician, please check the following table for a possible cause of the symptom and some solutions.

Symptom	Solution
TV will not turn on	<ul style="list-style-type: none">• Make sure the power cord is plugged in, then press POWER.• The remote control batteries may be dead. Replace the batteries.
No picture, no sound	<ul style="list-style-type: none">• Check the antenna/cable connections.
No sound, picture OK	<ul style="list-style-type: none">• The sound may be muted. Press VOL + –.• The station may have broadcast difficulties. Try another channel.• Make sure the MTS feature is set properly.
Poor picture, sound OK	<ul style="list-style-type: none">• Check the antenna connections.• The station may have broadcast difficulties. Try another channel.• Adjust the Picture menu.
Poor reception of broadcast channels	<ul style="list-style-type: none">• The station may have broadcast difficulties. Try another channel.• Check the antenna connections.
Black box appears on the screen	<ul style="list-style-type: none">• The closed caption feature may be set to one of the Text modes (Text1, Text2, Text3, or Text4). Turn closed captioning Off.
Unable to select a certain channel	<ul style="list-style-type: none">• The channel may be erased with the Manual programming feature.
Multiple images	<ul style="list-style-type: none">• The station may have broadcast difficulties. Try another channel.• Antenna reception may be poor. Use a highly directional outdoor antenna.
Poor color or no color	<ul style="list-style-type: none">• The station may have broadcast difficulties. Try another channel.• Adjust the Tint and/or Color in the Picture menu.
No stereo or SAP sound from a known MTS broadcast	<ul style="list-style-type: none">• Make sure the MTS feature is set properly.
The top panel buttons do not operate	<ul style="list-style-type: none">• Check the Panel lock feature.
The remote control does not operate	<ul style="list-style-type: none">• Remove all obstructions between the remote control and the remote control sensor in the TV.• The remote control batteries may be dead. Replace the batteries.

Symptom (DVD)

Solution

Playback doesn't start	<ul style="list-style-type: none">• No disc is loaded.• The disc may be dirty. Clean the disc.• The TV cannot play CD-ROMs, etc.
No picture	<ul style="list-style-type: none">• TV selector is not set correctly.
No sound	<ul style="list-style-type: none">• Make sure the input selector of the amplifier is set properly.• The TV is in the special playback mode.• Select the correct Audio Output/Input position on AV Amplifier.
Picture is distorted during fast reverse/forward playback	<ul style="list-style-type: none">• The picture will be distorted occasionally.
Stopping playback, search, slow-motion play, A-B repeat play, or changing angles, etc. cannot be performed	<ul style="list-style-type: none">• Some discs may not perform certain functions.
No on-screen display	<ul style="list-style-type: none">• Select Display On.
No surround sound	<ul style="list-style-type: none">• The setup does not match your stereo system.
The TV or remote operation key is not functioning	<ul style="list-style-type: none">• Turn off the TV and unplug the AC power cord for several is not functioning minutes, then replug it.
Playback does not start when the title is selected	<ul style="list-style-type: none">• Check the Rating Level setup.
Audio soundtrack and/or subtitle language is not changed when you play back a DVD	<ul style="list-style-type: none">• Multilingual language is not recorded on the DVD disc.
No subtitle	<ul style="list-style-type: none">• Some discs have no subtitles.• Subtitles are cleared. Press SUBTITLE.
Angle cannot be changed	<ul style="list-style-type: none">• Multi-angles are not recorded on the DVD discs.
⊙ appears on the screen	<ul style="list-style-type: none">• The function is prohibited with the TV or the disc.

Limited United States Warranty for 23" LCD TVs and 23" LCD TV/DVD Combinations ("LCD Product(s)")

Toshiba America Consumer Products, L.L.C. ("TACP") makes the following limited warranties to original consumers in the United States. THESE LIMITED WARRANTIES EXTEND TO THE ORIGINAL CONSUMER PURCHASER OR ANY PERSON RECEIVING THIS LCD PRODUCT AS A GIFT FROM THE ORIGINAL CONSUMER PURCHASER AND TO NO OTHER PURCHASER OR TRANSFEREE.

LCD PRODUCTS PURCHASED IN THE U.S.A. AND USED ANYWHERE OUTSIDE OF THE U.S.A., INCLUDING, WITHOUT LIMITATION, CANADA AND MEXICO, ARE NOT COVERED BY THESE WARRANTIES.

LCD PRODUCTS PURCHASED ANYWHERE OUTSIDE OF THE U.S.A., INCLUDING, WITHOUT LIMITATION, CANADA AND MEXICO, AND USED IN THE U.S.A., ARE NOT COVERED BY THESE WARRANTIES.

Limited One (1) Year Warranty on Parts and Labor

TACP warrants this LCD Product and its parts against defects in materials or workmanship for a period of one (1) year after the date of original retail purchase. DURING THIS PERIOD, TACP WILL, AT TACP'S OPTION, REPAIR OR REPLACE A DEFECTIVE PART WITH A NEW OR REFURBISHED PART WITHOUT CHARGE TO YOU FOR PARTS OR LABOR.

Rental Units

The warranty for LCD Product rental units begins on the date of the first rental or thirty (30) days after the date of shipment to the rental firm, whichever comes first.

Limited Warranty for Commercial Units

TACP warrants LCD Products that are sold and used for commercial purposes as follows: all parts are warranted against defects in materials or workmanship for a period of ninety (90) days after the date of original retail purchase. DURING THIS PERIOD, TACP WILL, AT TACP'S OPTION, REPAIR OR REPLACE A DEFECTIVE PART WITH A NEW OR REFURBISHED PART WITHOUT CHARGE TO YOU.

Owner's Manual and Product Registration Card

Read this owner's manual thoroughly before operating this LCD Product.

Complete and mail the enclosed product registration card or register your LCD Product online at www.tacp.toshiba.com/service as soon as possible. By registering your LCD Product you will enable TACP to bring you new products specifically designed to meet your needs and help us to contact you in the unlikely event a safety notification is required under the U.S. Consumer Product Safety Act. Failure to complete and return the product registration card does not diminish your warranty rights.

Your Responsibility

THE ABOVE WARRANTIES ARE SUBJECT TO THE FOLLOWING CONDITIONS:

- (1) You must retain your original bill of sale or provide other proof of purchase.
- (2) All warranty servicing of this LCD Product must be performed by an Authorized TACP Service Station.
- (3) The warranties from TACP are effective only if this LCD Product is purchased and operated in the Continental U.S.A. or Puerto Rico.
- (4) Labor service charges for set installation, setup, adjustment of customer controls, and installation or repair of antenna systems are not covered by this warranty. Reception problems caused by inadequate antenna systems, misaligned satellite dishes, cable television distribution, VCRs, DVD players/recorders, personal computer level IEEE-1394 devices, and any other connected signal source device are your responsibility.

- (5) Warranties extend only to defects in materials or workmanship as limited above, and do not extend to any LCD Product or parts that have been lost or discarded by you or to damage to the LCD Product or parts caused by fires, misuse, accident, Acts of God (such as lightning or fluctuations in electric power), improper installation, improper maintenance, or use in violation of instructions furnished by TACP; use or malfunction through simultaneous use of this LCD Product and connected equipment; or to units that have been modified or had the serial number removed, altered, defaced, or rendered illegible.

How to Obtain Warranty Service

If, after following all of the operating instructions in this manual and reviewing the section entitled "Troubleshooting," you find that service is needed:

- (1) To find the nearest TACP Authorized Service Station, visit TACP's website at www.tacp.toshiba.com/service or contact TACP's Consumer Solution Center toll free at 1-800-575-5469.
- (2) You must present your original bill of sale or other proof of purchase to the TACP Authorized Service Station. You must deliver the entire LCD Product to a TACP Authorized Service Station. You must pay for all transportation and insurance charges for the LCD Product to and from the TACP Authorized Service Station.

**For additional information, visit TACP's website:
www.tacp.toshiba.com**

ALL WARRANTIES IMPLIED BY THE LAW OF ANY STATE OF THE U.S.A., INCLUDING THE IMPLIED WARRANTIES OF MERCHANTABILITY AND FITNESS FOR A PARTICULAR PURPOSE, ARE EXPRESSLY LIMITED TO THE DURATION OF THE LIMITED WARRANTIES SET FORTH ABOVE. WITH THE EXCEPTION OF ANY WARRANTIES IMPLIED BY THE LAW OF ANY STATE OF THE U.S.A. AS HEREBY LIMITED, THE FOREGOING WARRANTY IS EXCLUSIVE AND IN LIEU OF ALL OTHER WARRANTIES, GUARANTEES, AGREEMENTS, AND SIMILAR OBLIGATIONS OF TACP WITH RESPECT TO THE REPAIR OR REPLACEMENT OF ANY PARTS. IN NO EVENT SHALL TACP BE LIABLE FOR CONSEQUENTIAL OR INCIDENTAL DAMAGES (INCLUDING, BUT NOT LIMITED TO, LOST PROFITS, BUSINESS INTERRUPTION, OR MODIFICATION OR ERASURE OF RECORDED DATA CAUSED BY USE, MISUSE OR INABILITY TO USE THIS LCD PRODUCT).

No person, agent, distributor, dealer, or company is authorized to change, modify, or extend the terms of these warranties in any manner whatsoever. The time within which an action must be commenced to enforce any obligation of TACP arising under the warranty or under any statute or law of the United States or any state thereof is hereby limited to ninety (90) days from the date you discover, or should have discovered, the defect. This limitation does not apply to implied warranties arising under the law of any state of the U.S.A.

THIS WARRANTY GIVES YOU SPECIFIC LEGAL RIGHTS AND YOU MAY ALSO HAVE OTHER RIGHTS WHICH MAY VARY FROM STATE TO STATE IN THE U.S.A. SOME STATES OF THE U.S.A. DO NOT ALLOW LIMITATIONS ON THE DURATION OF AN IMPLIED WARRANTY, WHEN AN ACTION MAY BE BROUGHT, OR THE EXCLUSION OR LIMITATION OF INCIDENTAL OR CONSEQUENTIAL DAMAGES. THEREFORE, THE ABOVE PROVISIONS MAY NOT APPLY TO YOU UNDER SUCH CIRCUMSTANCES.

Limited Canada Warranty

for 23" LCD TVs and 23" LCD TV/DVD Combinations ("LCD Product(s)")

Toshiba Canada Limited, ("TCL") makes the following limited warranties to original consumers in Canada. THESE LIMITED WARRANTIES EXTEND TO THE ORIGINAL CONSUMER PURCHASER OR ANY PERSON RECEIVING THIS LCD PRODUCT AS A GIFT FROM THE ORIGINAL CONSUMER PURCHASER AND TO NO OTHER PURCHASER OR TRANSFEREE.

LCD PRODUCTS PURCHASED IN CANADA AND USED ANYWHERE OUTSIDE OF CANADA, INCLUDING, WITHOUT LIMITATION, THE U.S.A. AND MEXICO, ARE NOT COVERED BY THESE WARRANTIES.

LCD PRODUCTS PURCHASED ANYWHERE OUTSIDE OF CANADA, INCLUDING, WITHOUT LIMITATION, THE U.S.A. AND MEXICO, AND USED IN CANADA ARE NOT COVERED BY THESE WARRANTIES.

Limited One (1) Year Warranty on Parts and Labour

TCL warrants this LCD Product and its parts against defects in materials or workmanship for a period of one (1) year after the date of original retail purchase. DURING THIS PERIOD, TCL WILL, AT TCL'S OPTION, REPAIR OR REPLACE A DEFECTIVE PART WITH A NEW OR REFURBISHED PART WITHOUT CHARGE TO YOU. YOU MUST DELIVER THE ENTIRE TELEVISION TO AN AUTHORIZED TCL SERVICE DEPOT. YOU MUST PAY FOR ALL TRANSPORTATION AND INSURANCE CHARGES FOR THE TELEVISION TO AND FROM THE SERVICE DEPOT.

Rental Units

The warranty for LCD Product rental units begins on the date of the first rental or thirty (30) days after the date of shipment to the rental firm, whichever comes first.

Limited Warranty for Commercial Units

TCL warrants LCD Products that are sold and used for commercial purposes as follows: all parts are warranted against defects in materials or workmanship for a period of ninety (90) days after the date of original retail purchase. DURING THIS PERIOD, TCL WILL, AT TCL'S OPTION, REPAIR OR REPLACE A DEFECTIVE PART WITH A NEW OR REFURBISHED PART WITHOUT CHARGE TO YOU. YOU MUST DELIVER THE ENTIRE TELEVISION TO AN AUTHORIZED TCL SERVICE DEPOT. YOU MUST PAY FOR ALL TRANSPORTATION AND INSURANCE CHARGES FOR THE TELEVISION TO AND FROM THE SERVICE DEPOT.

Owner's Manual and Product Registration

Read this owner's manual thoroughly before operating this LCD Product.

Register your LCD Product online at www.toshiba.ca as soon as possible. By registering your LCD Product you will enable TCL to bring you new products specifically designed to meet your needs and help us to contact you in the unlikely event a safety notification is required. Failure to register your LCD Product does not diminish your warranty rights.

Your Responsibility

THE ABOVE WARRANTIES ARE SUBJECT TO THE FOLLOWING CONDITIONS:

- (1) You must retain your original bill of sale or provide other proof of purchase.
- (2) All warranty servicing of this LCD Product must be made by an Authorized TCL Service Depot.
- (3) The warranties from TCL are effective only if this LCD Product is purchased in Canada from an authorized TCL dealer and operated in Canada.
- (4) Labour service charges for set installation, setup, adjustment of customer controls, and installation or repair of antenna

systems are not covered by this warranty. Reception problems caused by inadequate antenna systems, misaligned satellite dishes, cable television distribution, VCRs, DVD players/recorders, personal computer level IEEE-1394 devices, and any other connected signal source device are your responsibility.

- (5) Warranties extend only to defects in materials or workmanship as limited above, and do not extend to any LCD Product or parts that have been lost or discarded by you or to damage to the LCD Product or parts caused by fires, misuse, accident, Acts of God (such as lightning or fluctuations in electric power), improper installation, improper maintenance, or use in violation of instructions furnished by TCL; use or malfunction through simultaneous use of this LCD Product and connected equipment; or to units that have been modified or had the serial number removed, altered, defaced, or rendered illegible.

How to Obtain Warranty Service

If, after following all of the operating instructions in this manual and reviewing the section entitled "Troubleshooting," you find that service is needed:

- (1) To find the nearest TCL Authorized Service Depot, visit TCL's web site at www.toshiba.ca.
- (2) You must include the original bill of sale (or a copy thereof) or other proof of purchase along with the entire LCD Product to the Authorized Service Depot. You are responsible for all inbound transportation and insurance charges for the LCD Product to the Authorized Service Depot.

**For additional information, visit TCL's website:
www.toshiba.ca**

ALL WARRANTIES IMPLIED BY THE LAW OF ANY PROVINCE OF CANADA, INCLUDING THE IMPLIED WARRANTIES OF MERCHANTABILITY AND FITNESS FOR A PARTICULAR PURPOSE, ARE EXPRESSLY LIMITED TO THE DURATION OF THE LIMITED WARRANTIES SET FORTH ABOVE. WITH THE EXCEPTION OF ANY WARRANTIES IMPLIED BY THE LAW OF ANY PROVINCE OF CANADA AS HEREBY LIMITED, THE FOREGOING WARRANTY IS EXCLUSIVE AND IN LIEU OF ALL OTHER WARRANTIES, GUARANTEES, AGREEMENTS, AND SIMILAR OBLIGATIONS OF TCL WITH RESPECT TO THE REPAIR OR REPLACEMENT OF ANY PARTS. IN NO EVENT SHALL TCL BE LIABLE FOR CONSEQUENTIAL OR INCIDENTAL DAMAGES (INCLUDING, BUT NOT LIMITED TO, LOST PROFITS, BUSINESS INTERRUPTION, OR MODIFICATION OR ERASURE OF RECORDED DATA CAUSED BY USE, MISUSE, OR INABILITY TO USE THIS LCD PRODUCT).

No person, agent, distributor, dealer, or company is authorized to change, modify, or extend the terms of these warranties in any manner whatsoever. The time within which an action must be commenced to enforce any obligation of TCL arising under the warranty or under any law of Canada or any province thereof is hereby limited to ninety (90) days from the date you discover, or should have discovered, the defect. This limitation does not apply to implied warranties arising under the law of any province of Canada.

THIS WARRANTY GIVES YOU SPECIFIC LEGAL RIGHTS AND YOU MAY ALSO HAVE OTHER RIGHTS WHICH MAY VARY FROM PROVINCE TO PROVINCE IN CANADA. SOME PROVINCES OF CANADA DO NOT ALLOW LIMITATIONS ON THE DURATION OF AN IMPLIED WARRANTY, WHEN AN ACTION MAY BE BROUGHT, OR THE EXCLUSION OR LIMITATION OF INCIDENTAL OR CONSEQUENTIAL DAMAGES. THEREFORE, THE ABOVE PROVISIONS MAY NOT APPLY TO YOU UNDER SUCH CIRCUMSTANCES. [0305]

Index

A B

ANGLE button	39
Antenna cables (coaxial)	12
AUDIO SELECT button	32, 39
Audio system connection	17
Auto Configure	35
Auto off	36
A/V cables	12
Back of the TV	10
Blue screen	24

C

Cable converter box connection	13
Camcorder connection	17
CH ^ v buttons	23
CH RTN button	24
Channel Number buttons	23
Channel programming	
Automatic programming	22
Memory/Erase	23
Closed caption	30
ColorStream® connection	14, 15
Component video cables	12

D E

Digital audio system connection	17
DISPLAY button	32, 36, 38
DRC	41
DTV receiver connection	15
DVD connection	14
DVD MENU button	39
EJECT button	38

F G H I J

FAV ▲▼ button	23
Favorite channels	23
FF ►► button	38
Front of the TV	10
Full (picture size)	25
GAME button	36
HDMI connection	16
INPUT button	24
JPEG	44
JUMP button	39

L M N

Language selection	22
Last mode memory	36
MARKER button	39
Menu system	21
MP3	42
MTS	32
MUTE button	32
Natural (picture size)	25

P

Panel lock	31
PAUSE ■■ button	38
PC connection	18
PC setting	35
PIC SIZE button	25

Picture adjustments	
Picture mode	29
Picture quality	29
Picture size	25
PLAY ► button	38
PLAY MODE button	39
POWER button	19

R

Remote control	
Battery installation	20
Learning about the buttons	19
REPEAT A-B button	39
RETURN button	37
REV ◀◀ button	38

S

S-video cables	12
SAP sound	32
Set-top box	15
SETUP button	40
SKIP ►►◀◀ button	38
Sleep timer	31
SLOW ◀◀►► button	38
Sound mode selection	33
Sound quality adjustments	34
Specifications	45
StableSound®	34
Stereo sound	32
STOP ■ button	38
SUBTITLE button	40

T

TheaterWide® picture	25
TOP MENU button	39
Troubleshooting	46
TV/DVD button	37

V

V-Chip	
Age block	28
Aux block	28
Content block	28
MPAA	28
Password	28
VCD	38
VCR connection	13
VOL button	19

W

Warranty	48, 49
WMA	42
WOW™ surround	33

Z

ZOOM button	39
-------------------	----

TOSHIBA AMERICA CONSUMER PRODUCTS, L.L.C.

HEAD OFFICE:82 TOTOWA ROAD, WAYNE, NEW JERSEY 07470, U.S.A.
NATIONAL SERVICE DIVISION:1420B TOSHIBA DRIVE, LEBANON, TN. 37087, U.S.A.

TOSHIBA OF CANADA LTD.

HEAD OFFICE/191 McNABB STREET MARKHAM, ONTARIO L3R 8H2, CANADA TEL: (905) 470-5400

SERVICE CENTERS:

TORONTO: 191 McNABB STREET MARKHAM, ONTARIO L3R 8H2, CANADA TEL: (905) 470-5400

MONTREAL: 18050 TRANS CANADA, KIRKLAND, QUEBEC, H9J-4A1, CANADA TEL:(514)390-7766

VANCOUVER: 22171 FRASERWOOD WAY, RICHMOND, B.C. V6W 1J5, CANADA TEL: (604) 303-2500

ColorStream and StableSound are registered trademarks of Toshiba America Consumer Products, L.L.C.

TOSHIBA

YC/L1 72742113

Free Manuals Download Website

<http://myh66.com>

<http://usermanuals.us>

<http://www.somanuals.com>

<http://www.4manuals.cc>

<http://www.manual-lib.com>

<http://www.404manual.com>

<http://www.luxmanual.com>

<http://aubethermostatmanual.com>

Golf course search by state

<http://golfingnear.com>

Email search by domain

<http://emailbydomain.com>

Auto manuals search

<http://auto.somanuals.com>

TV manuals search

<http://tv.somanuals.com>