

# TOSHIBA



## COMBINATION FLAT COLOR TELEVISION AND VIDEO CASSETTE RECORDER / DVD VIDEO PLAYER

# MW20FN3/R MW24FN3/R

OWNER'S MANUAL

**VHS** Hi-Fi

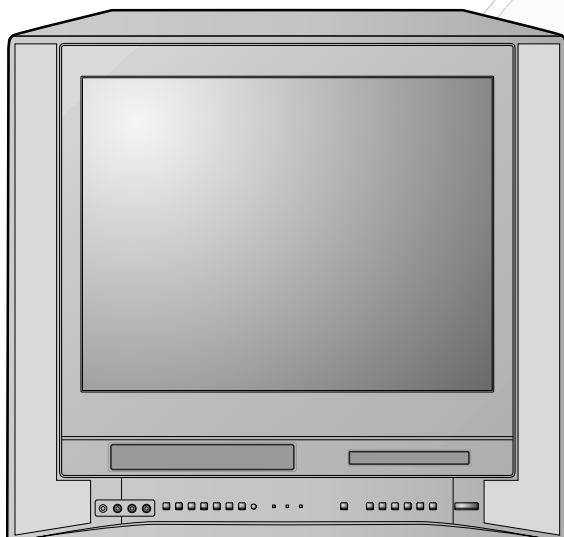

Introduction 2

Connections 14

Basic setup 19

TV operation 23

Playback (VCR) 35

Recording (VCR) 40

Other functions (VCR) 45

Basic playback (DVD) 49

Advanced playback (DVD) 52

Function setup (DVD) 56

Others 62

# IMPORTANT SAFEGUARDS



The lightning flash with arrowhead symbol, within an equilateral triangle is intended to alert the user to the presence of uninsulated dangerous voltage within the product's enclosure that may be of sufficient magnitude to constitute a risk of electric shock to persons.



The exclamation point within an equilateral triangle is intended to alert the user to the presence of important operating and maintenance (servicing) instructions in the literature accompanying the appliance.

**WARNING:** TO REDUCE THE RISK OF FIRE OR ELECTRIC SHOCK, do not expose this appliance to rain or moisture.

**WARNING:** This equipment has been tested and found to comply with the limits for a Class B digital device, pursuant to Part 15 of the FCC Rules. These limits are designed to provide reasonable protection against harmful interference in a residential installation. This equipment generates, uses and can radiate radio frequency energy and, if not installed and used in accordance with the instructions, may cause harmful interference to radio communications. However, there is no guarantee that interference will not occur in a particular installation. If this equipment does cause harmful interference to radio or television reception, which can be determined by turning the equipment off and on, the user is encouraged to try to correct the interference by one or more of the following measures:

- Reorient or relocate the receiving antenna.
- Increase the distance between the equipment and receiver.
- Connect the equipment into an outlet on a circuit different from that to which the receiver is connected.
- Consult the dealer or an experienced radio/TV technician for help.

**CAUTION:** Changes or modifications not expressly approved by the party responsible for compliance with the FCC (Federal Communications Commission) Rules could void the user's authority to operate this equipment.

**CAUTION:** THIS DIGITAL VIDEO PLAYER EMPLOYS A LASER SYSTEM.

TO ENSURE PROPER USE OF THIS PRODUCT, PLEASE READ THIS USER'S GUIDE CAREFULLY AND RETAIN FOR FUTURE REFERENCE. SHOULD THE UNIT REQUIRE MAINTENANCE, CONTACT AN AUTHORIZED SERVICE LOCATION-SEE SERVICE PROCEDURE.

USE OF CONTROLS, ADJUSTMENTS OR THE PERFORMANCE OF PROCEDURES OTHER THAN THOSE SPECIFIED HEREIN MAY RESULT IN HAZARDOUS RADIATION EXPOSURE.

TO PREVENT DIRECT EXPOSURE TO LASER BEAM, DO NOT TRY TO OPEN THE ENCLOSURE. VISIBLE LASER RADIATION MAY BE PRESENT WHEN THE ENCLOSURE IS OPENED. DO NOT STARE INTO BEAM.

**COPYRIGHT:** It is permissible to record television programs, films, video tapes and other material only in the event that third party copyrights and other rights are not violated.

## Location of the required Marking

The rating sheet and the safety caution are on the rear of the unit.

CERTIFICATION: COMPLIES WITH FDA RADIATION PERFORMANCE STANDARDS, 21 CFR SUBCHAPTER J.

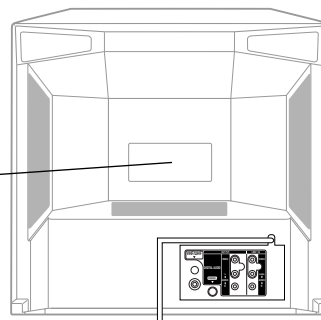

# IMPORTANT SAFEGUARDS

## 1. READ INSTRUCTIONS

All the safety and operating instructions should be read before the unit is operated.

## 2. RETAIN INSTRUCTIONS

The safety and operating instructions should be retained for future reference.

## 3. HEED WARNINGS

All warnings on the unit and in the operating instructions should be adhered to.

## 4. FOLLOW INSTRUCTIONS

All operating and use instructions should be followed.

## 5. CLEANING

Unplug this unit from the wall outlet before cleaning. Do not use liquid cleaners or aerosol cleaners. Use a damp cloth for cleaning.

## 6. ATTACHMENTS

Do not use attachments not recommended by the unit's manufacturer as they may cause hazards.

## 7. WATER AND MOISTURE

Do not use this unit near water. For example, near a bathtub, washbowl, kitchen sink, or laundry tub, in a wet basement, or near a swimming pool.

## 8. ACCESSORIES

Do not place this unit on an unstable cart, stand, tripod, bracket, or table. The unit may fall, causing serious injury, and serious damage to the unit. Use only with a cart, stand, tripod, bracket, or table recommended by the manufacturer.

- 8A.** An appliance and cart combination should be moved with care. Quick stops, excessive force, and uneven surfaces may cause the appliance and cart combination to overturn.

## 9. VENTILATION

Slots and openings in the cabinet and in the back or bottom are provided for ventilation, and to ensure reliable operation of the unit, and to protect it from overheating. These openings must not be blocked or covered. The openings should never be blocked by placing the unit on a bed, sofa, rug, or other similar surface. This unit should never be placed near or over a radiator or heat source. This unit should not be placed in a built-in installation such as a bookcase or rack unless proper ventilation is provided or the manufacturer's instructions have been adhered to.

## 10. POWER SOURCES

This unit should be operated only from the type of power source indicated on the rating plate. If you are not sure of the type of power supply to your home, consult your appliance dealer or local power company. For units intended to operate from battery power, or other sources, refer to the respective pages on this Owner's Manual for their operating instructions.

## 11. GROUNDING OR POLARIZATION

This unit is equipped with a polarized alternating-current line plug (a plug having one blade wider than the other). This plug will fit into the power outlet only one way. This is a safety feature. If you are unable to insert the plug fully into the outlet, try reversing the plug. If the plug should still fail to fit, contact your electrician to replace your obsolete outlet. Instead of the polarized alternating-current line plug, your unit may be equipped with a 3-wire grounding-type plug (a plug having a third (grounding) pin). This plug will only fit into a grounding-type power outlet. This too, is a safety feature. If you are unable to insert the plug into the outlet, contact your electrician to replace your obsolete outlet.

Do not defeat the safety purpose of the grounding-type plug.

## 12. POWER-CORD PROTECTION

Power-supply cords should be routed so that they are not likely to be walked on or pinched by items placed upon or against them, paying particular attention to cords at plugs, convenience receptacles, and the point where they exit from the appliance.

## 13. LIGHTNING

To protect your unit from a lightning storm, or when it is left unattended and unused for long periods of time, unplug it from the wall outlet and disconnect the antenna or cable system. This will prevent damage to the unit due to lightning and power line surges.

PORTABLE CART WARNING  
(symbol provided by RETAC)



S3126A

# IMPORTANT SAFEGUARDS

## 14. POWER LINES

An outside antenna system should not be located in the vicinity of overhead power lines or other electric light or power circuits, or where it can fall onto or against such power lines or circuits. When installing an outside antenna system, extreme care should be taken to keep from touching such power lines or circuits, as contact with them might be fatal.

## 15. OVERLOADING

Do not overload wall outlets and extension cords, as this can result in a risk of fire or electric shock.

## 16. OBJECT AND LIQUID ENTRY

Do not push objects through any openings in this unit, as they may touch dangerous voltage points or short out parts that could result in fire or electric shock. Never spill or spray any type of liquid into the unit.

## 17. OUTDOOR ANTENNA GROUNDING

If an outside antenna or cable system is connected to the unit, be sure the antenna or cable system is grounded so as to provide some protection against voltage surges and built-up static charges, Section 810 of the National Electrical Code (NEC), ANSI/NFPA 70, provides information with respect to proper grounding of the mast and supporting structure, grounding of the lead-in wire to an antenna discharge unit, size of grounding conductors, location of antenna discharge unit, connection to grounding electrodes, and requirements for the grounding electrode.

## 18. SERVICING

Do not attempt to service this unit yourself as opening or removing covers may expose you to dangerous voltage or other hazards. Refer all servicing to qualified service personnel.

For example:

- a. When the power-supply cord or plug is damaged.
- b. If liquid has been spilled, or objects have fallen into the unit.
- c. If the unit has been exposed to rain or water.
- d. If the unit does not operate normally by following the operating instructions. Adjust only those controls that are covered by the operating instructions, as an improper adjustment of other controls may result in damage and will often require extensive work by a qualified technician to restore the unit to its normal operation.
- e. If the unit has been dropped or the cabinet has been damaged.
- f. When the unit exhibits a distinct change in performance, this indicates a need for service.

## 19. REPLACEMENT PARTS

When replacement parts are required, be sure the service technician uses replacement parts specified by the manufacturer or those that have the same characteristics as the original part.

Unauthorized substitutions may result in fire, electric shock or other hazards.

## 20. SAFETY CHECK

Upon completion of any service or repairs to this unit, ask the service technician to perform safety checks to determine that the unit is in proper operating condition.

## 21. WALL OR CEILING MOUNTING

The product should be mounted to a wall or ceiling only as recommended by the manufacturer.

## 22. HEAT

The product should be situated away from heat sources such as radiators, heat registers, stoves, or other products (including amplifiers) that produce heat.

## 23. DISC TRAY

Keep your fingers well clear of the disc tray as it is closing. It may cause serious personal injury.

## 24. CONNECTING

When you connect the product to other equipment, turn off the power and unplug all of the equipment from the wall outlet. Failure to do so may cause an electric shock and serious personal injury. Read the owner's manual of the other equipment carefully and follow the instructions when making any connections.

## 25. LASER BEAM

Do not look into the opening of the disc tray or ventilation opening of the product to see the source of the laser beam. It may cause sight damage.

## 26. DISC

Do not use a cracked, deformed, or repaired disc. These discs are easily broken and may cause serious personal injury and product malfunction.

# IMPORTANT SAFEGUARDS / Power Source

## 27. NOTE TO CATV SYSTEM INSTALLER

This reminder is provided to call the CATV system installer's attention to Article 820-40 of the NEC that provides guidelines for proper grounding and, in particular, specifies that the cable ground shall be connected to the grounding system of the building, as close to the point of cable entry as practical.

### EXAMPLE OF ANTENNA GROUNDING AS PER THE NATIONAL ELECTRICAL CODE

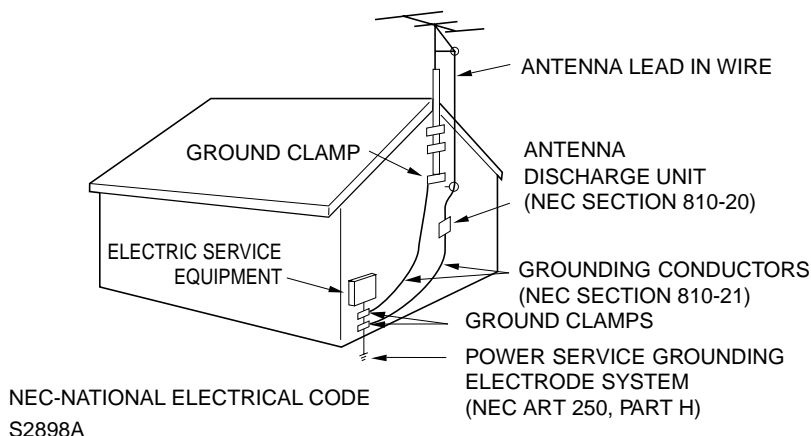

## IMPORTANT RECYCLING INFORMATION

This product uses both Cathode Ray Tube (CRT) and other components that contain lead. In your community there might be regulations that require you to dispose these materials properly under environmental considerations. Please contact your local authorities, or the Electronic Industries Alliance (<http://www.eiae.org>) for disposal or recycling information.

## Power source

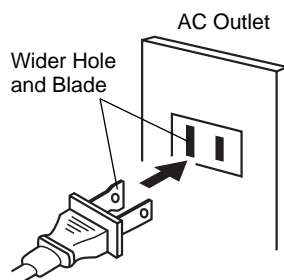

Polarized AC Cord Plug  
(One blade is wider than the other.)

### TO USE AC POWER SOURCE

Use the AC polarized line cord provided for operation on AC. Insert the AC cord plug into a standard 120V 60Hz polarized AC outlet.

#### Notes:

- Never connect the AC line cord plug to other than the specified voltage (120V 60Hz). Use the attached power cord only.
- If the polarized AC cord does not fit into a non-polarized AC outlet, do not attempt to file or cut the blade. It is the user's responsibility to have an electrician replace the obsolete outlet.
- If you cause a static discharge when touching the unit and the unit fails to function, simply unplug the unit from the AC outlet and plug it back in. The unit should return to normal operation.
- If the AC cord plug is plugged in for the first time, wait for about 5 seconds before pressing the power button on the front panel.

## Precautions

### Notes on handling

- When shipping the unit, the original shipping carton and packing materials come in handy. For maximum protection, repack the unit as it was originally packed at the factory.
- Do not use volatile liquids, such as insect spray, near the unit. Do not leave rubber or plastic products in contact with the unit for a long time. They will leave marks on the finish.
- The top and rear panels of the unit may become warm after a long period of use. This is not a malfunction.
- When the unit is not in use, be sure to remove the disc and the video cassette turn off the power.
- If you do not use the unit for a long period, the unit may not function properly in the future. Turn on and use the unit occasionally.

### Notes on locating

- Place the unit on a level surface. Do not use it on a shaky or unstable surface such as a wobbling table or inclined stand. The loaded disc or the video tape may come off the proper position and cause damage to the unit.
- When you place this unit near a TV, radio, or VCR, the playback picture may become poor and the sound may be distorted. In this case, place the unit away from the TV, radio, or VCR.

### Notes on cleaning

Use a soft, dry cloth for cleaning.

- For stubborn dirt, soak the cloth in a weak detergent solution, wring well and wipe. Use a dry cloth to wipe it dry.
- Do not use any type of solvent, such as thinner and benzene, as they may damage the surface of the unit.
- If you use a chemical saturated cloth to clean the unit, follow that product's instructions.

### To obtain a clear picture

The unit is a high technology, precision device. If the video head, the head drum, the optical pick-up lens and disc drive parts are dirty or worn down, the picture quality becomes poor. To obtain a clear picture, we recommend regular inspection and maintenance (cleaning or parts replacement) every 1,000 hours of use depending on the operating environment. For details, contact your nearest dealer.

### Notes on moisture condensation

**Moisture condensation damages the unit. Please read the following carefully.**

Moisture condensation occurs, for example, when you pour a cold drink into a glass on a warm day. Drops of water form on the outside of the glass. In the same way, moisture may condense on the head drum or the optical pick-up lens inside this unit, one of the most crucial internal parts of the unit.

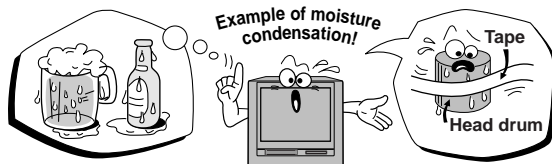

■ **Moisture condensation occurs during the following cases.**

- When you bring the unit directly from a cold place to a warm place.
- When you use the unit in a room where you just turned on the heater, or a place where the cold wind from the air conditioner directly hits the unit.
- In summer, when you use the unit in a hot and humid place just after you move the unit from an air conditioned room.
- When you use the unit in a humid place.

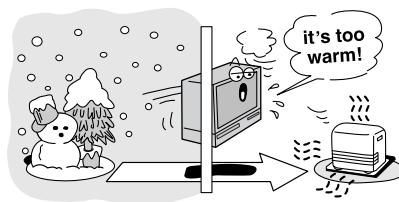

■ **Do not use the unit when moisture condensation may occur.**

If you use the unit in such a situation, it may damage discs and internal parts. Remove the disc or the video tape, connect the power cord of the unit to the wall outlet, turn on the unit, and leave it for two or three hours. After two or three hours, the unit will have warmed up and evaporated any moisture. Keep the unit connected to the wall outlet and moisture condensation will seldom occur.

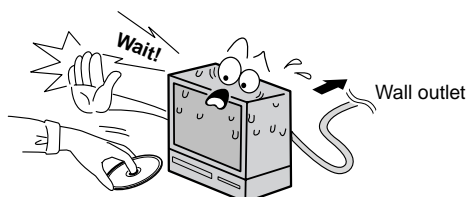

# Notes on discs

## On handling discs

- Do not touch the playback side of the disc.

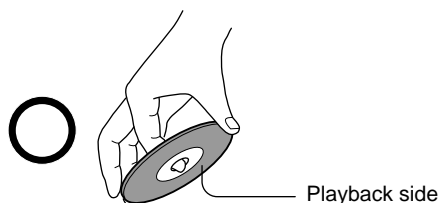

- Do not attach paper or tape to discs.



## On cleaning discs

- Fingerprints and dust on the disc cause picture and sound deterioration. Wipe the disc from the center outwards with a soft cloth. Always keep the disc clean.

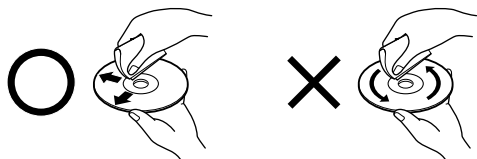

- If you cannot wipe off the dust with a soft cloth, wipe the disc lightly with a slightly moistened soft cloth and finish with a dry cloth.
- Do not use any type of solvent such as thinner, benzine, commercially available cleaners or antistatic spray for vinyl LPs. It may damage the disc.

## On storing discs

- Do not store discs in a place subject to direct sunlight or near heat sources.
- Do not store discs in places subject to moisture and dust such as a bathroom or near a humidifier.
- Store discs vertically in a case. Stacking or placing objects on discs outside of their case may cause warping.

## Structure of disc contents

Normally, DVD video discs are divided into titles, and the titles are sub-divided into chapters. Video CDs and Audio CDs are divided into tracks.

DVD video disc

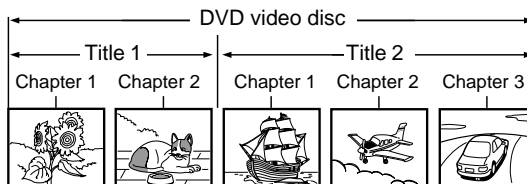

Video CD/Audio CD

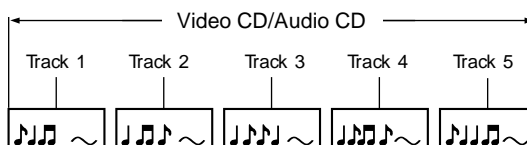

Each title, chapter or track is assigned a number, which is called "title number", "chapter number" or "track number" respectively.

There may be discs that do not have these numbers.

## Notes on copyright

It is forbidden by law to copy, broadcast, show, broadcast on cable, play in public, and rent copyrighted material without permission.

This device does not tape-record copy protected DVD Video Discs.

The device is not to be used for copying copyrighted content without the express written permission of the copyright owner.

Obtaining such permission is the sole responsibility of the user.

This product incorporates copyright protection technology that is protected by method claims of certain U.S. patents and other intellectual property rights owned by Macrovision Corporation and other rights owners. Use of this copyright protection technology must be authorized by Macrovision Corporation, and is intended for home and other limited viewing uses only unless otherwise authorized by Macrovision Corporation. Reverse engineering or disassembly is prohibited.



## Notes on discs (continued)

### About this owner's manual

This owner's manual explains the basic instructions of this unit. Some DVD video discs are produced in a manner that allows specific or limited operation during playback. As such, the unit may not respond to all operating commands. This is not a defect in the unit. Refer to instruction notes of discs.

"⊘" may appear on the TV screen during operation. A "⊘" means that the operation is not permitted by the unit or the disc at the moment. For example, it is unable to stop the playback of copyright message of the disc when the STOP (■) button is pressed. Alternatively, the "⊘" may also indicate that the feature is not available for the disc.

### Notes on region numbers

The region number of this unit is 1. If region numbers, which stand for their playable area, are printed on your DVD video disc and you do not find  or , disc playback will not be allowed by the player. (In this case, the unit will display a message on-screen.)

### On Video CDs

This unit supports Video CDs equipped with the PBC (Version 2.0) function. (PBC is the abbreviation of Playback Control.) You can enjoy two playback variations depending on types of discs.

- **Video CD not equipped with PBC function (Version 1.1)**  
Sound and movie can be played on this unit in the same way as an audio CD.
- **Video CD equipped with PBC function (Version 2.0)**  
In addition to operation of a Video CD not equipped with the PBC function, you can enjoy playback of interactive software with search function by using the menu displayed on the TV screen (Menu Playback). Some of the functions described in this owner's manual may not work with some discs.

### Playable discs

This unit can play the following discs.

	Disc Mark	Contents	Disc Size	Maximum playback time
DVD video discs		Audio + Video (moving pictures)	12 cm	Approx. 4 hours (single sided disc)
				Approx. 8 hours (double sided disc)
			8 cm	Approx. 80 minutes (single sided disc)
				Approx. 160 minutes (double sided disc)
Video CDs		Audio + Video (moving pictures)	12 cm	Approx. 74 minutes
			8 cm	Approx. 20 minutes
Audio CDs		Audio	12 cm	Approx. 74 minutes
			8 cm (CD single)	Approx. 20 minutes

The following discs are also available.

- CD-R
  - CD-RW
- CD-R/RW discs recorded by CD-DA method can be played. Some CD-R/RW discs may be incompatible.
- You cannot play discs other than those listed above.
  - You cannot play discs of DVD-RAM, DVD-RW, etc., or non standardized discs even if they may be labeled as above.
  - This unit uses the NTSC color system, and cannot play DVD video discs recorded in any other color system (PAL, SECAM, etc.).



# Contents

## Introduction

IMPORTANT SAFEGUARDS .....	2
Power source .....	5
Precautions .....	6
Notes on discs .....	7
Contents .....	9
Identification of Controls .....	10

## Connections

Antenna connections .....	14
Cable TV connections .....	15
Connecting to optional equipment .....	16

## Basic setup

Setting the language .....	19
Clock setting .....	20

## TV operation

TV operation .....	23
Tuner setting .....	26
Setting the V-Chip .....	28
To set the on timer .....	31
To set the off timer .....	32
Picture control adjustment .....	33
Sound control adjustment .....	34

## Playback (VCR)

Loading and unloading a cassette tape .....	35
Cassette tape playback .....	36
Special playback .....	37
Convenient function .....	38

## Recording (VCR)

Recording a TV program .....	40
One-touch Timer Recording (OTR) .....	42
Timer recording .....	43

## Other functions (VCR)

Setting the surround sound/ Setting the stable sound .....	45
Second Audio Program (SAP)/ Stereo recording and playback .....	46
Duplicating a video tape .....	47
Recording a DVD/CD disc .....	48

## Basic playback (DVD)

Preparation .....	49
Playback procedure .....	50
Special playback .....	51

## Advanced playback (DVD)

Zooming/Locating desired scene .....	52
Repeat, Random and Program playback/ Repeat A-B .....	53
Changing soundtrack language/Subtitles .....	54
Changing angles/Title selection/DVD menu ...	55

## Function setup (DVD)

Setting language .....	56
Setting the aspect ratio of TV screen/ Setting on screen display .....	57
Dynamic Range Control .....	58
Parental control setting .....	59
To change the parental level .....	60
Temporary disabling of rating level by DVD disc .....	61

## Others

Before calling service personnel .....	62
Reception disturbances .....	64
Language code list .....	65
Specifications .....	66
Limited warranty .....	67

# Identification of Controls

See the page in  for details.

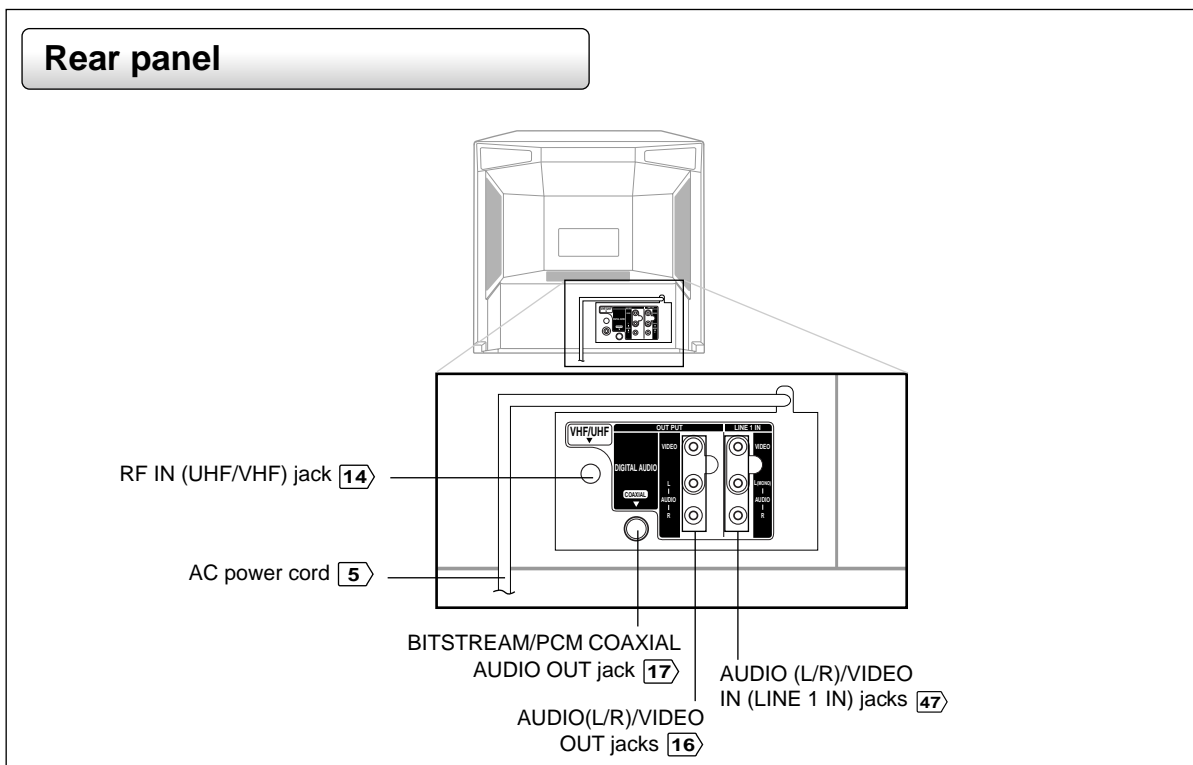
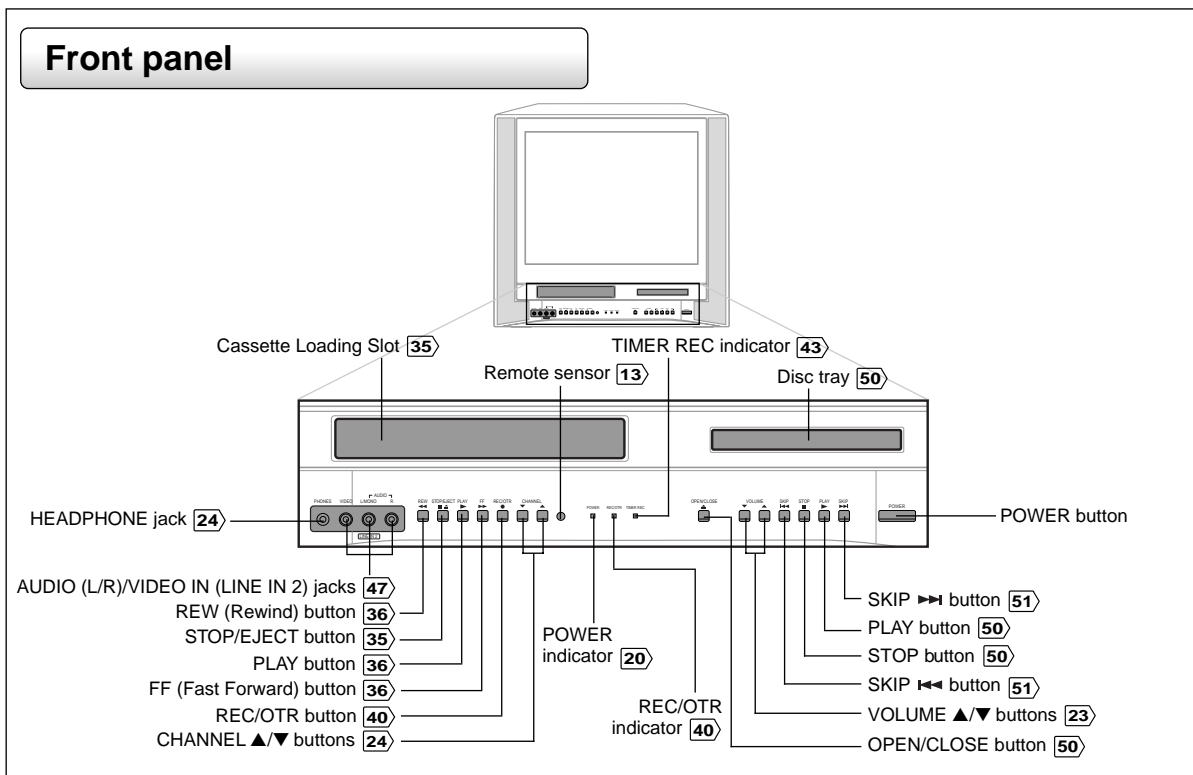

## TV/VCR operation status

Press **DISPLAY** to display the information on the screen.  
To cancel the display, press **DISPLAY** again.

### While watching TV

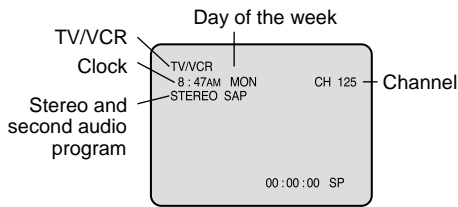

### While operating a tape

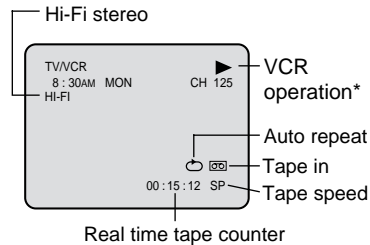

### VCR operation\*

- Recording : ●
- Rec/Pause : ||
- Play : ▶
- Fast-forward : ►►
- Rewind : ◀◀
- Stop : ■
- Eject : ▲

## DVD/Audio CD/Video CD operation status

### DVD

Press **DISPLAY** to display the information on the screen.  
To cancel the display, press **DISPLAY** again.

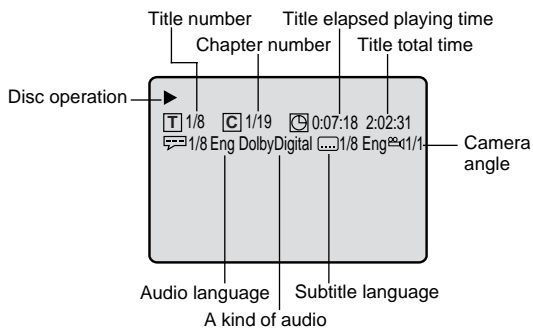

### Audio CD/Video CD

When you play the CD disc, the status display will appear on the screen and continue displaying.

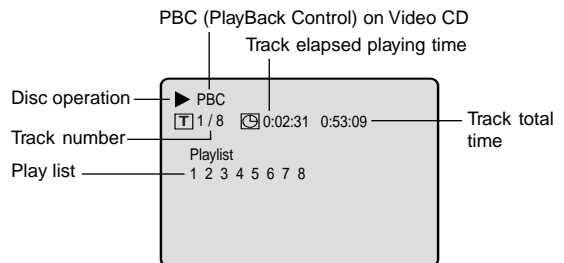

- Notes:**
- When you play the Video CD, Play list will not appear on the screen.
  - To turn off the PBC, press **Number button 1** in the stop mode, then press **ENTER**.

# Identification of Controls (continued)

The instructions in this manual describe the functions on the remote control. See the page in   for details.

## Remote control

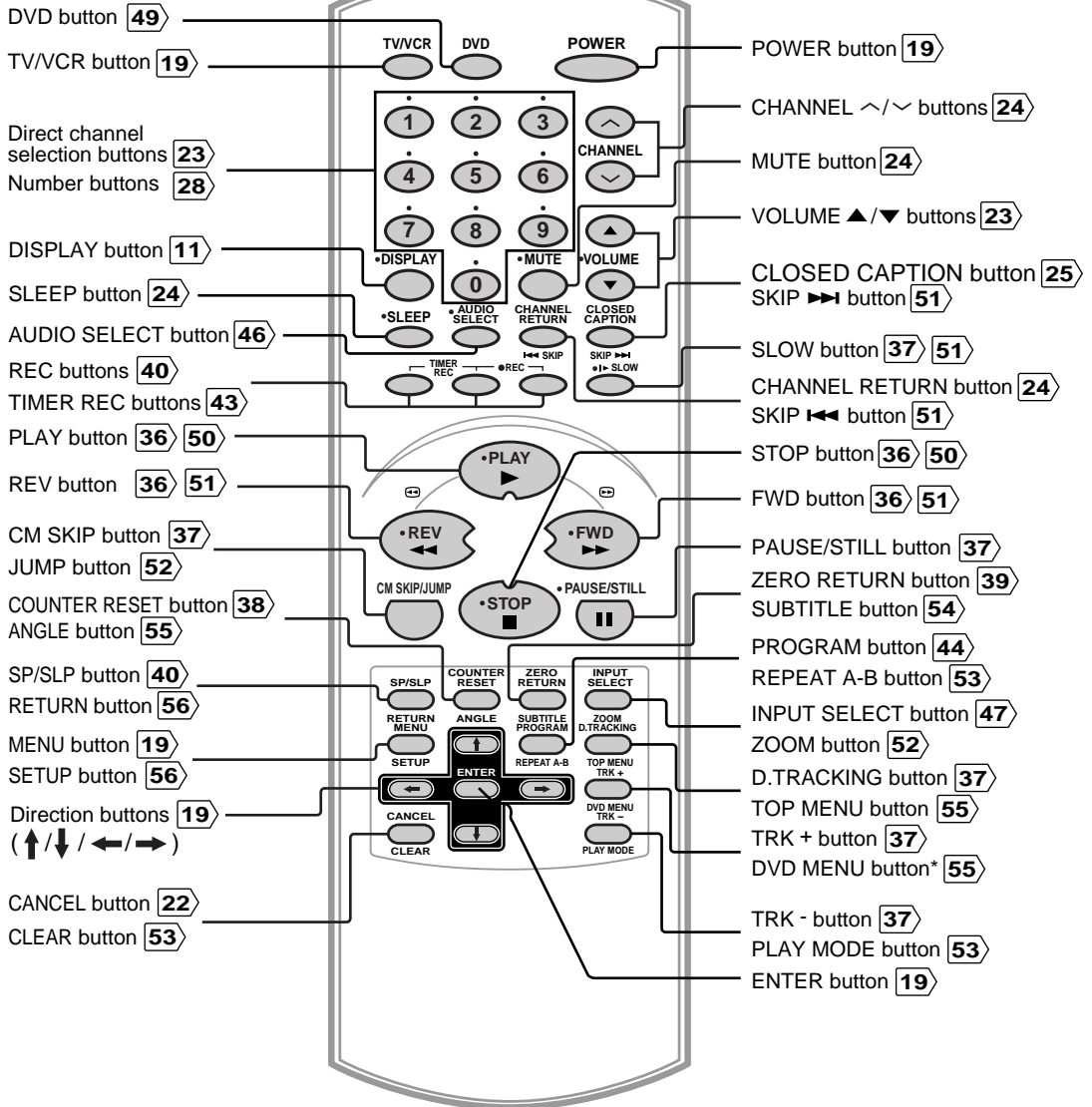

**\* DVD MENU button**  
 Use the MENU button to display the menu included on many DVD video discs. To operate a menu, follow the instructions in "DVD menu". 55

## Inserting Batteries

- 1** Slide the battery compartment cover in the direction of the arrow.

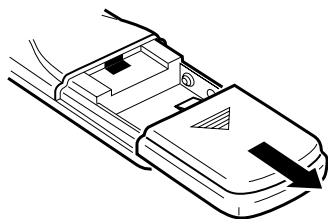

- 2** Install two "AAA" batteries (supplied), paying attention to the polarity diagram in the battery compartment.

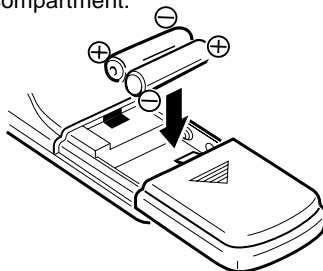

- 3** Replace the compartment cover.

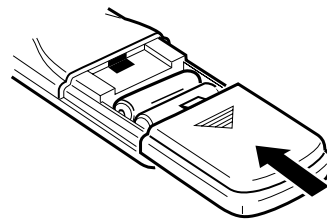

### Battery precautions:

The precautions below should be followed when using batteries in this device:

1. Use only the size and type of batteries specified.
2. Be sure to follow the correct polarity when installing the batteries as indicated in the battery compartment. Reversed batteries may cause damage to the device. To avoid a potential short circuit, insert the "-" end first.
3. Do not mix different types of batteries together (e.g. Alkaline and Carbon-zinc) or old batteries with fresh ones.
4. If the device is not to be used for a long period of time, remove the batteries to prevent damage or injury from possible battery leakage.
5. Do not try to recharge batteries not intended to be recharged; they can overheat and rupture. (Follow battery manufacturer's directions.)

## Remote control basics

- Press **POWER** to turn the unit on or off.
- Select your desired operating mode (TV/VCR or DVD) using **TV/VCR** or **DVD**.
- Tap **CH ^** or **CH v** to move through the channels one channel at a time.
- The **Direction** buttons (**↑/↓/←/→**) are also used to navigate on-screen menu system.
- You can directly access specific channels using **Direct channel selection** buttons.

### Operation:

- Aim the remote control at the remote sensor and press control buttons to operate.
- Operate the remote control within 30° angle on either side of the remote sensor, up to a distance of Approx. 7 meters.

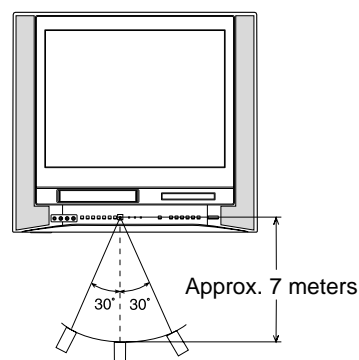



## Antenna connections

If you are using an indoor or outdoor antenna, follow the instructions below that correspond to your antenna system. If you are using a cable TV service (CATV), see page 15 for Cable TV connections.

### Combination VHF/UHF Antenna (Single 75 ohm Cable or 300 ohm Twin-lead Wire)

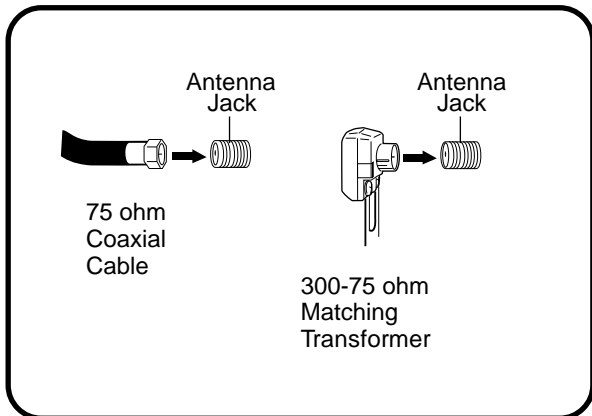

Connect the 75 ohm Cable from the Combination VHF/UHF Antenna to the Antenna Jack.

If your Combination VHF/UHF Antenna has a 300 ohm Twin-lead Wire, the use of the 300-75 ohm Matching Transformer may be necessary.

### Combination VHF/UHF Antenna (Separate VHF and UHF 300 ohm Twin-lead Wires)

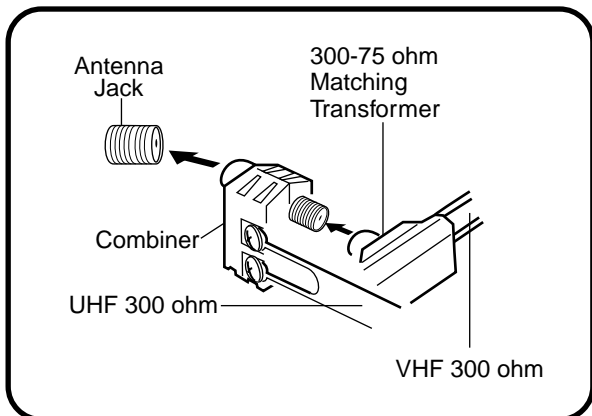

Connect the UHF 300 ohm Twin-lead Wire to the Combiner (not supplied). Connect the VHF 300 ohm Twin-lead Wire to the 300-75 ohm Matching Transformer. Attach the Transformer to the Combiner, then attach the Combiner to the Antenna Jack.

### Separate VHF/UHF Antennas (75 ohm VHF Cable and 300 ohm UHF Twin-lead Wires)

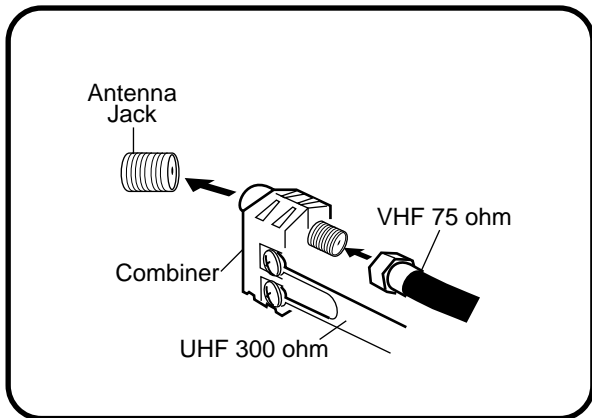

Connect the VHF 75 ohm cable and UHF 300 ohm Twin-lead Wire to the Combiner (not supplied). Attach the Combiner to the Antenna Jack.

# Cable TV Connections

This unit has an extended tuning range and can tune most cable channels without using a Cable TV Converter box. Some cable companies offer "premium pay channels" in which the signal is scrambled. Descrambling these signals for normal viewing requires the use of a descrambler device which is generally provided by the cable company.

## For subscriber to basic cable TV service

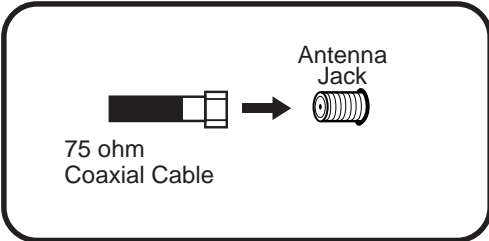

For basic cable service not requiring a Converter/Descrambler box, connect the CATV 75 ohm Coaxial Cable directly to the Antenna Jack on the back of the unit.

## For subscriber to scrambled cable TV service

If you subscribe to a cable TV service which requires the use of a Converter/Descrambler box, connect the incoming 75 ohm Coaxial Cable to the Converter/Descrambler box. Using another 75 ohm Coaxial Cable, connect the output jack of the Converter/Descrambler box to the Antenna Jack on the unit. Follow the connections shown below. Tune the unit to the output channel of the Converter/Descrambler box (usually channel 3 or 4) and use the Converter/Descrambler box to select channels.

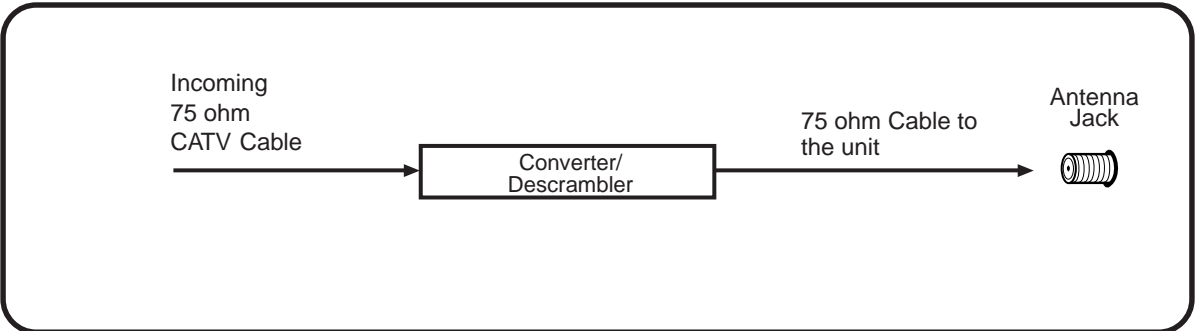

## For subscribers to unscrambled basic cable TV service with scrambled premium channels

If you subscribe to a cable TV service in which basic channels are unscrambled and premium channels require the use of a Converter/Descrambler box, you may wish to use a signal Splitter and an A/B Switch box (available from the Cable company or an electronics supply store). Follow the connections shown below. With the switch in the "B" position, you can directly tune any unscrambled channels on your unit. With the switch in the "A" position, tune your unit to the output of the Converter/Descrambler box (usually channel 3 or 4) and use the Converter/Descrambler box to tune scrambled channels.

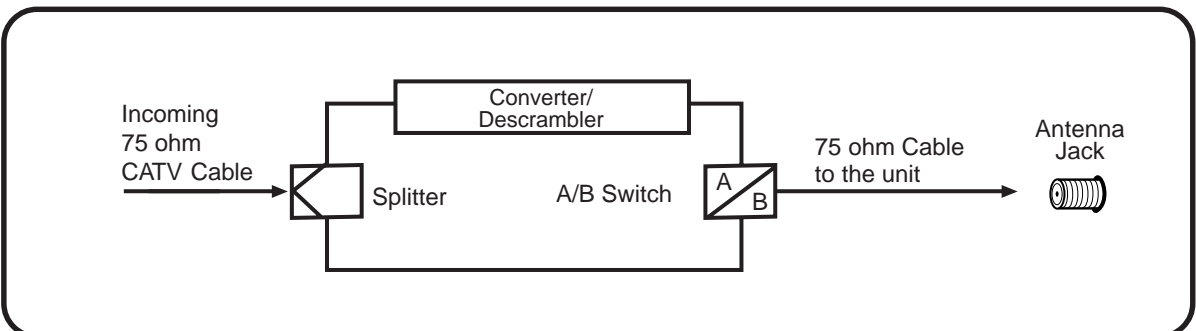

## Connecting to optional equipment

Before connecting the unit to other equipment, be sure to turn off the power and unplug all of the equipment from the wall outlet before making any connections.

You can enjoy the TV game, camcorder or high quality dynamic sounds of DVD video discs or audio CDs by connecting the unit to optional audio equipment.

### Connecting a camcorder or a TV game

Select "LINE 2" using the INPUT SELECT button.

➔ Signal flow

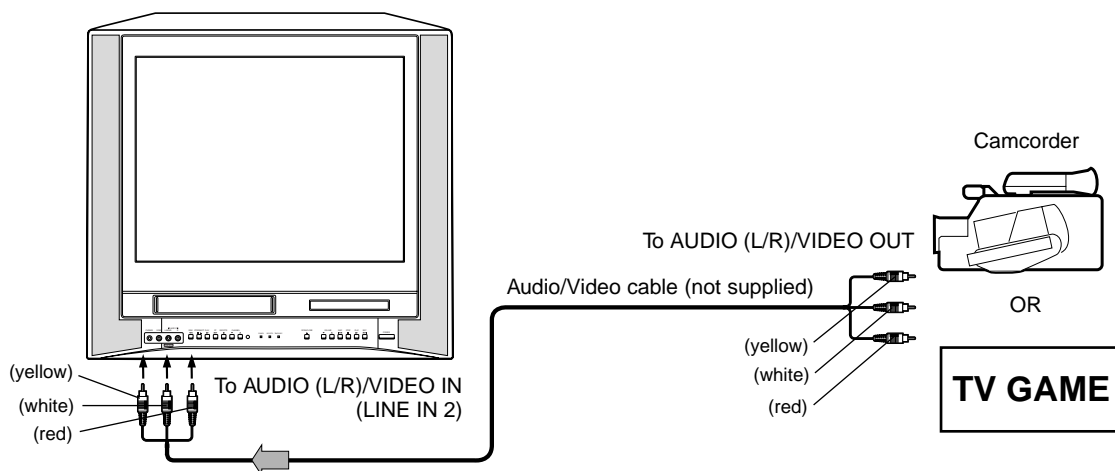

### Connecting to an audio system

Connect the unit to your audio system.

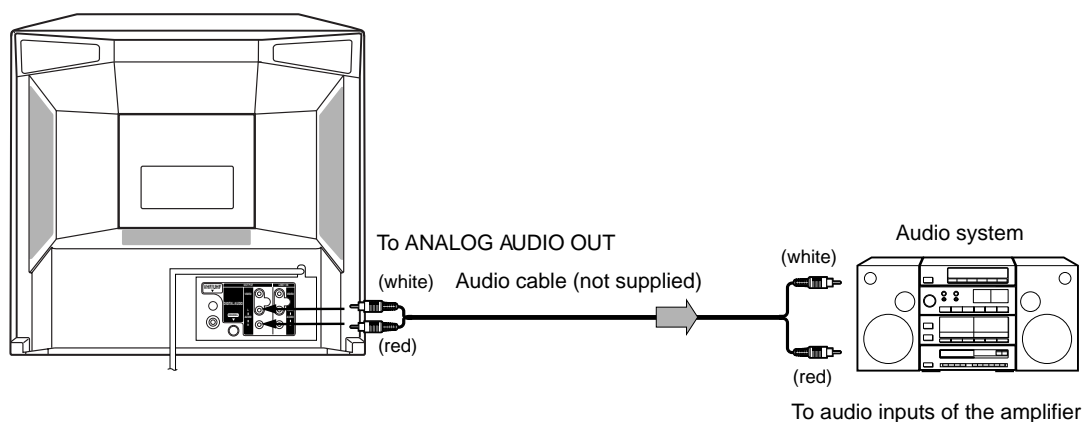

#### Notes:

- Refer to the owner's manual of the connected equipment as well.
- If you place the unit near a tuner or radio, the radio broadcast sound might be distorted. In this case, place the unit away from the tuner and radio.
- The output sound of the unit has a wide dynamic range. Be sure to adjust the receiver's volume to a moderate listening level. Otherwise, the speakers may be damaged by a sudden high volume sound.
- Turn off the amplifier before you connect or disconnect the unit's power cord. If you leave the amplifier power on, the speakers may be damaged.





## Connecting to an amplifier equipped with a Dolby Digital decoder

**Dolby Digital**

Dolby Digital is the surround sound technology used in theaters showing the latest movies, and is now available to reproduce this realistic effect in the home. You can enjoy motion picture and live concert DVD video discs with this dynamic realistic sound by connecting the unit to a 6 channel amplifier equipped with a Dolby Digital decoder or Dolby Digital processor. If you have a Dolby Pro Logic Surround decoder, you will obtain the full benefit of Pro Logic from the same DVD movies that provide full 5.1 channel Dolby Digital soundtracks, as well as from titles with the Dolby Surround mark.

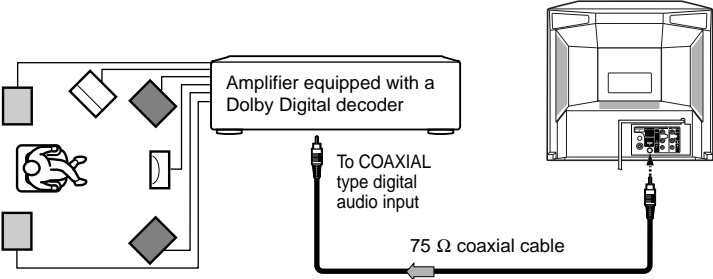

Manufactured under license from Dolby Laboratories. "Dolby" "Pro Logic" and the double-D symbol are trademarks of Dolby Laboratories. Confidential unpublished works. ©1992-1997 Dolby Laboratories. All rights reserved.

- Use DVD video discs encoded via the Dolby Digital recording system.

## Connecting to an amplifier equipped with Dolby Pro Logic Surround

**Dolby Pro Logic Surround**

You can enjoy the dynamic realistic sound of Dolby Pro Logic Surround by connecting an amplifier and speaker system (right and left front speakers, a center speaker, and one or two rear speakers).

- With an amplifier equipped with Dolby Digital  
Connect the equipment the same way as described in "Connecting to an amplifier equipped with a Dolby Digital decoder." Refer to that amplifier's owner's manual and set the amplifier so you can enjoy Dolby Pro Logic Surround sound.
- With an amplifier not equipped with Dolby Digital Connect the equipment as follows.

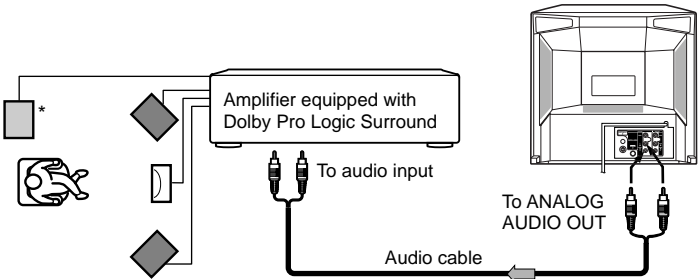

\* Connect one or two rear speakers. The output sound from the rear speakers will be monaural even if you connect two rear speakers.

## Connecting to an amplifier equipped with a DTS decoder

**Digital Theater Systems (DTS)**

DTS is a high quality surround technology used in theaters and now available for home use, on DVD video discs or audio CDs. If you have a DTS decoder or processor, you can obtain the full benefit of 5.1 channel DTS encoded sound tracks on DVD video discs or audio CDs.

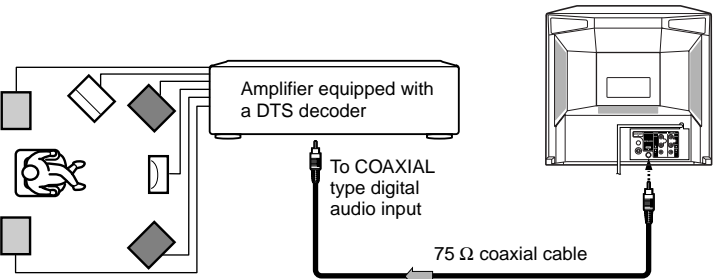

"DTS" and "DTS Digital Surround" are trademarks of Digital Theater Systems, Inc.

- Use DVD video discs or audio CDs encoded via the DTS recording system.

**Warning:**

When playing DTS-encoded discs (unit), excessive noise may be output from the analog stereo jacks. To avoid possible damage to the audio system, you should take proper precautions when the ANALOG AUDIO OUT (L/R) jacks of the unit are connected to an amplification system. To enjoy DTS Digital Surround™ playback, an external 5.1 channel DTS Digital Surround™ decoder system must be connected to the BITSTREAM/PCM AUDIO OUT jack of the unit.

## Connecting to an amplifier equipped with an MPEG2 audio decoder

**MPEG2 sound**

You can enjoy motion picture and live concert DVD video discs with dynamic realistic sound by connecting an amplifier equipped with an MPEG2 audio decoder or MPEG2 audio processor.

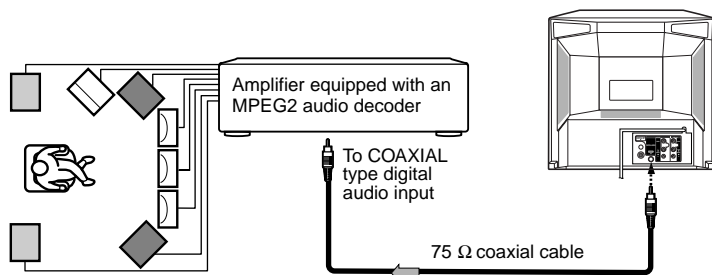

- Use DVD video discs encoded via the MPEG2 recording system.

## Connecting to an amplifier equipped with a digital audio input

**2 channel digital stereo**

You can enjoy the dynamic sound of 2 channel digital stereo by connecting an amplifier equipped with a digital audio input and speaker system (right and left front speakers).

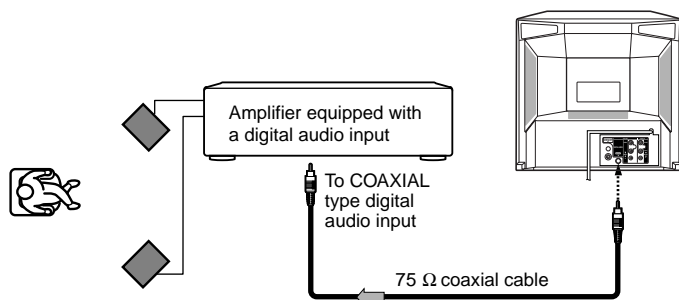
**Notes:**

- DO NOT connect the BITSTREAM/PCM AUDIO OUT jack of the unit to the AC-3 RF input of a Dolby Digital Receiver. This input on your A/V Receiver is reserved for Laserdisc use only and is incompatible with the BITSTREAM/PCM AUDIO OUT jack of the unit.
- Connect the BITSTREAM/PCM AUDIO OUT jack of the unit to the "COAXIAL" input of a Receiver or Processor.
- Refer to the owner's manual of the connected equipment as well.
- When you connect the unit to other equipment, be sure to turn off the power and unplug all of the equipment from the wall outlet before making any connections.
- The output sound of the unit has a wide dynamic range. Be sure to adjust the receiver's volume to a moderate listening level. Otherwise, the speakers may be damaged by a sudden high volume sound.
- Turn off the amplifier before you connect or disconnect the unit's power cord. If you leave the amplifier power on, the speakers may be damaged.

## Setting the language

This unit can display the on screen language in English, Spanish or French. Language selection (step 3) will automatically appear on the screen when you press MENU initially. Select the language you prefer first, then proceed with the other menu options.

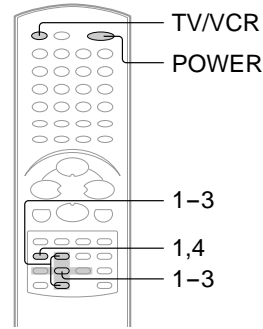

### Setting the language

#### Preparation:

- Press **POWER** to turn on the unit.
- Press **TV/VCR** to select the TV/VCR mode.

#### 1 Press MENU. Press ↑ or ↓ to select “SYSTEM SETUP”, then press ENTER.

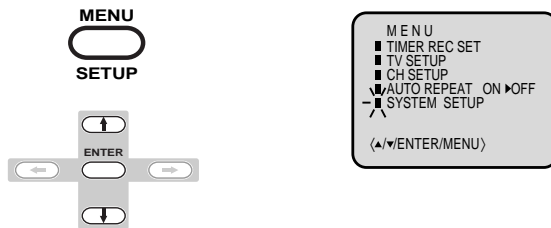

#### 2 Press ↑ or ↓ to select “LANGUAGE”, then press ENTER.



#### 3 Press ↑ or ↓ to select the desired language: English (ENGLISH), Spanish (ESPAÑOL) or French (FRANCAIS), then press ENTER.



#### 4 Press MENU repeatedly until the MENU screen is cleared.



#### Notes:

- Both the TV/VCR and the DVD have their own menu option **56**.
- If no buttons are pressed for more than 60 seconds, the TV/VCR MENU screen will return to normal TV operation automatically.

# Clock setting

The Auto Clock function will automatically set the built-in clock (Month, Day, Year and Time) when the unit is connected to an Antenna or Cable system and it is turned off. As the unit searches for a receivable station in your area and it receives a broadcast signal for Auto Clock, the Auto Clock needs several minutes to set itself.

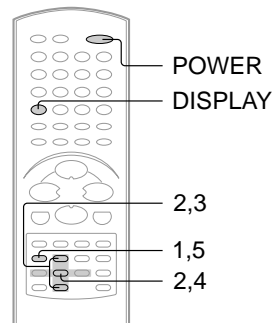

## Auto Clock setting

### Preparation:

- Connect the Antenna or Cable system.
- If you use a cable box, turn it on.
- Plug the AC Power cord to the AC outlet.

### 1 Make sure the unit is turned off.



• If you press **POWER**, the Auto Clock set is not effective.

### 2 Wait at least three minutes and press POWER.

The POWER indicator will light.

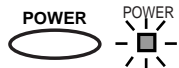

### 3 Press DISPLAY to check the clock on the screen.

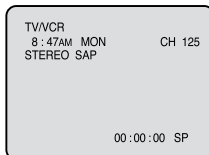

### 4 If the clock is not set, check the antenna condition. The Auto Clock may not function properly if the reception condition is not good.

## Auto Clock adjustment

The Auto Clock adjustment will be performed at 12:00 PM everyday if you turn off the unit.

- If you use a cable box and you want Auto Clock adjustment to be performed, the cable box must be left on.
- The Auto Clock adjustment is not effective when there is a difference of more than 5 minutes exists between the built-in clock time and the actual time.

## To set Auto Clock to OFF

When shipped from factory the AUTO CLOCK is set to "ON". But if you do not want Auto Clock set (Adjustment):

### 1 Press MENU.

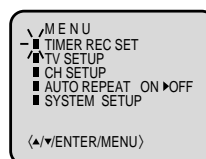

### 2 Press ↑ or ↓ to select "SYSTEM SETUP", then press ENTER.

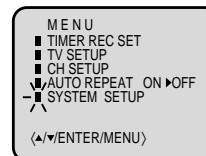
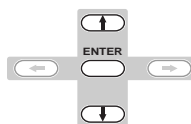

### 3 Press ↑ or ↓ to select "AUTO CLOCK".

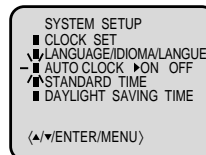
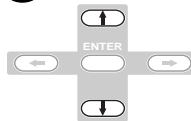

### 4 Press ENTER to select "OFF".

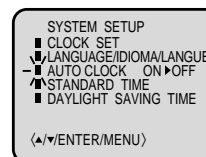
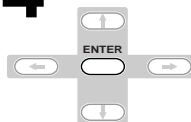

### 5 Press MENU repeatedly until the MENU screen is cleared.



- When the AUTO CLOCK is set to "OFF", the Auto Clock adjustment does not function.
- Set the clock manually [22].

## To set standard time

In the rare event that you live within broadcast range of two stations in two different time zones, the unit may recognize the wrong station for the Auto Clock set.

To correct the situation:

### 1 Press MENU.

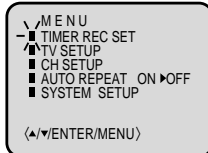

### 2 Press ↑ or ↓ to select "SYSTEM SETUP", then press ENTER.

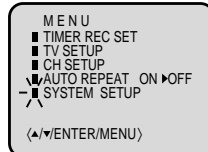
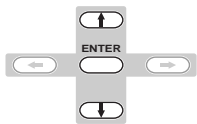

### 3 Press ↑ or ↓ to select "STANDARD TIME", then press ENTER.

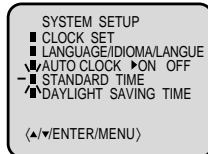
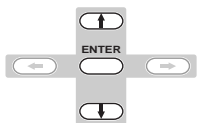

### 4 Press ↑ or ↓ to select your time zone, then press ENTER.

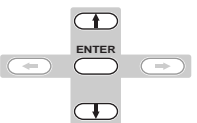

ATLANTIC : GMT-4hours  
 EASTERN : GMT-5hours  
 CENTRAL : GMT-6hours  
 MOUNTAIN : GMT-7hours  
 PACIFIC : GMT-8hours  
 ALASKA : GMT-9hours  
 HAWAII : GMT-10hours  
 AUTO : AUTO SET  
 (GMT: Greenwich Mean Time)

### 5 Press MENU repeatedly until the MENU screen is cleared.



#### Note:

To be able to select the standard time, the clock must first be set by "AUTO CLOCK" once.

## To set daylight saving time

You can set the Daylight saving time automatically or manually.

### 1 Press MENU. Press ↑ or ↓ to select "SYSTEM SETUP", then press ENTER.

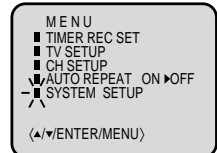
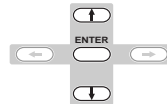

### 2 Press ↑ or ↓ to select "DAYLIGHT SAVING TIME", then press ENTER.

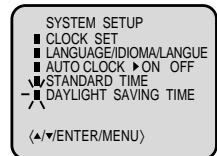
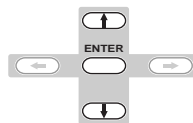

### 3 Press ↑ or ↓ to select one of the options, then press ENTER.

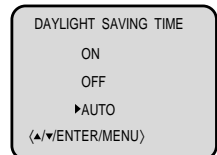
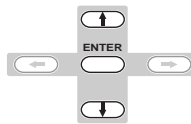

**ON:** for manual setting (forward one hour)

**OFF:** for manual setting (back one hour)

**AUTO:** for automatic setting (read XDS in the signal)

When you want to set the Daylight Saving Time manually, on the first Sunday in April you set to "ON", and on the last Sunday in October you set to "OFF".

### 4 Press MENU repeatedly until the MENU screen is cleared.



#### Notes:

- When shipped from factory, the DAYLIGHT SAVING TIME is set to "AUTO" position.
- When the clock is not set, Daylight Saving Time setting is not available.
- When there is no Daylight Saving Time in your area, always select "OFF" position in step 3.

# Clock setting (continued)

You must set the date and time manually for Timer Recordings, ON/OFF Timer and Daylight Saving Time if the Auto Clock process did not set them correctly.

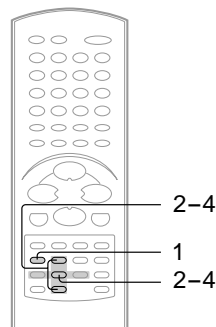

## Manual clock setting

**EXAMPLE:** Setting the clock to "8:30 AM", 29th. (WED) October, 2003.

**1** Press MENU.



**2** Press ↑ or ↓ to select the "SYSTEM SETUP", then press ENTER.

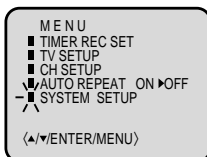
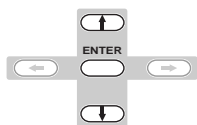

**3** Press ↑ or ↓ to select "CLOCK SET", then press ENTER.

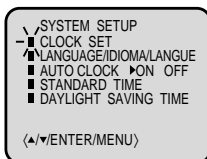
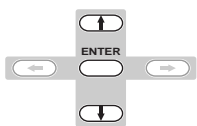

**4** Press ↑ or ↓ to set the month, then press ENTER.

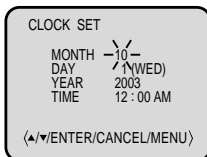
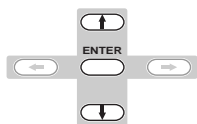

**5** Set the day, year and time as in step 4.

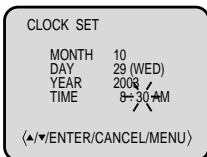

**6** After setting the clock, date and time starts functioning automatically.

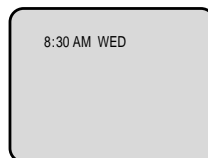

■ To make corrections any time during the process Press **CANCEL** repeatedly until the item you want to change blinks, then press ↑ or ↓.

**Notes:**

- After a power failure or disconnection of the power, the timer settings will be lost. In this case, reset the present time.
- When you set the minute, you can change in 10-minutes step by holding down ↑ or ↓.

# TV Operation

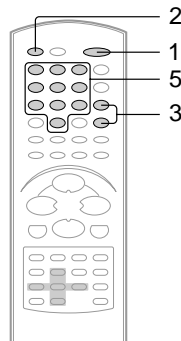

## TV operation



**1** To turn on the unit, press **POWER**.



**2** Press **TV/VCR** to select the TV/VCR mode.



**3** Adjust the volume level by pressing **VOLUME ▲ or ▼**.

The volume level will be indicated on the screen by green bars. As the volume level increases, so do the number of bars. If the volume decreases, the number of green bars also decreases.

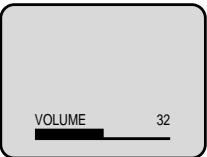

**4** Set TV/CATV menu to the appropriate position (See page 26).

TV - VHF/UHF channels  
CATV - CABLE TV channels

**5** Press the Direct channel selection buttons to select the channel.

**TV mode direct channel selection -**  
When TV/CATV menu is in the TV position, all channels can be instantly selected by using two buttons. (for example, to select channel 2, press "0", then "2". If you press only "2", channel selection will be delayed for two seconds.) For channels 10 and above, press the 2 digits in order.

**CATV mode direct channel selection -**  
When TV/CATV menu is in the CATV position, channels can be selected as follows:

**TO SELECT CATV CHANNELS:**

- 1-9 Press "0" twice, then 1-9 as needed. Example, to select channel 2, press "002".
- 10-12 Press "0", then the remaining 2 digits. Example, to select channel 12, press "012".
- 13-99 Press the 2 digits in order. Example, to select channel 36, press "36".
- 100-125 Press the 3 digits in order. Example, to select channel 120, press "120".

**NOTE FOR CHANNELS 1-12:**  
If only 1 or 2 button is pressed, the corresponding channel will be selected in 2 seconds.



- Notes:**
- If a channel with no broadcast is selected, the sound will automatically be muted.
  - If a station being viewed stops broadcasting, the TV will automatically shut itself off after 15 minutes.

**VHF/UHF/CATV CHANNELS**

TV	CATV
VHF 2-13	VHF 2-13
UHF 14-69	STD/HRC/IRC 14-36 (A) (W) 37-59 (AA) (WW) 60-85 (AAA) (ZZZ) 86-94 (86) (94) 95-99 (A-5) (A-1) 100-125 (100) (125) 01 (5A)

TV operation

## TV Operation (continued)

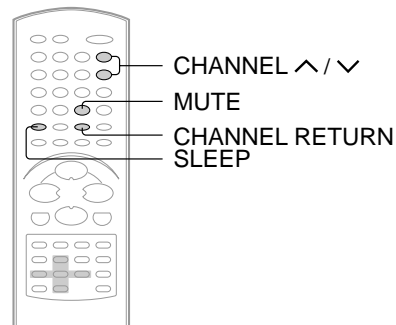

### Sleep

To set the unit to turn off after a preset amount of time, press **SLEEP** on the remote control. The clock will count down 10 minutes for each press of **SLEEP** (120, 110, ...10, 0). After the sleep time is programmed, the display will appear briefly every ten minutes to remind you that the sleep timer is operating. To confirm the sleep timer setting, press **SLEEP** and the remaining time will be display for a few seconds. To cancel the sleep timer, press **SLEEP** repeatedly until the display turns to 0.

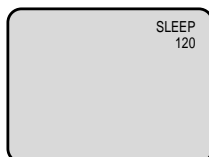

### Mute

Press **MUTE** to switch off the sound. The unit's sound will be silenced and "MUTE" will briefly appear on the screen. The sound can be switched back on by pressing this button again or one of **VOLUME**  $\blacktriangle$  or  $\blacktriangledown$ .

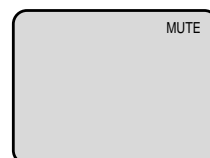

#### Note:

To listen through the headphone, insert a headphone (not supplied) with a 1/8" mini plug into HEADPHONE jack on the front. The sound from the TV speaker is muted.

### Channel $\wedge$ / $\nabla$

Press and release **CHANNEL**  $\wedge$  or  $\nabla$ . The channel automatically stops at the next channel set into memory. For proper operation, before selecting channels, they should be set into the memory. See page 26 "Setting channels automatically".

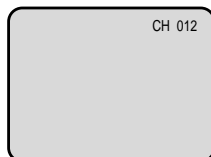

### Channel return

This button allows you to go back to the last channel selected by pressing **CHANNEL RETURN**. Press this button again to return to the last channel you were watching.

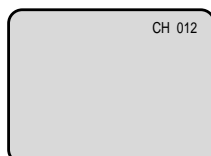



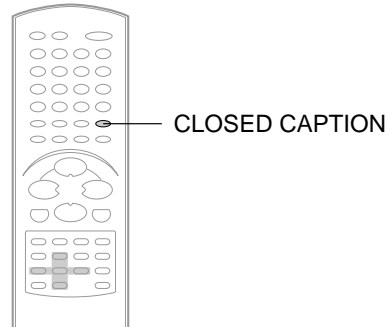

## Closed Captions

Press this button to switch between normal TV and the two closed caption modes (captions and full screen text). Closed captioning will display text on the screen for hearing impaired viewers.

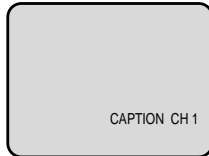

### WHAT IS CLOSED CAPTIONING?

This television has the capability to decode and display Closed Captioned television programs. Closed Captioning will display text on the screen for hearing impaired viewers or it will translate and display text in another language.

### CLOSED CAPTIONING WITH A VCR

Closed Captioned programs can be recorded and played back on a VCR with the Closed Captioned text intact. The Closed Captioned text will disappear during Cue (Fast Forward Search), Review (Rewind Search) and Pause Modes or if the VCR tracking is not adjusted properly.

### TO VIEW CLOSED CAPTIONS

Press CLOSED CAPTION on the remote control to switch between normal TV and the two Closed Caption Modes (Captions and Full Screen Text).

**Captions:** This Closed Caption Mode will display text on the screen in English or another language (depending on the setting of the Closed Captions CH. 1 or 2). Generally, Closed Captions in English are transmitted on Captions Channel 1 and Closed Captions in other languages are transmitted on Captions Channel 2.

The Text Closed Caption Mode will usually fill the screen with a programming schedule or other information.

After selecting a Closed Caption Mode, it will stay in effect until it is changed, even if the channel is changed.

If the Captions signal is lost due to a commercial or a break in the signal, the Captions will reappear when the signal is received again.

If the channels are changed, the Captions will be delayed approximately 10 seconds.

The Captions will appear in places on the screen where they will least interfere with the picture, usually on the bottom of the screen. News programs will usually show three-line Closed Captions which scroll onto the screen.

Most other shows provide two or three lined Captions placed near the character who is speaking so the viewer can follow the dialogue.

Words in italics or underlined describe titles, words in foreign languages or words requiring emphasis. Words that are sung usually appear enclosed by musical notes.

For television programs broadcasting with Closed Captions, look in your TV guide for the Closed Captions symbol (CC).

### Notes:

- If using an indoor antenna or if TV reception is very poor, the Closed Caption Decoder text may not appear. In this case, adjust the antenna for better reception or use an outdoor antenna.
- When activating the Closed Captioned Decoder, there will be a short delay before the Closed Captioned text appears on the screen.
- Closed Captioned text is only displayed in locations where it is available.
- If the Call display is on, the Closed Captioning text will not appear.
- If no caption signal is received, no captions will appear, but the television will remain in the Caption Mode.
- Misspellings or unusual characters may occasionally appear during Closed Captioning. This is normal with Closed Captioning, especially with live programs. This is because during live programs, captions are also entered live. These transmissions do not allow time for editing.
- When Captions are being displayed, on-screen displays, such as volume and mute may not be seen or may interfere with Closed Captions.
- Some cable systems and copy protection systems may interfere with the Closed Captioned signal.

# Tuner setting

This unit is equipped with a channel memory feature which allows channels to skip up or down to the next channel set into memory, skipping over unwanted channels. Before selecting channels, they must be programmed into the unit's memory. In addition to normal VHF and UHF channels, this unit can receive up to 113 Cable TV channels. To use this unit with an antenna, set the TV/CATV menu option to the TV mode. When shipped from the factory, this menu option is in the CATV mode.

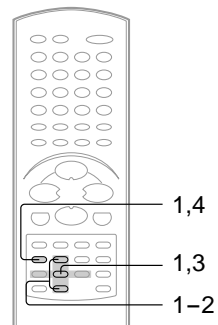

## TV/CATV selection

**Preparation:**  
 • Press TV/VCR to select the TV/VCR mode.

**1** Press MENU. Press **↑** or **↓** to select "CH SETUP", then press ENTER.

**2** Press **↑** or **↓** to select "TV/CATV".

**3** Press ENTER to select the "TV" or "CATV". The arrow indicates the selected mode.

TV - VHF/UHF channels  
 CATV - CABLE TV channels

**4** Press MENU repeatedly until the menu screen is cleared.

## Setting channels automatically

**1** Press MENU. Press **↑** or **↓** to select "CH SETUP", then press ENTER.

**2** Press **↑** or **↓** to select "AUTO CH MEMORY".

**3** Then press ENTER.

The unit will begin memorizing all the channels available in your area. Channel numbers will remain red until auto memorizing is complete.

AUTO CH 002

**4** Press MENU repeatedly until the MENU screen is cleared.

**Notes:**

- If a station being viewed stops broadcasting, the TV will automatically shut itself off after 15 minutes.
- You can't select "CH SETUP" if you set the channel to "LINE1" or "LINE2".

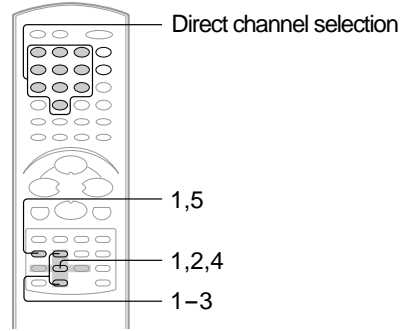

## To ADD/DELETE channels

**1** Press MENU. Press **↑** or **↓** to select “CH SETUP”, then press ENTER.

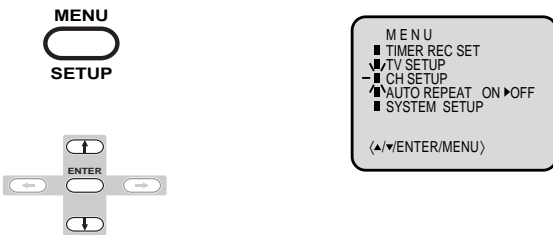

**2** Press **↑** or **↓** to select “ADD/DELETE”, then press ENTER.



**3** Select the desired channel to be added or deleted using **↑** or **↓**.

You can also select the channel using the Direct channel selection buttons (10 keys, 0-9).

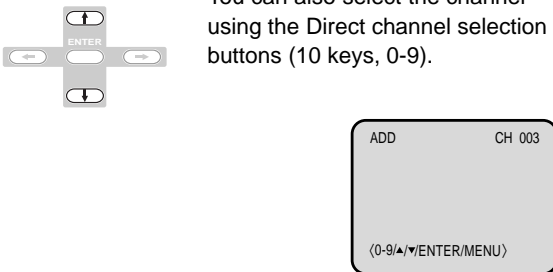

**4** Press ENTER to select “ADD” or “DEL”.

If you select an unmemorized channel, the Channel indication will be red. If you select “ADD”, the Channel indication changes from red to green and the channel will be memorized. If you select a memorized channel, the Channel indication will be green. If you select “DEL”, the Channel indication changes from green to red and the channel will be deleted from the memory.

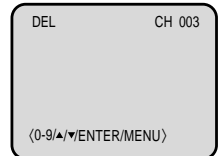
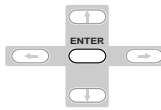

**5** Press MENU repeatedly until the MENU screen is cleared.



# Setting the V-Chip

An age limitation can be set to forbid children to watch programs according to "TV RATING" and "MOVIE RATING" level set. To use the V-Chip function, you must register a password.

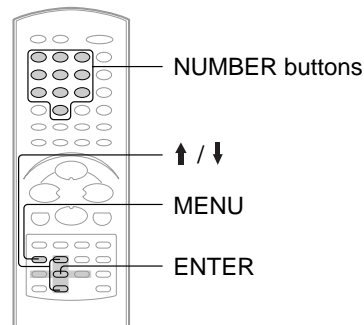

## To register password

**1** Press MENU. Press ↑ or ↓ to select "TV SETUP", then press ENTER.

M E N U

- ▼ TV REC SET
- ▼ TV SETUP
- ▼ CH SETUP
- AUTO REPEAT ON/OFF
- SYSTEM SETUP

<▲/▼ENTER/MENU>

**2** Press ↑ or ↓ to select "V-CHIP SET" then press ENTER.

▼ TV SETUP

- ▼ V-CHIP SET
- ▼ ON/OFF TIMER
- PICTURE
- AUDIO
- SURROUND ON ▶ OFF
- STABLE SOUND ON ▶ OFF
- SAP ON ▶ OFF

<▲/▼ENTER/MENU>

**3** Enter the password (4 digits) using the Number buttons (0-9), then press ENTER.

V-CHIP SET

NEW  
PASSWORD: \*\*\*\*

<0-9/ENTER/CANCEL/MENU>

"\*" appears instead of the number.

**4** Enter the same password again for safety, then press ENTER.

V-CHIP SET

CONFIRM  
PASSWORD: \*\*\*\*

<0-9/ENTER/CANCEL/MENU>

V-CHIP SET menu appears.

IF YOU FORGET THE PASSWORD, YOU CANNOT SET THE V-CHIP. TO AVOID FORGETTING THE PASSWORD, WRITE IT DOWN AND KEEP IN A SAFE PLACE.

## To set the V-chip

**1** In "V-CHIP SET" menu, press ↑ or ↓ to select "TV RATING", then press ENTER.

V-CHIP SET

- V-CHIP : OFF
- ▼ TV RATING : OFF
- ▼ MOVIE RATING : OFF
- CHANGE PASSWORD

<▲/▼ENTER/MENU>

**2** Press ↑ or ↓ to display the desired setting, then press ENTER.

V-CHIP SET

- V-CHIP : OFF /
- ▼ TV RATING : TV-PG
- ▼ MOVIE RATING : OFF
- CHANGE PASSWORD

DISPLAY TO SET CONTENTS

<▲/▼ENTER/MENU>

- OFF : TV RATING is not set
- TV-Y : All children
- TV-Y7 : 7 years old and above
- TV-G : General Audience
- TV-PG : Parental guidance
- TV-14 : 14 years old and above
- TV-MA : 17 years old and above

• When you select TV-Y7, TV-PG, TV-14 or TV-MA, press the DISPLAY button to explain the rating. Press ↑ or ↓ to select the desired rating you want. Press the ENTER button to select the setting "ON" or "OFF".

**3** Press ↑ or ↓ to select the "MOVIE RATING", then press ENTER.

V-CHIP SET

- V-CHIP : OFF
- ▼ TV RATING : TV-PG
- ▼ MOVIE RATING : OFF
- CHANGE PASSWORD

<▲/▼ENTER/MENU>

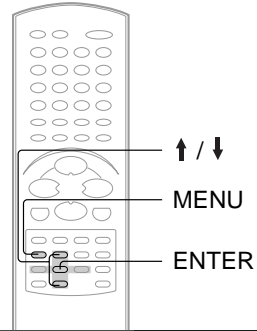

**4** Press ↑ or ↓ to select desired rating, then press ENTER.

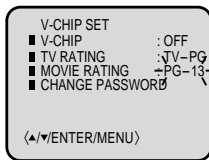
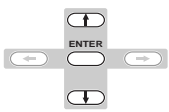

- OFF** : MOVIE RATING is not set
- G** : All ages
- PG** : Parental guidance
- PG-13** : Parental guidance less than 13 years old
- R** : Under 17 years old  
Parental guidance suggested
- NC-17** : 17 years old and above
- X** : Adult only

**7** Press MENU repeatedly until the MENU screen is cleared.



**Note:**

The V-Chip function is activated only on programs and tapes that have the rating signal.

**To use the TV after the TV is protected.**

When the program applied to the V-Chip setting is received, enter the password, then press the ENTER button. When the password is entered correctly the protection will be temporarily overridden.

**5** Press ↑ or ↓ to select “V-CHIP”.

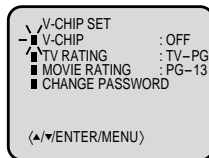
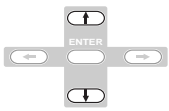

**6** Press ENTER to display “ON”.

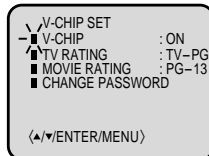
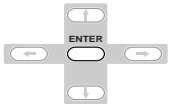

# Setting the V-Chip (continued)

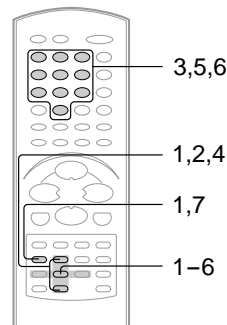

## To Change password

**1** Press MENU. Press **↑** or **↓** to select "TV SETUP", then press ENTER.

M E N U

- ▣ TIMER REC SET
- ▣ TV SETUP
- ▣ CH SETUP
- ▣ AUTO REPEAT ON ▸ OFF
- ▣ SYSTEM SETUP

(◀/▶/ENTER/MENU)

**2** Press **↑** or **↓** to select "V-CHIP SET", then press ENTER.

- ▣ TV SETUP
- ▣ V-CHIP SET
- ▣ ON/OFF TIMER
- ▣ PICTURE
- ▣ AUDIO
- ▣ SURROUND ON ▸ OFF
- ▣ STABLE SOUND ON ▸ OFF
- ▣ SAP ON ▸ OFF

(◀/▶/ENTER/MENU)

**3** Enter the Password using the Number buttons (0-9), then press ENTER.

V-CHIP SET

PASSWORD: \*\*\*\*

(0-9/ENTER/CANCEL/MENU)

**4** Press **↑** or **↓** to select "CHANGE PASSWORD", then press ENTER.

- ▣ V-CHIP SET
- ▣ V-CHIP : ON
- ▣ TV RATING : TV-PG
- ▣ MOVIE RATING : PG-13
- ▣ CHANGE PASSWORD

(◀/▶/ENTER/MENU)

**5** Enter the new password using the Number buttons (0-9), then press ENTER.

- ▣ V-CHIP SET
- ▣ V-CHIP : ON
- ▣ TV RATING : TV-PG
- ▣ MOVIE RATING : PG-13
- ▣ CHANGE PASSWORD
- NEW PASSWORD: - - - -

(0-9/ENTER/CANCEL/MENU)

**6** Enter the same password again to confirm, then press ENTER.

- ▣ V-CHIP SET
- ▣ V-CHIP : ON
- ▣ TV RATING : TV-PG
- ▣ MOVIE RATING : PG-13
- ▣ CHANGE PASSWORD
- CONFIRM PASSWORD: - - - -

(0-9/ENTER/CANCEL/MENU)

**7** Press MENU repeatedly until the MENU screen is cleared.

## To set the on timer

This feature allows you to have the unit automatically turn on at a predetermined time. If you program the ON TIMER once, the unit will turn on on the programmed day (daily/weekly) at the same time to the same channel.

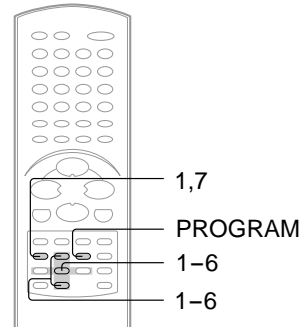

### To set the on timer

**EXAMPLE:** Turning on the TV to channel 12 at 7:00 AM, MONDAY-FRIDAY.

**1** Press MENU. Press  $\uparrow$  or  $\downarrow$  to select "TV SETUP", then press ENTER.

MENU SETUP

You can also select ON/OFF TIMER by pressing PROGRAM twice.

MENU  
 ■ TIMER REC SET  
 - TV SETUP  
 ■ CH SETUP  
 ■ AUTO REPEAT ON/OFF  
 ■ SYSTEM SETUP  
 (<math>\leftarrow/\rightarrow</math>)/ENTER/MENU)

**2** Press  $\uparrow$  or  $\downarrow$  to select "ON/OFF TIMER", then press ENTER.

TV SETUP  
 ■ V-CHIP SET  
 - ON/OFF TIMER  
 ■ PICTURE  
 ■ AUDIO  
 ■ SURROUND ON/OFF  
 ■ STABLE SOUND ON/OFF  
 ■ SAP ON/OFF  
 (<math>\leftarrow/\rightarrow</math>)/ENTER/MENU)

**3** Press  $\uparrow$  or  $\downarrow$  to select "ON TIMER", then press ENTER.

ON/OFF TIMER  
 - ON TIMER 12:00AM CH 001 SUN-SAT CANCEL  
 ■ OFF TIMER 12:00AM CANCEL  
 (<math>\leftarrow/\rightarrow</math>)/ENTER/CANCEL/MENU)

**4** Press  $\uparrow$  or  $\downarrow$  to set the desired hour, then press ENTER.

ON/OFF TIMER  
 ■ ON TIMER 7:00AM CH 001 SUN-SAT CANCEL  
 ■ OFF TIMER 12:00AM CANCEL  
 (<math>\leftarrow/\rightarrow</math>)/ENTER/CANCEL/MENU)

**5** Set the desired minute, channel and daily or weekly timer date as in step 4.

ON/OFF TIMER  
 ■ ON TIMER 7:00AM CH 012 MON-FRI CANCEL  
 ■ OFF TIMER 12:00AM CANCEL  
 (<math>\leftarrow/\rightarrow</math>)/ENTER/CANCEL/MENU)

**6** Press  $\uparrow$  or  $\downarrow$  to select "SET", then press ENTER. Now the ON TIMER is set.

ON/OFF TIMER  
 ■ ON TIMER 7:00AM CH 012 MON-FRI SET CANCEL  
 ■ OFF TIMER 12:00AM CANCEL  
 (<math>\leftarrow/\rightarrow</math>)/ENTER/CANCEL/MENU)

**7** Press MENU repeatedly until the MENU screen is cleared.



#### Notes:

- The unit will automatically turn off approximately 1 hour later after the ON TIMER turns on if no OFF TIMER has been set. To continue watching the TV, press any button to cancel the one hour automatic shut off.
- To cancel ON TIMER, follow above steps 1-5, then press  $\uparrow$  or  $\downarrow$  button to select "CANCEL". Press the MENU button repeatedly to return to the normal screen.
- After setting the ON TIMER, "■" of the OFF TIMER will flash on and off. If you wish to set the OFF TIMER, press the ENTER button then follow the steps 4-6 on page 32.
- If you want to correct the digits while setting, press the CANCEL button until the item you want to correct, then press  $\uparrow$  or  $\downarrow$  button to correct the desired setting.

# To set the off timer

This feature allows you to have the unit turn off automatically at a predetermined time. If you program the OFF TIMER once, the unit will automatically turn off at the same time everyday.

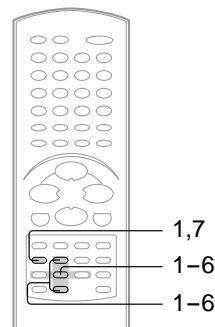

## To set the off timer

**EXAMPLE:** Turning off the TV at 11:30 PM.

**1** Press **MENU**. Press **↑** or **↓** to select **“TV SETUP”**, then press **ENTER**.  
You can also select **ON/OFF TIMER** by pressing **PROGRAM** twice.

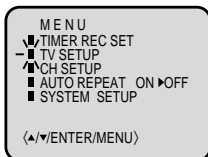
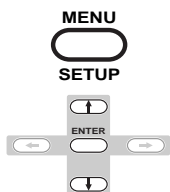

**2** Press **↑** or **↓** to select **“ON/OFF TIMER”**, then press **ENTER**.

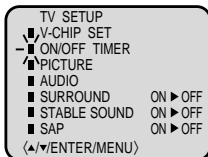
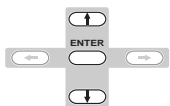

**3** Press **↑** or **↓** to select **“OFF TIMER”**, then press **ENTER**.

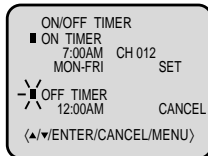
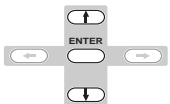

**4** Press **↑** or **↓** to set the desired hour, then press **ENTER**.

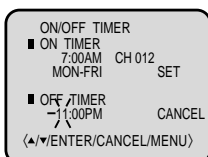
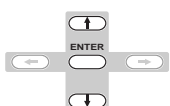

**5** Press **↑** or **↓** to set the desired minute, then press **ENTER**.

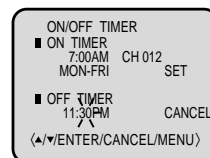
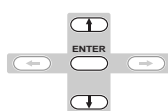

**6** Press **↑** or **↓** to select **“SET”**.  
Now the OFF TIMER is set.

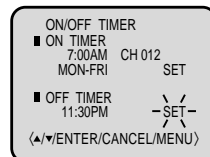
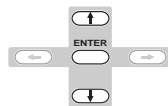

**7** Press **MENU** repeatedly until the **MENU** screen is cleared.



**Notes:**

- To cancel the OFF TIMER function:**  
To cancel OFF TIMER, follow above steps 1-5, then press **↑** or **↓** button to select **“CANCEL”**. Press the **MENU** button to return to the TV screen.
- To confirm the ON/OFF TIMER:**  
Press the **PROGRAM** button twice to indicate the programs on the screen.



# Picture control adjustment

Picture controls are factory preset but you can adjust them individually as follows:

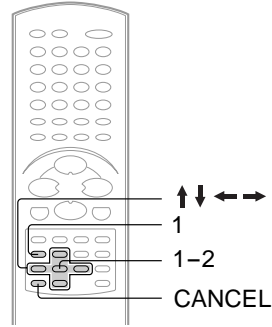

## Picture control adjustment

**1** To display the picture adjustment screen, press **MENU**. Press **↑** or **↓** to select "TV SETUP", then press **ENTER**.

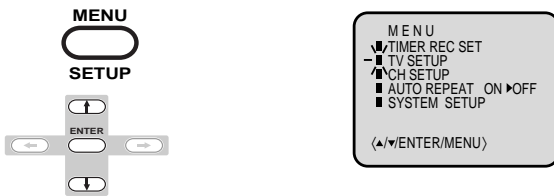

**2** Press **↑** or **↓** to select "PICTURE", then press **ENTER**.



### BRIGHTNESS

Press **ENTER** until "BRIGHTNESS" appears on the screen, then press **←** or **→** to adjust the brightness of the picture. When the button is pressed, the darker portions of the picture become lighter.

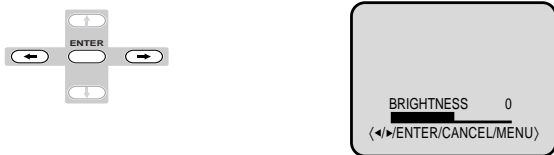

### CONTRAST

Press **ENTER** until "CONTRAST" appears on the screen, then press **←** or **→** to adjust the contrast of the picture. Pictures look sharpest in the daytime (bright light) by increasing the contrast. At night (dim light), the sharpest picture is obtained by reducing the contrast.



### COLOR

Press **ENTER** until "COLOR" appears on the screen, then press **←** or **→** to adjust the color intensity of the picture. The control should be set when colors appear normal in intensity and brilliance.

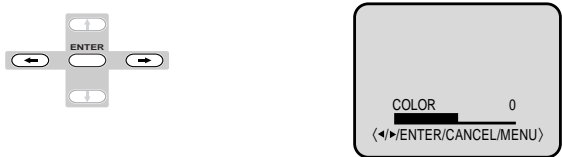

### TINT

Press **ENTER** until "TINT" appears on the screen, then press **←** or **→** to adjust the tint of the picture. This determines how accurately the colors are reproduced by the TV. Adjusting the tint for natural facial tone is the best method of obtaining accurate color reproduction of the entire picture.



### SHARPNESS

Press **ENTER** until "SHARPNESS" appears on the screen, then press **←** or **→** to adjust the sharpness of the picture.



### CANCEL

Pressing **CANCEL** while making picture adjustments will return all adjustments to the factory preset levels.



### Notes:

- The On-screen display will disappear 6 seconds after finishing an adjustment or by pressing the MENU button three times.
- The settings can only be adjusted when they are displayed on the TV screen.

# Sound control adjustment

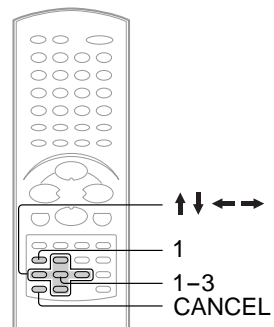

## Sound control adjustment

**1** To display the sound adjustment screen, press MENU. Press ↑ or ↓ to select “TV SETUP”, then press ENTER.

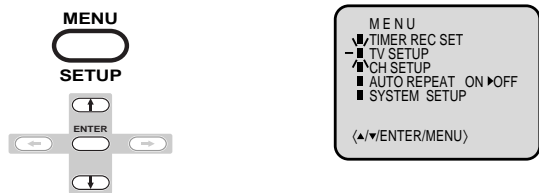

**2** Press ↑ or ↓ to select “AUDIO”, then press ENTER.



**3** Press ENTER repeatedly until the desired item appears on the screen.



→ BASS → TREBLE → BALANCE

**4** Press ← or → to adjust the setting.

	+	-
BASS	makes the bass sound stronger	makes the bass sound weaker
TREBLE	makes the treble sound stronger	makes the treble sound weaker
BALANCE	makes the output level of right speaker stronger	makes the output level of left speaker stronger



Pressing **CANCEL** while making sound control adjustments will return all adjustments to the factory preset levels.



**Notes:**

- The On-screen display will disappear 6 seconds after finishing an adjustment or by pressing the MENU button three times.
- The settings can only be adjusted when they are displayed on the TV screen.

# Loading and unloading a cassette tape

Use only video cassette tapes marked **VHS**.

## Loading

Push the center of the tape until it is automatically inserted.

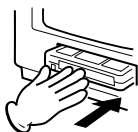

Insert the cassette tape with its labeled side facing up and the erase prevention tab positioned at your left. An inverted cassette tape cannot be inserted.

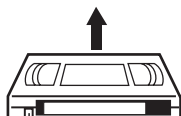

Erase prevention tab

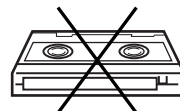

### Automatic power ON

When you insert a cassette tape the unit power will turn ON automatically.

### Automatic playback

When loading a cassette tape without an erase prevention tab, playback will start automatically.

## Unloading

**1** Press **STOP/EJECT** on the front panel.

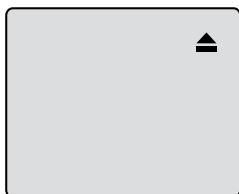

**2** Remove the cassette tape.

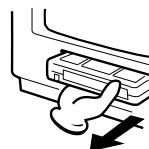

### Automatic tape eject

This unit will automatically rewind the tape when the tape has ended. And when the tape is rewinded to its beginning, the cassette tape will be ejected automatically.

### Notes:

- Always eject the tape when not in use.
- The cassette tape can be ejected even if the POWER is "OFF".

## To prevent accidental erasure

### To prevent accidental erasure

Remove the erase prevention tab with a screwdriver.

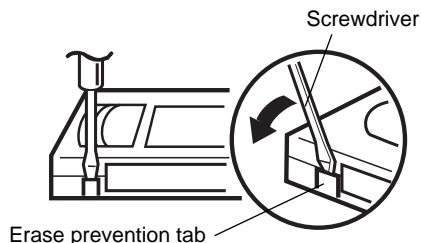

### To record again

Cover the hole with a piece of adhesive tape.



## Tape speed and maximum recording time

Tape Speed	Video cassette tape				
	T-160	T-120	T-90	T-60	T-30
SP (Standard Play)	2-2/3 hours	2 hours	1-1/2 hours	1 hour	30 minutes
SLP (Super Long Play)	8 hours	6 hours	4-1/2 hours	3 hours	1-1/2 hours

# Cassette tape playback

To play a prerecorded tape.

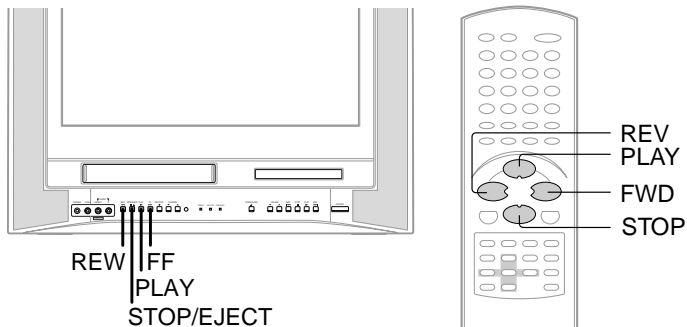

## Playback

- 1 Load a prerecorded tape:**  
(When loading a cassette tape without the erase prevention tab, playback will start automatically).



- 2 To start playback:**  
Press **PLAY** on the front panel or on the remote.  
Playback will start. "▶" will appear on the screen for about 4 seconds.



- To stop playback:**  
Press **STOP/EJECT** once on the front panel or press **STOP** on the remote.  
The tape will stop but remain fully loaded and ready to play.  
"■" will appear on the screen for about 4 seconds.

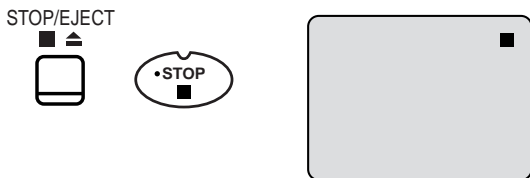

**Notes:**

- If you play a prerecorded tape after the DVD playback, you must set the unit to TV/VCR mode using the TV/VCR button.
- This unit selects the playback tape speed SP or SLP automatically.
- When you select the TV/VCR mode during DVD playback, DVD playback will change to the still mode, and after 5 minutes it will change to the resuming playback mode automatically.

## Rewind or forward the tape

- Preparation:**  
• Press **TV/VCR** to select the TV/VCR mode.

Stop the playback or recording with **STOP**.

**To rewind the tape:**

Press **REW** on the front panel or press **REV** on the remote.



**To forward the tape:**

Press **FF** on the front panel or press **FWD** on the remote.

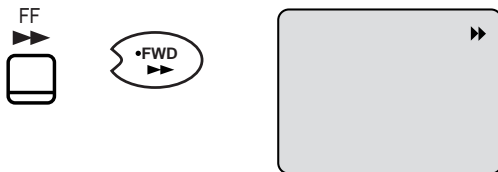

To stop the tape-winding, press **STOP**. To switch to playback directly (without **STOP**), press **PLAY**.

**■ Forward/Reverse picture search mode**

When the tape is being wound, you can switch to picture search mode (see next page). To do this, press **REV** or **FWD** again and hold it down. The unit will resume the tape winding as soon as the button is released.

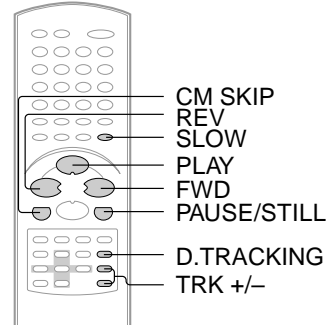

## Picture search

### Reverse picture search function

Press **REV** once or twice during the playback.

### Forward picture search function

Press **FWD** once or twice during the playback.

To return to playback, press **PLAY**.

### SPEED SEARCH TIMES

TAPE SPEED	PICTURE SEARCH SPEED	
	PRESS ONCE	PRESS TWICE
SP (Standard Play)	3 X	5 X
SLP (Super Long Play)	9 X	15 X

## Still picture

Press **PAUSE/STILL** during playback.

To resume normal playback, press **PLAY** or **PAUSE/STILL**.

If the still picture jitters excessively, press **TRK + / -** to stabilize the still picture.

## Slow motion

During playback press **SLOW**.

To return to playback, press **PLAY** or **SLOW**.

### ■ Slow tracking and vertical lock adjustment

If noise bars appear in the picture during slow motion, press the **TRK + / -** to reduce the noise bars.

## Frame by frame picture

Press **PAUSE/STILL** during playback.

Press **SLOW** one by one: The picture advances frame by frame.

To return to playback, press **PLAY** or **PAUSE/STILL**.

## CM skip

Press **CM SKIP** during playback. The unit will search forward through approximately 30 seconds of the tape (e.g. unwanted commercial time) for each press of **CM SKIP** (maximum six presses) and then resume normal playback.

For example : 1 press: 30 seconds of tape

2 press: 60 seconds of tape

3 press: 90 seconds of tape

## Digital tracking controls

When a tape is played, the Digital Auto Tracking system automatically adjusts the tracking to obtain the best possible picture. If noise bars appear during playback, adjust the tracking manually as follows:

- Press **TRK + / -** to obtain the best possible picture. "MANUAL TRACK" will appear for 4 seconds on the screen. To resume automatic tracking, press **D.TRACKING**. "DIGITAL TRACK" will appear for 4 seconds on the screen.

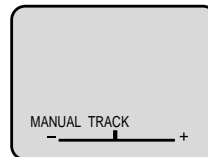

### Notes:

- "SP" is more appropriate as less noise appeared during search and still playback for tape recorded in SP.
- The audio output is muted during SPEED SEARCH, STILL, FRAME ADVANCE and SLOW MOTION.
- During picture search mode there will be noise bars which are caused by the system.
- The Special Playback will automatically change to playback after approx. 5 minutes to protect the video tape against excessive wear.

# Convenient function

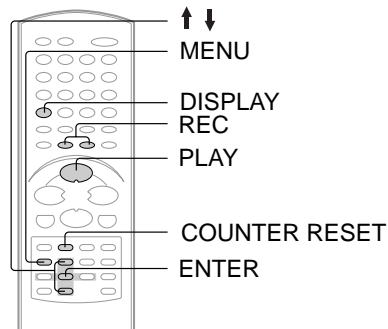

## Repeat playback

The entire video tape will be played until its end. The tape will automatically rewind to the beginning and the playback will be repeated.

**1** Press MENU. Press **↑** or **↓** to select "AUTO REPEAT".

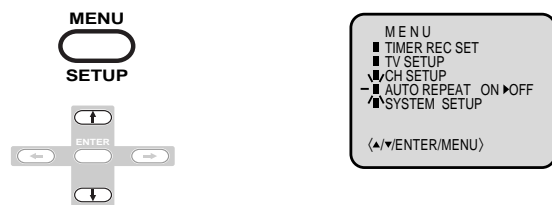

**2** Then press ENTER to select "ON" or "OFF".

If "ON" is selected, the playback will be repeated endlessly.



**3** Press MENU until the menu screen is cleared.

If you press DISPLAY, "11" will appear on the screen.



**4** To start the playback, press PLAY.

The playback will be repeated endlessly.



**■ To cancel repeat mode:**

Follow the above step 1, then press **ENTER** to select "OFF" position. Press **MENU** to return to the TV screen. The repeat function is canceled automatically when the unit is switched off.

## Using the real time tape counter

The On-Screen Real Time Tape Counter shows the tape running time in Hours, Minutes and Seconds. You can easily determine how long the tape has been running or how much time is left on the tape.

**1** Press DISPLAY.

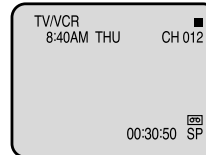

**2** Press COUNTER RESET to set the counter to "00:00:00".

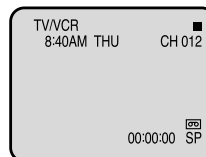

**3** Begin Playback or Recording to start the tape, the counter will display the elapsed time.



**4** When you wish to make the counter disappear, press DISPLAY once again.



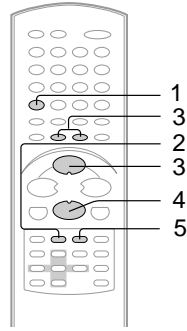

## Zero return function

The zero return function provides a convenient method of rapidly returning to the starting point of recording or playback. The starting point can be indexed for any location on the tape by pressing COUNTER RESET and ZERO RETURN.

### 1 Press DISPLAY.

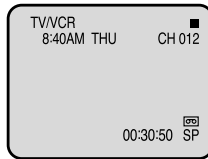

### 2 Before playback or recording, press COUNTER RESET to set the counter to "00:00:00".

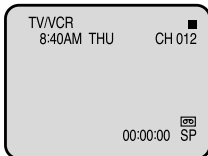
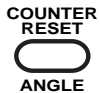

### 3 Begin playback or recording.



### 4 Press STOP.

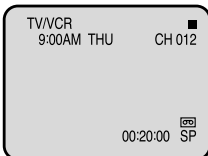

### 5 Press ZERO RETURN. The tape will rewind and automatically stop at the "00:00:00" position.

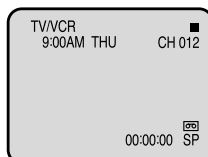

## Video head cleaning

### Video head clogging

The video heads are the means by which the unit reads the picture from the tape during playback. In the unlikely event that the heads become dirty enough to be clogged, no picture will be played back. This can easily be determined if, during playback of a known good tape, there is good sound, but no picture (picture is extremely snowy). If this is the case, have the unit checked by qualified service personnel.



Good Picture

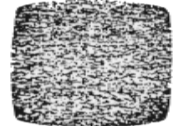

Snowy Picture

### Video head cleaning

Video head cleaning is needed when the playback picture becomes unclear. This signifies that the heads are getting dirty and can occur when playing poor quality or damaged tapes. If the heads require cleaning, use an equivalent high quality chemical non-abrasive (wet) head cleaning tape or have them cleaned professionally. If playing a head cleaning tape in the unit once does not improve the picture, play it several times before requesting service.

#### Notes:

- DO NOT ATTEMPT TO CLEAN THE VIDEO HEADS OR SERVICE THE UNIT BY REMOVING THE REAR COVER.
- Video heads may eventually wear out and should be replaced when they fail to produce clear pictures.
- To help prevent video head clogging, use only good quality VHS tapes. Discard worn out tapes.

## Recording a TV program

Recording and viewing the same TV program.

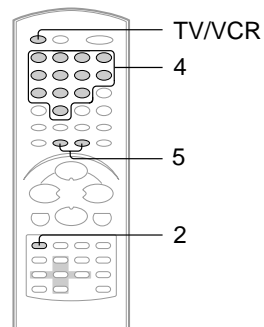

### Recording a TV program

#### 1 Load a cassette tape with the erase prevention tab intact.

The unit will automatically turn on.



#### 2 Press SP/SLP to select the desired tape speed SP or SLP.

The tape counter and SP or SLP will appear on the screen for about 4 seconds.

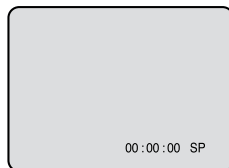

#### 3 Select "TV" or "CATV" to the appropriate position .

TV - VHF/UHF channels  
CATV - CABLE TV channels

#### 4 Press Direct channel selection buttons or CH / to select the channel to be recorded.

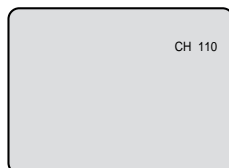
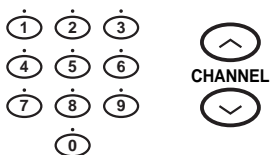

#### 5 Press both REC at the same time.

"●" will appear on the screen for about 4 seconds and the REC/OTR indicator on the front panel will light.

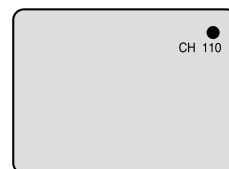

#### Notes:

- If power is switched off during recording, the TV and the DVD sections go off and the VCR continues to record. Press the STOP button to halt the recording and turn off the VCR.
- The unit channel cannot be changed during recording.
- If you record the TV program after the DVD playback, you must set the unit to TV/VCR mode using the TV/VCR button.



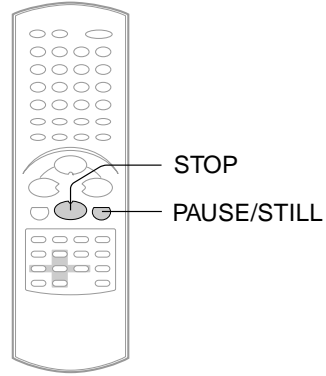

## To stop recording

Press **STOP** to stop recording.

"■" will appear on screen for about 4 seconds.



### ■ Auto Rewind feature

This VCR will automatically rewind the tape when the tape has ended (except during OTR and timer recording). It will also eject the tape.

#### Note:

If the erase prevention tab is removed, the tape will eject when both the REC buttons are pressed for recording.

## To stop recording temporarily

Press **PAUSE/STILL** to avoid recording unwanted material.

"||" will appear on the screen and the REC/OTR indicator will blink on and off. Press **PAUSE/STILL** or both **REC** at the same time to continue the recording.

+PAUSE/STILL



#### Note:

The pause function will be released after 5 minutes to prevent damage to the tape or the unit. The unit will change to the STOP mode.

## One-touch Timer Recording (OTR)

The One-touch Timer Recording feature provides a simple and convenient way to make a timed recording.

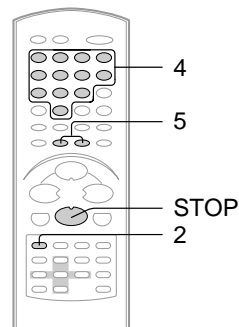

### One-touch Timer Recording (OTR)

**Example:** One-touch Timer Recording for 30 minutes.

#### 1 Load a cassette tape with the erase prevention tab intact.

The unit will automatically turn on.

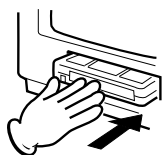

#### 2 Press SP/SLP to select the desired tape speed SP or SLP.

The tape counter and SP or SLP will appear on the screen for about 4 seconds.

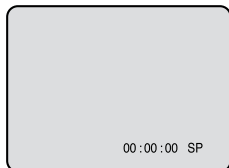

#### 3 Set "TV" or "CATV" option to the appropriate position [26].

TV - VHF/UHF channels  
CATV - CABLE TV channels

#### 4 Press Direct channel selection buttons or CH ^/∨ to select the channel to be recorded.

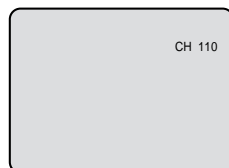
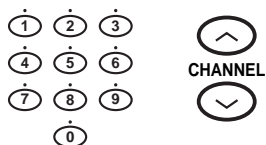

#### 5 Press both REC at the same time to begin recording. Press the buttons again to stop recording after 30 minutes. Each additional press of REC will increase recording time as shown below, up to a maximum of 6 hours. "OTR" will appear on the screen.

Press	Recording time	Press	Recording time
once	NORMAL REC	6 times	3:00
twice	0:30	7 times	4:00
3 times	1:00	8 times	5:00
4 times	1:30	9 times	6:00
5 times	2:00	10 times	NORMAL REC

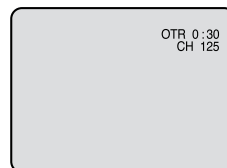

### To cancel OTR

Press **STOP**.

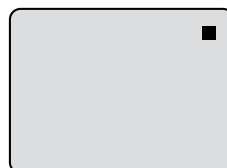

"■" will appear on screen for about 4 seconds.

#### Notes:

- If you wish to watch the DVD playback during the recording or the OTR, press the DVD button to change to DVD mode and perform the DVD playback [51].
- The channel cannot be changed during recording.

# Timer recording

Timer recording can be programmed on-screen with the remote control. The built-in timer allows automatic unattended recording of up to 8 programs within 1 month.

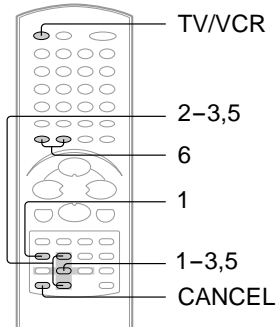

## Timer recording

### Preparation:

- Press **TV/VCR** to select the TV/VCR mode.
- Load a cassette tape with the erase prevention tab intact.
- Check the time and date are correct [22].

### Example:

Program a timer recording for 23rd day, channel 125 (CATV), 7:00 - 9:30 PM (Tape speed : SLP).

**1** Press **MENU**. Press **↑** or **↓** to select "TIMER REC SET", then press **ENTER**.

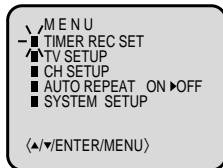
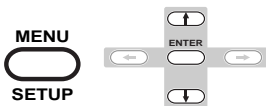

**2** Press **↑** or **↓** to select one of the program line, then press **ENTER**.

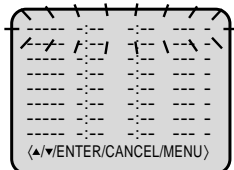
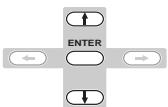

**3** Press **↑** or **↓** to select the date, then press **ENTER**.

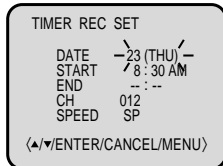
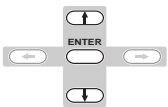

**4** Set the start time, end time, channel and tape speed as in step 3.

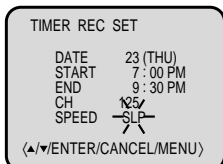

### Notes:

- Press **CANCEL** to move cursor backward for correction.
- To record from external source set the channel to "L1" or "L2". "L1" or "L2" will appear next to CH 125 (or 69).

**5** To set the timer for another program, press **↑** or **↓** until the number of the second program blinks, then press **ENTER**. Repeat steps 2 to 4 to set the second program.

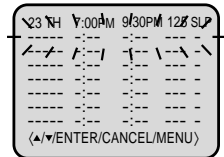
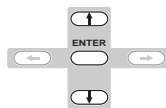

**6** Press both **TIMER REC** at the same time. The **TIMER REC** indicator will light. The Timer is programmed, when the programmed time is reached, the recording is automatically started.

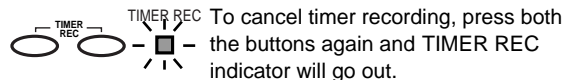

### Notes:

- The VCR section cannot be used while the **TIMER REC** indicator is lit. If you want to use the VCR operation, press both **TIMER REC** buttons at the same time to deactivate the timer.
- When the clock is not set, you cannot select "TIMER REC". In this case, set the clock (see pages 20-22).
- After a power failure or disconnection of the power plug, all programmed recording setting and time display will be lost upon resumption of power. In this case, reset the clock (see pages 20-22) and reprogram any timer recordings.
- If you want to correct the digits while setting, press the **CANCEL** button until the item you want to correct, then press **↑** or **↓** to correct the desired setting.
- If programming is performed without a tape in the unit, or with a tape without an erase prevention tab, the Timer Recording is not possible. If a tape without an erase prevention tab is in the unit, the tape will be ejected.

## Timer recording (continued)

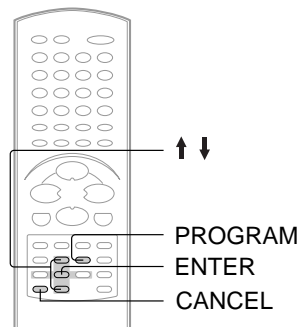

### To set daily/weekly timer

#### Weekly (e.g. WKL-TUE: each Tuesday) or daily (e.g. MON-SAT: Monday to Saturday) Timer recording

Follow the procedure of timer recording on the previous page. At picture 3 press  $\uparrow$  or  $\downarrow$  repeatedly until the desired setting appears. Then press **ENTER**.

When you press  $\downarrow$  repeatedly, the indicator at DATE will change as follows, in this case the day is Friday.

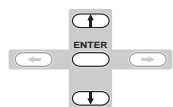
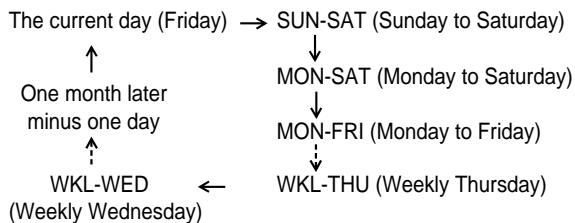

### If the programs overlap another

Do not overlap timer programs as portions of the conflicting programs will be lost. The first recording time has priority over the next recording time as shown in the diagram below.

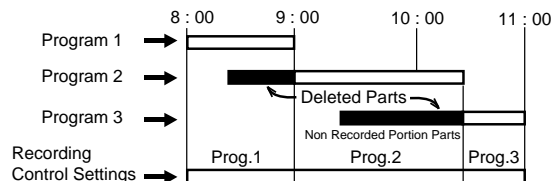

#### Notes:

- The daily/weekly recording can be made continuously until the recording is canceled or the tape reaches the end.
- During timer recording the automatic rewinding mechanism does not function.
- You can correct or cancel the programed setting in program confirm mode.

### To confirm the settings

Press **PROGRAM** once. The TV screen displays the timer program list. Press **PROGRAM** again. The TV screen displays the ON/OFF timer setting.

**PROGRAM**



REPEAT A-B

Press **PROGRAM** 3 times. The screen returns to the normal screen.

(once)

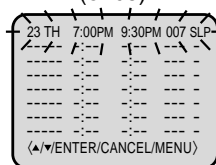

(twice)

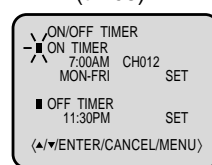

### To cancel a program

Press  $\uparrow$  or  $\downarrow$  to select "TIMER REC SET" in the MENU, then press **ENTER**. Press  $\uparrow$  or  $\downarrow$  to select the unnecessary program, and press **CANCEL** to cancel the program.

**CANCEL**



CLEAR

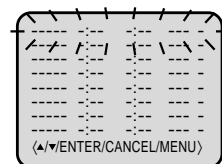

# Setting the surround sound/ Setting the stable sound

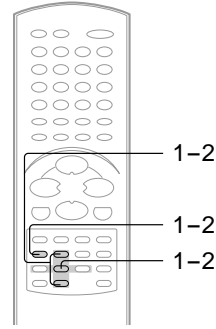

## Setting the surround sound

The surround sound feature expands the audio listening field wider and deeper to create exceptional sound quality from the TV's speakers.

**1** Press **MENU**. Press **↑** or **↓** to select "TV SETUP", then press **ENTER**.

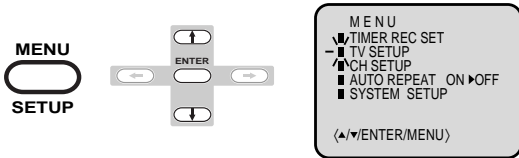

**2** Press **↑** or **↓** to select "SURROUND".  
 Then press **ENTER** to select "ON".  
 Then press **MENU** repeatedly until the menu screen is cleared.

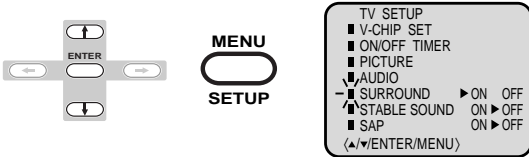

■ **To cancel the surround sound mode:**  
 Follow the above step 2, then press **ENTER** to select "OFF" position. Press **MENU** to return to the TV screen.

## Setting the stable sound

The stable sound feature limits the highest volume level to prevent extreme changes in volume when the signal source is changed.

**1** Press **MENU**. Press **↑** or **↓** to select "TV SETUP", then press **ENTER**.

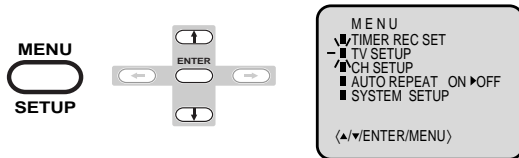

**2** Press **↑** or **↓** to select "STABLE SOUND".  
 Then press **ENTER** to select "ON".  
 Then press **MENU** repeatedly until the menu screen is cleared.

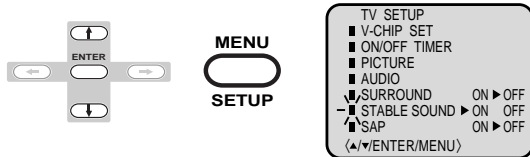

■ **To cancel stable sound mode:**  
 Follow the above step 2, then press **ENTER** to select "OFF" position. Press **MENU** to return to the TV screen.

# Second Audio Program (SAP)/ Stereo recording and playback

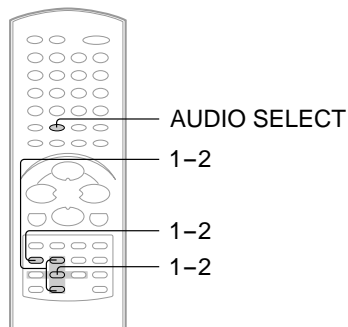

## Second Audio Program (SAP)

Your unit is fitted with a SAP broadcast system which enables you to switch to a Second Audio Program when viewing a selected channel. This function applies only when the program is broadcast in multi-languages through the SAP broadcast system.

**1** Press MENU. Press **↑** or **↓** to select "TV SETUP", then press ENTER.

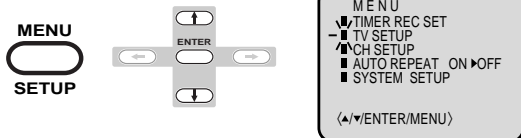

**2** Press **↑** or **↓** to select "SAP". Then press ENTER to select "ON".

Then press MENU repeatedly until the menu screen is cleared.

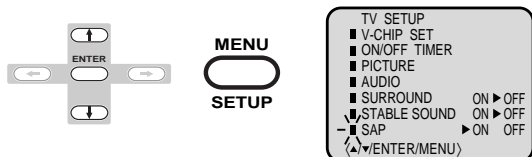

### Listening to SAP

When the unit is turned on or a channel selection is made, make certain the letters "SAP" appears on the screen. This means that the "Second Audio Program" broadcasting is available.

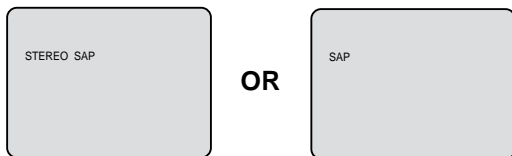

#### Notes:

- When playing back a tape that is not recorded in Hi-Fi stereo mode, the audio will automatically be monaural.
- When listening to a VHS Hi-Fi video tape or MTS broadcast through the VHF/UHF jack (Audio/Video cord not connected), the sound will be monaural.

## Stereo recording and playback

The VHS Hi-Fi audio system permits high fidelity recording of MTS STEREO TV broadcasts.

When a MTS STEREO broadcast is received, "STEREO" will appear on the screen and the program can be viewed or recorded in stereo. The Hi-Fi stereo recording procedure is the same as for normal recordings.

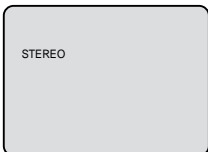

#### Note:

When using a CATV system, stereo TV programs may be transmitted over a mono cable channel. In this case "STEREO" will not appear and the sound will be in mono.



### Output selection

When viewing an MTS stereo TV program, or playing a prerecorded VHS Hi-Fi stereo videotape, press **AUDIO SELECT** to select how the audio will be heard through the speakers. Normally set to the Hi-Fi stereo position, this button can be set to the MONO position if the stereo broadcast or videotape audio is of poor quality. The "R" and "L" positions allow the audio from the Right or Left Hi-Fi channel to be heard over both TV speakers. This button has no effect when viewing a MONO videotape or TV program. Each time when you press the button, OUTPUT SELECTION display appears on the screen for several seconds. Refer to the chart below.

OUTPUT SELECTION	SOUND HEARD ON BOTH SPEAKERS
STEREO	STEREO
L ch	LEFT CHANNEL AUDIO
R ch	RIGHT CHANNEL AUDIO
MONO	MONO

# Duplicating a video tape

If you connect the unit to another VCR or Camcorder, you can duplicate a previously recorded tape. Make all connections before turning on the power.

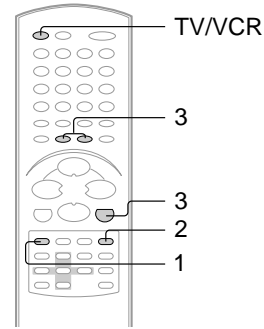

## Duplicating a video tape

### Preparation:

- Press **TV/VCR** to select the TV/VCR mode.
- Load a cassette tape with the erase prevention tab intact.
- Load a previously recorded tape into the playback VCR or Camcorder.

### 1 Press **SP/SLP** to select the desired tape speed **SP** or **SLP**.



It is recommended that you set the Speed to the SP mode on the recording VCR for best results.

### 2 Press **INPUT SELECT** once or twice to select **AUDIO/VIDEO** input position.



"LINE1" or "LINE2" will appear on the screen.

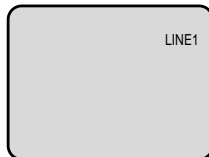

LINE1: on the rear panel  
LINE2: on the front panel

### 3 Press both **REC** at the same time, then press **PAUSE/STILL**.



### 4 Press **PLAY** on the playback VCR, then press **PAUSE/STILL**.

### 5 Release the recording pause and the playback.

### Note:

Unauthorized recording of copyrighted television programs, films, video cassettes and other materials may infringe the rights of copyright owners and be contrary to copyright laws.

### Connection with second video recorder

- Select "LINE1" on step 2.

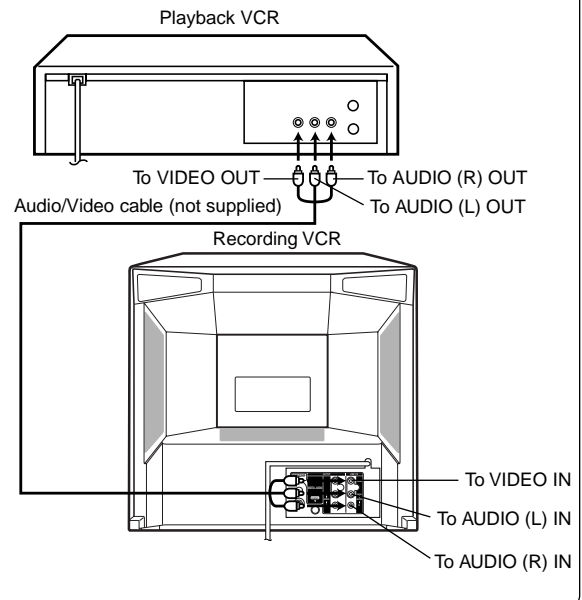

### Connection with Camcorder

- Select "LINE2" on step 2.

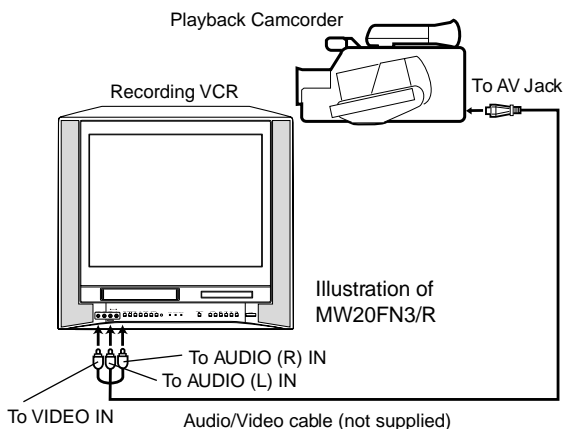

For duplicating a previously recorded tape from a camcorder, follow the camcorder manufacturer's instructions. A typical camcorder dubbing hookup is shown above.

## Recording a DVD/CD disc

You can record disc material in DVD, Audio CD, etc. onto a video tape with this unit.

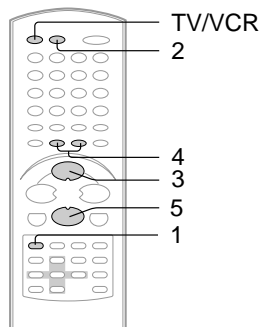

### Duplicating a DVD or CD disc

#### Preparation:

- Press **TV/VCR** to select the TV/VCR mode.
- Load a cassette tape with the erase prevention tab intact.
- Load a DVD/CD disc.

- 1 Press **SP/SLP** to select the desired tape speed **SP** or **SLP**.



- 2 Press **DVD** to select the DVD mode.



- 3 Press **PLAY** to start playback.



- 4 Press both **REC** to start recording.



The unit will change to the VCR mode automatically and the playback picture or sound will be duplicated on the video cassette tape.

- 5 Press **STOP** if you finish recording.



If you wish to stop a DVD/CD disc, press **DVD** to change the DVD mode, then press **STOP**.

#### Notes:

- You may not record the beginning of the disc, so start to playback the disc, then start to record.
- You cannot record the disc with copy guard function. The following icon and text will show up on the TV screen for about 4 seconds.



DISC IS COPY PROTECTED



# Preparation

The following pages describe the setup/operation in DVD mode.

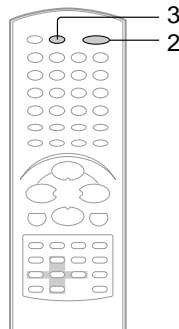

## DVD VCD CD Preparation

### 1 Insert the AC cord plug into a standard 120V 60Hz polarized AC outlet.

If the AC cord plug is plugged in for the first time, wait for about 5 seconds before pressing **POWER**.

### 2 Press **POWER** on the unit or on the remote control to turn on the unit.

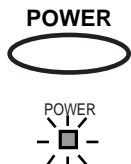

- The **POWER** indicator will light.
- Every time you press **POWER**, the unit starts from TV mode.
- When using an amplifier, switch on the amplifier.

### 3 Press **DVD** to select DVD mode.



The DVD startup screen will appear on the screen.

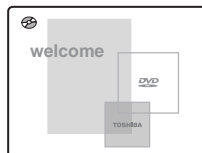

#### Notes:

- When connecting to other equipment, unplug the unit from the AC outlet.
- **If the unit does not operate properly:** Static electricity, etc., may affect the player's operation. Disconnect the AC power cord once, then connect it again.

# Playback procedure

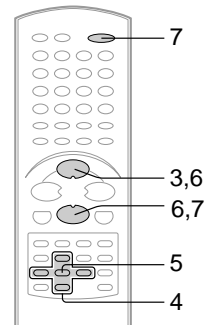
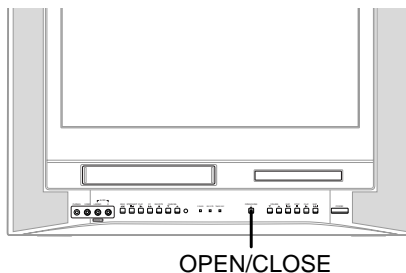

## DVD VCD CD Playback procedure

- 1** Press **OPEN/CLOSE** on the unit.  
The disc tray will open.

OPEN/CLOSE

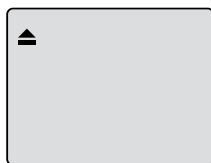

- 2** Place a disc onto the tray.  
Position it with the printed label side up, align it with the guides, and place it in its proper position.

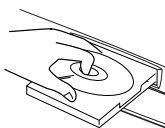

- 3** Press **OPEN/CLOSE** on the unit or **PLAY** on the unit or the remote control.

- The disc tray closes automatically. On the TV screen, "▲" changes to "⊗" and then playback commences.

OPEN/CLOSE



- A menu screen will appear on the TV screen, if the disc has a menu feature.

- 4** Press **↑/↓** or **←/→** to make a selection.

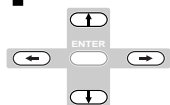

- 5** Press **ENTER**.  
Title is selected and play commences.

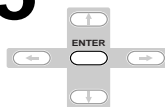

- 6** Press **STOP** to end playback.

The unit memorizes the stopped point, depending on the disc. "■" appears on the screen. Press **PLAY** to resume playback (from the scene point).

If you press **STOP** again or unload the disc ("■" appears on the screen.), the unit will clear the stopped point.



- 7** To stop the playback, press **STOP**.  
Then press **OPEN/CLOSE** on the unit.  
The disc tray opens.  
Remove the disc then press **POWER**.

The disc tray closes automatically and unit turns off.

OPEN/CLOSE



POWER



### Notes:

- If a non-compatible disc is loaded, "Incorrect Disc", "Region Code Error" or "Parental Error" will appear on the TV screen according to the type of loaded disc. If these appear, check your disc again (see pages 8 and 59).
- Some discs may take a minute or so to start playback.
- When you set a single-faced disc label downwards (ie. the wrong way up) and press **PLAY** or **OPEN/CLOSE** on the unit, "⊗" will appear on the display for about 5 seconds and then "No Disc" or "Incorrect Disc" will be displayed.
- Some playback operations of DVDs may be intentionally fixed by software producers. Since this unit plays DVDs according to the disc contents the software producers designed, some playback features may not be available. Also refer to the instructions supplied with the DVDs.

# Special playback

Note: There may be a slight delay between when you press the button and the function activating.

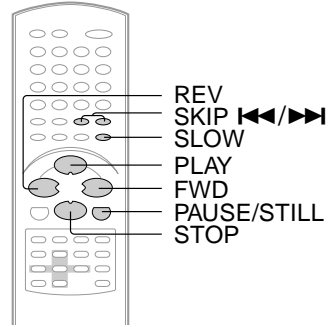

## DVD VCD CD Fast forward playback

Press FWD during normal playback.



Each press of FWD will increase the speed of the search ►►, ►►►, ►►►►, ►►►►►. To resume normal playback, press PLAY.



## DVD VCD Frame advance

Press PAUSE/STILL during still playback.



One frame is advanced each time you press PAUSE/STILL. To resume normal playback, press PLAY.



## DVD VCD CD Review playback

Press REV during normal playback.



Each press of REV will increase the speed of the search ◀◀, ◀◀◀, ◀◀◀◀, ◀◀◀◀◀. To resume normal playback, press PLAY.



## DVD VCD Slow-motion playback

Press SLOW (|►) during normal playback or still playback.



Each press of SLOW will change the speed of the slow x1/2, x1/4, x1/6, x1/8.



To resume normal playback, press PLAY.



To resume the still playback, press PAUSE/STILL.

## DVD VCD CD Still playback

Press PAUSE/STILL during normal playback to pause playback.

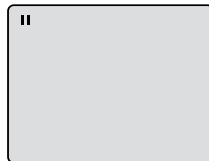

To resume normal playback, press PLAY.

## DVD VCD CD Locating a chapter or track

Press SKIP ◀◀ or ►► repeatedly to display the chapter or track number you want.

Playback starts from the selected chapter or track.



To locate succeeding chapters or tracks.



Playback starts from the beginning of the current chapter or track.



When you press twice, playback starts from the beginning of the preceding chapter or track.

### ■ Playing a Disc while the VCR section is recording or standing by for timer recording.

- 1) Start to record. Follow step 1-5 on page 40.
  - If the unit is standing by for recording, turn on the unit.
- 2) Press DVD to select DVD mode.
- 3) Play a disc. Follow step 1-5 on page 50.
  - Press PLAY if the unit does not start to play a disc automatically.
- 4) Stop to play. Press STOP to stop playback a disc.

### Note:

The unit is capable of holding a still video image or On screen display image on your television screen indefinitely. If you leave the still video image or On screen display image displayed on your TV for an extended period of time, you risk permanent damage to your television screen. Projection televisions are very susceptible.

# Zooming/Locating desired scene

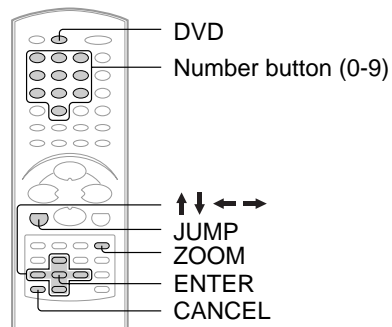

## DVD VCD Zooming

This unit will allow you to zoom in on the frame image. You can then make selections by switching the position of the frame.

**1** Press DVD to select DVD mode. Press ZOOM during playback.



The center part of the image will be zoomed in.



Each press of ZOOM will change the ZOOM Q1 (x 2), Q2 (x 3) and Q3 (x 4).

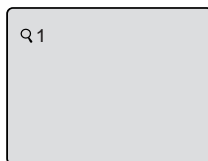

**2** Press ↑/↓ / ←/→ to view a different part of the frame.

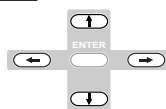

You may move the frame from the centre position to UP, DOWN, LEFT or RIGHT direction.

**3** In the zoom mode press ZOOM repeatedly to return to a 1:1 view (Q Off).



**Notes:**

- You can select the Pause, Slow or Search playback in the zoom mode.
- Some discs may not respond to zoom feature.

## DVD VCD CD Locating desired scene

Use the title, chapter and time recorded on the disc to locate the desired point to play back.

**1** Press JUMP during playback.

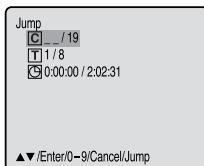

**2** Press ↑ or ↓ to select the “C (Chapter)”, “T (Title/Track)” or “(Time)”.

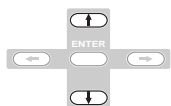

**3** Press Number buttons (0–9) to input the number.

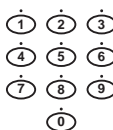

- If you input a wrong number, press CANCEL.
- Refer to the package supplied with the disc to check the numbers.

**4** Press ENTER.

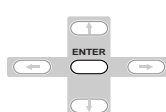

- Playback starts.
- When you change the title, playback starts from Chapter 1 of the selected title.
  - Some discs may not work in the above operation.

# Repeat, Random and Program playback/Repeat A-B

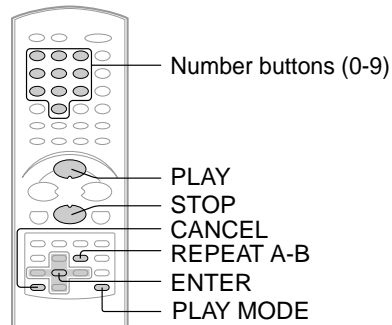

## DVD VCD CD Repeat, Random and Program playback

Press **PLAY MODE** during playback or stop mode.



Each time you press **PLAY MODE**, playback mode changes as follows.

### DVD

On screen display	Operation
Title:	Repeats the current title.
Chapter:	Repeats the current chapter.
Off:	Resumes normal playback.

• During stop mode, **PLAY MODE** key is not effective.

### Audio CD/Video CD

On screen display	Operation
All:	Repeats entire disc.
Track:	Repeats the current track.
Off:	Resumes normal playback.
Random Play:	Plays the tracks in random order.
*Program:	Plays the tracks in program order.
(Status display):	Resumes normal playback.

- During stop mode, you can not select " Track".
- During Audio CD playback, " Off" does not appear.
- Random playback and Program playback do not function on the Video CD.

### \*Program menu

Use number buttons (0-9) to enter the track's number you want to program, then press **ENTER**.

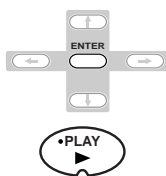
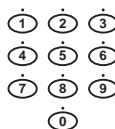

The track number and total time are displayed. Repeat this step to enter additional tracks. When you have finished entering tracks, press **PLAY** to start Program playback.

A playlist of your programmed tracks is displayed.

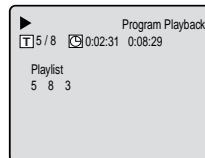
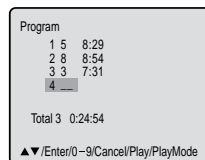

### Notes:

- If you put a wrong number, press **CANCEL**.
- To cancel program play, press **STOP** 3 times.
- To clear the programs on the program menu, press **CANCEL** until all programs will be cleared.
- The program is cancelled when you open the disc tray or turn off the power.

## DVD VCD CD Repeat A-B

Repeat A-B playback allows you to repeat material between two selected points.

### 1 Press REPEAT A-B during playback.



The start point is selected.



### 2 Press REPEAT A-B again.



The end point is selected. Playback starts at the point that you selected. Playback stops at the end point, returns to Point A automatically, then starts again.



### Notes:

- Some discs may not work with the repeat operation.
- In Repeat A-B mode, subtitles near point A or B may not appear.
- You may not be able to set Repeat A-B, depending on the scenes of the DVD.
- Repeat A-B does not work with interactive DVDs.
- Repeat & Repeat A-B function is prohibited when PBC is on.

- To resume normal playback press **REPEAT A-B** again. " Off" appears on the screen.

# Changing soundtrack language/ Subtitles

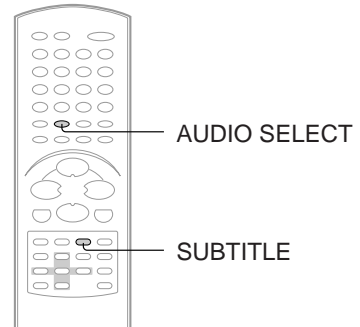

## DVD Changing soundtrack language

You can select the language when you play a multilingual disc.

### 1 Press AUDIO SELECT during playback.



The current soundtrack language will appear.



### 2 Press AUDIO SELECT repeatedly until the desired language is selected.



The on-screen display will disappear after a few seconds.

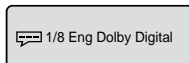

### In case of video CD playback

Audio type changes as follows each time you press AUDIO SELECT.



#### Note:

Changing soundtrack language is cancelled when you open the disc tray. The initial default language or available language will be heard if the disc is played back again.

## DVD Subtitles

### Turning the Subtitles On and Off

When playing back a disc recorded with subtitles, you can turn the subtitles on or off.

Press SUBTITLE during playback until "Off" appears.

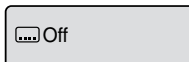

### Changing the subtitle language

You can select the language when playing back a disc recorded with multilingual subtitles.

#### 1 Press SUBTITLE repeatedly during playback until your desired language appears.

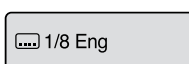

#### 2 The on-screen display will disappear after a few seconds.

#### Notes:

- If the desired language does not appear after pressing the SUBTITLE button several times, the language is not recorded on the disc.
- Changing subtitle language is cancelled when you open the disc tray or turn the power off.
- Some functions may not work on some DVDs. You may not be able to turn subtitles on or off or change subtitles. While playing the DVD, the subtitle may change when:
  - you open or close the disc tray.
  - you change the title.
- In some cases, the subtitle language is not changed to the selected one immediately.

# Changing angles/Title selection/DVD menu

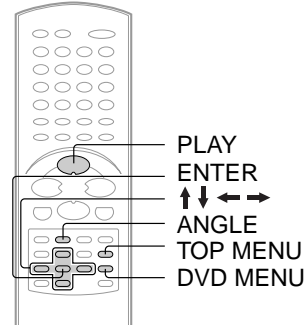

## DVD Changing Angles

When playing back a disc recorded with multi-angle facility, you can change the view angle.

- 1** Press **ANGLE** during playback.  
The current angle will appear.

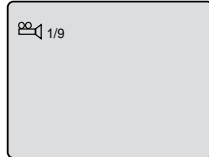

- 2** Press **ANGLE** repeatedly until the desired angle is selected.



**Note:**

Depending on the DVD, you may not be able to change the angles even if multi-angles are recorded on the DVD.

## DVD Title Selection

Two or more titles are recorded on some discs. If the title menu is recorded on the disc, you can select the desired title.

- 1** Press **TOP MENU** during playback.  
Title menu appears on the screen.



- 2** Press **↑/↓** or **←/→** to select the desired title.

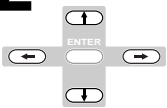

- 3** Press **ENTER** or **PLAY**.  
The playback of the selected title will start.

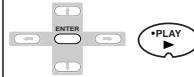

**Notes:**

- Depending on the DVD, you may not be able to select the title.
- Depending on the DVD, a "title menu" may simply be called a "menu" or "title" in the instructions supplied with the disc.

## DVD Menu

Some DVDs allow you to select the disc contents using the menu.

When you play back these DVDs, you can select the subtitle language and soundtrack language, etc. using the DVD menu.

- 1** Press **DVD MENU** during playback.  
The DVD menu appears on the screen.  
Press **DVD MENU** again to resume playback at the scene when you pressed **DVD MENU**.



- 2** Press **↑/↓** or **←/→** to select the desired item.

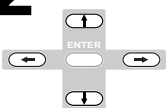

- 3** Press **ENTER**.  
The menu continues to another screen. Repeat steps 2 and 3 to set additional items if any.

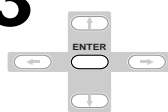

# Setting language

You can change the default settings to customise performance to your preference.

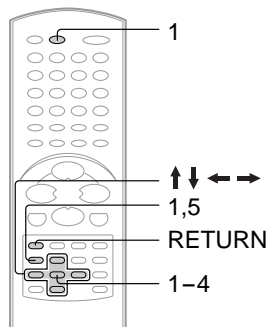

## DVD Setting Language

**1** Press DVD to select DVD mode. Press SETUP in the stop mode. Press ↑ or ↓ to select “Language”, then press → or ENTER.

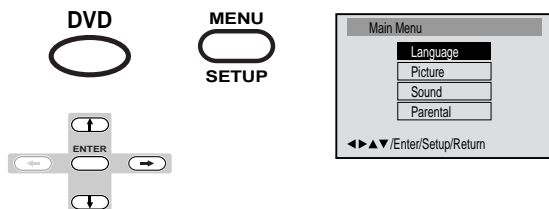

**5** Press SETUP to remove the Menu screen.

**Notes:**

- If the selected soundtrack language is not recorded on the disc, the original language will be heard.
- If the selected subtitle language is not recorded on the disc, the first-priority language is selected.

**2** Press ↑ or ↓ to select “OSD Language”, then press → or ENTER.



**3** Press ↑ or ↓ to select desired language (e.g. English), then press ENTER.



- The menu returns to “Language” menu automatically.
- If you want to return to the previous menu, press ← or RETURN.

**4** Repeat steps 2-3 for other “Language” setting.

**Other: (Menu/Audio/Subtitle)**

If you want to select another language, enter the language code (see the Language code list on page 65).

**Off: (subtitle)**

Subtitles do not appear.



# Setting the aspect ratio of TV screen/ Setting on screen display

You can select the aspect ratio for your TV.  
On screen display can be switched on or off when you press the buttons.

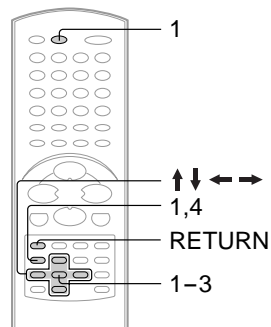

## DVD Setting the aspect ratio of TV screen

- 1 Press DVD to select DVD mode. Press SETUP in the stop mode or No Disc. Press ↑ or ↓ to select "Picture", then press → or ENTER.

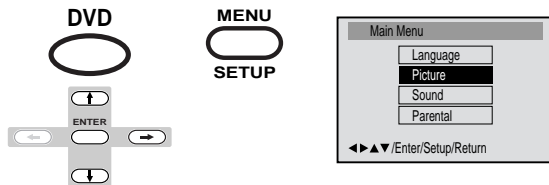

- 2 Press ↑ or ↓ to select "TV Screen", then press → or ENTER.



- 3 Press ↑ or ↓ to select your desired screen type, then press → or ENTER.

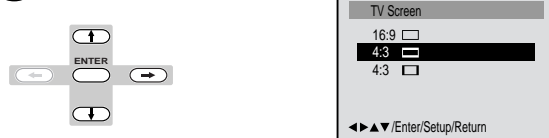

You have the following screen sizes to choose from:

**16:9** : (Wide screen)

Select this mode when connecting to a wide-screen TV. A wide screen picture is displayed full size.

**4:3** : (Letterbox)

Select this mode when connecting to a conventional TV. When playing back a wide screen-DVD disc, it displays the wide picture with black bands at the top and bottom of screen.

**4:3** : (Panscan)

It displays the wide picture on the whole screen with left and right edges automatically cut off.

- If you want to return to the previous menu, press ← or RETURN.

- 4 Press SETUP to remove the Menu screen.



## DVD Setting on screen display

- 1 Press DVD to select DVD mode. Press SETUP in the stop mode or No Disc. Press ↑ or ↓ to select "Picture", then press → or ENTER.

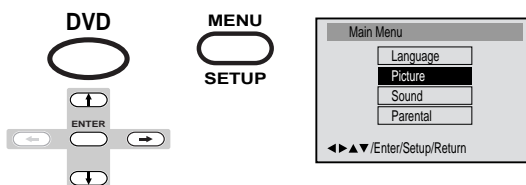

- 2 Press ↑ or ↓ to select "Display".

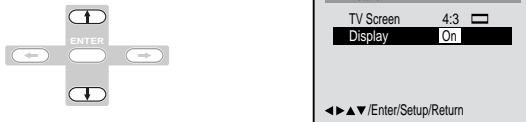

- 3 Press → or ENTER to select "On" or "Off".



**On:** On screen displays appear when you press the buttons (factory setting).

**Off:** On screen displays do not appear when you press any buttons.

- If you want to return to the previous menu, press ← or RETURN.

- 4 Press SETUP to remove the Menu screen.



### Note:

If the DVD disc is not formatted in the pan & scan style, it displays 4:3 style.

# Dynamic Range Control

DRC (Dynamic Range Control) enables you to control the dynamic range so as to achieve a suitable sound for your equipment.

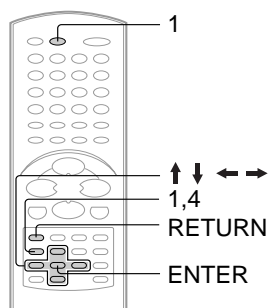

## DVD Dynamic Range Control

**1** Press DVD to select DVD mode. Press SETUP in the stop mode. Press ↑ or ↓ to select “Sound”.

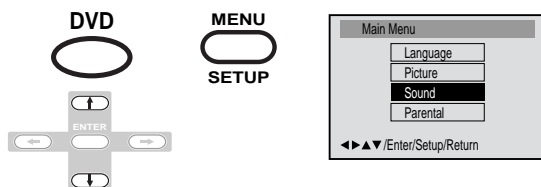

**2** Press → or ENTER to select “DRC”.

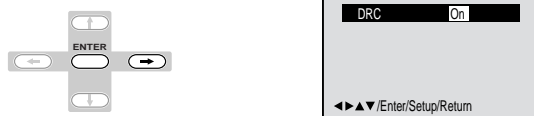

**3** Press → or ENTER to select “On” or “Off”.



- If you want to return to the previous menu, press ← or RETURN.

**4** Press SETUP to remove the Menu screen.



**Notes:**

- This function works only during playback of Dolby Digital recorded discs.
- The level of Dynamic Range Reduction may differ depending on DVD video disc.

# Parental control setting

Some discs are specified not suitable for children. Such discs can be limited not to play back with the unit.

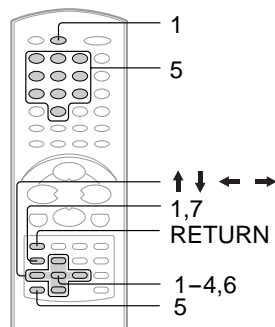

## DVD Parental control setting

**1** Press DVD to select DVD mode. Press SETUP in the stop mode. Press ↑ or ↓ to select “Parental”, then press → or ENTER.

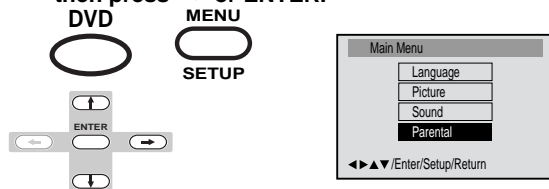

**2** Press ↑ or ↓ to select “Parental Level”, then press → or ENTER.

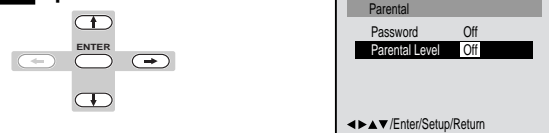

**3** Press ↑ or ↓ to select a level from Off or 1–8. Press → or ENTER to set the selected level.



- **Level Off:** The parental control setting does not function.
- **Level 8:** Almost all DVD software can be played back.
- **Level 1:** DVD software for adults cannot be played back.
- Select from the level 1 to level 8. The limitation will be more severe as the level number is lower.

**4** Press ↑ or ↓ to select “Password”, then press → or ENTER.

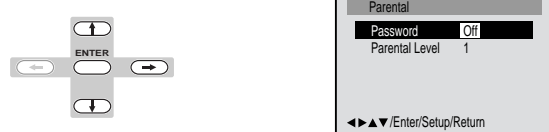

**5** Press number buttons (0–9) for the password. Don't forget the password.

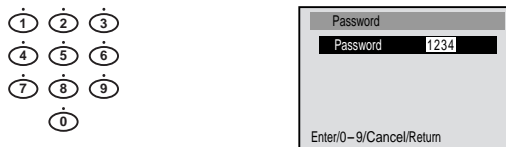

- If you input a wrong number, press **CANCEL**.

**6** Press ENTER to store the password.

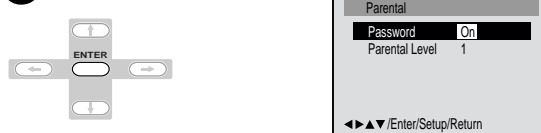

- Note:** Now the rating is locked and the setting cannot be changed unless you enter the correct password.
- If you want to return to the previous menu, press ← or **RETURN**.

**7** Press SETUP to remove the parental control screen.



### Notes:

- If each setup (P.56–60) has been completed, the unit can always be worked under the same conditions (especially with DVD discs). Each setup will be retained in the memory when you turn the power off.
- Depending on the discs, the unit cannot limit playback.
- Some discs may not be encoded with specific rating level information though its disc jacket says “adult.” For those discs, the age restriction will not work.

# To change the parental level

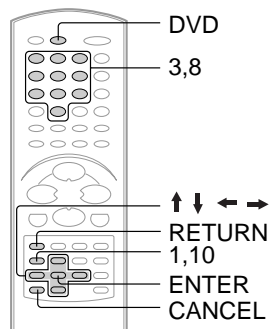

## DVD To change the parental level

**1** Press DVD to select DVD mode. Press SETUP in the stop mode or No Disc. Press ↑ or ↓ to select “Parental”, then press → or ENTER.

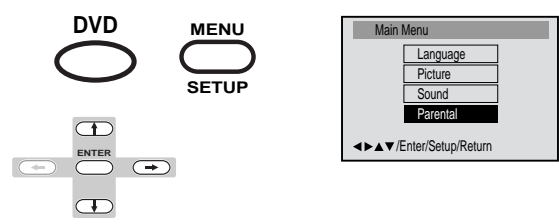

**2** Press ↑ or ↓ to select “Password”, then press → or ENTER.



**3** Press number buttons (0–9) to enter the password you have stored.

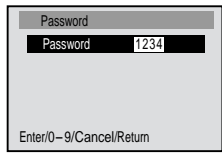
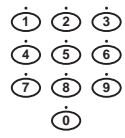

• If you input a wrong number, press CANCEL.

**4** Press ENTER. The password is now Off.



**5** Press ↑ or ↓ to select “Parental Level”. Then press → or ENTER. The Parental Level screen is displayed.

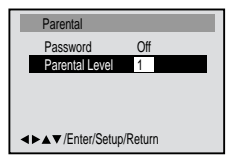
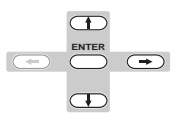

**6** Press ↑ or ↓ to select a level from Off or 1–8 and then press → or ENTER.

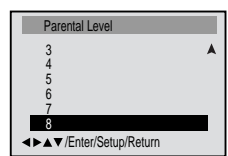
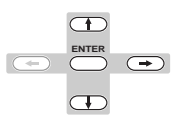

**7** Press ↑ or ↓ to select “Password” and then press → or ENTER.

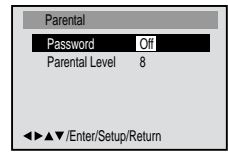
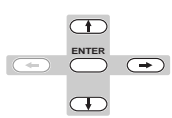

**8** Press number buttons (0–9) to enter a 4-digit password.

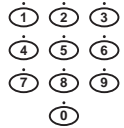

Now you can enter a new password.

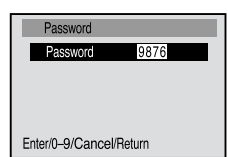

# To change the parental level (continued)/Temporary disabling of rating level by DVD disc

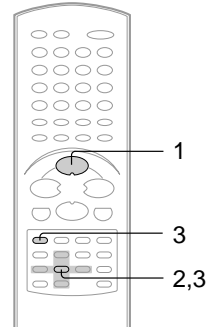

## 9 Press ENTER.

The parental level is now changed and locked.

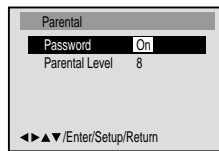
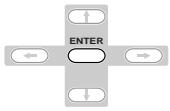

- If you want to return to the previous menu, press **←** or **RETURN**.

## 10 Press SETUP to remove the parental control screen.



### Note:

Do not forget the password. If you forget the password, contact the dealer that you purchased the unit from.

## DVD Temporary disabling of rating level by DVD disc

Depending on the DVD disc, the disc may try to temporarily cancel the rating level that you have set. It is up to you to decide whether to cancel the rating level or not.

## 1 Load a DVD disc and press PLAY (see page 50).

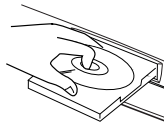

## 2 If the DVD disc has been designed to temporarily cancel the Rating level, the screen which appears after inserting a DVD will change, depending on which disc is played. If you select "YES" with the ENTER key, "Your disc exceeds the parental control level." screen will then appear.

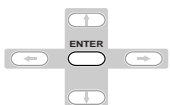
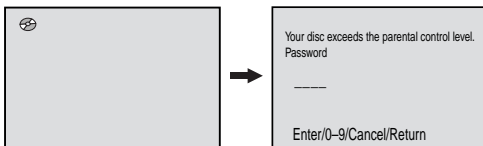

## 3 If you wish to cancel the set rating level temporarily, enter the 4-digit password.

Then press ENTER.

Alternatively, if the password has not been set, playback will commence. If you don't know (or have forgotten) the password, select "STOP". The setting screen will disappear.

Press OPEN/CLOSE to remove the disc.

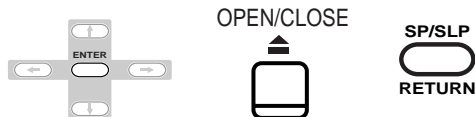

To quit entering, press **RETURN**.

## 4 Playback will commence if the entered password was correct.

### Notes:

- This temporary cancellation of rating level will be kept until the disc is ejected.
- When the disc is ejected, the original rating level will be set again automatically.

## Before calling service personnel

Check the following guide for the possible cause of a problem before contacting service.

### Symptoms and correction

SYMPTOMS	CAUSE	POSSIBLE SOLUTIONS	PAGE
<b>POWER</b>			
No power.	The AC power cord is not connected.	Connect the AC power cord to the AC outlet.	5
Although the power is on, the unit does not operate.	Cassette or disc is not inserted.	Insert a video cassette or disc.	35, 50
	The TIMER REC buttons are depressed.	Press the TIMER REC buttons.	43
<b>TV BROADCAST RECEPTION</b>			
Poor or no picture.	TV station experiencing problems.	Try another channel.	23
	Picture control is not adjusted.	Check picture control adjustments.	33
	Possible local interference.	Check for source of reception disturbance.	64
	Antenna (CATV) connector is not connected or possible local interference.	Check CATV connection or VHF/UHF antenna, reposition or rotate antenna.	14, 15
Poor or no color.	TV station experiencing problems.	Try another channel.	23
	Picture control is not adjusted.	Check picture control adjustments.	33
	Possible local interference.	Check for source of reception disturbance.	64
	Antenna (CATV) connector is not connected or possible local interference.	Check CATV connection or VHF/UHF antenna, reposition or rotate antenna.	14, 15
Picture wobbles or drifts.	TV station experiencing problems.	Try another channel.	23
	Antenna (CATV) connector is not connected or possible local interference.	Check CATV connection or VHF/UHF antenna, reposition or rotate antenna.	14, 15
	Cable TV channel is scrambled.	Try another channel.	23
No CATV reception.	CATV connector is not connected.	Check all CATV connections.	15
	TV/CATV Mode menu option is set to the TV mode.	Set the TV/CATV Menu option to the CATV mode.	26
	Cable TV service interrupted.	Contact your Cable TV company.	15
No reception above channel 13.	TV/CATV Mode menu option is not set to the appropriate mode.	Make sure TV/CATV menu option is in the appropriate mode.	26
	UHF antenna is not connected.	Check UHF antenna.	14
Poor or no sound.	TV station experiencing problems.	Try another channel.	23
	Antenna (CATV) connector is not connected or possible local interference.	Check CATV connection or VHF/UHF antenna, reposition or rotate antenna.	14, 15
	Possible local interference.	Check for source of reception disturbance.	64
	The MUTE button is depressed.	Check the MUTE button has not been pressed.	24
TV shuts off.	TV station stopped broadcasting.	Tune new channel.	23
	Sleep timer is set.	Set Sleep Timer to "0".	24
Closed caption is not activated.	TV station experiencing problems or program tuned is not closed captions.	Try another channel.	23
	TV signal is weak.	Check CATV connection of VHF/UHF antenna, reposition or rotate antenna.	14, 15
	The CLOSED CAPTION button is not depressed.	Press the CLOSED CAPTION button to turn on the closed caption.	25

SYMPTOMS	CAUSE	POSSIBLE SOLUTIONS	PAGE
<b>VCR</b>			
TV recording does not work.	The video cassette's erase prevention tab is broken off.	Place a piece of adhesive tape over the hole.	35
Timer recording does not work.	The time is not set correctly.	Reset the present time.	20-22
	The recording start/end time is not set correctly.	Reset the start/end time.	43
	The TIMER REC buttons have not been pressed at the same time (the TIMER REC indicator is not lit).	Press the TIMER REC buttons at the same time (the TIMER REC indicator is lit).	43
Noise bars appear on the screen.	Tape is old or worn.	Replace the tape.	–
	Tracking adjustment is beyond range of automatic tracking circuit.	Adjust tracking manually using the TRK +/- buttons on the remote control.	37
	Video heads are dirty.	Clean the video heads.	39
<b>DVD</b>			
The playback picture has occasional distortion.	The disc is dirty.	Eject the disc and clean it.	7
	It is in fast forward or fast reverse playback.	Some times a small amount of picture distortion may appear. This is not a malfunction.	–
The unit does not start playback.	No disc is inserted.	Insert a disc.	50
	An unplayable disc is inserted.	Insert a playable disc (Check the disc type and color system).	8
	The disc is placed upside down.	Place the disc with the playback side down.	50
	The disc is not placed within the guide.	Place the disc correctly inside the guide on the disc tray.	50
	The disc is dirty.	Clean the disc.	7
	The parental lock function is set.	Cancel the parental lock function or change the parental lock level.	59, 61
Playback does not follow the course of the disc's program	It is in the mode of repeat playback, memory playback, etc.	These operations may prevent a proper progress of the contents.	–
⊘ appears on the screen.	The function is prohibited with the unit or the disc.	–	8
<b>REMOTE CONTROL</b>			
Remote control does not operate.	The remote control is not aimed at the sensor.	Aim the remote control at the remote sensor.	13
	Distance is too far or too much light in the room.	Operate within 7 m or reduce the light of the room.	13
	There is an obstacle in the path of the beam.	Clear the path of the beam.	13
	The batteries are weak.	Replace the batteries.	13
	The batteries are not inserted correctly.	Insert correctly.	13

## Reception disturbances

Most types of television interference can be remedied by adjusting the height and position of the VHF/UHF antenna. Outdoor antennas are recommended for best results. The most common types of television interference are shown below. If one of these symptoms appear when the unit is connected to a Cable TV system, the disturbance may be caused by the local Cable TV company broadcast.

### IGNITION

Black spots or horizontal streaks may appear, the picture may flutter or drift. Usually caused by interference from automobile ignition systems, neon lamps or AC powered tools and appliances such as drills or hair dryers.



### GHOSTS

Ghosts are caused by the television signal following two paths. One is the direct path and the other is reflected by tall buildings, hills or other large objects. Changing the direction or position of the antenna may improve the reception.



### SNOW

If the TV/VCR/DVD is located far from the TV station, in a fringe reception area where the signal is weak, small dots may appear in the picture. If the signal is extremely weak, the installation of a larger external antenna may be necessary.



### RADIO FREQUENCY INTERFERENCE (RFI)

Caused by two-way radios, this type of interference produces moving ripples or diagonal streaks in the picture. Some cases may cause a loss of contrast in the picture. Changing the direction and position of the antenna or installing an RFI filter may improve the picture.

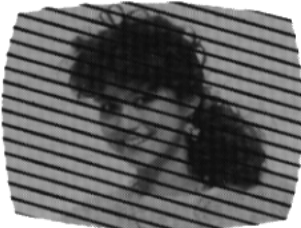

### PICTURE SIZE VARIATION

A slight picture size variation is normal when you adjust the CONTRAST or BRIGHTNESS settings.



## CARE AND MAINTENANCE

To prevent fire or shock hazard, disconnect the unit from the power source before cleaning. The finish on the cabinet may be cleaned with mild soap and a soft, damp cloth and cared for as other furniture. Use caution when cleaning or wiping the plastic parts.



## Language code list

Enter the appropriate code number for the initial settings "Menu", "Audio" and/or "Subtitle" (see page 56).

Language Name	Code	Language Name	Code	Language Name	Code	Language Name	Code
Abkhazian	1112	Fiji	1620	Lingala	2224	Singhalese	2919
Afar	1111	Finnish	1619	Lithuanian	2230	Slovak	2921
Afrikaans	1116	French	1628	Macedonian	2321	Slovenian	2922
Albanian	2927	Frisian	1635	Malagasy	2317	Somali	2925
Amharic	1123	Galician	1722	Malay	2329	Spanish	1529
Arabic	1128	Georgian	2111	Malayalam	2322	Sundanese	2931
Armenian	1835	German	1415	Maltese	2330	Swahili	2933
Assamese	1129	Greek	1522	Maori	2319	Swedish	2932
Aymara	1135	Greenlandic	2122	Marathi	2328	Tagalog	3022
Azerbaijani	1136	Guarani	1724	Moldavian	2325	Tajik	3017
Bashkir	1211	Gujarati	1731	Mongolian	2324	Tamil	3011
Basque	1531	Hausa	1811	Nauru	2411	Tatar	3030
Bengali; Bangla	1224	Hebrew	1933	Nepali	2415	Telugu	3015
Bhutani	1436	Hindi	1819	Norwegian	2425	Thai	3018
Bihari	1218	Hungarian	1831	Oriya	2528	Tibetan	1225
Breton	1228	Icelandic	1929	Panjabi	2611	Tigrinya	3019
Bulgarian	1217	Indonesian	1924	Pashto, Pushto	2629	Tonga	3025
Burmese	2335	Interlingua	1911	Persian	1611	Turkish	3028
Byelorussian	1215	Irish	1711	Polish	2622	Turkmen	3021
Cambodian	2123	Italian	1930	Portuguese	2630	Twi	3033
Catalan	1311	Japanese	2011	Quechua	2731	Ukrainian	3121
Chinese	3618	Javanese	2033	Rhaeto-Romance	2823	Urdu	3128
Corsican	1325	Kannada	2124	Romanian	2825	Uzbek	3136
Croatian	1828	Kashmiri	2129	Russian	2831	Vietnamese	3219
Czech	1329	Kazakh	2121	Samoan	2923	Volapük	3225
Danish	1411	Kirghiz	2135	Sanskrit	2911	Welsh	1335
Dutch	2422	Korean	2125	Scots Gaelic	1714	Wolof	3325
English	1524	Kurdish	2131	Serbian	2928	Xhosa	3418
Esperanto	1525	Laothian	2225	Serbo-Croatian	2918	Yiddish	2019
Estonian	1530	Latin	2211	Shona	2924	Yoruba	3525
Faroese	1625	Latvian, Lettish	2232	Sindhi	2914	Zulu	3631



# Specifications

## General / input / output / supplied accessories

### GENERAL

	MW20FN3/R	MW24FN3/R
Picture Tube	Type 20 (508mm diagonal)	Type 24 (600mm diagonal)
Speaker	1-13/16 (46mm) × 3-7/8 (99mm) inches, 8 ohm × 2	
Audio Output Power	1.5W + 1.5W	
Power supply	AC 120V 60Hz	
Power consumption	Operation: 110W, Standby: 4W	Operation: 135W, Standby: 4W
Weight	59.5 lbs (27.0 kg)	79.4 lbs (36.0 kg)
Dimensions	Width : 22-9/16 inches (573 mm) Height : 20-3/8 inches (517 mm) Depth : 19-15/16 inches (482 mm)	Width : 25-13/16 inches (655 mm) Height : 22-13/16 inches (580 mm) Depth : 18-5/8 inches (473.5 mm)
Operating conditions	Temperature: 5°C-40°C (41°F-104°F), Operating status: Horizontal	
Tuner	181 channel freq. synthesized VHF 2-13 UHF 14-69 CATV 113 Channels	
Antenna input/output	UHF/VHF In : 75 ohm coaxial	
Color system	NTSC	
Video head	4 Rotary heads	
Audio track	Hi-Fi sound - 2 Tracks / MONO sound - 1 Track	
Hi-Fi frequency response	20Hz to 20,000Hz	
Hi-Fi dynamic range	More than 90dB	
F.FWD/REW time at 25°C (77°F)	Approx. 1minute and 48 seconds (with T-120 Cassette Tape)	
Applicable disc (DVD)	DVD (12cm, 8cm), CD (12cm, 8cm)	
Frequency range (DVD)	DVD linear sound: 48 kHz sampling 4Hz-22kHz 96 kHz sampling 4Hz-44 kHz	
S/N ratio (DVD)	90dB	
Harmonic distortion (DVD)	0.06%	
Wow and flutter (DVD)	Less than 0.01% Wrms	
Dynamic range (DVD)	More than 90dB	

### Input/Output

Video input	1.0 V (p-p), 75 Ω, negative sync., pin jack x 2
Video output	1.0 V (p-p), 75 Ω, negative sync., pin jack x 1
Audio input	- 8.0 dBm, 50k Ω. negative sync., pin jack (L/R) x 2
Audio output	- 8.0 dBm, 1k Ω. negative sync., pin jack (L/R) x 1
Audio output (BITSTREAM/PCM COAXIAL)	0.5V (p-p), 75 Ω, pin jack × 1

### Supplied accessories

300-75 ohm Matching Transformer .....	1
Remote control .....	1
Batteries (AAA) .....	2

- Designs and specifications are subject to change without notice.
- Tape Speed shown is approximate.

## **Limited warranty**

Toshiba America Consumer Products, Inc. ("TACP") and Toshiba Hawaii Inc. ("THI") make the following limited warranties. These limited warranties extend to the original consumer purchaser or any person receiving this set as a gift from the original consumer purchaser and to no other purchaser or transferee .

### **Limited Ninety (90) Day Warranty**

TACP and THI warrant this product and its parts against defects in materials or workmanship for a period of ninety (90) days after the date of original retail purchase. During this period, TACP and THI will repair a defective product or part, without charge to you. You must deliver the entire set to an Authorized TACP/THI Service Station. You pay for all transportation and insurance charges for the set to and from the Service Station.

### **Limited One (1) Year Warranty**

TACP/THI further warrant the parts in this product against defects in materials or workmanship for a period of one year after the date of original retail purchase. During this period TACP/THI will replace a defective part without charge to you, except that if a defective part is replaced after ninety (90) days from the date of original retail purchase you pay labor charges involved in the replacement. You must also deliver the entire product to a TACP/THI Authorized Service Station. You are responsible for all transportation for the set to and from the Service Station.

### **Limited Two (2) Year Warranty of Picture Tube**

TACP and THI further warrant the picture tube in this product against defects in materials or workmanship for a period of two (2) years after the date of original retail purchase. During this period, TACP/THI will replace a defective picture tube without charge to you except that if a defective picture tube is replaced after ninety (90) days from the date of the original retail purchase, you pay labor charges involved in the replacement. You are responsible for all charges involved in the replacement. You are responsible for all transportation and insurance charges for the set to and from the Service Station.

### **Rental Units**

The warranty for rental units begins with the first rental or thirty (30) days from the date of shipment to the rental firm, whichever comes first.

### **Commercial Units**

Products sold and used for commercial use have a limited ninety (90) day warranty for all parts, labor and picture tube.

### **Owner's Manual and Demographic Card**

You should read this owner's manual thoroughly before operating this product. You should complete and mail the enclosed Demographic card within ten days after you, or the person who has given you this product as a gift, purchased this product. This is one way to enable TACP/THI to provide you with better customer service and improved products. Failure to return the Demographic card will not affect your rights under this warranty.

### **Your Responsibility**

The above warranties are subject to the following conditions:

- ( 1 ) You must retain your bill of sale or provide other proof of purchase.
- ( 2 ) All warranty servicing of this product must be made by an Authorized TACP/THI Service Station.
- ( 3 ) These warranties are effective only if the product is purchased and operated in the U.S.A. or Puerto Rico.
- ( 4 ) Labor service charges for set installation, set up, adjustment of customer controls and installation or repair of antenna systems are not covered by this warranty. Reception problems caused by inadequate antenna systems are your responsibility.
- ( 5 ) Warranties extend only to defects in materials or workmanship as limited above and do not extend to any product or parts which have been lost or discarded by you or to damage to products or parts caused by misuse, accident, damage caused by Acts of God, such as lightning or fluctuations in electric power, improper installation, improper maintenance or use in violation of instructions furnished by us; or to units which have been altered or modified without authorization of TACP/THI .

## How to Obtain Warranty Service

If after following all of the operating instructions in this manual and checking the section "Before calling service personnel" and you still find that service is needed;

- ( 1 ) Call the TACP toll free number 1-800-631-3811 after you find a defective product or part to find the nearest Toshiba Authorized Service Station.
- ( 2 ) Please present your bill of sale or other proof to the Authorized Service Station.  
"TACP/THI Authorized Service Station personnel will come to your home when warranty service is required. Depending on the type of repair required, the service will either be performed in your home or the set will be taken to the TACP/THI Authorized Service Station for repair and returned to your home at no cost to you".

**In the Continental United States contact:**



**In Hawaii Contact:**

Toshiba Hawaii, Inc  
327 Kamakee Street,  
Honolulu, Hawaii 96814  
(808) 591-8377

All warranties implied by state law, including the implied warranties of merchantability and fitness for a particular purpose, are expressly limited to the duration of the limited warranties set forth above. With the exception of any warranties implied by state law as hereby limited, the foregoing warranty is exclusive and in lieu of all other warranties, guarantees, agreements and similar obligations of manufacturer or seller with respect to the repair or replacement of any parts. In no event shall TACP or THI be liable for consequential or incidental damages.

No person, agent, distributor, dealer or company is authorized to change, modify or extend the terms of these warranties in any manner whatsoever. The time within which action must be commenced to enforce any obligation of TACP or THI arising under this warranty or under any statute, or law of the United States or any state thereof, is hereby limited to 90 days from the date you discover or should have discovered, the defect. This limitation does not apply to implied warranties arising under state law.

This warranty gives you specific legal rights and you may also have other rights which may vary from state to state. Some states do not allow limitation on how long an implied warranty lasts, when an action may be brought, or the exclusion or limitation of incidental or consequential damages, so the above provisions may not apply to you.



### ATTENTION CANADIAN CONSUMERS:

Canadian consumers are requested to complete the special Canadian "Warranty Registration Form" enclosed, and forward this completed form with a copy of bill of sale to TOSHIBA OF CANADA to "Register and Validate" their warranty.

Products purchased in the U.S.A. and used in Canada are not covered by these warranties.

Products purchased in Canada and used in the U.S.A. are not covered by these warranties.

Rev. 09-01-98

# TOSHIBA

**TOSHIBA AMERICA CONSUMER PRODUCTS, INC.**

## Free Manuals Download Website

<http://myh66.com>

<http://usermanuals.us>

<http://www.somanuals.com>

<http://www.4manuals.cc>

<http://www.manual-lib.com>

<http://www.404manual.com>

<http://www.luxmanual.com>

<http://aubethermostatmanual.com>

Golf course search by state

<http://golfingnear.com>

Email search by domain

<http://emailbydomain.com>

Auto manuals search

<http://auto.somanuals.com>

TV manuals search

<http://tv.somanuals.com>