

***Strata***<sup>®</sup> ***DK***

Digital Business Telephone Systems

**DKT2004-CT**  
**Cordless Digital Telephone**  
**User Guide**

---

September 2000

---

## Publication Information

Toshiba America Information Systems, Inc., Telecommunication Systems Division, reserves the right, without prior notice, to revise this information publication for any reason, including, but not limited to, utilization of new advances in the state of technical arts or to simply change the design of this document.

Further, Toshiba America Information Systems, Inc., Telecommunication Systems Division, also reserves the right, without prior notice, to make such changes in equipment design or components as engineering or manufacturing methods may warrant.

DKA-UG-CRDLS-VC  
4016149

Version C.3, September 2000

## © Copyright 2000

### **Toshiba America Information Systems, Inc. Telecommunication Systems Division**

All rights reserved. No part of this manual, covered by the copyrights hereon, may be reproduced in any form or by any means—graphic, electronic, or mechanical, including recording, taping, photocopying, or information retrieval systems—without express written permission of the publisher of this material.

Strata is a registered trademark of Toshiba Corporation. Strategy is a registered trademark of Toshiba America Information Systems, Inc.

Trademarks, registered trademarks, and service marks are the property of their respective owners.

# Contents

---

## Introduction

Organization.....	v
How to Use this Manual .....	vi
Conventions .....	vii
Important Safety Instructions.....	viii
Related Documents .....	x

## Chapter 1 – The Grand Tour

Applications .....	2
Benefits .....	3
Cordless Digital Telephone Standard Parts .....	4
Base Unit Controls and Functions .....	5
Features .....	6

## Chapter 2 – Installation

Removing and Charging Your Battery Pack .....	12
Charging Extra Battery Packs.....	13
Tips on Extending Battery Pack Life.....	14
Battery Memory Effect.....	14
LCD Low Battery Indicator.....	14

**Chapter 3 – Configuration**

Entering Program Mode.....	16
----------------------------	----

**Chapter 4 – The Handset**

Handset Controls.....	19
Handset Volume Level .....	19
Ringer Volume Level .....	20
Mute.....	20
Using the Handset.....	21
Charging the Handset.....	22
Switching a Call to Your Cordless Digital Telephone.....	23
Switching a Call to the Desk Telephone.....	24
Using Memory .....	25
Chain Dialing.....	27

**Chapter 5 – Features**

Before You Begin .....	30
Quick Reference.....	31
Making an Outside Call.....	31
Making an Outside Call to an ISDN Trunk.....	33
Making an Internal Call.....	33
Answering Calls.....	34
Transferring Calls.....	34
Conferencing Calls .....	35
Placing/Retrieving Calls on Hold .....	37
Using Automatic Hold.....	38
Calling the Attendant Console.....	39
Tone/Pulse Dialing .....	40
Account Code Calls .....	40
Forced Account Codes.....	40
Emergency Override of Forced Account Codes.....	41
Voluntary Account Codes.....	41
Verified Account Codes .....	42
Alarm Reset .....	42
Alert Signaling .....	42

Automatic Busy Redial (ABR) .....	43
Automatic Callback .....	44
Line Queuing with Automatic Callback .....	45
Auto Redial .....	46
Call Forward .....	46
Call Forward-All Calls .....	47
Call Forward-Busy.....	48
Call Forward-No Answer .....	48
Call Forward-Busy/No Answer .....	49
Call Forward-Cancel.....	50
Call Forward-External .....	51
Call Forward-Fixed.....	52
Call Park Orbits (Release 3 or later) .....	52
Call Park and Page.....	53
Call Pickup.....	54
Directed Call Pickup.....	54
Group Pickup .....	55
Calls to Other Groups .....	55
Call Waiting .....	56
Direct Station Selection Buttons (Hotline) .....	57
Do Not Disturb (DND) .....	57
Door Lock .....	58
Door Telephone .....	59
ISDN Outgoing Calling .....	60
Subaddress .....	61
LCD Name/Number Display .....	61
Messaging .....	63
Calling Station Messaging.....	63
Cancelling a Calling Station Message .....	63
Message Waiting.....	64
[PhDN/MW] Message Waiting .....	66
Off-hook Call Announce (OCA) .....	67
Activating Off-hook Announce (OCA).....	67
Handset Off-hook Call Announce (HS-OCA) Calling .....	67
Speaker Off-hook Call Announce (SP-OCA).....	69
Override Calls .....	70

## Contents

### Chapter 5 – Features

Busy Override .....	70
DND Override .....	70
Executive Override .....	71
Page Announcements .....	71
Privacy On-Line .....	71
Privacy Release .....	73
Release and Answer .....	74
Speed Dial .....	74
Storing Station Speed Dial Numbers .....	75
Stored Station or System Speed Dial Calling .....	76
Timed Reminders .....	77
Toll Restriction Override .....	79
Two (Tandem) Line Connection .....	80
Using a [DN] Button .....	80
Using Line Buttons .....	81

## Appendix

Installing Optional Headset .....	84
Troubleshooting .....	85
Range and Performance .....	86
Nine Simultaneous Conversation Channels .....	87
Radio Interference .....	87
Specifications .....	88
Available Optional or Replacement Items .....	89
Access Codes .....	90
CO Line Access Codes .....	94
Feature Access Codes .....	95
Paging Group Codes .....	95
Speed Dial Access Codes .....	96

<b>Index</b> .....	97
--------------------	----

# Introduction

---

This guide describes the features and operation of the Toshiba DKT2004-CT 900 MHz Cordless Digital Telephone with Strata DK Business Telephone Systems. To get the most from your cordless digital telephone, please read this guide thoroughly. The Strata DK systems which support this equipment are:

- ◆ DK14
- ◆ DK16e and 16
- ◆ DK40i and 40
- ◆ DK424i, DK424 and DK280 (Release 3.0 or higher)

Your Toshiba Cordless Digital Telephone also works with Strata DK24/56/96 systems. For Strata DK24/56/96, Release 4; Strata DK14, DK40, and DK40i see the “Access Codes” section of the Appendix for differences in operation.

## Organization

This user guide is divided as follows:

- ◆ **Chapter 1 – The Grand Tour** covers an equipment overview by describing the features associated with the cordless digital telephone.
- ◆ **Chapter 2 – Installation** covers instructions for installing your cordless digital telephone with your Strata DK System.

- ◆ **Chapter 3 – Configuration** covers the configuration options for optimizing the performance of your cordless phone.
- ◆ **Chapter 4 – Using the Handset** covers the various controls and features related to operating your cordless phone.
- ◆ **Chapter 5 – Operation** covers the practical operation of the cordless digital telephone features.
- ◆ **Appendix** covers descriptions of the Optional Headset, Installation, Troubleshooting, Range, Telephone Line Problems, Specifications, Available Optional or Replacement Items, and Access Codes.

**Important!** *Before using your new cordless phone, the battery must be charged continuously for 10 hours.*

## How to Use this Manual



You can use this guide in a variety of ways, depending on your level of experience with the system and your assigned password level.

If you are a new user of DKAdmin/DKBackup, you should attempt to read this entire guide. It introduces you to all the features and procedures of the system and enables you to work with DKAdmin/DKBackup quickly.

If you are proficient in using DKAdmin/DKBackup, you may still have questions from time-to-time about a particular function or procedure. Use the Index to locate a subject or item that you may have questions about, or scan the Contents.



# Conventions

Conventions	Description
<b>Note</b>	Elaborates specific items or references other information. Within some tables, general notes apply to the entire table and numbered notes apply to specific items.
<b>Important!</b>	Calls attention to important instructions or information.
<b>CAUTION!</b>	Advises you that hardware, software applications, or data could be damaged if the instructions are not followed closely.
	Alerts you to precautions noted both on the equipment and in this guide.
<b>WARNING!</b>	Alerts you when the given task could cause personal injury or death.
[PDN]	Represents any Primary Directory Number button (the extension number for the telephone).
[SDN]	Represents any Secondary appearance of a PDN. A PDN that appears on another telephone is considered an SDN.
[PhDN]	Represents any Phantom Directory Number button (an additional DN).
[DN]	any Directory Number button (also known as an Extension or Intercom Number).
<b>Arial Bold</b>	letters represent telephone buttons. For example: <b>999#</b> .
	Denotes the step in a one-step procedure.
<b>Tilde (~)</b>	Means “through.” Example: 350 ~ 640 Hz frequency range.
<b>+</b>	is used for multiple key entries. For example: Press <b>Speed Dial + XX + Redial + Spkr (XX = 08~60 seconds)</b> .

# Important Safety Instructions

**WARNING!** When using your telephone equipment, always follow basic safety precautions to reduce the risk of fire, electrical shock, and personal injury, including the following.

- Read and understand all instructions.
- Follow all warnings and instructions marked on the product.
- Unplug this product from the wall outlet before cleaning. Do not use liquid cleaners or aerosol cleaners. Use a dry cloth for cleaning.
- Do not use this product near water; for example, near a sink or in a wet area.
- Do not place this product on an unstable cart, stand, or table. The telephone may fall, causing serious damage to the unit.
- To protect the product from overheating, do not block or cover any slots or openings in the base Unit. This product should never be placed near or over a radiator or heat register. This product should not be placed in an enclosed cabinet unless proper ventilation is provided.
- Operate this product only from the type of power source indicated on the marking label.
- Do not allow anything to rest on the power cord. Do not locate this product where the cord will be damaged by persons walking on it.
- Do not overload wall outlets and extension cords, as this can result in the risk of fire or electrical shock.
- Never push objects of any kind into this product through the Base Unit slots, as they may touch dangerous voltage points or short out parts that could result in a risk of fire or electric shock. Never spill liquid of any kind on the product.
- To reduce the risk of electric shock, do not disassemble this product. Contact qualified service personnel when service or repair work is required. Opening or removing covers may expose you to dangerous voltages or other risks. Incorrect reassembly can cause electric shock when the appliance is subsequently used.

- Unplug this product from the wall outlet and refer servicing to qualified service personnel under the following conditions:
  - ◆ When the power supply cord is damaged or frayed.
  - ◆ If liquid has been spilled into the product.
  - ◆ If the product has been exposed to rain or water.
  - ◆ If the product does not operate normally when following the operating instructions. Adjust only those controls that are covered by the operating instructions. Improper adjustment of other controls may result in damage, and will often require extensive work by a qualified technician to restore the product to normal operation.
  - ◆ If the product has been dropped, or the cabinet has been damaged.
  - ◆ If the product exhibits a distinct change in performance.
- Do not use the telephone to report a gas leak in the vicinity of the leak.

**WARNING! To reduce the risk of fire or injury to persons by the battery, follow these instructions:**

- Use only battery pack model EXP9580 or EXP9586. Use of any other battery may cause a safety hazard.
- Do not dispose of the battery pack in a fire. The cell may explode. Under federal, state and local laws, it may be illegal to dispose of old batteries by placing them in the trash. Check with your local government for information on where to recycle or dispose of old batteries. If you cannot find the information you need, contact Toshiba for assistance.
- Do not open or mutilate the battery pack. Released electrolyte is corrosive and may cause damage to the eyes or skin, and, if swallowed, may be toxic. Cadmium is a chemical known to the State of California to cause cancer.
- Exercise care in handling the battery in order not to short the battery with conducting materials such as rings, bracelets, and keys. The battery or conductor may overheat and cause burns.
- Charge the battery pack provided with or identified for use with this product only

## Introduction

### *Related Documents*

in accordance with the instructions and limitations specified in the instruction manual provided for this product.

- Observe proper polarity orientation between the battery pack and battery charger.

## Related Documents

**Note** Some documents listed here may appear in different versions on the CD-ROM, FYI, or in print. To find the most current version, check the version/date in the Publication Information on the back of the document's title page.

The following documents and CD-ROMS can be used to reference further information about the Strata DK systems.

- ◆ Strata DK Programming Manual
- ◆ Strata DK Installation & Maintenance Manual
- ◆ Strata DK Library CD-ROM

For authorized users, Internet site FYI (<http://fyi.tsd.toshiba.com>) contains all current Strata DK documentation and enables you to view, print, and download current publications.

Your cordless digital telephone is designed and engineered to work with your Toshiba digital telephone system and provide you with reliability, long life, and outstanding performance. The cordless digital telephone is compatible with all Strata DK systems that support digital telephones (except Strata DK24/56/96 Release 3). All it requires for connection is a digital station port.

Your cordless digital telephone uses digital 900 MHz spread-spectrum technology, which represents state-of-the-art design and engineering. This provides unsurpassed range, several times greater than conventional analog or cordless digital telephones. It provides clarity that is so good, it is indistinguishable from corded telephones in most environments. It also provides fully secure communications for up to nine cordless digital telephones within a given environment.

Fully charged, your cordless digital telephone provides over 3 hours of talk time and 42 hours of standby. There is a fast charger in the handset and a trickle charger in the base.

The cordless digital telephone provides many of the same features as a 2000-series corded digital key telephone (DKT):

- ◆ 20-character Liquid Crystal Display LCD (displays top 16 characters of DKT)
- ◆ Four programmable buttons for feature or multiple-line access (same as first four buttons on DKT station port)
- ◆ Headset jack

## The Grand Tour

### Applications

- ◆ Handset volume adjustment (three levels)
- ◆ Two ring levels and a vibration mode
- ◆ **Cnf/Trn** button
- ◆ **Msg** button with Message Waiting LED
- ◆ **Hold** button
- ◆ Twenty-speed dial memory (stored in the telephone separate from 40 individual and system speed dial numbers)

Your cordless digital telephone offers two different modes of operation. You can use it either in conjunction with a 2000-series digital telephone, or on a stand-alone basis. When used with a DKT, both the cordless digital telephone and the DKT share the same digital station port on the PDKU. It also shares the same extension number.

You can switch between use of your DKT and your cordless, just by pressing a button. When used on a stand-alone basis, the cordless digital telephone attaches to its own digital station port on the PDKU.

Several useful accessories are available:

- ◆ Base wall mount
- ◆ Headset
- ◆ Heavy duty 5.5-hour battery
- ◆ Separate deep cycle charger

## Applications

Your cordless digital telephone brings mobility and productivity to office telephones. Greater call access cuts down on “telephone tag” delays. Its compact design makes it easy to take with you.

## Benefits

Your cordless digital telephone uses advanced technology and provides important features that place it far above the competition in functionality and value. You benefit from much greater performance than other cordless telephones currently available. This means better sound quality, longer range, greater security, multi-line access, helpful LCD display information, and many other important advantages.

The cordless digital telephone provides many advantages over a single-line analog or digital telephone. Some of those advantages are:

- ◆ Multi-line access is available on up to four programmable buttons. These buttons can be used for CO line appearances, multiple [DN] appearances, or features. If the cordless telephone is attached to a 2000-series desk telephone, the four programmable buttons are the same as the first four buttons on the desk DKT.
- ◆ Your cordless digital telephone rings to the same extension number as the regular DKT it is used with, enabling you to answer via either telephone. Both follow the same forwarding and hunting regardless of which telephone is in use. This is much simpler than having a separate extension number and standard station port for a single-line cordless, in which, if you use both phones, you must forward the DKT telephone to the single-line telephone (SLT).

An SLT cordless is not only a cumbersome alternative to the Toshiba digital cordless; but also, if you forget to forward your calls, you cannot receive the calls on your SLT cordless. With your cordless digital telephone it is easy. Just press a button, grab your cordless, and go!

- ◆ Message Waiting LED that is activated just like any regular DKT. This is a big advantage over a single-line cordless, which, for example, cannot light message waiting from voice mail.
- ◆ Spread-spectrum technology provides five to seven times greater range than conventional cordless telephones, making your cordless digital telephone much more useful and valuable.
- ◆ 900 MHz spread-spectrum operation provides maximum security with a frequency range that is almost impossible to scan. Regular 900 MHz cordless digital telephones are difficult to scan, but less so than spread spectrum. Analog cordless telephone frequencies are easy to scan and provide virtually no security from the outside. Hackers and thieves can use this to hear conversations and pick up credit card numbers.

## The Grand Tour

### *Cordless Digital Telephone Standard Parts*

- ◆ Sound quality is better on your cordless digital telephone than non-spread spectrum 900 MHz digital cordless phones. Sound quality on conventional analog cordless telephones is so poor by comparison that they are only practical for short range usage.

## Cordless Digital Telephone Standard Parts

Your Toshiba cordless digital telephone includes the following items:

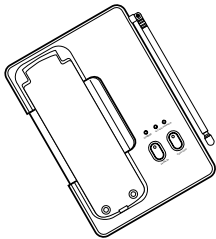

**Base Unit**



**Handset**

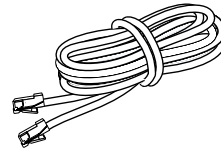

**Telephone Cord (2 ft.)**

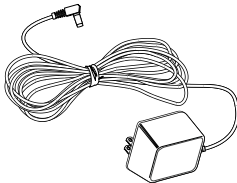

**AC Adapter**

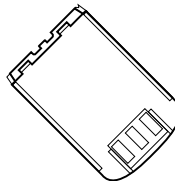

**Rechargeable Battery**

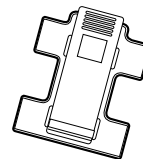

**Belt Clip**



**User Guide**

5395

If any of these items are missing or damaged, contact your System Administrator.



# Base Unit Controls and Functions

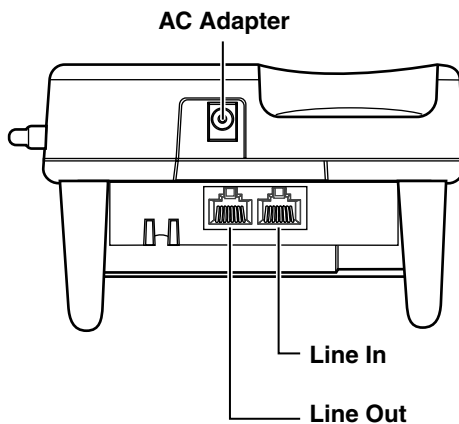
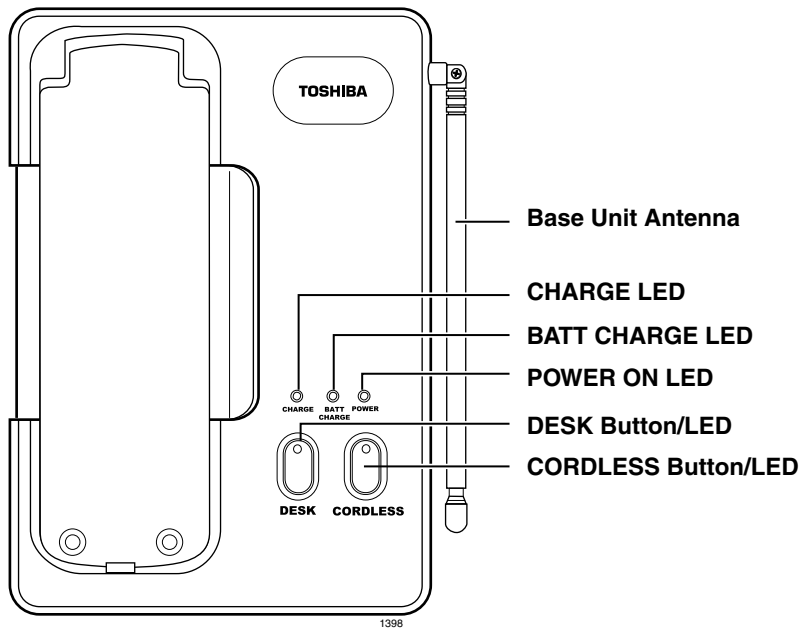

## **Features**

- ◆ Super Long Range 900 MHz Spread Spectrum
- ◆ 2-line, 10-digit LCD Display
- ◆ Headset Jack
- ◆ Ringer Volume Control
- ◆ Handset Volume Control
- ◆ Message Waiting LED
- ◆ Single button access to Conference, Hold, Message Waiting, and Transfer features
- ◆ Four Flexible Function Keys (First four keys of DKT port in Strata DK)
- ◆ 20-Number Memory Store and Search
- ◆ Battery Charging System for Optional Standby Battery
- ◆ 2-Way Handset Mounting
- ◆ Vibration Ringer Alert
- ◆ Compact Handset Design

**Important!** *Your telephone system must be programmed for Auto Preference for your **TALK** button to work. If there is a shared digital telephone, you receive internal system dial tone automatically after picking up the handset of your deskset. For example, in a DK424 system, Program 32 must have a setting other than "00." It is best to set Auto Line Preference to access Intercom dial tone.*

## Step 1: Select Location

1. Select a location for your cordless digital telephone. Avoid excessive heat or humidity.
2. Place the cordless digital telephone's base unit on a desk or tabletop near a standard 120V AC outlet and within reach of the digital telephone line connection to your Strata DK system.
3. Keep the base unit and handset away from sources of electrical noise (motors, fluorescent lighting, etc.).

**Important!** *Place the cordless telephone to the right of the DKT. If placed on the left of the DKT, the cordless antenna picks up a tone due to its close proximity to the DKT speaker and electronic parts.*

## Step 2: Connect Telephone Cords

Your cordless digital telephone can be used as a stand-alone telephone or in conjunction with your deskset.

There are two telephone line jacks on the back of the base unit of your cordless digital telephone: “Line In” and “Line Out.” You can connect your cordless digital telephone to both the telephone line and a Strata DK digital telephone.

➤ **To use as a stand-alone telephone**

- Connect the modular jack labeled “Line In” to the telephone wall jack.

➤ **To use with a desk telephone**

1. Unplug the telephone line cord from your desk telephone.
2. Connect this cord to “Line In” of your cordless telephone.
3. Using the two foot modular cord that came with your cordless telephone, connect the jack labeled “Line Out” to the desk telephone.

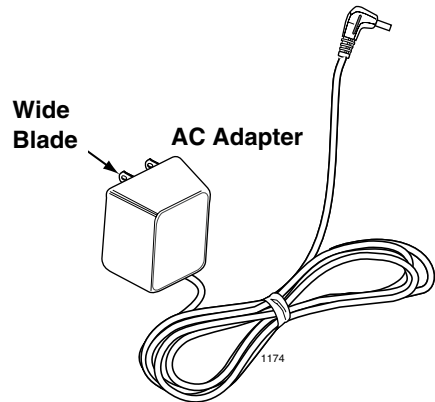

## Step 3: Connect and Apply Power to Base Unit

**Note** The AC adapter furnished with this telephone may be equipped with a polarized line plug (a plug having one blade wider than the other). This plug fits into the power outlet only one way. If you are unable to insert the plug fully into the outlet, try reversing the plug. If the plug still does not fit, contact your facilities coordinator about replacing the obsolete plug. Do not alter the shape of the blades on the polarized plug.

1. Plug the AC adapter cord into the AC adapter input jack on the base unit.

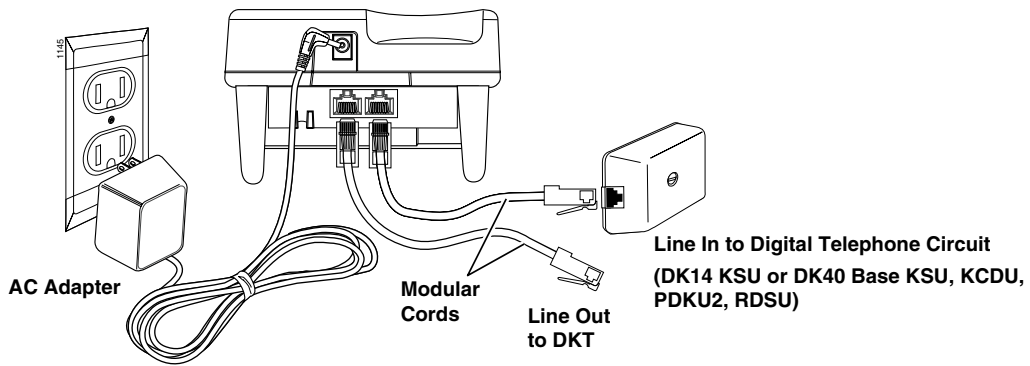



---

**CAUTION! Use only the AC adapter supplied with your cordless digital telephone.**

---

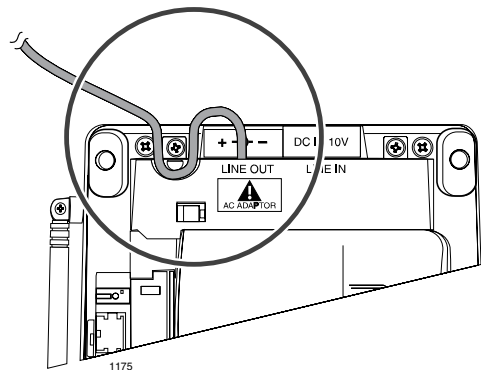
2. Plug the AC adapter into a standard 120 VAC wall outlet.
3. Route the power cord where it is not a trip hazard, and where it cannot become chafed and create a fire or electrical hazard.
4. Wrap the power cord around the notch on the bottom of the base unit as shown at the right.
5. Check to see that the power LED is on, indicating the telephone has power.



## Installation

### *Attach Belt Clip to Handset (optional)*

6. Before using your cordless digital telephone, be sure to raise the antenna to the vertical position.

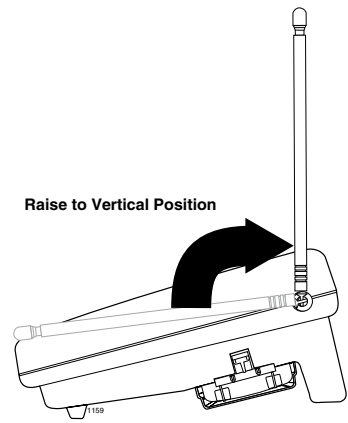

## Step 4: Attach Belt Clip to Handset (optional)

### ► To attach the belt clip to the handset

1. Snap the tabs of the belt clip into the notches on the sides of the handset.
2. Use the belt clip to attach the handset to your belt or pocket for convenient portability.

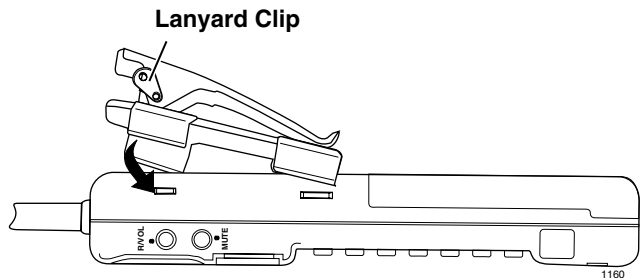

### ► To remove the belt clip

1. Pry one tab at a time from the notch on the side of the handset.
2. Carefully lift the belt clip off.

**Note** The belt clip is designed to fit snugly onto the handset.

## Step 5: Install Handset Battery Pack

1. Place a charged battery pack onto the handset so that it slides easily along the ridges.

If your battery is not charged, see [“Removing and Charging Your Battery Pack”](#) on Page 12.

2. Slide the battery pack up onto the handset until it clicks into place.

You are now ready to configure your cordless digital telephone. See [“Configuration”](#) on Page 15.

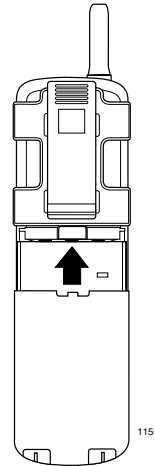

# Removing and Charging Your Battery Pack

**Important!** *Before using your new cordless digital telephone, the battery must be charged continuously for six to eight hours.*

## ► To remove the handset's battery pack

1. Press in on the battery pack release latch.
2. Slide the battery pack off the handset.

**Note** You may have to pull hard to slide the battery pack off, when the handset is new.

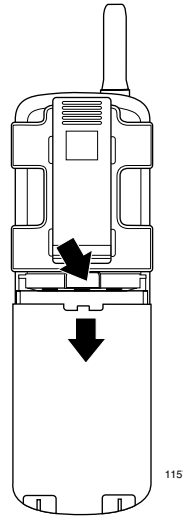

## ► To charge the handset's battery pack

1. Place the handset on the base unit.
2. Make sure the CHARGE LED lights. If it does not light, check to see that the AC adapter is plugged in and that the handset is making good contact with the base unit.



## Charging Extra Battery Packs

The base unit of your cordless digital telephone is equipped with a battery charger for charging an extra battery pack. This compartment has a latch that keeps the battery pack in place during charging.

### ► To charge extra battery packs

1. Position the battery pack so the inner side is facing toward the top of the base unit.
2. Slide the battery pack into the charging compartment until it clicks into place.
3. Make sure the BATTERY CHARGE LED lights. If it does not light, check to see that the AC adapter is plugged in, and that the battery pack is seated into the charging compartment.

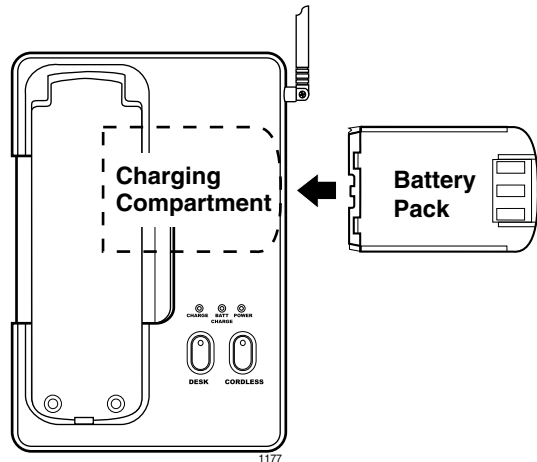

**Note** Charge the standard 400 mAh battery pack without interruption for six to eight hours. Charge the optional 730 mAh extended battery pack without interruption for eight to ten hours.

# Tips on Extending Battery Pack Life

## Battery Memory Effect

All rechargeable nickel cadmium batteries can develop a “memory” (reduced charge capacity) caused by repeated charge and discharge cycles. Batteries that have developed this effect do not operate to their fullest capacity.

### ➤ To avoid memory effect

- Operate the unit until the battery pack is completely discharged before recharging. For example, use the handset off the base all day. Only replace the handset on the base at night after a full day of use. Do not “top off” the charge after using the battery for a short time.

### ➤ To erase memory effect

- Operate the unit until the battery pack is completely discharged, then recharge it fully. Repeat this process at least three times.

## LCD Low Battery Indicator

When the battery pack in the handset is low and needs to be charged you see this message on the display and the handset beeps.

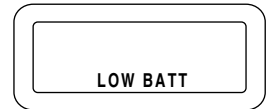
1192

## Low Battery Symptoms

On a Call	In Standby Mode
Only the <b>TALK</b> key operates.	None of the keys operate.
Handset beeps once every three seconds.	Handset beeps once.
Complete your call as quickly as possible.	Cannot make call.
Replace battery pack.	Replace battery pack before making a call.

To restore your battery capacity, return the handset to the base unit for charging or replace the handset battery pack with another charged one.

You can configure three items in your cordless digital telephone that affect the way it works the Strata DK business telephone system. These are:

SOFT KEY	<p><b>F1 (On)</b> causes the deskset to turn on the soft keys whenever the mode is changed from cordless to DKT.</p> <p><b>F1 (Off)</b> causes the deskset to turn off the soft keys whenever the mode is changed from cordless to DKT.</p>
SOFT KEY LOCK (MODE 70/71)	<p><b>F2 (On)</b> allows the Soft Key Mode 70/71 (Soft key <b>Off/On</b>) function to pass from the deskset to the Strata DK for controlling the soft key mode.</p> <p>Do not use this <b>F2 (On)</b> setting unless you have Release 3 of Strata DK280. Use with older systems may cause a system malfunction. Use <b>F2 (Off)</b>.</p> <p><b>F2 (Off)</b> locks the Soft Key (Mode 70/71) function from passing from the deskset to the Strata DK.</p>
RCV LEVEL	<p><b>F2 (On)</b> sets the receive level to normal level.</p> <p><b>F2 (Off)</b> sets the receive level to 4-dB level (lower volume).</p>

The above three settings default to the ON state.

Your cordless digital telephone can operate in either the DKT or the cordless mode and can be programmed whenever the telephone is idle. When entering the program mode during cordless operation, all calls coming to this station are ringback tone until the program mode is ended. Entering the program mode during DKT operation has no effect on current call status.

# Entering Program Mode

➤ **To enter the program mode**

1. Remove the handset from the base unit.
2. Press and hold \* and # at the same time.

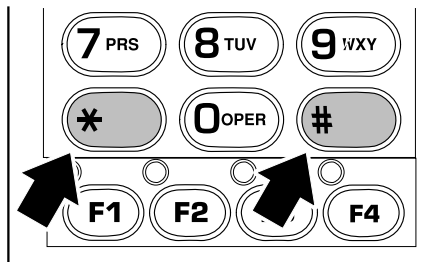

1178

3. While holding \* and #, press **TALK**.

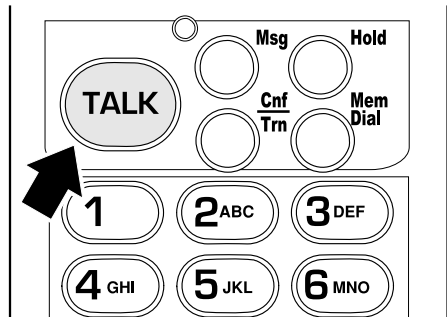

1178b

4. Release all three keys.

5. Press the **R/VOL** button on the upper right side of the cordless handset until you toggle to the DATA STORE settings screen.
6. Press **0** to toggle the settings for each program step or store (save) the setting when in DATA STORE step.
7. Press **TALK** at any time to exit PROGRAM without saving changes. To save the changes step to DATA STORE and press **0** before pressing **TALK**.
8. Press **MUTE** to step through the program steps in the reverse order.

The LEDs above the **F1~F3** buttons indicate the current setting for each of the program steps. Each time the feature is entered and digit **0** is pressed these LEDs change their indication.

You see the following screens on the cordless LCD prompting you to configure your handset:

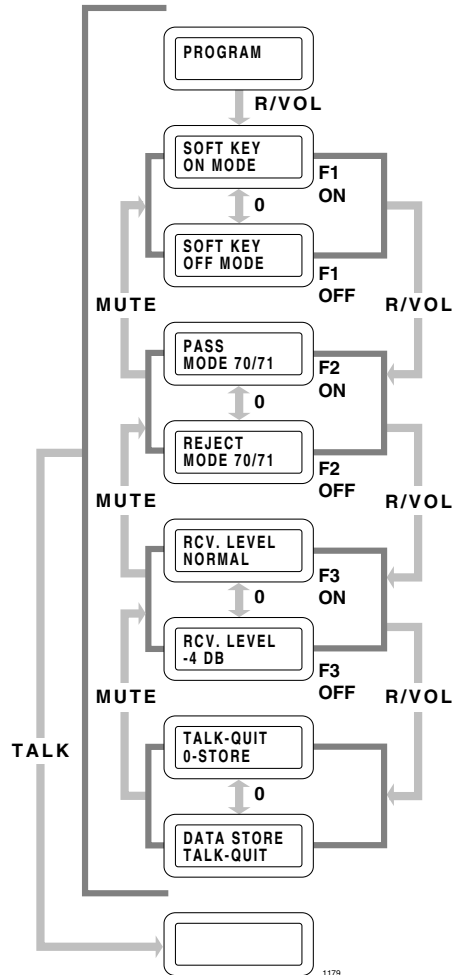

## Configuration

*Entering Program Mode*

## Handset Controls

### Handset Volume Level

- Press the **R/VOL** button on the side of the handset while on a call to select a loud or soft volume level.

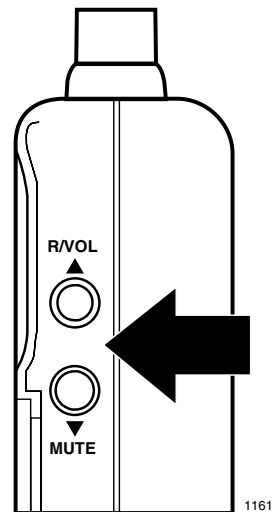

## Ringer Volume Level

- While the telephone is idle, press the **R/VOL** button on the side of the handset to select ring volume. When the handset is returned to the base, the ring volume automatically switches to RING HIGH.

**Note** When the display is set for RING OFF, you receive a vibration alert instead of the audible ring tone.

## Mute

- Press and hold the **MUTE** button to consult another person in the room without the caller hearing you. Release the **MUTE** button to continue the conversation.

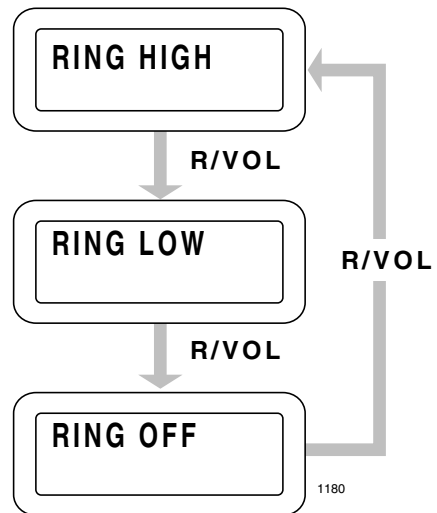



## Using the Handset

- Pick up the handset and press **TALK**.

You may see:

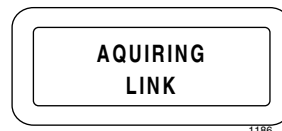

When the cordless digital telephone communicates between the base unit and the handset, the screen goes to standby, and the telephone is ready to use.

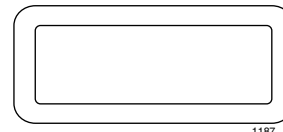

When talking and the handset is at the range limit of your cordless digital telephone, you may see:



Take the following action:

- During a call, move back in range within 20 seconds.
- In standby mode, move back within range.

When the display indicates DKT MODE, the telephone was not transferred to cordless mode at the base.



## Charging the Handset

For more information see [Page 12](#).

➤ **To charge your handset**

- Place the handset on the base unit either face down or face up, with or without the belt clip attached. (The battery pack in the handset automatically recharges in either position.)

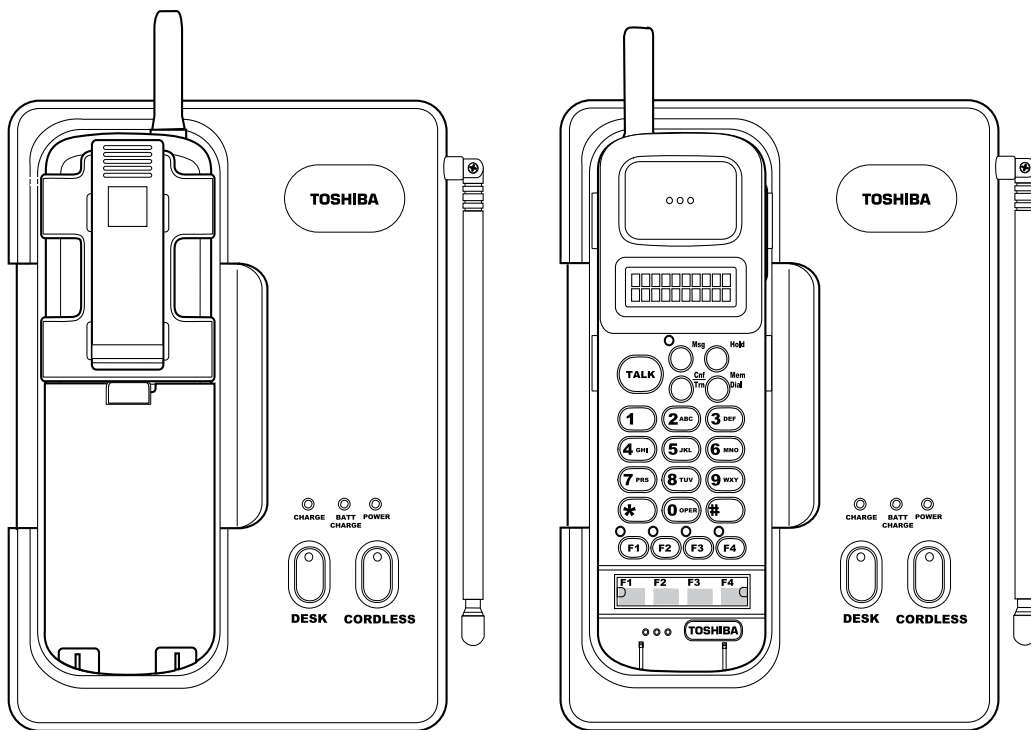

# Switching a Call to Your Cordless Digital Telephone

You can switch a call from the deskset to the cordless digital telephone or vice versa whether idle or talking.

**Note** Transferring while idle or when calls are on hold results in a steady light (skipping the flashing state).

## ► To transfer an active call

1. Press **CORDLESS** on the base unit.

The **CORDLESS** LED flashes.

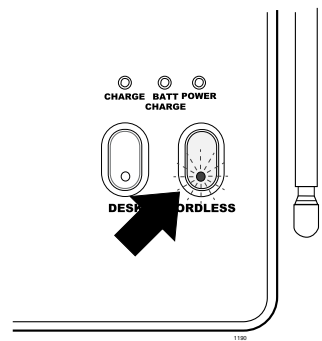

2. Pick up the handset and press **TALK**.

The **CORDLESS** LED lights steady. The **DKT** LEDs go out and LCD display shows **CORDLESS MODE**.

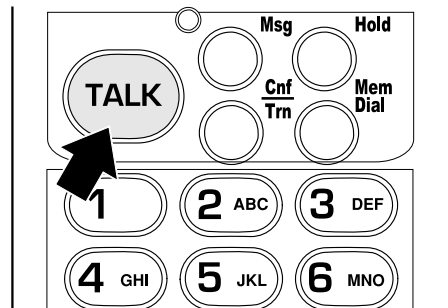

## The Handset

### Switching a Call to the Desk Telephone

3. When you finish the call, place the handset back on the base unit to automatically hang up.

If the telephones are idle, the transfer takes place immediately without the need to pick up the handset.

## Switching a Call to the Desk Telephone

1. Press **DESK** on the base unit.

The DESK LED flashes.

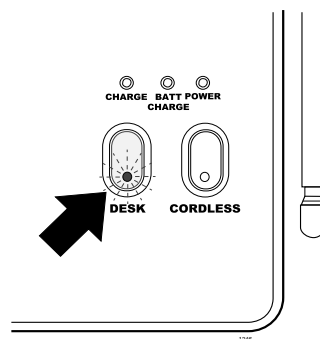

2. Pick up the handset on your desk telephone.
3. Hang up your cordless digital telephone handset.

The DESK LED lights steady.

**Note** If the cordless AC Adapter is unplugged or if the Strata DK system is turned off, the mode automatically changes to the CORDLESS mode.

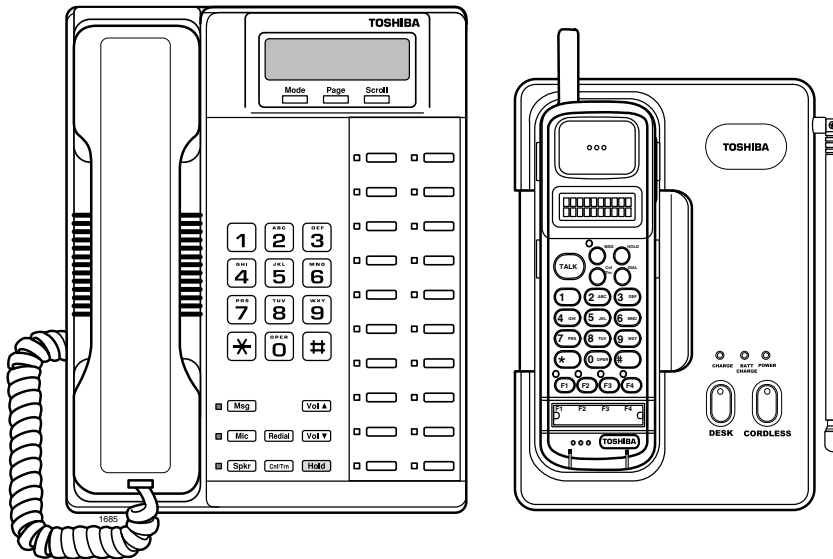

Cordless Digital Telephone with Digital Telephone

## Using Memory

### ► To store a number

1. Remove the handset from the base unit.
2. Press **Mem Dial**.
3. Enter the number (up to 16 digits) you want to store.



You hear a beep and see:

## The Handset

### Using Memory

4. Press **Mem Dial**.

You see:

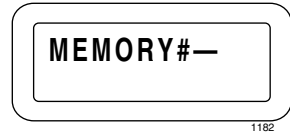

5. Enter the number (01~20) for the memory location you want to use.

You hear a confirmation beep and see the message. The telephone then returns to standby.

**Note** After pressing **Mem Dial** the second time, you have 20 seconds to enter the memory location number you wish to use. Otherwise, an error tone sounds and the unit returns to standby.

### ► To erase a stored number

1. Remove the handset from the base unit.

You see:

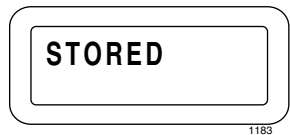

2. Press **Mem Dial** twice.

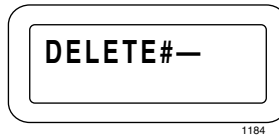

You see:

3. Press the memory location number you want to clear.

You hear a long beep and see a screen confirming that you have erased that number from memory.

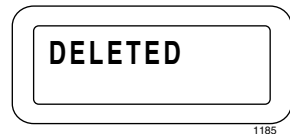

► **To dial a stored number**

1. Remove the handset from the base unit.
2. Press **TALK**  
...or press a designated function key with a line assigned to it. For example: Press **F2**.
3. Press **Mem Dial**.
4. Enter the two-digit memory number (01~20) for that number from the keypad.

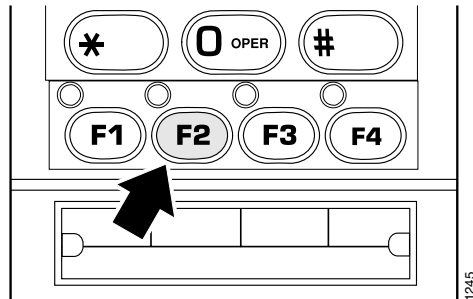

Your cordless digital telephone then dials the previously stored number. If you select a memory location that does not have a stored number, the handset beeps rapidly and the telephone does not dial.

## Chain Dialing

On certain occasions, after dialing a number, you may be requested by the party or service you are calling to enter a special access code, such as when performing a banking transaction. The access code can be stored in one of the 20 memory locations.

1. Remove the handset from the base unit.

## The Handset

### Using Memory

2. Make the call by dialing directly or from one of the stored numbers in memory.
3. When prompted by the called party, press **Mem Dial** (as shown) and the memory number of the access code at the appropriate time.

Example:

1. Dial the number for your bank.
2. When the bank requests your account number press **Mem Dial**.
3. Using the handset, enter the two-digit memory location (01~20) for your account number. Your handset dials the number and you may proceed with your transaction.

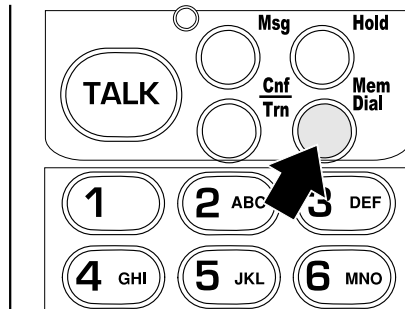

12-45b



This chapter gives you all of the cordless digital telephone features in alphabetical order beginning on [Page 40](#). Your cordless digital telephone provides many of the same features as a 2000-series corded digital telephone. In addition to the **Msg**, **Hold**, **Conf/Trn** and **Mem Dial** functions, you can use your cordless digital telephone's **F1~F4** buttons to invoke the features listed below or to gain multiple-line access.

When sharing the same station, your cordless **F1~F4** buttons perform the same functions as the first four buttons on a 2000-series telephone. The **F1~F4** buttons were preassigned upon system installation. Ask your System Administrator which **F1~F4** button functions you may or may not have.

## Features

### *Before You Begin*

If you are not using the programmable **F1~F4** buttons, you can use the alternate steps in this chapter to invoke the features listed below.

- ◆ **Pooled Line Grp**
- ◆ **Release and Ans**
- ◆ **Park in Orbit**
- ◆ **Park and Page**
- ◆ **Redial**
- ◆ **Call Frwd All Calls**
- ◆ **Call Frwd Busy**
- ◆ **Call Frwd No Answer**
- ◆ **Speed Dial**
- ◆ **Call Frwd Busy/NAAns**
- ◆ **Call Frwd External**
- ◆ **Auto Callback**
- ◆ **Account Code**
- ◆ **Auto Busy Redial**
- ◆ **Directed Pickup**
- ◆ **Group Pickup**
- ◆ **Do Not Disturb**
- ◆ **LCD Msg Select**
- ◆ **Privacy on Line**
- ◆ **Privacy Release**
- ◆ **DSS**
- ◆ **Tone Dial Select**
- ◆ **Start**
- ◆ **Subaddress**

There may be some feature operation differences on older version systems - compared to Strata DK424 or DK424i (e.g., Strata DK14, Strata DK40, Strata DK40i, Strata DK280, etc.). Please see "[Access Codes](#)" on [Page 90](#) for Feature Access Code sequences that match your Toshiba telephone system. Also see the Digital Telephone User Guide for more information.

## Before You Begin

If you are a new user of the cordless digital telephone, find out if your Strata DK system has Tone or Voice First Signaling. The difference is Tone Signaling rings while Voice First Signaling notifies you with a long tone, and then the caller's voice. Both signals are enabled in system programming and determine how you make and answer calls on your cordless digital telephone.

You can toggle between Tone and Voice First Signaling on a call-by-call basis.

➤ **To change the signaling method**

1. Press a [DN] button and dial another station [DN].
2. Press **1**.
3. Speak to your party when they answer.

If Tone First Signaling is enabled, you hear a ring tone (one second) every four seconds.

If Voice First Signaling is enabled, you hear a tone burst and then you can talk over the called station speaker.

After you press **1**, the other method is activated.

➤ **To answer a call when you have Voice First signaling**

- Talk in the direction of your telephone  
...or answer the call normally.

➤ **To answer a call when you have Tone First signaling**

If you hear successive ring tones, you have *Tone* First Signaling.

- Lift the handset.

**Note** You can change to the alternate signaling method when making a call on a call-by-call basis by pressing **1** after dialing an internal telephone number.

## Quick Reference

The following topics are quick references for using your telephone's standard features.

### Making an Outside Call

You can make calls to or receive calls from telephones outside of the Strata DK system by dialing direct or and using CO Line Access Codes.

## Features

### Quick Reference

#### ► To direct dial an outside number

1. Press **TALK**  
...or press any available **Line** button.
2. Dial a telephone number.

The [DN], Line, or Pooled Line Grp LED lights.

**Line** buttons can be labeled **CO Line** (outside CO Line), **Line**, or **Pooled Line Grp**. After selecting a Line, you should hear dial tone and the LED lights steady.

Dial tone stops after you dial the first digit.

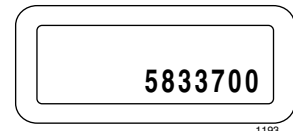

#### ► To use CO Line Access Codes to dial an outside number

1. Press **TALK**.
2. Dial a CO Line access code.  
See [“Access Codes” on Page 90](#).
3. Dial a telephone number.

You hear internal dial tone and the LED lights steady (with INT/PDN automatic off-hook selection programmed).

You hear CO Line dial tone and the LED continues to flash at the in-use rate.

Dial tone stops after you dial the first digit.

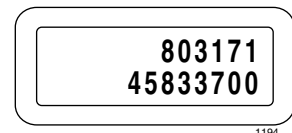

## Making an Outside Call to an ISDN Trunk

1. Access an outside CO line
2. Dial the number.
3. Press **Start**.

The dialed digits will not be sent until you press this button or until the timer expires. See [“ISDN Outgoing Calling” on Page 60](#) for more information on ISDN calls.

## Making an Internal Call

You can make calls to and receive calls from other stations in the Strata DK system.

### ► To dial an internal call

1. Press **TALK** or a [DN].
2. Dial a [DN].

You hear dial tone and the LED lights steady.

#### Notes

- If the system is set for Voice First Signaling, make a voice announcement when you hear a single tone.
- If the system is set for Tone Signaling, you hear repeated ring tones and you should wait for the call to be answered.
- If the called station does not answer, you can leave a message waiting by pressing **Msg** or **7**.

### ► To recall a busy station

- Press **4** to set Automatic Call Back (ACB).

### ► To override a busy station

- Press **2**

Busy Override is activated (use only if the called station is not equipped for OCA).

...or **3**.

Executive Override (system programmable option) is activated.

## Answering Calls

### ► To answer a call on a CO Line or [DN]

- Press the flashing [DN], **Line**, or **TALK** button.

The LED changes from the flashing incoming call rate to steady.

### ► To answer a call on Pooled Line Grp

1. Press the flashing **Pooled Line Grp** or **TALK** button.

The LED changes from the flashing incoming call rate to steady. If another call comes in during the first call, place the call on hold or transfer it, then answer the second call.

**Note** A warning tone is given when you are on a **Pooled Line Grp** call which indicates an incoming call.

2. Press **Release and Ans**  
...or **TALK**

### ► To answer a transferred call

- Press **TALK**  
...or the flashing [DN] key.

You hear an internal ringing tone. The cordless digital telephone continues to ring whether the deskset is set for Voice First or Tone Signaling.

The [DN] or Line LED is steady when you are connected to the call.

## Transferring Calls

You can transfer calls to a idle or busy station, but you cannot transfer calls to a station that is in the DND mode.

► **To transfer a call (using Camp-on)**

1. Press **Cnf/Trn**.
2. Dial the [DN] where the call is to be transferred.
3. Announce the call.

The Line or [DN] LED flashes at the conference rate. You hear internal dial tone.

The [DN] could be the [DN] of a telephone, a Hunt Group Number, or ACD Group [DN], etc.

After dialing, you hear a single tone.

**Note** If the call was made with Tone Signaling instead of Voice First Signaling, you hear ringing tone.

If the called station does not answer, you receive a recall ring (when your station or [DN] is idle). The ring is set by system programming.

4. Hang up

The Line LED changes to steady when the called station connects with the transferred call.

...or press **Line**, [DN] + **42** to reconnect to the transferred line before the call is answered or busy tone is received.

The Line LED changes to steady red when the called station connects with the transferred call. After you hang up, the Line LED begins to flash at the on-hold rate or if you transferred the call from a [DN], the [DN] LED goes out. The CO Line or [DN] camps onto the called station and the called station receives a warning tone.

You receive a recall ring when your station or [DN] is idle and camp-on is cancelled when the called station user fails to answer within a predetermined time. Repeat the procedure if necessary.

## Conferencing Calls

### ► To conference calls with stations only

As many as four stations can be conferenced on one [DN].

1. Press <b>Cnf/Trn</b> .	You hear internal dial tone and the LED flashes at the conference rate.
2. Dial a [DN].	The [DN] could be for a telephone or department.
3. Press <b>Cnf/Trn</b> after the party answers.	All parties are conferenced and the [DN] LED from which the conference originated lights steady.

### ► To add a second Line

1. Press <b>Cnf/Trn</b> .	You hear dial tone. The [DN] or Line LED flashes at the conference rate if the call is on a [DN] or <b>Line</b> button.
2. Dial the next telephone number.	
3. Press <b>Cnf/Trn</b> after the party answers.	All parties are conferenced. You can add one more station to a two-line conference.
	<b>Note</b> If you receive a busy tone or the second station does not answer, return to the original connection by pressing the original [DN] or Line or hanging up.
	If both lines appear on your telephone, both Line LEDs lights steady (if you used <b>Line</b> buttons). If you established the two-line call on a single [DN], it lights steady.

### ► To add a station to a line call

1. Press <b>Cnf/Trn</b> .	You hear dial tone. The [DN] or Line LED flashes at the conference rate.
---------------------------	--



2. Dial the [DN] of the station to be added.
3. Press **Cnf/Trn** after the party answers.

If you receive a busy tone or no answer, press **Cnf/Trn** to return to the original connection.

All parties are conferenced. The [DN] or Line LED lights steady.

Up to three stations (including your own) can conference with one line.

The new station is not conferenced until you answer by lifting the handset or pressing a [DN].

## Placing/Retrieving Calls on Hold

Calls on hold may be released automatically if the held party hangs up and the network provides a hold-release signal. See [Page 38](#) for the Automatic Hold feature.

### ► To hold a call that appears on a Line or [DN] button

- 
- Press **Hold**.

The Line or [DN] LED flashes green at the on-hold rate.

You hear recall tone when your station is idle (or two times only when busy) if you do not retrieve the held call before “Hold the recall” time set in system programming expires.

### ► To place a Handsfree Answerback call on hold

- 
1. Press **TALK** or the flashing [DN] to answer the call.
  2. Press **Hold**.

You are connected to the incoming call.

The Line or [DN] LED flashes green at the on-hold rate.

You hear recall tone when your station is idle (or two times only when busy) if you do not retrieve the held call before “Hold the recall” time set in system programming expires.

## Features

### Quick Reference

#### ➤ To retrieve the held call

- Press **Line** or the [DN] which is on hold.

The Line or [DN] LED flashes at the on-hold rate.

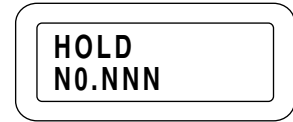

#### ➤ To place a call on Exclusive Hold

Exclusive Hold enables you to place a call on hold so that only you or somebody using a Call Pickup code at another station can retrieve it.

- Press **Hold** twice.

The Line LED flashes at the exclusive hold rate.

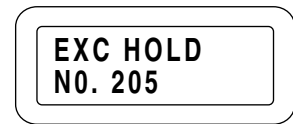

#### ➤ To retrieve a call on Exclusive Hold

- Press the **Line** button that is on Exclusive Hold.

Another station user can pick up the call by dialing **#5** plus your station number, or by dialing **#5#7** plus the CO Line number (**001~200**) that the call is held on.

## Using Automatic Hold

Automatic Hold enables you to process calls more quickly, because you can automatically place a call on hold by pressing another **Line** or a [DN] button. You do not have to press the **Hold** button. You can also switch between a new call and the original call without having to press **Hold**. Automatic Hold is assigned on a station-by-station basis in system programming.

➤ **To use Automatic Hold**

- Press another **Line** or [DN] to receive or originate a new call, while on one call.

The original Line or [DN] LED flashes at the on-hold rate and the original call is placed on hold.  
The LED of the new call lights steady and the new line is accessed.

➤ **To switch between calls**

- Press **Line** or [DN] of the held call.

The Line or [DN] LED just placed on hold flashes at the on-hold rate, and the LED of the Line just accessed lights steady.

## Calling the Attendant Console

There are three ways to call the Attendant Console depending upon system programming. You can call any Attendant Console, a particular Attendant Console, or all Attendant Consoles.

➤ **To call any console**

- Press a [DN] + **0**.

The call rings the Attendant Console. Dial 0 calls rotate between the consoles if more than one console is installed.

➤ **To call a specific console**

- Press a [DN] + the console's [DN] \_\_\_\_\_.

The call rings the console's Incoming [DN] (**In-DN**) button.

**Note** Your System Administrator can provide the Attendant Console Incoming [DNs].

➤ **To make an emergency call to all consoles**

- Press [DN] + the emergency access code **#400**.

The call rings all consoles (**Emgr** button).

## Tone/Pulse Dialing

With some older Central Offices, you may have to make calls using rotary dial pulses on outside lines. To access remote equipment (such as an answering machine) requiring Dual-tone Multi-frequency (DTMF) tones while on these lines, you must set your telephone for tone dialing after you have dialed the telephone number. Your telephone must have a **Tone Dial Select** button assigned in system programming to access this feature.

### ► To change to Tone Dialing

1. Dial a telephone number on a line programmed for rotary dial pulses.
2. Press **Tone Dial Select** while the call is in progress.

Although the line is programmed for rotary dial pulses, you can access the line and dial the telephone number like any other call described in this guide.

The Tone Dial Select LED lights steady, and you can send DTMF tones with your dial pad. If the LED is off, tone dialing is not selected, and you cannot send DTMF tones.

**Note** When originating or receiving a new call, the system automatically places the line in the dial pulse mode.

## Account Code Calls

Account Codes can be entered before or after a call. Some of the code applications include billing, tracking, and line restriction. Account Codes are recorded by the system and can, along with the details of the calls they are associated with, be printed out on a Station Message Detail Recording (SMDR) report.

### Forced Account Codes

Some applications may require that you enter a Forced Account Code before dialing the telephone number.

### ► To use a Forced Account Code

1. Access a line.	You hear dial tone after accessing a line. If you dialed with LCR, you do not hear dial tone. See <a href="#">“Access Codes” on Page 90</a> .
2. Enter the Forced Account Code.	Dial tone stops after you dial the first digit. You hear dial tone after you press the last digit of a valid account code, or busy tone if you dial an invalid code. If you dial with LCR, you do not hear dial tone.
3. Dial a telephone number.	Any digits that you dial after entering the code is entered in Step 2 are treated as part of a telephone number.

## Emergency Override of Forced Account Codes

You can bypass Forced Account Codes with three emergency numbers including 911. See your System Administrator for these numbers.

## Voluntary Account Codes

Voluntary Account Codes are optional and can be entered after accessing a CO Line or during a call that you originated or received. The outside party cannot hear the tones you are entering.

Voluntary Account Codes can be set in system programming to change the Toll Restriction classification of your station. See your System Administrator for more information. If your station is programmed not to verify Account Codes, you do not hear a confirmation tone.

### ► To use a Voluntary Account Code

1. Press <b>Account Code</b>	Your conversation is not interrupted. Some telephones require that you enter the account code before dialing a telephone number. If a valid account code is not entered, dialing external calls may be restricted.
------------------------------	--

## Features

### Alarm Reset

...or **Speed Dial + 50**

...or **\* + 50**.

2. Enter the Account Code.
3. Repeat Steps 1 and 2 to enter another account code (the last code entered is recorded).

You hear confirmation tone (one-half second duration) if the code is valid. If the code is invalid, you hear two short tones.

#### Notes

- Any digits dialed after the code has been entered are treated as part of the outside telephone number.
- Voluntary Account Codes must be entered before the call is disconnected.

## Verified Account Codes

If the system is set for Verified Account Codes, you must enter specific codes when entering Forced or Voluntary Account Codes. Verified Account Codes are established in system programming or by designated stations.

## Alarm Reset

Your Strata DK system can be connected to a facility alarm system. All telephones produce a startling tone whenever this alarm is activated. Stations with an **Alarm Reset** button can reset the alarm by pressing the **Alarm Reset** button.

## Alert Signaling

Alert Signaling enables you to send an alert sound to a predesignated (partner) station by pressing a single button. This feature is based on the “buzz” key, where, for example, a manager might alert his/her administrative assistant to enter the office.

You can have as many as four **Alert Signal(s)** to send or receive an Alert Signal to/from other telephones. An Alert Signal is sent even if the alerted telephone is busy (on/off-hook) or in the DND or Call Forward mode.

➤ **To send an Alert Signal**

- Press **Alert Signal**. An alert tone sounds at the designated station.

**Note** The signal sounds even if the alerted telephone is busy (on or off hook) or in the DND mode.

## Automatic Busy Redial (ABR)

After reaching a busy outside number, you can activate Automatic Busy Redial (ABR) so that the Strata DK system automatically redials that number for you at regular intervals. ABR is an optional feature enabled in system programming. This feature may not be allowed on some (or all) lines in your system depending on the telephone line type connected.

➤ **To activate ABR**

1. Press **Auto Busy Redial**

...or press **Cnf/Trn + #44**.

2. Press **Spkr**.

The Auto Busy Redial LED flashes.

You hear confirmation tone after you press **Cnf/Trn + #44**.

The system redials the number every 30 or 60 seconds (depending on system programming), up to 15 times. With each attempt, the:

- Line and Spkr LEDs blink when the line is seized.
- Dial tone is heard over your speaker.
- Telephone number is redialed. If busy, ABR resets and tries again.

## Features

### Automatic Callback

3. Press **TALK** and wait for the party to answer.

#### ➤ To cancel ABR

- Press **Auto Busy Redial**  
...or press [DN] + **#44**.

If the [DN] or Line is available, the [DN] or Line and Spkr LEDs flash. The called telephone number rings, and your telephone receives ring tone.

**Note** If your station is busy, ABR does not attempt a recall.

If you do not press **TALK** within 30 seconds after a connection is made, you hear a muted ring for another 30 seconds, then the call disconnects.

## Automatic Callback

After reaching a busy or Do Not Disturb station, you can set Automatic Callback (ACB) to have the system call you back when the called station becomes available. You can make other calls while waiting for the called station to become available.

#### ➤ To set Automatic Callback (busy or DND stations)

1. Press **Auto Callback**  
  
...or press **4**.
2. Press **TALK**.
3. Answer within three rings to prevent the callback from being cancelled.

Busy tone stops momentarily, then you hear two seconds of dial tone, then busy tone resumes.

The LED flashes at the incoming call rate.

Your telephone rings at a fast rate when the called station becomes idle, and you hear a single tone (LED lights steady).

The called station receives a voice announce call from your telephone or, with Tone Signaling, you hear ringback tone and the called station rings.



If you receive a busy tone after answering the callback, the called party has already received or originated another call. Your request is not cancelled.

➤ **To cancel Automatic Callback (busy or DND stations)**

- Press a [DN] + **#43** + **TALK**.

## Line Queuing with Automatic Callback

Automatic Callback enables a waiting queue for an available line after attempting access to a line group when all lines are busy. The system calls you back when a line becomes available.

➤ **To set Line Queuing**

1. Press **Auto Callback**

... or press **4**.

2. Press **TALK**.

3. Lift the handset immediately or press the flashing [DN].

The busy tone stops momentarily, then you hear two seconds of dial tone, then busy tone resumes.

You can make other calls while waiting for a line to become available.

The [DN] LED from which you attempted to first access the line flashes at the incoming call rate, and your telephone rings at a fast rate.

**Note** You must answer within three rings to prevent the callback from being cancelled.

You hear CO dial tone. If you hear a busy tone, the line has already been seized or has received an incoming call. Your request is not cancelled.

You are called again the next time a line becomes available. The Line or [DN] LED lights steady.

➤ **To cancel Line Queuing**

- Press a [DN] + **#43** + **TALK**.

## Auto Redial

This feature enables you to automatically redial the last number (outside or [DN]) called by pressing **Redial**. The **Redial** feature button must be programmed as one of the four flexible keys on the telephone.

➤ **To redial the last number dialed**

1. Press an available [DN] or **Line**.

Make sure that you press the same [DN] or **Line** button that you used to dial the telephone number that you wish to redial.

You hear dial tone.

2. Press **Redial**.

The last telephone number you dialed is automatically redialed.

## Call Forward

You can set your telephone [DN] with a variety of Call Forward modes. Call Forward must be set before the call is received. When Call Forward is set, the following types of calls are forwarded.

- ◆ External calls that ring your station, but lines that ring more than one station are not forwarded except CF-External.
- ◆ Line calls that are transferred to your station.
- ◆ Internal calls (Handsfree and OCA calls may or may not). CF-External calls are not forwarded on internal calls.

Call Forward has priority over the Station Hunt feature.

Telephones can have many [DN] buttons, but the telephone must be the designated owner of a [DN] before you can Call Forward to the [DN]. Each telephone is usually the owner of at least one [DN] which is called the Primary Directory Number [PDN].

Your telephone can be programmed to have [PhDNs] in addition to [DNs]. Each [PhDN] can be set to any mode of Call Forward independent of other [DNs] on the telephone. Like the [DNs], your telephone must be the owner of [PhDNs], so that you can use any of call forward features. If you hear re-order tone when following any of the Call Forward steps, then your telephone is not the owner of the selected [PhDN].

When you forward calls to another destination, you see a message indicating the:

- ◆ Type of Call forward.
- ◆ Forwarded from [PhDN] and/or [DN].
- ◆ Forwarded to destination number.

**Note** Call Forward–All Calls, Call Forward–No Answer, and Call Forward–Busy can only be activated when Speed Dial is assigned to an “**F1-F4**” function key or deleted from all buttons (use \*). See “[Access Codes](#)” on [Page 90](#).

## Call Forward-All Calls

If your station is idle or busy and has this feature activated, all calls to it are forwarded immediately. The station does not ring.

### ► To set Call Forward-All Calls

<ol style="list-style-type: none"> <li>1. Press <b>Call Frwd All Calls</b>  ...or press a [PDN] or [PhDN] + <b>#601</b>.</li> <li>2. Enter the [DN] to which calls are forwarded.</li> </ol>	<p>The Call Frwd All Calls LED flashes.</p> <p>You hear a confirmation tone.</p> <p><b>Note</b> [PhDNs] can only be forwarded by using the dial codes.</p>
--	--

## Features

### Call Forward

3. Press **Call Frwd All Calls**

...or press **TALK** if an access code was used.

The Call Frwd All Calls LED lights steady red and calls forward to the stored station number.

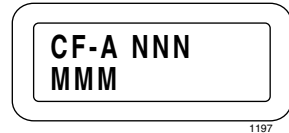

## Call Forward-Busy

Calls to your telephone while you are busy on another call or in the DND mode forward immediately if this feature is set. Calls ring as normal if your telephone is idle.

### ► To set Call Forward-Busy

1. Press **Call Frwd Busy**  
...or press a [PDN] or [PhDN] + **#602**.
2. Enter the [DN] of the station to which calls are to be forwarded.
3. Press **Call Frwd Busy**

...or press **TALK** if an access code was used.

The Call Frwd Busy LED flashes.

You hear confirmation tone if you pressed **#602**.

The Call Frwd Busy LED lights steady and calls are forwarded to the stored station number.

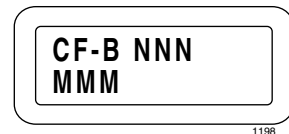

## Call Forward-No Answer

All calls to your station when set with this feature are forwarded to a selected station if you do not answer within a time that you designate.

**Note** Your station can be assigned in system programming to not Call Forward-No Answer when receiving Voice First (handsfree) calls. Callers can activate Call Forward-No Answer by dialing 1 during their voice announcement.

► **To set call Forward-No Answer**

1. Press **Call Frwd No Answer**  
 ...or press a [PDN] + **#603**.
2. Enter the [DN] to which calls are forwarded.
3. Press **Speed Dial**
4. ...or \*.
5. Enter the time at which the calls are to be forwarded (08~60 seconds).
6. Press **Call Frwd No Answer**  
 ...or press **TALK**.

The Call Frwd No Answer LED flashes red.

You hear confirmation tone.

You can omit this step if you pressed **Call Frwd No Answer** in Step 1, and you do not want to change the length of time that your telephone rings before it forwards. Initially, your telephone rings 12 seconds before it forwards.

You can omit this step and continue onto the next step if you do not wish to change the amount of time your telephone rings before it forwards.

The Call Frwd No Answer LED lights steady red and calls are forwarded to the stored station number.

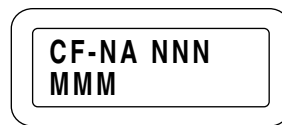

1199

## Call Forward-Busy/No Answer

All calls to your station set with this feature are forwarded immediately to a selected station whenever you are busy on another call or in the DND mode. Calls also forward if you do not answer the call within a time that you designate.

## Features

### Call Forward

**Note** Your station can be assigned in system programming not to Call Forward-No Answer when receiving Voice First (handsfree) calls. Callers can activate Call Forward-No Answer by dialing **1** during the voice announcement.

#### ► To set Call Forward-Busy/No Answer

- |  |   |
|--|---|
| 1. Press <b>Call Frwd Busy/NAns</b><br><br>...or press the [PDN] or [PhDN] to be forwarded + <b>#604</b> . | The <b>Call Frwd Busy/NAns</b> LED flashes.   |
| 2. Enter the [DN] to which calls are forwarded.  | You hear a confirmation tone if <b>#604</b> is dialed.  |
| 3. Press <b>Speed Dial</b>   | You can omit this step if you pressed <b>Call Frwd Busy/NAns</b> in Step 1, and you do not want to change the length of time that your telephone rings before it forwards. Initially, your telephone rings 12 seconds before it forwards. |
| 4. ...or <b>*</b> .  |   |
| 5. Enter the time at which the call are to be forwarded (08~60 seconds).                                   | You can omit this step and continue onto the next step if you do not wish to change the amount of time your telephone rings before it forwards.   |
| 6. Press <b>Call Frwd Busy/NAns</b><br><br>...or press <b>TALK</b> .                                       | The Call Frwd Busy/NAns LED lights steady red and calls are forwarded to the stored station number.   |

## Call Forward-Cancel

#### ► To cancel any Call Forward mode except Call Forward-External

- Press the applicable **Call Forward** button so that its associated LED turns off  
...or press [PDN] + **#601**  
...or press **TALK**.

## Call Forward-External

This feature enables you to forward new incoming calls directed to your [PDN] to a destination outside of the system. [PhDNs] assigned to your telephone do not Call Forward to external destinations. Internal calls and transferred calls to your [PDN] also do not forward to external destinations. Only incoming calls over CO Lines dedicated to your [PDN], private CO Line, and/or Direct In Dial line calls are forwarded. The Call Forward-External destination can be a telephone number over a CO Line, a station over a tie line, or a station within your Strata DK system.

Any of the Call Forward modes can be set for your [PDNs] or [PhDNs] simultaneously with Call Forward-External. This feature stores the calls to Station Speed Dial Code 49. Use the Speed Dial storage procedures detailed in this chapter. When forwarding to an outside destination include the CO Line (or CO Line Group) access code before the telephone number. See [Table 1 on page 94](#) for the CO Line/Line Group access codes. The LCR access code “9” cannot be used.

---

**Important!** *Only perform the following procedure the first time Call Forward External is set or when you change the destination. It is not necessary to store the destination each time you set Call Forward External; it remains in system memory.*

---

### ► To set Call Forward-External

1. Press **Call Frwd External**

...or press the [PDN] + **#670 + TALK.**

Incoming calls forward to the destination stored at Station Speed Dial Location 49 (RCTUA, B, C/D processors) or location 139 (RCTUE/F processors).



## Features

Call Park Orbits (Release 3 or later)

- **To cancel Call Forward-External**
  - Repeat the previous step.

### Call Forward-Fixed

If you activate this feature, all internal and Private or DID CO Line calls to your [PDN] are forwarded immediately to a [PDN] set in system programming. Your station must be assigned with the “**Call Frwd to: \_\_\_\_\_**” button in system programming to activate this feature.

- **To set Call Forward-Fixed**

- Press **Call Frwd to:**  
\_\_\_\_\_.

The “**Call Frwd to:**  
\_\_\_\_\_” LED lights steady and all calls are forwarded to a station [DN] or voice mail device set in system programming.



### Call Park Orbits (Release 3 or later)

The Call Park Orbit feature enables you to hold a call temporarily in an orbit for anyone to retrieve. You can have the same station or a different station. There are 20 General Park Orbits for the system and one Personal Park Orbit for each station. Once you have parked a call in an orbit, you can:

- ◆ Hang up and retrieve the parked call at a later time.
- ◆ Originate another call.
- ◆ Access a voice paging device to announce the parked call for pickup from another station.

If you park a call and your station is idle while the system Call Park recall timer expires, the parked call automatically recalls to your station. If your station is busy, the parked call camps onto your station.



### ► To park a call

- |   |  |
|---|--|
| <ol style="list-style-type: none"> <li>1. Press <b>Park in Orbit</b> while on an internal or outside call.</li> </ol> | <p>The Line or [DN] LED flashes at the consultation-hold rate until you enter the orbit number.</p>  |
| <p>...or <b>Cnf/Trn + #332.</b></p>   |  |
| <ol style="list-style-type: none"> <li>2. Enter a General Orbit Number (<b>900~919</b>)</li> </ol>                    | <p>After dialing the orbit number, you hear a short dial tone and the call is parked. The Line LED flashes at the Hold rate, or the [DN] LED goes out.</p> |
| <p>...or enter a valid [PDN].</p>   |  |
| <ol style="list-style-type: none"> <li>3. Press <b>TALK.</b></li> </ol>   |  |

### ► To pick up or retrieve a parked call

- |  |   |
|--|---|
| <ol style="list-style-type: none"> <li>1. Press the parked <b>Line</b>, [DN] or <b>Park in Orbit</b></li> </ol> <p>...or [DN] + <b>#332.</b></p> | <p>The Line LED flashes at an on-hold rate (the [DN] LED is off). The call is parked at the orbit with the orbit number that you have just entered.</p> |
| <ol style="list-style-type: none"> <li>2. Enter the Orbit Number or the [PDN] where the call is parked.</li> </ol>                               | <p>The Orbit Number is usually provided in the paging announcement. The Line or [DN] LED lights steady when the call is picked up or retrieved.</p>     |

## Call Park and Page

- |   |  |
|---|--|
| <ol style="list-style-type: none"> <li>1. Press <b>Park and Page</b> while on an internal or outside call.</li> </ol> <p>...or <b>Cnf/Trn + #331.</b></p> | <p>The Line or [DN] LED flashes at the consultation-hold rate.</p>   |
| <ol style="list-style-type: none"> <li>2. Enter a General Orbit Number (<b>900~919</b>) or a valid [DN].</li> </ol>                                       | <p>The Line LED flashes at an on-hold rate (the [DN] LED is off). You hear a short dial tone for your paging access.</p> |

## Features

### Call Pickup

3. Enter the Paging access code\_\_\_\_\_. See [“Access Codes” on Page 90.](#)
4. Make your announcement and remember to include the Orbit Number in your announcement.
5. Press **TALK** to free the paging device.

The paging device is released when you hang up.

## Call Pickup

You can pick up a call that is ringing another station, a call placed on hold at another station and other types of calls.

### Directed Call Pickup

Directed Call Pickup provides you with several ways to pick up calls ringing in, or calls held at other stations. You can also pick up a telephone group page and an external page with Directed Call Pickup.

#### ► To use Directed Pickup

1. Press **Directed Pickup**  
...or press a [DN] + **#5**.
2. Dial one of the pickup codes. See [“Access Codes” on Page 90.](#)

➤ **To pick up a ringing CO Line in a tenant system**

- Press **Directed Pickup 1~4**

...or press a [DN] + **#59**.

After you press a particular button, you are connected to a new incoming call for that particular Tenant Group. **Directed Pickup1~4** buttons correspond to Tenant Groups 1~4. You are connected to a new incoming ringing call (in any Tenant Group) after dialing the access code.

In non-tenant systems, the **Directed Pickup1** button picks up any ringing CO Line.

This feature does not pick up transferred CO Lines that are ringing; see “Directed Call Pickup” that follows for instructions on how to pick up transferred lines.

## Group Pickup

Stations can be assigned in system programming to Pickup Groups. As many as 20 groups can be created to enable you to easily pickup incoming (new or transferred) or internal calls that are ringing stations that are in your group or in other groups. See your System Administrator for group assignments.

### Calls Within Your Group

You can pick up calls ringing stations within your pickup group. You can belong to more than one group.

➤ **To pick up a call ringing a station in your group**

- Press **Group Pickup**

...or press a [DN] + **#5#34**.

You are connected to the call after pressing **Group Pickup** or entering the access code.

## Calls to Other Groups

You can pick up calls directed to other pickup groups by following the steps on the left.

### ► To pick up a call ringing another group

- |  |  |
|--|--|
| <ol style="list-style-type: none"><li>1. Press a [DN].</li><li>2. Enter <b>#5</b>, then the access code (<b>#320~#339</b>) of the group that the station belongs to.</li></ol> | <p>You hear dial tone.</p> <p>You are connected to the call after dialing the group access code. If the called station belongs to more than one group, any of the Group Pickup codes associated with those groups picks up the call.</p> |
|--|--|

## Call Waiting

You can place the call on hold or end this call and answer the next call. A warning tone indicates that you have a call camped onto your station and the [DN] or Line LED flashes at the on-hold rate.

### ► To answer an incoming call while on another call

- |  |  |
|--|--|
| <ol style="list-style-type: none"><li>1. Press <b>Hold</b>.</li><li>2. Press the flashing [DN] or <b>Line</b><br/><br/>...or press the flashing [DN] or <b>Line</b> if your telephone has the Auto Hold feature<br/><br/>...or press the ringing [DN] or <b>Line</b> to end the current call and answer the next call.</li></ol> | <p>The existing call is put on hold. The camped-on line rings your station and the Line LED flashes at the incoming call rate.</p> <p>You are connected to the transferred call and the [DN] or Line LED lights steady.</p> <p>The existing call is placed on hold and you are connected to the transferred call. The [DN] or Line LED lights steady (See your System Administrator to find out if you have Auto Hold).</p> <p>This disconnects the current call and then connects you to the transferred call. The [DN] or Line LED remains steady.</p> |
|--|--|

...or hang up and the camped-on call rings your station. Then press a [DN], **Line**

...or press **TALK**.

The existing call is disconnected. The camped-on line rings your telephone and the Line LED flashes at the incoming call rate.

## Direct Station Selection Buttons (Hotline)

This optional feature enables you to connect directly to another station [PDN] by pressing a Direct Station Selection **DSS** button. The button's LED shows status (idle/busy). If connected to a CO Line, press this button to put the outside party on hold. Transfer the call as you would normally, by voice announcing or camping on by hanging up or by pressing the **Release and Ans** button.

The station could be busy on its Primary [DN], Secondary [DN], a Phantom [DN], a CO Line or in Do Not Disturb mode if the DSS LED is lit. If a station is idle but other stations are using all of the station's [PDN] buttons, the station [**DSS**] button lights busy.

## Do Not Disturb (DND)

If your station is in the DND mode, internal and external calls do not ring your station; calls cannot be transferred to it and Off-hook Call Announce calls are denied. You can continue to make calls while in the DND mode.

**Note** You can press **Alert Signal** button from your "alert partner" telephone to override DND and signal your telephone. Also, telephones with the DND override feature can call and ring your telephone when it is in the DND mode. DND and or Alert Signal must be programmed on the telephone **F1~F4** buttons.

## Features

### Door Lock

#### ► To activate/deactivate DND

- Press **Do Not Disturb**.  
...or press it again to toggle the feature off.

The LED lights steady in DND mode.

#### Notes

- Pressing **Do Not Disturb** while a call is ringing at your station silences the ringing.
- Calls forward from your station if it is set for Call Forward-Busy or Call Forward-Busy/No Answer while in the DND mode.
- Some stations may be programmed to override DND.

## Door Lock

Your telephone may have an **Unlock Door** button(s), which unlocks a door lock when pressed. You may use the following to record the locations of each door.

**Unlock Door 0** \_\_\_\_\_

**Unlock Door 1** \_\_\_\_\_

**Unlock Door 2** \_\_\_\_\_

**Unlock Door 3** \_\_\_\_\_

**Unlock Door 4** \_\_\_\_\_

#### ► To unlock a door lock

- Press the corresponding button (**Unlock Door 0~4**).

The door unlocks for three or six seconds when you press the button, depending on system programming. The Unlock Door LED turns on for the amount of time the door is unlocked.

# Door Telephone

Door phones can be used to call digital and electronic telephones selected in system programming. You can call a door telephone and monitor the area surrounding the door telephone.

## ► To answer a door telephone call

1. Press **TALK**.
2. Dial the door telephone [DN] if not connected yet.
3. Hang up when the call is completed.

If you lift the handset while the door telephone is still ringing, your [DN] LED lights steady and you are connected to the door telephone.

## ► To pick up door telephone calls that are ringing at a station other than yours

1. Press a [DN] + **#5#30**.

You hear a distinctive ringing tone. Your telephone rings five times or only once, depending on system programming.

## Features

### ISDN Outgoing Calling

#### ► To call/monitor a door telephone

1. Press a [DN].
2. Dial the [DN] for the desired door location.

You hear dial tone and the LED lights steady.

[DN]

#151 Location \_\_\_\_\_

#152 Location \_\_\_\_\_

#153 Location \_\_\_\_\_

#154 Location \_\_\_\_\_

#155 Location \_\_\_\_\_

#156 Location \_\_\_\_\_

[DN]

#157 Location \_\_\_\_\_

#158 Location \_\_\_\_\_

#159 Location \_\_\_\_\_

#161 Location \_\_\_\_\_

#162 Location \_\_\_\_\_

#162 Location \_\_\_\_\_

Hang up when the call is completed or when you are finished monitoring.

## ISDN Outgoing Calling

This feature enables you to make outgoing call using an Integrated Services Digital Network (ISDN) trunk, provided that you are connected to a Strata DK424i or DK424 system with Release 4.0, or higher, software and that you subscribe to ISDN lines. ISDN trunks offer faster call connection setup, and they also provide more connection circuits.

Making an ISDN outgoing call will either be handled automatically with a timer or by you initiating the ISDN “Start” sequence. The method depends on your system’s programming. See your System Administrator to determine the method.



► **To make an outgoing call to an ISDN trunk**

1. Access an outside CO line
2. Dial the number.
3. Press **Start**.

The dialed digits will not be sent until you press this button or until the timer expires.

## Subaddress

Subaddress digits may be required for dialing another department, or to send a call to equipment, such as a printer. If you need to enter subaddress digits, follow these instructions:

► **To make an outgoing call with a subaddress to an ISDN trunk**

1. Access an outside CO line
2. Dial the number.
3. Press **Sub**.
4. Enter the subaddress.
5. Press **Start**.

The **Sub** button informs the system that the following digits are the subaddress.

The dialed digits will not be sent until you press this button or until the timer expires.

## LCD Name/Number Display

This feature enables you to use your telephone to store a title (such as your name, telephone number, location, etc.) in system memory. This title (e.g., LOBBY) displays on your station's LCD while it is idle, and it appears at other stations' LCDs when they are called from your station. Your name displays on other telephone LCDs when they are used to call your telephone.

## Features

### LCD Name/Number Display

Name display information for non-LCD telephones or voice mail/auto attendant devices can be stored from station 200. When name/number is recorded for non-LCD telephones or other devices, their name/number is displayed on LCD telephones when called.

#### ► To activate name/number information

1. Press **TALK + #621**.
2. Press **TALK**.

Current information appears on the display after the call is released.

The new information is stored and appears on the display. For example, if the name is "TOSHIBA EXT. 200", that appears on the display.

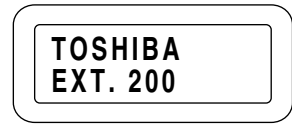

#### ► To clear name/number display

1. Press **TALK + #620**.
2. Press **TALK**.
3. Press a [DN] + **#621** to redisplay a name after it has been cleared.

You hear a confirmation tone, then a busy tone.

When a user name is set, your title appears on the LCD during direct, forwarded, and hunted calls. On override or OCA calls, the LCD does not display the title.

A name is displaced by Message and Call Forward settings if they are set.

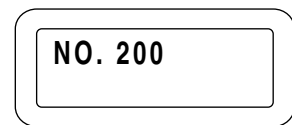

# Messaging

## Calling Station Messaging

You can set a message that appears on the LCD of telephones that call your telephone by following the instructions on the left.

### ► To create an LCD message for telephones that call you

- |   |   |
|---|---|
| <p>1. Press <b>LCD Msg Select</b><br/>...or press a [PDN] + <b>#68</b>.</p> |   |
| <p>2. Dial the number of the message you want.</p>                          | <p>Personal message (10~19) an system message (60~99). The selected message is displayed.</p>   |
| <p>3. Press <b>LCD Msg Select</b><br/>...or <b>Spkr</b>.</p>                | <p>The LCD Msg Select LED lights continuously, and the selected message is set. The message is sent to LCD telephones that call your telephone.</p> |

## Cancelling a Calling Station Message

### ► To cancel a message that has been set at your station

- |   |   |
|---|---|
| <p>► Press <b>LCD Msg Select</b><br/>...or press a [PDN] + <b>#68</b></p> | <p>The LCD Msg Select LED goes out.</p> <p>The LED lights.</p>                |
| <p>...or press <b>Spkr</b>.</p>   | <p>The LED goes out. A personal message (10~19) remains stored in memory.</p> |

## Message Waiting

If you call a station [DN] and it is busy or its user does not answer, you can leave a message waiting indication by pressing the **Msg** button. The Msg LED at the called station flashes after you press the button. The user can call you back by pushing the **Msg** button with the flashing LED. (Voice mail devices, as well as people, can leave message waiting indications.)

All telephones have a fixed **Msg** button/LED for receiving/retrieving messages left by callers that called the [PDN]. Telephones that own [PhDNs] can also have flexible message waiting [PhDN/MW] buttons/LEDs for receiving/retrieving messages left by callers.

Each Message Waiting indication can accept up to four MW indications at each [DN] or [PhDN] at one time. One of the indications for each [DN] is reserved for the Message Center set in system programming.

### ► To answer a Message Waiting

1. Press <b>Msg</b> when the Msg LED is flashing red. If there is no answer, hang up and try at a later time.	Your telephone rings the station or voice mail device that set the indication. If there is no answer, the LED continues to flash.
2. Press <b>TALK</b> after receiving the message to terminate the call.	Voice mail devices may cancel the indication after a short delay.
3. Repeat the Steps to retrieve additional messages.	The Msg LED flashes if you have more messages.

The called party must answer—by either going off-hook or by pressing the **Spkr** button—for the indication to be cancelled automatically.

### ► To cancel Message Waiting

► Press <b>Msg</b> to answer	The Msg indication is cancelled when the called party answers.
------------------------------	--

...or press **TALK + #409**.

The Msg indication cancels without calling the telephone or VM device which set the Msg indication on your telephone.

► **To set a Message Waiting light on another telephone**

1. Press a [DN] and dial a [PDN] or a [PhDN].
2. Press **Msg** or press **7** while listening to the ringback or busy tone.
3. Press **TALK**.

You hear ringback tone or busy tone.

The Msg LED associated with the dialed number flashes at the called telephone. The Msg LED lights steady at your telephone.

- If you dialed a [PDN], the LED of the fixed **Msg** button flashes.
- If you dialed a [PhDN] and that station has a **MW** button specifically associated with the [PhDN], then that button's [PhDN/MW] LED flashes. If the called station does not have a [PhDN/MW] button, then dial the [PDN] to leave a message.

The Msg LED continues to flash at the called telephone, until the called party retrieves the message by pressing the Flashing (fixed) **Msg** button or the [PhDN/MW]. After setting a message waiting indication on another telephone, the Msg LED turns off at your station after you press **TALK**.

► **To cancel a Message Waiting light on the other telephone set from your telephone**

1. Dial the station number on which you left the indication.
2. Press **Msg** twice or press **7** twice.

## [PhDN/MW] Message Waiting

To use this feature, your telephone must be programmed for both [PhDNs] and Message Waiting (**MW**) buttons.

Your telephone has one built-in Message Waiting (**Msg**) button that works with your [PDN] (see Message Waiting for a detailed explanation of this feature.).

### ► To set a Message Waiting indication for a [PhDN/MW]

- Follow the same procedure used to set a message light on another telephone.

### ► To respond to [PhDN/MW]

1. Press the [PhDN/MW] indicated by the flashing red LED.

...or answer a message by pressing **TALK**. If there is no answer, hang up and try at a later time.

2. Press **TALK** after receiving the message.
3. Repeat Steps 1 and 2 to answer the next messages.

Your telephone rings the station or voice mail device that left the message. (The LED on your telephone continues to flash.)

If you have more than one message waiting indication from different sources, the red LED continues to flash, after you answer the first message.

### ► To cancel Message Waiting set on a [PhDN/MW]

A flashing [PhDN/MW] indicates that there is a message waiting on that button; however, if you have listened to that message (which should turn the LED off) or if for some reason you wish to turn it off, you can follow the steps below to turn it off.

1. Press the [PhDN] associated with the flashing.
2. Enter **#409**.

You hear a steady dial tone and the [PhDN] LED lights steady.

The dial tone stops.

3. Press **TALK**.

The flashing red Message Waiting LED stops, indicating that the message has been canceled.

## Off-hook Call Announce (OCA)

This feature enables you to call and speak through either the handset or the speaker of an off-hook, busy digital telephone. There are two kinds of OCA:

- ◆ Handset Off-hook Call Announce (HS-OCA)—enables an announcement to be made through the handset. No special hardware is required.
- ◆ Speaker Off-hook Call Announce (SP-OCA)—enables an announcement to be made through the speaker. The called telephone must be equipped with optional hardware.

### Activating Off-hook Announce (OCA)

If your system programming is set for automatic OCA, you are connected as an OCA call immediately; otherwise, when you hear busy tone, you must press **2**.

If your system is set for Tone Signaling, you hear ringback tone and must press **1** to OCA. If you hear busy tone after pressing **1**, press **2** to activate OCA. If you hear busy tone, press **2** (you hear ringback tone, then press **1** to OCA).

### Handset Off-hook Call Announce (HS-OCA) Calling

#### ► To make an HS-OCA call with Voice First Signaling

1. Press **TALK**.

You hear a single tone and are able to talk to the station if your station is programmed for automatic HS-OCA operation.

2. Call the desired station.

## Features

### *Off-hook Call Announce (OCA)*

3. Speak to the called party if you hear silence
4. ...or press **2** if you hear busy tone.
5. Press **2** to speak to the called station if your station is not programmed for automatic HS-OCA operation and if you hear DND busy tone.

**Note** Your station must be programmed to override DND to OCA a DND station.

### ► To make an HS-OCA call with Tone Signaling

1. Press **TALK** and call the desired station.
2. Press **21** or **12** to speak to the called station.
3. Press **2** if you receive busy tone. Then press **1** to OCA  
...or if you receive ring tone, press **1** to OCA (you may hear busy tone), then press **2** to OCA.

If you receive busy tone after pressing **21**, the called station is either busy on a speakerphone call or does not have the OCA option set in system programming. Either condition blocks OCA.

You hear ring tone.



## Speaker Off-hook Call Announce (SP-OCA)

This feature enables you to call and speak through the speaker of an off-hook, busy digital telephone.

### ► To make an SP-OCA call with Voice First Signaling

<ol style="list-style-type: none"><li>1. Press <b>TALK</b> and call the desired station.</li><li>2. Speak to the called party ...or press <b>2</b> (if a busy tone is heard or your station is not programmed for automatic SP-OCA operation, you must press <b>2</b> to speak to the called station).</li></ol>	<p>You hear a single tone and can talk to the station if your station is programmed for automatic SP-OCA operation.</p>
--	---

### ► To dial an SP-OCA call with Tone Signaling

<ol style="list-style-type: none"><li>1. Press <b>TALK</b> and call the desired station.</li><li>2. If you receive busy or ring tone, press <b>21</b>.</li><li>3. Speak to the called station.</li></ol>	<p>If you receive busy tone after pressing <b>21</b>, the called telephone is either busy on a speakerphone call or does not have the OCA option set in system programming.</p>
--	---

## Override Calls

Busy Override enables you to send a muted ring tone to a busy station to indicate that a call is waiting and DND Override lets you send a tone to an idle or busy station in the DND mode to indicate that a call is coming in. You can enter an established conversation with Executive Override.

### Busy Override

#### ► To initiate a Busy Override signal

- 
- Press **2** after reaching a busy station

...or press **21**.

A tone is heard at the busy station, indicating that a call is waiting.

...or for Off-hook Call Announce activation:

- If your station is equipped for manual Off-hook Call Announce, pressing **2** (with Voice First Signaling) or **21** (with Tone Signaling) makes an Off-hook Call Announce call to that station.
- If your station is equipped with Automatic Off-hook Call Announce and the called station is able to receive OCA, you do not receive a busy tone and you may converse with the called party after dialing the station number.

### DND Override

#### ► To initiate a DND Override signal

- 
- Press **2** after reaching a DND station.

A tone signal is heard at the DND station indicating that a call is coming in.

Your station must be enabled in system programming to send a DND Override signal. Also, a telephone can be enabled in system programming to block DND Override from all other telephones.

**Note** Privacy Override is blocked by DND. However, OCA is possible to DND stations from stations that are allowed DND override.

## Executive Override

### ► To initiate Executive Override

- After reaching a busy station, press **3**. Enter the conversation.

An optional tone signal may be heard by the called parties prior to your entering the conversation.

## Page Announcements

Station users can make page announcements to telephones and external speakers.

### ► To make a Page Announcement Automatic Busy Redial (ABR)

1. Press a [DN], and enter a paging access code.  
See [“Access Codes” on Page 90](#).
2. Use a normal voice level to make your announcement, then repeat it.
3. Hang up.

Each of the page access codes (including the [PDN] button) can be stored on an **SD** button.

## Privacy On-Line

This option blocks a user at a station programmed with Privacy Override from entering a line conversation by pressing a common **Line** button. Your station must be assigned with the **Privacy On-Line** button in system programming to activate this

## Features

### Privacy On-Line

feature. The button does not block Busy Override or Executive Override. Busy and Executive Override are described earlier in this guide.

#### ► To make all lines on your station private

- Press **3**.

The LED lights steady and station users cannot enter line calls on your station by using Privacy Override.

#### ► To cancel Privacy Override

This optional feature enables you to enter an established call on a private common **Line** button. Up to two station users may enter an existing line-to-station call (allowing up to three stations to be connected to a line). To access this feature, your station must be assigned with Privacy Override in system programming, or the station that is already connected to the line must be in the Privacy Release mode.

---

**Important!** *Privacy Override only operates on common **Line** buttons; it does not operate on common [DN] buttons which are always private. See “Conference Calls” which allow up to four parties to talk on a [DN] button.*

---

#### ► To override Privacy On-Line

1. Press a busy **Line** button.

The LED turns off and station users can enter line calls on your station by using Privacy Override.

You are connected to the line and can participate in the conversation.

Connected parties may hear an optional tone signal before you enter the conversation.

**Note** Station users with a **Privacy Release** button can allow stations to enter their conversations on common **Line** buttons, even if the station entering the conversation is not programmed for Privacy Override.

# Privacy Release

If you press the optional **Privacy Release** button, any other station user can enter your call on a private common **Line** button just by pressing **Line** on their telephone. Your station must be assigned Privacy Release in system programming to activate this feature. Up to two stations can enter an existing external call (allowing up to three stations to be connected to a line).

**Note** Privacy Release only applies to calls on common **Line** buttons; calls on common (multi-appearing) [DN] button calls are always private and cannot be accessed by more than one telephone, even if other telephones share a common [DN].

## ► To activate Privacy Release

- Press **Privacy Release** while on a line call.

The Privacy Release LED lights steady and the line flashes at all appearances. Station users should be able to enter your calls by pressing a common **Line** button. Only one station can enter each time **Privacy Release** is pressed.

You must be on a line call to activate this feature. The Privacy Release LED turns off when another station has entered your external call.

## ► To deactivate Privacy Release

- Press **Privacy Release** again.

The Privacy Release LED turns off and station users without Privacy Override cannot enter your calls by pressing a common line. If you do not deactivate Privacy Release while on the call, it turns off when you hang up. Private lines deny station users access to busy common **Line** buttons.

## Release and Answer

This feature enables you to automatically disconnect or transfer an active call and answer a new call via the push of a button, instead of with the handset.

### Notes

- This feature requires that you are currently connected to an existing call.
- Your telephone must have been programmed with the **Release and Ans** button.

### ► To release a call and answer another

- Press the **Release and Ans**

...or press the **Cnf/Trn** and dial a “transfer-to” destination. Then, press **Release and Ans**

...or press a **DSS** button of a “transfer-to” destination, then press **Release and Ans**.

The Line or [DN] LED flashes to indicate a new incoming call while you are connected to the existing call. You hear a muted, Busy Override or Camp-on-busy tone. The original call is released and you can answer the new call.

This transfers the original call and answers the new call.

This transfers the original call and answers the new call.

## Speed Dial

Speed Dial enables you to call a telephone number with a brief access code or an optional feature button. Strata DK provides two types of Speed Dial numbers—Station and System.

- ◆ Station Speed Dial numbers are assigned by individual station users to their own station and can only be dialed at their station.

- ◆ System Speed Dial numbers can only be assigned from attendant consoles or station 200 (typically the System Administrator's station), but they can be used by other stations.

Your station times out to the idle mode if the following storage procedures are not completed within one or three minutes. The time is set in system programming.

## Storing Station Speed Dial Numbers

You can store personal telephone numbers on either Station Speed Dial buttons or access codes. You can call the telephone number by either pressing the button or dialing the access code.

### Notes

- Speed Dial number storage requires **Redial** and **Speed Dial** to be programmed as flexible keys on the telephone.
- Redial functions, only if assigned to an **F1~F4** function key on the cordless.
- Using Speed Dial from the system works only if assigned to an **F1~F4** function key or **Speed Dial** button deleted from all buttons (use \*).

### ► To store a Station Speed Dial Number

1. Do not lift the handset.
2. Press **Redial**.
3. Press the **SD** button you wish to store the telephone number on  
  
...or press **Speed Dial** and enter the code that you want to store the telephone number on.
4. Enter the telephone number (up to 20 digits).

**SD** buttons are assigned in system programming.

Station Speed Dial access codes are 10~49.

## Features

### Speed Dial

5. To store [DN] button access, followed by a CO Line access code before the telephone number to allow one-touch dialing of telephone numbers, See [“Access Codes” on Page 90.](#)
6. Press **Redial**.

Repeat this procedure to replace stored telephone numbers with new ones. To clear a Speed Dial entry, repeat this procedure, skipping Step 4.

The number is stored. The stored number is dialed when you press **SD**, or **Speed Dial** and the Speed Dial access code.

## Stored Station or System Speed Dial Calling

You can call stored Speed Dial numbers by pressing a button or by entering a Speed Dial code. To store speed dial numbers, see the previous instructions. **Speed Dial** and **SD** buttons are assigned to stations in system programming.

### ► To call with a Speed Dial button

1. Access a line. (See [“Access Codes” on Page 90](#) for information on CO Line buttons and access codes.)
2. Press **SD**.

The system dials the telephone number assigned to the button.



### ► To call with a Speed Dial access code

1. Access a line. (See “Access Codes” on Page 90 for information on CO Line access codes.)
2. Press **Speed Dial**  
...or **\*** if your telephone does not have the **Speed Dial** button.
3. Enter the Speed Dial code.

**Note** Speed Dial cannot appear on any button position if the port that the cordless is connected to uses **\*** as an access code.

Station Speed Dial codes are **10~49**; System Speed Dial codes are **600~699** or **60~99** (see Appendix on Page 83 for additional Speed Dial codes). The system automatically dials the number assigned to the code.

## Timed Reminders

You can set five separate reminders at your station. Your telephone sends a distinct beep at the exact minute and hour you set for any of these reminders, either one time or daily.

**Note** This feature requires **Redial** to be programmed, or a flexible key.

### ► To enter a Timed Reminder

1. Press a [DN] and dial **#605~#609**.

You have a choice of five different reminders.

## Features

### Timed Reminders

2. Enter the desired time by entering two digits for the hour of the day (24 hour format - HH) and two digits for the minute (MM).  
Example for 8:03 PM, enter 20 and then 03.
3. Press **0** for an every day reminder, or **1** for a one-time reminder only.
4. Enter desired LCD message number, station number (**10~49**), system code (**60~99**), or **00**.
5. Press **Redial**.

#### Desktop Display

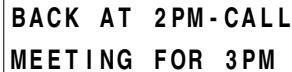

BACK AT 2PM - CALL  
MEETING FOR 3PM

#### Cordless Display



BACK AT  
2PM CALL

The first 16 characters only display when the timed reminder calls back.

The time is recorded in memory and a burst of dial tone is received to confirm successful entry.

Example:



605HHMM162 #  
#62

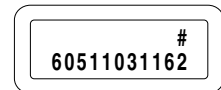

60511031162 #  
#62

Sets a message for 11:03 AM delivery; sends Message #62 once.

### ► To cancel a Timed Reminder

1. Press a [DN], then dial **#605~#609** depending on which reminder set you wish to cancel.
2. Press **Redial**.

Dial **#605** to cancel the reminder set for **#605** or dial **#606** to cancel the reminder set for **#606**, etc.

**Note** You can only cancel one reminder at a time.

The reminder is cancelled.

## Toll Restriction Override

Stations can be individually restricted from making toll calls. Each station can be allowed or denied specific area and office codes, long distance information calls, international calls and/or operator-assisted calls. You can completely override Toll Restriction at selected stations or you can change the station's Toll Restriction class. The station resumes its normal class at the conclusion of the call.

### ► To override/change Toll Restriction

- |  |   |
|--|---|
| 1. Access an outgoing line using a <b>Line</b> or [DN] button.<br><br>See <a href="#">“Access Codes” on Page 90</a> for Line Access Codes or ask your System Administrator for the proper code to be used for this type of call. | You hear dial tone, and the Line LED flashes steady.  |
| 2. Press <b>Cnf/Trn + #47</b> .  | You no longer hear dial tone.   |
| 3. Enter the four-digit Toll Restriction Override Code.  | You hear dial tone. For security reasons, the override codes are only available on a selected basis. See your System Administrator. |
| 4. Dial a telephone number.  |   |

# Two (Tandem) Line Connection

## Using a [DN] Button

This feature enables you to connect two lines, then drop out of the conversation.

### ► To connect two outside lines (using a [DN] button)

1. Press **Cnf/Trn** while talking to an external party on a [DN] button.

2. Dial a line access code and then the external telephone number of the other party (see [“Access Codes” on Page 90](#)).

Ask your System Administrator for the proper code to be used for this type of call.

3. Press **Cnf/Trn** after the party answers.

Press [DN] and then **Cnf/Trn** to return to the original call if you receive a busy tone/no answer.

4. Press **Cnf/Trn** and hang-up.

5. Press **TALK**.

You hear dial tone, the [DN] LED flashes at the conference rate.

The [DN] LED lights steady and all parties are conferenced.

You hear dial tone and the [DN] LED flashes at the exclusive-hold rate.

The [DN] LED continues to flash at the exclusive-hold rate and the two lines are connected. The LED turns off when the external parties hang up.

If the public telephone company provides auto disconnect, the connection may release automatically when the parties hang up. If not, the lines must be supervised to be disconnected.

## Using Line Buttons

This feature enables a station user to connect two lines, then drop out of the conversation. Both **Line** buttons (or **Pooled Line Grp** buttons) must appear on your telephone to allow tandem connection to be established from your telephone.

### ► To connect two outside lines using the Line button

1. Press **Cnf/Trn** while on a line call.

After you press the button, you hear dial tone, the Line LED flashes at the conference rate. The new Line LED lights steady.

2. Press another **Line** button and dial a telephone number.

The Line LEDs light steady and all parties are conferenced.

3. Press **Cnf/Trn** after the party answers.

...or return to the original call if you receive a busy tone/no answer by pressing the original **Line** button.

4. Press **Cnf/Trn**.

You hear dial tone.

- The Line LEDs flashes at the exclusive hold rate and the LED lights steady.
- Both Line LEDs continue to flash at the exclusive hold rate and the two lines are connected. The LED turns off.

5. Press **TALK**.

If the public telephone company provides auto disconnect, the connection may release automatically when the parties hang up. If not, the lines must be supervised to be disconnected (See the previous "Supervision" instructions).

## Features

### *Two (Tandem) Line Connection*

#### ► To supervise a tandem call and release it

---

<ol style="list-style-type: none"><li>1. Press either a [DN] or <b>Line</b> button.</li><li>2. Go back on-hook if the parties have hung up ...or <b>Cnf/Trn</b> and hang-up if the parties are still talking.</li></ol>	<p>You are connected to both lines and both Line LEDs light steady.</p> <p>Both Line LEDs turn off and the connection is released.</p>
---	--

# Appendix

---

This appendix contains additional information for your cordless digital telephone. It is divided into:

- ◆ Installing Optional Headset
- ◆ Troubleshooting
- ◆ Range and Performance
- ◆ Nine Simultaneous Conversation Channels
- ◆ Radio Interference
- ◆ Specifications
- ◆ Available Optional or Replacement Items
- ◆ Access Codes

## Installing Optional Headset

The optional headset provides a hands-free option for the cordless digital telephone. Only use headsets especially designed or modified for use with radio frequency equipment. With the headset installed, you can use the belt clip to carry the handset and conduct a conversation using the headset.

1. Open the cover over the headset jack.
2. Plug the headset in. No other settings are needed.

All feature operations remain the same as using the handset. When using the headset, the handset earphone and microphone are disconnected.

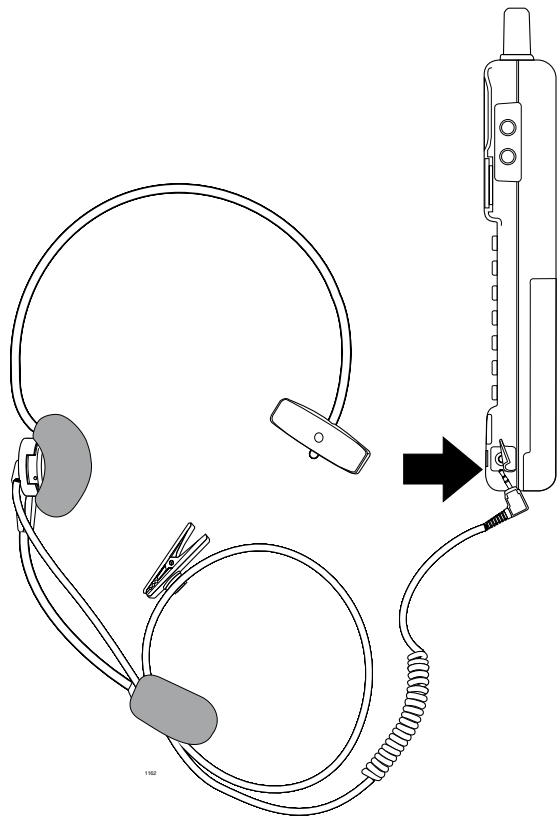



# Troubleshooting

If your cordless telephone is not performing to your expectations, try these suggestions. If you are still unable to resolve the problems, contact your telephone system administrator. Do not attempt to service this unit yourself. All service must be done by qualified service personnel.

Problem	Suggestion
CHARGE LED does not come on when handset is placed on base unit.	<p>Make sure the AC adapter is plugged into the base unit and wall outlet.</p> <p>If the AC adapter is plugged into a wall outlet with a switch, make sure the switch is turned on.</p> <p>Make sure the handset is properly seated in the base unit.</p> <p>Make sure the nickel-cadmium battery pack is properly placed on the handset.</p> <p>Make sure that the charging contacts on the handset and base unit are clean.</p>
Conversation interrupted frequently.	<p>Make sure that the base unit antenna is fully vertical.</p> <p>Move closer to the base unit.</p>
Press <b>TALK</b> and get no dial tone.	Move closer to the base unit.
Cannot configure the cordless digital telephone.	<p>Check both ends of all telephone line cords for good connections.</p> <p>Make sure the AC adapter is plugged into the base unit and wall outlet.</p>
Handset does not ring.	<p>The nickel-cadmium battery may be weak. Charge the battery pack for 8-10 hours.</p> <p>Check the Ringer Alert setting. It may be set to Ring Off.</p> <p>Make sure the base unit antenna is fully vertical.</p> <p>The handset may be too far away from the base unit.</p>
Tone noise	Move cordless telephone to the right side of the DKT.
Other problems	Contact your telephone system administrator.

## Range and Performance

The cordless digital telephone is designed to operate up to 1.1 miles from the base in a completely unrestricted test environment. Typically, ranges of 300 to 400 feet are possible, depending upon the structure of the building the telephone is used in.

For optimum range and performance from your cordless digital telephone, try the following options:

- Place the base units at least 3 to 6 feet away from the deskset; at least 3 feet from metal structures; and at least 6 feet from computers, fax machines or other electronic equipment.
- Use an AC outlet not associated with computer or electromagnetic equipment.
- Wherever possible, put the base units in the middle of the coverage area.
- Mount the base units high in the room, for maximum range.
- Locate 3 or less cordless telephones 12 feet apart.
- Locate 4 to 10 cordless telephones 20 feet apart.

## Nine Simultaneous Conversation Channels

The cordless digital telephone has nine operating channels available.

A common misconception is that this limits a customer to nine cordless phones. This is not the case. Each cordless digital telephone can operate on any of the nine channels. When you turn on a cordless digital telephone, the phone selects an available channel within its' range. In a given cordless range, nine simultaneous calls can be made. In most businesses, it is unlikely that all nine channels will be in use at the same time. Typically 20 to 30 phones can share the 9 channels.

Another factor is the distribution of the phones in a facility. If your cordless digital telephones are disbursed throughout a facility, there should not be contention for channels. If there are more than nine cordless digital telephones in one area and nine users are using their cordless phones, a tenth user would not be able to connect at that time.

## Radio Interference

Radio interference may occasionally interrupt your conversations. When this happens, remember that your unit is not defective. If these noises continue, and are too distracting, move to a different location while you are talking on the telephone. (As noted in the preceding Range section, you may need to move the base unit as well.) If the situation persists, contact your telephone system administrator.

## Specifications

General	
Frequency Control	Frequency Synthesizer
Modulation	MSK
Operating Temperature	-10° to 50° C

Base Unit	
Receive/Transmit Frequency	903.20 to 924.95 MHz (9 channels)
Power Requirements	10VDC from supplied AC adapter
Size	Width 5.0 inches Depth 7.5 inches Height 3.7 inches
Weight	Approximately 1 lb., 5 oz.

Handset	
Receive/Transmit Frequency	903.20 to 924.95 mHz (9 channels)
Power Requirements	Rechargeable Nickel-Cadmium battery pack
Size	Width 2.125 inches Depth .875 inches Height 6.5 inches with antenna
Weight	Approximately 10.5 oz. with battery
Battery	Capacity 400 mAh, 4.8V Talk Mode 2.5 hours (typical) Standby Mode 42 hours (typical)

## Available Optional or Replacement Items

Contact your telephone system administrator for the following optional accessories and replacement parts.

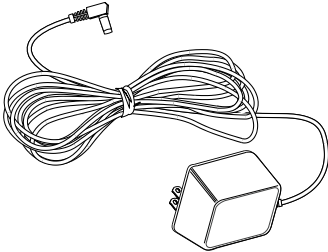

**AC Adapter**

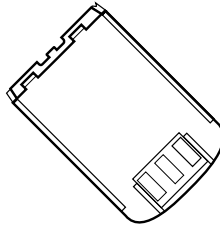

**400 mAh Battery**

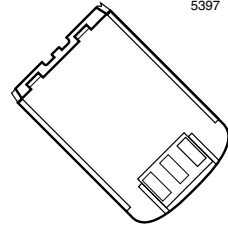

**730 mAh Battery**

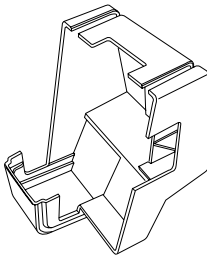

**Base Unit Wall Mount**



**User Guide**

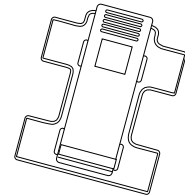

**Belt Clip**

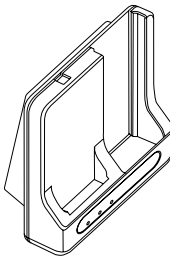

**Desktop/Wallmount Charger**

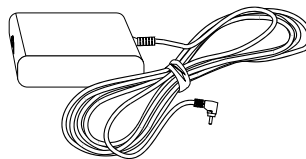

**Battery Backup**

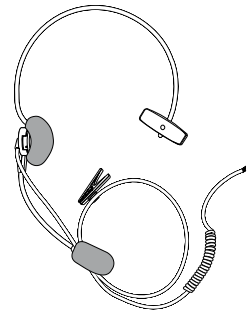

**Headset**

# Access Codes

This section contains access codes for outside CO lines, Paging Group and Paging Zone Codes, and Call Pickup Codes. It also contains Feature Access Codes and instructions for programming them onto Speed Dial buttons.

**Important!** *The following table provides an overview of the Feature Access Codes for various Toshiba business telephone systems. This table may not cover all Feature Code entries. For example, “XXX” and “YY” in this table are variable entries that may change with different Feature Access Codes. Please see the relevant Digital Telephone User’s Guide to specify the needed entry*

Feature	Strata DK14, DK40, DK16e, DK424, DK280	Strata DK8 & DK16, DK24/56/96
Account Code	<b>Conf/Trn + #46 + XXXXX</b>	<b>Conf/Trn + 46 + XXXXX</b>
Automatic Busy Redial -- Cancel	<b>TALK + #44 + TALK</b>	<b>TALK + 44 + TALK</b>
Automatic Busy Redial -- Set	<b>Conf/Trn + #44 + TALK</b>	<b>Conf/Trn + 44 + TALK</b>
Automatic Callback -- Cancel	<b>TALK + #43</b>	<b>TALK + 43</b>
Call Forward - All Calls	<b>TALK + #601 + XXX + TALK</b>	<b>TALK + 601 + XXX + TALK</b>
Call Forward - Busy	<b>TALK + #602 + XXX + TALK</b>	<b>TALK + 602 + XXX + TALK</b>
Call Forward - Busy/No Answer <sup>1</sup>	<b>TALK + #604 + XXX + Speed Dial + YY + TALK</b>	<b>TALK + 604 + XXX + Speed Dial + YY + TALK</b>
Call Forward - External	<b>TALK + #670 + No. + TALK</b>	—
Call Forward - No Answer <sup>1</sup>	<b>TALK + #603 + XXX + Speed Dial + YY + TALK</b>	<b>TALK + 603 + XXX + Speed Dial + YY + TALK</b>

Feature	Strata DK14, DK40, DK16e, DK424, DK280	Strata DK8 & DK16, DK24/56/96
Call Park	<b>Conf/Trn + #41 + Line + TALK</b> <b>Conf/Trn + #332 + XXX + TALK</b> (Release 3)	<b>Conf/Trn + 41 + Line + TALK</b>
Call Park and Page	<b>Conf/Trn + #331 + XXX + Page</b> (Release 3)	—
Call Park Retrieve	<b>TALK + #42</b> <b>TALK + #332 + TALK</b> (Release 3)	<b>TALK + 42</b>
Call Pickup - External Page	<b>TALK + #5#35</b>	<b>TALK + 535</b>
Call Pickup - Held Line	<b>TALK + #5(#7001~#7144)</b>	<b>TALK + 5(701~704)</b>
Call Pickup - Int Pg, DoorPhone	<b>TALK + #5#30</b>	<b>TALK + 530</b>
Call Pickup - Other Groups	<b>TALK + #5(#320~#339)</b>	—
Call Pickup - Own Group	<b>TALK + #5#34</b>	—
Call Pickup - Ringing Line	<b>TALK + #59</b>	<b>TALK + 59</b>
Call Pickup - Station	<b>TALK + #5XXX</b>	<b>TALK + 5XXX</b>
Door Phones	<b>TALK + (#151~#163)</b>	<b>TALK + (551~556)<sup>1</sup></b>
Emergency Page	<b>TALK + #400</b>	—
Hook Flash	<b>Conf/Trn + #45</b>	<b>Conf/Trn + 45</b>
LCD Message Cancel	<b>TALK + #68 + TALK</b>	<b>TALK + 68 + TALK</b>
LCD Message Set	<b>TALK + #68 + XX + TALK</b>	<b>TALK + 68 + XX + TALK</b>
Message Waiting Cancel	<b>TALK + #409 + TALK</b>	—

## Appendix

### Access Codes

Feature	Strata DK14, DK40, DK16e, DK424, DK280	Strata DK8 & DK16, DK24/56/96
Page Access - All Page	<b>TALK + #39</b>	<b>TALK + 39</b>
Page Access - External Zones	<b>TALK + (#35~#38)</b>	<b>TALK + (35~38)</b>
Page Access - Internal All	<b>TALK + #30</b>	<b>TALK + 30</b>
Page Access - Internal Pg Grps	<b>TALK + (#311_#318)</b>	<b>TALK + (31~34)</b>
Speed Dial - Station	<b>TALK + (Speed Dial or *) + (10~49)</b>	<b>TALK + (Speed Dial or *) + (10_49)</b>
Speed Dial - System	<b>TALK + (Speed Dial or *) + (600~699) or (60~99)</b>	<b>TALK + (Speed Dial or *) + (60~99)</b>
Timed Reminder - Cancel	<b>TALK + (#605~#609) + TALK</b>	<b>TALK + (605~609) + TALK</b>
Timed Reminders	<b>TALK + (#605~#609) + HHMMX + TALK</b>	<b>TALK + (605~609) + HHMMX + TALK</b>
Toll Restr Override	<b>Conf/Trn + #47 + XXXX + No.</b>	<b>Conf/Trn + 47 + XXXX + No.</b>
Trunk Access - LCR/General	<b>TALK + 9 + No.</b>	<b>TALK + 9 + No.</b>
Trunk Access - Line Groups	<b>TALK + (801~816) + No.</b>	<b>TALK + (81~84) + No.</b>
Trunk Access - Trunk Access	<b>TALK + (#7001~#7144) + No.</b>	<b>TALK + (701~704) + No.</b>
Voice Mail ID	<b>TALK + #656 + 91 + XXX + TALK</b>	<b>TALK + 656 + 91 + XXX + TALK</b>
Voice Mail Retrieval	<b>TALK + #657 + 92 + XXX + TALK</b>	<b>TALK + 657 + 92 + XXX + TALK</b>



## Notes

- Call Forward No Answer and Call Forward Busy can only be activated when Speed Dial is assigned to an **F1~F4** function key, or deleted from all buttons (use \*).
- Redial functions only if assigned to an **F1~F4** function key on the cordless.
- Using Speed Dial from the system will function only if assigned to an **F1~F4** function key or Speed Dial key deleted from all buttons (use \*).

## CO Line Access Codes

CO lines are used when you dial an outside number. If your telephone does not have a **CO** or **Line** button, you can enter the appropriate code listed in [Table 1](#) to access an outside line.

You can also store the code on a **SD** button for one-touch access. If you are storing a CO line access code onto a Speed Dial code, enter **44** before the CO access code (e.g., to store code **7001**, enter **447001**).

In some systems, **9** is used as a general group code or to access Least Cost Routing (LCR). System users are required to dial **9** in order to access an outside line. If you press **9** in a system programmed with LCR, you may not hear internal dial tone, depending on system programming.

See your System Administrator for the code which applies to your telephone.

### ► To access a line

- Press [PDN] + CO Line Access Code.

**Table 1** CO Line Access Codes

System	CO Line Access Codes
DK14	<b>801~804</b> or <b>#7001~#7004</b>
DK16e	<b>801~808</b> or <b>#7001~#7008</b>
DK40	<b>801~808</b> or <b>#7001~#7012</b>
DK424 (RCTUA)	<b>801~808</b> or <b>#7001~#7016</b>
DK424 (RCTUBA/BB)	<b>801~808</b> or <b>#7001~#7048</b>
DK424 (RCTUC/D)	<b>801~816</b> or <b>#7001~#7144</b>
DK424 (RCTUE/F)	<b>801~816</b> or <b>#7001~#7200</b>

### Notes

- ◆ **801~816** access line groups 1~16, respectively.
- ◆ **#7001~#7200** access individual lines 1~200, respectively.

# Feature Access Codes

Refer to the list of codes on page 90.

## Paging Group Codes

Your telephone can be assigned to page groups. Telephones can be a member of more than one group and each group can have as many as 120 stations. Station users can access each group separately by dialing an access code (Tables 2~3).

► **To enter a paging group access code**

- Press [PDN] + Access Code

**Table 2      Paging Groups**

Paging Group	Access Code	Paging Group	Access Code
Station Group A	<b>#311</b>	Station Group E	<b>#315</b>
Station Group B	<b>#312</b>	Station Group F	<b>#316</b>
Station Group C	<b>#313</b>	Station Group G	<b>#317</b>
Station Group D	<b>#314</b>	Station Group H	<b>#318</b>

**Table 3      External Paging Zones**

External Paging Zone	Access Code	External Paging Zone	Access Code
<b>DK14/DK40/DK424 (all processors)</b>			
Paging All Call Page Zone	<b>#30</b>	Paging All Call, External Page Zone	<b>#39</b>
<b>DK40/DK424 ((RCTUA, RCTUBA/BB, RCTUC/D)</b>			
Zone A	<b>#35</b>	Zone C	<b>#37</b>
Zone B	<b>#36</b>	Zone D	<b>#38</b>
<b>DK424 (RCTUE/F)</b>			
Zone A	<b>#351</b>	Zone E	<b>#355</b>
Zone B	<b>#352</b>	Zone F	<b>#356</b>

**Table 3 External Paging Zones** *(continued)*

External Paging Zone	Access Code	External Paging Zone	Access Code
Zone C	<b>#353</b>	Zone G	<b>#357</b>
Zone D	<b>#354</b>	Zone H	<b>#358</b>

## Speed Dial Access Codes

The number of station and system speed dial numbers available to you depends on the size of your company's telephone system. Check with your System Administrator to find out which codes apply to your system.

Once you store a telephone number on any of the codes listed below, you can dial the number by entering the code, such as **\*10** or **SD + 10**.

**Table 4 Speed Dial Access Codes**

Telephone System Size	Station Speed Dial Codes	System Speed Dial Codes
Small System (DK14/DK16e/DK40/RCTUA)	<b>10~49</b>	<b>60~99</b>
Medium System (RCTUBA/BB and RCTUC/D)	<b>10~49</b>	<b>600~699</b>
Large System (RCTUE/F)	<b>100~139</b>	<b>200~999</b>

**Table 5 Speed Dial Number Linking**

System	System Speed Dial Codes that can be Linked to other Speed Dial Codes
DK14, DK16e, DK40, RCTUA	<b>90~99</b>
RCTUBA/BB, RCTUC/D	<b>690~699</b>
RCTUE/F	<b>990~999</b>

# Index

---

## A

- access codes
  - CO Line, 94
  - speed dial, 96
- account code calls, 40
- account codes
  - verified, 42
  - voluntary, 41
- alarm reset, 42
- alert signaling, 42
- answering
  - a transferred call, 54
  - calls, 34
- attendant console, 39
- auto preference, 7
- auto redial, 42
- automatic
  - busy redial, 71
  - callback, 39
  - hold, 38

## B

- base unit controls and functions, 5
- battery, 12
  - charging extra packs, 13
  - extending life, 14
  - removing and charging, 12

- before you begin, 30
- busy override, 70

## C

- call
  - attendant console, 39
  - hold, 37
  - other groups, 55
  - override, 70
  - park and page, 53
  - park orbits, 52
  - pickup, 57
  - stored station, 76
  - system speed dial, 76
  - within your group, 55
- call forward, 46
  - all calls, 47
  - busy, 48
  - busy/no answer, 49
  - cancel, 50
  - external, 51
  - fixed, 52
  - no answer, 48
- call transfer with camp-on, 34
- calling station message, 63
  - cancelling, 63
- chain dialing, 27

CO line  
  button, [51, 76](#)  
  queuing with automatic callback, [45](#)  
  tandem connection, [77](#)  
CO Line access codes, [94](#)  
configuration, [15](#)

## **D**

dial  
  a stored number, [27](#)  
  internal calls, [33](#)  
direct station selection buttons (hotline), [57](#)  
directed call pickup, [54](#)  
[DN] buttons, [80](#)  
do not disturb, [57](#)  
  override, [70](#)  
door  
  lock, [58](#)  
  telephone, [59](#)

## **E**

emergency calls to the attendant console, [39](#)  
emergency override of forced account codes, [41](#)  
erase a stored number, [26](#)  
exclusive hold, [38](#)  
executive override, [71](#)

## **F**

feature access codes, [90](#)  
features, [6](#)  
forced account codes, [40](#)

## **G**

group pickup, [55](#)

## **H**

handset, [19, 21, 67](#)  
  charging, [22](#)  
  controls, [19](#)  
  volume level, [19](#)

## **I**

installation, [7](#)  
installing optional headset, [84](#)  
ISDN  
  buttons, [33, 61](#)

## **L**

LCD  
  low battery indicator, [14](#)  
  name/number display, [61](#)  
line buttons, [81](#)  
low battery symptoms, [14](#)

## **M**

memory, [21](#)  
message waiting, [57](#)  
messaging, [63](#)

## **N**

name/number display, [60](#)

## **O**

off-hook call announce  
  (HS-OCA), [67](#)  
  (OCA), [64](#)  
optional or replacement items, [89](#)

## **P**

paging group codes, [95](#)  
phantom directory numbers, [47](#)  
[PhDN/MW] message waiting, [66](#)

privacy  
  on-line, 71  
  release, 73

## R

radio interference, 87  
range, 86  
release and answer, 74  
ringer volume level, 20

## S

simultaneous conversation channels, 87  
speaker off-hook call announce  
(SP-OCA), 69  
specifications, 88  
speed dial, 57  
  access codes, 96  
SP-OCA  
  tone first signaling, 69  
spread spectrum technology, 1  
start (ISDN button), 33, 61  
store  
  a number, 25  
  station speed dial numbers, 75  
sub (subaddress ISDN button), 61  
switching calls  
  to cordless digital telephone, 23  
  to desk telephone, 24

## T

timed reminders, 77  
toll restriction override, 79  
tone/pulse dialing, 40  
tone/voice first signaling, 77  
transfer  
  a call, 34  
  an active call, 23

troubleshooting, 85

## V

verified account codes, 42  
voluntary account codes, 41

## Free Manuals Download Website

<http://myh66.com>

<http://usermanuals.us>

<http://www.somanuals.com>

<http://www.4manuals.cc>

<http://www.manual-lib.com>

<http://www.404manual.com>

<http://www.luxmanual.com>

<http://aubethermostatmanual.com>

Golf course search by state

<http://golfingnear.com>

Email search by domain

<http://emailbydomain.com>

Auto manuals search

<http://auto.somanuals.com>

TV manuals search

<http://tv.somanuals.com>