

TOSHIBA HDD & DVD / Video Cassette Recorder RD-XV47KE

**TOSHIBA**



**HDD & DVD / Video Cassette Recorder**

# RD-XV47KE

*OWNER'S MANUAL*



**OPERATIONS  
GUIDE**

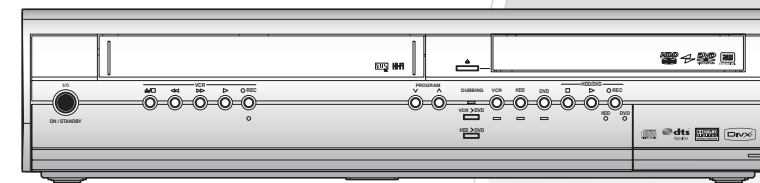

Introduction

Connections

Basic Setup

Recording

Playback

Editing

Function Setup

VCR Functions

Others

**TOSHIBA**

Printed in China



1VMN23421 / E3B90ED ★★★★★

© 2007 Toshiba Corporation

# Introduction

## Precautions

**WARNING:** TO REDUCE THE RISK OF FIRE OR ELECTRIC SHOCK, DO NOT EXPOSE THIS PRODUCT TO RAIN OR MOISTURE.

	<p><b>CAUTION</b> RISK OF ELECTRIC SHOCK DO NOT OPEN</p>		<p>The lightning flash with arrowhead symbol, within an equilateral triangle, is intended to alert the user to the presence of uninsulated "dangerous voltage" within the product's enclosure that may be of sufficient magnitude to constitute a risk of electric shock to persons.</p>
<p><b>CAUTION:</b> TO REDUCE THE RISK OF ELECTRIC SHOCK, DO NOT REMOVE COVER (OR BACK). NO USER SERVICEABLE PARTS INSIDE. REFER SERVICING TO QUALIFIED SERVICE PERSONNEL.</p>			<p>The exclamation point within an equilateral triangle is intended to alert the user to the presence of important operating and maintenance (servicing) instructions in the literature accompanying the appliance.</p>

The important note is located on the rear of the cabinet.

## Laser Safety

This unit employs a laser. Only a qualified service personnel should remove the cover or attempt to service this unit, due to the possibility of eye injury.

**CAUTION:** USE OF CONTROLS OR ADJUSTMENTS OR PERFORMANCE OF PROCEDURES OTHER THAN THOSE SPECIFIED HEREIN MAY RESULT IN HAZARDOUS RADIATION EXPOSURE.

**CAUTION:** VISIBLE AND INVISIBLE LASER RADIATION WHEN OPEN AND INTERLOCK DEFEATED. DO NOT STARE INTO BEAM.

**LOCATION:** INSIDE, NEAR THE DECK MECHANISM.

## Power Supply

The power supply is connected and the unit is live when the mains cable is plugged into a 220–240 V~, 50 Hz AC outlet. To operate the unit, press [I/O ON / STANDBY].

**WARNING: LIVE PARTS INSIDE.  
DO NOT REMOVE ANY SCREWS.**

## Caution

1. Do not attempt to open the cabinet. There are no parts inside you can service. Refer all servicing to qualified service personnel.
2. Slots and openings in the cabinet at the sides and underneath are provided for ventilation. To ensure reliable operation and to protect the unit from overheating, these openings must not be blocked or covered.  
Avoid installation in enclosed spaces such as bookcases unless suitable ventilation is provided.
3. Keep the unit away from radiators and other heat sources.
4. Avoid use near strong magnetic fields.
5. Do not push objects of any kind into the unit through the cabinet slots or openings as they could touch electrically live parts or short circuit parts resulting in a fire or electric shock.
6. Do not spill liquid on the unit. If liquid is spilled and enters the unit, consult qualified service personnel.
7. Do not stand the unit vertically. Use the unit in a horizontal (flat) position only.
8. This product is in Stand-by mode when turned off while the mains cable is connected.
9. Do not place any combustible objects on the device (candles, etc.).
10. Before moving the unit, be sure to remove any discs and unplug the mains cable from the AC outlet.
11. Disconnect the mains plug to shut off when find troubles or not in use.
12. The mains plug shall remain readily operable.
13. Read both manual instructions to ensure correct and safe installation and interconnection of the unit in multimedia systems.
14. Keep the distances 20 cm around apparatus of ventilation openings.

## Declaration of Conformity

This product complies with the requirement of the directives

EMC-Directive: 89 / 336 / EEC  
 Low Voltage Directive: 73 / 23 / EEC  
 CE Marking: 93 / 68 / EEC

We declare that the following product:  
 HDD & DVD / Video Cassette Recorder  
 Model RD-XV47KE  
 Trade Name: TOSHIBA

is in compliance with following Regulations.

EN55013: 2001+A1:2003, EN55020:  
 2002+A1:2003+A2:2005, EN61000-3-2:  
 2003+A2:2005, EN61000-3-3: 1995 + A1: 2001  
 EN60065: 2002  
 EN60825-1 Edition 1.2: 2001



### A NOTE ABOUT RECYCLING

This product's packaging materials are recyclable and can be reused. Please dispose of any materials in accordance with your local recycling regulations.

This product consists of materials which can be recycled and reused if disassembled by a specialised company.

Batteries should never be thrown away or incinerated but disposed of in accordance with your local regulations concerning chemical wastes.



### Make your contribution to the environment!!!

- Exhausted batteries do not belong in the dustbin.
- You can dispose of them at a collection point for exhausted batteries or special waste.
- Contact your council for details.



### For Customer Use:

Carefully read the Model No. and Serial No. located at the back of the unit and enter the information below. Retain this information for future reference.

Model No. \_\_\_\_\_

Serial No. \_\_\_\_\_

## Installation Location

For safety and optimum performance of this unit:

- Install the unit in a horizontal and stable position.
- Do not place anything directly on top of the unit.
- Do not place the unit directly on top of the TV.
- Shield the unit from direct sunlight and keep away from sources of intense heat. Avoid dusty or humid locations. Avoid locations with insufficient ventilation for suitable heat dissipation. Do not block the ventilation holes on the sides of the unit. Avoid locations subject to strong vibration or strong magnetic fields.

## Avoid the Hazards of Electrical Shock and Fire

- Do not handle the mains cable with wet hands.
- Do not pull on the mains cable to disconnect it from AC outlet. Grasp it by the plug.
- If the water is spilled onto the unit accidentally, unplug the mains cable immediately and take the unit to an Authorised Service Centre for servicing.

## Moisture Condensation Warning

Moisture condensation may occur inside the unit when it is moved from a cold place to a warm place, after heating a cold room, or under conditions of high humidity. Do not use the unit for at least 2 hours to allow the inside to dry.

## About Copyright

Unauthorised copying, broadcasting, public performance and lending of discs are prohibited. This product incorporates copyright protection technology that is protected by U.S. patents and other intellectual property rights. Use of this copyright protection technology must be authorised by Macrovision, and is intended for home and other limited viewing uses only unless otherwise authorised by Macrovision. Reverse engineering or disassembly is prohibited.

## Notice for the Progressive Scan Outputs

Consumers should note that not all high definition television sets are fully compatible with this product and may cause artifacts to be displayed in the picture. In case of picture problems with 525 or 625 progressive scan output, it is recommended that the user switch the connection to the 'standard definition' output. If there are questions regarding your TV set compatibility with this 525p or 625p HDD & DVD player, please contact our customer service centre.

Introduction

Connections

Basic Setup

Recording

Playback

Editing

Function Setup

VCR Functions

Others

Manufactured under license from Dolby Laboratories. "Dolby" and the double-D symbol are trademarks of Dolby Laboratories.

"Dolby® Digital Stereo Creator enables consumers to create stereo DVD-Videos with stunning Dolby Digital sound tracks at home. The technology, when utilized instead of PCM recording, also saves recordable disc space, allowing for higher video resolution or extended recording time on each DVD. DVDs mastered using Dolby Digital Stereo Creator will play back on all DVD-Video players."

Note: This is true when the players are compatible with actual recordable DVD discs.

"DTS" and "DTS Digital Out" are registered trademarks of DTS, Inc.



DivX, DivX Certified, and associated logos are trademarks of DivX, Inc. and are used under license.

## Accessories Supplied

- Remote control with two R6 (AA) batteries



- RF cable

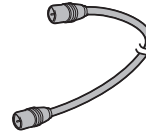

- Owner's Manual

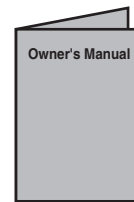

- Quick Setup Guide

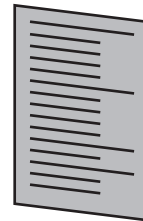

## Maintenance

### SERVICING

- Please refer to relevant topics on the "Troubleshooting" on pages 103 to 107 before returning the unit.
- If this unit becomes inoperative, do not try to correct the problem by yourself. There are no user-serviceable parts inside. Turn the unit off, unplug the mains cable, and consult your dealer or an Authorised Service Centre.

### CLEANING THE CABINET

- Use a soft cloth slightly moistened with a mild detergent solution. Do not use a solution containing alcohol, spirits, ammonia or abrasive.

### HDD HDD HANDLING

- HDD is a precision apparatus that is susceptible to vibration, strong impact or dirt. Depending on the installation environment or handling, the unit may become partially damaged or in the worst case, recording or replaying may not be available. Especially while the HDD is in motion, do not subject it to vibration or strong impact or pull out the power plug. And if a power failure occurs, the content of the recording / replaying programme may be lost.

### HDD MOVING THE UNIT

- HDD rotates at high speed when in operation. Be sure that rotation has stopped and then move the unit without subjecting it to strong impact or vibration.

### DVD CLEANING DISCS

- When a disc becomes dirty, clean it with a cleaning cloth. Wipe the disc from the centre out. Do not wipe in a circular motion.
- Do not use solvents such as benzine, thinner, commercially available cleaners, detergent, abrasive cleaning agents or antistatic spray intended for analogue records.

### DVD CLEANING THE DISC LENS

- If this unit still does not perform properly although you refer to the relevant sections and to "Troubleshooting" in this Owner's Manual, the laser optical pickup unit may be dirty. Consult your dealer or an Authorised Service Centre for inspection and cleaning of the laser optical pickup unit.

### DVD DISC HANDLING

- Handle the discs so that fingerprints and dust do not adhere to the surfaces of the discs.
- Always store the disc in its protective case when it is not used.

### VCR AUTO HEAD CLEANING

- Automatically cleans video heads as you insert or remove a videotape, so that you can see a clear picture.
- Playback picture may become blurred or interrupted while the TV programme reception is clear. Dirt accumulated on the video heads after a long extended period of use, or the usage of rental or worn tapes can cause this problem. If a streaky or snowy picture appears during playback, the video heads in the unit may need to be cleaned.
  1. Please visit your local Audio / Video store and purchase a good quality VHS Video Head Cleaner.
  2. If a Video Head Cleaner does not solve the problem, please consult your dealer or an Authorised Service Centre.

#### Note

- Remember to read the instructions along with the video head cleaner before use.
- Clean video heads only when problems occur.

Introduction

Connections

Basic Setup

Recording

Playback

Editing

Function Setup

VCR Functions

Others

## Table of Contents

<b>Introduction .....</b>	<b>2</b>	<b>Playback .....</b>	<b>60</b>
Precautions .....	2	Information on Playback .....	60
Features .....	7	Basic Playback .....	61
Choosing a Disc .....	9	PBC Function for Video CDs .....	68
Guide to the Owner's Manual .....	15	Special Playback .....	69
Functional Overview .....	16	Repeat / Programme Playback / Slide Show .....	73
Installing Batteries in the Remote Control .....	20	Search .....	74
HDD / DVD / VCR Modes Switching .....	20	Selecting the Format of Audio and Video .....	75
Guide to Display Information .....	21		
Guide to Setup Menu .....	21	<b>Editing .....</b>	<b>77</b>
Front Panel Display Guide .....	22	Guide to the Editing on this Unit .....	77
		Adding or Deleting Chapter Marks Manually .....	78
<b>Connections .....</b>	<b>23</b>	Creating Titles to a Playlist .....	79
Connections .....	23	Deleting Titles .....	81
		Deleting a Scene of a Title .....	82
<b>Basic Setup .....</b>	<b>26</b>	Editing Title Names .....	84
For the First Time Use .....	26	Protecting / Undo Protecting Titles .....	85
OSD Language Setting .....	27	Combining Titles .....	86
Channel Setting .....	27	Dividing a Title .....	87
Setting the Clock .....	30		
Selecting the Sound Mode .....	32	<b>Function Setup .....</b>	<b>89</b>
Selecting the TV Aspect Ratio .....	32	Tour of the Setup Menus .....	89
		Initial Setting .....	92
<b>Recording .....</b>	<b>34</b>	Digital Audio Setting .....	93
Information on Supported Media .....	34	Playback .....	94
Formatting a Disc .....	38	Recording .....	98
Deleting All Contents in HDD .....	39	Display .....	99
Setting Bilingual Recording Audio .....	40		
Recording Audio Select (XP) .....	41	<b>VCR Functions .....</b>	<b>100</b>
Basic Recording .....	42	Playback .....	100
One-touch Timer Recording (OTR) .....	42	Recording and One-touch Timer Recording (OTR) .....	100
Timer Recording .....	43	Search .....	101
Setting External Input Audio .....	46	Other Operations .....	102
Satellite Link .....	47	Changing the Video Colour System .....	102
Information on Dubbing .....	48	Hi-Fi Stereo Sound System .....	102
Setting for External Connection (AV3) .....	56		
Dubbing from the External Devices .....	56	<b>Others .....</b>	<b>103</b>
Finalising a Disc .....	57	Troubleshooting .....	103
Setting Disc Protection .....	58	Language Code .....	108
		Glossary .....	109
		Specifications .....	110

## Features

The following features are available with this unit.

### Recording

This unit allows you to record on the HDD, a DVD-RW / +RW disc (rewritable) and a DVD-R / +R disc (one-time write) as well as a videotape. You can choose any one for your convenience.

HDD

DVD

VCR

#### One-touch Timer Recording (OTR)

[▶ Page 42] (HDD/DVD) or [▶ Page 101] (VCR)

This feature allows you to start the recording right away with just one-touch. And each press of [REC ●] (HDD/DVD/VCR) increases the recording time by 15 minutes up to 4 hours.

#### Left Channel Stereo Recording

The unit can record monaural sound from the left channel as pseudo stereo sound (same left and right channels) automatically. (AV3 only)

HDD

DVD

#### Timer Programming up to 32 Programmes

[▶ Pages 43-46]

You can programme the unit to record up to 32 programmes within a month period. Daily or weekly repeating programmes can also be programmed.

HDD

#### 160 GB Hard Disc [▶ Pages 34-37]

This unit is equipped with a 160 GB hard disc which allows you to record up to 272 hours (with SLP mode). The HDD operates just like a VR mode DVD-RW disc.

Most of the functions which are available with a VR mode DVD-RW disc can be performed on the HDD too.

#### VPS / PDC [▶ Page 45]

This system assures that the TV programme you wish to record using Timer Recording will be recorded exactly from the beginning to the end even if the actual broadcasting time is shifted.

#### Automatic Chapter Marker [▶ Page 39]

Each recorded title is automatically marked with chapter marks.

DVD

#### Automatic DVD Menu Making

[▶ Page 57]

DVD Menus are made automatically when a Video mode or +VR mode disc is finalised.

#### Automatic Finalise

[▶ Page 58]

You can set the disc to be finalised automatically when the disc space runs out.

#### Relay Recording [▶ Page 44]

When you Timer Record to DVD, if the disc runs out of the space, or if there is no recordable disc in the unit, it automatically changes the recording media to the HDD.

### Dubbing

With this unit, you can enjoy bi-directional dubbing with HDD, DVD or VCR.

HDD

DVD

#### Fast Dubbing [▶ Page 48]

This feature offers you the dubbing speed of 32 times the SLP mode dubbing for DVD-RW / R and 9.6 times the LP mode dubbing for DVD+RW / R at the maximum.

#### Just Dubbing [▶ Page 54]

When dubbing from HDD to DVD, if you set the Rec Mode to "Auto", the Rec Mode will automatically be adjusted so the titles will fit nicely in the remaining space of the disc when there is not enough space in the disc. When dubbing from DVD to HDD, the Rec Mode will automatically be adjusted for the titles to fit a 4.7 GB DVD.

### Playback

HDD

#### Simultaneous Playback and Recording

[▶ Page 71]

You can play back a title while recording.

HDD

DVD

#### Theatre-quality Sound at Home [▶ Page 24]

When connecting the unit to an amplifier or a decoder that is compatible with Dolby Digital or DTS, you can experience a theatre-quality sound environment.

#### Variable Skip [▶ Page 72]

You can skip forward a certain time, which is specified in the Setup Menu in advance, with one-touch while playback.

#### Variable Replay [▶ Page 72]

You can skip back a certain time, which is specified in the Setup Menu in advance, with one-touch while playback.

#### Title Sorting [▶ Page 62]

You can sort and display the titles by order of name or date. You can also sort out the unplayed titles (HDD only).

HDD

#### Time Shift Playback [▶ Page 70]

You can play back a title being recorded from the beginning while recording continues.

Introduction

Connections

Basic Setup

Recording

Playback

Editing

Function Setup

VCR Functions

Others

## Editing

**HDD****DVD**

### **Adding or Deleting Chapter Marks Manually**

[ ➤ Page 78]

You can add chapter marks to a title.

### **Creating Titles to a Playlist (VR mode DVD-RW discs and HDD only)**

[ ➤ Page 79]

You can create a title to the Playlist.

### **Deleting Titles**

[ ➤ Page 81]

You can delete titles which you do not need anymore.

### **Deleting a Scene of a Title (VR mode DVD-RW discs and HDD only)**

[ ➤ Page 82]

You can delete a specific scene of a title.

### **Editing Title Names**

[ ➤ Page 84]

You can name titles or change the title name.

### **Protecting / Undo Protecting Titles (VR mode DVD-RW discs, Video mode DVD-RW / R and HDD only)**

[ ➤ Page 85]

You can prevent accidental editing or title erasing.

### **Combining Titles (VR mode DVD-RW discs and HDD only)**

[ ➤ Page 86]

You can combine two titles into a single title.

### **Dividing Titles (VR mode DVD-RW discs and HDD only)**

[ ➤ Page 87]

You can divide a title into two new titles.

- It is possible to edit +VR mode recorded / edited on other unit, in case you can undo the finalisation of the disc on this unit.

## Compatibility

**DVD**

### **Playing back discs recorded in Video mode on any regular DVD player**

[ ➤ Pages 57-58]

Discs recorded in Video mode can be played back on regular DVD players, including computer DVD drives compatible with DVD-Video playback. You will need to finalise the discs recorded in Video mode to play back in other DVD players.

Although DVD+RW / R discs are playable on other units without finalisation in most cases, it is recommended to finalise in order to stabilise the performance.

- DVD-Video Format (Video mode) is a new format for recording on DVD-RW / R discs that was approved by the DVD Forum in 2000. Adoption of this format is optional for manufactures of DVD playback devices and there are DVD-Video players, DVD-ROM drives and other DVD playback devices available that cannot play back DVD-RW / R discs recorded in the DVD-Video Format.







## Choosing a Disc

When you want to play back DVD or CD software or copy programmes from the HDD to a recordable DVD, load an appropriate disc into the unit. There are many types and formats of discs. Please use the following information to select an appropriate disc.

### Note

- Handle the disc according to the disc instruction manual.
- Toshiba cannot guarantee that all discs bearing the DVD or CD logos will operate as expected. Additionally, Toshiba cannot guarantee those discs recorded in this unit will operate properly in other DVD players, recorders and/or personal computer drives.

## For Recording / Playback











Disc	Mark	Specification	Remarks
DVD-R		• 4.7 GB for General Ver. 2.0 (8 cm (3 1/4 in.)) (12 cm (4 3/4 in.))	Read carefully the section "On DVD-R Discs" (Page 11). Depending on the disc status or the recording equipment, playback of the disc may not be possible on this unit.
DVD-RW		• 4.7 GB for Ver. 1.1 and 1.2 (8 cm (3 1/4 in.)) (12 cm (4 3/4 in.))	Read carefully the section "On DVD-RW Discs" (Page 11). Depending on the disc status or the recording equipment, playback of the disc may not be possible on this unit.
DVD+R		• 4.7 GB (8 cm (3 1/4 in.)) (12 cm (4 3/4 in.))	Read carefully the section "On DVD+R / DVD+RW discs" (Page 11). Depending on the disc status on the recording equipment, playback of the disc may not be possible on this unit.
DVD+RW		• 4.7 GB (8 cm (3 1/4 in.)) (12 cm (4 3/4 in.))	

## Using different disc types for different purposes

DVD-RW / R and DVD+RW / R discs when creating your own original discs for distribution  
DVD-R discs are designed to comply with the global standard DVD-Video format, and can be recorded only once. DVD-R / +R discs are convenient when you edit your original content (recorded personal events such as a wedding party) with this unit, transfer them to the unit and make copies to send to your friends or relatives. The discs can be played back on other compatible DVD players. DVD-RW / +RW discs, which are rewritable, can be used as well.

We cannot guarantee that DVD-RW / R and DVD+RW / R discs recorded on this unit will be playable on all DVD recorders/players. Similarly, there is no guarantee that all DVD-RW / R and DVD+RW / R discs recorded on other recorders will be playable on this unit.

## For Playback Only

Disc	Mark	Specification	Remarks
DVD video		<ul style="list-style-type: none"> <li>• 8 cm (3 1/4 in.)</li> <li>• 12 cm (4 3/4 in.)</li> <li>• Region number</li> </ul>  or 	The region number of this unit is 2. The region number marked on the rear panel must correspond to a specific playable area, that is printed on your DVD video disc. If you do not find Region 2 or ALL regions, or the disc is encoded to permit playback only in regions other than Region 2, disc playback will not be allowed by the unit.
Audio CD (CD-DA)		<ul style="list-style-type: none"> <li>• 8 cm (3 1/4 in.)</li> <li>• 12 cm (4 3/4 in.)</li> </ul>	
CD-R	 	<ul style="list-style-type: none"> <li>• 12 cm (4 3/4 in.)</li> <li>• CD-DA (audio CD) format, MP3, JPEG, DivX<sup>®</sup> files</li> </ul>	Depending on the disc status, playback may not be possible.
CD-RW	 		
Video CD (VCD)	 	<ul style="list-style-type: none"> <li>• 12 cm (4 3/4 in.)</li> <li>• Version 1.1 and 2.0</li> </ul>	

**DVD** is a trademark of DVD Format/Logo Licensing Corporation.

- You cannot play discs other than those listed above.
- You cannot play non-standardised discs even if they may be labelled as above.
- You cannot play discs with specialised encoding (such as Super Audio CD discs) or the DVD audio portions of DVD Audio discs.
- Toshiba cannot guarantee that all discs bearing the DVD or CD logos will operate as expected.

**RW COMPATIBLE** This label indicates playback compatibility with DVD-RW discs recorded in VR mode (Video Recording Format).

### Note

- This unit cannot play the DVD-R discs recorded in VR mode (Video Recording Format).

- Toshiba is not liable for any damage or loss caused directly or indirectly by the malfunction of this unit, including, without limitation, any one of the following:
  - Failure to record contents intended to be recorded by the consumer.
  - Failure to edit contents as intended by the consumer.
  - When a DVD-RW / R disc and DVD+RW / R disc created on this unit is used (e.g., insertion, playback, recording or editing) in another DVD player, recorder or personal computer drive.
  - When a DVD-RW / R disc and DVD+RW / R disc that is used in the manner described in the immediately preceding bullet point is used again in this unit.
  - When a DVD-RW / R disc and DVD+RW / R disc that was recorded in another DVD recorder, or in a personal computer drive is used in this unit.
- Some functions may not work with personal computer discs.
- Discs recorded in this unit may not operate as expected on other DVD players, recorders or personal computer drives.

Because of problems and errors that can occur during the creation of DVD and CD software and/or the manufacture of DVD and CD discs, Toshiba cannot guarantee that the unit will play every feature of every DVD bearing the DVD logo and/or every CD bearing the CD logo. As one of the creators of DVD technology, Toshiba DVD players are manufactured using the highest standards of quality, and as a result, such incompatibilities are rare.

## On DVD-R Discs

### Standards

- DVD-R for General Ver. 2.0 discs can be used for recording and playback.
- Discs compatible with the following recording mode speed can also be used:  
Ver. 2.0/2x  
Ver. 2.0/4x  
Ver. 2.0/8x  
Ver. 2.0/16x
- Select discs labelled "for video", "for recording", "120 min." etc.

### Recording conditions

- Images for which copying is prohibited or restricted (copy once or copy prohibited) cannot be recorded.
- We strongly recommend using any DVD-R 2x or 8x to assure good recording quality.

### Discs that have been tested and are proven to be compatible with this unit:

VERBATIM DVD-R 8x  
MAXELL DVD-R

## On DVD-RW Discs

### Standards

- Discs labelled DVD-RW Ver. 1.1 or 1.2 can be used.
- Discs compatible with the following recording mode speeds can also be used:  
Ver. 1.1/2x  
Ver. 1.2/4x
- Select discs labelled "for video", "for recording", "120 min." etc.

### Recording conditions

- Images for which copying is prohibited (copy prohibited) cannot be recorded. If the disc is labelled as CPRM compatible, images for which copying is restricted (copy once) can be recorded in VR mode.
- We strongly recommend using any DVD-RW 4x disc to assure good recording quality.

### Discs that have been tested and are proven to be compatible with this unit:







TDK DVD-RW 2x  
JVC DVD-RW 4x

## On DVD+R / DVD+RW Discs

- DVD+R 1x-16x and DVD+RW 1x-4x discs can be used in this unit.
- We strongly recommend for good recording quality: TDK DVD+R 4x/8x/16x, SONY DVD+R 4x/8x/16x, MAXELL DVD+R 4x/8x/16x, SONY DVD+RW 4x
- Discs that have been tested and are proven to be compatible with this unit:  
VERBATIM DVD+R 8x VERBATIM DVD+RW 4x
- Although DVD+RW / R discs are playable on other units without finalisation in most cases, it is recommended to finalise in order to stabilise the performance.

## Marks on DVD Video Discs

The following are examples of marks and the meanings.

Mark	Meanings
	Number of audio streams recorded in the disc. (2 streams such as English and Japanese in this example.)
	Number of subtitle languages recorded in the disc. (2 subtitle languages are recorded in this example.)
	Number of camera angles recorded in the disc. (3 camera angles are recorded in this example.)
	Pictures are recorded in the standard picture shape (4:3 aspect ratio).
	Pictures are recorded in the letter box picture shape (4:3 aspect ratio with horizontal black bars in the top and bottom of pictures).
	Pictures are recorded in the 16:9 wide picture shape. TVs with 4:3 aspect ratio will display them in the letter box style.
	Pictures are recorded in the 16:9 wide picture shape. TVs with 4:3 aspect ratio will display them in the pan scan style (one or both sides of pictures are cut).
	Actual picture shape may vary depending on the aspect ratio or mode selection of the TV.

## Structure of Disc Contents

Normally, DVD video discs are divided into titles, and the titles are subdivided into chapters.

Video CDs / Audio CDs are divided into tracks.

Data disc contains MP3/JPEG/DivX<sup>®</sup> are divided into groups, and the groups are subdivided into tracks.

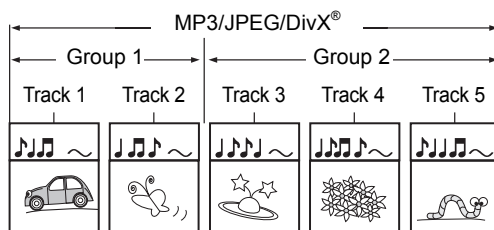
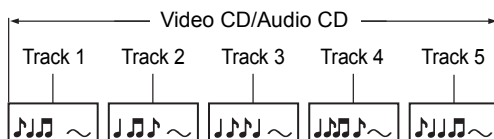
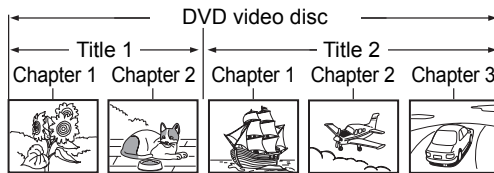

- Title:** Divided contents of a DVD video disc. Roughly corresponds to a story title in short stories.
- Chapter:** Divided contents of a title. This corresponds to a chapter in a story.
- Track:** Divided contents of a Video CD, an Audio CD or data disc contains MP3, JPEG or DivX<sup>®</sup>.
- Group:** Divided contents of a MP3, JPEG or DivX<sup>®</sup> data disc. Consists of number of tracks.

Each title, chapter, group or track is assigned a number, which is called "title number", "chapter number", "group number" or "track number" respectively.

Some discs may not have these numbers.

When you record on the HDD, one recording will always equal one title. You can divide a title into several chapters by marking borders in it to facilitate scene search.

## On Handling Discs

- Do not touch the playback side of the disc.

**Yes**

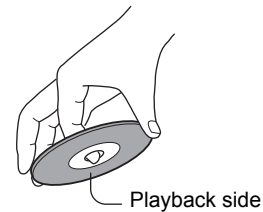

- Do not stick paper or tape to discs.

**No**



## On Cleaning Discs

- Fingerprints and dust on the disc cause picture and sound deterioration. Wipe the disc from the centre outwards with a soft cloth. Always keep the disc clean.

**Yes**



**No**



- Do not use any type of solvent such as thinners, benzene, commercially available cleaners or antistatic spray for vinyl LPs. It may damage the disc.

## On Storing Discs

- Do not store discs in a place subject to direct sunlight or near heat sources.
- Do not store discs in places subject to moisture and dust such as a bathroom or near a humidifier.
- Store discs vertically in a case. Stacking or placing objects on discs outside of their case may cause warping.

## Discs and Purposes

The table shows main functions which are available on this unit per disc category. This will help you choose discs.

	DVD-RW disc Video mode	DVD-RW disc VR mode	DVD-R disc Video mode
Characteristics on this unit	Suitable for saving data in Video mode format to play on compatible devices.  You can erase recorded contents to use the disc repeatedly.	Suitable for saving data in VR mode format to play on compatible devices.  You can erase recorded contents to use the disc repeatedly.	Suitable for saving data in Video mode format to play on compatible devices.  Once you execute Video mode finalising process on a recorded disc so that it can be played on other players. You cannot make additions, corrections and deletions of contents on the disc.
For the first use	Initialise the disc.	Initialise the disc.	No preparatory steps required.
Recording a TV programme	Yes	Yes	Yes
Erasing recorded contents	Yes  Undo the finalisation of the disc first to delete the contents.	Yes  Undo the finalisation of the disc first to delete the contents.	Yes  Deleting contents cannot restore the disc space. <u>After you execute Video mode finalising process on a recorded disc, you cannot delete contents of the disc.</u>
Indexing recorded contents	Yes	Yes	Yes
Naming a title	Yes	Yes	Yes
Collecting favourite scenes (Playlist Editing)	No	Yes	No
Making a new title from a Playlist containing favourite scenes (Copy within the same disc)	No	Yes	No
Playing contents recorded on this unit, on other devices	Execute Video mode finalising process on this unit. This process makes the disc playable on other compatible devices. (Some models excepted.)	Execute VR mode finalising process on this unit. This process makes the disc playable on other compatible devices. (Some models excepted.)	Execute Video mode finalising process on this unit. This process makes the disc playable on other compatible devices. (Some models excepted.)
When a message appears and the loaded disc cannot be used:	Initialise the disc.	Initialise the disc.	-

Introduction

Connections

Basic Setup

Recording

Playback

Editing

Function Setup

VCR Functions















Others

	DVD+RW disc +VR mode	DVD+R disc +VR mode
Characteristics on this unit	Suitable for saving data in +VR mode format to play on compatible devices.  You can erase recorded contents to use the disc repeatedly.	Suitable for saving data in +VR mode format to play on compatible devices.  Once you execute +VR mode finalising process on a recorded disc so that it can be played on other players. You cannot make additions, corrections and deletions of contents on the disc.
For the first use	Initialise the disc.	No preparatory steps required.
Recording a TV programme	Yes	Yes
Erasing recorded contents	Yes  Undo the finalisation of the disc first to delete the contents.	Yes  Deleting contents cannot restore the disc space. After you execute +VR mode finalising process on a recorded disc, you cannot delete contents of the disc.
Indexing recorded contents	Yes	Yes
Naming a title	Yes	Yes
Collecting favourite scenes (Playlist Editing)	No	No
Making a new title from a Playlist containing favourite scenes (Copy within the same disc)	No	No
Playing contents recorded on this unit, on the other unit	Although DVD+RW discs are playable on other units without finalisation in most cases, it is recommended to finalise in order to stabilise the performance.	Although DVD+R discs are playable on other units without finalisation in most cases, it is recommended to finalise in order to stabilise the performance.
When a message appears and the loaded disc cannot be used:	Initialise the disc.	-

## Guide to the Owner's Manual

### Symbols Used in the Owner's Manual

To show what recording mode or disc type applies to each function, the following symbols appear at the beginning of each operating item.

Symbol	Description
	Available to (internal) HDD
	Available to DVD-Videos
	Available to DVD-RW discs in Video mode
	Available to DVD-RW discs in VR mode
	Available to DVD-R discs in Video mode
	Available to DVD+RW discs in +VR mode
	Available to DVD+R discs in +VR mode
	Available to Audio CDs
	Available to Video CDs
	Available to CD-RW / R discs with MP3 files
	Available to CD-RW / R discs with JPEG files
	Available to DVD-RW / R, DVD+RW / R and CD-RW / R discs with DivX <sup>®</sup> files
	Available to VHS tapes Use only cassettes marked VHS (  ).

Introduction

Connections

Basic Setup

Recording

Playback

Editing

Function Setup

VCR Functions

Others

## Functional Overview

### Front Panel

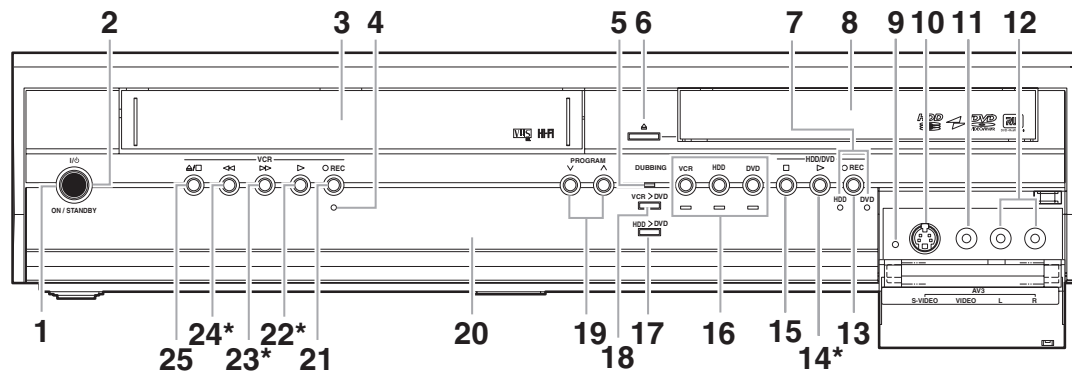

- 1 **I/⏻ ON / STANDBY button**: Press to turn the unit on / off.
  - 2 **I/⏻ ON / STANDBY indicator**: Lights up when the power is on.
  - 3 **Cassette compartment**: Insert a tape here.
  - 4 **REC indicator (VCR)**: Lights up during VCR recording.
  - 5 **DUBBING indicator**: Lights up during dubbing.
  - 6 **OPEN / CLOSE ▲ button (DVD)**: Press to open / close the disc tray.
  - 7 **REC indicators (HDD/DVD)**: Lights up during HDD/DVD recording.
  - 8 **Disc tray**: Place a disc here.
  - 9 **RESET**: Press with a sharp pointed object to restart the unit. Also refer to the "Note" right below.
  - 10 **S-VIDEO input jack (AV3) (HDD/DVD/VCR)**: Connect the S-Video output of an external device here using a commercially available S-Video cable.
  - 11 **VIDEO input jack (AV3) (HDD/DVD/VCR)**: Connect the video output of an external device here using a commercially available Video cable.
  - 12 **AUDIO input jacks (AV3) (HDD/DVD/VCR)**: Connect the audio output of an external device here using a commercially available Audio (L / R) cable.
  - 13 **● REC button (HDD/DVD)**: Press once to start a basic recording. Press repeatedly to start an OTR (One-touch Timer Recording). Each press increases the recording time by 15 minutes up to 4 hours.
  - 14 **PLAY ► button\* (HDD/DVD)**: Press to start or resume playback.
  - 15 **STOP ■ button (HDD/DVD)**: Press to stop playback, recording or dubbing.
  - 16 **Device Select Buttons / Indicators**:
    - VCR**: Press to activate the VCR. Lights up when VCR is selected.
    - HDD**: Press to activate the HDD. Lights up when HDD is selected.
    - DVD**: Press to activate the DVD. Lights up when DVD is selected.
  - 17 **DUBBING HDD > DVD button**: Press to start One Touch Dubbing from HDD to DVD.
  - 18 **DUBBING VCR > DVD button**: Press to start One Touch Dubbing from VCR to DVD.
  - 19 **PROGRAM ∇ / ▲ buttons: (HDD/DVD)**: Press to change the channel up or down.
    - (VCR)**: Press to change the channel up or down. Press to adjust the tracking during playback or in slow motion of the tape. While playback is in still mode, you can adjust the vertically blurred picture.
  - 20 **Front Panel Display**: Shows information and messages. Refer to "Front Panel Display Guide" on page 22.
  - 21 **● REC button (VCR)**: Press once to start a basic recording. Press repeatedly to start an OTR (One-touch Timer Recording). Each press increases the recording time by 15 minutes up to 4 hours.
  - 22 **PLAY ► button\* (VCR)**: Press to start playback. Press to turn on the unit to start playback.
  - 23 **FWD ►► button\* (VCR)**: Press to fast forward or fast search. Press to turn on the unit to fast forward.
  - 24 **REW ◀◀ button\* (VCR)**: Press to rewind or rewind search. Press to turn on the unit to rewind.
  - 25 **STOP / EJECT ▲/■ button (VCR)**: Press to eject the videotape. Press to stop recording or playback.
- (\*) You can also turn on the unit by pressing these buttons.

#### Note

- After pressing [RESET],
- The settings for the items listed below will be lost;
    - Clock Setting
    - Timer Programme
    - Resume point
  - The settings for the item listed below will not be lost, but need to be set again;
    - Channel Setting
  - All other settings will remain as memorised.

#### Button names described in the Owner's Manual

The instructions in this manual are described mainly with the operations using the remote control. Some operations can be carried out using the buttons on the front panel.



## Rear Panel

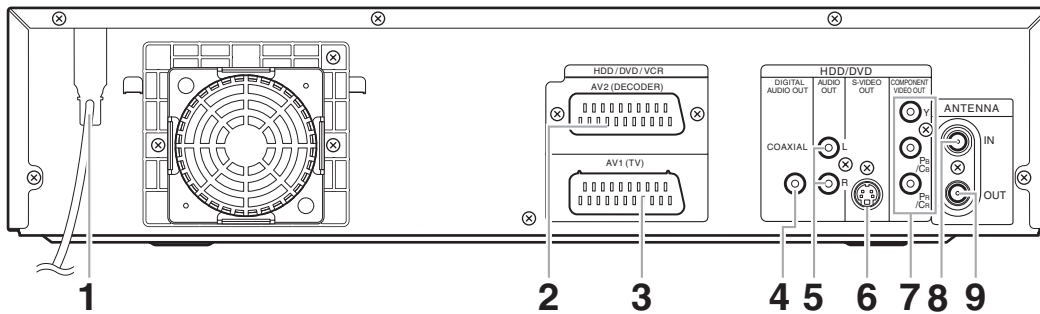

- 1 Mains cable:**  
Connect to a standard AC outlet.
- 2 AV2(DECODER) (HDD/DVD/VCR):**  
Connect to VCR, camcorder, or other Audio-Video equipment. Use a commercially available Scart cable.
- 3 AV1(TV) (HDD/DVD/VCR):**  
Connect to the Scart socket on your TV. Use a commercially available Scart cable.
- 4 DIGITAL AUDIO OUT (COAXIAL) jack (HDD/DVD):**  
Connect to an amplifier with a digital input jack such as a Dolby Digital decoder, DTS decoder or MPEG decoder. Use a commercially available Coaxial cable.
- 5 AUDIO OUT jacks (HDD/DVD):**  
Connect to the audio input jacks on your TV. Use a commercially available Audio cable.
- 6 S-VIDEO OUT jack (HDD/DVD):**  
Connect to the S-Video input jack on your TV. Use a commercially available S-Video cable.
- 7 COMPONENT VIDEO OUT jacks (HDD/DVD):**  
Connect to an optional component video cable through the component video input jacks of a TV.
- 8 ANTENNA IN (HDD/DVD/VCR):**  
Connect to an antenna cable.
- 9 ANTENNA OUT (HDD/DVD/VCR):**  
Connect to the Aerial jack on your TV, cable box or direct broadcast system. Use the supplied RF cable.

### Note

- Do not touch the inner pins of the jacks on the rear panel. Electrostatic discharge may cause permanent damage to the unit.
- **This unit does not have an RF modulator.**

Introduction

Connections

Basic Setup

Recording

Playback

Editing

Function Setup

VCR Functions

Others

## Remote Control

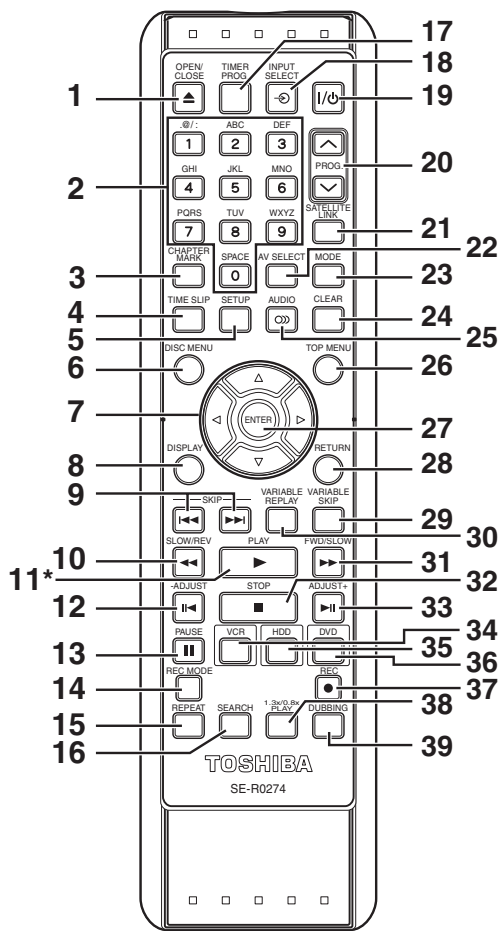

(\*) You can also turn on the unit by pressing this button.

- 1 OPEN / CLOSE ▲ button (DVD/VCR):**  
(DVD) Press to open / close the disc tray.  
(VCR) Press to eject the videotape.
- 2 Number buttons:**  
Press to select channel numbers.  
Press to select a title / chapter / track on the display.  
Press to enter setting values.  
Press to enter the index / desired time to search in VCR mode.
- 3 CHAPTER MARK button (HDD/DVD):**  
Press to add chapter marks on each title  
(HDD, VR mode DVD-RW and +VR mode DVD+RW / R).
- 4 TIME SLIP button (HDD):**  
Press once to start recording the TV programme you are watching. Press again to watch the content being recorded from the beginning while recording continues.

- 5 SETUP button:**  
Press once to display the Setup Menu.  
Press to exit from the present menu.
- 6 DISC MENU button:**  
Displays the Disc Menu.
- 7 Cursor ▲ / ▼ / ◀ / ▶ buttons:**  
Press to move the cursor and determine items or settings.
- 8 DISPLAY button:**  
Displays the on-screen menu.
- 9 SKIP ◀◀ / ▶▶ buttons (HDD/DVD):**  
During playback, press to skip to the previous / next chapter or track.
- 10 SLOW / REV ◀◀ button:**  
(HDD/DVD) During playback, press to play back in fast reverse. Or when playback is paused, press to play back in slow reverse. During slow reverse playback, press to change the speed.  
(VCR) Press to rewind the videotape in stop mode or to view the picture rapidly in reverse during the playback mode.
- 11 PLAY ▶ button\*:**  
Press to start or resume playback.  
If the resume point has been set, the playback will start from the resume point.
- 12 -ADJUST ◀◀ button (HDD/DVD):**  
During playback, press to play backward by one frame at a time.
- 13 PAUSE ◻◻ button:**  
Press to pause playback or recording.
- 14 REC MODE button:**  
Press to select the Rec Mode.
- 15 REPEAT button (HDD/DVD):**  
Press to play back the chapter, title, group, disc and track repeatedly.
- 16 SEARCH button:**  
(HDD/DVD) Press to call up the chapter / track, title or time search menu.  
(VCR) Press to call up the index or time search menu.
- 17 TIMER PROG. button (HDD/DVD):**  
Press to display the Timer Programme List.
- 18 INPUT SELECT ◻ button:**  
Press to select an external input mode ("AV1", "AV2" or "AV3").
- 19 I/O ON / STANDBY button:**  
Press to turn the unit on / off.
- 20 PROG. ▲ / ▼ buttons:**  
(HDD/DVD) Press to change the channel up or down.  
(VCR) Press to change the channel up or down. Press to adjust the tracking during playback or in slow motion of the tape. While playback is in still mode, you can adjust the vertically blurred picture.
- 21 SATELLITE LINK button:**  
Press to activate the Satellite Link Timer Recording.
- 22 AV SELECT button (HDD/DVD):**  
Press to display AV Select Menu.

**23 MODE button:**

**(HDD/DVD)** Press to change the Original and Playlist on the HDD/DVD title menu.  
When User 1 - User 3 in Picture Quality Menu are selected, press to display User Setup Menu.  
**(VCR)** Press to change the video colour system.

**24 CLEAR button:**

**(HDD/DVD)** Press to clear the information once entered, etc.  
Press to delete chapter marks.  
**(DVD)** Press to erase the track number entered in the programme play screen for Video / Audio CDs.  
**(VCR)** Press to reset the tape counter.

**25 AUDIO  button:**

During playback, press to change the audio settings.

**26 TOP MENU button (HDD/DVD):**

Displays the Title List.

**27 ENTER button:**

Press to confirm or select menu items.

**28 RETURN button:**

Press to return to the previously displayed Menu Screen.

**29 VARIABLE SKIP button (HDD/DVD):**

Skips by the amount of time set in advance.

**30 VARIABLE REPLAY button (HDD/DVD):**

Replays by the amount of time set in advance.

**31 FWD / SLOW  button:**

**(HDD/DVD)** During playback, press to play back in fast forward. Or when playback is paused, press to play back in slow forward.

**(VCR)** During playback, press to play back in fast forward.

In still mode, press to view the videotape in slow motion.

During playback in slow motion, press to increase the speed in slow motion.

Press to fast forward the videotape in stop mode.

**32 STOP  button:**

Press to stop playback or recording.

**33 ADJUST+  button (HDD/DVD):**

During playback, press to advance one frame at a time.

**34 VCR button:**

Press to activate the VCR. (See page 20.)

**35 HDD button:**

Press to activate the HDD. (See page 20.)

**36 DVD button:**

Press to activate the DVD. (See page 20.)

**37 REC  button:**

Press once to start a basic HDD/DVD/VCR recording. Press repeatedly to start a One-touch Timer Recording in HDD/DVD/VCR mode.

**38 1.3x/0.8x PLAY button (HDD/DVD):**

During playback, press to play back in a slightly faster/slower speed while keeping the audio quality.

**39 DUBBING button:**

Press to start dubbing during HDD/DVD playback. Press to display the Dubbing Menu during HDD/DVD stop mode and VCR mode.

**Note**

- If you turn off this unit, [OPEN / CLOSE ] on the remote control is not available. Be sure to use [OPEN / CLOSE ] or [STOP / EJECT ] on the unit.

**Button names described in the Owner's Manual**

The instructions in this manual are described mainly with the operations using the remote control. Some operations can be carried out using the buttons on the front panel.

Introduction

Connections

Basic Setup

Recording

Playback

Editing

Function Setup

VCR Functions

Others

## Installing Batteries in the Remote Control

Install two R6 (AA) batteries (supplied) into the remote control, carefully match with the polarity indicated inside the battery compartment.

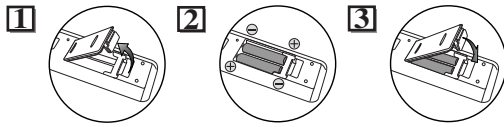

### Caution

- Incorrect use of batteries can result in hazards such as leakage and bursting.
- Do not mix new and old batteries together.
- Do not use different kinds of batteries together.
- Make sure that the + and - ends of each battery match the indications inside the battery compartment.
- Remove batteries if the equipment will not be used for a month or more.
- When disposing used batteries, please comply with governmental regulations or the public instructions for environmental protection that apply in your country or area.
- Do not recharge, short-circuit, heat, burn or disassemble batteries.

## About the Remote Control

- Make sure there is no obstacle between the remote control and the remote control sensor on the unit.
- Use within the operating range and angle as shown.

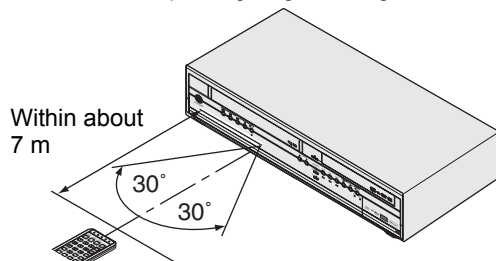

Remote control

- The maximum operable range as follows:
  - Line of sight:** approximately 7 m
  - Either side of centre:** approximately 7 m within 30 degrees
- Remote control operation may become unreliable if the remote control sensor of the unit is being exposed by the strong sunlight or fluorescent light.
- Remote controls for different devices can interfere with each other. Be careful when using remote controls for other equipment located close to the unit.
- Replace the batteries when the operating range of the remote control reduces.

## HDD / DVD / VCR Modes Switching

Because this unit is a combination of a VCR, a HDD and a DVD recorder, you must select first which component you wish to operate.

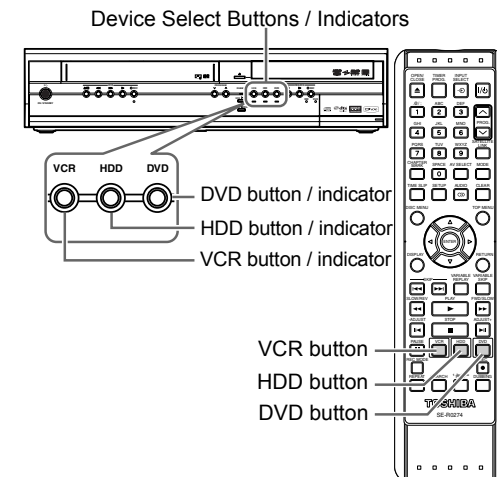

### HDD mode

Press **[HDD]** on the remote control.  
(Verify that the HDD indicator is lit.)

### DVD mode

Press **[DVD]** on the remote control.  
(Verify that the DVD indicator is lit.)

### VCR mode

Press **[VCR]** on the remote control.  
(Verify that the VCR indicator is lit.)

### Note

- If you press **[REC ●]** of each device, recording starts in its device mode.

## Guide to Display Information

The Display Menu gives you all information of the HDD or DVD.

### Display Example:

Press **[DISPLAY]** once to show all information.  
Press **[DISPLAY]** four times to exit the display.

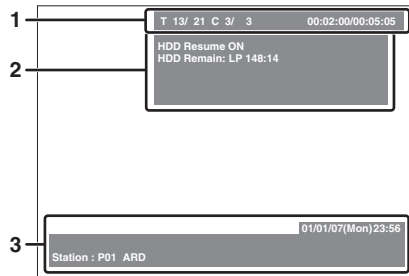

Press **[DISPLAY]** once.

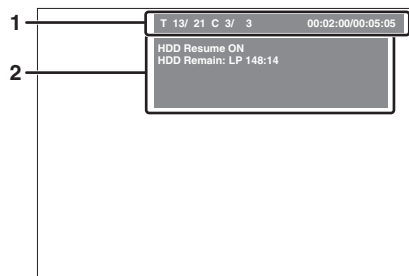

Press **[DISPLAY]** twice.



Press **[DISPLAY]** thrice.

Each section includes the information as listed below:

- 1
  - Current title number / total number of the titles
  - Current chapter number / total number of the chapters
  - Elapsed playback time of the current title / total time of the title
- 2
  - Playback status and Rec Mode
  - Current title status
  - Remained disc space
  - Current device
- 3
  - Date and clock
  - Programme name
  - Station name

### Note

- This is an example screen only for explanation. Displayed items varies depending on the actual mode.

## Guide to Setup Menu

This unit uses the following on-screen menu for most operations.

### How to use Setup Menus:

Press **[SETUP]** to display "Setup Menu". Choose either menu using **[Cursor ▲ / ▼]**, then press **[ENTER]**. These menus provide entries to all main functions of the unit.

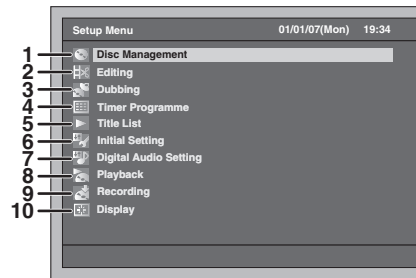

- 1 **Disc Management:**  
To set up the disc to manage.
- 2 **Editing:**  
To edit a recorded disc or HDD.
- 3 **Dubbing:**  
To dub a content among HDD, DVD and VCR.
- 4 **Timer Programme:**  
To programme a Timer Recording.
- 5 **Title List:**  
To select the title list.
- 6 **Initial Setting:**  
To make the settings of the basic items.
- 7 **Digital Audio Setting:**  
To select the digital audio setting.
- 8 **Playback:**  
To set up the unit to play discs / HDD as you prefer.
- 9 **Recording:**  
To set up the unit to record on discs / HDD as you prefer.
- 10 **Display:**  
To set up the OSD screen and the front display of the unit as you prefer.

Available menus vary among discs.

Introduction

Connections

Basic Setup

Recording

Playback

Editing

Function Setup

VCR Functions

Others

## Front Panel Display Guide

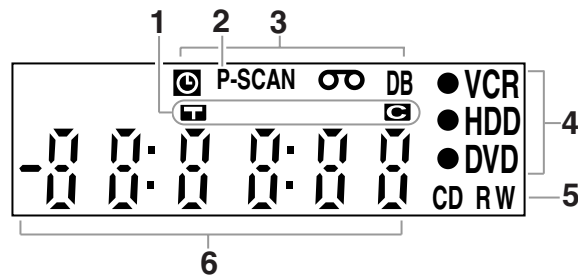

### 1 Title / Track and Chapter mark

- T** : Appears when indicating a title / track number.
- G** : Appears when indicating a chapter number.

### 2 P-SCAN

Appears when the progressive scan is activated.

### 3 Current status of the unit

- Timer Recording icon** : Appears when Timer Recording is in Standby, or is proceeding. Disappears when all the Timer Recordings are finished. (Does not appear while in the Satellite Link standby mode or the Satellite Link Recording is in progress.)
- Videotape icon** : Appears when a videotape is in the unit.
- DB** : Lights up during a dubbing process.

- 4 ● **VCR** : Lights up during VCR recording.
- **HDD** : Lights up during HDD recording.
- **DVD** : Lights up during DVD recording.

### 5 Disc type and current status of the unit

- CD** : Appears when an Audio CD or a disc with MP3 / JPEG / DivX® files is on the disc tray.
- R** : Appears when a DVD-R disc or a DVD+R disc is loaded on the disc tray.
- RW** : Appears when a DVD-RW disc or a DVD+RW disc is loaded on the disc tray.

### 6 Displays the following

- Played-back time
- Current title / chapter / track number
- Recording time
- Clock
- Channel number
- VCR tape counter
- Remaining time for a One-touch Timer Recording

## Display Messages



Appears when the unit is turning on.



Appears when the unit is turning off.



Appears when the disc tray is opening.



Appears when a disc is loaded on the disc tray.



Appears when the disc tray is closing.



Appears when the DVD-Video is playing its menu.



Appears when recording is stopped.



Appears when the Auto Tuning is functioning.

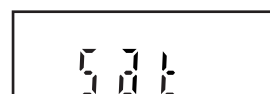

Appears when the Satellite Link Recording is in standby.

# Connections

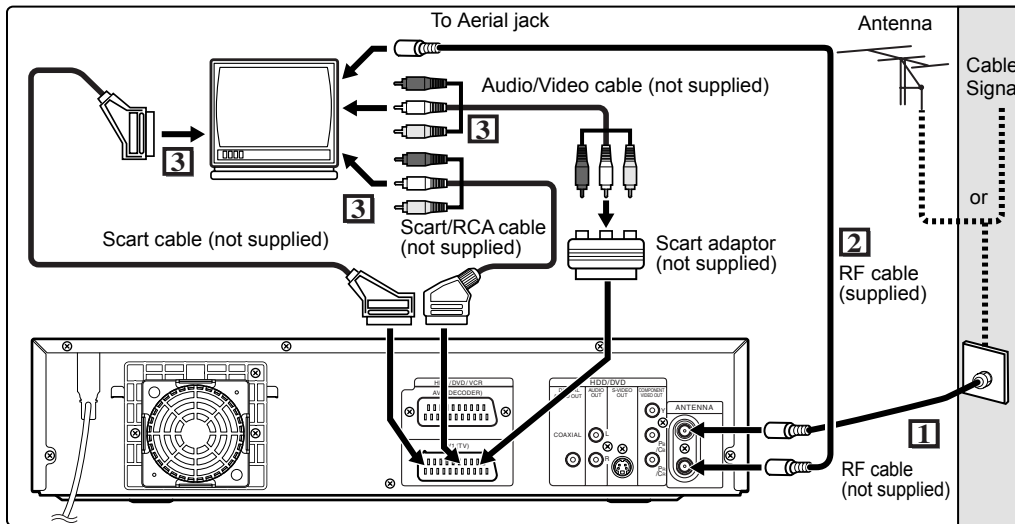

## Connections

### Connecting to a TV

Connect the unit to a TV after considering the capabilities of your existing equipment.

**Before installation, unplug your TV and this unit. Using the Scart socket**

- 1** Connect the antenna or cable to the **ANTENNA IN** jack of this unit.
- 2** Connect the **ANTENNA OUT** jack of this unit to the **Aerial** jack of your TV. Use the supplied RF cable.
- 3** Connect **AV1(TV) Scart** socket of this unit to the **Scart** socket of your TV. Use a commercially available Scart cable.

#### Note

- If your TV does not have a Scart socket, use a commercially available Scart adaptor or Scart / RCA cable to connect.
- Connect this unit directly to the TV. If the AV cables are connected to a VCR, pictures may be distorted due to the copy protection system.
- When changing the "Video Out" setting ("SCART(RGB)", "Component (Progressive)" or "Component (Interlace)"), connect to a Video jack or an S-Video jack on the TV. If the setting is changed, for example, to "Component (Progressive)" or "Component (Interlace)" while the scart cable is connected to the TV, a distorted video signal may be output.

### Selecting Progressive Scan (625p <525p> or Interlaced 625i <525i>) Playback

- If your TV is compatible with progressive scanning (625p <525p>), connect the TV to the **COMPONENT VIDEO OUT** jacks of the unit and set "Video Out" setting to "Component (Progressive)" in the setup menu (see page 92). Next, set your TV to the progressive scan mode.
- If your TV is not compatible with progressive scan, set "Video Out" setting to "Component (Interlace)".
- Use a commercially available adaptor if the Video input jacks of your TVs or monitors are the BNC type.

### Using the S-VIDEO OUT or the COMPONENT VIDEO OUT jacks and the AUDIO OUT jacks

If your TV has an S-Video or a Component Video input jack, use either an S-Video cable (to connect the S-VIDEO OUT jack) or a Component Video cable (to connect the COMPONENT VIDEO OUT jacks), and an Audio cable (to connect the AUDIO OUT jacks).

- S-Video connection provides the good quality picture.
- Component connection provides the better quality picture.

- 1** Follow steps 1 and 2 on the left.
- 2** Connect **S-VIDEO OUT** or **COMPONENT VIDEO OUT** jacks of this unit to the **S-Video** or **Component Video** input jacks of your TV. Use a commercially available **S-Video** cable or **Component Video** cable.

Introduction

Connections

Basic Setup

Recording

Playback

Editing

Function Setup

VCR Functions

Others

**3 Connect the AUDIO OUT jacks of this unit to the analogue Audio input jacks of your TV. Use a commercially available Audio cable.**

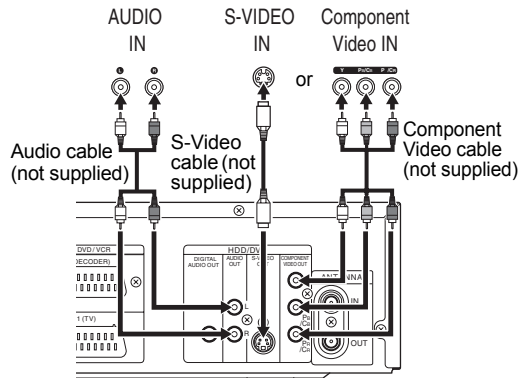

**Note for a TV with no S-Video input jack or Scart socket:**

- This unit has no RF modulator, so this type of TV cannot be used.
- Only component connection is compatible with the Progressive Scan.

**Connecting to External Equipment**

This unit has three input terminals, AV1(TV) or AV2(DECODER) on the rear panel and AV3 on the front panel. Be sure that all the units are off before making any connections.

**Recording from a HDD / DVD player, VCR, Satellite Box or other Audio-Video equipment with a Scart output socket (AV2)**

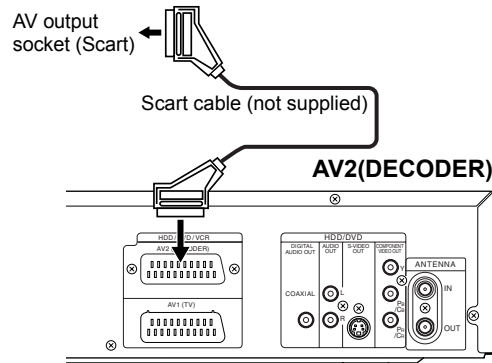

**Note**

- When you record a TV programme from a Satellite Box, you must connect a Scart cable to AV2(DECODER). (See page 47.)
- When AV2 is connected, the signal from the AV2 will be output automatically. If you want to monitor the signal from other input, you must press **[DISPLAY]** first. Then, select the desired input to monitor with **[INPUT SELECT]**.

**Recording from a camcorder or other Audio-Video equipment with no Scart output socket (AV3)**

If no S-Video input jack is available, connect to VIDEO input jack on the front panel using an RCA Video cable.

Set "S-Video In" when using S-VIDEO input jack. (See page 56.)

**AV3 (Front)**

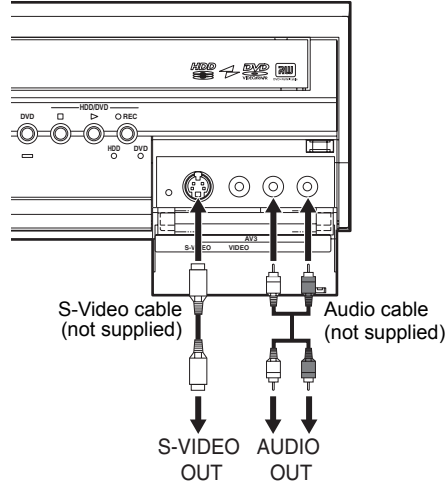

**Digital Audio for Better Sound Quality**

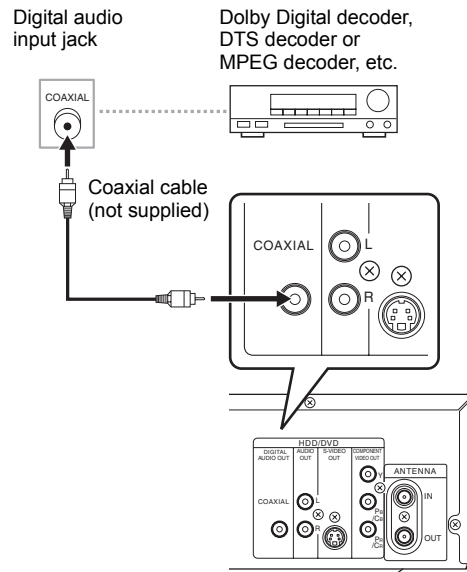

The connections illustrated above are optional for better sound.

**1 For clear digital sound quality, use the DIGITAL AUDIO OUT (COAXIAL) jack to connect your digital audio equipment.**

If the audio format of the digital output does not match the capabilities of your receiver, the receiver will produce a strong, distorted sound or no sound at all.



## Connecting a Dolby Digital™ decoder, DTS decoder or MPEG decoder

- Connecting Multi-channel Dolby Digital decoder allows you to enjoy the Multi-channel Dolby Digital surround system as well as DTS decoder, Multi-channel surround system.
- After connecting to a Dolby Digital decoder, set "Dolby Digital" to "Bit Stream" in "Digital Audio Setting". (See page 93.)
- After connecting to a DTS decoder, set "DTS" to "On" in "Digital Audio Setting". (See page 94.)
- After connecting to a MPEG decoder, set "MPEG" to "Bit Stream" in "Digital Audio Setting". (See page 93.)

## Connecting to an MD deck or DAT deck

- The audio source recorded in Dolby Digital Multi-channel surround format cannot be recorded using an MD or DAT deck as a digital sound.
- If not connected to a Dolby Digital decoder, set "Dolby Digital" to "PCM" in "Digital Audio Setting" (see page 93). Playing back a DVD using incorrect settings may generate noise distortion, and damage speakers.
- Set "Dolby Digital" and "MPEG" to "PCM" and set "DTS" to "Off" in "Digital Audio Setting" (see pages 93 and 94) for connecting to an MD or DAT deck.
- You can use AUDIO OUT jacks for the connection of your audio system.

## After You Have Completed Connections

Switch the input selector on your TV to an appropriate external input channel. For details, refer to the Owner's Manual of your TV.

### Note

- Connect this unit directly to the TV. If the AV cables are connected to a VCR, pictures may be distorted due to the effects of the copy protection system.

Introduction

Connections

Basic Setup

Recording

Playback

Editing

Function Setup

VCR Functions

Others

# Basic Setup

## For the First Time Use

Right after the purchase of the unit, do the Initialise Setting by doing the following procedures. This menu may not appear if you have already turned on the unit.

**1 After making all the necessary connections, turn on the TV. Select the appropriate external input channel.** (See pages 23 to 24.)

**2 Press [I/ON / STANDBY].**

After displaying the opening picture for 3 seconds, the OSD Language Menu will appear.

Refer to "OSD Language Setting" on page 27 to select a language for the on-screen displays and the menus, "Channel Setting" on page 27 to setup the channels, and "Setting the Clock" on page 30 to set the clock.

If you press [PLAY ►] at this point, "English" will be selected automatically and step 3 can be skipped.

**3 Select the desired setting using [Cursor ▲ / ▼], then press [ENTER].**



**4 Press [ENTER] to start Auto Channel Tuning.**

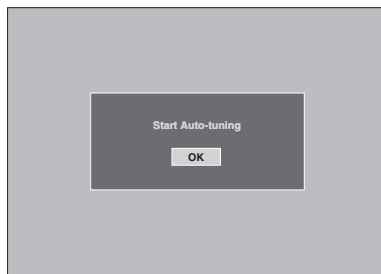

If you like to skip this step, press [RETURN].

**5 Use [Cursor ▲ / ▼ / ◀ / ▶] to set current time then press [ENTER].**

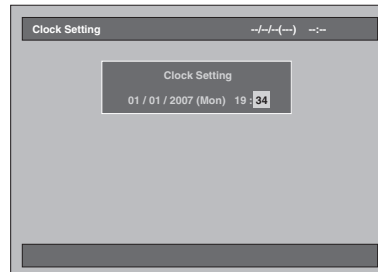

## OSD Language Setting

Follow the steps below to change the OSD Language.

- 1 Press **[SETUP]** in stop mode.  
Setup Menu will appear.
- 2 Select **“Initial Setting”** using **[Cursor ▲ / ▼]**, then press **[ENTER]**.

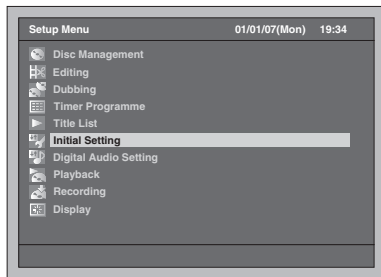

- 3 Select **“OSD Language”** using **[Cursor ▲ / ▼]**, then press **[ENTER]**.



- 4 Select the desired language using **[Cursor ▲ / ▼]**, then press **[ENTER]**.



The selected language will be checked and activated.

- 5 Press **[SETUP]** to exit.

## Channel Setting

### Auto Tuning

If you have already set the channels when you first turned on the unit, you can skip this section.

After resetting the settings or whenever you move to a new area, we recommend you to programme available channels in your area with the following procedures.

- 1 Press **[SETUP]** in stop mode.  
Setup Menu will appear.
- 2 Select **“Initial Setting”** using **[Cursor ▲ / ▼]**, then press **[ENTER]**.

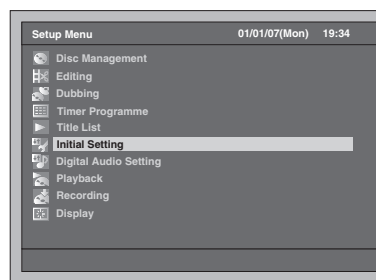

- 3 Select **“Channel Setting”** using **[Cursor ▲ / ▼]**, then press **[ENTER]**.

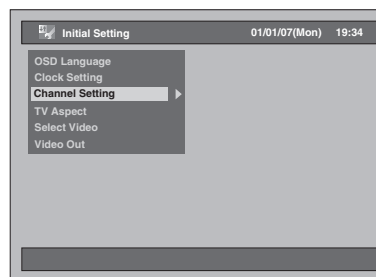

- 4 Select **“Auto Tuning”** using **[Cursor ▲ / ▼]**, then press **[ENTER]**.

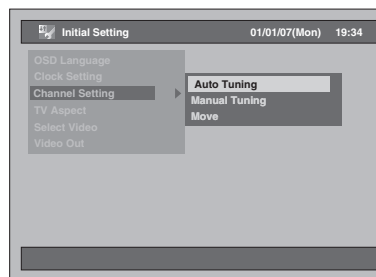

The unit will start storing channels available in your area.

Introduction

Connections

Basic Setup

Recording

Playback

Editing

Function Setup

VCR Functions

Others

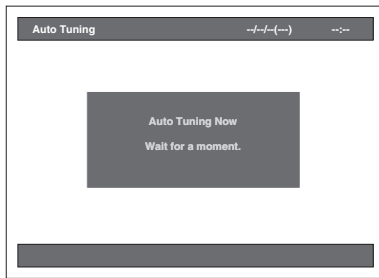

- Wait for several minutes to finish channel storing.

#### After Auto Tuning has stopped:

- Use **[PROG. ^ / v]** or **[the Number Buttons]** to change the channel.
- When you use **[the Number Buttons]**, press **[0]** first for a single digit number.
- Use **[INPUT SELECT ⊕]** or **[PROG. ^ / v]** to select an external input channel ("AV1", "AV2" or "AV3") of this unit.

#### To cancel auto tuning:

Press **[RETURN]** during scanning.

#### Note

- The selection will be affected by how you receive TV channels in your local area.
- If the auto tuning is cancelled during scanning, some channels not yet tuned may not be received.
- You cannot change the channel when either HDD, DVD or VCR is in any recording mode (normal recording, One-touch Timer Recording or Timer Recording).

## Manual Tuning

You can tune each channel and set their properties manually.

- 1 Press [SETUP] in stop mode.**  
Setup Menu will appear.
- 2 Select "Initial Setting" using [Cursor ▲ / ▼], then press [ENTER].**



- 3 Select "Channel Setting" using [Cursor ▲ / ▼], then press [ENTER].**

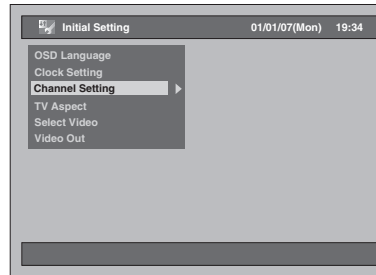

- 4 Select "Manual Tuning" using [Cursor ▲ / ▼], then press [ENTER].**

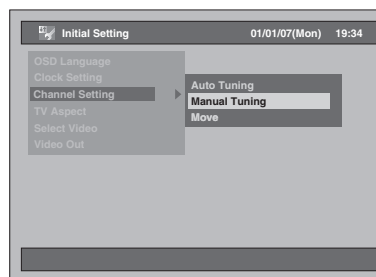

- 5 Select the position number of which you want to change the setting using [Cursor ▲ / ▼], then press [ENTER].**

Pos.	Channel	Decoder	Skip	Station
P01	21	On	Off	ARD
P02	45	Off	Off	---
P03	63	Off	Off	---
P04	80	Off	Off	---
P05	88	Off	Off	---
P06	95	Off	Off	---
P07	110	Off	Off	---
P08	2	Off	On	---

- You can select position numbers 01 to 99.
- You can jump to the next or the previous page using **[SKIP ►►]** or **[SKIP ◀◀]**.

- 6 Press [Cursor ▲ / ▼] to start searching for the available channel.**

- Search direction can be switched by pressing **[Cursor ▲ / ▼]**.
- If you already know the channel number, you can directly enter the channel number using **[the Number buttons]**. Refer to the following Channel Plan table and press the three digits to select the channel number.  
(To select channel 4, press **[0]** first and then press **[0]** and **[4]**. Or press **[4]**. And when "4" appears, wait for 2 seconds.)
- If this is the channel you want, press **[Cursor ►]**.

Channel Plan	
CH Indication	TV Channel
02 – 12	E2 – E12
21 – 69	E21 – E69
74 – 78	X, Y, Z, Z+1, Z+2
80 – 99,100	S1 – S20,GAP
121 – 141	S21 – S41
142 – 153	R1 – R12

This unit can receive the Hyper and Oscar frequency bands.

### 7 Move to the Decoder Setting section using [Cursor ▶], and change the setting using [Cursor ▲ / ▼].

- If you select "On", Scrambled image will be decoded when connected to a decoder.

### 8 Move to the Skip Setting section using [Cursor ▶]. If the setting is "On", change it to "Off" using [Cursor ▲ / ▼].

- If you select "On", the channel will be skipped when you change channels using [PROG. ^ / v].

### 9 When the setup for the position is completed, press [ENTER].

- To set another channel, repeat steps 5 to 9.

### 10 Press [SETUP] to exit.

- "Station" (station name) will be detected and assigned automatically. It cannot be selected.

## To Select a Channel

#### Notes on using [the Number buttons]:

- Enter channel numbers as a two-digit number for the quickest result. For example, to select channel 6, press [0] and [6]. If you only press [6], channel 6 will be selected after 2 seconds. You can only select channels 1 to 99.

#### About an external input:

- You can select the external input mode "AV1", "AV2" or "AV3" using [INPUT SELECT ⇄] or [PROG. ^ / v].
- You cannot change the channel when either HDD, DVD or VCR is in any recording mode (normal recording, One-touch Timer Recording or Timer Recording).

## Move

You can replace two channels.

### 1 Press [SETUP] in stop mode.

Setup Menu will appear.

### 2 Select "Initial Setting" using [Cursor ▲ / ▼], then press [ENTER].

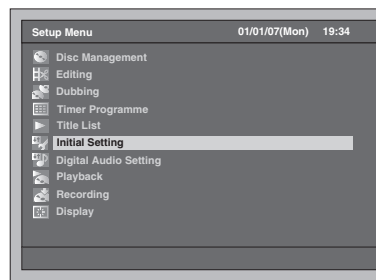

### 3 Select "Channel Setting" using [Cursor ▲ / ▼], then press [ENTER].

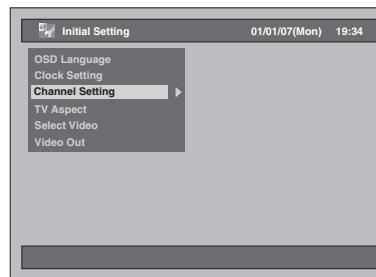

### 4 Select "Move" using [Cursor ▲ / ▼], then press [ENTER].

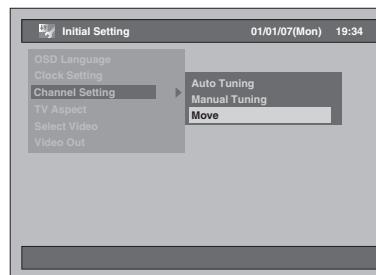

Introduction

Connections

Basic Setup

Recording

Playback

Editing

Function Setup

VCR Functions

Others

- 5** Select the line of the channel you want to move to a new position using [Cursor ▲ / ▼], then press [ENTER].

Pos.	Channel	Decoder	Skip	Station
P01	21	On	Off	ARD
P02	45	Off	Off	---
P03	63	Off	Off	---
P04	80	Off	Off	---
P05	88	Off	Off	---
P06	95	Off	Off	---
P07	110	Off	Off	---
P08	2	Off	On	---

- The indication on the selected line turns red.
- You can jump to the next or the previous page using [SKIP ►►] or [SKIP ◀◀].

- 6** Go to a desired position using [Cursor ▲ / ▼], then press [ENTER].

- The selected channel is now moved.
- To move another channel, repeat steps 5 to 6.

- 7** Press [SETUP] to exit.

## Setting the Clock

### Auto Clock Setting

- 1** Press [SETUP] in stop mode.  
Setup Menu will appear.
- 2** Select "Initial Setting" using [Cursor ▲ / ▼], then press [ENTER].

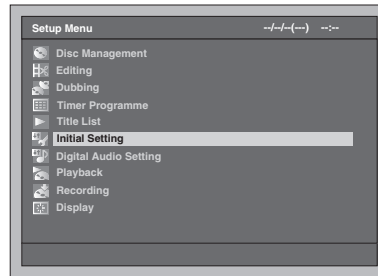

- 3** Select "Clock Setting" using [Cursor ▲ / ▼], then press [ENTER].

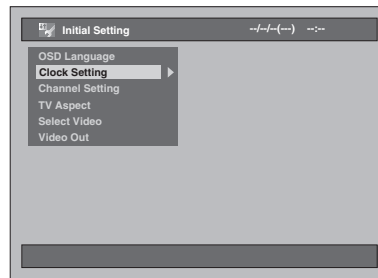

- 4** Select "Auto Clock Setting" using [Cursor ▲ / ▼], then press [ENTER].

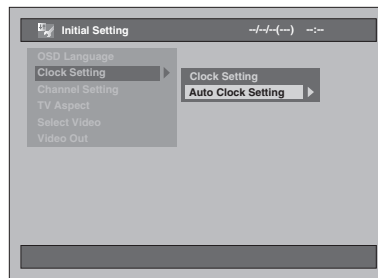

- 5** Select “On” using [Cursor ▲ / ▼], then press [ENTER].

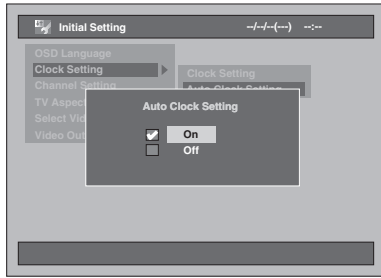

- 6** Press [SETUP] to exit.  
**7** Press [I/ON ON / STANDBY] to turn the unit to standby mode.

The Auto Clock function is activated. This unit will search for the time only when the unit is in standby mode. Leave the unit for several minutes to give it time to set the clock.

#### Note

- If you want to cancel “Auto Clock Setting”, select “Off” using [Cursor ▲ / ▼] at step 5, and then press [ENTER].
- The default setting of “Auto Clock Setting” is “On”.
- The clock may set itself automatically after you connect the antenna cable to the unit and plug in the mains cable. In this case, the current time will appear on the front panel display.
- To set the clock automatically, the channel assigned to “P01” must receive the PDC signal and the Decoder must be Off.
- The clock cannot be set automatically if you are not receiving a channel in your area that carries a time signal. In this case, set the clock manually.
- Once the auto clock setting is performed, the unit will correct the current time by receiving PDC broadcasts whenever the unit is in standby mode.
- The unit will correct the current time automatically at 8:00, if the unit is in standby mode.
- From 23:00 to 1:00, the Auto Clock function will not operate even if the unit is in standby mode.

## Manual Clock Setting

- 1** Follow the steps 1 to 3 in “Auto Clock Setting” on page 30.  
**2** Select “Clock Setting” using [Cursor ▲ / ▼], then press [ENTER].

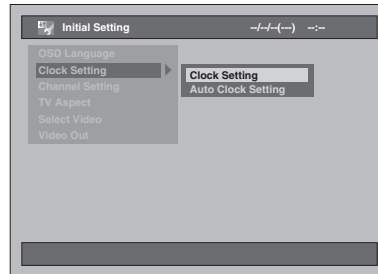

- 3** Move to the item you want to set using [Cursor ◀ / ▶], and change the setting to suit your preference using [Cursor ▲ / ▼].

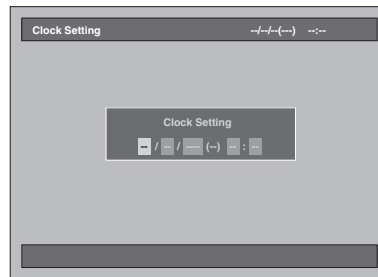

- 4** When all the information is entered, press [ENTER].

Your setting is now activated. Although seconds are not displayed, they will be counted from zero.

- 5** Press [SETUP] to exit.

#### Note

- Your clock setting will be lost if either there is a power failure or this unit has been unplugged for more than 30 seconds.

Introduction

Connections

Basic Setup

Recording

Playback

Editing

Function Setup

VCR Functions

Others

## Selecting the Sound Mode

This unit can receive bilingual broadcasts.

You can switch between modes by pressing **[AUDIO **] on the remote control. Each mode is indicated on the TV screen as follows.

- During reception of bilingual broadcasts

Mode	Audio output	Display on the TV screen
Main	Main audio from both speakers	Main
Sub	Sub audio from both speakers	Sub
Main / Sub	<ul style="list-style-type: none"> <li>• Main audio from the left speaker</li> <li>• Sub audio from the right speaker</li> </ul>	Main/Sub

## Selecting the TV Aspect Ratio

You can select the TV aspect ratio to match the formats of what you are playing back on the unit and your TV screen (4:3 standard or 16:9 widescreen TV).

- 1 Press **[SETUP]** in stop mode.  
Setup Menu will appear.
- 2 Select **“Initial Setting”** using **[Cursor ▲ / ▼]**, then press **[ENTER]**.

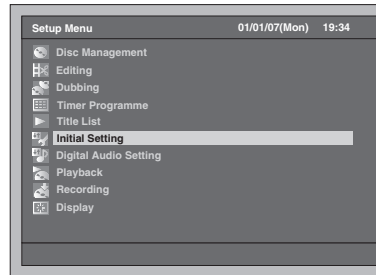

- 3 Select **“TV Aspect”** using **[Cursor ▲ / ▼]**, then press **[ENTER]**.

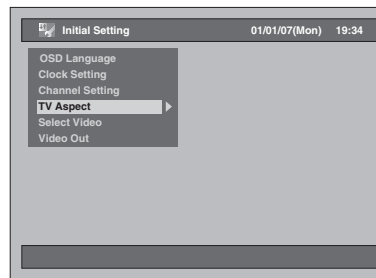

- 4 Select the desired setting using **[Cursor ▲ / ▼]**, then press **[ENTER]**.

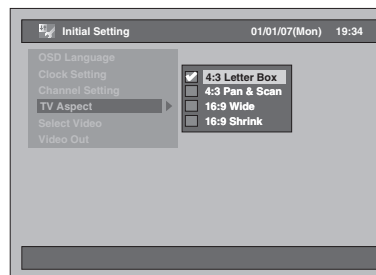

The selected setting will be checked and activated.

- The default setting is “4:3 Letter Box”.

- 5 Press **[SETUP]** to exit.

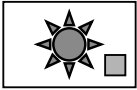
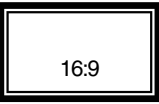
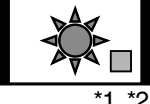
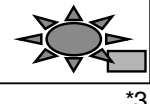
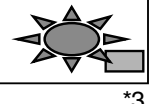
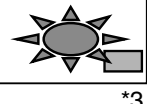
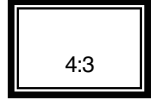
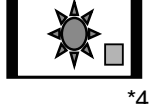
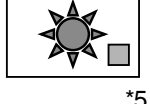
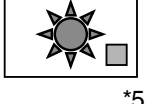
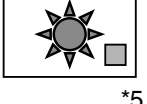
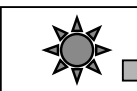
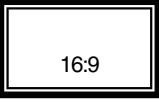
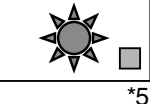
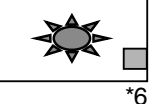
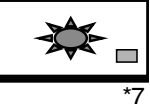
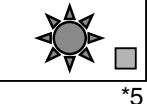
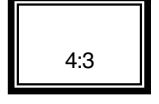
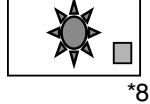
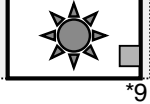
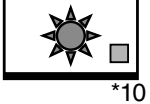
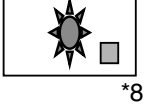

Refer to the table below to find the appropriate setting for your TV.

The aspect ratio of the original image	Your TV	Your Setting			
		16:9 Shrink	4:3 Pan & Scan	4:3 Letter Box	16:9 Wide
4:3 	16:9 	 *1, *2	 *3	 *3	 *3
	4:3 	 *4	 *5	 *5	 *5
16:9 	16:9 	 *5	 *6	 *7	 *5
	4:3 	 *8	 *9	 *10	 *8

- \*1 The aspect ratio of the image will not be distorted and no parts will be cropped, but black bars will appear on both sides.
- \*2 Select this option only when you cannot change the ratio on your TV.
- \*3 The image will be stretched horizontally to fit 16:9 TV screen.
- \*4 This setting is designed to view the 4:3 image on 16:9 TV. If you have 4:3 TV and select this setting, black bars will appear on both sides and the image will be squeezed horizontally.
- \*5 No effect.
- \*6 This setting is for 4:3 TV. If you have 16:9 TV and select this setting, the aspect ratio of the image will be distorted and parts of the image will be cropped.
- \*7 This setting is for 4:3 TV. If you have 16:9 TV and select this setting, black bars will appear on the top and bottom of the screen and the image will be squeezed vertically.
- \*8 The image will be squeezed horizontally to fit the 4:3 TV screen.
- \*9 The aspect ratio of the image will not be distorted but the both sides will be cropped to fit the 4:3 TV screen.
- \*10 The aspect ratio of the image will not be distorted and no parts will be cropped, but black bars will appear on the top and bottom of the screen.

Introduction

Connections

**Basic Setup**

Recording

Playback

Editing

Function Setup

VCR Functions

Others

# Recording

## Information on Supported Media

### Media Types

You want to	HDD	DVD-RW VR	DVD-RW Video	DVD-R	DVD+RW	DVD+R	VCR
Record TV programmes	○	○	○	○	○	○	○
Reuse by deleting unwanted contents	○	○	○	×	○	×	○
Edits recorded contents	○	○	○	○	○	○	×
Edit/Record from connected equipment	○	○	○	○	○	○	○ <sup>*2</sup>
Copy disc for distribution	×	○ <sup>*1</sup>	○	○	○	○	×
Play on other HDD/DVD/VCR equipment	×	○ <sup>*1</sup>	○	○	○	○	○

\*1 VR mode DVD-RW can only be played on DVD equipment that is VR compatible.

\*2 Programmes can be recorded from other equipment, but they cannot be edited.

Features	HDD	DVD-RW VR	DVD-RW Video	DVD-R	DVD+RW	DVD+R	VCR
<b>Recording</b>							
Rewritable	Yes	Yes	Yes	No	Yes	No	Yes
Can create chapters at fixed intervals (auto.)	Yes	No	No	No	No	No	No
Can create chapters wherever you like (manual)	Yes	Yes	No	No	Yes	Yes	No
Can record 16:9 size pictures	Yes	Yes	No	No	No	No	No
Can record copy-once programmes	Yes	Yes <sup>*1</sup>	No	No	No	No	Yes
<b>Editing</b>							
Can perform basic edit functions	Yes	Yes	Yes	Yes	Yes	Yes	No
Can perform advanced edit functions (Playlist edit)	Yes	Yes	No	No	No	No	No

\*1 CPRM compatible disc only.

### Note

- For details of the above functions and implied restrictions, see the explanations inside this Owner's Manual.

### Information:

This unit can record on DVD-RW / R discs and DVD+RW / R discs.

DVD-R / +R discs allow you to record programmes only once, and the recorded contents can be erased although the space left on the disc does not change. DVD-RW / +RW discs allow you to record programmes repeatedly, and the recorded contents can be erased.





There are 3 recording formats: VR mode, Video mode and +VR mode. VR and Video modes are available for DVD-RW discs while as only Video mode is available for DVD-R discs. +VR mode is available for DVD+RW / R discs.

Video mode is the same recording format as used on the pre-recorded DVD-Videos you purchase in local shops. You can play back the discs recorded in this format on most of the DVD players. You will need to finalise such discs (see page 57) before playing them back on other DVD players. Unless finalised, you can record additional materials or edit discs recorded in Video mode with this unit.

VR (Video Recording) mode is a basic recording format for DVD-RW discs.

You can record and edit material repeatedly. It is impossible to record additional materials on a disc formatted in VR mode and already recorded in another video system other than PAL, such as NTSC.

+VR mode is a recording format for DVD+RW / R. You can play back in this format on most of the DVD player.

Logo	Attributes
	8 cm / 12 cm, single-sided, single layer disc Max. recording time (SLP mode, approx.): 480 minutes (4.7 GB) (for 12 cm) 144 minutes (1.4 GB) (for 8 cm)
	
	8 cm / 12 cm, single-sided, single layer disc Approx. max. recording time (EP mode): 327 minutes (4.7 GB) (for 12 cm) 108 minutes (1.4 GB) (for 8 cm)
	

If you want to record repeatedly on the same disc, or if you want to edit the disc after recording, use a rewritable DVD-RW / +RW type disc. If you want to save recordings without any alteration, use a non-rewritable DVD-R / +R type disc.

### Recordable Discs

- Discs that can be used with this unit:  
 DVD-R: 2x, 4x, 8x or 16x  
 DVD-RW: 2x or 4x  
 DVD+R: 1x-16x  
 DVD+RW: 1x-4x
- We strongly recommend for good recording quality:  
 TDK DVD+R 4x/8x/16x, SONY DVD+R 4x/8x/16x, MAXELL DVD+R 4x/8x/16x, SONY DVD+RW 4x
- Discs that have been tested and are proven to be compatible with this unit:  
 MAXELL DVD-R, TDK DVD-RW 2x, VERBATIM DVD-R 8x, JVC DVD-RW 4x  
 VERBATIM DVD+R 8x  
 VERBATIM DVD+RW 4x
- Although DVD+RW / R discs are playable on other units without finalisation in most cases, it is recommended to finalise in order to stabilise the performance.

Disc type	Disc format	Functions
	Video mode 	Playing back, Limited recording, Limited editing
	VR mode 	Playing back, Recording, Original / Playlist editing
	Video mode 	Playing back, Limited recording, Limited editing
	+VR mode 	Playing back, Limited recording, Limited editing
	+VR mode 	Playing back, Limited recording, Limited editing

DVD players bearing the **RW COMPATIBLE** logo are capable of playing back DVD-RW discs recorded in VR mode.

### Rec Mode

You can select a Rec Mode among 5 options in DVD-RW / R, 4 options in DVD+RW / R. And the recordable time and the picture / audio quality of recorded material depends on the Rec Mode you select.

Disc size	Rec Mode	Recording time	Video / Sound Quality
8 cm Disc	XP	18 min	★★★★★ (good)
	SP	36 min	★★★★
	LP	72 min	★★★
	EP	108 min	★★
	SLP (except +VR mode discs)	144 min	★ (poor)
12 cm Disc	XP	60 min	★★★★★ (good)
	SP	120 min	★★★★
	LP	240 min	★★★
	EP	360 min	★★
	SLP (except +VR mode discs)	480 min	★ (poor)
HDD (Internal)	XP	34 hrs	★★★★★ (good)
	SP	68 hrs	★★★★
	LP	136 hrs	★★★
	EP	204 hrs	★★
	SLP	272 hrs	★ (poor)

To select the Rec Mode you prefer, press **[REC MODE]**. The information of the selected media (internal HDD or DVD) will be displayed.

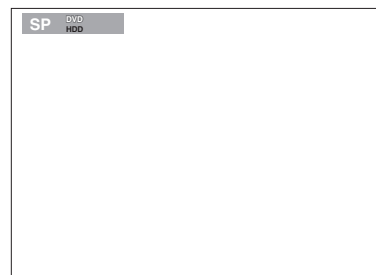

Press **[REC MODE]** repeatedly to change the Rec Mode. The speed will be changed each time you press it with the following order:



SLP mode is not available for +VR mode discs. If DVD+RW / R were used for the Timer Programming with SLP mode, the Rec Mode will change to EP mode.

- \* The recording time is an estimate and actual recording time may differ.
- \* Audio and video quality of the content being recorded may degrade if the recording time becomes longer.
- \* If you press **[DISPLAY]**, remaining recording time is displayed when the unit is in stop mode.

**Note**

- This unit cannot record on CD-RW or CD-R discs.
- DVD-RW / R discs, DVD+RW / R discs and CD-RW / R discs recorded on a personal computer or a DVD or CD recorder may not be played back if the disc is damaged or dirty or if there is condensation on the unit's lens.
- If you record on a disc using a personal computer, there are cases in which it may not be played back because of the settings of the application software used to create the disc, even if it is recorded in a compatible format. (Check with the software publisher for more detailed information.)
- Discs recorded in Video mode on this unit cannot record additionally using other DVD recorders.
- Since the recording is made by the variable bit rate (VBR) method, the actual remaining time for recording may be a little bit shorter than the remaining time displayed on the OSD, depending on the picture you are recording.
- DVD-RW once formatted with other DVD recorders cannot be recorded on this unit and vice versa.
- The maximum Fast Dubbing speed is up to 4x for DVD-RW discs and DVD-R discs.
- During Fast Dubbing, the noise from the unit becomes louder. This is not a malfunction.

**Restrictions on Recording**

You cannot record copy-protected video or a programme broadcasted in the NTSC colour system using this unit. Copy-protected video includes DVD-Videos and some satellite broadcasts.

If copy-protected material or NTSC signal is detected, recording will pause or stop automatically and an error message appears on the screen.

You can only record "Copy-once only" video using a DVD-RW disc in VR mode with Content Protection for Recordable Media (CPRM).

When recording a TV broadcast or an external input, you can display copy control information on the screen.

CPRM is a scrambling copy protection system for the protection of "copy-once" broadcast programmes.

This unit is CPRM compatible, which means that you can record copy-once broadcast programmes, but you cannot make a copy of those recordings. CPRM recordings can only be played back on DVD players that are specifically compatible with CPRM.

**Maximum recordable numbers of title / chapters:**







<b>HDD:</b>	600 titles per each Playlist and Original 99 chapters per title
<b>VR mode DVD:</b>	99 titles per each Playlist and Original 999 chapters per each Playlist and Original
<b>Video mode DVD:</b>	99 titles per disc 99 chapters per title
<b>+VR mode DVD:</b>	49 titles per discs 254 chapters per disc 99 chapters per title

**Note**

- Remaining time of +VR mode disc may decrease when adding chapter marks or increase when clearing chapter marks depending on the recording time or edited contents.
- For +VR mode disc, it is not likely to be able to add chapter marks up to the maximum recordable numbers of chapters, according to time and number of chapters.

**Information on Copy Control**

Some satellite broadcasts include copy-protected information. If you wish to record them, refer to the following.

Disc type / format	Copy-free	Copy-once	Copy-prohibited
 HDD	☆	☆	—
 VR DVD-RW ver. 1.1 / ver. 1.2	☆	—	—
ver. 1.1 / ver. 1.2 CPRM compatible	☆	☆	—
 Video DVD-RW ver. 1.1 / ver. 1.2	☆	—	—
ver. 1.1 / ver. 1.2 CPRM compatible	☆	—	—
 DVD-R ver. 2.0	☆	—	—
 DVD+RW	☆	—	—
 DVD+R	☆	—	—
 VCR	☆	☆	☆

☆ : Recordable

— : Not recordable

**Making Discs Playable in Other DVD Players (Finalise)**

After recording, you must finalise the disc to play it back on other players. (See page 57.)

You cannot finalise discs in other DVD recorders.

- For Video mode discs, the finalisation is required.
- For VR mode discs, the finalisation is recommended.
- For +VR mode discs, the finalisation is recommended.
- For the information on videotapes, refer to "VCR Functions" on pages 100 to 102.

## About HDD

HDD is a special device which has high recording density and is suited for long-time recording or high-speed cueing but by contrast, has many factors which can cause breakage. Use HDD on the premise that you should dub the recorded programmes to a DVD disc or a videotape to protect your previous videos.

### **HDD is a temporary storage location:**

HDD is not a permanent storage location of the recorded contents. Be sure to use it as a temporary storage location until you watch the programmes once, edit them, or dub them to a DVD disc or a videotape.

### **Be sure to dub (back up) data promptly if you find abnormalities in HDD:**

If there is mechanical trouble with the HDD, grinding or other sounds may be heard or blocky noise may appear on the image. If you continue to use as it is, deterioration may continue and eventually the HDD may not be used at all. If you notice these symptoms of a failing HDD, promptly dub the data to a DVD disc or a videotape.

When an HDD fails, recovery of recorded content (data) may be impossible.

### **About the remaining capacity of HDD recording time:**

In recording to HDD, the Remaining Capacity Display may differ from the actual recordable time as this unit adopts Variable Bit Rate encoding, which varies the recording (storage) amount of data in conformity with the information amount of video. Before recording to the HDD, ensure there is sufficient space on the HDD by deleting unnecessary titles in advance. (Remaining capacity will not increase if you only delete Playlists.)

Introduction

Connections

Basic Setup

Recording

Playback

Editing

Function Setup

VCR Functions

Others

## Formatting a Disc

### Auto Format

Whenever you load a brand new DVD-RW and DVD+RW disc, the unit will ask you to format the disc.

#### 1 Select the recording format you prefer using [Cursor ◀ / ▶]. Then press [ENTER] to format the disc.

- Brand new DVD-R disc is formatted in Video mode and brand new DVD+R is formatted in +VR mode. But limited to the brand new DVD-R disc only, you can re-format the disc. Refer to "Reformatting a Disc (Disc Format)" below.

#### Note

- You cannot mix two formats on one DVD-RW disc. When you load a disc once recorded before, the recording format cannot be changed even if you change it in the Setup Menu.

### Reformatting a Disc (Disc Format)



If you format a pre-recorded DVD-RW / +RW disc, all the data contained in it will be erased and the disc will return to the blank media status. This feature is only available for the DVD-RW / +RW disc.

#### 1 Press [SETUP] in stop mode.

Setup Menu will appear.

#### 2 Select "Disc Management" using [Cursor ▲ / ▼], then press [ENTER].



#### 3 Select "DVD Format" using [Cursor ▲ / ▼], then press [ENTER].



#### 4 Select the desired setting using [Cursor ▲ / ▼], then press [ENTER].

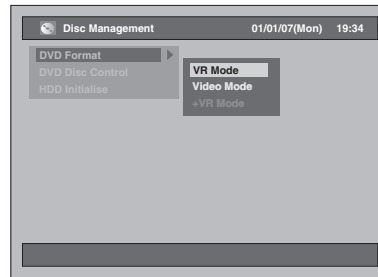

- The default setting is "VR Mode".

#### 5 Select "Yes" using [Cursor ◀ / ▶], then press [ENTER].

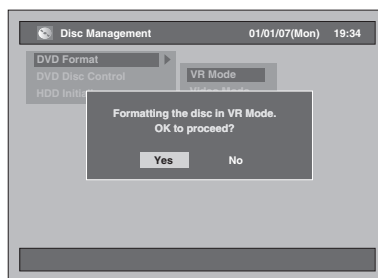

Formatting will start.  
Example: VR Format

- The screen returns to normal after formatting is completed.
- This operation may take awhile to be completed.

#### Note

- When you reformat the DVD-RW / +RW disc, all contents of the disc will be erased.
- A disc once formatted with this unit cannot be used on other DVD recorders unless finalised.
- Depending on discs, the available format will vary.  
DVD-RW: VR mode, Video mode  
DVD+RW: +VR mode

## Deleting All Contents in HDD

- 1 Press [SETUP] in stop mode.  
Setup Menu will appear.
- 2 Select "Disc Management" using [Cursor ▲ / ▼], then press [ENTER].

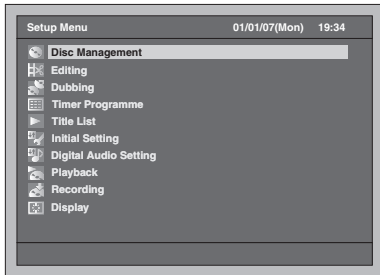

- 3 Select "HDD Initialise" using [Cursor ▲ / ▼], then press [ENTER].

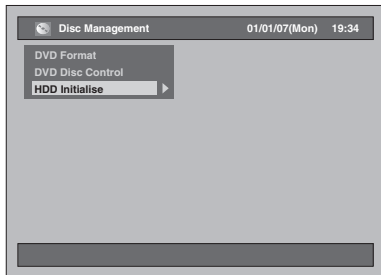

- 4 Select a setting using [Cursor ▲ / ▼], then press [ENTER].

- The default setting is "All Erase".

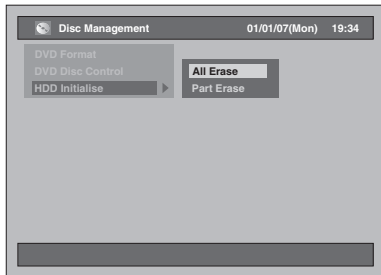

### All Erase:

Select "Yes" using [Cursor ◀ / ▶], then press [ENTER].

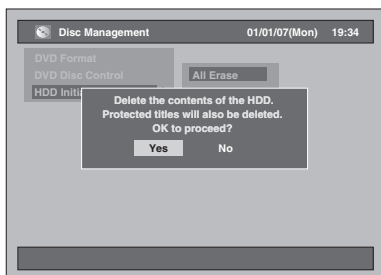

All contents in HDD will be deleted.

- The default setting is "No".

### Part Erase:

Select "Yes" using [Cursor ◀ / ▶], then press [ENTER].

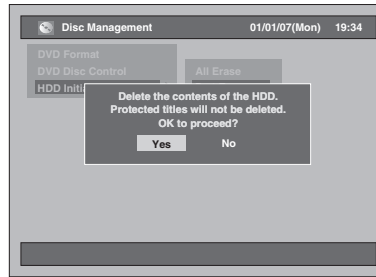

The protected contents in HDD will not be deleted.

- The default setting is "No".

## Creating Chapter Marks Automatically



You can sort out the recording by adding chapter marks every set time interval.

- 1 Press [SETUP] in stop mode.  
Setup Menu will appear.
- 2 Select "Recording" using [Cursor ▲ / ▼], then press [ENTER].

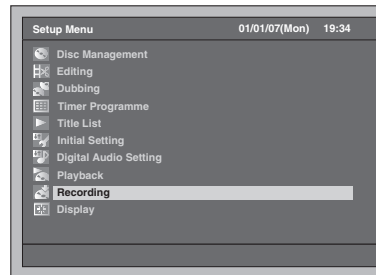

- 3 Select "Auto Chapter [HDD]" using [Cursor ▲ / ▼], then press [ENTER].

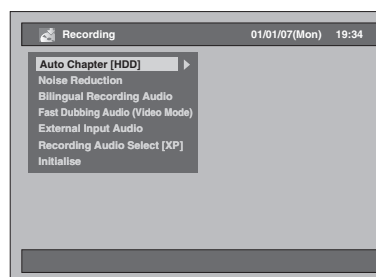

Introduction

Connections

Basic Setup

Recording

Playback

Editing

Function Setup

VCR Functions

Others

#### 4 Select the desired setting using [Cursor ▲ / ▼], then press [ENTER].



The selected setting will be checked and activated.

- The default setting is "15 minutes".

#### 5 Press [SETUP] to exit.

##### Note

- Depending on the recording time, a chapter with no image may be created at the end.
- Chapter marks will automatically be added at the set interval with "Auto Chapter [HDD]". (Chapter marks will not be added while recording is paused.) To add chapter marks manually, refer to "Adding or Deleting Chapter Marks Manually" on page 78.

## Setting Bilingual Recording Audio



You can select either "Main" or "Sub" audio to record a bilingual broadcast in Video mode and +VR mode.

#### 1 Press [SETUP] in stop mode.

Setup Menu will appear.

#### 2 Select "Recording" using [Cursor ▲ / ▼], then press [ENTER].

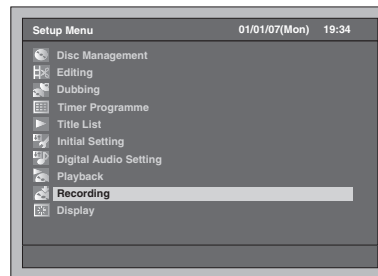

#### 3 Select "Bilingual Recording Audio" using [Cursor ▲ / ▼], then press [ENTER].

#### 4 Select the desired setting using [Cursor ▲ / ▼], then press [ENTER].

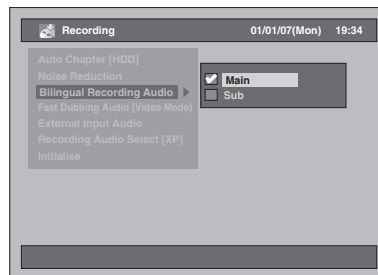

- Main : Main audio
- Sub : Sub audio

The selected setting will be checked and activated.

- The default setting is "Main".

#### 5 Press [SETUP] to exit.

##### Note

- If you are recording onto a VR mode disc, both "Main" and "Sub" will be recorded regardless of your setting here. And when you play back, you can choose either audio format or a combination of both as your playback audio.
- If you are recording the bilingual programme onto the HDD with "Fast Dubbing Audio (Video Mode)" set to "On", the recording will be made in whichever the audio format type you choose here.
- Make sure to set the audio format as mentioned above when you record on the HDD or a VR mode DVD-RW disc while "Recording Audio Select [XP]" is set to "LPCM".



## Recording Audio Select (XP)



You can enjoy high quality sound recording. This function works only when the recording mode is set at XP.

- 1 Press **[SETUP]** in stop mode.  
Setup Menu will appear.
- 2 Select **"Recording"** using **[Cursor ▲ / ▼]**, then press **[ENTER]**.

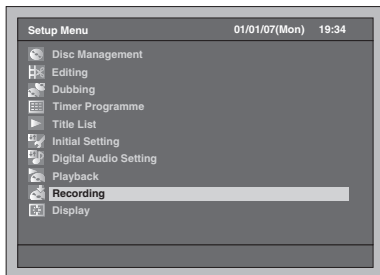

- 3 Select **"Recording Audio Select [XP]"** using **[Cursor ▲ / ▼]**, then press **[ENTER]**.
- 4 Select the desired setting using **[Cursor ▲ / ▼]**, then press **[ENTER]**.



The selected setting will be checked and activated.

- The default setting is "Dolby Digital".

### Dolby Digital:

Records Dolby Digital audio for good quality sound.

### LPCM:

Records Linear PCM audio for the best quality sound.

- 5 Press **[SETUP]** to exit.

### Note

- "LPCM" stands for Linear Pulse Code Modulation. It changes analogue sound to digital sound without compressing audio data.
- When the recording mode is set at other than XP, the unit records "Dolby Digital" audio automatically even if you selected "LPCM".
- With HDD or VR mode DVD-RW discs, you cannot record both main and sub audio together when "LPCM" is selected. Instead, whichever the type of audio selected in "Bilingual Recording Audio" will be recorded. (See "Setting Bilingual Recording Audio" on page 40.)

Introduction

Connections

Basic Setup

Recording

Playback

Editing

Function Setup

VCR Functions

Others

## Basic Recording



Follow the steps below to record a TV programme.

- Use only the HDD or CPRM-compatible VR mode DVD-RW discs for recording copy-once programmes. (See page 36.)

If you are recording to the HDD, press [HDD] first. If you are recording to a disc, press [DVD] first. Insert a recordable disc if you are recording to a DVD.

- 1 Turn on the TV. Select the appropriate external input channel.**  
(See pages 23 to 24.)
- 2 Select a Rec Mode using [REC MODE].** (See page 35.)
- 3 Select the desired channel to record using [PROG. ^ / v] or [the Number buttons].**
- 4 Press [REC ●] to start recording.**  
The information will be displayed for 5 seconds. To pause the recording, press [PAUSE II]. Press [REC ●] or [PAUSE II] to resume the recording.
- 5 Press [STOP ■] to stop the recording.**

### Note

- If playback and recording are in progress at the same time, select the appropriate device by pressing [HDD] or [DVD] before you press [PAUSE II] or [STOP ■] to pause or stop the operation.
- When the Clock Setting has not been made, the date and time of title names will be 01/01/07(Mon) and 0:00.
- Up to 600 titles can be recorded on the HDD.
- Up to 99 titles can be recorded on the DVD-RW / R discs.
- Up to 49 titles can be recorded on the DVD+RW / R discs.
- You cannot change the recording mode during HDD / DVD recording.
- If you want to monitor the programme that you are recording, make sure the device such as a Satellite Box is powered off or press [DISPLAY] when it is connected to AV2.
- NTSC recording is prohibited in this unit.
- You can play back a title on one device while making a recording on other device. To do so, simply select the device (HDD, DVD or VCR) you like to use for the playback by pressing [HDD], [DVD] or [VCR] button during HDD / DVD / VCR recording. And then follow the normal playback procedure.

## One-touch Timer Recording (OTR)



This is a simple way to start a Timer Recording. You can start recording right away by just one touch of a button and each press of the button sets the end time for the recording. The recording time will increase by 15 minute to the max of 4 hours.

If you are recording to the HDD, press [HDD] first. If you are recording to a disc, press [DVD] first.

- 1 Whenever you want to start recording the programme you are watching, press [REC ●].**  
The recording will start.
- 2 Press [REC ●] repeatedly to set the end time for the recording. Each press of the button will increase the recording time by 15 minutes (the maximum recording time is 4 hours).**

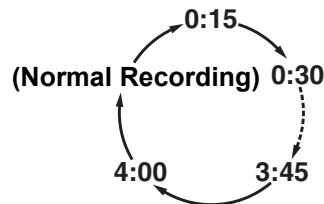

- The maximum recording time is 4 hours.
- To change the recording time during the One-touch Timer Recording, press [REC ●] repeatedly.

- 3 When the recording is completed, the unit will ask you whether to turn off the unit except conditions listed below.**

- If a Timer Recording is programmed to start in 5 minutes.
- During playback of HDD / DVD / VCR.
- During recording of HDD / DVD / VCR.
- While displaying menus or information on the screen.
- The unit will be turned off automatically if you select "Yes" or if you do not reply in 1 minute.
- To cancel the OTR in progress, press [STOP ■].

### Note

- The remaining recording time will be displayed on the Front Panel Display during a One-touch Timer Recording.
- The unit will turn off automatically when a power failure occurs.

- If you want to monitor the programme that you are recording, make sure the device such as a Satellite Box is powered off or press **[DISPLAY]** when it is connected to AV2.
- If you have not set the clock, you cannot switch to OTR. Set the clock in "Setting the Clock" on page 30 before One-touch Timer Recording.
- When the DVD disc space is full during the One-touch Timer Recording, the Timer Recording stops and the unit turns off.
- You cannot pause OTR.

## Timer Recording



You can programme the unit to record up to 32 programmes within a month in advance. Daily or weekly recordings are available.

### Preparing for Timer Recording:

- Be sure to set the clock before programming a Timer Recording. Refer to "Setting the Clock" on page 30.
- Check that the recording media (internal HDD or DVD) has enough recordable space for the time you set.
- Insert a recordable disc if you are recording to a DVD.
- Use only the HDD or CPRM-compatible VR mode DVD-RW discs for recording copy-once programmes. (See page 36.)

### 1 Press **[TIMER PROG.]**.

Timer Programme List will appear.

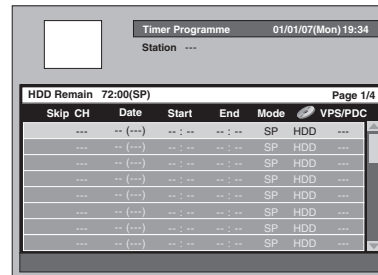

- You can access this screen from the Setup Menu also.

### 2 Select a line which is not yet set using **[Cursor ▲ / ▼]**, then press **[ENTER]**.

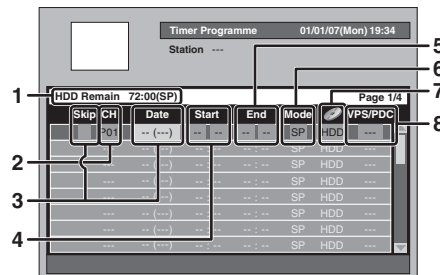

- 1 Available recording time left on the recording media under the programmed Rec Mode.
- 2 Recording Channel:  
To record from an external input, select "AV1", "AV2" or "AV3". (Using camcorder or other source.)

Introduction

Connections

Basic Setup

Recording

Playback

Editing

Function Setup

VCR Functions

Others

### 3 Recording Date:

When press [**Cursor ▼**] at the current date, the setting will change as follows.

e.g., 1st January

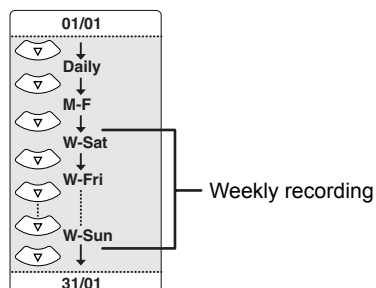

Skip:

Select this item only when you want to deactivate the periodical (Daily, Mon-Fri or Weekly) Timer Recording temporarily. To do so, move the cursor to the Skip section and then press

[**Cursor ▲ / ▼**].

Check mark will appear and press [**ENTER**] to activate the setting.

#### 4 Start Time:

#### 5 End Time:

#### 6 Rec Mode:

Refer to "Rec Mode" on page 35.

#### 7 Recording Media (HDD or DVD):

To record onto the HDD, select "HDD". To record onto a disc, select "DVD". VCR is not compatible with Timer Recording.

#### 8 VPS/PDC system:

Refer to "VPS (Video Programme System) / PDC (Programme Delivery Control)" on page 45.



- VPS/PDC system is only available for HDD.
- VPS/PDC system is not available for periodical timer programme.

### 3 Select an item to set using

[**Cursor ◀ / ▶**], and set the contents to suit your preference using [**Cursor ▲ / ▼**].

#### 4 Press [**ENTER**] when all the information is entered.

The  icon will appear on the Front Panel Display indicating one or more Timer Recordings are in standby.

- Press [**CLEAR**] will reset all the entered information.
- To set another programme, repeat steps 2 to 4.
- When programmes are overlapped, a warning message "All or part of the programme will not be recorded." will appear.
  - When  icon appears, a part of the programme will not be recorded.
  - When  icon appears, the whole programme will be recorded.

For details on overlapped Timer Programmings, refer to "Hints for Timer Recording" on page 45.

#### 5 Press [**TIMER PROG.**] to exit.

- You can also press [**SETUP**] twice to exit.

- If you press [**||/⏻ ON / STANDBY**] to turn the unit to standby mode, it will turn on 2 minutes before the programmed recording time, and start recording at the programmed recording time. When the recording is completed, the unit will ask you whether to turn off the unit. The unit will be turned off automatically if you select "Yes" or if you do not reply in 1 minute.
- To stop recording in progress, press [**STOP ■**]. Confirmation message will appear. Select "Yes" using [**Cursor ◀ / ▶**].

#### Relay Recording:

When you Timer Record to DVD, the unit automatically changes the recording media to HDD under the conditions listed below:

- when there is no recordable disc in the unit.
  - when the disc does not have enough space for the recording.
  - if the unit is formatting or finalising a disc.
- This feature is available only for Timer Recording but not for OTR.

#### Note

- If you have not set the clock, the clock setting window will appear instead of Timer Programme List at step 1. Continue from step 3 in "Setting the Clock" on page 30 before programming the timer.
- If a basic recording or One-touch Timer Recording is in progress on the VCR and the Timer Recording set for HDD or DVD is about to begin, the unit will automatically switch to the programmed channel within 15 seconds before the programmed time, and the recording in progress on the VCR will be cancelled UNLESS their recording channel is the same. If their recording channel is the same, the Timer Recording for HDD or DVD will start without cancelling the recording currently in progress on the VCR. In this case, the recording of the same channel will be made on both VCR and the HDD or DVD.
- The maximum recordable duration is 7 hours for Video mode discs, 8.5 hours for VR mode discs and 5 hours for +VR mode discs.
- If the recording time exceeds 12 hours, a Timer Recording cannot be set.
- If the starting time you entered is already in the past, the recording will start as soon as you activate the Timer Recording by pressing [**ENTER**] at step 4.
- If playback and recording are in progress at the same time, select the appropriate device by pressing [**HDD**], [**DVD**] or [**VCR**] before you press [**PAUSE II**] or [**STOP ■**] to pause or stop the operation.
- When the Timer Recording is finished, confirmation message will appear. If there is no signal for about 1 minute, unit will turn off automatically.
- If DVD+RW / R were used for the Timer Programming with SLP mode, the Rec Mode will change to EP mode.
- When VPS / PDC is set to "On" for timer recording, you may hear some noise from the unit while the unit is in timer standby mode. This is not a malfunction.

## Editing the Timer Programming Information

### 1 Press [TIMER PROG.].

Timer Programme List will appear.

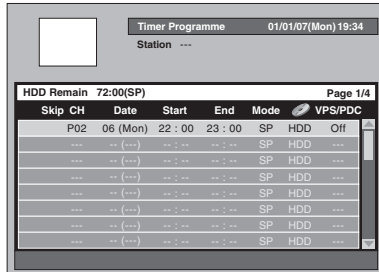

To change the setting of a programme:

- 1 Select the programme you want to edit using [Cursor ▲ / ▼], then press [ENTER].
  - Use [SKIP ►►] or [SKIP ◄◄] to jump to next / previous Timer Programme List page.

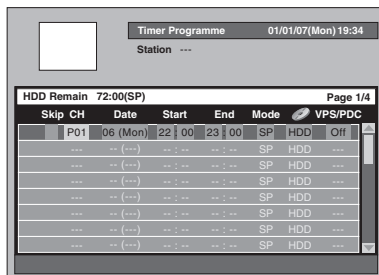

- 2 Move to the item you want to change using [Cursor ◄ / ►], then press [Cursor ▲ / ▼] to change the setting.
- 3 Press [ENTER] to confirm.

To delete a programme from the list:

- 1 Select the programme you want to delete using [Cursor ▲ / ▼] (Do not press [ENTER]), then press [CLEAR].
- 2 Select "Yes" using [Cursor ◄ / ►], then press [ENTER]. The programme is now deleted.

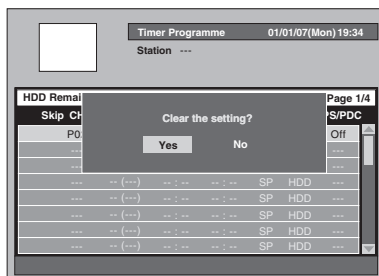

### 2 Press [TIMER PROG.] to exit.

#### Note

- This unit automatically lists up the programmes in the order of start time every time you access the Timer Programme List.

## VPS (Video Programme System) / PDC (Programme Delivery Control)

The Video Programme System (VPS) or Programme Delivery Control (PDC) assures that the TV programmes you have programmed for Timer Recording are recorded exactly from beginning to end, even if the actual broadcasting time differs from the scheduled time due to a delayed start or extension of the programme duration. Furthermore, if a programme is interrupted, the recording will also be interrupted automatically and resumed when the programme starts again.

If the VPS / PDC signal drops out because the broadcast signal is weak, or if a broadcasting station does not transmit a regular VPS / PDC signal, the Timer Recording is performed in normal mode (without VPS / PDC) even if it was programmed for VPS / PDC. If the starting time of the VPS / PDC Timer Recording is between 0:00 and 3:59 on a given day, the VPS / PDC function will operate from 20:00 on the previous day to 4:00 on the next day. If the starting time of the VPS / PDC Timer Recording is between 4:00 and 23:59 on a given day, the VPS / PDC function will operate from 0:00 on the given day to 4:00 on the next day. This means that if the relevant programme is broadcasted within this period, it is recorded correctly. If the timer is not programmed correctly, the incorrect timer setting stays in effect unless you cancel it. To cancel an incorrect timer setting, refer to "Editing the Timer Programming Information" on this page.

## Hints for Timer Recording

### The priority of overlapped settings:

When the Timer Programmings are overlapped, you will receive a warning message.

If this happens, check the Timer Programme List and change it as necessary. Otherwise, the unit will prioritise recording as described below.

### If the starting time is same:

- The Timer Programming set first (PROG. 1) has priority.

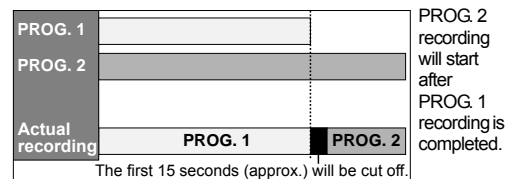

### Different start time and different end time:

- A program with the earlier start time has the priority.

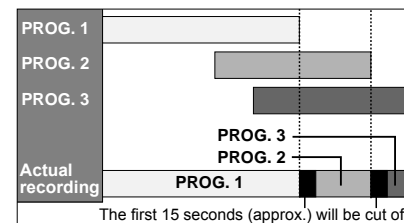

**If the recording time entirely overlaps:**

- The shorter Timer Programming (PROG. 2) is not recorded.

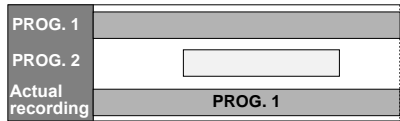
**If the End time of the programme currently being recorded and the Start time of the subsequent programme are same:**

- If PROG. 1 is a DVD recorded programme, the beginning of PROG. 2 may be cut off.

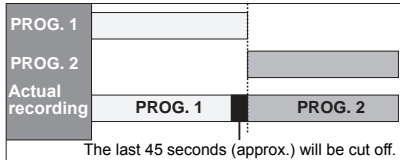

- \* The amount of time cut off differs depending on the recording media.

## Setting External Input Audio



When the external input audio is a bilingual broadcast, or when copying a videotape to a DVD disc, you can choose "Stereo" or "Bilingual" to record on a DVD.

- 1 Press [SETUP] in stop mode.**  
Setup Menu will appear.
- 2 Select "Recording" using [Cursor ▲ / ▼], then press [ENTER].**

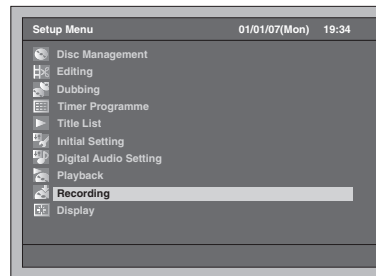

- 3 Select "External Input Audio" using [Cursor ▲ / ▼], then press [ENTER].**
- 4 Select the desired setting using [Cursor ▲ / ▼], then press [ENTER].**



- Stereo : Stereophonic sound
  - Bilingual : Main and Sub audio
- The selected setting will be checked and activated.
- The default setting is "Stereo".

- 5 Press [SETUP] to exit.**

**Hint**

- If you try to record bilingual audio onto a Video mode DVD-RW / R and +VR mode DVD+RW / R disc and when "Bilingual" is selected, only either one of main or sub audio will be recorded. (See "Setting Bilingual Recording Audio" on page 40 for more detail.)
- When recording the bilingual audio from the external equipment, make sure to select "Bilingual". If you select "Stereo", a mixture of main and sub audio will be heard when playing back.

# Satellite Link



You can set the unit to start recording whenever it detects the scart control signal from the external tuner.

## Preparing for the Satellite Link Timer Recording:

### [Preparation of the external tuner]

- The external tuner should be equipped with some kind of timer function. Using timer function of the tuner, set it to be turned on when it comes to the time you want to start recording, and off when it comes to the time you want to finish recording. (Refer to the tuner's manual on how to set the timer.)
- Make sure to turn off the external tuner when you finish setting.

### [Preparation of this unit]

- Make sure to select the desired Recording mode beforehand.
- Make sure to set "Bilingual Recording Audio", "Fast Dubbing Audio (Video Mode)" and "External Input Audio" in "Recording" setting correctly.

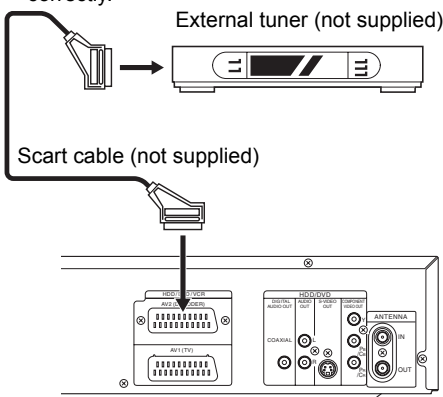

## 1 Press [SATELLITE LINK].

The unit will be turned off automatically as it goes into the Satellite Link standby mode.

- "sat" will appear on the front panel display when you press [SATELLITE LINK].



- When the Satellite Link Recording starts, counter and "●HDD" will appear on the front panel display.



- When the Satellite Link Timer Recording is over, the unit returns to the Satellite Link standby mode unless you cancel the Satellite Link function.

**To cancel the Satellite Link function while in the Satellite Link standby mode:**  
Press [I/⏪ / ON / STANDBY] or [SATELLITE LINK] to turn on the unit.

**To cancel the Satellite Link function while the Satellite Link Recording is in progress:**  
Press [STOP ■].

### Note

- You cannot set the Start / End time for the Satellite Link Timer Recording on this unit.
- The Satellite Link will not be activated unless the unit is in standby mode.
- Recording will be paused while the copy protection or NTSC signal is being detected, and will resume when the copy protection or NTSC signal is no longer detected.
- When a regular Timer Recording is completed, the unit will be turned off automatically.
- When there is not enough space on the HDD, the unit cannot go into the Satellite Link Standby mode. Delete the unnecessary titles from the HDD in such case.
- When a regular Timer Recording and the Satellite Link Timer Recording are overlapped, the regular Timer Recording has priority.

	Example 1
Timer Recording	[Bar chart showing a single timer recording period]
Satellite Link	[Bar chart showing a satellite link recording period overlapping the timer recording]
Actual Recording	[Bar chart showing the actual recording period, which is the timer recording period]

	Example 2
Timer Recording	[Bar chart showing a single timer recording period]
Satellite Link	[Bar chart showing a satellite link recording period overlapping the timer recording]
Actual Recording	[Bar chart showing the actual recording period, which is the satellite link recording period]

	Example 3
Timer Recording	[Bar chart showing a single timer recording period]
Satellite Link	[Bar chart showing two satellite link recording periods overlapping the timer recording]
Actual Recording	[Bar chart showing the actual recording period, which is the union of the two satellite link recording periods]

	Example 4
Timer Recording	[Bar chart showing a single timer recording period]
Satellite Link	[Bar chart showing two satellite link recording periods overlapping the timer recording]
Actual Recording	[Bar chart showing the actual recording period, which is the union of the two satellite link recording periods]

Introduction

Connections

Basic Setup

**Recording**

Playback

Editing

Function Setup

VCR Functions

Others

## Information on Dubbing



You can copy a HDD / DVD disc to a videotape or copy a videotape to a HDD / DVD disc. This function will be possible only if the DVD disc or the videotape is not copy protected. Before starting this function, prepare for the recording on the DVD-RW / R disc, DVD+RW / R disc or the videotape. See pages 34 to 37 (HDD / DVD) or page 100 (VCR).

### Difference between Copy (dubbing) and Move:

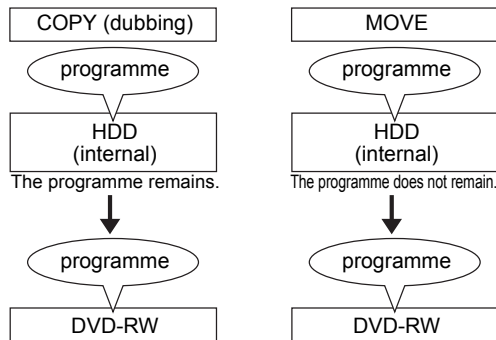

### Available dubbing direction for copy-once programme:

From	To	
HDD (Internal)	DVD-RW (VR) (CPRM-compatible)	○ <sup>1,2</sup>
	DVD-RW (VR) (Not CPRM-compatible)	×
	DVD-RW (Video)	×
	DVD-R / +RW / +R	×
	Videotape	○ <sup>2</sup>
DVD-RW (VR)	HDD (Internal)	×
	Videotape	○ <sup>2</sup>
Videotape	HDD (Internal)	○
	DVD-RW (VR) (CPRM-compatible)	○ <sup>2</sup>
	DVD-RW (VR) (Not CPRM-compatible)	×
	DVD-R / +RW / +R	×

○: Available

×: Not available

\*1: The programme (recorded) moves. (It will be deleted from HDD.)

\*2: You cannot dub the recorded programme to HDD or DVD-RW again. (Copy control signal will be recorded to the videotape.) (Refer to page 36 for details about CPRM.)

### Fast Dubbing:

This unit is compatible with the bi-directional Fast Dubbing between HDD and DVD-RW / R or DVD+RW / R.

Fast Dubbing offers you the dubbing speed of 32 times the SLP mode dubbing for DVD-RW / R and 9.6 times the LP mode dubbing for DVD+RW / R. To perform the Fast Dubbing, set the Rec Mode to "Fast". (See pages 53 to 54.)

- Duration of Fast Dubbing will depend on the Rec Mode, the title amount, and the disc type of the material to be dubbed.
- Fast Dubbing is prohibited when;
  - Rec Mode is set to other than "Fast".
  - dubbing from a Video mode DVD-RW / R to the HDD.
  - dubbing a title in HDD, which has been previously dubbed from a VR mode DVD-RW disc to the HDD, to a Video mode DVD-RW / R disc.
  - dubbing a title with the bilingual audio in HDD, which has been previously recorded with the "Fast Dubbing Audio (Video Mode)" set to "Off", to a Video mode DVD-RW / R disc.
  - there is not enough space left in the disc when dubbing from HDD to DVD or vice versa.
  - dubbing a title in HDD, which has been recorded with EP mode, to DVD+RW / R disc.

### Note

- If you want to dub programmes from both lists (Original List and Playlist), finish up the dubbing of one list first and then make dubbing of the other list.
- NTSC dubbing is prohibited in this unit.
- During Fast Dubbing of copy-once programmes, the following operations are not available:
  - Playback of the titles in HDD.
- When any Rec Mode other than "Fast" is selected,
  - you only can watch the playback image of the title being dubbed (the audio cannot be changed also).
  - Elapsed dubbing time will be displayed in the Front Panel Display, but on the TV screen, it only shows "--:--:--(--h--m--s)".
- If you stop the bi-directional dubbing between HDD and DVD halfway;
  - Playing media : Nothing is moved. Contents remain in the media.
  - Recording media: Nothing is dubbed. With regard to DVD-R, the disc space used for the dubbing process will be lost (even though nothing is dubbed).

## One Touch Dubbing



- 1 Insert a recordable disc when dubbing from HDD to DVD. Insert a disc to be dubbed when dubbing from DVD to HDD.**
- 2 Start the playback of the contents you want to dub.**
- 3 Press [DUBBING] during playback.** Confirmation message will appear.
- 4 Select "Yes" using [Cursor ◀ / ▶], then press [ENTER].**

The dubbing will start.

- When One Touch Dubbing is completed, completion message will be displayed on the screen for a few seconds.
- The dubbing will stop automatically when it reaches the end of the title.



To stop One Touch Dubbing manually, follow the instructions below.

- 1 Press and hold **[DUBBING]** for 4 seconds.
- 2 Select "Yes" using **[Cursor ◀ / ▶]**, then press **[ENTER]**.  
Completion message will appear and the dubbing will stop.
- 3 Press **[ENTER]** to remove the message.

#### Note

- The Rec Mode will be set to "Auto" for the One Touch Dubbing.

## One Touch Dubbing from HDD or Videotape to DVD

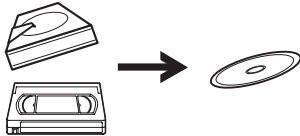

With One Touch Dubbing, you can start dubbing right away with just one touch.

#### Before:

##### [General]

- Recordable DVD must be in the unit. (See pages 34 to 36.)
- There should be enough space on the recording DVD.
- Make sure to press the corresponding Device Select Button before using the device of your choice.
- Dubbing cannot be executed during recording of any device.

##### [Videotape to DVD dubbing]

- A videotape to be dubbed must be in the unit.

#### Limitations:

##### [General]

- You cannot dub to the finalised Video mode DVDs.
- You cannot dub to the protected VR mode DVDs.
- You cannot dub to the DVD if the number of the titles or the chapters of the disc is at its limit.
- Dubbing cannot be executed while the Setup Menu is showing.

##### [HDD to DVD dubbing]

- If a copy control signal is detected, the dubbing cannot be started.
- Dubbing cannot be executed during HDD or DVD recording.

##### [Videotape to DVD dubbing]

- If a copy control signal is detected during dubbing, the dubbing will be stopped.
- Copy-once programmes which are recorded directly from the TV can be dubbed to the HDD / DVD.
- Copy-once programmes which are copied from the HDD / DVD to a videotape cannot be dubbed further from the videotape to the HDD / DVD.
- Be noted that with videotape to DVD dubbing, the unit recognise DVD's remaining time as the dubbing duration although the actual dubbing will end when the videotape ends.

## 1 There are three ways to start One Touch Dubbing.

### Method 1 (Videotape to DVD):

Play the contents of videotape you want to dub. When it comes to the point where you want to start dubbing from, press **[STOP ■]** or **[PAUSE II]**. Then, press **[DUBBING VCR > DVD]** on the front panel. The dubbing will start from there to the end.

- If there is not enough space left on the disc, the prohibited icon "⊘" will appear and the dubbing will not be started.

### Method 2 (HDD to DVD):

Start the playback of the title you want to dub. Press **[DUBBING]** or **[DUBBING HDD > DVD]** on the front panel. The dubbing will start from the beginning of the title to the end.

### Method 3 (HDD to DVD):

If you press **[DUBBING HDD > DVD]** on the front panel in stop mode without selecting any title, the unit will start dubbing the last title in the Original List or the Playlist. It will start dubbing the title in the Original List if the Original List was the last selected list. It will start dubbing the title in the Playlist if the Playlist was the last selected list.

- If the title was in the resume stop mode, the dubbing will start from the beginning to the end of the resume stopped title.
- If the title was in the regular stop mode, the dubbing will start from the beginning to the end of the last title.
- If there is not enough space left on the disc, the prohibited icon "⊘" will appear and the dubbing will not be started.

Introduction

Connections

Basic Setup

Recording

Playback

Editing

Function Setup

VCR Functions

Others

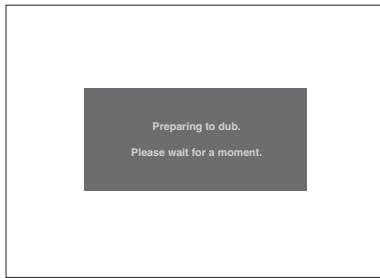

[HDD to DVD dubbing]

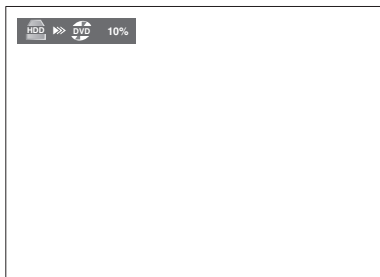

[Videotape to DVD dubbing]



**2 The dubbing will stop automatically when it reaches the end of the title or videotape. If you want to stop the dubbing manually, follow the instructions below.**

**To stop the dubbing in progress:**

- 1 Press **[DUBBING]** for 4 seconds. Confirmation window will appear.
- 2 Select "Yes" using **[Cursor ◀ / ▶]**, then press **[ENTER]**.
- 3 Press **[ENTER]** to exit.

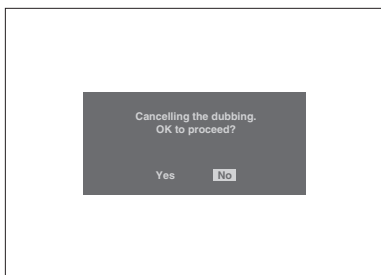

**Note**

**[HDD to DVD dubbing]**

- You cannot switch the device mode except between HDD and VCR during HDD to DVD dubbing. No limitation for High Speed Dubbing.

**[Videotape to DVD dubbing]**

- When dubbing starts, the video image may be distorted because of the Digital Tracking function. This is not a malfunction. Play the videotape until the image clears up and then start the dubbing.
- Playback audio is determined by the setting you make in "Selecting the Sound Mode" section on page 102.
- Dubbing takes as much time as the playback does.
- You cannot switch the device mode except between HDD and DVD during videotape to DVD dubbing.
- If you want to watch the dubbed material, after the VCR to DVD dubbing, press **[DVD]** first then press **[PLAY ▶]**.

## Dubbing from HDD / DVD to Videotape

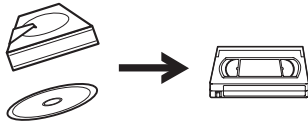

You can copy the contents of the HDD / DVD to a videotape.

### Limitations:

- If a copy control signal is detected during dubbing, the dubbing will be stopped.

### Limitation (DVD to VCR):

- The contents of DVDs made on this unit can be dubbed. Any other discs cannot be dubbed.

### Preparing for dubbing:

- Insert a recordable videotape with a record tab intact.
- Make sure that the videotape has enough space to record the contents.
- If you are dubbing a title contains both main and sub audio, set the audio type you want to dub. To set the audio type, refer to "Switching Audio Soundtrack" on page 75. If you want to dub both main and sub audio, select "Main / Sub" when you set the audio type.

### Preparing for dubbing (DVD to VCR):

- If you are dubbing from a disc, insert a disc to be dubbed.

## 1 Press [DUBBING].

The Dubbing Direction and the Rec Mode Menu will appear.

## 2 For HDD to VCR dubbing: Select "HDD → VCR Dubbing" using [Cursor ▲ / ▼], then press [ENTER].

**For DVD to VCR dubbing:  
Select "DVD → VCR Dubbing" using [Cursor ▲ / ▼], then press [ENTER].**

Dubbing Top Menu will appear.

Example: HDD → VCR

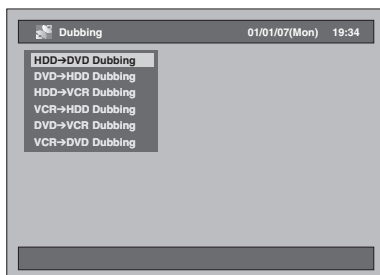

## 3 Select "Add to Title".

- If "Add to Title" is already highlighted, press [ENTER].
- If one of the Dubbing Titles is highlighted, select "Add to Title" using [Cursor ▲ / ▼], then press [ENTER].
- To switch Original and Playlist, press [MODE] before you press [ENTER].

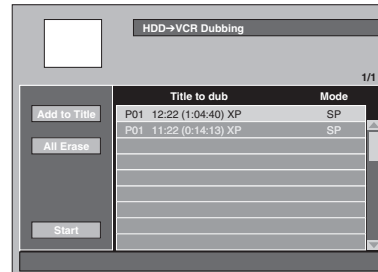

- If you have registered any dubbing before, they will be listed in the Dubbing Title List.
- Contents in the Dubbing Title List will be deleted when you select the different dubbing direction.

### To sort the titles:

- 1 Press [ENTER] anywhere in the Title List.
- 2 Select "Title Sorting" using [Cursor ▲ / ▼], then press [ENTER].
- 3 Select the desired sort type and press [ENTER].

## 4 Select a desired title using [Cursor ▲ / ▼], then press [ENTER].

## 5 Select "Register" using [Cursor ▲ / ▼], then press [ENTER].

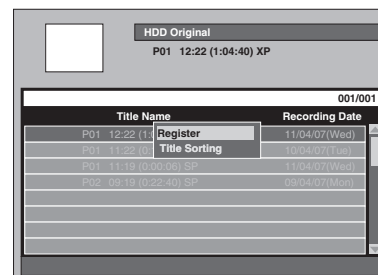

The selected title is added to the Dubbing Title List.

- Contents in the Dubbing Title List will be deleted when you exit by pressing [I/O] ON / STANDBY or select the different dubbing direction.

Introduction

Connections

Basic Setup

Recording

Playback

Editing

Function Setup

VCR Functions

Others

## 6 Repeat the steps 3 to 5 until you select all programmes to be dubbed.

### To delete a title:

- 1 Select a title using [Cursor ▲ / ▼], then press [ENTER].
- 2 Select "Delete" using [Cursor ▲ / ▼], then press [ENTER].
- 3 Select "Yes" using [Cursor ◀ / ▶], then press [ENTER].

### To move a title:

- 1 Select a title using [Cursor ▲ / ▼], then press [ENTER].
- 2 Select "Move" using [Cursor ▲ / ▼], then press [ENTER].
- 3 Enter a desired insert point using [Cursor ▲ / ▼], then press [ENTER].

## 7 After registering all the programmes you want, select "Start" using [Cursor ▲ / ▼ / ▶ / ◀], then press [ENTER].

## 8 Select a desired Rec Mode using [Cursor ◀ / ▶], then press [ENTER].



- Depending on the dubbing direction or the recording format type, the available Rec Mode will vary.

## 9 Select "Yes" using [Cursor ◀ / ▶], then press [ENTER].

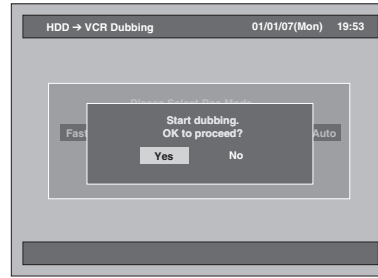

- Dubbing will start.

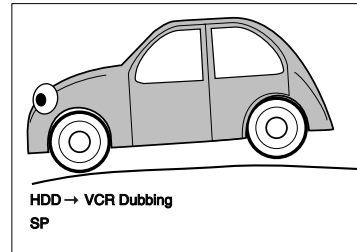

- It may take awhile to prepare for the dubbing.

### To stop the dubbing in progress:

Press [DUBBING] for 4 seconds.

### Note

- You cannot change the device mode between VCR and HDD / DVD during the HDD / DVD to VCR dubbing.
- If you want to watch the duplicated material, after the DVD to VCR duplication, press [VCR] first then press [PLAY ▶].

## Bi-directional Dubbing between HDD and DVD

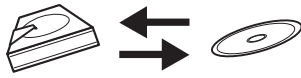

The basic procedure to make a dubbing from the Setup Menu is as follows:

- 1 Select dubbing direction.
- 2 Register titles in the Dubbing Title List.
- 3 Edit the Dubbing Title List as you prefer.
- 4 Select Rec Mode.
- 5 Start dubbing.

When you dub a title has bilingual audio to Video mode DVD-RW / R and DVD+RW / R, select an appropriate audio format in the "Bilingual Recording Audio" menu on page 40.

- 1** Insert a recordable disc when dubbing from HDD to DVD.  
Insert a disc to be dubbed when dubbing from DVD to HDD.
- 2** Press [DUBBING].  
The Dubbing Direction will appear.
- 3** For HDD to DVD dubbing:  
Select "HDD → DVD Dubbing" using [Cursor ▲ / ▼], then press [ENTER].  
For DVD to HDD dubbing:  
Select "DVD → HDD Dubbing" using [Cursor ▲ / ▼], then press [ENTER].  
"DVD → HDD Dubbing" is not available when the +VR mode and Video mode disc recorded by other units is inserted.

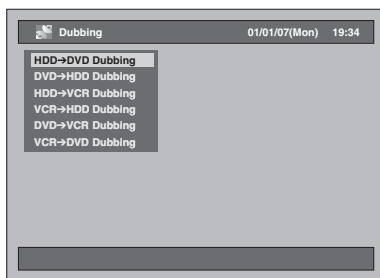

- 4** Select "Add to Title".
  - If "Add to Title" is already highlighted, press [ENTER].
  - If one of the Dubbing Titles is highlighted, select "Add to Title" using [Cursor ▲ / ▼ / ◀ / ▶], then press [ENTER].
  - To switch Original and Playlist, press [MODE] before you press [ENTER].

Example: HDD → DVD

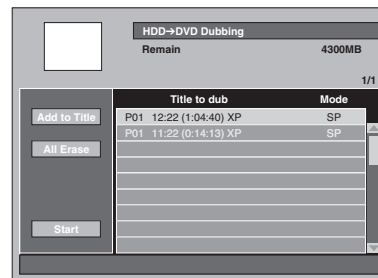

- If you have registered any dubbing before, they will be listed in the Dubbing Title List.

To sort the titles:

- 1 Press [ENTER] anywhere in the Title List.
- 2 Select "Title Sorting".
- 3 Select the desired sort type and press [ENTER].

- 5** Select a desired title using [Cursor ▲ / ▼], then press [ENTER].
- 6** Select "Register" using [Cursor ▲ / ▼], then press [ENTER].

Example: HDD Original

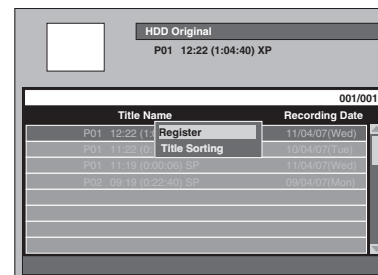

The selected title is added to the Dubbing Title List.

- Contents in the Dubbing Title List will be deleted when you exit by pressing [I/⏻ ON / STANDBY] or select the different dubbing direction.

- 7** Repeat steps 4 to 6 until you register all the programmes to be dubbed.

To delete a title:

- 1 Select a title using [Cursor ▲ / ▼], then press [ENTER].
- 2 Select "Delete" using [Cursor ▲ / ▼], then press [ENTER].
- 3 Select "Yes" using [Cursor ◀ / ▶], then press [ENTER].

Introduction

Connections

Basic Setup

Recording

Playback

Editing

Function Setup

VCR Functions

Others

**To move a title:**

- 1 Select a title using [Cursor ▲ / ▼], then press [ENTER].
- 2 Select "Move" using [Cursor ▲ / ▼], then press [ENTER].
- 3 Select a desired insert point using [Cursor ▲ / ▼], then press [ENTER].

**To change the title name:**

- 1 Select a title using [Cursor ▲ / ▼], then press [ENTER].
- 2 Select "Change Name" using [Cursor ▲ / ▼], then press [ENTER].
- 3 Enter a desired name. Refer to "Guide to Edit Title Name" on page 85.

**To erase all the titles in the Dubbing Title List:**

- 1 Select "All Erase" using [Cursor ▲ / ▼ / ◀ / ▶], then press [ENTER].
- 2 Select "Yes" using [Cursor ◀ / ▶], then press [ENTER].

- 8 After registering all the programmes you want, select "Start" using [Cursor ▲ / ▼ / ◀ / ▶], then press [ENTER].**

- 9 Select a desired Rec Mode using [Cursor ◀ / ▶], then press [ENTER].**



- Depending on the dubbing direction or the recording format type, the available Rec Mode will vary.
- Select "Fast" if you want to perform the "Fast Dubbing" (see "Fast Dubbing" on page 48 for more details).
- Fast Dubbing is prohibited in this unit if a title has been recorded using the NTSC system.
- "Fast" is not available when dubbing from a Video mode disc to the HDD.

**When "Auto" is selected (Just Dubbing):**

- Basically the Rec Mode is set to "Fast", but it will be changed automatically under the conditions listed below;
  - HDD to DVD dubbing; the Rec Mode will automatically be adjusted so the titles will fit nicely in the remaining space of the disc when there is not enough space in the disc.
  - DVD to HDD dubbing; the Rec Mode will automatically be adjusted for the titles to fit a 4.7 GB DVD.

- 10 Select "Yes" using [Cursor ◀ / ▶], then press [ENTER].**

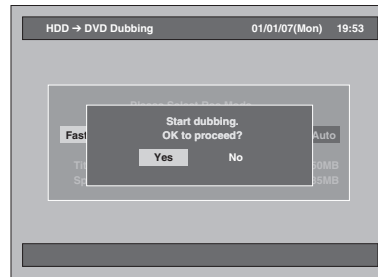

Dubbing will start.

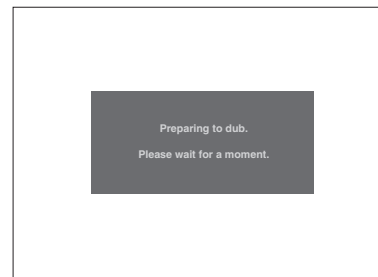

- It may take awhile to prepare for the dubbing.
- During Fast Dubbing, the playback picture will not appear.
- When dubbing is completed, completion message will be displayed on the screen for a few seconds.

**To stop the dubbing in progress:**

- 1 Press [DUBBING] for 4 seconds. Confirmation window will appear.
- 2 Select "Yes" using [Cursor ◀ / ▶], then press [ENTER].
- 3 Press [ENTER] to exit.

## Dubbing from Videotape to HDD / DVD

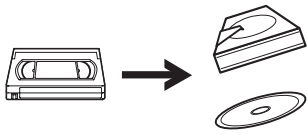

You can copy the contents of a videotape to HDD or DVD disc.

### Limitation:

- If a copy control signal is detected during dubbing, the dubbing will be stopped.

### Limitations (VCR to HDD):

- With VCR to HDD dubbing, the unit recognise the HDD's remaining time as the dubbing duration. The maximum possible duration is 10 hours and 30 minutes.

### Limitations (VCR to DVD):

- You cannot dub to the finalised Video mode DVDs.
- You cannot dub to the protected VR mode DVDs.
- Copy-once programmes which are recorded directly from the TV can be dubbed to the HDD and CPRM compatible VR mode DVD-RW.
- Copy-once programmes which are copied from the HDD / DVD to a videotape cannot be dubbed further from the videotape to the HDD / DVD.
- With VCR to DVD dubbing, the unit recognise DVD's remaining time as the dubbing duration although the actual dubbing will end when the videotape ends.

### Preparing for dubbing:

- Insert a videotape to be dubbed.

### Preparing for dubbing (VCR to HDD):

- Make sure there is enough space on the HDD.

### Preparing for dubbing (VCR to DVD):

- Insert a recordable DVD. (See pages 34 to 37.)
- Make sure there is enough space on the DVD.

Press [VCR] first.

- 1 Press [PLAY ►] to start playback of the videotape, and press [STOP ■] when it reaches the point where you want to start dubbing.**
- 2 Press [DUBBING].**  
The Dubbing Direction will appear.
- 3 For HDD dubbing:**  
Select "VCR → HDD Dubbing" using [Cursor ▲ / ▼], then press [ENTER].  
**For DVD dubbing:**  
Select "VCR → DVD Dubbing" using [Cursor ▲ / ▼], then press [ENTER].

Example: VCR → HDD

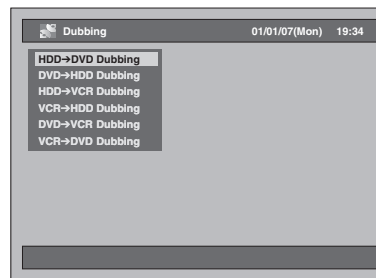

- 4 Select a desired Rec Mode using [Cursor ◀ / ▶], then press [ENTER].**

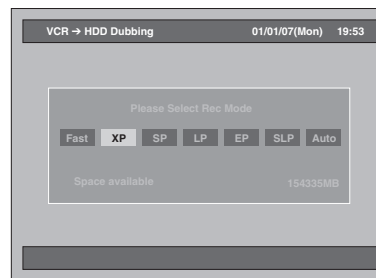

Confirmation window will appear.

- 5 Select "Yes" using [Cursor ◀ / ▶], then press [ENTER].**

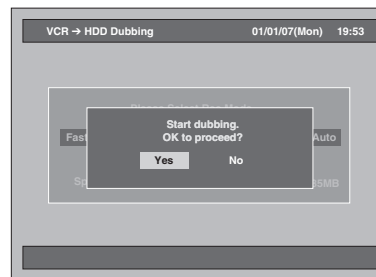

Dubbing will start.

When the dubbing is completed, completion message will be displayed on the screen for a few seconds.

### To stop the dubbing in progress:

- 1 Press [DUBBING] for 4 seconds. Confirmation window will appear.
- 2 Select "Yes" using [Cursor ◀ / ▶], then press [ENTER].
- 3 Press [ENTER] to exit.

### Note

- The device mode change is available only between HDD and DVD during the videotape to the HDD / DVD dubbing.
- After starting dubbing, the picture may be distorted because of the digital tracking function. This is not a malfunction. Be advised to play back the videotape until the picture is stabilised, then set the starting point at which you wish to start recording, and start dubbing.
- Playback audio is determined by the setting you make in the "Selecting the Sound Mode" section on page 102.

Introduction

Connections

Basic Setup

Recording

Playback

Editing

Function Setup

VCR Functions

Others

## Setting for External Connection (AV3)

Connect the external equipment using either the input jacks, AV1(TV) (Rear), AV2(DECODER) (Rear) or AV3 (Front). However, for AV3 jacks, you have to select S-VIDEO input or VIDEO input jacks depending on the connected devices. Use a commercially available Scart, S-Video or Video cable and an Audio cable for this connection.

- 1 Press [SETUP] in stop mode.  
Setup Menu will appear.
- 2 Select "Initial Setting" using [Cursor ▲ / ▼], then press [ENTER].

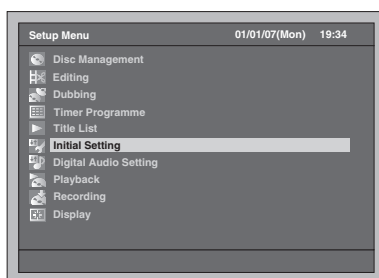

- 3 Select "Select Video" using [Cursor ▲ / ▼], then press [ENTER].

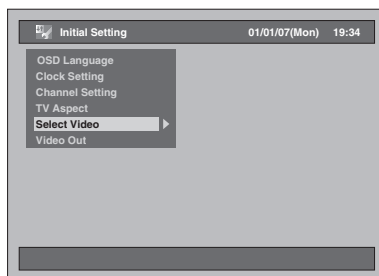

- 4 Select the video input type you use, "Video In" or "S-Video In", using [Cursor ▲ / ▼], then press [ENTER].

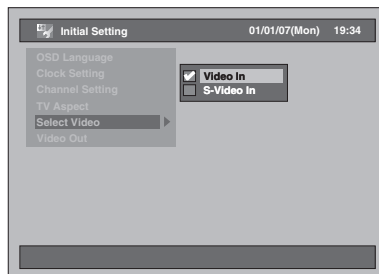

The selected setting will be checked and activated.

- The default setting is "Video In".

- 5 Press [SETUP] to exit.

## Dubbing from the External Devices



When you dub a title has bilingual audio to Video mode DVD-RW / R and +VR mode DVD+RW / R, select an appropriate audio format in the "Bilingual Recording Audio" menu on page 40.

- 1 Turn on the TV. Select the appropriate external input channel.  
(See pages 23 to 24.)
- 2 Select the media.  
**Dubbing to HDD:**  
Press [HDD] first.  
**Dubbing to DVD:**  
Press [DVD] first and insert a disc.  
• It may take awhile to load the disc.  
**Dubbing to a videotape:**  
Press [VCR] and insert a videotape.
- 3 Select the appropriate external input channel of this unit by pressing [INPUT SELECT ]. You also can use [PROG. ^ / v].  
• If you are using the jacks on the front, set the channel to "AV3".  
• If you are using the jacks on the rear, set the channel to "AV1" and "AV2".
- 4 Select a Rec Mode by pressing [REC MODE].  
Refer to "Rec Mode" on page 35 for HDD / DVD or page 100 for VCR.
- 5 Press [● REC] (of the dubbing device) on this unit to start dubbing.
- 6 Press the PLAY button on the external device to dub from.
- 7 **For HDD or DVD:**  
Press [STOP ] to stop dubbing.  
• This operation may take awhile to be completed. Then stop the external device.  
**For VCR:**  
Press [STOP / EJECT ] to stop dubbing.  
Then stop the external device.

### Note

- To avoid mistakes, it is recommended to use the buttons on the front panel to operate.
- Read also the instructions for the external device thoroughly.
- If you want to monitor the programme that you are recording, make sure the device such as a Satellite Box is powered off or press [DISPLAY] when it is connected to AV2.
- NTSC dubbing is prohibited in this unit.



## Finalising a Disc

In order to play back discs recorded in this unit on other player, you must finalise the discs.

- Although finalisation is recommended, you may be able to play the VR mode and +VR mode discs on other unit without finalising. With regard to the Video mode discs, you MUST finalise them before playing them back on other player.
- After DVD-R / +R discs are finalised, additional recording, editing and undo finalisation are impossible.
- For DVD-R, Video mode DVD-RW, +VR mode DVD+RW / R discs, a DVD menu is created automatically after finalising discs, and title list for the discs will no longer be available.

### Finalise



You must first finalise the disc before playing it back on other unit.

- 1 Press [SETUP] in stop mode.**  
Setup Menu will appear.
- 2 Select “Disc Management” using [Cursor ▲ / ▼], then press [ENTER].**

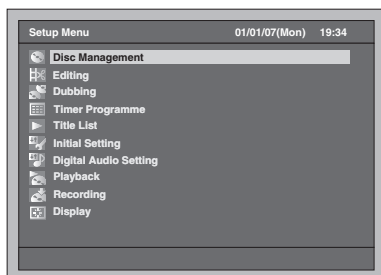

- 3 Select “DVD Disc Control” using [Cursor ▲ / ▼], then press [ENTER].**
- 4 Select “Finalise” using [Cursor ▲ / ▼], then press [ENTER].**

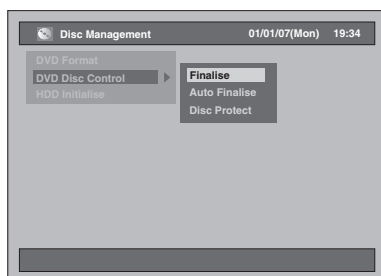

- 5 Select “Yes” using [Cursor ◀ / ▶], then press [ENTER].**

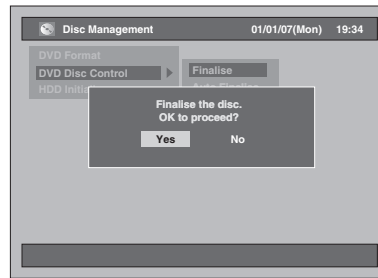

- If the disc has already been finalised, “Undo Finalise” will be listed in the menu instead of “Finalise” (DVD-RW and DVD+RW). To Undo the finalisation of the disc, select “Undo Finalise” and press [ENTER].

Finalising will start.

- This operation may take awhile to be completed.

#### Note

- You cannot cancel finalising the disc once it has started.
- After the finalisation of DVD+RW discs, Empty Title will appear on the last of Title List.

Introduction

Connections

Basic Setup

Recording

Playback

Editing

Function Setup

VCR Functions

Others

## Auto Finalise



You can finalise discs automatically when the disc space runs out if you set this in the Setup Menu.

- 1 Press **[SETUP]** in stop mode.  
Setup Menu will appear.
- 2 Select “Disc Management” using **[Cursor ▲ / ▼]**, then press **[ENTER]**.

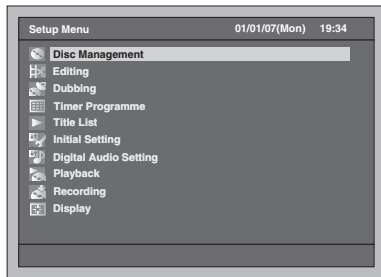

- 3 Select “DVD Disc Control” using **[Cursor ▲ / ▼]**, then press **[ENTER]**.
- 4 Select “Auto Finalise” using **[Cursor ▲ / ▼]**, then press **[ENTER]**.

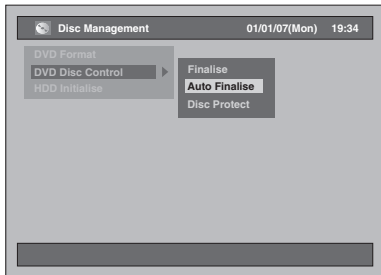

- 5 Select “On” using **[Cursor ▲ / ▼]**, then press **[ENTER]**.

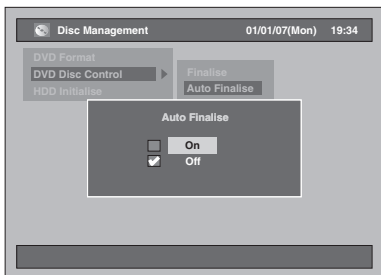

The unit automatically finalises the disc when the disc space runs out.

Your setting is activated.

- The default setting is “Off”.

- 6 Press **[SETUP]** to exit.

### Note

- Auto Finalise is not available while the Setup Menu is displayed.

## Setting Disc Protection



You can protect a disc from the accidental overwriting, editing or erasing.

- 1 Press **[SETUP]** in stop mode.  
Setup Menu will appear.
- 2 Select “Disc Management” using **[Cursor ▲ / ▼]**, then press **[ENTER]**.



- 3 Select “DVD Disc Control” using **[Cursor ▲ / ▼]**, then press **[ENTER]**.

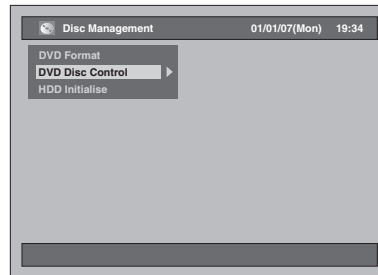

- 4 Select “Disc Protect” using **[Cursor ▲ / ▼]**, then press **[ENTER]**.

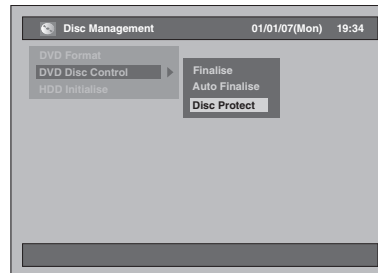

- If the disc has already been protected, “Disc Undo Protect” will be listed in the menu instead of “Disc Protect”.

**5** Select “Yes” using [Cursor ◀/▶], then press [ENTER].

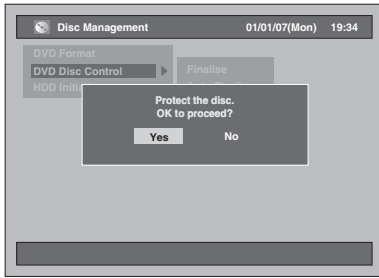

The disc is protected.  
• The default setting is “No”.

**6** Press [SETUP] to exit.

**Note**

- Disc Protect is available for VR mode DVD-RW discs and +VR mode DVD+RW / R discs.

Introduction

Connections

Basic Setup

**Recording**

Playback

Editing

Function Setup

VCR Functions

Others

# Playback

## Information on Playback

Read the following information before you play back a DVD.

### Playable Discs

You can play back all the discs listed on the right. Before attempting to play back a DVD, make sure it meets the requirements for Region Codes and Colour Systems as described in this section. Discs that bear any of the logos shown below will be played back correctly in this unit. Other disc types are not guaranteed to be played back.

### Colour Systems

DVDs are recorded using different colour systems throughout the world. The most common colour system, used primarily in the U.K. and other EU countries, is PAL.

This unit uses the PAL system. However, it is also possible to play back DVDs using other colour systems, such as NTSC.

### Region Codes

This unit has been designed to play back DVDs for Region Two (2). It is only possible to play back DVDs in this unit that are labelled for Region 2 or for ALL regions. You cannot play back DVDs that are labelled for other regions. Look for DVDs that bear either of the symbols shown below. If these region symbols do not appear on your DVD, you cannot play back the DVD in this unit.



The number inside the globe refers to region of the world.

A DVD labelled for a specific region can only be played back in the unit with the same region code.

Disc	Logo
DVD-Video	
DVD-RW (VIDEO/VR mode, DivX® files)	
DVD-R (VIDEO mode, DivX® files)	
DVD+RW (+VR mode, DivX® files)	
DVD+R (+VR mode, DivX® files)	
CD-DA (AUDIO CD)	
VCD (VIDEO CD)	
CD-RW (CD-DA FORMAT, MP3, JPEG, DivX® files)	
CD-R (CD-DA FORMAT, MP3, JPEG, DivX® files)	

**DVD** is a trademark of DVD Format/Logo Licensing Corporation.

## Basic Playback

### Hint for HDD / DVD Playback

The contents of a HDD / DVD are generally divided into titles. Titles are sometimes further subdivided into chapters.

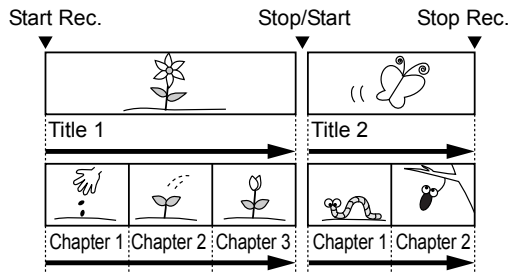

### Direct Playback



If you are playing the HDD, press [HDD] first.  
If you are playing a disc, press [DVD] first.

- 1 Turn on the TV. Select the appropriate external input channel.  
(See pages 23 to 24.)
  - If you are playing the HDD, proceed to step 5.
- 2 Press [OPEN / CLOSE ▲] to open the disc tray.
- 3 Place the disc on the disc tray with its label facing up. Be sure to align the disc with the disc tray guide.

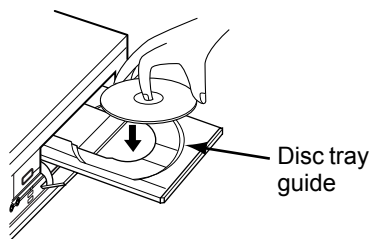

- 4 Press [OPEN / CLOSE ▲] to close the disc tray.
- 5 Press [PLAY ►] to start playback.  
Playback will start.
  - Depending on the media, the playback may start from a resume point. (See page 69.)
  - If you are playing back a DVD-Video, a Disc Menu may appear. See page 67 for more details about the Disc Menu.
- 6 Press [STOP ■] to stop playback.

### Note

- Some discs may start playback automatically.
- If no resume point is set when you stop HDD or DVD playback, it will start from beginning of the last title.
- If playback and recording are in progress at the same time, select the appropriate device by pressing [HDD] or [DVD] before you press [PAUSE II] or [STOP ■] to pause or stop the operation.

### Playback from the Title List Menu



(Not available for the DVD-Videos, the finalised Video mode DVDs, or the Video mode discs made on other unit)

If you are playing the HDD, press [HDD] first.  
If you are playing a disc, press [DVD] first.

- 1 Follow steps 1 to 4 in “Direct Playback” on the left.
  - If you are playing the HDD, follow step 2.
- 2 Press [TOP MENU].  
Title List Menu will appear.  
Press [MODE] to switch Original / Playlist if necessary.
  - To exit the Title List Menu, press [RETURN] or [SETUP] twice.
- 3 Select a desired title using [Cursor ▲ / ▼], then press [ENTER].
  - Use [Cursor ▲ / ▼] to move among the titles one by one, and use [SKIP ►►] or [SKIP ◀◀] to jump to the next / previous Title List page.
- 4 Select “Play” using [Cursor ▲ / ▼]. Then press [ENTER].  
Playback will start. For HDD, if any resume point has been set, the playback will start from the resume point.
- 5 Press [STOP ■] to stop playback.

### Note

- Title edited by hidden-title on other units cannot be played back although the title name is displayed on the Top Menu. If you play the hidden-title, the next playable title will be played back.

## Changing the Order of the Title Display



You can display the titles by order of name, date or unplayed (HDD only).

Press [DVD] or [HDD].

- 1** Press [TOP MENU] to display the Title List Menu, then press [ENTER].
- 2** Select "Title Sorting" using [Cursor ▲ / ▼]. Then press [ENTER].
- 3** Select the desired setting using [Cursor ▲ / ▼], then press [ENTER].

### Note

- When the titles are sorted and displayed by the names, folders may be created for each names. In order to display the contents of the files, press [ENTER] on desired files, and select "Contents Display" using [Cursor ▲ / ▼] and then press [ENTER].
- The folders created for the title sorted by name will disappear if you sort the titles by date or by unplayed titles.
- This feature is not available for finalised Video mode DVDs and +VR mode DVDs.

## Playback from the DVD Menu



With finalised Video mode DVDs or the Video mode DVDs and +VR mode DVDs made on other units, a DVD Menu may be appeared instead of the Title List. DVD Menus are created automatically when you finalise a Video mode disc. With such discs, Title List is no longer available.

Follow the steps below to play back a disc using the DVD Menu.

Press [DVD] first.

- 1** Insert a disc.

DVD Menu may appear automatically. Otherwise, press [TOP MENU] to call up the DVD Menu.

Example: DVD-R



- 2** Select a desired title using [Cursor ▲ / ▼ / ◀ / ▶], then press [PLAY ▶] or [ENTER].

Playback will start.

- Select [Prev.] or [Fwd.] to jump to the next / previous Title List page.
- Select [QUIT], then press [ENTER] to exit. If you call up the DVD menu during DVD playback, the playback resume when you select [QUIT].

- 3** Press [STOP ■] to stop playback.

### Note

- DVD Menu and operation may vary depending on the discs.

## Playing Back a Video CD



- 1** Follow steps 1 to 4 in "Direct Playback" on page 61.
- 2** Press [PLAY ▶] to start playback.  
Playback will start.  
• If a menu appears, see page 68 for details.
- 3** Press [STOP ■] to stop playback.

## Playing Back an MP3



Press [DVD] first.

- 1 Press [TOP MENU] to call up the MP3 List after a disc is inserted.

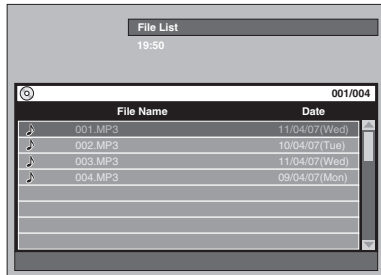

- To exit the MP3 list, press [TOP MENU] or [RETURN].
- If there are more than one page of MP3 list, press [SKIP ►►] to jump to the next page, or press [SKIP ◄◄] to jump to the previous page.

- 2 Press [Cursor ▲ / ▼] to select the desired folder (group) or file (track), then press [ENTER].

**If a file is selected:**  
Playback will start.

- If a folder is selected:**  
The files in the folder will appear.  
Press [Cursor ▲ / ▼] to select a file or folder you want, then press [ENTER].
- Press [ENTER] to move to any lower folders.
  - Press [RETURN] to move back to the folder above.

- 3 Press [STOP ■] to stop playback.

**Hints for MP3 files:**

- Folders are known as Groups, Files are known as Tracks.
- Folders are shown with the icon.
- The system can recognise up to 255 groups (or folders) per disc, and up to 999 tracks (or files) per disc.
- The name of group and track can be displayed up to 32 characters. Unrecognisable characters will be replaced with asterisks (\*).
- Unplayable groups and tracks may be displayed depending on the recording conditions.
- For MP3 file recorded in Variable Bit Rate (VBR), the unit may not display the actual elapsed time.

**It is recommended that files to be played back in this unit are recorded under the following specifications:**  
[MP3]

- Sampling frequency: 44.1 kHz or 48 kHz
- Constant Bit Rate: 112 kbps to 320 kbps

### Note

- MP3 files cannot be recorded as digital sound using an MD or DAT deck.
- Files with extensions other than “.mp3 (MP3)” will not be listed in the File List.
- Some folders or files listed in the File List may be unplayable due to their recording status.
- The File List displays only up to 8 folder and file names.

## Playing Back a JPEG



Press [DVD] first.

- 1 Press [TOP MENU] to call up the JPEG List after a disc is inserted.

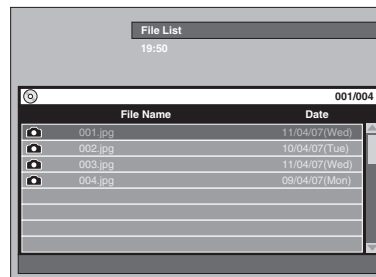

- To exit the JPEG list, press [TOP MENU] or [RETURN].
- If there are more than one page of JPEG list, press [SKIP ►►] to jump to the next page, or press [SKIP ◄◄] to jump to the previous page.

- 2 Press [Cursor ▲ / ▼] to select the desired folder (group) or file (track), then press [ENTER].

**If a file is selected:**  
Playback will start.

- If a folder is selected:**  
The files in the folder will appear.  
Press [Cursor ▲ / ▼] to select a file or folder you want, then press [ENTER].
- Press [ENTER] to move to any lower folders.
  - Press [RETURN] to move back to the folder above.

- 3 Press [STOP ■] to stop playback.

**Notes on JPEG:**

After the file is displayed for 5 seconds or 10 seconds (see “Slide Show” on page 74), the display will move to the next file.

During JPEG playback, press [Cursor ►] or [Cursor ◀] to rotate a picture 90 degrees clockwise or counterclockwise respectively. (Not available when the display menu appears.)

Files with extensions other than “.jpg/.jpeg (JPEG)” will not be listed in the File List.

**[JPEG] Size of picture**

- Upper limit: 6300 x 5100 dots
- Lower limit: 32 x 32 dots
- Capacity limit: less than 12 MB
- High resolution or large-size JPEG files take a few moments to be displayed.
- It is impossible to play back progressive JPEGs (JPEG files saved in progressive format) on this unit.
- It is impossible to play back JPEG files of 12 MB or more.
- The name of group and track can be displayed up to 32 characters. Unrecognisable characters will be replaced with asterisks (\*).

**Playing Back a DivX®**

- 1 In stop mode, press [TOP MENU] to call up the DivX® List.**

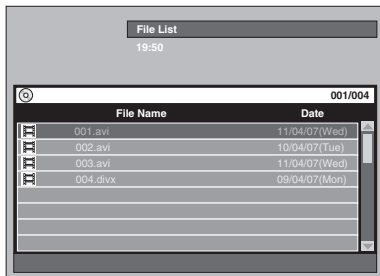

To exit the DivX® list, press [TOP MENU] or [RETURN].

- 2 Press [Cursor ▲ / ▼] to select the desired folder (group) or file (track), then press [ENTER].**

**If a file is selected:**  
Playback will start.

**If a folder is selected:**  
The files in the folder will appear.  
Press [Cursor ▲ / ▼] to select the file or folder you want, then press [ENTER].

- Press [ENTER] to move to any lower folders.
- Press [RETURN] to move back to the folder above.

**It is recommended that files to be played back in this unit are recorded under the following specifications:**

**[DivX®]**

- Official DivX® Certified product
- Plays all versions of DivX® video (including DivX® 6) with standard playback of DivX® media files.
- Maximum size of image : 720 x 480 @30 fps  
720 x 576 @25 fps
- Sampling frequency of audio : 8 kHz - 48 kHz
- Audio type : MPEG1 audio layer2, MP3 (MPEG1, 2, 2.5 audio layer3), Dolby Digital

**Hint for the purchased or rental official DivX® Certified product**

- When you purchased or rental a DivX® file through the DivX® Video-On-Demand (VOD) services, a registration code is required every time you get the new file from the DivX® VOD services. Refer to "DivX® VOD" on page 66.
- Some DivX® VOD files are restricted with the limited playable times (you cannot play them back beyond the limit). If your DivX® VOD file has such limit, confirmation window will appear.  
Use [Cursor ◀ / ▶] to select "Yes" if you want to play back the file, or to select "No" if you do not wish to play it back. Then press [ENTER].

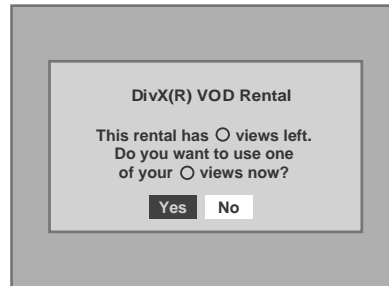

- You cannot play back the DivX® VOD files, of which rental period has been expired. In such case, press [TOP MENU] and select other files that can be played back.

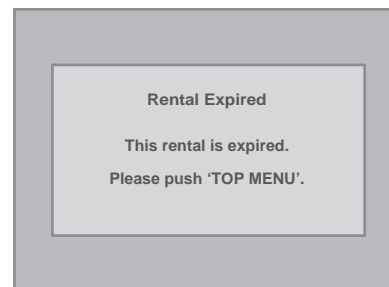
**Hint**

- DivX® is a codec (compression/decompression) that can compress images to a very small amount of data. The software can compress video data from almost any sources to the size that can be sent on the Internet without compromising visual quality of the images.
- A file with an extension of ".avi" and ".divx" is called a DivX® file. All files with the ".avi" extension are recognised as MPEG4.
- Files whose extension other than ".avi" and ".divx" will not be listed on the DivX® menu. However, unplayable groups or tracks may be displayed, depending on the recording conditions.
- Even if the file has an extension of either ".avi" and ".divx", this unit cannot play it back if it is recorded in the format other than DivX®.
- Folders are known as Groups; files are known as tracks.
- A maximum of 255 folders or 999 files may be recognised in one disc.
- Up to 8 hierarchies can be recognised in one folder. Files in the 9th or deeper hierarchies cannot be played back.



- The name of group and track can be displayed up to 32 characters. Unrecognisable characters will be replaced with asterisks (\*).
- You can play back the disc recorded in multi-session.
- Playback will be stopped if the File List is displayed during the playback.
- It may take awhile for audio and images to be output after you inserted a disc and pressed [PLAY ▶].
- When playing back the files recorded in high bit rates, the images can be interrupted in some occasions.
- Although DivX® logo has been obtained for this unit, it may not be able to play back some data, depending on the characteristics, bit rates, or audio format settings, etc.
- Use the software recognised by the DivX, Inc. when you make DivX® files.
- A DivX® file whose file size exceeds 2 GB cannot be played back.
- When using tools or utilities to make up DivX® files, read their instruction manual beforehand.
- Never use the MPEG4 tools when you make DivX® files. Otherwise, noise or disturbance of the picture and sound may be generated.
- If a large-sized DivX® file is selected, it may take awhile to start the playback (over 20 seconds sometimes).
- If DivX® files written on CD discs cannot be played back, rewrite them on a DVD disc and try to play back.
- For more information for DivX®, please visit <http://www.divx.com>.
- You cannot play back the DivX® VOD files obtained with different registration codes on this unit. Press [TOP MENU] and select other files that can be played back.

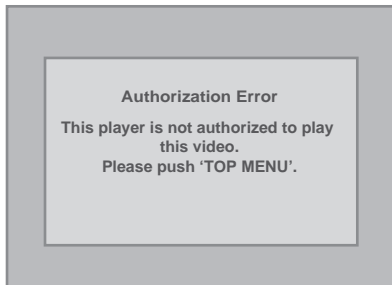

## DivX® Subtitle

The subtitle created by the user can be displayed during DivX® playback.

### 1 After the DivX® file is selected, the Subtitle List will appear.

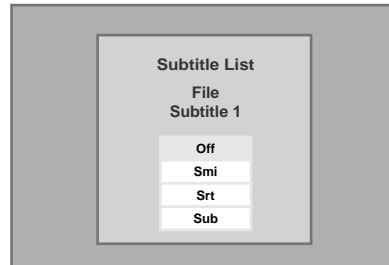

### 2 Select the desired setting using [Cursor ▲ / ▼], then press [ENTER]. DivX® with the subtitle starts playback. The subtitle will not be displayed when the setting is "Off".

- If there is more than one extension, the extension selection will appear in the Subtitle List.

#### Note

- DivX® subtitle can only be displayed according to the same name with an extension of the DivX® file name.
- Files whose extension is other than ".SMI", ".smi", ".SRT", ".srt", ".SUB" and ".sub" will not be listed in the Subtitle List.
- This unit cannot be recognised if the DivX® file and its subtitle file are not in the one folder.
- The subtitle may not be displayed if the file size is too large.
- To change the subtitle, refer to "DivX Subtitle" on page 95 if multiple subtitles are available.
- The subtitle cannot display if the on-screen information is displayed.
- If "DivX Subtitle" is set to "Off" in Playback menu, the Subtitle List will not be displayed even if you select a DivX® file with created subtitle. (Refer to "DivX Subtitle" on page 95.)
- Unrecognisable characters will be replaced with asterisks (\*).
- When the Status Display for Repeat, Search, Subtitle and Audio Sound Track setting or AV Select Menu is shown on the screen, the DivX® Subtitle will not be displayed.

Introduction

Connections

Basic Setup

Recording

Playback

Editing

Function Setup

VCR Functions

Others

## Playing Back Discs Contains Mixture of Different Type of Media

For playing back a CD-RW / R that contains mixture of different type of media (DivX®, MP3, JPEG etc.), you need to setup which media to play.

- 1 Press [SETUP] in stop mode.**  
Setup Menu will appear.
- 2 Select "Playback" using [Cursor ▲ / ▼], then press [ENTER].**

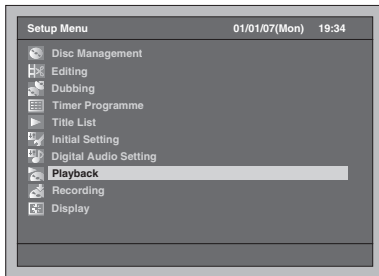

- 3 Select "Media Select" using [Cursor ▲ / ▼], then press [ENTER].**

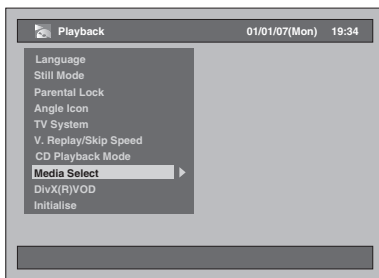

- 4 Select the media to play using [Cursor ▲ / ▼], then press [ENTER].**

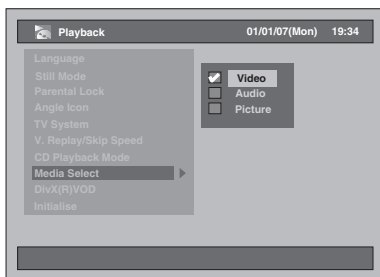

Video : To play DivX® files.  
Audio : To play MP3 files.  
Picture : To play JPEG files.

## DivX® VOD



This unit allows you to play back the files purchased or rented from DivX® Video-On-Demand (VOD) services. The files are available on the Internet. When you purchase or rent DivX® VOD files on the Internet, you will be asked to enter a registration code. This menu item provides you the registration code.

- 1 Follow the steps 1 to 2 on the left to display the Playback Menu.**
- 2 Select "DivX(R)VOD" using [Cursor ▲ / ▼], then press [ENTER].**

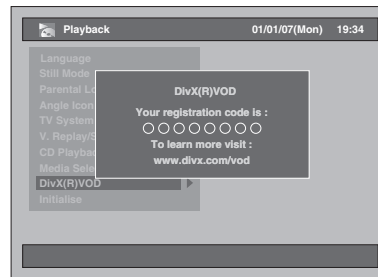

### Note

- One registration code is only valid for one DivX® VOD file.
- You must first download the file from the Internet and play it back on this unit before you are able to get another code.
- You must follow this step every time you purchase or rent a DivX® VOD file from the Internet.
- For more information for DivX®, please visit <http://www.divx.com/vod>.

## Playing Back Discs Using the Disc Menu



A DVD contains a disc menu, which lists the contents and enables you to customise playback. The menu may offer choices for subtitle languages, special features and chapter selection. Usually this information appears automatically when you start playback, but sometimes you need to press **[DISC MENU]** to display the menu.

Press **[DVD]** first.

### 1 Press **[DISC MENU]**.

Disc Menu will appear.  
If the feature is not available, "⊗" may appear on the TV screen.

### 2 Select an item using **[Cursor ▲ / ▼ / ◀ / ▶]**, then press **[ENTER]**.

Repeat this step until all the features you want are set up or to start playing back the disc from the menu. The following operations are available.

**[DISC MENU] button:**

Displays the DVD Menu, which will vary among discs, and may be same with the Title menu.

**[Cursor ▲ / ▼ / ◀ / ▶] buttons:**

Move the cursor from item to item on the screen.

**[ENTER] button:**

Selects the currently highlighted menu option.

**[the Number buttons]:**

Selects a numbered menu option (available on certain discs).

### 3 Press **[DISC MENU]** to exit the disc menu.

Depending on discs, pressing **[DISC MENU]** may not exit the disc menu.

#### Note

- Menus vary among discs. Refer to the information accompanying the disc for details.

## Playing Back Discs Using the Title Menu



Some DVDs have a title menu, which lists the titles available on the DVD. You can start playing back such discs at a specific title.

Press **[DVD]** first.

### 1 Press **[TOP MENU]**.

Title Menu will appear.  
If the feature is not available, "⊗" may appear on the TV screen.

### 2 Select a desired item using **[Cursor ▲ / ▼ / ◀ / ▶]**, then press **[ENTER]**.

The disc will start playing back at the title you selected. The following operations are available.

**[TOP MENU] button:**

Displays the DVD "Title Menu" which will vary between discs.

**[Cursor ▲ / ▼ / ◀ / ▶] buttons:**

Move the cursor from item to item on the screen.

**[ENTER] button:**

Selects the currently highlighted menu option.

**[the Number buttons]:**

Selects a numbered menu option (available on certain discs).

### 3 Press **[TOP MENU]** to exit.

#### Note

- **[TOP MENU]** will not be available for some DVDs.
- Menus vary among discs. Refer to the information accompanying the disc for details.

Introduction

Connections

Basic Setup

Recording

Playback

Editing

Function Setup

VCR Functions

Others

## PBC Function for Video CDs



This unit conforms to ver.1.1 and ver.2.0 of the Video CD standard playback control (PBC) function. This enables you to play back interactive software using menu screens. Refer to the information accompanying the Video CD.

Ver.1.1 (without PBC function): You can still enjoy playback of pictures and music from the CD.

Ver.2.0 (with PBC function): "Pbc" will appear on the Front Panel Display when playing back a Video CD with the PBC function.

### Hint

- When playing back Video CDs with the PBC function, "Pbc" is displayed instead of the playing back time and current track indications on the Front Panel Display.

### Note

- Some operations cannot be performed unless the function is cancelled either automatically or intentionally by you.
- Operations that are not available when the PBC function is set to "On" are indicated by the following symbol in this manual:



## Playing Back a Video CD Using the Menu



- 1** When playing back a Video CD with the PBC function, the menu will appear automatically.
- 2** Press [the Number buttons] to select the desired track.  
Playback will start at the selected track.
- 3** Press [RETURN] to go back to the menu.

## Cancelling and Recalling the PBC Function



Insert a Video CD.

- 1** Press [SETUP] in stop mode.  
Setup Menu will appear.

- 2** Select "Playback" using [Cursor ▲ / ▼], then press [ENTER].

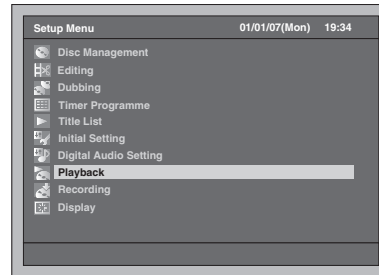

- 3** Select "CD Playback Mode" using [Cursor ▲ / ▼], then press [ENTER].

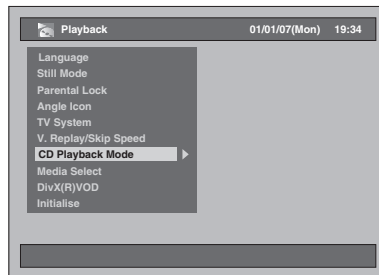

- 4** Select "PBC" using [Cursor ▲ / ▼], then press [ENTER].

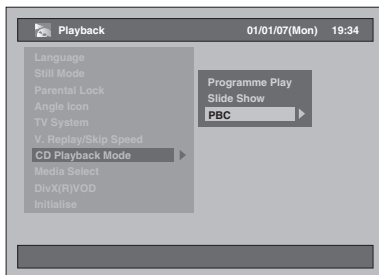

- 5** Select "Off" using [Cursor ▲ / ▼], then press [ENTER].

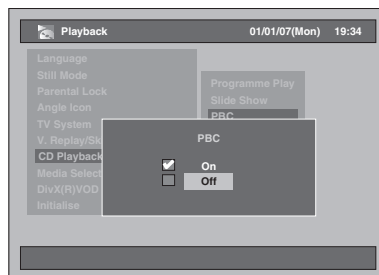

- 6** Press [SETUP] to exit.

To recall the PBC function, select "On" at step 5 above.

### Note

- The default setting of "PBC" is "On".
- The information of the setting "On" or "Off" is memorised even after the power is turned off or the disc tray is opened or closed.

## Special Playback

### Resume Playback



You can resume playback from the point where you stopped it before.

**If you are playing the HDD, press [HDD] first.**

**If you are playing a disc, press [DVD] first.**

#### 1 During playback, press [STOP ■].

Press [STOP ■] twice will cancel the Resume function.

#### 2 Press [PLAY ►].

In a few seconds, playback will resume from the point at which you stopped it before. Even if you turn off the unit, you can resume playback at the same point after the unit is powered on.

#### For HDD:

**You can set a resume point per every title.**

- If you play back from the Title List Menu, you can choose "Play". Otherwise the playback will start from the resume point of the last played title.
- Press [STOP ■] twice at step 1 if you do not want to set a resume point. In this case, next time you press [PLAY ►], the playback will start from the beginning of the last recorded title in the Title List.

#### For DVDs:

**You can set only one resume point per disc.**

- If a resume point is set, the playback will start from the resume point next time you press [PLAY ►].
- Press [STOP ■] twice at step 1 if you do not want to set a resume point. In this case, next time you press [PLAY ►], the playback will start from the beginning of the disc.

#### For Video CD, Audio CD, MP3, JPEG and DivX®:

**You can set only one resume point per disc.**

- If a resume point is set, the playback will start from the resume point next time you press [PLAY ►] if you are playing an Audio CD, DivX®, JPEG or Video CD with PBC off. As for the MP3 files, the resume playback will start from the beginning of the track last played.
- Press [STOP ■] twice at step 1 if you do not want to set a resume point. In this case, next time you press [PLAY ►], the playback will start from the beginning of the disc.

**To cancel the resume playback and start playing back the disc from the beginning:**

Press [STOP ■] while playback is stopped.

#### Note

- For Video CDs, if you turn "PBC" on using the setting menu, the resume function is cancelled.
- Resume point will be lost when you;
  - Open / Close the disc tray.

### Rapid Playback



Rapid Play function is available only during playback. Available only on discs recorded in the Dolby Digital format, Rapid Play plays back in a slightly faster/slower speed while keeping the sound quality just as normal playback.

#### 1 During playback, press [1.3x/0.8x PLAY].

- ▶ : Press [1.3x/0.8x PLAY] once during playback. Plays back approximately at 0.8 times of normal playback.
- ▶ : Press [1.3x/0.8x PLAY] twice during playback. Plays back approximately at 1.3 times of normal playback.
- ▶ : Press [1.3x/0.8x PLAY] thrice to play back in normal speed. No effects.

#### 2 Press [PLAY ►] to resume the normal playback.

#### Note

- Audio (language) setting cannot be changed while using this mode.
- This feature may not work at some point in a disc.
- Audio is PCM during Rapid play mode.
- When you select "PAL" in "TV System" (see page 97), this function is not available with discs recorded using the NTSC system.

Introduction

Connections

Basic Setup

Recording

Playback

Editing

Function Setup

VCR Functions

Others

## Fast Forward / Fast Reverse Playback

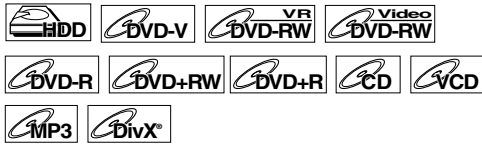

If you are playing the HDD, press [HDD] first.  
If you are playing a disc, press [DVD] first.

- 1 During playback, press [FWD / SLOW ►►] or [SLOW / REV ◀◀].

Each time you press [FWD / SLOW ►►] or [SLOW / REV ◀◀], the approximate speed will change as follows.

	Available Speed											
Speed (HDD/DVD)	64x	32x	16x	8x	2x	Normal speed	2x	8x	16x	32x	64x	
Speed (CD)	-	-	16x	-	-	Normal speed	-	-	16x	-	-	
Speed (VCD)	-	-	16x	8x	2x	Normal speed	2x	8x	16x	-	-	
Speed (MP3)	-	-	-	8x	-	Normal speed	-	8x	-	-	-	
Speed (DivX®)	-	-	16x	8x	2x	Normal speed	2x	8x	16x	-	-	
OSD indication	◀◀5	◀◀4	◀◀3	◀◀2	◀◀1		►►1	►►2	►►3	►►4	►►5	

- For Audio CDs, approximate speed is fixed at 16x with sound.
- For Video CDs, approximate forward speeds are 2x, 8x and 16x, and approximate reverse speeds are 2x, 8x and 16x.
- For MP3 files, approximate speed is fixed at 8x.
- For DivX® files, approximate forward speeds are 2x, 8x and 16x, and approximate reverse speeds are 2x, 8x and 16x.
- To return to play back at normal speed, press [PLAY ►].
- Picture quality of DivX® files in fast reverse is lower than that in fast forward.
- For some DivX® files, Fast forward/Fast reverse may not function.

### Note

- Fast forward or fast reverse playback across titles (for HDD/DVD) or tracks (for VCD/MP3/DivX®) is impossible.

## Slow Forward / Slow Reverse Playback



If you are playing the HDD, press [HDD] first.  
If you are playing a disc, press [DVD] first.

- 1 During playback, press [PAUSE ■], then press [FWD / SLOW ►►] or [SLOW / REV ◀◀].

Each time you press [FWD / SLOW ►►] or [SLOW / REV ◀◀], the approximate speed change as follows.

(The sound will remain muted.)

	Available Speed						
Speed (HDD/DVD)	-	1/8	1/2	Normal speed	1/4	1/16	-
OSD indication	-	◀1	◀2		►2	►1	-
Speed (VCD/DivX®)	-	-	-	Normal speed	1/2	1/4	1/8
OSD indication	-	-	-		►3	►2	►1

To return to normal playback, press [PLAY ►].

### Note

- For some DivX® files, Slow forward may not function.
- Only slow forward is available when playing back Video CDs and discs with DivX® files.

## Time Shift Playback



You can play back a title being recorded from the beginning while recording continues.

Press [HDD] first.

- 1 Press [PLAY ►] during recording.

Playback of the title you are recording will start from the beginning.

- Elapsed playback time will be displayed in the Front Panel Display.

- 2 To stop the playback, press [STOP ■] once.

- The Front Panel Display will switch back to show the elapsed recording time.

### Important

If you press [STOP ■] twice, it will stop the recording.

## Using the [TIME SLIP] button

With [TIME SLIP] button, even if you leave your couch while you are watching TV through this unit, you can come back and watch rest of the programme from right where you left at any convenient time with just one button.

### 1 While viewing a TV broadcast via this unit, press [TIME SLIP].

This unit start to record the TV broadcast.

### 2 Press [TIME SLIP] again.

Playback will start from the point you press [TIME SLIP] first while recording continues.

- While viewing the recorded content, you can pause and resume the playback by pressing [TIME SLIP].

### 3 To stop the recording, press [STOP ■] twice.

#### Note

- The contents you watched through the Time Slip playback will be stored in Title List.
- You cannot use the OTR function during Time shift playback.
- Before you start Time shift playback, make sure no resume point is set on other titles.
- You can no longer fast forward the playback when it comes to the points listed below:
  - XP mode : 15 seconds before the current recording point.
  - SP mode : 30 seconds before the current recording point.
  - LP mode : 60 seconds before the current recording point.
  - EP mode : 90 seconds before the current recording point.
  - SLP mode : 105 seconds before the current recording point.

## Simultaneous Playback and Recording



You can play back a title on HDD while making a recording on the same device.

To do so, press [TOP MENU] during recording and select a title you like to play, and then press [ENTER]. Press [Cursor ▲ / ▼] to select "Play" on the option window, and then press [ENTER].

To play back a title being recorded while continuing to record, refer to "Time Shift Playback" on page 70.

## Pause



If you are playing the HDD, press [HDD] first.  
If you are playing a disc, press [DVD] first.

### 1 During playback, press [PAUSE II].

Playback will pause with the sound muted.

### 2 Press [PLAY ►] to resume playback.

## Step by Step Playback



### 1 During playback, press [PAUSE II].

### 2 Press [ADJUST+ ►II] or [-ADJUST II◀] repeatedly.

Each time you press [ADJUST+ ►II], playback will go forward one frame (or step) at a time with the sound muted.

To go backward one frame (or step), press [-ADJUST II◀].

### 3 Press [PLAY ►] to resume playback.

#### Note

- Only step by step forward is available when playing back Video CDs and discs with DivX® files.

Introduction

Connections

Basic Setup

Recording

Playback

Editing

Function Setup

VCR Functions

Others

## Variable Replay / Variable Skip



During playback, you can skip forward or backward by the amount of time you set in the Setup Menu. To set the time amount, refer to "9. V. Replay/Skip Speed" on page 97.

If you are playing the HDD, press [HDD] first.  
If you are playing a disc, press [DVD] first.

Press [VARIABLE SKIP] if you want to skip forward.  
Press [VARIABLE REPLAY] if you want to skip backward.

## Zoom



If you are playing the HDD, press [HDD] first.  
If you are playing a disc, press [DVD] first.

- 1 During playback, press [AV SELECT].  
AV Select Menu will appear.
- 2 Select "Zoom" using [Cursor ▲ / ▼], then press [ENTER].



- 3 Select the desired zoom factor to zoom using [Cursor ▲ / ▼], then press [ENTER].

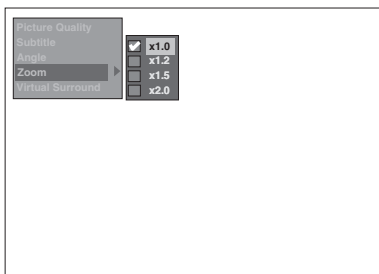

Four options are available, "x1.0", "x1.2", "x1.5" and "x2.0".  
The zoom area is displayed.

- 4 While the picture is enlarged, press [Cursor ▲ / ▼ / ◀ / ▶] to move the zoomed image up, down, left or right.

The grey box with an inner orange box that shows during Zoomed Playback is the position guide. The position of the orange box inside the grey box indicates the position of the zoomed image within the overall picture. The position guide disappears about after 3 seconds if there is no input.

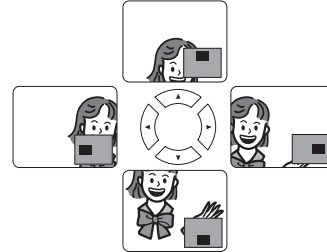

### Note

- To cancel the zoom function, select "x1.0" using [Cursor ▲ / ▼], then press [ENTER].



## Repeat / Programme Playback / Slide Show

### Repeat Playback



#### 1 During playback, press [REPEAT] repeatedly until desired repeat is selected.

The selected repeat playback will start.  
The repeat display will display about 5 seconds.  
The following operations are available.

##### Title:

(Not available during Time shift playback)  
The current title will be played back repeatedly.  
(HDD and DVD)

##### Chapter:

The current chapter will be played back repeatedly. (HDD and DVD)

##### Disc:

The current disc will be played back repeatedly.  
(Audio CD, Video CD, MP3 and DivX®)

##### Track:

The current track will be played back repeatedly.  
(Audio CD, Video CD, MP3 and DivX®)

##### Group:

The current group will be played back repeatedly.  
(MP3 and DivX®)

#### Hint

- To cancel the repeat playback, select "Off". The repeat setting is also cancelled when you stop playback.

#### Note

- For Video CDs with PBC function, repeat playback does not work while PBC function is on.

### Programme Playback



You can programme the disc to play back in your desired order.

- Press [SETUP] in stop mode.  
Setup Menu will appear.
- Select "Playback" using [Cursor ▲ / ▼], then press [ENTER].

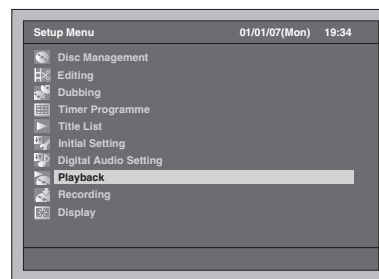

- Select "CD Playback Mode" using [Cursor ▲ / ▼], then press [ENTER].

- Select "Programme Play" using [Cursor ▲ / ▼], then press [ENTER].

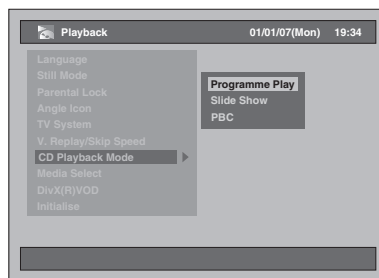

- Select the desired track using [Cursor ▲ / ▼], then press [ENTER] or [Cursor ►].

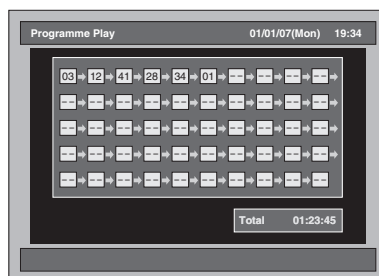

- Press [PLAY ►] to start programme playback.

Introduction

Connections

Basic Setup

Recording

Playback

Editing

Function Setup

VCR Functions

Others

**Hint**

- To erase tracks you entered, select the track and then press **[CLEAR]**.
- You can make up to 50 track settings.
- To cancel programme playback, press **[STOP ■]** twice during programme playback.
- You may also select the desired track using **[the Number buttons]** at step 5.
- For Video CDs, if you select programme playback with the PBC function on, the PBC function will be turned off automatically and programme playback starts.

**Note**

- During programme playback, if you fast forward the track to the end, the playback speed of the next track will be normal.
- During programme playback, you cannot use the search function except for the search with **[SKIP ◀◀ / ▶▶]**, **[SLOW / REV ◀◀]** or **[FWD / SLOW ▶▶]**.

**Slide Show**

You can select the display time between 5 seconds and 10 seconds.

- 1 Follow steps 1 to 3 in “Programme Playback” on page 73.**
- 2 Select “Slide Show” using [Cursor ▲ / ▼], then press [ENTER].**
- 3 Select the display time using [Cursor ▲ / ▼], then press [ENTER].**
- 4 Press [SETUP] to exit.**

**Note**

- Large-size JPEG files take a few moments to be displayed.

**Search**

If you are playing the HDD, press **[HDD]** first.  
If you are playing a disc, press **[DVD]** first.

**Using [SKIP ◀◀ / ▶▶] buttons**

- 1 Press [SKIP ▶▶] to skip to the next title (except HDD) or chapter / track during playback.**

To go back to the previous title (except HDD) or chapter/track, press **[SKIP ◀◀]** twice in quick successions.

**Using the [SEARCH] button**

By using the **[SEARCH]** button, you can select following search options.

Type of search you can select with <b>[SEARCH]</b> button	
HDD	Chapter, Time search
DVD	Chapter, Title, Time search
Audio CD, VCD, DivX®	Track, Time search
MP3	Track search

- 1 Select a type of search by pressing [SEARCH].**  
Every time you press **[SEARCH]**, type of search changes.
- 2 Enter the desired chapter, track, title number or time to search for using [the Number buttons], then press [ENTER].**  
Chapter, title, track or time search will start.

**Hint**

- For DVDs, Audio CD, Video CD, MP3 and DivX®, you can perform the Title / Track search in stop mode.
- Edit marks can be searched as chapter mark. (See page 78.)

**Note**

- During programme playback, search functions are not available except the search using **[SKIP ◀◀ / ▶▶]**, **[SLOW / REV ◀◀]** or **[FWD / SLOW ▶▶]**.
- Time search function is available only in the same track or title.
- For Video CDs with PBC function, search function does not work while PBC function is on.

## Selecting the Format of Audio and Video

You can select the format of audio and video to suit the content of the disc you are playing back.

### Switching Subtitles



Many DVD-Videos have subtitles in one or more languages. The available languages are usually printed on the disc case. You can switch subtitle languages at any time during playback.

Press [DVD] first.

- 1 During playback, press [AV SELECT].
- 2 Select "Subtitle" using [Cursor ▲ / ▼], then press [ENTER].
- 3 Select the desired subtitle language using [Cursor ▼].

Subtitles are displayed in the selected language. If you select "Off", subtitles will disappear.

#### Note

- With some discs, it is only possible to change the subtitle language from the disc menu. Press [DISC MENU] to display the disc menu.
- For discs with DivX® files, the screen only displays the number of subtitle languages.
- For VR mode DVD-RW discs, only On and Off is available.

### Switching Audio Soundtrack



You can select a language for DVDs during playback if multiple languages are available.

If you are playing the HDD, press [HDD] first.  
If you are playing a disc, press [DVD] first.

- 1 During DVD playback, press [AUDIO ⏮] repeatedly to select one of the available languages.

Audio display appears at the left top of the TV screen, and the new audio will be heard. The display will disappear after about 5 seconds.



#### Note

- With some discs, it is only possible to change the soundtrack from the disc menu. Press [DISC MENU] to display the disc menu.
- When playing back Audio CDs, Video CDs or MP3 files, you can switch among the left (L), the right (R) channel, and stereo (L / R).
- If the title contains both main and sub audio, you can switch among main, sub or main / sub.

### Picture Adjustment

You can adjust the picture you are watching according to your preferences.

- 1 Press [AV SELECT].  
AV Select Menu will appear.
- 2 Select "Picture Quality" using [Cursor ▲ / ▼], then press [ENTER].

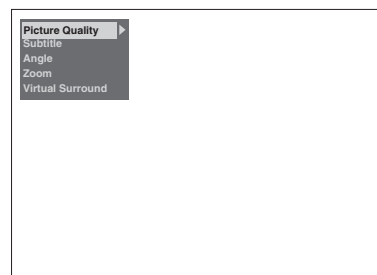

For fixed picture settings:

- 1 Select "Normal" or "Cinema" using [Cursor ▲ / ▼], then press [ENTER].



Normal : To play back with normal picture setting.

Cinema: To play back with picture setting for movies.

Introduction

Connections

Basic Setup

Recording

Playback

Editing

Function Setup

VCR Functions

Others

**For manual picture settings:**

- 1 Select "User 1", "User 2" or "User 3" using [Cursor ▲ / ▼], then press [MODE].
- 2 Select setup option you want to adjust using [Cursor ▲ / ▼], then press [ENTER].

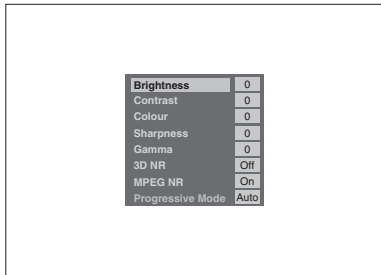

- 3 Make an adjustment using [Cursor ◀ / ▶], then press [ENTER].

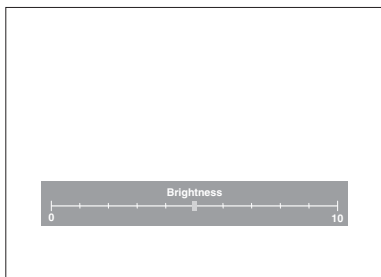

- 4 Press [AV SELECT] to exit.

User Setup options			default
Brightness	to adjust brightness	0(dark) - 10(bright)	0
Contrast	to adjust contrast	-5(weak) - +5(strong)	0
Colour	to adjust colour	-5(pale) - +5(brilliant)	0
Sharpness	to adjust sharpness	-5(soft) - +5(clear)	0
Gamma	to adjust darkness	-1(weak) - +1(strong)	0
3D NR	to reduce noise in the playback picture	Off, Weak, Middle, Strong	Off
MPEG NR	to reduce noise in the MPEG picture	Off, On	Off
Progressive Mode*	to select suitable signal conversion for progressive output	Auto, Film (for live-action picture), Video(for an animation)	Auto

\*Available only when "Video Out" is set to "Component (Progressive)" in the "Initial Setting". (See page 92.)

## Switching Camera Angles



Some DVD-Videos feature scenes shot from two or more angles. The disc case is usually marked with an angle icon if the disc has multi-angle scenes.

Press [DVD] first.

- 1 During playback, press [AV SELECT].  
AV Select menu will appear.
- 2 Select "Angle" using [Cursor ▲ / ▼], then press [ENTER].  
The angle will switch each time you press [Cursor ▼].

**Note**

- If the "Angle" is not selectable, that means the scene does not contain the sequences shot from the multiple angles.
- When "Angle Icon" is set to "On" (see page 97), and the scene contains the sequences shot from the multiple angles, "Angle" will appear on the TV screen.

## Switching Virtual Surround System



You can enjoy stereophonic virtual space through your existing 2 channel stereo system.

- 1 Press [AV SELECT].  
AV Select Menu will appear.
- 2 Select "Virtual Surround" using [Cursor ▲ / ▼], then press [ENTER].



- 3 Select "Off", "Type 1" or "Type 2" using [Cursor ▲ / ▼], then press [ENTER].



- Off : no effect
- Type 1 : Natural effect
- Type 2 : Emphasised effect

**Note**

- Select "Virtual Surround" to "Off" if the sound is distorted.
- The setting will be kept even when the unit is turned off.

# Editing

## Guide to the Editing on this Unit

The following editing menus are three different methods depending on how you edit the titles.

- Add or delete chapter marks manually. (See page 78.)
- Create a Playlist, scene delete, combine or divide of the title. (See pages 79, 82, 86 and 87.)
- Edit from the Title List (delete, edit title name or protect of the title, etc.). (See pages 81, 84, and 85.)

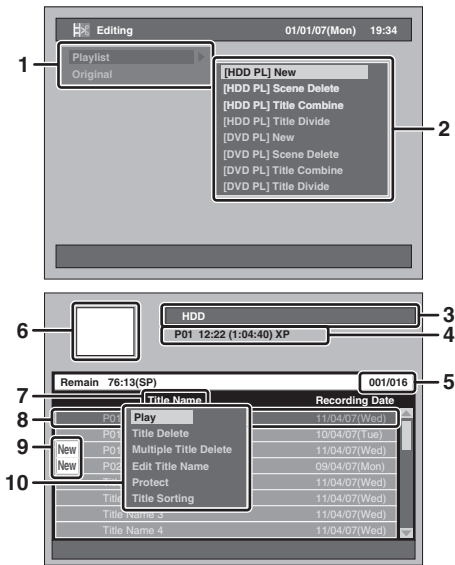

- 1 Editing Menu
- 2 Items of Editing Menu
  - Items vary between "Playlist" and "Original".
- 3 Selected device (HDD or DVD)
- 4 Channel, starting time, the length of recording time and Rec Mode of the selected title
- 5 The number of the current Title / the total number of the Title
  - Use **[SKIP >>>]** to jump to the next page. Use **[SKIP <<<]** to jump to the previous page. Use **[Cursor ▲ / ▼]** to move among titles one by one.
- 6 Preview window (Moving Image)
- 7 Selected list type (Original or Playlist for HDD or VR mode DVD-RW only)
- 8 Selected title
  - Title name
  - Only the highlighted title will be played back in the preview window.
  - Protect icon will appear only when the title is protected (Original only).
- 9 Unplayed titles (HDD only)
- 10 Pop-up window

## Available Editing Menus

Item	Media						Page	Description	
	HDD		VR mode DVD-RWs		Video Mode DVDs	+VR mode DVDs			
	Original	Playlist	Original	Playlist	Original	Original			
Add/Delete Chapter Mark Manually	○	○	○	○	×	○	78	To add or delete the chapter marks to the title.	
From Setup	New	×	○	×	○	×	×	79	To add a title to the Playlist.
	Scene Delete	○	○	○	○	×	×	82-84	To delete a part of the title.
	Title Combine	×	○	×	○	×	×	86	To combine two titles into one.
	Title Divide	○	○	×	○	×	×	87	To divide a title into two titles.
From Title List	Title Delete	○	○	○	○	○	○	81	To delete a title.
	Multiple Title Delete	○	○	○	○	○	○	81	To delete selected titles.
	Edit Title Name	○	○	○	○	○	○	84	To edit title names.
	Protect	○	×	○	×	○	×	85	To protect/undo protect the title.

○: Available  
 ×: Not available

### Note

- You can edit a disc recorded using the PAL system. It is impossible to edit discs recorded using the NTSC system.
- It is possible to edit +VR mode recorded / edited on other unit, in case you can undo the finalisation of the disc on this unit.

## What Are Original and Playlist?

There are 2 types for the title list: Original and Playlist.

### Original:

Original is the list of the recorded programmes (titles) when they are recorded. Original is available for HDD, DVD-RW and DVD-R. Please note that editing the titles in the Original is like editing the original data. For example, if you erase a title in the Original, the title cannot be recovered.



: Available to edit in the HDD Original



: Available to edit in the VR mode DVD-RWs Original

### Playlist:

Playlist is the copy of the Original. You can edit the titles in the Playlist as you like without affecting the original data in the Original. It works like a back up for the Original. Delete a title from the Playlist does not delete the corresponding title in the Original. But delete a title from the Original, the corresponding title in the Playlist will be deleted. Playlist is available only for the HDD and the VR mode DVD-RWs. There is no Playlist for the Video mode DVD-RWs.



: Available to edit in the HDD Playlist



: Available to edit in the VR mode DVD-RWs Playlist

### About Edit Mark:

Edit marks will be added automatically where title is edited, for example where a title is divided or combined. These marks work as chapter marks when you search for a chapter, but cannot be deleted like chapter marks. Also, when a title with chapter marks are dubbed from DVD to the HDD, those marks become edit marks once they are dubbed to the HDD.

## Adding or Deleting Chapter Marks Manually



You can add or delete chapter marks. After a title is marked with chapters, you can use the chapter search feature.

You can set a chapter mark anywhere you want. You can add up to 999 chapter marks per title for DVD-RW, 99 chapter marks per title for DVD+RW / R and 99 chapter marks per title for HDD.

To add the chapter marks ...

- 1** Play back the title you want to add the chapter marks to.
- 2** Press [CHAPTER MARK] at the point where you want.

- A chapter mark will be added.



### Hint

Chapter marks can be added even under the conditions listed below:

- when the playback is paused.
- when the programme is recording or the recording is paused.

### Note

- You can add chapter marks during recording.
- Remaining time of +VR mode disc may decrease when adding chapter marks or increase when clearing chapter marks depending on the recording time or edited contents.
- For +VR mode disc, it is not likely to be able to add chapter marks up to the maximum recordable numbers of chapters, according to time and number of chapters.

To delete the chapter marks ...

- 1** Play back the title you want to delete the chapter marks from.
- 2** Press [PAUSE II].
- 3** Select a desired chapter mark to delete using [SKIP ◀◀ / ▶▶].

#### 4 Press [CLEAR].

- A chapter mark will be deleted.

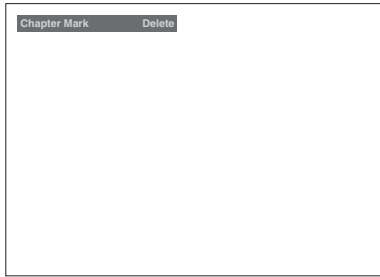

#### Note

- You cannot delete chapter marks from a title being recorded currently.
- Edit marks cannot be deleted (see "About Edit Mark:" on page 78).

## Creating Titles to a Playlist



You can create a title to the Playlist as you prefer. You can make it up to 99 titles for DVDs and 600 titles for HDD.

### 1 Press [SETUP] in stop mode.

Setup Menu will appear.

### 2 Select "Editing" using [Cursor ▲ / ▼], then press [ENTER].

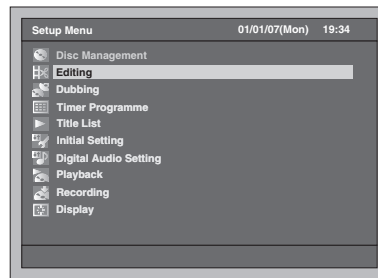

### 3 Select "Playlist" using [Cursor ▲ / ▼], then press [ENTER].

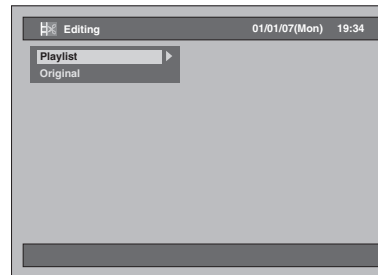

### 4 Select "[HDD PL] New" or "[DVD PL] New" using [Cursor ▲ / ▼], then press [ENTER].

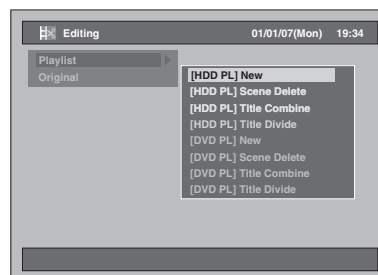

Introduction

Connections

Basic Setup

Recording

Playback

Editing

Function Setup

VCR Functions

Others

**5** Select a desired title you want to add to the Playlist using [Cursor ▲ / ▼], then press [ENTER].

Example: [HDD PL] New

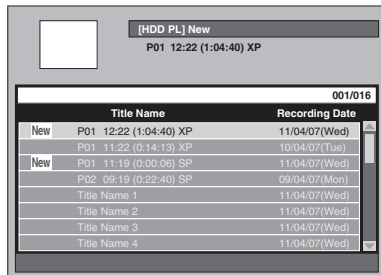

- The selected title is added to the Playlist.
- Press [MODE] to switch Original and Playlist if necessary.

**6** Select "Select" using [Cursor ▲ / ▼], then press [ENTER].

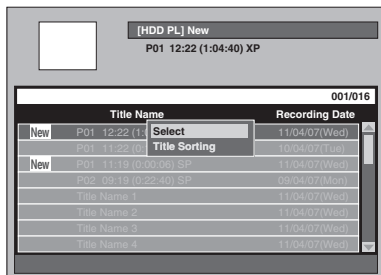

**7** Select "Yes" using [Cursor ◀ / ▶], then press [ENTER].

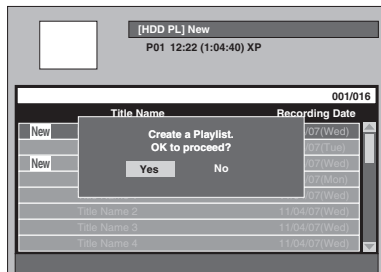

**8** Input the title name in the Playlist Title Name window if necessary. Then press [ENTER]. See "Guide to Edit Title Name" on page 85.

- If you want to leave the title name as it is, press [ENTER].
- To create another playlist, repeat steps 3 to 8.

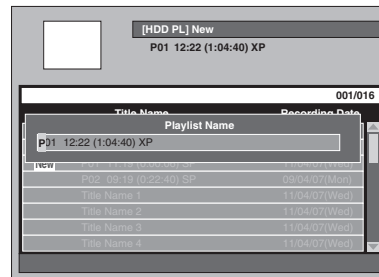

**9** Press [SETUP] to exit.

**Note**

- For VR mode DVD-RW disc, if the Playlist contains more than 99 titles or 999 chapters, "[DVD PL] New" cannot be selected.
- For the HDD, if the Playlist contains more than 600 titles, "[HDD PL] New" cannot be selected.
- To delete titles from Playlist, refer to "Deleting Titles" on pages 81 to 82.
- This function does not work on +VR mode discs.



## Deleting Titles

Be advised that the titles once deleted cannot be recovered.  
 With DVD-R / +R discs, deleting titles will not affect the recordable disc space.  
 With Video mode DVD-RW discs, the disc space will increase only when the last title in the Original is deleted.  
 If you delete the title in DVD+RW disc, deleted title will be displayed as "Empty Title". The disc space will increase if you delete all title from the Empty Title to the newest title memorised in the Title list.  
 With HDD and VR mode DVD-RW discs, the disc space will increase when any title in the Original is deleted.  
 Deleting a Playlist will not increase the recordable disc space.  
 Deleting a title in the Playlist will not delete the corresponding title in the Original.

### Deleting a Title



You can delete a title which you do not need anymore.

If you edit the HDD, press [HDD] first.  
 If you edit a disc, press [DVD] first.

#### 1 Press [TOP MENU].

Title List will appear.  
 Except for Video mode DVD-RW / R and +VR mode DVD+RW / R, press [MODE] to switch Original and Playlist if necessary.

#### 2 Select a desired title to delete using [Cursor ▲ / ▼], then press [ENTER].

Example: HDD Original

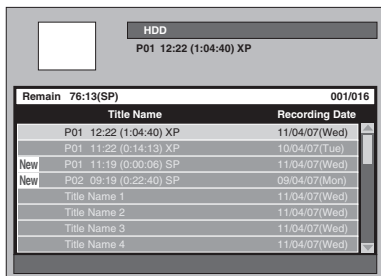

#### 3 Select "Title Delete" using [Cursor ▲ / ▼], then press [ENTER].

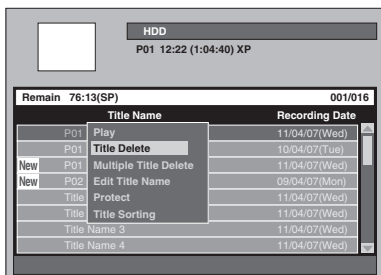

Confirmation window will appear.

#### 4 Select "Yes" using [Cursor ◀ / ▶], then press [ENTER].

The title is deleted.

#### 5 Press [RETURN] or [SETUP] twice to exit.

### Deleting Selected Titles



You can also delete some titles at once.

If you edit the HDD, press [HDD] first.  
 If you edit a disc, press [DVD] first.

#### 1 Press [TOP MENU].

Title List will appear.  
 Except for Video mode DVD-RW / R and +VR mode DVD+RW / R, press [MODE] to switch Original and Playlist if necessary.

#### 2 Select a desired title to delete using [Cursor ▲ / ▼], then press [ENTER].

Example: HDD Original

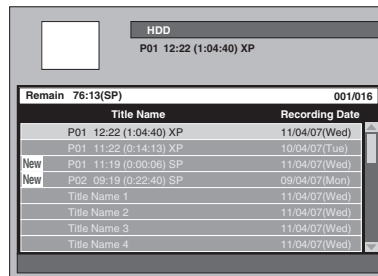

#### 3 Select "Multiple Title Delete" using [Cursor ▲ / ▼], then press [ENTER].

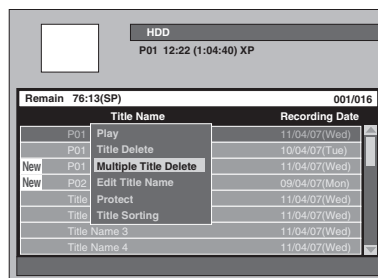

The first "✓" will be marked.

- 4** Continue to select a desired title again using [Cursor ▲ / ▼], then press [ENTER].

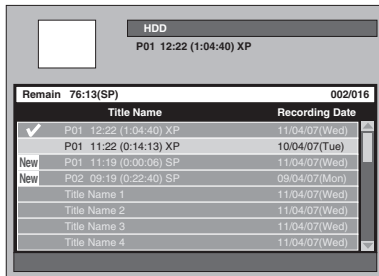

The second "✓" will be marked.

If you want to clear the check mark of a title, select the title, then press [ENTER]. "✓" mark will disappear.

- 5** When all the titles are selected, press [CLEAR].

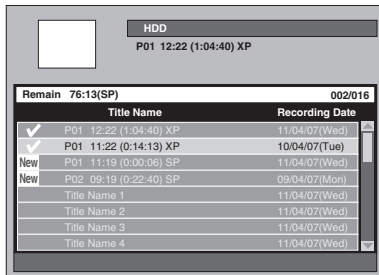

Confirmation window will appear.

- 6** Select "Yes" using [Cursor ◀ / ▶], then press [ENTER].

The selected titles are deleted.

#### Note

- You cannot delete a title in a folder and other titles at the same time.

## Deleting a Scene of a Title



You can delete a specific scene of a title.

Even if a scene of a title is deleted from the Playlist, the title in the Original will remain as it was, and recordable disc space will not increase.

- Press [SETUP] in stop mode.  
Setup Menu will appear.
- Select "Editing" using [Cursor ▲ / ▼], then press [ENTER].

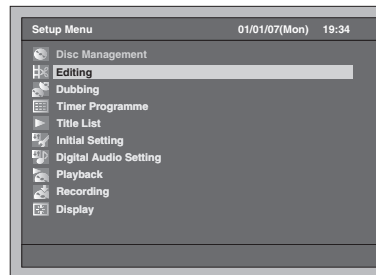

- Select "Playlist" or "Original" using [Cursor ▲ / ▼], then press [ENTER].

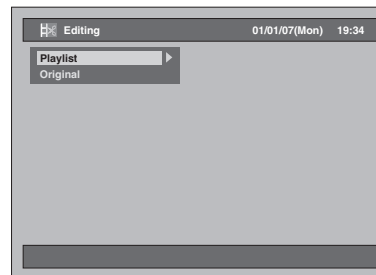

- Select "[HDD ORG] Scene Delete" or "[DVD ORG] Scene Delete" in "Original", or "[HDD PL] Scene Delete" or "[DVD PL] Scene Delete" in "Playlist" using [Cursor ▲ / ▼], then press [ENTER].

Example: Playlist

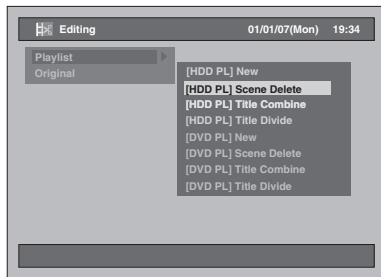

- 5** Select a desired title you want to delete a scene from, then press [ENTER].

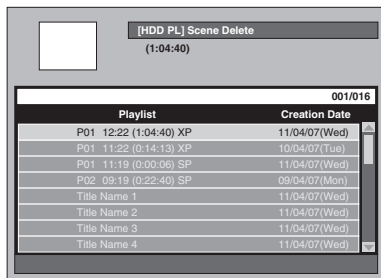

- 6** Select "Select" using [Cursor ▲ / ▼], then press [ENTER].

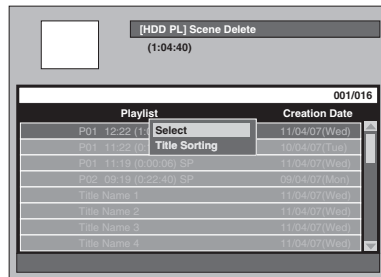

- 7** Press [PLAY ►] to start playback.

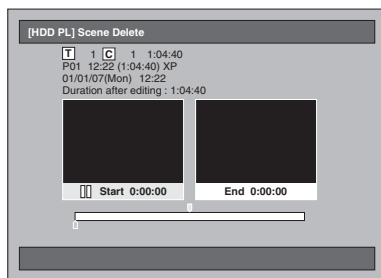

Play the title up to the point where you want to set a start point of the scene to be deleted.

- You can use [PLAY ►], [SLOW / REV ◀◀], [FWD / SLOW ▶▶], [SKIP ◀◀ / ▶▶], [VARIABLE REPLAY], [VARIABLE SKIP], [PAUSE II] or [STOP ■] (which is substitute for [PAUSE II]) to find the start point easily.
- If you want to quit the process, press [SETUP] to exit.
- [STOP ■] works as described below while searching for the Start/End point:  
While in play: to pause the playback.  
While in pause: to jump back to the beginning of the title.

- 8** When it reaches the desired start point, press [ENTER].

A start point is marked on the progress bar and the highlight moves to the window on the right.

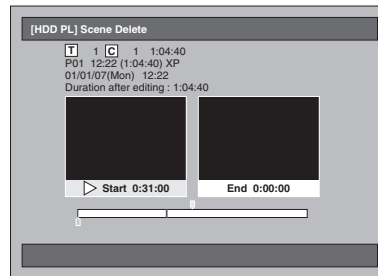

- If you want to reset the start point, press [CLEAR]. Or press [RETURN], then follow the steps 5 to 7 again.
- If you want to quit the process, press [SETUP] to exit.

- 9** Press [PLAY ►] to start playback again.

Play the title up to the point where you want to set an end point for the scene to be deleted.

- You can use [PLAY ►], [SLOW / REV ◀◀], [FWD / SLOW ▶▶], [SKIP ◀◀ / ▶▶], [VARIABLE REPLAY], [VARIABLE SKIP], [PAUSE II] or [STOP ■] (which is substitute for [PAUSE II]) to find the end point easily.

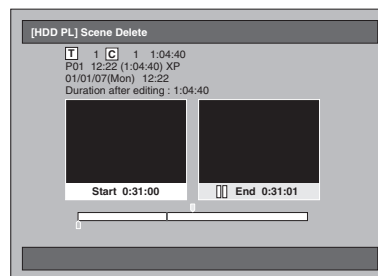

Introduction

Connections

Basic Setup

Recording

Playback

Editing

Function Setup

VCR Functions

Others

## 10 When it reaches the desired end point, press [ENTER].

An end point is marked on the progress bar.

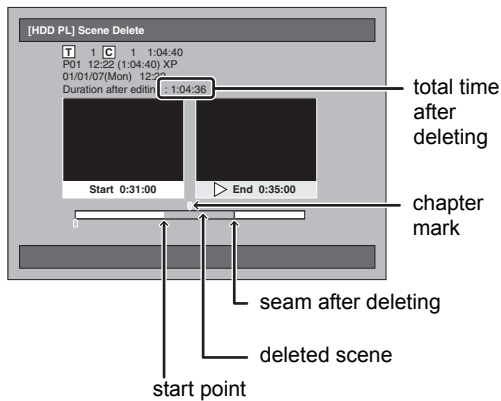

- If you want to reset the end point, press [RETURN] twice, then follow the steps 5 to 9 again.
- If you want to quit the entire process, press [RETURN] repeatedly.

## 11 Select "Delete" using [Cursor ▲ / ▼], then press [ENTER].

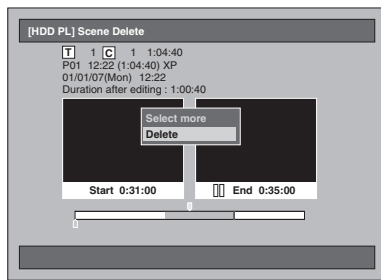

If you want to select more scenes...  
Select "Select more". Then follow steps 5 to 10.

## 12 Select "Yes" using [Cursor ◀ / ▶], then press [ENTER].

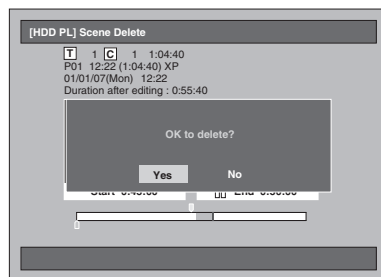

The scene is deleted.

## 13 Press [SETUP] to exit.

### Note

- If a certain scene is deleted from the title in the Original, the title in the Playlist that contains the corresponding scene will be deleted also.
- Title List cannot be deleted or changed when a title or disc has been protected or during recording.
- For Original only, "Preview" appears at step 11. By selecting it you can preview the result of scene deletion.

## Editing Title Names



You can name titles or change the title names from this menu.  
The names you put on the titles will be displayed on a Title List.

If you edit the HDD, press [HDD] first.  
If you edit a disc, press [DVD] first.

### 1 Press [TOP MENU].

Title List will appear.

Except for Video mode DVD-RW / R and +VR mode DVD+RW / R, press [MODE] to switch Original and Playlist if necessary.

### 2 Select a desired title to edit using [Cursor ▲ / ▼], then press [ENTER].

Title window will appear.

Example: HDD Original

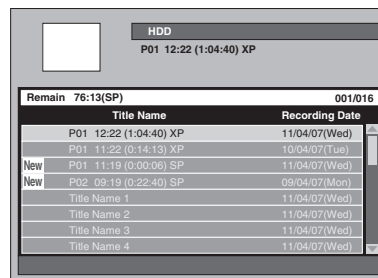

### 3 Select "Edit Title Name" using [Cursor ▲ / ▼], then press [ENTER].

The first letter will be highlighted.

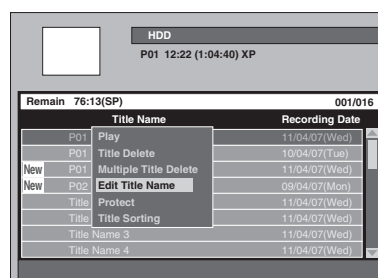

**4** To enter a title name, refer to “Guide to Edit Title Name” below.

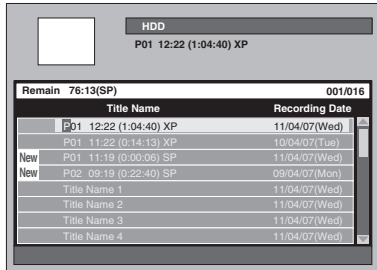

**5** When you finish entering the title name, press [ENTER] again.  
Your setting is activated.

**6** Press [RETURN] or [SETUP] twice to exit.

**Guide to Edit Title Name**

Following the list below, press [the Number Buttons] repeatedly until the desired letter appears.

Press		
0	space , 0	
1	! # \$ % & ' ( ) * + , - . / : ; < = > ? @ [ \ ] _ { } ~ ` 1	
2	ABC abc 2	
3	DEF def 3	
4	GHI ghi 4	
5	JKL jkl 5	
6	MNO mno 6	
7	PQRS pqrs 7	
8	TUV tuv 8	
9	WXYZ wxyz 9	

Select a desired item using [Cursor ▲ / ▼ / ◀ / ▶], then press [ENTER].

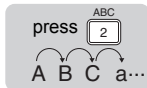

- If you want to enter the same letters successively, for example if you want to enter AA, press [ENTER] after you enter the first A ( 2 ), then enter the other A by pressing ( 2 ) one more time.
- Press [Cursor ▶] for a space.
- Press [Cursor ◀ / ▶] to move the cursor to the left or right.
- Press [Cursor ◀] to insert a letter in the letters entered.
- Press [CLEAR] to erase letters one by one.
- If the letters are completed, press [ENTER] again.
- You can enter up to 64 letters, for the titles in the HDD, the VR mode DVD-RWs and the Video mode DVD-RW / R.

**Note**

- Unidentified letters in a title name are shown by “\*”. If you delete them, adjoining letters may change to “\*” or other.

**Protecting / Undo Protecting Titles**



To prevent accidental editing or title erasing, you can protect the contents.

If you edit the HDD, press [HDD] first.  
If you edit a disc, press [DVD] first.

**1** Press [TOP MENU].

Title List will appear.

**2** Select a desired title to protect using [Cursor ▲ / ▼], then press [ENTER].

Example: HDD Original

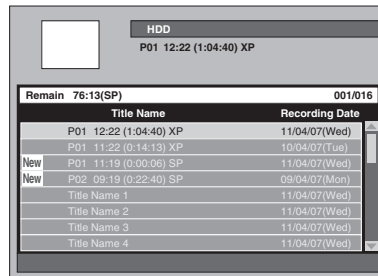

**3** Select “Protect” using [Cursor ▲ / ▼], then press [ENTER].

The protect icon will appear on the list.

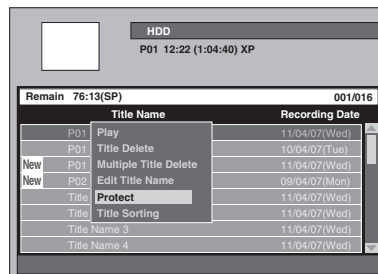

If the title has already been protected, “Undo Protect” will be listed on the window instead of “Protect”. To cancel the protection, select “Undo Protect” and press [ENTER]. The protect icon will disappear.

**4** Press [RETURN] or [SETUP] twice to exit.

To protect the VR mode DVD-RW and DVD+RW discs themselves, refer to “Setting Disc Protection” on page 58.

## Combining Titles



You can combine two titles into a single title.

- 1 Press [SETUP] in stop mode.  
Setup Menu will appear.
- 2 Select "Editing" using [Cursor ▲ / ▼], then press [ENTER].

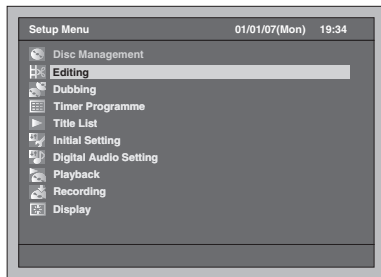

- 3 Select "Playlist" using [Cursor ▲ / ▼], then press [ENTER].

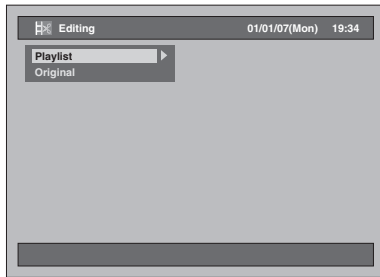

- 4 Select "[HDD PL] Title Combine" or "[DVD PL] Title Combine" using [Cursor ▲ / ▼], then press [ENTER].

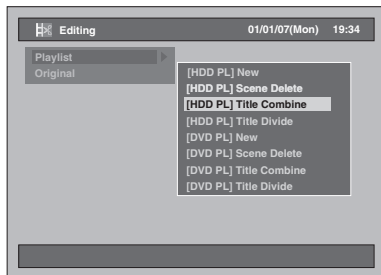

- 5 Select a desired title (title 1) using [Cursor ▲ / ▼], then press [ENTER].

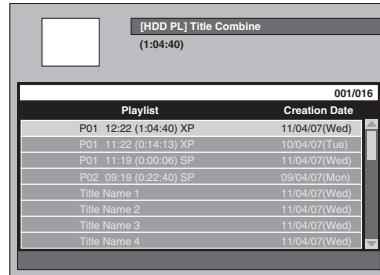

- 6 Select "Select" using [Cursor ▲ / ▼], then press [ENTER].

The first "✓" will be marked.

- 7 Select a title to combine (title 2) using [Cursor ▲ / ▼], then press [ENTER].

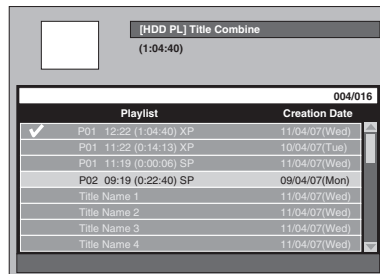

The second "✓" will be marked and Confirmation window will appear.

- 8 Select "Yes" using [Cursor ◀ / ▶], then press [ENTER].

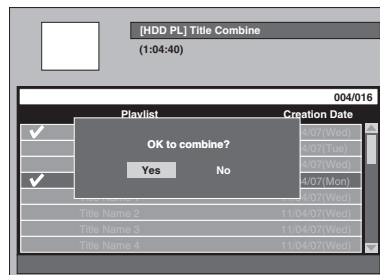

Two titles will be combined into a single title.

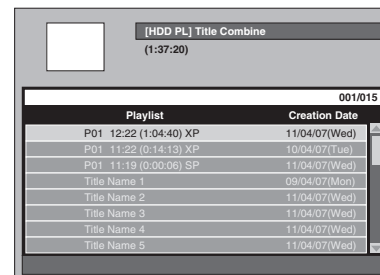

- 9 Press [SETUP].

Confirmation window will appear.

## 10 Select “Yes” using [Cursor ◀ / ▶], then press [ENTER] to exit.

### Note

- If the number of chapter marks in the combined title exceeds 999 (99 for HDD), the combination will be rejected.
- If one of two titles in the Original is deleted, the combined new title will be deleted.
- The name of the title selected first will become the name of the combined title.
- The title selected first will be the first half of the combined title.
- If the length of the title exceeds 12 hours after combined, the combination will be rejected.
- You only can combine the titles in the same folder.

## Dividing a Title



You can divide a title into two new titles.

- 1 Press [SETUP] in stop mode.**  
Setup Menu will appear.
- 2 Select “Editing” using [Cursor ▲ / ▼], then press [ENTER].**

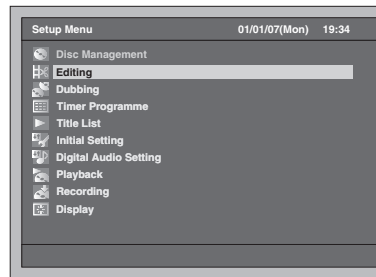

- 3 Select “Playlist” or “Original” using [Cursor ▲ / ▼], then press [ENTER].**

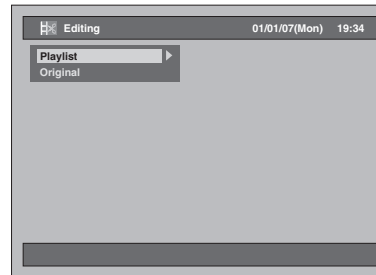

- 4 Select “[HDD PL] Title Divide” or “[DVD PL] Title Divide” using [Cursor ▲ / ▼], then press [ENTER].**

Example: Playlist

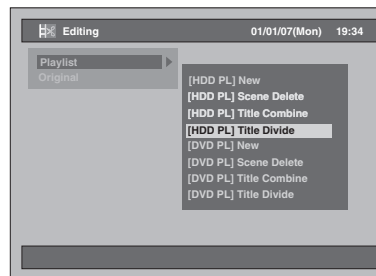

Introduction

Connections

Basic Setup

Recording

Playback

Editing

Function Setup

VCR Functions

Others

- 5** Select a desired title you want to divide, then press [ENTER].

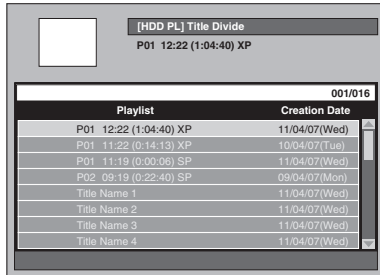

- 6** Select "Select" using [Cursor ▲ / ▼], then press [ENTER].

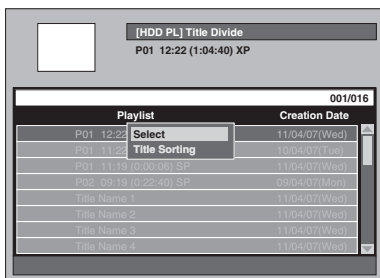

- You can use [PLAY ►], [SLOW / REV ◀◀], [FWD / SLOW ►►], [SKIP ◀◀ / ►►], [VARIABLE REPLAY], [VARIABLE SKIP], [PAUSE ||] or [STOP ■] (which is substitute for [PAUSE ||]) to find the divide point easily.
- If you want to quit the process, press [SETUP] to exit.
- [STOP ■] works as described below while searching for the divide point:  
While in play: to pause the playback.  
While in pause: to jump back to the beginning of the title.

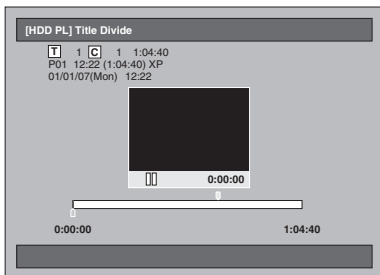

- 7** When it reaches the desired dividing point, press [ENTER], or press [PAUSE ||] or [STOP ■] and then [ENTER].

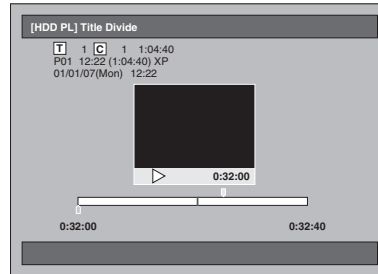

- 8** Select "Yes" using [Cursor ◀ / ▶], then press [ENTER].

The title is divided.

- 9** Press [SETUP] to exit.

#### Note

- If an internal HDD or a DVD disc contains the maximum number of titles (HDD: 600, DVD-RW disc: 99), you cannot divide any titles.
- With DVD-RW disc, you cannot divide the titles if the total number of chapters has already reached 999.



# Function Setup

## Tour of the Setup Menus

The following table shows the items which you can change the setting and their default settings. Refer to the following table for your convenience.

Setup Menu	Items	Selection (highlight is the default)	Contents
Initial Setting	OSD Language ➡ Page 27	English Français Español Deutsch Italiano Svenska Nederlands	Set the language for OSD (on-screen display).
	Clock Setting	Clock Setting ➡ Page 31	Set the clock manually.
		Auto Clock Setting ➡ Page 30	Set the clock automatically.
	Channel Setting	Auto Tuning ➡ Page 27	Tune the channels automatically.
		Manual Tuning ➡ Page 28	Tune the channels manually.
		Move ➡ Page 29	Move the channel to different position.
	TV Aspect ➡ Page 32	4 : 3 Letter Box 4 : 3 Pan & Scan 16 : 9 Wide 16 : 9 Shrink	Set a picture size according to aspect ratio of your TV.
Select Video ➡ Page 56	Video In S-Video In	Set the video input type for the external input.	
Video Out ➡ Page 92	SCART(RGB) Component (Progressive) Component (Interlace)	Sets the video output signal to be fixed accordingly to your TV set.	
Digital Audio Setting	Down Sampling ➡ Page 93	48kHz 96kHz	Set whether the sound recorded at 96 kHz is down sampled to 48 kHz or not.
	Dolby Digital ➡ Page 93	Bit Stream PCM	Set the type of sound signal output from the digital audio output jack.
	MPEG ➡ Page 93	Bit Stream PCM	Set the digital audio output signal specification.
	DTS ➡ Page 94	On Off	Set whether DTS signal is output or not.
	Dynamic Range Control ➡ Page 94	On Off	Compress the range of sound volume.

Introduction

Connections

Basic Setup

Recording

Playback

Editing

Function Setup

VCR Functions

Others

Setup Menu	Items	Selection (highlight is the default)	Contents
Playback	Language ➡ Page 94	Original English French Spanish German Italian Swedish Dutch Other	Set the language for audio.
		Off English French Spanish German Italian Swedish Dutch Other	Set the language for subtitles.
		English French Spanish German Italian Swedish Dutch Other	Set the language for Disc Menu.
		Off English French German Spanish Italian Dutch Swedish Russian Polish	Set the language for DivX® Subtitle.
	Still Mode ➡ Page 96	Auto Field Frame	Set the still mode.
	Parental Lock ➡ Page 96	All Level 8 to 1	Set the parental level for DVD disc playback.
	Angle Icon ➡ Page 97	On Off	Set whether or not to display the angle icon.
	TV System ➡ Page 97	PAL Auto	Set the TV system.
	V. Replay/Skip Speed ➡ Page 97	Variable Skip 15 seconds 30 seconds 1 minute	Set the amount of skip time when you press <b>[VARIABLE SKIP]</b> .
		Variable Replay 15 seconds 30 seconds 1 minute	Set the amount of rewind time when you press <b>[VARIABLE REPLAY]</b> .
	CD Playback Mode ➡ Pages 73-74	Programme Play	Set the disc to play back in your desired order.
		Slide Show 5 seconds 10 seconds	Set the display time.
		PBC On Off	Enable you to play back interactive software using menu screens.
	Media Select ➡ Page 66	Video Audio Picture	Set the media to play for discs contains mixture of different type of media.
DivX(R)VOD ➡ Page 66		Provide DivX® VOD registration code.	
Initialise ➡ Page 97	Initialise Yes No	Return the initial settings to the factory default.	

Setup Menu	Items	Selection (highlight is the default)	Contents
Recording	Auto Chapter [HDD] ➡ Page 39	5 minutes 10 minutes 15 minutes 30 minutes 60 minutes Off	Insert chapter marks every set time interval.
	Noise Reduction ➡ Page 98	Strong Weak Off	Reduce some noise in playback picture or to record in LP/EP/SLP mode.
	Bilingual Recording Audio ➡ Page 40	Main Sub	Set the audio type for recording.
	Fast Dubbing Audio (Video Mode) ➡ Page 98	On Off	Set the HDD bilingual recording audio for fast dubbing.
	External Input Audio ➡ Page 46	Stereo Bilingual	Set the external input audio type for recording.
	Recording Audio Select [XP] ➡ Page 41	Dolby Digital LPCM	Set the recording audio type. (Only when the Rec Mode is set to XP.)
	Initialise ➡ Page 97	Initialise Yes No	Return the initial settings to the factory default.
Display	FL Dimmer ➡ Page 99	Auto Bright Dark	Set the brightness of the Front Panel Display.
	Display Device Status ➡ Page 99	On Off	Set the operating display.
	Background Colour ➡ Page 99	On Off	Set the background colour.
	Screen Saver ➡ Page 99	On Off	Set the Screen Saver.

**Note**

- If you change the settings in the Setup Menus, the information of the contents remain memorised even after the power is turned off or the disc tray is opened or closed.

Introduction

Connections

Basic Setup

Recording

Playback

Editing

Function Setup

VCR Functions

Others

## Initial Setting

- 1** Press [SETUP] in stop mode.  
Setup Menu will appear.
- 2** Select "Initial Setting" using [Cursor ▲ / ▼], then press [ENTER].

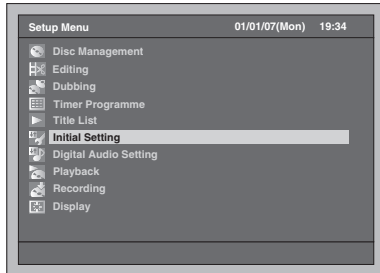

- 3** Select "Video Out" using [Cursor ▲ / ▼], then press [ENTER].

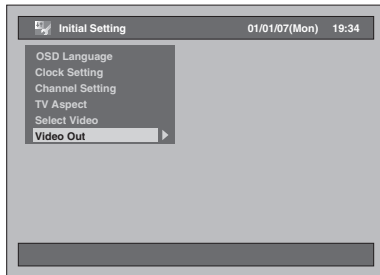

### Video Out (Default: SCART(RGB))

Set the video output signal to be fixed accordingly to your TV set.

- 4** Select the desired setting using [Cursor ▲ / ▼], then press [ENTER].

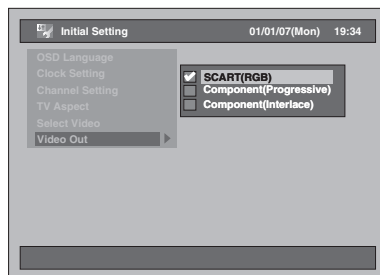

The selected setting will be checked and activated.

SCART(RGB):

Select "SCART(RGB)" if your TV has a scart terminal and connected to it.

Component (Progressive):

If your TV is compatible with progressive scanning, select "Component (Progressive)".

Component (Interlace):

If your TV has component jacks, select "Component (Interlace)".

- 5** When you finish with the setting, press [SETUP] to exit.

## Digital Audio Setting

- 1 Press [SETUP] in stop mode.  
Setup Menu will appear.
- 2 Select "Digital Audio Setting" using [Cursor ▲ / ▼], then press [ENTER].

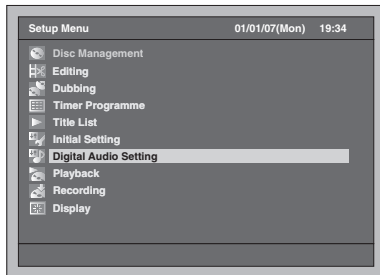

- 3 Select a desired item using [Cursor ▲ / ▼], then press [ENTER].

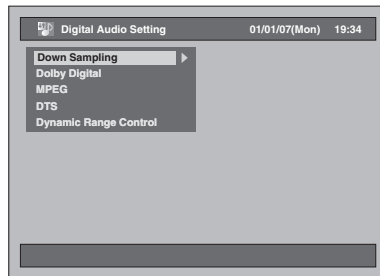

- 4 Refer to 1. to 5. on pages 93 to 94 and set the selected item.
- 5 When you finish with the setting, press [SETUP] to exit.

### 1. Down Sampling (Default: 48kHz)

Set the Down Sampling.

(Follow steps 1 to 2 above.)

Select "Down Sampling" using [Cursor ▲ / ▼], then press [ENTER].

Option window will appear.

Select the desired setting using [Cursor ▲ / ▼], then press [ENTER].



The selected setting will be checked and activated.

48kHz: If your amplifier / decoder is NOT compatible with 96 kHz PCM, select "48kHz". Sound recorded at 96 kHz is down sampled to 48 kHz.

96kHz: If your amplifier / decoder is compatible with 96 kHz PCM, select "96kHz". Sound is sampled at 96 kHz.

### Note

When playing back disc with copyright protection:

- Even if you select "96kHz", the sound will be down sampled at 48 kHz.

### 2. Dolby Digital (Default: Bit Stream)

Set the Dolby Digital.

(Follow steps 1 to 2 on the left.)

Select "Dolby Digital" using [Cursor ▲ / ▼], then press [ENTER].

Option window will appear.

Select the desired setting using [Cursor ▲ / ▼], then press [ENTER].



The selected setting will be checked and activated.

Bit Stream: Outputs Dolby Digital signals.

If your amplifier / decoder is compatible with Dolby Digital, set to "Bit Stream". Converts the Dolby Digital into PCM (2 channel).

PCM:

If your amplifier / decoder is NOT compatible with Dolby Digital, set to "PCM".

### Hint

When playing back the HDD or a DVD-RW disc recorded in VR mode:

- If the audio source on a disc is in Dolby Digital format, set "Dolby Digital" to "PCM" so that you can switch to main audio (L), sub audio (R), or a combination of both (L / R) using your amplifier / decoder.

### 3. MPEG (Default: PCM)

Set the MPEG.

(Follow steps 1 to 2 on the left.)

Select "MPEG" using [Cursor ▲ / ▼], then press [ENTER].

Option window will appear.

Select the desired setting using [Cursor ▲ / ▼], then press [ENTER].

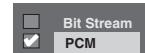

The selected setting will be checked and activated.

Bit Stream: Outputs MPEG Audio signals.

If your amplifier / decoder is compatible with MPEG, set to "Bit Stream".

PCM:

Converts MPEG into PCM.

If your amplifier / decoder is NOT compatible with MPEG, set to "PCM".

Introduction

Connections

Basic Setup

Recording

Playback

Editing

Function Setup

VCR Functions

Others

#### 4. DTS (Default: On)

Set the DTS.

(Follow steps 1 to 2 on page 93.)

**Select “DTS” using [Cursor ▲ / ▼], then press [ENTER].**

Option window will appear.

**Select the desired setting using [Cursor ▲ / ▼], then press [ENTER].**

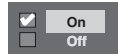

The selected setting will be checked and activated.

On: Outputs DTS signals.

If your amplifier / decoder is compatible with DTS, set to “On”.

Off: No DTS signal is output.

If your amplifier / decoder is NOT compatible with DTS, set to “Off”.

#### 5. Dynamic Range Control (Default: On)

Set to “On” to make the dynamic range narrower.

(Follow steps 1 to 2 on page 93.)

**Select “Dynamic Range Control” using [Cursor ▲ / ▼], then press [ENTER].**

Option window will appear.

**Select the desired setting using [Cursor ▲ / ▼], then press [ENTER].**



The selected setting will be checked and activated.

## Playback

### 1 Press [SETUP] in stop mode.

Setup Menu will appear.

### 2 Select “Playback” using [Cursor ▲ / ▼], then press [ENTER].

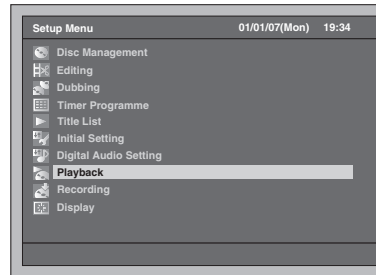

### 3 Select a desired item using [Cursor ▲ / ▼], then press [ENTER].

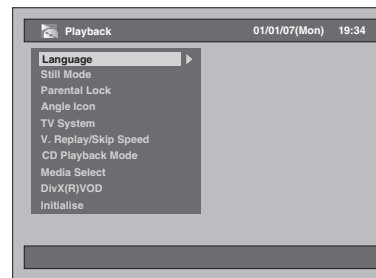

### 4 Refer to 1. to 10. on pages 94 to 97 and set the selected item.

### 5 When you finish with the setting, press [SETUP] to exit.

#### 1. Audio Language (Default: Original)

Set the Audio language.

(Follow steps 1 to 2 above.)

**Select “Language” using [Cursor ▲ / ▼], then press [ENTER].**

Language Menu will appear.

**Select “Audio Language” using [Cursor ▲ / ▼], then press [ENTER].**

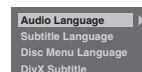

Select the desired language using [Cursor ▲ / ▼], then press [ENTER].

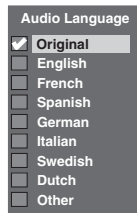

The selected setting will be checked and activated.  
If "Original" is selected, the audio language is the default of the inserted disc.

## 2. Subtitle Language (Default: Off)

Set the Subtitle language.

(Follow steps 1 to 2 on page 94.)

Select "Language" using [Cursor ▲ / ▼], then press [ENTER].

Language Menu will appear.

Select "Subtitle Language" using [Cursor ▲ / ▼], then press [ENTER].

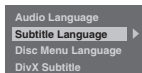

Select the desired language using [Cursor ▲ / ▼], then press [ENTER].

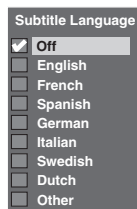

The selected setting will be checked and activated.

If "Other" is selected, enter the appropriate 4-digit code using [the Number buttons]. Refer to "Language Code" on page 108.



When you finish entering the code, press [ENTER].

### Note

- You can also change or turn off the subtitles on a DVD from the disc menu if it is available.
- Press [CLEAR] to erase numbers entered incorrectly.
- You can only select the languages supported by the inserted disc.
- The Audio language setting and the subtitle language setting may not be available for some discs.

## 3. Disc Menu Language (Default: English)

Set the Disc Menu language.

(Follow steps 1 to 2 on page 94.)

Select "Language" using [Cursor ▲ / ▼], then press [ENTER].

Language Menu will appear.

Select "Disc Menu Language" using [Cursor ▲ / ▼], then press [ENTER].

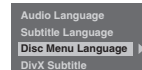

Select the desired language using [Cursor ▲ / ▼], then press [ENTER].

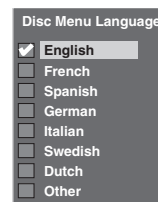

The selected setting will be checked and activated.

## 4. DivX Subtitle (Default: Off)

You can set the DivX® Subtitle language.

(Follow steps 1 to 2 on page 94.)

Select "Language" using [Cursor ▲ / ▼], then press [ENTER].

Language Menu will appear.

Select "DivX Subtitle" using [Cursor ▲ / ▼], then press [ENTER].

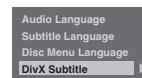

Select the desired language using [Cursor ▲ / ▼], then press [ENTER].

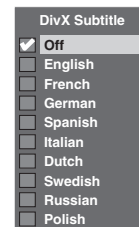

The selected setting will be checked and activated.

Introduction

Connections

Basic Setup

Recording

Playback

Editing

Function Setup

VCR Functions

Others

## 5. Still Mode (Default : Auto)

Set the still mode.

(Follow steps 1 to 2 on page 94.)

**Select "Still Mode" using [Cursor ▲ / ▼], then press [ENTER].**

Option window will appear.

**Select the desired setting using [Cursor ▲ / ▼], then press [ENTER].**



The selected setting will be checked and activated.

- Auto:** Automatically select the best resolution setting ("Frame" or "Field") based on the data characteristics of the pictures.
- Field:** Select "Field" when the pictures are still unstable even if "Auto" is selected. "Field" stabilises the pictures, although the picture quality may become coarse due to the limited amount of data.
- Frame:** Select "Frame" to display relatively motionless pictures in higher resolution. "Frame" improves the picture quality, although it may unstabilise the pictures due to simultaneous output of two Field data.

### Note

- An individual picture on TV screen is called as Frame, which consists of two separate images called as Field. Some pictures may be blurred at the "Auto" setting in still mode due to their data characteristics.

## 6. Parental Lock (Default: All)

You can set the Parental Lock Level to keep your children from viewing the inappropriate materials.

(Follow the steps 1 to 2 on page 94.)

**Select "Parental Lock" using [Cursor ▲ / ▼], then press [ENTER].**

Parental lock window will appear.

- If you want to set a parental lock, proceed to **A**.
- If you want to change the password, proceed to **B**.

**A: When you want to set a parental lock,**

**1 Enter the 4-digit password in the password input field using [the Number buttons], then press [ENTER].**

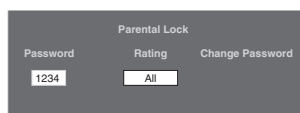

- When the password has not been set yet, the numbers will be displayed during entering the password. After that, the numbers will change to "\*".

- When the password has been set already, the password will be displayed as "\*" for your security.
- If the password you have entered is wrong, the error message will appear.

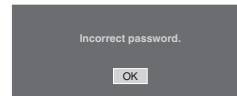

**Press [ENTER] and enter the correct 4-digit password again.**

**2 Select a desired level using [Cursor ▲ / ▼], then press [ENTER].**

### Rating Explanation:

- All - Parental Controls is inactive; all discs can play.
- 8 - Virtually all DVD software of any grade (adult/general/children) can be played back.
- 7 to 2 - Only DVD software intended for general use and children can be played back.
- 1 - Only DVD software intended for children can be played back.

**3 Press [SETUP] to exit.**

**B: When you want to change the password,**

**1 Enter the 4-digit password in the password input field using [the Number buttons] (the password will be displayed as "\*" for your security), then press [ENTER].**

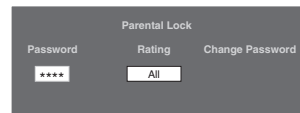

Change Password input field will appear.

**2 Select Change Password input field using [Cursor ◀ / ▶].**

**3 Enter the new 4-digit password in the password input field using [the Number buttons], then press [ENTER].**

**4 Press [SETUP] to exit.**

### Note

- Some DVD-Videos feature the Parental Lock function. If the rating of the inserted disc exceeds the level you set, playback will stop. You must enter a password before the disc will be played back.
- The parental lock function may not be available on some discs.
- It may be difficult to determine if some DVDs support the parental lock function. Be sure to confirm that the parental lock function operates in the way that you have set.
- Record the password in case you forget it.



- Press **[CLEAR]** to erase numbers entered incorrectly.  
If you forget your password or you want to clear all settings in Parental Lock, press and hold **[CLEAR]** for 8 seconds. Your password is cleared and parental levels are set to "All".

## 7. Angle Icon (Default: Off)

You can set to "On" to show the Angle icon on the screen whenever the feature is available.

(Follow steps 1 to 2 on page 94 and see page 76.)

**Select "Angle Icon" using [Cursor ▲ / ▼], then press [ENTER].**

**Select the desired setting using [Cursor ▲ / ▼], then press [ENTER].**



The selected setting will be checked and activated.

## 8. TV System (Default: PAL)

You can set the TV system.

(Follow steps 1 to 2 on page 94.)

**Select "TV System" using [Cursor ▲ / ▼], then press [ENTER].**

**Select the desired setting using [Cursor ▲ / ▼], then press [ENTER].**



The selected setting will be checked and activated.

- PAL:** Outputs a modified PAL signal for viewing discs recorded with the NTSC system on a PAL system TV.
- Auto:** Changes the video system (PAL / NTSC) automatically according to the format of the inserted disc.

### Note

- With discs recorded using the PAL system, a PAL signal is output for viewing on a PAL system TV.
- Discs recorded with the PAL system cannot be viewed on an NTSC system TV.
- With discs recorded using the NTSC system, an NTSC signal is output for viewing on an NTSC or Multi system TV.
- With discs recorded using the NTSC system, select PAL to view on a PAL system TV.

## 9. V. Replay/Skip Speed

Assign the **[VARIABLE REPLAY]** or **[VARIABLE SKIP]** button to rewind or skip by a certain amount of time.

(Follow steps 1 to 2 on page 94 and see page 72.)

**Select "V. Replay/Skip Speed" using [Cursor ▲ / ▼], then press [ENTER].**

Sub Menu will appear.

**Select a desired item to set using [Cursor ▲ / ▼], then press [ENTER].**

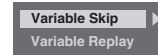

Refer to the explanations below and set the selected item.

**Variable Skip (Default: 30 seconds)**  
Sets the amount of skip time for **[VARIABLE SKIP]**.

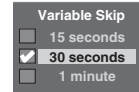

**Variable Replay (Default: 15 seconds)**  
Sets the amount of rewind time for **[VARIABLE REPLAY]**.

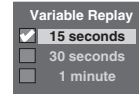

## 10. Initialise (Default: No)

Initialise the setting in Playback.

(Follow steps 1 to 2 on page 94.)

**Select "Initialise" using [Cursor ▲ / ▼], then press [ENTER].**

Confirmation window will appear.

**Select "Yes" using [Cursor ◀ / ▶], then press [ENTER].**

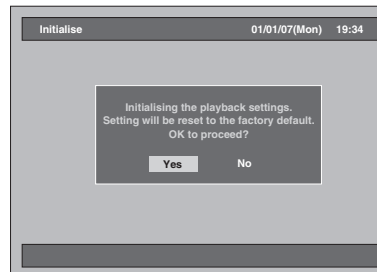

Your setting in Playback will be initialised.

Introduction

Connections

Basic Setup

Recording

Playback

Editing

Function Setup

VCR Functions

Others

## Recording

- 1 Press [SETUP] in stop mode.  
Setup Menu will appear.
- 2 Select "Recording" using [Cursor ▲ / ▼], then press [ENTER].

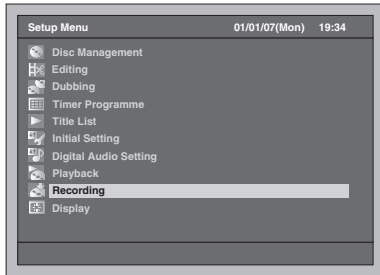

- 3 Select a desired item using [Cursor ▲ / ▼], then press [ENTER].

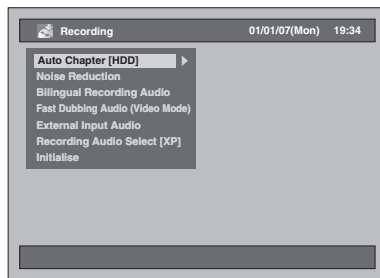

- 4 Refer to 1. to 3. on this page and set the selected item.
- 5 When you finish with the setting, press [SETUP] to exit.

### 1. Noise Reduction (Default: Off)

Set the noise reduction to reduce some noise in playback picture or to record in LP/EP/SLP mode.

(Follow steps 1 to 2 above.)

**Select "Noise Reduction" using [Cursor ▲ / ▼], then press [ENTER].**

Option window will appear.

**Select the desired setting using [Cursor ▲ / ▼], then press [ENTER].**



The selected setting will be checked and activated.

### 2. Fast Dubbing Audio (Video Mode) (Default: Off)

On: When recording a bilingual programme to the HDD and to make the Fast Dubbing (HDD to DVD (Video Mode)) available, the unit only records either Main or Sub audio. (See page 40.)

Off: When recording a bilingual programme to the HDD, the unit will record both Main and Sub audio, however, this makes it impossible to perform the Fast Dubbing (HDD to DVD (Video Mode)).

(Follow steps 1 to 2 on the left.)

**Select "Fast Dubbing Audio (Video Mode)" using [Cursor ▲ / ▼], then press [ENTER].**

Option window will appear.

**Select the desired setting using [Cursor ▲ / ▼], then press [ENTER].**

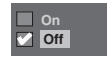

The selected setting will be checked and activated.

### 3. Initialise (Default: No)

Initialise the setting in Recording.

(Follow steps 1 to 2 on the left.)

**Select "Initialise" using [Cursor ▲ / ▼], then press [ENTER].**

Confirmation window will appear.

**Select "Yes" using [Cursor ◀ / ▶], then press [ENTER].**



Your setting in Recording will be initialised.

## Display

- 1 Press [SETUP] in stop mode.**  
Setup Menu will appear.
- 2 Select "Display" using [Cursor ▲ / ▼], then press [ENTER].**

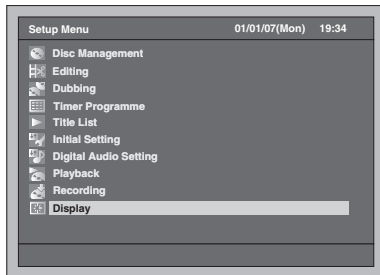

- 3 Select a desired item using [Cursor ▲ / ▼], then press [ENTER].**

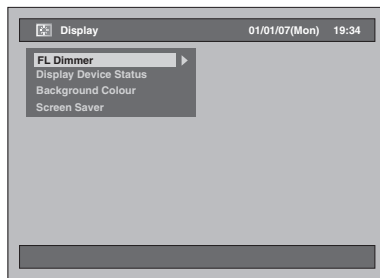

- 4 Refer to 1. to 4. on this page and set the selected item.**
- 5 When you finish with the setting, press [SETUP] to exit.**

### 1. FL Dimmer (Default: Auto)

Set the front panel display brightness. You can choose one from "Auto," "Bright" and "Dark". If "Auto" is selected, the display gets dark when the power is off.

(Follow steps 1 to 2 above.)

**Select "FL Dimmer" using [Cursor ▲ / ▼], then press [ENTER].**

Option window will appear.

**Select the desired setting using [Cursor ▲ / ▼], then press [ENTER].**

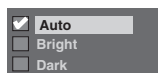

The selected setting will be checked and activated.

### 2. Display Device Status (Default: On)

Set the operating display.

(Follow steps 1 to 2 on the left.)

**Select "Display Device Status" using [Cursor ▲ / ▼], then press [ENTER].**

Option window will appear.

**Select the desired setting using [Cursor ▲ / ▼], then press [ENTER].**

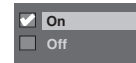

The selected setting will be checked and activated.

On: Shows the operating display.

Off: Does not show the operating display.

### 3. Background Colour (Default: On)

Set the background colour.

When there is no signal for the picture signal input, the screen changes to blue background.

(Follow steps 1 to 2 on the left.)

**Select "Background Colour" using [Cursor ▲ / ▼], then press [ENTER].**

Option window will appear.

**Select the desired setting using [Cursor ▲ / ▼], then press [ENTER].**

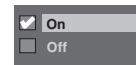

The selected setting will be checked and activated.

### 4. Screen Saver (Default: On)

You can set to "On" to activate the Screen Saver after 15 minutes of no activity.

(Follow steps 1 to 2 on the left.)

**Select "Screen Saver" using [Cursor ▲ / ▼], then press [ENTER].**

Option window will appear.

**Select the desired setting using [Cursor ▲ / ▼], then press [ENTER].**

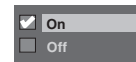

The selected setting will be checked and activated.

Introduction

Connections

Basic Setup

Recording

Playback

Editing

Function Setup

VCR Functions

Others

# VCR Functions

## Playback



- 1 Press [I/O ON / STANDBY] to turn on the unit.**  
To play back a tape, turn on the TV and be sure to select the input to which the unit is connected.
- 2 Press [VCR].**
- 3 Insert a pre-recorded tape, then press [PLAY ►] to begin playback.**
- 4 During playback, press [PAUSE II].**  
Playback will be paused and sound will be muted.
- 5 Press [PLAY ►] to resume playback.**
- 6 Press [STOP ■] to stop playback.**
- 7 Press [OPEN / CLOSE ▲] to eject the tape.**

### Note

- When a tape without record tab is inserted, the unit will start playback automatically.
- Tracking will be automatically adjusted upon playback. To adjust the tracking manually, press [PROG. ^ / v].

## Recording and One-touch Timer Recording (OTR)

### Basic Recording



#### Before recording, make sure:

- The desired channel is selected by pressing [the Number buttons] or [PROG. ^ / v] on the remote control.
- There is a tape with a record tab in the unit.
- The desired recording speed is selected in SP (standard play) or LP (long play) mode by pressing [REC MODE] on the remote control.

Tape speed	Recording / Playback Time			
Type of tape	E60	E120	E180	E240
SP mode	1 hour	2 hours	3 hours	4 hours
LP mode	2 hours	4 hours	6 hours	8 hours

- 1 Turn on the unit and insert a recordable tape.**

Make sure that the TV input is set on the unit.

- 2 Press [VCR].**

- 3 Press [REC ●] to start recording.**

To temporarily stop recording or to resume it, press [PAUSE II].

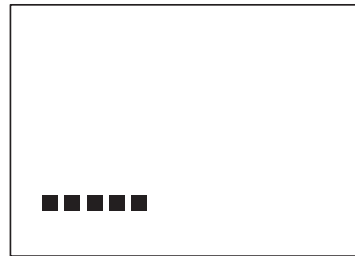

After the unit has been in pause mode for 5 minutes, it will stop automatically to protect the tape and the video head from damage.

- 4 Press [STOP ■] when the recording is completed.**

### Accidental erasure prevention

To prevent accidental recording on a recorded cassette, remove its record tab. To record on it later, cover the hole with cellophane tape.

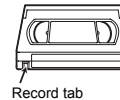

Record tab

### Note

- Although you can playback a videotape recorded in the SP or LP mode on this unit, SLP mode recording is not available.
- Timer Recording is not available for VCR.
- When VCR recording and the Timer Recording are overlapping, the Timer Recording has its priority.
- The unit will automatically switch to the programmed channel 15 seconds before the programmed time, and the VCR recording will be cancelled except when their recording channel is the same. If their recording channel is the same, the Timer Recording will start without cancelling the VCR recording, and the recording will be made on both VCR and the HDD / DVD.

#### To view one channel while recording another:

If you want to watch the TV programmes, simply select the channel you want to watch with the TV's remote.

## One-touch Timer Recording



This feature allows you to set the recording length simply by pressing [REC ●].

- 1 Turn on the unit and insert a recordable tape.**  
Make sure that the TV input is set on the unit.
- 2 Press [VCR].**
- 3 Select the recording speed using [REC MODE].** (See page 100.)
- 4 Select the desired channel to record using [PROG. ^ / v] or [the Number buttons].**
- 5 Press [REC ●] repeatedly until the desired recording time (15 minutes to 4 hours) appears on the TV screen.**

One-touch Timer Recording will start.

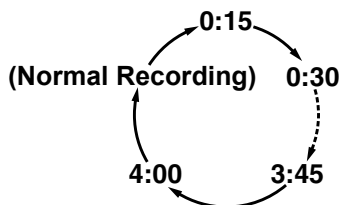

- When the unit reaches the specified time, it will be turned off automatically.
- To change the recording length during One-touch Timer Recording, press [REC ●] repeatedly until the desired length appears.
- To cancel One-touch Timer Recording within the specified time, press [STOP ■].

### Note

- The remaining recording time will appear on the front panel display during a One-touch Timer Recording. Press [DISPLAY] can also see the remaining recording time on the TV screen.
- You cannot pause a One-touch Timer Recording.
- When VCR recording and the Timer Recording are overlapping, the Timer Recording has its priority.
- The unit will automatically switch to the programmed channel 15 seconds before the programmed time, and the VCR recording will be cancelled except when their recording channel is the same. If their recording channel is the same, the Timer Recording will start without cancelling the VCR recording, and the recording will be made on both VCR and the HDD / DVD.

## Search

### Index Search



An index mark will be assigned at the beginning of each recording you make. You may skip to a specific marked point by following the steps below.

- 1 Press [VCR].**
- 2 Press [SEARCH] to display the index search menu.**
- 3 Enter the number of recordings you want to skip using [the Number buttons] within 30 seconds.**
- 4 Press [FWD / SLOW ►►] or [SLOW / REV ◀◀] to start index search.**

If you want to go in the forward direction, press [FWD / SLOW ►►].

If you want to go in the reverse direction, press [SLOW / REV ◀◀].

After index search, the VCR will play back the tape automatically.

### Note

- This function is not available during recording.

### Time Search



This feature allows you to go to a specific point on a tape by entering the exact amount of time you want to skip in order to reach the point.

- 1 Press [VCR].**
- 2 Press [SEARCH] repeatedly until the time search menu appears.**
- 3 Enter your desired time to skip using [the Number buttons] within 30 seconds.**
- 4 Press [FWD / SLOW ►►] or [SLOW / REV ◀◀] to start time search.**

If you want to go in the forward direction, press [FWD / SLOW ►►].

If you want to go in the reverse direction, press [SLOW / REV ◀◀].

After time search, the unit will play back the tape automatically.

### Note

- This function is not available during recording.
- Press [STOP ■] to stop the search.
- If the tape reaches the end during the Search, this unit will cancel it and rewind the tape.

Introduction

Connections

Basic Setup

Recording

Playback

Editing

Function Setup

VCR Functions

Others

## Other Operations



Press **[VCR]** first.

**To cue or review picture during playback**

**(Picture Search):**

Press **[FWD / SLOW ►►]** or **[SLOW / REV ◄◄]** during playback.

Press it again and the unit will search in super high speed.

**To freeze the picture on TV screen during playback (Still mode):**

Press **[PAUSE II]** during playback. Each time you press the button, the picture will be forwarded frame by frame.

If the picture begins to vibrate vertically during the still mode, stabilise the picture by pressing the **[PROG. ^ / ∨]**.

If the picture is distorted or rolling vertically, adjust the vertical hold control on your TV, if equipped.

**To reset the tape counter:**

Press **[CLEAR]**.

**To play back in slow motion:**

Press **[FWD / SLOW ►►]** during the still mode.

If the noise bars appear on the TV screen, you can reduce it by pressing **[PROG. ^ / ∨]**.

### Note

- Still / Slow mode will be automatically cancelled after 5 minutes to prevent damage to the tape and the video head.
- To return to normal play back from the Picture Search / Still / Slow mode, press **[PLAY ►]**.

## Changing the Video Colour System



Press **[VCR]** first.

Different countries use different television colour systems.

This unit will distinguish the video colour system (MESECAM or PAL) automatically according to the format of a pre-recorded video tape during playback or the input signal from the tuner or external devices.

To change the video colour system manually, press **[MODE]**.

Each time you press **[MODE]**, the colour system will change as follows.

→ **AUTO** → **MESECAM** → **PAL** →

### Note

- If the playback picture on the TV screen is black and white, change the video colour system manually.
- When you change the video colour system manually, be sure to change it before recording. If you select the wrong video colour system for recording, the colour of the picture may be deteriorated.

## Hi-Fi Stereo Sound System

This unit will record and playback Hi-Fi stereo sound. In addition, it has an AV2 and NICAM stereo sound decoder. This unit will receive stereo and bilingual broadcasts and it is possible to record in several ways and to play back the sound.

### Selecting the Sound Mode

You can select each mode by pressing **[AUDIO ◻◻◻]** on the remote control. Each mode is indicated on the TV screen as following.

- During playback of the recorded tape in Hi-Fi mode

Mode	Audio output	Display on the TV screen
Stereo	Stereo	STEREO
L	L audio from both speakers	LEFT
R	R audio from both speakers	RIGHT
Normal	Monaural	MONO

- During reception of bilingual broadcasts

Mode	Audio output	Display on the TV screen
Main	Main audio from the both speakers	Main
Sub	Sub audio from the both speakers	Sub
Main / Sub	<ul style="list-style-type: none"> <li>• Main audio from the left speaker</li> <li>• Sub audio from the right speaker</li> </ul>	Main Sub

### Note

- If you play back non-Hi-Fi tapes, the unit will play back automatically in monaural even if you select any mode.
- If the stereo signal becomes weak, the broadcast is automatically recorded in monaural.

# Others

## Troubleshooting

Before requesting service for this unit, check the table below for a possible cause of the problem you are experiencing. Some simple checks or a minor adjustment on your part may eliminate the problem and restore proper performance.

Error message for HDD/DVD	Possible Cause	Solution
Operation could not be completed successfully. There may be a problem with the disc.	<ul style="list-style-type: none"> <li>The disc may be dirty or have scratches.</li> </ul>	<ul style="list-style-type: none"> <li>Check and clean the disc if necessary. (See pages 5 and 12.)</li> </ul>
There is no title in the original list.	<ul style="list-style-type: none"> <li>Nothing has been recorded yet.</li> <li>There is no title in the Original.</li> </ul>	<ul style="list-style-type: none"> <li>Record some programmes. (See page 42.)</li> </ul>
There is no playlist.	<ul style="list-style-type: none"> <li>Playlist has not been created yet.</li> <li>+VR mode disc or Video mode disc may be inserted.</li> </ul>	<ul style="list-style-type: none"> <li>Create a Playlist first. (See page 79.)</li> </ul>
There are no editable playlists.	<ul style="list-style-type: none"> <li>There is only one title in the Playlist. It requires more than two titles to perform this editing feature.</li> </ul>	<ul style="list-style-type: none"> <li>Create more than two titles in the Playlist. (See page 79.)</li> </ul>
No more titles can be added. The number of titles exceeds the limit.	<ul style="list-style-type: none"> <li>You only can register up to 18 titles in the Dubbing Title List.</li> </ul>	<ul style="list-style-type: none"> <li>Delete unnecessary titles from the Dubbing Title List. (See page 53.)</li> </ul>
Cannot perform the dubbing. The title is copy-protected.	<ul style="list-style-type: none"> <li>Undubbable disc, such as DVD-Video disc, may be inserted.</li> </ul>	<ul style="list-style-type: none"> <li>Insert a dubbable disc. (See page 48.)</li> </ul>
Cannot perform the dubbing.	<ul style="list-style-type: none"> <li>The disc may be unrecordable, or there is no disc in the unit.</li> </ul>	<ul style="list-style-type: none"> <li>Insert a dubbable disc. (See page 48.)</li> </ul>
Cannot perform the dubbing. Insufficient disc space.	<ul style="list-style-type: none"> <li>The space in the recording media is not enough for the dubbing.</li> </ul>	<ul style="list-style-type: none"> <li>Make sufficient space in the recording media.</li> </ul>
Cannot perform the dubbing. Use a CPRM compatible disc.	<ul style="list-style-type: none"> <li>You are trying to dub a copy-once programme to a non-CPRM compatible disc. Copy-once programmes can only be moved to a CPRM compatible disc.</li> </ul>	<ul style="list-style-type: none"> <li>Use a CPRM compatible disc.</li> </ul>
Could not perform the dubbing.	<ul style="list-style-type: none"> <li>There may be insufficient space in the HDD because the Fast Dubbing from DVD to HDD and the HDD recording are proceeding simultaneously.</li> </ul>	<ul style="list-style-type: none"> <li>Check the dubbing title or the recording media.</li> </ul>
The operation is currently unavailable.	<ul style="list-style-type: none"> <li>You are not allowed to edit a Timer Programme during or 10 seconds before the Timer Recording of the selected Timer Programme.</li> </ul>	<ul style="list-style-type: none"> <li>Stop the recording if you want to edit the Timer Programme in recording. (See pages 42 and 43.)</li> </ul>
All or part of the programme will not be recorded.	<ul style="list-style-type: none"> <li>Timer Programmes may be overlapping.</li> </ul>	<ul style="list-style-type: none"> <li>Check the Timer Programmes.</li> </ul>
Incorrect password.	<ul style="list-style-type: none"> <li>Incorrect password was entered.</li> </ul>	<ul style="list-style-type: none"> <li>Enter correct password. If you have forgotten the password, press and hold <b>[CLEAR]</b> for 8 seconds.</li> </ul>
Cannot read disc. Either the disc is unsupported, or it is scratched or dirty.	<ul style="list-style-type: none"> <li>The disc may not be supported by this unit, or it may be dirty or have scratches.</li> </ul>	<ul style="list-style-type: none"> <li>Use only the discs supported by this unit (see page 60), or clean the disc if necessary (see pages 5 and 12).</li> </ul>
Region Code Error. Cannot play disc.	<ul style="list-style-type: none"> <li>The disc's region code is not supported by this unit.</li> </ul>	<ul style="list-style-type: none"> <li>Use only the discs with the region code supported by this unit. (See pages 10 and 60.)</li> </ul>
Number of recordable titles exceeded.	<ul style="list-style-type: none"> <li>You are trying to record when total title number is already at the limit.</li> </ul>	<ul style="list-style-type: none"> <li>Delete unnecessary titles. (See page 81.)</li> </ul>
Total number of chapters exceeds the limit.	<ul style="list-style-type: none"> <li>You are trying to record when total chapter number is already at the limit.</li> </ul>	<ul style="list-style-type: none"> <li>Delete unnecessary chapters. (See page 78.)</li> </ul>
Recording is stopped. There are some problems with the disc.	<ul style="list-style-type: none"> <li>The disc may be dirty or have scratches.</li> </ul>	<ul style="list-style-type: none"> <li>Check and clean the disc if necessary. (See pages 5 and 12.)</li> </ul>
HDD Error.		<ul style="list-style-type: none"> <li>Turn the power off, then on again. If the problem cannot be solved yet, please call an Authorised Service Centre.</li> </ul>
DVD Error.		<ul style="list-style-type: none"> <li>Turn the power off, then on again. If the problem cannot be solved yet, please call an Authorised Service Centre.</li> </ul>

Introduction

Connections

Basic Setup

Recording

Playback

Editing

Function Setup

VCR Functions

Others

Error message for HDD/DVD	Possible Cause	Solution
Insufficient disc space in the recording media.	<ul style="list-style-type: none"><li>The space in the recording media is not enough for the selected Rec Mode.</li></ul>	<ul style="list-style-type: none"><li>Make sufficient space in the recording media, or change the Rec Mode. (See page 35.)</li></ul>
Cannot dub because the allowable number of Edit Marks or chapters has been exceeded.	<ul style="list-style-type: none"><li>You are trying to dub when total chapter or Edit Mark number in the DVD is already at its limit.</li></ul>	<ul style="list-style-type: none"><li>Delete unnecessary chapters in the DVD. (See page 78.) (Edit Marks cannot be deleted.)</li></ul>
Insufficient disc space.	<ul style="list-style-type: none"><li>The space in the recording media is not enough.</li></ul>	<ul style="list-style-type: none"><li>Make sufficient space in the recording media.</li></ul>



	Symptom	Solution
<b>POWER</b>	The power does not turn on.	<ul style="list-style-type: none"> <li>• Check that the AC power cord is connected securely.</li> <li>• Batteries of the remote control are weak.</li> </ul>
	The unit turns on automatically without any operation.	<ul style="list-style-type: none"> <li>• The unit turns on automatically 2 minutes before the Timer Recording.</li> </ul>
	The OSD Language Menu appears every time the power turns on.	<ul style="list-style-type: none"> <li>• Finish up the Language Setting procedure by selecting a language in the OSD Language Menu. Press <b>[ENTER]</b> to activate the setting.</li> </ul>
	The power turns off automatically.	<ul style="list-style-type: none"> <li>• The power turns off automatically when abnormality is detected on the disc. Press <b>[ON / STANDBY]</b> or <b>[OPEN / CLOSE ▲]</b> on the unit to open the disc tray, and before it is opened completely, press the button again. Then take out the disc.</li> <li>• The power turns off automatically when an OTR is completed.</li> </ul>

	Symptom	Solution
<b>GENERAL</b>	The unit does not function.	<ul style="list-style-type: none"> <li>• “ ” or error message appears if the operation is prohibited.</li> <li>• Batteries of the remote control are weak or exhausted.</li> </ul>
	No picture, sound or menu appears on the screen.	<ul style="list-style-type: none"> <li>• Check if the connections are made securely and correctly.</li> <li>• Check if the cables are damaged.</li> <li>• Check if a correct external input channel is selected on your TV. (See page 25.)</li> <li>• Check if you have completed the Channel Setting. (See pages 27 to 30.)</li> </ul>
	Clock Setting and Channel Setting cannot be performed.	<ul style="list-style-type: none"> <li>• If a recording is in progress, these operations cannot be performed.</li> </ul>
	The unit does not operate properly.	<ul style="list-style-type: none"> <li>• Moisture has condensed inside the unit. Remove the disc and leave the unit turned on for about two hours until the moisture evaporates. (See page 3.)</li> </ul>

	Symptom	Solution
<b>CHANNEL</b>	TV channels cannot be changed.	<ul style="list-style-type: none"> <li>• Check if the connections are made securely and correctly.</li> <li>• Check if the cables are damaged.</li> <li>• Try Channel Setting by following the steps on pages 27 to 30.</li> </ul>
	Only specific channels do not appear.	<ul style="list-style-type: none"> <li>• The channels may be set to be skipped. (See page 28.)</li> </ul>
	The external input channels (such as AV1, AV2 or AV3) cannot be skipped.	<ul style="list-style-type: none"> <li>• This unit does not skip the external input channels. This is not a malfunction.</li> </ul>

	Symptom	Solution
<b>RECORDING</b>	<b>GENERAL</b>	
	The image from the external device cannot be displayed or recorded.	<ul style="list-style-type: none"> <li>• Try pressing <b>[INPUT SELECT </b>] repeatedly.</li> <li>• Turn on all connected devices.</li> <li>• Check if the connections are made securely and correctly.</li> </ul>
	<b>HDD/DVD</b>	
Recording is impossible.	<ul style="list-style-type: none"> <li>• This unit cannot record programmes that contain copy protection signal. This is not a malfunction.</li> <li>• The space of the recording media may be used up. Try deleting unnecessary titles from the Original, or exchange it with the recordable media.</li> <li>• The maximum number of titles or chapters has exceeded. Delete the unnecessary titles to make enough space or insert a new recordable media.</li> <li>• Check if the connections are made securely and correctly.</li> </ul>	
Timer Recording cannot be performed.	<ul style="list-style-type: none"> <li>• The internal clock of the unit may have been stopped due to a power failure that lasted for more than 30 seconds. Reset the clock. (See pages 30 to 31.)</li> </ul>	
<b>DVD</b>		
Recording is impossible.	<ul style="list-style-type: none"> <li>• Copy-once programmes can only be recorded on a CPRM compatible VR mode DVD-RW.</li> <li>• Check if the disc is protected or finalised. Undo the protection or the finalisation.</li> <li>• DVD-RW once formatted with other DVD recorders cannot be recorded on this unit. This is not a malfunction.</li> <li>• Video mode DVDs recorded by other DVD recorders cannot be used on this unit unless finalised.</li> <li>• Check if the connections are made securely and correctly.</li> </ul>	
<b>VCR</b>		
Recording is impossible.	<ul style="list-style-type: none"> <li>• Check if a videotape is inserted.</li> <li>• Check if a videotape has a record tab intact.</li> </ul>	

Introduction

Connections

Basic Setup

Recording

Playback

Editing

Function Setup

VCR Functions

Others

	Symptom	Solution	
GENERAL	TV aspect ratio does not match your TV screen.	<ul style="list-style-type: none"> <li>• Check the TV Aspect Ratio. (See pages 32 to 33.)</li> <li>• A different aspect ratio will be used when the aspect ratio specified by the disc is not supported by this unit.</li> </ul>	
	Playback picture is distorted. Colour of the picture is abnormal.	<ul style="list-style-type: none"> <li>• During fast forward or fast reverse, playback picture may be distorted. This is not a malfunction.</li> <li>• Connect to TV directly. When you connect this unit with the television via VCR or other devices, the picture may be distorted due to the copy-protection signal.</li> <li>• Check if the cables are damaged.</li> <li>• Keep the equipment which may cause electrical disturbances, such as a cellular phone, away.</li> </ul>	
	There is no sound, or no subtitle.	<ul style="list-style-type: none"> <li>• Turn on all connected devices.</li> <li>• Check if the external input channel is set correctly.</li> <li>• Check if the connections are made securely and correctly.</li> </ul>	
HDD/DVD	Playback does not start from the beginning.	<ul style="list-style-type: none"> <li>• Resume function may be activated. See page 69 to cancel the resume point.</li> </ul>	
PLAYBACK	DVD	Playback cannot be performed.	<ul style="list-style-type: none"> <li>• Check if the playable disc is inserted.</li> <li>• Check if the disc is loaded correctly with the labelled side facing up.</li> <li>• Discs made on other devices or on personal computers cannot be played back on this unit unless it is finalised on the device. Even if it is finalised, the performance of those discs are not guaranteed on this unit.</li> <li>• The disc may be dirty or flawed. Clean the disc.</li> <li>• Check if all the connections are made correctly.</li> <li>• Check the Parental Lock Setting. (See page 96.)</li> </ul>
		There is no sound, or no subtitle.	<ul style="list-style-type: none"> <li>• Check if the Digital Audio Setting is set correctly. (See pages 93 to 94.)</li> <li>• There is a possibility that the selected subtitle language is not supported by the disc.</li> </ul>
	Digital Audio Setting cannot be changed to main audio (L), sub audio (R) or combination of both.	<ul style="list-style-type: none"> <li>• If the audio source is in the Dolby Digital format, set the Dolby Digital Setting to "PCM" in the Setup Menu. (See page 93.)</li> </ul>	
	Audio Language or the Subtitle Language of the DVD cannot be changed.	<ul style="list-style-type: none"> <li>• Multilingual subtitles are not supported by the disc.</li> <li>• Some audio languages or the subtitle languages can be changed only from the Disc Menu. Please refer to the disc's manual.</li> </ul>	
	Camera angles cannot be changed.	<ul style="list-style-type: none"> <li>• Even though the multi-angle feature is supported by the disc, that does not mean all the scenes are shot from multi-angles. Changing angles are available only for those scenes shot from the multi-angle.</li> </ul>	
	The disc cannot be played back on other player even though it is finalised properly.	<ul style="list-style-type: none"> <li>• Some DVD players do not play back the disc made on other recorder. Refer to the manual of the unit.</li> </ul>	
	VCR	VCR picture is noisy.	<ul style="list-style-type: none"> <li>• Adjust the tracking by pressing <b>[PROG. ^ / v]</b> while you are playing a videotape.</li> </ul>
	During VCR playback, pictures do not come out even though sound does.	<ul style="list-style-type: none"> <li>• VCR Head cleaning may be necessary. Refer to "AUTO HEAD CLEANING" on page 5.</li> </ul>	

		Symptom	Solution
<b>EDITING</b>	<b>HDD/DVD</b>	Titles cannot be edited or deleted.	<ul style="list-style-type: none"> <li>The titles or the disc itself may be protected. Cancel the protection by following the steps on page 85 for title protection and page 58 for disc protection.</li> </ul>
		The capacity of the disc doesn't increase even if the recorded programme is deleted.	<ul style="list-style-type: none"> <li>Deleting a title in the Playlist will not increase the capacity, try deleting a title in the Original.</li> </ul>
		Dubbing cannot be executed.	<ul style="list-style-type: none"> <li>When the number of the titles or the chapters exceeds the maximum recordable number, the dubbing will not be executed.</li> <li>Copy-once programmes or the copy protected programmes may not be dubbed depending on the recording media. Regarding the limitations on dubbing, refer to the page 48.</li> </ul>
	<b>DVD</b>	Titles cannot be edited or deleted.	<ul style="list-style-type: none"> <li>The titles in the Video mode / VR mode discs cannot be edited or deleted if they are finalised. Undo the finalisation by following the steps on page 57.</li> </ul>
		The capacity of the disc doesn't increase even if the recorded programme is deleted.	<ul style="list-style-type: none"> <li>With Video mode DVD-RW discs, the disc space will increase only when the last title in the Original is deleted. With DVD-R / +R discs, deleting a title will not increase the disc space.</li> </ul>
		Dubbing cannot be executed.	<ul style="list-style-type: none"> <li>Video mode discs made on other recorder cannot be dubbed using this unit.</li> </ul>

		Symptom	Solution
<b>REMOTE CONTROL</b>		The remote control does not function.	<ul style="list-style-type: none"> <li>No batteries in the remote or the batteries may be weak. Replace the batteries.</li> <li>Make sure there is no obstacle between the remote and the unit.</li> <li>Try getting closer to the unit. (See page 20.)</li> <li>Make sure to press the Device Select Buttons (<b>[HDD]</b>, <b>[DVD]</b> or <b>[VCR]</b>) before operating on the device of your choice.</li> <li>If above solutions do not solve the problem, please call an Authorised Service Centre.</li> </ul>
		Setup Menu Screen does not display when <b>[SETUP]</b> is pressed.	<ul style="list-style-type: none"> <li>While the disc is loading, <b>[SETUP]</b> does not respond.</li> </ul>

		Symptom	Solution
<b>OTHERS</b>		The Clock display does not appear in the Front Panel Display.	<ul style="list-style-type: none"> <li>Check that the AC power cord is connected securely.</li> <li>(In case of power failure) Check the breaker and Clock Setting.</li> </ul>
		When you forget the password for Parental Lock.	<ul style="list-style-type: none"> <li>Please cancel the password and the set level. (See page 96.)</li> </ul>

\* If you are still having trouble with this unit after checking "Troubleshooting", write down the error message and the error description, and please call an Authorised Service Centre.

Introduction

Connections

Basic Setup

Recording

Playback

Editing

Function Setup

VCR Functions

Others

## Language Code

Language	Code	Language	Code	Language	Code	Language	Code
Abkhazian	4748	French	5264	Lithuanian	5866	Sindhi	6550
Afar	4747	Frisian	5271	Macedonian	5957	Singhalese	6555
Afrikaans	4752	Galician	5358	Malagasy	5953	Siswat	6565
Albanian	6563	Georgian	5747	Malay	5965	Slovak	6557
Amharic	4759	German	5051	Malayalam	5958	Slovenian	6558
Arabic	4764	Greek	5158	Maltese	5966	Somali	6561
Armenian	5471	Greenlandic	5758	Maori	5955	Spanish	5165
Assamese	4765	Guarani	5360	Marathi	5964	Sundanese	6567
Aymara	4771	Gujarati	5367	Moldavian	5961	Swahili	6569
Azerbaijani	4772	Hausa	5447	Mongolian	5960	Swedish	6568
Bashkir	4847	Hebrew	5569	Nauru	6047	Tagalog	6658
Basque	5167	Hindi	5455	Nepali	6051	Tajik	6653
Bengali; Bangla	4860	Hungarian	5467	Norwegian	6061	Tamil	6647
Bhutani	5072	Icelandic	5565	Occitan	6149	Tatar	6666
Bihari	4854	Indonesian	5560	Oriya	6164	Telugu	6652
Bislama	4855	Interlingua	5547	Oromo (Afan)	6159	Thai	6654
Breton	4864	Interlingue	5551	Panjabi	6247	Tibetan	4861
Bulgarian	4853	Inupiak	5557	Pashto; Pushto	6265	Tigrinya	6655
Burmese	5971	Irish	5347	Persian	5247	Tonga	6661
Byelorussian	4851	Italian	5566	Polish	6258	Tsonga	6665
Cambodian	5759	Japanese	5647	Portuguese	6266	Turkish	6664
Catalan	4947	Javanese	5669	Quechua	6367	Turkmen	6657
Chinese	7254	Kannada	5760	Rhaeto-Romance	6459	Twi	6669
Corsican	4961	Kashmiri	5765	Romanian	6461	Ukrainian	6757
Croatian	5464	Kazakh	5757	Russian	6467	Urdu	6764
Czech	4965	Kinyarwanda	6469	Samoan	6559	Uzbek	6772
Danish	5047	Kirghiz	5771	Sangho	6553	Vietnamese	6855
Dutch	6058	Kirundi	6460	Sanskrit	6547	Volapuk	6861
English	5160	Korean	5761	Scots Gaelic	5350	Welsh	4971
Esperanto	5161	Kurdish	5767	Serbian	6564	Wolof	6961
Estonian	5166	Laothian	5861	Serbo-Croatian	6554	Xhosa	7054
Faroese	5261	Latin	5847	Sesotho	6566	Yiddish	5655
Fiji	5256	Latvian; Lettish	5868	Setswana	6660	Yoruba	7161
Finnish	5255	Lingala	5860	Shona	6560	Zulu	7267

## Glossary

### **Analogue audio**

An electrical signal that directly represents sound. In contrast, digital audio can also be an electrical signal, but is an indirect representation of sound. See also Digital audio.

### **Aspect ratio**

The width of a TV screen relative to its height. Conventional TVs are 4:3 (i.e., the screen is almost square). Widescreen models are 16:9 (the screen is almost twice as wide as its height).

### **Chapter**

Just as a book is split up into several chapters, a title on a DVD disc is usually divided into chapters. See also Title.

### **CPRM (Content Protection for Recordable Media)**

CPRM is a scrambling copy protection system for the protection of "copy-once" broadcast programmes (e.g. some satellite broadcasts).

### **Digital audio**

An indirect representation of sound using numbers. During recording, the sound is measured at discrete intervals (44,100 times a second for CD audio) by an analogue-to-digital converter, generating a stream of numbers. On playback, a digital-to-analogue converter generates an analogue signal based on these numbers. See also Sampling frequency and Analogue audio.

### **Dolby Digital**

A system developed by Dolby Laboratories that compresses digital sound. It works with stereo (2ch) or multi-channel audio.

### **DTS (Digital Theater System)**

DTS is a multi channel surround sound system, but it is different from Dolby Digital. DTS surround sound technologies were developed by DTS, Inc.

### **Finalise**

To make DVDs that have been recorded playable in DVD players, finalise DVD-RW / R and DVD+RW / R discs with this unit.

### **JPEG (Joint Photographic Experts Group)**

JPEG is a method of compressing still image files. You can copy JPEG files on CD-RW / R discs from a computer and play back the files on this unit.

### **MP3 (MPEG Audio Layer 3)**

MP3 is a method of compressing files. You can copy MP3 files on CD-RW / R discs from a computer and play back the files on this unit.

### **PBC (Video CD only) (Playback Control)**

This function enables you to play back interactive software using a menu screen. See also Title.

### **PCM (Pulse Code Modulation)**

PCM is a format that converts audio into digital data. It is mainly used for Audio CDs and DAT. This unit can play back sounds as realistic as possible by converting even compressed Dolby Digital and MPEG audio to PCM.

### **Playlist**

From this list you can play back contents of a disc in your desired order or in sequence. It is also possible to directly search for a specific scene.

### **Region code**

Regions associate discs and players with particular areas of the world. This unit will only play back discs that have compatible region codes. You can find the region code of your unit by looking on the rear panel. Some discs are compatible with more than one region (or all regions).

### **Sampling frequency**

The rate at which sound is measured by a specified interval to turn it into digital audio data. The number of samples in one second is defined as the sampling frequency. The higher the rate is, the better the possible sound quality.

### **S-Video output**

Video is output as the individual signals of colour(C) and luminance(Y), so a higher-quality picture will be displayed.

### **Title**

(DVD)  
A collection of chapters on a DVD. See also chapter.

### **(Video CD)**

The contents of a Video CD. When playing back a Video CD with the PBC function, the title menu will appear automatically.

### **Track**

Audio CDs and Video CDs use tracks to divide the contents of a disc. The DVD equivalent is called a chapter. See also Chapter.

Introduction

Connections

Basic Setup

Recording

Playback

Editing

Function Setup

VCR Functions

Others

## Specifications

### General

System	HDD, DVD-Video, DVD-RW / R, DVD+RW / R, VCD, CD-DA, CD-RW / R, Video Cassette Tape
VCR video heads	Four heads
HDD	Internal 3.5 inch HDD 160 GB
Power requirements	220–240 V $\sim$ $\pm$ 10%, 50 Hz $\pm$ 0.5%
Power consumption	60 W (standby: 8.0 W)
Weight	5.8 kg
Dimensions (width x height x depth)	435 x 99.5 x 380 mm
Operating temperature	5°C to 40°C
Operating humidity	Less than 80% (no condensation)
TV format	PAL / SECAM - BG / DK

### Recording

Recording format	Video Recording format (DVD-RW only), Video format (DVD-RW, DVD-R) +VR format (DVD+RW, DVD+R)
Recordable discs	DVD-ReWritable, DVD-Recordable, DVD+ReWritable, DVD+Recordable
<b>Video recording format</b>	
Sampling frequency	13.5 MHz
Compression format	MPEG2
<b>Audio recording format</b>	
Sampling frequency	48 kHz
Compression format	Dolby Digital

### Tuner

Receivable channels	E2-E69
---------------------	--------

### Input/Output

#### Front Panel : (AV3)

Video input	One RCA connector
Input level	1 Vp-p (75 $\Omega$ )
S-Video input	One Mini DIN 4-pin jack
Input level	Y (luminance) 1 Vp-p (75 $\Omega$ ) C (colour) 300 mVp-p (75 $\Omega$ )
Audio input	Two RCA connectors
Input level	2 Vrms (input impedance: more than 10 k $\Omega$ )

#### Rear Panel

VHF/UHF antenna input/output terminal	VHF/UHF set 75 $\Omega$
Audio input /output	Two 21-pin scart sockets (AV1, AV2)
Video input /output	Two 21-pin scart sockets (AV1, AV2)
Input /output level	1Vp-p (75 $\Omega$ ) each
S-Video output	One Mini DIN 4-pin jacks
Output level	Y (luminance) 1 Vp-p (75 $\Omega$ ) C (colour) 300 mVp-p (75 $\Omega$ )
Component video out	Three RCA connectors
Output level	Y: 1.0 Vp-p (75 $\Omega$ ) PB/CB, PR/CR: 0.7 Vp-p (75 $\Omega$ ) each
Analogue audio output	Two RCA connectors
Output level	2 Vrms (output impedance: $\approx$ 680 $\Omega$ )
Digital audio out	One Coaxial pin jack
Output level	500 mVp-p (75 $\Omega$ )

### Note

- The specifications and design of this unit are subject to change without notice.

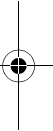

## Free Manuals Download Website

<http://myh66.com>

<http://usermanuals.us>

<http://www.somanuals.com>

<http://www.4manuals.cc>

<http://www.manual-lib.com>

<http://www.404manual.com>

<http://www.luxmanual.com>

<http://aubethermostatmanual.com>

Golf course search by state

<http://golfingnear.com>

Email search by domain

<http://emailbydomain.com>

Auto manuals search

<http://auto.somanuals.com>

TV manuals search

<http://tv.somanuals.com>