

# TOSHIBA

Hi-Fi **VHS** SQPB  
Video Cassette Recorder  
**W-622**

---

*OWNER'S MANUAL*



# SAFETY PRECAUTIONS

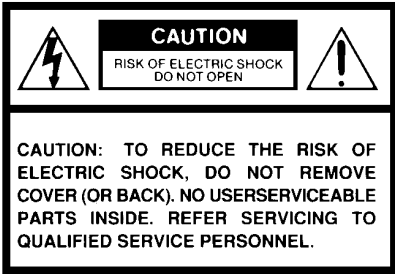

The lightning flash with arrowhead symbol, within an equilateral triangle, is intended to alert the user to the presence of uninsulated “dangerous voltage” within the product’s enclosure that may be of sufficient magnitude to constitute a risk of electric shock to persons.



The exclamation point within an equilateral triangle is intended to alert the user to the presence of important operating and maintenance (servicing) instructions in the literature accompanying the appliance.

**WARNING: TO REDUCE THE RISK OF FIRE OR ELECTRIC SHOCK, DO NOT EXPOSE THIS APPLIANCE TO RAIN OR MOISTURE. DANGEROUS HIGH VOLTAGES ARE PRESENT INSIDE THE ENCLOSURE. DO NOT OPEN THE CABINET. REFER SERVICING TO QUALIFIED PERSONNEL ONLY.**

**CAUTION: TO PREVENT ELECTRIC SHOCK, MATCH WIDE BLADE OF PLUG TO WIDE SLOT, FULLY INSERT.**

Product Name: Video Cassette Recorder  
Model Number: W-622

FCC Notice: “Declaration of Conformity”.

This device complies with part 15 of the FCC Rules. Operation is subject to the following two conditions: (1) This device may not cause harmful Interference, and (2) this device must accept any interference received, including interference that may cause undesired operation.

Contact: Toshiba America Consumer Products, Inc.  
Address: 1420 Toshiba Drive, Lebanon, TN 37087  
Telephone: 615-449-2360

User Installer Caution: Changes or modification made to this equipment not expressly approved by Toshiba Corporation or parties authorized by Toshiba Corporation could void the user’s authority to operate the equipment.

### Note to CATV system installer:

This reminder is provided to call the CATV system installer’s attention to Article 820-40 of the NEC that provides guidelines for proper grounding and, in particular, specifies that the cable ground shall be connected to the grounding system of the building, as close to the point of cable entry as practical.

### Copyright

**It is permissible to record television programs, film, video tapes and other material only in the event that third party copyrights and other rights are not violated.**

In the spaces provided below, record the Model and Serial No. located at the rear of your video cassette recorder.

Model No. \_\_\_\_\_

Serial No. \_\_\_\_\_

Retain this information for future reference.

# IMPORTANT PRECAUTIONS

## Save Original Packing Materials

The original shipping carton and packing materials will come in handy if you ever have to ship your VCR. For maximum protection, repack the set as it was originally packed at the factory.

## Avoid Volatile Liquid

Do not use volatile liquids, such as an insect spray, near the unit.  
Do not leave rubber or plastic products touching the unit for a long time. They will mar the finish.

## Moisture Condensation

Never operate this unit immediately after moving it from a cold location to a warm location. When the VCR is exposed to such a change in temperature, moisture may condense on the cylinder inside, one of its most crucial internal parts. To prevent the VCR from possible damage, do not use the unit for at least 2 hours when there is an extreme or sudden change in temperature.

## Compatibility

This video cassette recorder (VCR) is compatible with any other VCR bearing the **VHS** mark. HQ VHS equipment is also compatible with existing, non-HQ VHS equipment.



As an ENERGY STAR® Partner, TOSHIBA has determined that this product or product model meets the ENERGY STAR® guidelines for energy efficiency.

# IMPORTANT SAFETY INSTRUCTIONS

**CAUTION: PLEASE READ AND OBSERVE ALL WARNINGS AND INSTRUCTIONS GIVEN IN THIS OWNER'S MANUAL AND THOSE MARKED ON THE UNIT. RETAIN THIS BOOKLET FOR FUTURE REFERENCE.**

This set has been designed and manufactured to assure personal safety. Improper use can result in electric shock or fire hazard. The safeguards incorporated in this unit will protect you if you observe the following procedures for installation, use and servicing. This unit is fully transistorized and does not contain any parts that can be repaired by the user.

**DO NOT REMOVE THE CABINET COVER, OR YOU MAY BE EXPOSED TO DANGEROUS VOLTAGE. REFER SERVICING TO QUALIFIED SERVICE PERSONNEL ONLY.**

**1. Read owner's manual**

After unpacking this product, read the owner's manual carefully, and follow all the operating and other instructions.



**2. Power Sources**

This product should be operated only from the type of power source indicated on the marking label. If you are not sure of the type of power supply to your home, consult your product dealer or local power company. For products intended to operate from battery power, or other sources, refer to the operating instructions.



**3. Grounding or Polarization**

This product may be equipped with a polarized alternating current line plug (a plug having one blade wider than the other). This plug will fit into the power outlet only one way. This is a safety feature. If you are unable to insert the plug fully into the outlet, try reversing the plug. If the plug should still fail to fit, contact your electrician to replace your obsolete outlet. Do not defeat the safety purpose of the polarized plug.

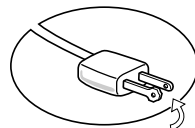

**4. Ventilation**

Slots and openings in the cabinet are provided for ventilation and to ensure reliable operation of the product and to protect it from overheating, and these openings must not be blocked or covered. The openings should never be blocked by placing the product on a bed, sofa, rug or other similar surface. This product should not be placed in a built-in installation such as a bookcase or rack unless proper ventilation is provided or the manufacturer's instructions have been adhered to.



**5. Heat**

The product should be situated away from heat sources such as radiators, heat registers, stoves, or other products (including amplifiers) that produce heat.

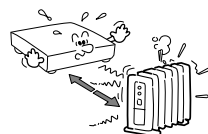

**6. Water and Moisture**

Do not use this product near water - for example, near a bath tub, wash bowl, kitchen sink, or laundry tub; in a wet basement; or near a swimming pool and the like.

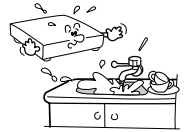

**7. Cleaning**

Unplug this product from the wall outlet before cleaning. Do not use liquid cleaners or aerosol cleaners. Use a damp cloth for cleaning.



**8. Power-Cord Protection**

Power-supply cords should be routed so that they are not likely to be walked on or pinched by items placed upon or against them, paying particular attention to cords at plugs, convenience receptacles, and the point where they exit from the product.



**9. Overloading**

Do not overload wall outlets; extension cords, or integral convenience receptacles as this can result in a risk of fire or electric shock.



**10. Outdoor Antenna Grounding**

If an outside antenna or cable system is connected to the product, be sure the antenna or cable system is grounded so as to provide some protection against voltage surges and built-up static charges. Article 810 of the National Electrical Code, ANSI/NFPA 70, provides information with regard to proper grounding of the mast and supporting structure, grounding of the lead-in wire to an antenna discharge unit, size of grounding conductors, location of antenna-discharge unit, connection to grounding electrodes, and requirements for the grounding electrode.

**EXAMPLE OF ANTENNA GROUNDING AS PER NATIONAL ELECTRICAL CODE**

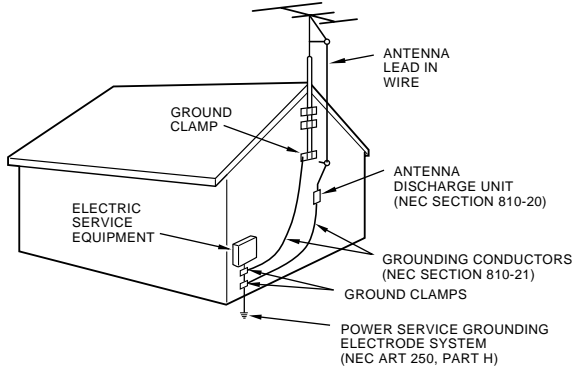

NEC – NATIONAL ELECTRICAL CODE

S2898A

**11. Power Lines**

An outside antenna system should not be located in the vicinity of overhead power lines or other electric light or power circuits, or where it can fall into such power lines or circuits. When installing an outside antenna system, extreme care should be taken to keep from touching such power lines or circuits as contact with them might be fatal.

# IMPORTANT SAFETY INSTRUCTIONS

## 12. Lightning

For added protection for this product during storm, or when it is left unattended and unused for long periods of time, unplug it from the wall outlet and disconnect the antenna or cable system. This will prevent damage to the product due to lightning and power-line surges.



## 13. Object and Liquid Entry

Never push objects of any kind into this product through openings as they may touch dangerous voltage points or short-out parts that could result in a fire or electric shock. Never spill liquid of any kind on the product.



## 14. Attachments

Do not use attachments not recommended by the product manufacturer as they may cause hazards.

## 15. Accessories

Do not place this product on an unstable cart, stand, tripod, bracket, or table. The product may fall, causing serious injury to a child or adult, and serious damage to the product. Use only with a cart, stand, tripod, bracket, or table recommended by the manufacturer, or sold with the product. Any mounting of the product should follow the manufacturer's instructions, and should use a mounting accessory recommended by the manufacturer.

A product and cart combination should be moved with care. Quick stops, excessive force, and uneven surfaces may cause the product and cart combination to overturn.



## 16. Damage Requiring Service

Unplug this product from the wall outlet and refer servicing to qualified service personnel under the following conditions:

- When the power-supply cord or plug is damaged.
- If liquid has been spilled, or objects have fallen into the product.
- If the product has been exposed to rain or water.
- If the product does not operate normally by following the operating instructions. Adjust only those controls that are covered by the operating instructions as an improper adjustment of other controls may result in damage and will often require extensive work by a qualified technician to restore the product to its normal operation.
- If the product has been dropped or damaged in any way.
- When the product exhibits a distinct change in performance - this indicates a need for service.

## 17. Servicing

Do not attempt to service this product yourself as opening or removing covers may expose you to dangerous voltage or other hazards. Refer all servicing to qualified service personnel.



## 18. Replacement Parts

When replacement parts are required, be sure the service technician has used replacement parts specified by the manufacturer or have the same characteristics as the original part. Unauthorized substitutions may result in fire, electric shock, or other hazards.

## 19. Safety Check

Upon completion of any service or repairs to this product, ask the service technician to perform safety checks to determine that the product is in proper operating condition.

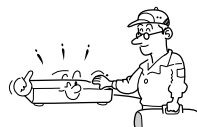

# Contents

## INTRODUCTION

---

Provides important notes and general explanation of the VCR, including names of the buttons, jacks, etc.

<b>SAFETY PRECAUTIONS</b> .....	2
<b>IMPORTANT PRECAUTIONS</b> .....	3
<b>IMPORTANT SAFETY INSTRUCTIONS</b> .....	4
<b>Contents</b> .....	7
<b>Identification of Controls</b> .....	8
• Front Panel	
• Remote Control	
• VCR Display	
• Rear Panel	

## PREPARATION

---

Explains what you need to do before operating the VCR.

<b>How to Use the Remote Control</b> .....	10
<b>Connections</b> .....	11
<b>Auto Set Up</b> .....	13
<b>Initial Settings Using On-screen Display</b> .....	14
• Setting the Language	
• Optional settings on the SET UP screen	
• Setting the Clock	
<b>Storing Channels on the VCR</b> .....	16
<b>Video Cassette Use</b> .....	18

## PLAYBACK

---

Explains variable functions concerning playback.

<b>Playback</b> .....	19
• Basic Playback	
• Double Speed Playback	
• S-VHS Quasi playback (SQPB)	

<b>Variable Speed Playback</b> .....	20
• Picture Search	
• Commercial Movie Skip	
• Still Picture	
• Frame Advance	
• Slow-motion Picture	

<b>Useful Functions in Tape Operation</b> .....	22
• Counter Function	
• Tape Remaining Time	
• Memory Stop Feature	

## RECORDING

---

Explains recording functions.

<b>Recording a TV Program</b> .....	24
• Basic Recording	
• Watching a TV program while recording another	
• Skipping unnecessary scenes while recording	
• Recording off time setting	
<b>Timer Program Recording</b> .....	25
<b>MTS Broadcast Compatibility</b> .....	28

## ADDITIONAL INFORMATION

---

<b>Remote Control for TOSHIBA TVs</b> ..	29
<b>Before Calling Service Personnel</b> ...	30
<b>Specifications</b> .....	31
<b>Accessories</b> .....	31
<b>Memo</b> .....	32
<b>LIMITED WARRANTY</b> .....	Back cover

# Identification of Controls

See the page in   for details.

This manual shows the names of buttons in italics.

## Front Panel

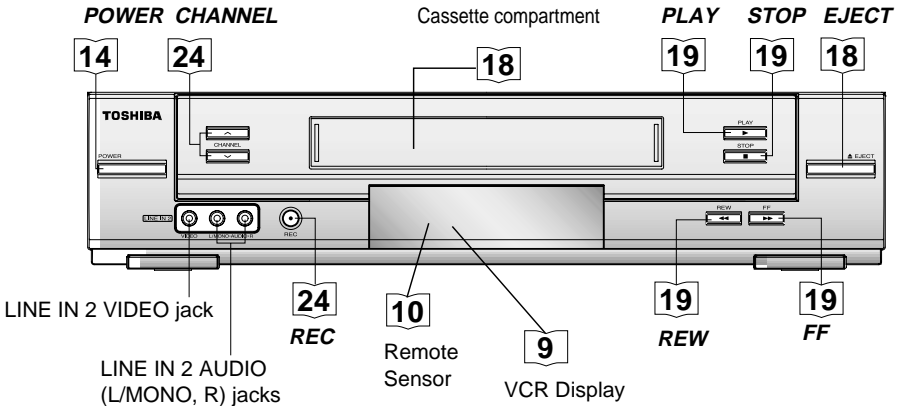

## Remote Control

To operate your TV. **TV** 29  
 To operate this VCR. **VCR** 14

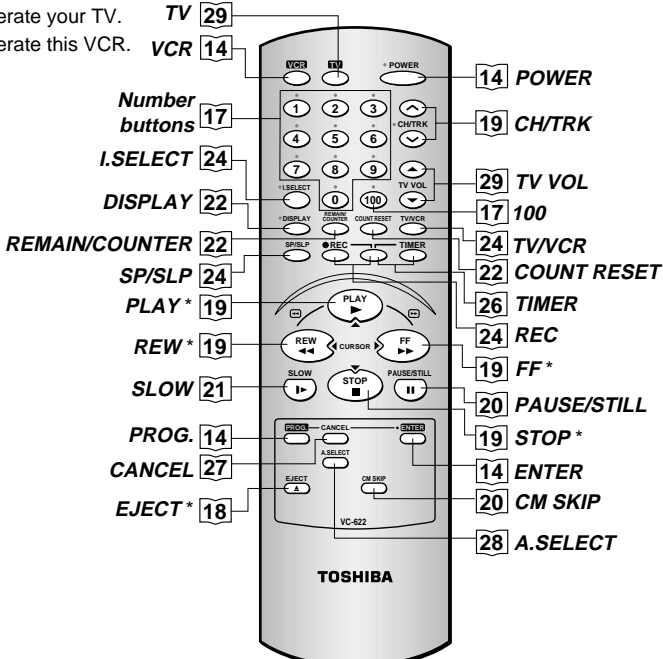

\* These buttons are used to control the cursor on the screen.



**VCR Display**

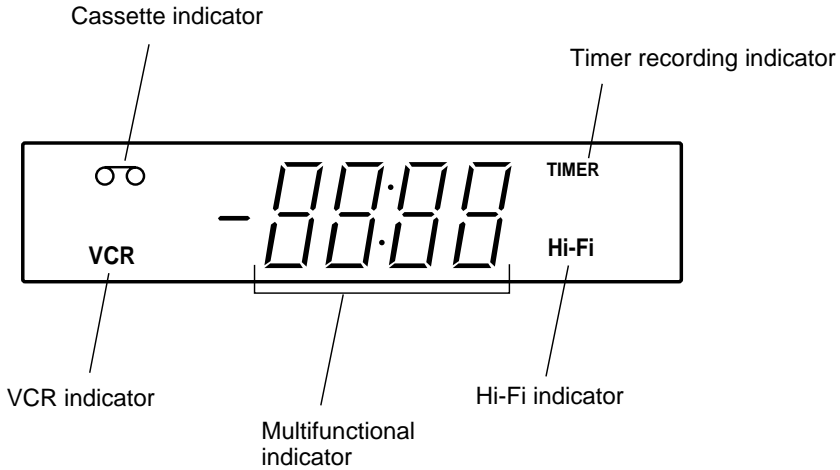

**Rear Panel**

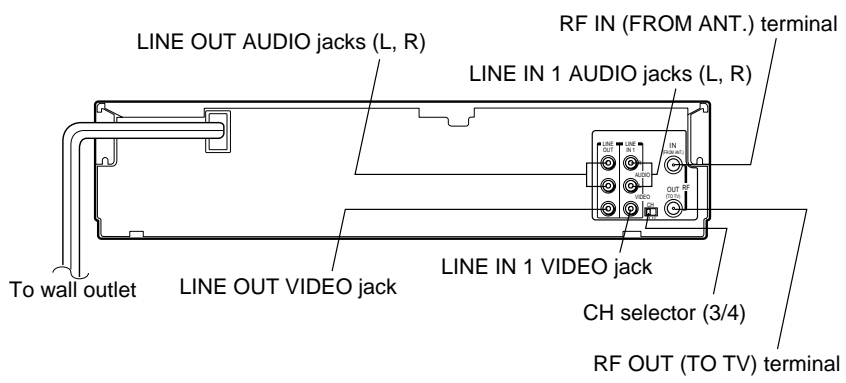

**LINE IN 1 AUDIO (Rear), 2 (Front) jacks**

If the connected equipment is monaural (has one audio output jack), connect the L (MONO) side, the same sound is recorded on both L and R on the Hi-Fi track.

# How to Use the Remote Control

This section explains how to get ready for remote control operation.

## Setting up the Remote Control

- 1 Open the battery compartment lid on the rear panel.

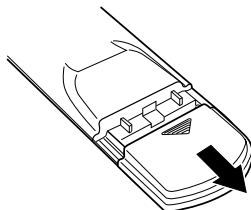

- 2 Install 2 batteries ("AAA" size) following the polarity diagrams.

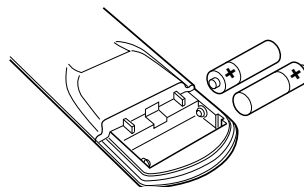

- 3 Close the battery compartment lid.

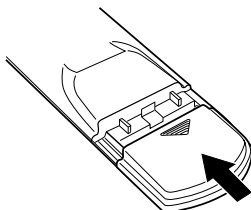

- 4 Point the remote control at the VCR and press the buttons within the operating range.  
Distance: within about 7 m from the front of the remote sensor  
Angles: within about 30° in every direction

### Notes on batteries

- The life of the batteries is about 1 year depending on the conditions of use.
- If the remote control does not operate correctly, replace all batteries with new ones.
- If the remote control is not to be used for a long period of time, remove the batteries to avoid possible damage from battery corrosion.

### Caring for the remote control

- Do not expose the remote sensor of the VCR to a strong light source such as direct sunlight or illumination (especially high-frequency lighting) when using the remote control.
- Be careful not to spill water on the remote control or to place it on anything wet, and avoid sharp impacts.

# Connections

Before you use this VCR, it is necessary to connect it to your TV. Several ways of connecting are available depending on your use of TV or cable box. Select one which is applicable to your equipment.

## Antenna/VCR/TV Connection

- 1** Disconnect the antenna cable from your TV and connect it to the **RF IN** terminal on the VCR.
- 2** Connect the **RF OUT** terminal to the TV.

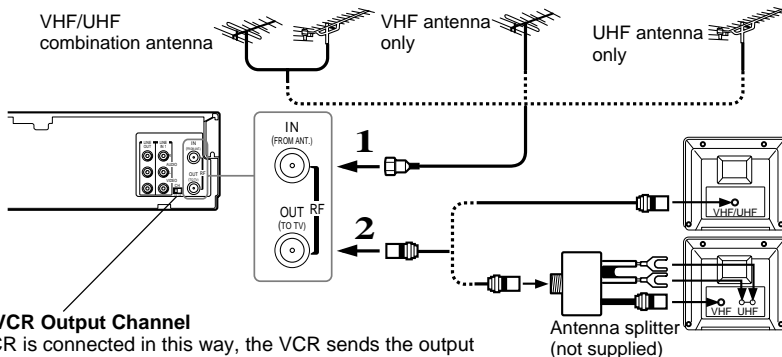

### Setting the VCR Output Channel

When the VCR is connected in this way, the VCR sends the output signals to channel 3 or 4 on your TV. Set the output channel selector (CH selector) of the VCR to "3" or "4", whichever is vacant in your area.

## AUDIO/VIDEO Connections

The AUDIO/VIDEO jacks are also available to connect your TV.

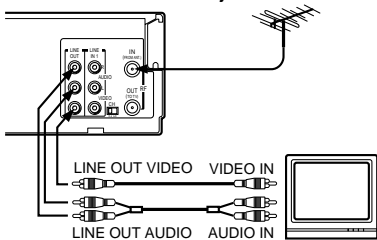

### When connected your TV using the AUDIO/VIDEO OUT jacks

To watch video pictures, set the video input mode on your TV. For the video input mode, refer to the manual of your TV.

## Cable Connection

Choose one of the below according to your usage of the cable box.

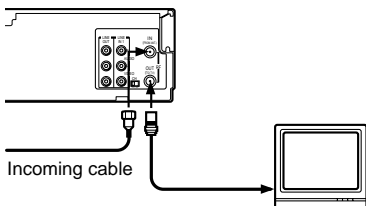

### This set-up will enable you to:

- record an unscrambled channel.
- watch an unscrambled channel while recording it.
- record an unscrambled channel while watching another (only when you connect a cable-compatible TV).

### You will need to:

- select TV channel 3 or 4 to receive video signals.
- to record a channel while watching another, press **TV/VCR** on the remote control to turn off the "VCR" indicator in the VCR display and select a desired channel on the TV (only when you connect a cable-compatible TV).

## Connections (continued)

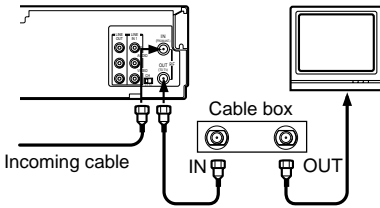

### This set-up will enable you to:

- record an unscrambled channel.
- watch an unscrambled channel while recording it.
- record an unscrambled channel while watching another (scrambled or unscrambled).

### You will need to:

- set TV channel to the output channel of the cable box.
- turn on the cable box and select cable channel 3 or 4 according to the output channel of the VCR.
- to record a channel while watching another, press **TV/VCR** on the remote control to turn off the “VCR” indicator in the VCR display and select a desired cable channel on the cable box.

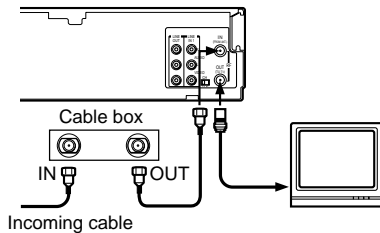

### This set-up will enable you to:

- watch an unscrambled or scrambled channel while recording it.
- record any channels through the cable box.

### You will need to:

- set TV channel 3 or 4 to receive video signals. (See page 11.)
- set VCR channel to the output channel of the cable box, and select a desired cable channel on the cable box.
- while the VCR is turned off or the “VCR” indicator is not lit in the VCR display, set TV channel to the output channel of the cable box.

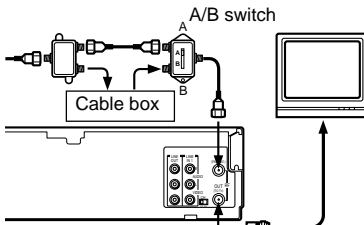

### This set-up will enable you to:

- watch an unscrambled or scrambled channel while recording it.
- record an unscrambled channel while watching another unscrambled channel (only when you connect a cable-compatible TV).
- A/B switch “A”: record and watch an unscrambled channel which comes by bypassing the cable box.
- A/B switch “B”: record and watch a scrambled or unscrambled channel coming through the cable box.

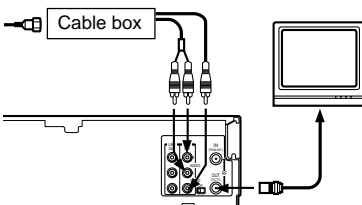

### This set-up will enable you to:

- watch or record a channel through the cable box via the LINE IN 1 (AUDIO/VIDEO) jacks.

### You will need to:

- press **I.SELECT** so that the VCR display shows “L1”.

# Auto Set Up

The VCR's clock and tuner channels are set automatically when the VCR is plugged into the AC outlet.

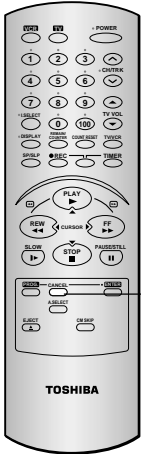

**CANCEL**

## Auto Set up

- 1 Plug the VCR into the AC outlet
- 2 "Auto" blink while the VCR automatically sets the clock using the data broadcast by the local TV stations. While "Auto" is blinking, channel memory is also set automatically.



- 3 When Auto set up has been completed, the VCR is on standby mode.

### Notes

- It may takes several minutes during the Auto set-up
- Press **CANCEL** on the remote control to cancel the auto set-up.

# Initial Settings Using On-screen Display

The language selection and clock setting must be set first when VCR is first plugged in or after it encounters a power failure.

## Preparation

- Turn on the TV, and select the video channel (3 or 4), or the video input mode if you made the Audio/Video connection (page 11).
- Press VCR to set the remote control operating the VCR.

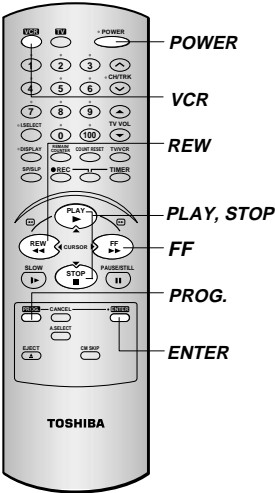

## Setting the Language

**1** Press **POWER** to turn on the VCR.

**2** Press **PROG.**  
The following screen appears on the TV.

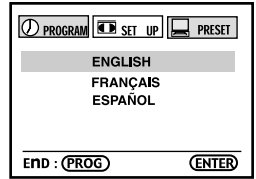

**3** Select the language using **PLAY** or **STOP** and press **PROG.**  
The screen turns to the MENU screen.

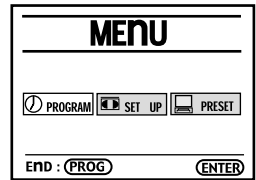

**4** Press **PROG.** to return to the normal TV screen.

## Optional settings on the SET UP screen

Other optional settings can be made. Press **ENTER** while "SET UP" is selected on the MENU screen. The screen turns to the SET UP screen.

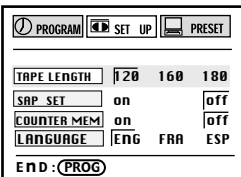

- Page 22
- Page 28
- Page 23
- To change the language, move down here and set to the desired one.

To exit, press **PROG.** once.

## Setting the Clock

Example: To set the clock to 2:30 p.m. on August 25 (summer time) 2002.

**1** Press **PROG.**  
The MENU screen appears on the TV.

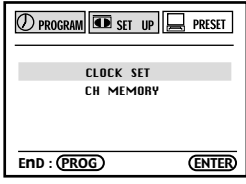

**2** Select "PRESET" using **FF** or **REW**, and press **ENTER**.

**3** Press **ENTER** to select "CLOCK SET".

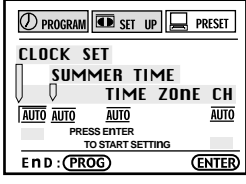

**4** Select "AUTO" or "MANU" using **PLAY** or **STOP**.  
**AUTO:** The VCR automatically sets or adjusts the clock.  
If you select "AUTO" mode, proceed to step **8**.  
**MANU:** You can set the clock manually.  
If you select "MANU" mode, proceed to next step.

**5** Vary the digits to set the hour.  
**PLAY:** To increase.  
**STOP:** To decrease.

**6** Move to the next using **FF** (To move back, press **REW**.)

**7** Repeat step **5** and **6** to set the minutes, month, day, and the year (by the last two digits).  
Proceed to step **10** to start the clock.

**8** Press **ENTER** to start the "AUTO" clock set feature.

After the VCR is turned off, it automatically updates the clock using the data broadcast by the local TV stations.

\*The clock is revised by broadcasting signal at 8:00 A.M every morning.

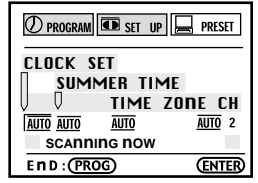

**9** Select the options using **FF** or **REW**. Change the data using **PLAY** or **STOP**.

1) Set "SUMMER TIME" (Daylight-Saving Time).  
DST start: Daylight-saving time begins on the first Sunday in April. Because the clock automatically changes from 2:00 AM to 3:00 AM (forward one hour).  
DST end: Daylight-saving time ends on the last Sunday in October. The VCR clock automatically changes from 2:00 AM to 1:00 AM (back one hour).

remember that any part of a scheduled Timer Recording that falls between these two times will not be recorded.  
**AUTO:** the VCR is using the clock data Broadcast by the local TV stations.

**IN:** You want to use the DST function, and you are leaving in the area that apply Daylight-saving time.

**OUT:** You are not leaving in the area that apply Daylight-saving time and you do not want to use DST function.

2) Set "TIME ZONE".  
If you select "AUTO" for your time zone, the VCR sets the clock using the first Coordinated Universal Time information it finds. If the time is not correct, select another time zone or use the "MANU" option.

3) Set "CLOCK DATA CH".  
If you don't know the clock data channel, select "AUTO". The VCR will scan automatically to tune the channel carrying the clock data.

If AUTO CLOCK SET is unsuccessful, set the time and date through the "MANU" clock set menu selection.

**10** Press **PROG.**  
Now the clock starts.

# Storing Channels on the VCR

This section is required if you receive only normal TV or unscrambled cable channels

## Incoming Antenna/Cable(CATV) Signals

The VCR scans through all receivable TV and CATV channels and stores only the active ones in your area into the memory. Once the storing is finished, you can select a desired channel using **CH/TRK.**

### Preparation

- Turn on the TV, and select the video channel (3 or 4), or the video input mode if you made the Audio/Video connection (page 11).
- Press **I.SELECT** so that the channel number will appear if "L1" or "L2" is displayed in the VCR display.

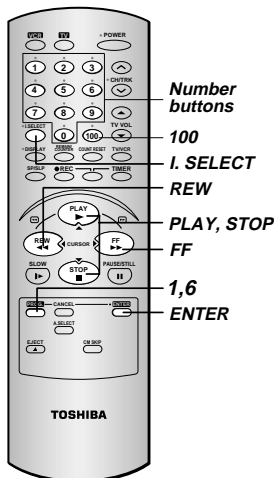

## Incoming Antenna/Cable(CATV) Signals

**1** Press **PROG.** to display the MENU screen.

**2** Select "PRESET" using **FF** or **REW**, and press **ENTER**.

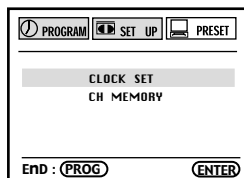

**3** Select "CH MEMORY" using **PLAY** or **STOP**, and press **ENTER**.

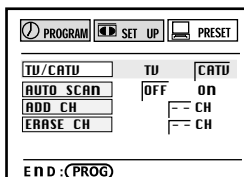

**4** Set "TV/CATV" to "TV" or "CATV" using **FF** or **REW**.  
**TV:** To store channels received via the antenna.  
**CATV:** To store channels received via the incoming cable.

**5** Select "AUTO SCAN" using **PLAY** or **STOP**, and press **FF** to set to "ON".

The VCR starts scanning and the channels are stored in the VCR in ascending order. When the scanning is finished, the screen automatically returns.

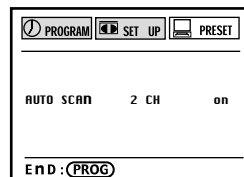

**6** Press **PROG.** twice to exit.



## Adding or erasing channels

### Adding channels

If a desired channel cannot be scanned automatically because of a weak signal, it can be added to the memory.

### Erasing channels

You can erase a stored channel from the memory if it is unnecessary.

1) Follow steps 1 to 3 of "Incoming Antenna/CATV Signals".

2) Select "ADD CH" or "ERASE CH" using **PLAY** or **STOP**.

To add channels

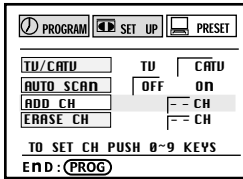

To erase channels

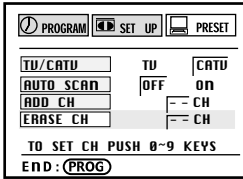

3) Enter a channel number of 1 to 125 using **number buttons**.

For more than 100 number, first press **100**.

For CATV channels, refer to the chart below. (For other orders, check with your cable company.)

4) Repeat steps 2) and 3) to add or erase channels as necessary.

5) Press **PROG** twice to exit.

## Selecting stored channels

Once the active channels have been stored, you can select the channels in two ways below.

### Number buttons

To enter digits of the channel number.

- For one-digit number, enter 0 before.
- For more than 100 number, first press **100**.
- Each **number button** needs to be pressed within 2 seconds.

### CH/TRK buttons

To shift up or down the stored channel numbers.

## Channel reference chart

Number on the VCR		CH NUMBER										1	2	3	4	5	6	7	8	9
Corresponding channel number		TV										-	2	3	4	5	6	7	8	9
		CATV STD (HRC/IRC)										1(A-8)	2	3	4	5(A-7)	6(A-6)	7	8	9
10	11	12	13	14	15	16	17	18	19	20	21	22	23	24	25	26	27	28	29	30
10	11	12	13	14	15	16	17	18	19	20	21	22	23	24	25	26	27	28	29	30
10	11	12	13	A	B	C	D	E	F	G	H	I	J	K	L	M	N	O	P	Q
31	32	33	34	35	36	37	38	39	40	41	42	43	44	45	46	47	48	49	50	51
31	32	33	34	35	36	37	38	39	40	41	42	43	44	45	46	47	48	49	50	51
R	S	T	U	V	W	AA	BB	CC	DD	EE	FF	GG	HH	II	JJ	KK	LL	MM	NN	OO
52	53	54	55	56	57	58	59	60	61	62	63	64	65	66	67	68	69	70	71	...
52	53	54	55	56	57	58	59	60	61	62	63	64	65	66	67	68	69	-	-	...
PP	QQ	RR	SS	TT	UU	VV	WW	XX	YY	ZZ	AAA	BBB	65	66	67	68	69	70	71	...
93	94	95	96	97	98	99	100	101	102	103	...	121	122	123	124	125				
-	-	-	-	-	-	-	-	-	-	-	...	-	-	-	-	-				
93	94	A-5	A-4	A-3	A-2	A-1	100	101	102	103	...	121	122	123	124	125				

### CATV signals

- STD (standard) cable TV signals
- HRC (Harmonic Related Carriers) cable TV signals
- IRC (Incremental Related Carriers) cable TV signals  
IRC is also called ICC (Incremental Coherent Carriers)

# Video Cassette Use

## Video Cassette Use

### Loading a cassette

Push the cassette into the cassette compartment with the window side facing up and the label side towards the front. The VCR is automatically turned on. The  $\circ\circ$  indicator will appear in the VCR display.

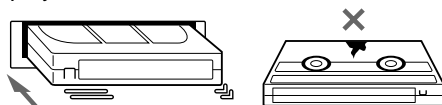

### Ejecting a cassette

Press **EJECT**. The cassette is ejected from the cassette compartment.

#### Warning

Do not insert your hands or any foreign objects into the compartment. This may result in injury or damage. Take special care with children to avoid accidents.

## Precautions when using video cassettes

Video cassettes have a safety tab to prevent accidental erasure. If the tab has already been removed, recording cannot be performed.

### To prevent accidental erasure

Remove this safety tab with a screwdriver.

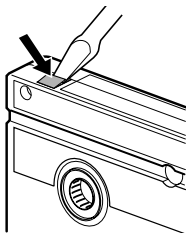

### To record again

Cover the tab hole with adhesive tape.

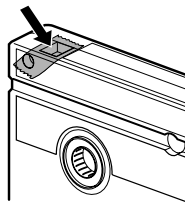

- Avoid exposing cassettes to direct sunlight. Keep them away from heaters. Avoid extreme humidity, vibrations or shock, strong magnetic fields (near a motor, transformer or magnet) and dusty place.

# Playback

This section explains the basic playback operation.

## Preparation

- Select the video channel (3 or 4) or video input mode on the TV.
- Press **VCR** to set the remote control operating the VCR.

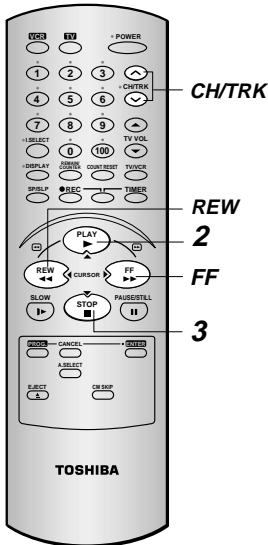

## Basic Playback

- 1 Load a recorded cassette.  
Power is turned on.  
If the cassette has no safety tab, playback starts automatically.
- 2 Press **PLAY** to start playback.
- 3 To stop playback, press **STOP**.

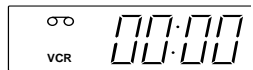
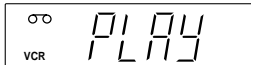

## Double Speed Playback

- 1 Press **PLAY** during playback.  
A tape runs at double speed playback.

To resume normal playback Press **PLAY**

## Rewinding / Fast-forwarding

Press **REW** or **FF** in the stop mode.

## Adjusting the tracking

When playback starts, the VCR automatically adjusts the tracking for clear pictures and sound (Digital Auto Tracking).

If the VCR cannot locate the best possible tracking point, hold down one of **CH/TRK** to adjust the tracking manually.

## Notes

- During the adjusting, the playback picture and sound may be distorted.
- The digital auto tracking is activated only in the playback mode.
- The noise on the screen may not be completely eliminated depending on the tape used, especially when the tape was recorded on another VCR.

## S-VHS Quasi Playback (SQPB)

- This VCR can also play back at tape which is recorded in S-VHS format.  
But the playback pictures does not have the same quality and resolution as the original S-VHS playback picture.
- This VCR cannot record in S-VHS format.
- SQPB is an abbreviation for S-VHS Quasi Playback.

# Variable Speed Playback

You can play back a tape at various tape speeds.

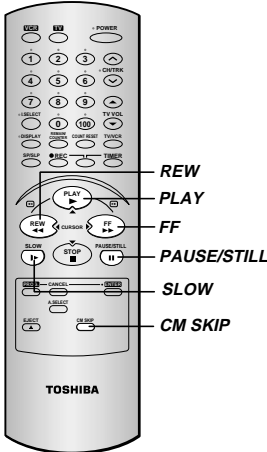

## Picture Search

A tape runs at 5 times or 7 times the normal playback speed so that you can quickly locate a particular scene.

- 1 Press **FF** or **REW** during playback.  
The tape runs at 5 times the normal playback speed.
- 2 To change the tape speed to 7 times the normal playback speed, press and hold **FF** or **REW**.  
If you release it, the tape speed returns to 5 times.

### Note

If you press **FF** or **REW** during picture search, the mode changes to fast-forwarding or rewinding.

### To resume normal playback

Press **PLAY**

## Commercial Movie Skip

You can skip a portion of playback you do not want (such as a commercial) and then return to normal playback.

- 1 Press **CM SKIP** during playback.  
The VCR will automatically search forward for 30 seconds to a maximum of 3 minutes (six presses) and then resume normal playback.

## Still Picture

A picture freezes so that you can watch closer.

- 1 Press **PAUSE/STILL** during playback.  
The picture freezes.

### To resume normal playback

Press **PAUSE/STILL** again.

### Notes

- The still mode is automatically cancelled after about 5 minutes and returns to normal playback.
- The still picture may shake if a picture of a fast-moving object or scene is frozen. This is not a defect in the unit.

### Adjusting Still Picture Stability

If the still picture is distorted or flickers, hold down one of **CH/TRK** until the picture becomes stable.

### Note

The distortion of the still picture may not be eliminated completely.

## Frame Advance

A picture advances frame by frame.

- 1 Press **PLAY** during still playback.  
Each time you press **PLAY**, the picture advances one frame.

### To resume normal playback

Press **PAUSE/STILL**.

## Slow-motion Picture

The tape runs at 1/7th or 1/15th the normal playback speed.

- 1 Press **SLOW** during playback.  
The tape runs at about 1/7th the normal playback speed.  
Each time you press **SLOW**, the speed alternates between 1/7th and 1/15th.

### To resume normal playback

Press **PLAY**.

#### Notes

- The slow-motion picture mode is automatically cancelled after about 5 minutes and returns to normal playback.
- The slow-motion picture may flicker up and down. This is not a defect in the unit.

## Adjusting the Tracking Manually

If the slow-motion picture is noisy, hold down one of **CH/TRK** until the best picture is obtained.

#### Note

The noise in the slow-motion picture may not be eliminated completely.

# Useful Functions in Tape Operation

These functions will help your playback.

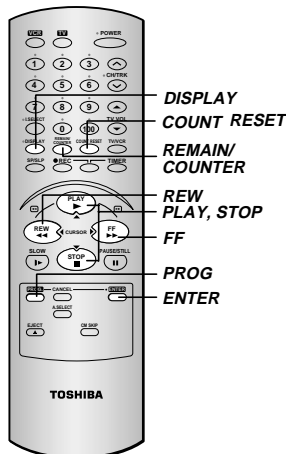

## Counter Function

You can view the clock, linear time counter or tape remaining time in the VCR display or on the TV screen.

Each time you press **REMAIN/COUNTER**, the VCR display changes in sequence as follows:

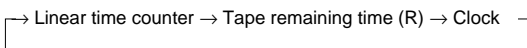

The indication above will also appear on the TV screen by pressing **DISPLAY**. They are switchable with **REMAIN/COUNTER**.

### To reset the linear time counter to "0:00:00"

The counter is automatically reset to "0:00:00" when a cassette is ejected. If you want to reset at another point, such as the beginning of a new recording, just press **COUNT RESET**.

#### Notes

- The linear time counter does not work on non-recorded portions on the tape.
- When the tape is ejected or the VCR is turned off, the display changes to clock.
- If the tape rewinds back over "00:00", "-" appears in the VCR display.
- The displayed time of the linear time counter is only an approximation.

## Tape Remaining Time

To view the tape remaining time in the VCR display, select the tape length beforehand.

- 1 Turn on the VCR and load a cassette.
- 2 Press **PROG.** to display the MENU screen.
- 3 Select "SET UP" using **FF** or **REW**, and press **ENTER**.
- 4 Select the length of the tape, using **FF** or **REW**.

**T120:** for a T-120 tape or shorter

**T160:** for a T-140 or T-160 tape

**T180:** for a T-180 tape

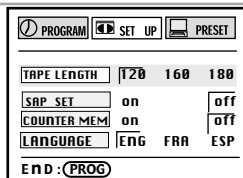

- 5 Press **PROG.** once to exit.
- 6 Press **REMAIN/COUNTER**.  
The remaining time ("R - : -") appears in the VCR display.

#### Notes

- The displayed remaining time is an approximation.
- The remaining time is calculated according to the tape speed (SP or SLP) and the cassette type.

## Memory Stop Feature (Zero Return)

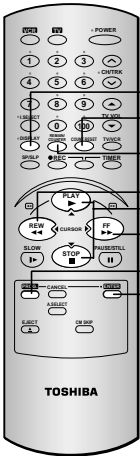

**DISPLAY**  
**COUNT RESET**  
**REMAIN/COUNTER**  
**REW**  
**PLAY, STOP**  
**FF**  
**PROG**  
**ENTER**

- 1 On the SET UP screen, select "COUNTER MEM." using **PLAY** or **STOP**, and set to "ON" using **REW** or **FF**.

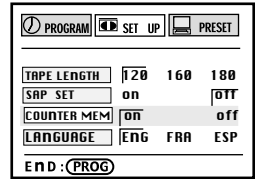

- 2 Press **PROG.** once to exit.

The memory-stop feature allows you to quickly return to a counter reading of "0H00M00S" from any point on the tape. Memory stop is automatically turned on whenever the time counter with memory is displayed on the TV screen. This is convenient when you want to watch a segment of the tape repeatedly. You may also discover other useful application for this feature.

**Notes:** If you are rewinding the tape and the VCR stops at "0H00M00S M", press **REW** again to continue rewinding.

If you press the **FF** (fast-forward) button and the time counter never reaches "0H00M00S M" between that point and the end of the tape, the VCR will continue to fastforward to the end of the tape.

# Recording a TV Program

This section explains the basic recording operation.

## Preparation

- Select the video channel (3 or 4) or video input mode on the TV.

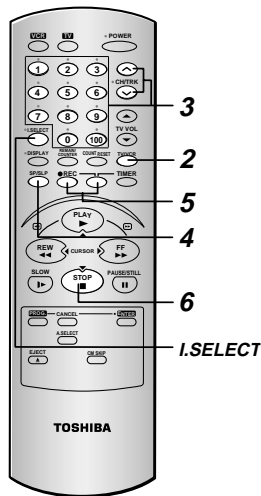

## To record from other connected equipment

In step 3, press **I.SELECT** to switch the display as follows:

- L1:** To record via the LINE IN 1 jacks on the rear panel.  
**L2:** To record via the LINE IN 2 jacks on the front panel.

## Basic Recording

**1** Load a cassette with the safety tab attached.

**2** Press **TV/VCR** so that the "VCR" indicator appears in the VCR display.

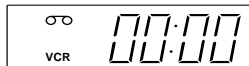

**3** Select a channel to record with **CHANNEL** on the VCR, or **CH/TRK** or **number buttons** on the remote control.

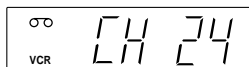

If you see "L1" or "L2" in the VCR display, press **I.SELECT** so that the channel number appears.

- If you record cable channels via the cable box, make the output channel number of the cable box or "L1" appear, depending on your connection. (See pages 11 – 12.)

**4** Press **SP/SLP** to select the recording tape speed.

**SP:** Suitable for general recording with better picture and sound quality.

**SLP:** Suitable for tripling recording time, but with less picture and sound quality than using the SP tape speed.

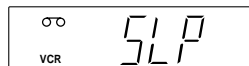

**5** Press **REC** on the VCR, or simultaneously press both **REC** on the remote control.

Recording starts.

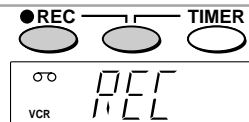

**6** Press **STOP** to stop recording.

## Watching a TV program while recording another

- 1) While recording, press **TV/VCR** to turn off "VCR" indicator.
- 2) Choose another channel using the channel selector on the TV.

## Skipping unnecessary scenes while recording

Press **PAUSE/STILL** to stop recording momentarily. To resume recording, press **PAUSE/STILL** again.

### Note

The VCR automatically shifts to the stop mode if the recording pause mode continues for 10 minutes.

## Recording off time setting

By setting the recording off time, the recording stops and the VCR is turned off automatically. While recording, press simultaneously both **REC** on the remote repeatedly to set the desired off time.

Each time you press **REC**, each half-hour up to about 4 hours appear cyclically.

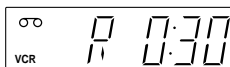

### Notes

- To cancel the recording in progress, press **POWER** on the VCR.



# Timer Program Recording

The programmable timer allows you to record up to 6 different programs over one month.

## Preparation

- Select the video channel (3 or 4) or video input mode on the TV.
- Make sure that the clock is set correctly (page 15).
- Store the channels on the VCR (pages 16 and 17).

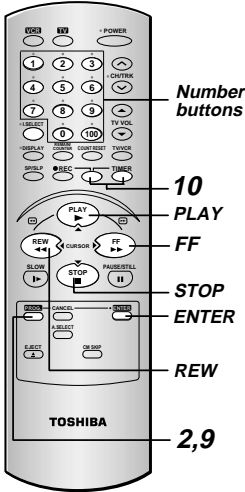

## Timer Programming Procedure

**Example:** To record cable channel 25 in the SP tape speed from 9:20 p.m. until 10:00 p.m. on August 30. Today is August 25.

- 1 Load a cassette with the safety tab attached.
- 2 Press **PROG.** to display the MENU screen.
- 3 Select "PROGRAM" using **FF** or **REW**, and press **ENTER**.

PROGRAM	CH	DATE	ON	OFF	SPD
●	--	-/-	-:-	-:-	-
●	--	-/-	-:-	-:-	-
●	--	-/-	-:-	-:-	-
●	--	-/-	-:-	-:-	-
●	--	-/-	-:-	-:-	-
●	--	-/-	-:-	-:-	-
END : (PROG)					

- 4 Move to the next using **FF**, and select the channel number 25 by pressing **number buttons** 2 and 5, **PLAY** or **STOP**.

PROGRAM	CH	DATE	ON	OFF	SPD
●	25	-/-	-:-	-:-	SLP
●	--	-/-	-:-	-:-	-
●	--	-/-	-:-	-:-	-
●	--	-/-	-:-	-:-	-
●	--	-/-	-:-	-:-	-
●	--	-/-	-:-	-:-	-
END : (PROG)					

- To record a cable program from the connected cable box:  
Enter the cable channel number by **number buttons**, **PLAY** or **STOP**.  
If your cable box is not remote-controllable, choose the desired channel (1 to 125) on the cable box.
- You can make "L1" or "L2" appear on the channel number position by pressing **L.SELECT** depending on your connection. (See pages 8 and 12).

**To make corrections:**  
Press **REW** to move back to the item, or **FF** to forward.

(Continued)

## Timer Program Recording (continued)

- 5** Move to the next using **FF**, and set the recording date using **PLAY** or **STOP**.

The date changes as follows:

→ 8/25 → 9/25 → ... → 7/25 → WKLYSU → ...  
 ← MO-FR ← WKLYSA ←

PROGRAM	CH	DATE	ON	OFF	SPD
●	2 5	8/30	--	--	SLP
●	--	--	--	--	--
●	--	--	--	--	--
●	--	--	--	--	--
●	--	--	--	--	--
●	--	--	--	--	--
●	--	--	--	--	--
●	--	--	--	--	--
END: (PROG)					

**[WKLYSU]...[WKLYSA]:** You can record TV programs on the same channel on the day and time every week.

**[MO-FR]:** You can record TV programs on the same channel on the day and time Monday through Friday.

- 6** Move to the next using **FF**, and set the hour and minutes of the recording start time.

PROGRAM	CH	DATE	ON	OFF	SPD
●	2 5	8/30	09:20	--	SLP
●	--	--	--	--	--
●	--	--	--	--	--
●	--	--	--	--	--
●	--	--	--	--	--
●	--	--	--	--	--
●	--	--	--	--	--
●	--	--	--	--	--
END: (PROG)					

- 7** Move to the next, and set the recording off time.

PROGRAM	CH	DATE	ON	OFF	SPD
●	2 5	8/30	9:20	08:00	SLP
●	--	--	--	--	--
●	--	--	--	--	--
●	--	--	--	--	--
●	--	--	--	--	--
●	--	--	--	--	--
●	--	--	--	--	--
●	--	--	--	--	--
END: (PROG)					

- 8** Move to the next, and select the tape speed (SP) using **PLAY** or **STOP**.

For the tape speed "AUTO (Auto Speed Select)", see below.

To set another program, press **FF**, and select the next line pressing **STOP**.

Repeat steps 4 to 8.

PROGRAM	CH	DATE	ON	OFF	SPD
●	2 5	8/30	9:20	08:00	SP
●	--	--	--	--	--
●	--	--	--	--	--
●	--	--	--	--	--
●	--	--	--	--	--
●	--	--	--	--	--
●	--	--	--	--	--
●	--	--	--	--	--
END: (PROG)					

- 9** Press **PROG.**

Now programming is completed.

- 10** Press both **TIMER** simultaneously.

The power turns off and the VCR enters the timer standby mode.

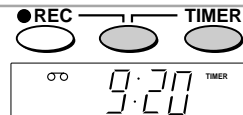

### Auto Speed Select

If you are not sure the tape is long enough for timer program recording in the SP tape speed, set the recording tape speed to "AUTO".

Recording starts in the SP tape speed and the VCR automatically selects the tape speed to record the program to the end. If the tape length is not long enough, the tape speed automatically changes from SP to SLP.

### Notes

- Make sure that the tape length is selected correctly according to the tape used on the SET UP screen (page 22).
- When the SLP tape speed is selected and the tape length is not sufficient to record the program to the end, the program cannot be recorded to the end.
- The picture will be distorted when playing the part where the recording tape speed is switched from SP to SLP with the Auto Speed Select feature.

## Confirming the timer programs

Press **PROG.** during timer recording mode.  
The screen for confirming will appear.

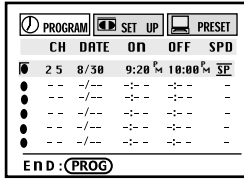

Press **PROG.** again to exit from confirmation page.

## Changing/cancelling the timer programs

- 1) If the **TIMER** indicator is lit, press both **TIMER** to turn it off and then turn the VCR on by pressing **VCR POWER**.
- 2) With steps 2 to 9, change the items.  
To cancel a program, select the program you want to cancel in step 4, and press **CANCEL**. The line is then cleared.
- 3) Press both **TIMER** to return to the timer standby mode.

## Error indication

The "--E--" ( Error ) indicator appears in the VCR display if you press both **TIMER** when:

- a cassette is not loaded.
- the loaded cassette has no safety tab.
- timer recording is in progress.

In these cases, a recording can not be made.

## To cancel the Timer Recording

By pressing the **POWER** button on the front panel of the VCR, it will cancel the timer recording and go to standby.

## If a power failure occurs during the timer program recording

- When a power failure has occurred, the programmed contents are not affected, reset the clock.

## Overlaps of the programs

If two timer programs overlap, the recording start time of program 1 has priority over the recording off time of program2.

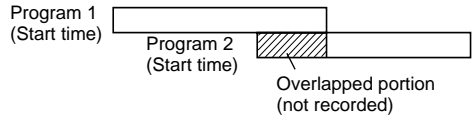

# MTS Broadcast Compatibility

This VCR can receive or record MTS (Multichannel TV Sound) broadcasts. By connecting the VCR to your stereo system or stereo TV, you will experience the SAP or stereo sound.

## Preparation

Connect a stereo TV or stereo system to the AUDIO OUT jacks of the VCR.

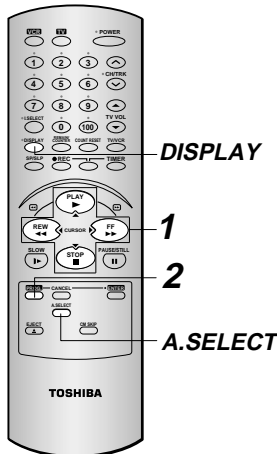

## Recording the SAP/Stereo Broadcast

- 1 On the SET UP screen (page 14), select "SAP SET" using **PLAY** or **STOP**, and set to "ON" using **REW** or **FF**.
- 2 Press **PROG.** once to exit.
- 3 Perform a recording.

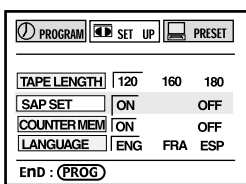

### SAP (Second Audio Program broadcast):

A separate audio program, usually broadcast in a second language with the main language.

## Selecting a sound

### Sounds recorded on the tape

According to your setting of "SAP SET" on the SET UP screen, the sound is recorded onto different tracks of the tape as below. Set "SAP SET" to "ON" or "OFF" appropriately.

Type of receiving broadcast	Setting of "SAP SET" on the SET UP screen	On-Screen Display (Press <b>DISPLAY</b> .)		Contents of recorded sound		
		"SAP"	"STEREO"	Normal sound track (Mono)	Hi-Fi sound track	
					L	R
Regular (monaural audio)	"ON" or "OFF"	not lit	not lit	MONO	MONO	MONO
Stereo	"ON" or "OFF"	not lit	lit	MONO (MIXED)	STEREO	
Regular+SAP	"ON"	lit	not lit	MONO	MONO	SAP
	"OFF"	lit	not lit	MONO	MONO	MONO
Stereo+SAP	"ON"	lit	lit	MONO	MONO	SAP
	"OFF"	lit	lit	MONO (MIXED)	STEREO	

### Sounds in playback

You can play SAP and/or stereo broadcast with this VCR. Press **A.SELECT** to select a desired sound.

Desired sound	L , R indicator in the On-Screen Display	Sound Output
SAP Sound	R (right) is on	SAP
Stereo Sound	Both R (right) and L (left) are on	HIFI Sound

### Note

When the TV is connected to the RF OUT terminal of the VCR, the output sound is monaural.

# Remote Control for TOSHIBA TVs

The remote control can control TOSHIBA TVs.

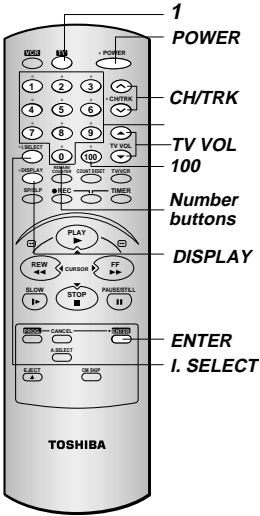

## TOSHIBA TV's Control

- 1** Press **TV** to set the remote control operating your TV.
- 2** Point the remote control at your TV and use each button listed below to make sure that your TV is operate correctly.

<b>POWER</b>	To turn the TV on or off.
<b>CH/TRK</b>	To select TV channels in the upper or lower direction.
<b>TV VOL</b>	To adjust the sound level.
<b>I.SELECT</b>	To select an external source such as a VCR.
<b>Number buttons</b>	To select TV channels. When selecting channels 1 to 9, first enter 0 and then the desired number.
<b>100</b>	To substitute for 100 channel key.
<b>DISPLAY</b>	To turn on or off TV's screen display.
<b>ENTER</b>	To use for the TV's ENTER key.

### Important

Some TVs may not respond to all the operations above, or may not be operated at all with this remote control. In this case, operate your TV with it's own remote control.

# Before Calling Service Personnel

Check the following symptoms before requesting servicing.

## No power.

- The power cord is not plugged in.
- **Plug the power cord into the outlet firmly.**

## Although the power is on, the VCR will not work.

- There is no cassette.
- **Load a cassette. (page 18)**

## The clock does not work.

- There has been a power failure.
- **Reset the clock. (page 15)**

## The timer does not work properly.

- The time is incorrect.
- **Set the clock correctly. (page 15)**

## The picture does not appear on the TV screen.

- The video channel or video input mode is not set correctly.
- **Set the TV channel to the video channel (3 or 4) or set the video input mode on the TV. (page 11)**
- The TV signal is weak.
- **Adjust the antenna direction or use an optional antenna booster.**
- The power cord is not plugged in.
- **Plug the power cord into the outlet firmly.**

## The picture does not appear on the TV screen during recording and playback.

- The video channel or VCR mode is not set correctly.
- **Press TV/VCR to select the VCR mode and set the TV channel to 3 or 4. (pages 11, 12)**

## The VCR does not record.

- The loaded cassette has no safety tab.
- **Use a cassette with a safety tab or cover the hole with adhesive tape. (page 18)**

## The playback picture is poor.

- Tracking is not set appropriately.
- **Adjust the tracking manually. (page 19)**
- The video heads are dirty.
- **Clean the video heads with a commercially available cleaning tape.**

## The desired sound is not heard, such as SAP, stereo, or regular sound.

- Setting of sounds is not correct.
- **Select a desired sound using A.SELECT. (page 28)**

## Noise is present in the Hi-Fi sound being played.

- Tracking is not set appropriately.
- **Adjust the tracking manually. (page 19)**

## The timer recording function does not work.

- There is an error in programming.
- **Reset the timer recording program. (page 27)**
- There is no cassette in the VCR.
- **Load a cassette with the safety tab attached. (page 18)**
- The cassette does not have the safety tab.
- **Use another cassette with a safety tab or cover the hole with adhesive tape. (page 18)**
- The timer indicator is not displayed.
- **Press both TIMER simultaneously. (page 26)**
- There has been a power failure.
- **Reset the clock. (page 15)**

## The remote control does not work properly.

- The batteries are exhausted.
- **Replace all batteries. (page 10)**
- The remote control is operated beyond the operating range.
- **Make sure the remote control is within 30° of the remote sensor on the VCR. (page 10)**
- Too far from the VCR.
- **Use the remote control within 7 m from the front of the VCR. (page 10)**
- An obstacle may be in the way of the operation.
- **Remove the obstacle.**
- The operating mode of the remote control is not set correctly.
- **Press VCR or TV depending on the equipment you want to operate. (pages 14, 29)**

## The cassette is ejected immediately after it is loaded.

- The cassette was inserted with the label side not paralleling the compartment.
- **Reload it carefully. (page 18)**

## The cassette does not go into the cassette compartment.

- There is already a cassette in the VCR.
- **Eject the cassette and reload the new one. (page 18)**

# Specifications

<b>Power Supply:</b>	120 V AC, 60 Hz
<b>Power consumption:</b>	18 W
<b>External dimensions:</b>	430 x 94 x 252mm (W.H.D.)
<b>Mass:</b>	3.0 kg
<b>Channels received:</b>	VHF: Channels 2–13 UHF: Channels 14–69 CATV: Channels A7-A1,A-CCC, 66-125
<b>Antenna input/output terminals:</b>	UHF/VHF: 75 $\Omega$ F type connector
<b>Signal system:</b>	Standard NTSC
<b>Recording/Playback system:</b>	Recording: VHS format (SP, SLP) Playback: VHS format (SP, LP, SLP)
<b>Cassette:</b>	Video cassette with <b>VHS</b> mark
<b>Tape speed:</b>	SLP: 11.1 mm/s, SP: 33.4 mm/s
<b>Video recording/playback time:</b>	SLP: 480 minutes, SP: 160 minutes (When T-160 video cassette is used.)
<b>Fast forward/rewind time:</b>	Within approx. 60 s (When T-120 video cassette is used.)
<b>Video input:</b>	1 V (p-p), 75 $\Omega$ , unbalanced, negative sync., pin jack
<b>Video output:</b>	1 V (p-p), 75 $\Omega$ , unbalanced, negative sync., pin jack
<b>Audio input:</b>	Line input: 308 mV (rms), more than 47 k $\Omega$ , pin jack
<b>Audio output:</b>	Line output: 308 mV (rms), less than 4.7 k $\Omega$ , pin jack
<b>Audio frequency range (Hi-Fi):</b>	20 Hz – 20 kHz
<b>Audio dynamic range (Hi-Fi):</b>	68 dB
<b>Utilization conditions:</b>	Temperature: 5°C to 40°C Humidity: less than RH 80%

# Accessories

Antenna cable .....	1
Remote control .....	1
Batteries (AAA) .....	2

Designs and specifications are subject to change without notice.

# LIMITED WARRANTY

## TOSHIBA VIDEO CASSETTE RECORDER

---

Toshiba America Consumer Products, Inc. ("TACP") and Toshiba Hawaii Inc. ("THI") make the following limited warranties. These limited warranties extend to the original consumer purchaser or any person receiving this set as a gift from the original consumer purchaser and to no other purchaser or transferee.

### Limited Ninety (90) Day Warranty

TACP/THI warrant this product against defects in materials or workmanship for a period of ninety days after the date of original retail purchase. During this period, TACP/THI will repair a defective product or part, without charge to you. You must deliver the entire product to a TACP/THI Authorized Service Station. You are responsible for all transportation and insurance charges for the set to and from the Authorized Service Station.

### Limited One (1) Year Warranty

TACP/THI further warrant the parts in this product against defects in materials or workmanship for a period of one (1) year after the date of original retail purchase. During this period, TACP/THI will replace a defective part without charge to you, except that if a defective part is replaced after ninety (90) days from the date of the original retail purchase, you pay labor charges involved in the replacement. You must also deliver the entire product to a TACP/THI Authorized Service Station. You are responsible for all transportation and insurance charges for the set to and from the Authorized Service Station.

### Rental Units

The warranty for rental units begin with the first rental or thirty (30) days from the date of shipment to the rental firm, whichever comes first.

### Commercial Units

Products sold and used for commercial use have a limited ninety (90) day warranty for all parts and labor.

### Owner's Manual and Demographic Card

You should read the owner's manual thoroughly before operating this product. You should complete and mail the enclosed Demographic card within ten (10) days after you, or the person who has given you this product as a gift, purchased this product. This is one way to enable TACP/THI to provide you with better customer service and improved products. Failure to return the card will not affect your rights under this warranty.

### Your Responsibility

The above warranties are subject to the following conditions:

- (1) You must retain your bill of sale or provide other proof of purchase.
- (2) You must notify an Authorized TACP/THI Service Station within thirty (30) days after you discover a defective product or part.
- (3) All warranty servicing of this product must be made by an Authorized TACP/THI Service Station.
- (4) These warranties are effective only if the product is purchased and operated in the U.S.A or Puerto Rico.
- (5) Labor service charges for set installation. Set up, adjustment of customer controls and installation of repair or antenna systems are not covered by this warranty. Reception problems caused by inadequate antenna systems are your responsibility.
- (6) Warranties extend only to defects in materials or workmanship as limited above and do not extend to any product or parts which have been lost or discarded by you or to damage to products or parts caused by misuse, accident, damage caused by Acts of God, such as lightning or fluctuations in electric power, improper installation, improper maintenance or use in violation of instructions furnished by us; or to units which have been altered or modified without authorization of TACP/THI or to damage to products or parts thereof which have had the serial number removed, altered, defaced or rendered illegible.
- (7) At your option, after the warranty period has expired in the U.S.A. Call (800)-631-3811 to receive information concerning an exchange price. Payment must be enclosed with the product in the form of a certified check or money order and forward your product to:  
Toshiba America Consumer Products Inc.  
Returns Center  
1420C Toshiba Dr.  
Lebanon, TN 37087
- (8) Upon receipt we will, at our option, replace your unit with a new or refurbished unit of equal value. Features may not be identical to your original product.
- (9) Physically damaged units are not acceptable for repair or exchange in or out of warranty and will be returned as received.



## LIMITED WARRANTY (continued)

### How to Obtain Warranty Service

- (1) Refer to the troubleshooting guide in your owner's manual. This check list may solve your problem.
- (2) Call the TACP toll free number **800-631-3811** within (30) days after you find a defective product or part.
- (3) Arrange for the delivery of the product to the Authorized TACP/THI Service Station. Products shipped to the Service Station must be insured and safely and securely packed, preferably in the original shipping carton, and a letter explaining the defect and also a copy of the bill of sale or other proof of purchase must be enclosed.

**In the Continental United States contact:**



**In Hawaii contact**

**Toshiba Hawaii  
327 Kamakee Street,  
Honolulu, HA 96814  
(808)-591-8377**

All warranties implied by state law, including the implied warranties of merchantability and fitness for a particular purpose, are expressly limited to the duration of the limited warranties set forth above. With the exception of any warranties implied by state law as hereby limited, the foregoing warranty is exclusive and in lieu of all other warranties, guarantees, agreements and similar obligations of manufacturer or seller with respect to the repair or replacement of any parts. In no event shall TACP/THI be liable for consequential or incidental damages.

No person, agent, distributor, dealer or company is authorized to change, modify or extend the terms of these warranties in any manner whatsoever. The time within action must be commenced to enforce any obligation of TACP/THI arising under the warranty or under any statute, or law of the United States or any state thereof, is hereby limited to ninety (90) days from the date you discover or should have discovered the defect. This limitation does not apply to implied warranties arising under state law. This warranty gives you specific legal rights and you may also have other rights which may vary from state to state. Some states do not allow limitation on how long an implied warranty lasts, when an action may be brought or the exclusion or limitation of incidental or consequential damages, so the above provisions may not apply to you.

#### **ATTENTION CANADIAN CONSUMERS:**

Canadian consumers are requested to complete the special Canadian "Warranty Registration Form" enclosed and forward this completed form with a copy of bill of sale to TOSHIBA OF CANADA to "Register and Validate" their warranty. Product must be purchased from an Authorized Canadian Dealer.

Products purchased in the U.S.A and used in Canada are not covered by these warranties.

#### **IMPORTANT: PACKING AND SHIPPING INSTRUCTION**

When you send the product to a Service Station, you should use the original carton box and packing material, then insert the original carton box containing the unite into another carton, using more packing material.

**TOSHIBA AMERICA CONSUMER PRODUCTS, INC.**

Printed in Indonesia  
AC68-01702A

## Free Manuals Download Website

<http://myh66.com>

<http://usermanuals.us>

<http://www.somanuals.com>

<http://www.4manuals.cc>

<http://www.manual-lib.com>

<http://www.404manual.com>

<http://www.luxmanual.com>

<http://aubethermostatmanual.com>

Golf course search by state

<http://golfingnear.com>

Email search by domain

<http://emailbydomain.com>

Auto manuals search

<http://auto.somanuals.com>

TV manuals search

<http://tv.somanuals.com>