

# INSTRUCTION MANUAL

---

INDUSTRIAL ROBOT SR SERIES

---

START-UP MANUAL

---

## Notice

1. Make sure that this Instruction Manual is delivered to the final user of the Toshiba Industrial Robot.
2. Please read this manual before using the Toshiba Industrial Robot.
3. Please read the "Safety Manual" also.
4. Keep the manual nearby for further reference during use of the robot.

**TOSHIBA MACHINE CO.,LTD.**

**1998- 3**

Copyright 1997 by Toshiba Machine Co., Ltd.  
All rights reserved.

No part of this document may be reproduced in any form without obtaining prior written permission from the Toshiba Machine Co., Ltd.

The information contained in this manual is subject to change without notice.

## PREFACE

This manual describes how to start up the Toshiba SR series industrial robot.

Start-up as used in this manual refers to operations from turning on the robot controller to operating the robot by manual guidance. Before operating the controller, make sure that all the cables have been correctly connected among the robot, controller, and peripheral equipment according to the "Transportation and Installation Manual".

This manual is written for users who have not operated SR series robots before. Users who have experience or want to know the details of the operations, see the Operating Manual.

This manual consists of the following chapters.

### Chapter 1 "Before operating SR Series Robot"

This chapter outlines robot operational procedure, names of controls which should be used for the start-up operation, and their functions.

A control panel and teach pendant are used to operate the robot. Be sure to learn where the various switches are.

### Chapter 2 "Power-ON to Manual Guidance"

This chapter describes how to turn on the power and how to manually guide the robot. The last paragraph of this chapter also discusses how to turn off the power. Be sure to follow the precautions which should be taken before turning off the power.

### Chapter 3 "Setting Environmental Conditions for the SR7000 Controller"

This chapter describes items to be set before operating the controller such as date, time and communication channel assignment.

### Chapter 4 "Example of Simple Operation"

This chapter shows how to program and edit data and how to set automatic operations. Because in the chapter you will actually operate the robot, be sure to follow the precautions.

### Chapter 5 "File"

This chapter presents an outline of files used in the robot system and also formatting and backup operations for floppy disks (option). Files which store programs and parameters should be backed up on different disks.

**NOTE!**  
**FOR EUROPEAN UNION (EU)**

In European Union (EU), there are following limitations and notes to approve the CE Marking EMC Direction. In other countries and areas, it is not necessary to apply to these limitations and notes.

(1) Set up conditions

- ◆ The following type of power line transformer must be used.
 

Frequency:	50 or 60 Hz
Secondary voltage:	3 phase 200 ~ 230 VAC
power capacity:	Min. 2.7 kVA

(2) Input power condition

- ◆ Core wires: 3.5 mm<sup>2</sup> ~ 5.5 mm<sup>2</sup>
- ◆ Voltage short interruption: 0.5 cycle

(3) Ground

- ◆ Core wires: 0.08 mm<sup>2</sup> ~ 0.5 mm<sup>2</sup>
- ◆ Ground condition: Exclusive ground line for robot ground impedance must be less than 100 Ω.

(4) External input and output line / Optional input and output line

- ◆ Core wires: 0.08 mm<sup>2</sup> ~ 0.5 mm<sup>2</sup>
- ◆ Shield: Ground shield
- ◆ Cable length: Max. 10 m
- ◆ Manufacturing method: Refer to figure A.
- ◆ Signal ground: Voltage potential between signal ground PGBA and controller frame ground F.G. must be the same.

(5) Serial communication line

- ◆ Only 1 of 4 serial communication ports (connector name; J1 ~ J4) can be used at the same time.
- ◆ Core wires: 0.08 mm<sup>2</sup> ~ 0.5 mm<sup>2</sup>
- ◆ Shield: Ground shield
- ◆ Cable length: Max. 10 m
- ◆ Twisted pair: Not required for RS-232C, required for RS-422.
- ◆ Manufacturing method: Refer to figure A.

(6) Limitation of the robot specification

- |  |                                      |
|--|--------------------------------------|
| ◆ Cable length from robot to controller:             | Max. 8 m                             |
| ◆ Cable length of teach pendant:                     | Max. 8 m                             |
| ◆ Optional 5th axis:                                 | Cannot be used.                      |
| ◆ Optional input output signals(type;SR7000IO):      | Only one optional board can be used. |
| ◆ Optional relay output signals (type;SR7000RO):     | Cannot be used.                      |
| ◆ Optional conveyer tracking system (type;SR7000CV): | Cannot be used.                      |
| ◆ Separated operation panel:                         | Cannot be used.                      |

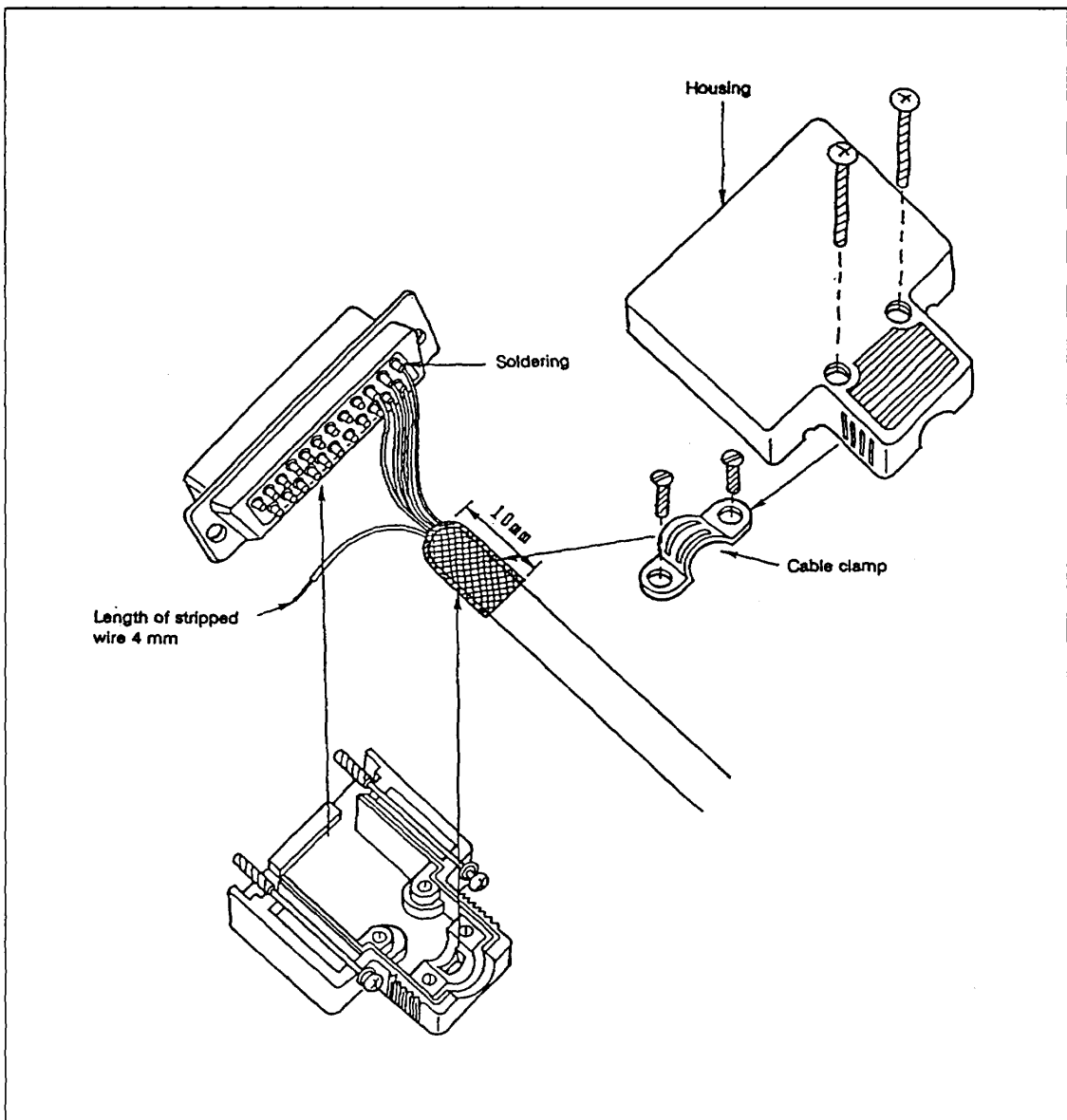

Figure A

## TABLE OF CONTENTS

### CHAPTER 1 BEFORE OPERATING SR SERIES ROBOT

<b>1.1 OVERVIEW</b> . . . . .	<b>1-1</b>
1.1.1 Structure . . . . .	1-2
1.1.2 Functions . . . . .	1-4
<b>1.2 OUTLINE OF OPERATIONAL PROCEDURE</b> . . . . .	<b>1-9</b>
<b>1.3 SPECIFICATIONS</b> . . . . .	<b>1-11</b>
<b>1.4 COORDINATE SYSTEM</b> . . . . .	<b>1-14</b>
<b>1.5 SYSTEM CONFIGURATION</b> . . . . .	<b>1-16</b>
<b>1.6 NAMES AND FUNCTIONS OF SR7000 CONTROLLER</b> . . . . .	<b>1-21</b>
1.6.1 Control Panel . . . . .	1-21
1.6.2 Teach Pendant . . . . .	1-23

### CHAPTER 2 POWER ON TO MANUAL GUIDANCE

<b>2.1 TURNING ON MAIN POWER</b> . . . . .	<b>2-2</b>
2.1.1 Cold Starting . . . . .	2-2
2.1.2 Hot Starting . . . . .	2-5
<b>2.2 SETTING CONTROLLER ENVIRONMENTAL CONDITIONS</b> . . . . .	<b>2-8</b>
<b>2.3 TURNING THE SERVO POWER ON</b> . . . . .	<b>2-9</b>
<b>2.4 MANUAL GUIDANCE OF EACH AXIS</b> . . . . .	<b>2-10</b>
<b>2.5 MANUAL GUIDANCE OPERATION</b> . . . . .	<b>2-13</b>
<b>2.6 MOTION RANGE LIMIT</b> . . . . .	<b>2-16</b>
2.6.1 Setting Joint Limit Values by Teaching . . . . .	2-16
2.6.2 Setting Joint Limit by Numeric Value Entry . . . . .	2-18

<b>2.7 TURNING OFF THE POWER</b>	<b>2-21</b>
2.7.1 Turning OFF Servo Power	2-21
2.7.2 Turning OFF the Main Power	2-21
<b>CHAPTER 3 SETTING ENVIRONMENTAL CONDITIONS FOR THE SR7000 CONTROLLER</b>	
<b>3.1 SETTING DATE AND TIME</b>	<b>3-1</b>
3.1.1 Setting Date	3-1
3.1.2 Setting Time	3-3
<b>3.2 CHANGING FILE DATA</b>	<b>3-6</b>
<b>3.3 SETTING THE SYSTEM CONFIGURATION</b>	<b>3-12</b>
3.3.1 Outline of Data	3-12
3.3.2 File Format	3-14
3.3.3 Details of Data	3-18
<b>3.4 SETTING EXTERNAL SELECTION FILES</b>	<b>3-26</b>
3.4.1 Signals Used for Selecting File	3-26
3.4.2 Contents of File	3-27
<b>3.5 BATCH PROCESSING</b>	<b>3-29</b>
3.5.1 Batch File	3-29
3.5.2 Automatic Execution File	3-31
3.5.3 Using Batch Processing Effectively	3-32
<b>3.6 PROGRAM EXECUTION ENVIRONMENT</b>	<b>3-34</b>
3.6.1 Program Execution Environment	3-34
3.6.2 Resetting Execution Environment	3-36
3.6.3 Reset Timing of Program Execution Environment	3-37
<b>3.7 SETTING COORDINATE SYSTEM</b>	<b>3-38</b>
3.7.1 Robot Coordinate Systems	3-38
3.7.2 Teaching Coordinate Data	3-40
3.7.3 Selecting Coordinate System in Data Editor Mode	3-46
3.7.4 Selecting Coordinate System in Utility Mode	3-53
3.7.5 Selecting Coordinate System Using Robot Language	3-56
3.7.6 Timing of Changing the Coordinate System	3-56

**CHAPTER 4 EXAMPLE OF SIMPLE OPERATION**

<b>4.1 EXAMPLE OF ROBOT OPERATION</b>	<b>4-2</b>
<b>4.2 TEACHING THE PROGRAM AND POSITION DATA</b>	<b>4-3</b>
4.2.1 Inputting A Robot Language Program	4-3
4.2.2 Teaching Positional Data	4-7
4.2.3 Changing Positional Data	4-13
<b>4.3 TEST RUN</b>	<b>4-16</b>
4.3.1 Preparation before Conducting Test Run	4-16
4.3.2 Test Run in Step Operation Mode	4-22
4.3.3 Test Run in Cycle Operation Mode	4-27
4.3.4 Test Run in Continuous Operation Mode	4-32
<b>4.4 AUTOMATIC OPERATION</b>	<b>4-38</b>

**CHAPTER 5 FILES**

<b>5.1 TYPES OF FILES</b>	<b>5-1</b>
<b>5.2 CHECKING FILES</b>	<b>5-3</b>
<b>5.3 FILES REQUIRED TO START UP ROBOT</b>	<b>5-6</b>
5.3.1 Files Required to Perform the Cold Start Operation	5-6
5.3.2 Files Required for the Hot Start Operation	5-7
5.3.3 Setting of Distribution I/O Function	5-8
<b>5.4 FORMATTING FLOPPY DISKS</b>	<b>5-9</b>
<b>5.5 BACKING UP FILES</b>	<b>5-12</b>
5.5.1 Saving Files	5-12
5.5.2 Loading Files	5-15
<b>5.6 COPYING FILES</b>	<b>5-19</b>
<b>5.7 RENAMING FILES</b>	<b>5-23</b>
<b>5.8 DELETING FILES</b>	<b>5-26</b>



## CHAPTER 1

### BEFORE OPERATING SR SERIES ROBOT

This chapter presents an outline of the robot operational procedure, specifications, coordinate system, system configuration, and their functions.

#### 1.1 OVERVIEW

This paragraph deals with an outline of the SR-HSP series Toshiba system robot. The SR-HSP series signifies the horizontally articulated robot.

The robot and robot controller feature as follows:

(1) Robot

- High-speed and smooth motion
  - Cycle time 0.8 sec. under load of 2 kgf, 0.9 sec. under load of 5 kgf (SR-654HS)

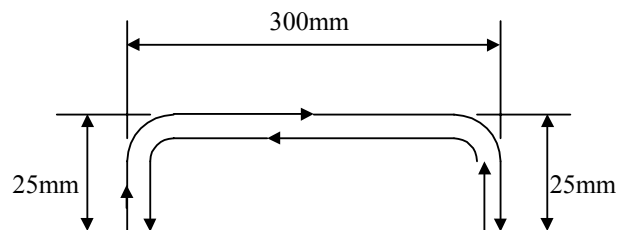

- Wide working range
  - A bidirectional rotating type without dead space included in the horizontal zone. (ST-HS series)
- High reliability
  - Maintenance-free, employing AC servo motors and absolute encoders.
- Enough Ni loading capacity
  - Max. 20 kgf (SR-1054HS)
- Easy wiring and piping
  - As nine cables and two air pipes standardly run in the arm, wiring and piping to the end effector are necessary.

- (2) Robot controller (SR7000)
- Simple programming.
    - A program can be created easily according to highly advanced robot language SCOL.
  - Excellent operability
    - Teaching of positions, programming, adjustment, etc can be performed according to the menu selection on the teach pendant.
  - Extensive interfaces
    - As RS232C three ports, computer and printer interface software are standard-equipped, a diversity of system structure is possible.
  - Easy diagnosis of faults
    - A number of self-diagnostic functions allow an operator to smoothly address faults.

Fig. 1.1 shows the SR–HSP series system robot.

### 1.1.1 Structure

The robot consists of the basic robot, controller and teach pendant connected with the controller, which is intended for teaching positions and entering programs.

To make the robot do a job, programs and position data are necessary so that the robot can execute the job.

Normally, such programs and position data should be created and stored in the controller memory beforehand. When operating the robot, the controller interprets the contents of programs and gives the robot the instructions on motions according to the program sequence to cause the robot to do the job.

Programs and position data for one process which are put together are called the task program, which can also be called the file when they are loaded to and saved in the controller.

As the control unit of the controller uses the SCOL language (symbolic code language for robot), a task program can be easily created and entered as if you were creating a BASIC program.

Entry of position data is possible in the three manners; □ guiding by the robot and teach pendant, □ entry of coordinates through the teach pendant and □ manual guiding of the robot by the operator after turning off the servo control.

The teach pendant can be shared by many robots, and automatic operation is possible even when it is disconnected from the controller.

Also, saving and management of files are very easy, using an optional FDD unit.

In addition to the above, a great number of options and functions including optical sensors for position data compensation and interface software with a personal computer are also available.

Fig. 1.2 shows a system configuration of SR series Toshiba system robots.

SR-1054 HSP Robot

Robot controller SR7000

Teach pendant

Fig. 1.1 SR Series System Robot

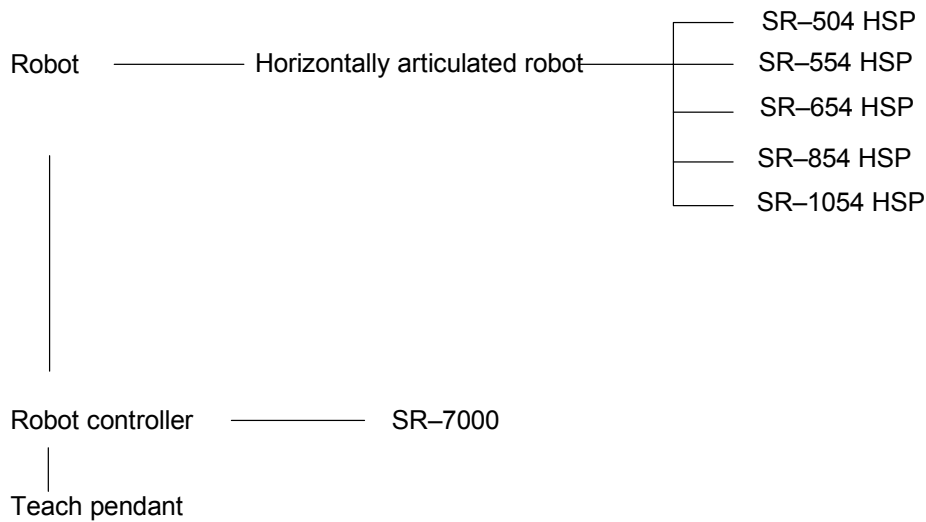

Fig. 1.2 System Configuration of SR Series System Robot

### 1.1.2 Functions

#### (1) Control method

A 32-bit microprocessor serves as the central processor.

A 16-bit microprocessor is used for communication control and a 32-bit microprocessor for each axis servo control, thus servo control, robot language processing and editing are possible. Also, an 8-bit microprocessor is employed for the teach pendant to realize a more intelligent robot.

#### (2) Motion

The motion comes in three types; PTP (point-to-point) control, CP (continuous path) control (linear interpolation, circular interpolation (option)) and short-cut.

- PTP control: Dedicated SCOL language MOVE  
This control is used to move each axis fast to a specified position, irrespective of a path. Simultaneous operation is executed in which all axes start moving simultaneously and finish simultaneously.
- CP control (linear interpolation): Dedicated SCOL language MOVES  
This is the path control in which all paths are predetermined. Each axis moves between two taught points in the Cartesian coordinate system along the shortest distance. It is used to move the end effector of the robot along a straight line.
- CP control (circular interpolation): Dedicated SCOL language MOVEC  
Each axis moves on an arc from the current point to the target point via specified mid-point.

□ Short-cut

Each axis passes the vicinity of a taught point without reaching and stopping at the same point, then moves to the next point. The travel time can be reduced.

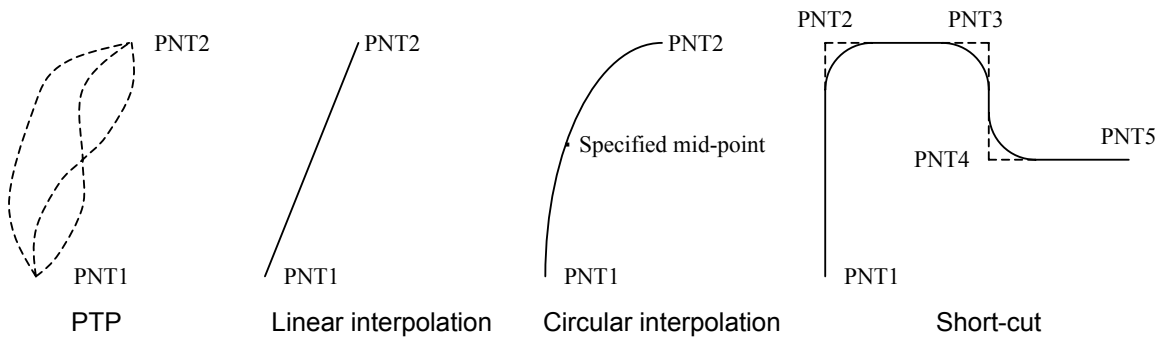

(3) Number of controlled axes

A maximum of five axes can be controlled simultaneously. Additionally, the air cylinder can be driven.

(4) Storage capacity

The storage capacity of the RAM drive is 512 K bytes.

To save files, a 1.44 M bytes FDD unit (option) is available.

The rate of file active area is displayed in units of byte on the teach pendant.

Storage capacity of program alone (approximation): 500 points for 1,000 lines

A floppy disk is initialized in the MS-DOS format. It should be noted that reading of the data contained in floppy disks for the SR-5500 controller is not possible.

(5) Storing method

A file (programs and position data) is stored in the memory backed up by a battery. Check is performed on battery voltage drop and destruction of memory contents, and if an abnormality has generated, an alarm is output to inform the operator to that effect.

(6) Number of program files

Up to 256 program files can be registered.

(7) Position detection

Detected by an absolute encoder on the no-load side of the AC servo motor.

(8) External input/output signals

□ Standard external input

In all, 32 inputs insulated optically are open to the user. Branch of a program and interlock by input signals can be programmed easily, using the robot language.

- Standard external output  
In all, 24 outputs of transistor and open collector are open to the user. Output signal ON/OFF and pulse output can be programmed easily, using the robot language.
  - Extension external input/output  
When an option board is added, addition of 24 inputs and 16 outputs is possible. Furthermore, sixty-four each of input and output that can operate as the slave station of our TC200 programmer are available.
- (9) External operation signal  
To facilitate construction of an FA system, servo ON, servo OFF, start, feed hold, cycle stop, robot operating speed, program reset, etc. are possible by external signals in the external-automatic mode.  
In any other mode, these external signals are neglected, except for the servo OFF signal. The low speed instruction becomes effective also in the internal-automatic mode, however. Also, the signals of ready, automatic operation ON, external-automatic mode ON, fault, servo ON, emergency stop ON, etc. necessary for external operations are output.
- (10) Teaching method  
A program can be entered easily through the teach pendant, using the robot language (SCOL). Position data can be given in the following three manners.
- Teaching by remote-guidance through teach pendant.
  - Entry of coordinates through teach pendant.
  - Manual guidance in servo-free status.
- (11) File editing function  
A file can be registered and deleted on the teach pendant. Program editing is also possible on the display. When the FDD unit (option) is provided, reading and writing of data contained in a floppy disk of 1.44 MB MS-DOS format are possible. Thus, a program can be edited on the personal computer.
- (12) Speed setting
- Program  
Robot travel speed can be programmed in the range of 1 to 100 % in 1 % increments.
  - Override  
A programmed speed can be overridden in the range of 1 to 100 % in 1 % increments.

- Acceleration/deceleration speed setting  
Speed at acceleration can be programmed in the range of 1 to 100 % in 1 % increments, using the ACCEL instruction.  
Likewise, deceleration speed can be programmed in the range of 1 to 100 % in 1 % increments by means of the DECEL instruction.
  - Speed limit  
A limit can be set on the maximum speed so that the robot speed can always be slower than this limit. It is convenient to use in the TEST RUN mode.
- (13) Servo gain ON/OFF function (servo-free)  
Servo control ON and OFF are possible for each axis, using the program instruction (GAIN). The same operation is also possible through the teach pendant.
  - (14) Torque limiting function  
A limit value for each joint motor torque can be set in the range of 0 to 300 %, using the program instruction.  
When transferring or inserting a workpiece, there are occasions in which the robot motion is mechanically obstructed due to faulty workpiece, etc., or no excessive force should be exerted on the workpiece. When this happens, it is possible to prevent damage of the work hand or robot by limiting the motor torque.
  - (15) Interruptive function  
When any external signal is input during robot motion, the motion can be stopped instantly and required processing can be executed by means of external input signals.
  - (16) Coordinate system setting function  
Coordinate systems of the robot and peripheral equipment can be established through the teach pendant.
  - (17) Program function  
When the robot language SCOL is used, jump, subroutine, loop, interruptive processing, delay time, speed setting, interpolation, hand operation, vertical movement and rotation of each axis by an air cylinder are possible.  
For details, see the Robot Language Manual.
  - (18) Operation  
In the internal-automatic operation mode, the five modes are available; step, motion step, cycle, continue and machine lock. (The step and machine lock modes can be selected only in the test operation.)  
In the external-automatic operation mode, the continue or cycle mode can be selected.

- Step  
A program is executed step by step.
  - Motion step  
A motion instruction given in a program is executed once.
  - Cycle  
A program is executed until the END instruction of main task has been executed. That is, a series of operation is executed only once.
  - Continue  
A program is executed, neglecting motion instructions in the same man-machine lock program (i.e., the robot will not move).
  - Machine lock  
A program is executed, neglecting motion instructions programmed, as if the robot were actually moving.
- (19) Working range limitation  
To detect the stroke end limit, soft limits are provided, which can be set by the user at his discretion.
- (20) Self-diagnosis function  
The system performs check on the servo fault, overtravel, transmission error, battery voltage drop, control power fault, parameter destruction, etc. If an error is detected, an appropriate error number is displayed on the teach pendant, and the servo power is turned off according to the error.
- (21) FDD unit (option)  
Files stored in the controller memory (programs and position data) can be stored in floppy disks. It is also possible to load the data of the floppy disks into the controller. A floppy disk is initialized in the MS-DOS format. It should be noted that reading of the data contained in floppy disks for the SR-5500 controller is not possible.
- (22) Personal computer and printer interface  
The interface function of an personal computer and printer is standard-equipped. Thus, management of the robot language and line management can be performed very easily, using the personal computer. Additionally, management of a group of robots is possible by the host computer, thus construction of a highly advanced FA system can be realized.



## 1.2 OUTLINE OF OPERATIONAL PROCEDURE

At the least, the following operations are required to start up the robot.

- (1) Installing the robot and controller at the site and connect the cables in place.

Unpack the controller and robot and install them at the site. After the installation work is complete, connect cables between the controller, robot and peripheral equipment. For details, see the Transportation and Installation Manual.

- (2) Starting up and manually guiding the robot.

After robot installation work is complete, turn on the robot power so that it can be manually operated. The operation range of the robot should have been set before teaching the operation. For the setting procedure, see Chapter 2, "Power ON to Manual Guidance".

- (3) Teaching the contents of the operation to the robot.

To make the robot work, a robot language program and position data should be prepared. After the robot has been started up, input the program and position data. An example of the operation is described in Chapter 4, "Example of Simple Operation". For details, see the Operating Manual and the Robot Language Manual.

- (4) Checking the operation being taught with a test run.

Check that the robot correctly works as taught. An example of the operation is described in Chapter 4, "Example of Simple Operation". For details, see the Operating Manual.

- (5) Making the robot work in an automatic operation mode.

After checking that the robot correctly works as has been taught, make the robot work. An example of the operation is described in Chapter 4, "Example of Simple Operation". For details, see the Operating Manual.

After the robot has been installed, the following components are required to make the robot work.

- Robot main body
- Robot controller
- Teach pendant

Check that cables have been securely connected between the robot body and controller and between the controller and teach pendant.

Note 1)

In the automatic operation mode, it is not necessary to connect the teach pendant to the robot body. Even if the teach pendant is not to be used, it is necessary to connect a dummy connector to the teach pendant connector on the controller. Otherwise, the servo power cannot be turned on.

Note 2)

The low speed instruction signal, servo OFF signal, and emergency stop signal of the external control signal cables should be short-circuited even if they are not used. For the connector locations and terminal numbers to be short-circuited, see the Transportation and Installation Manual. (For the connectors attached to the controller, such signal cables have already been short-circuited.)

### 1.3 SPECIFICATIONS

The basic specifications of SR–HSP series horizontally articulated robots are shown in Table 1.1.

Table 1.1 Basic Specifications of SR–HSP Series Robots

Item		Specification				
Model		SR–504HSP	SR–554HSP	SR–654HSP	SR–854HSP	SR–1054HSP
Controlled axes		4 axes	4 axes	4 axes	4 axes	4 axes
Arm length	Full length	500 mm	550 mm	650 mm	850 mm	1050 mm
	Arm 1	250 mm	250 mm	350 mm	550 mm	580 mm
	Arm 2	250 mm	300 mm	300 mm	300 mm	470 mm
Working range	Axis 1	±110°	±115°	±115°	±115°	±115°
	Axis 2	±137°	±120°	±140°	±145°	±140°
	Axis 3	150 mm	200 mm	200 mm	200 mm	200 mm
	Axis 4	±280°	±280°	±280°	±280°	±360°
Maxi. speed	Axis 1	270°/S	255°/S	255°/S	204°/S	170°/S
	Axis 2	432°/S	432°/S	432°/S	432°/S	270°/S
	Axis 3	1000 mm/S	1000 mm/S	1000 mm/S	1000 mm/S	1000 mm/S
	Axis 4	864°/S	864°/S	864°/S	864°/S	576°/S
	Resultant	4.24 m/S	4.71 m/S	5.15 m/S	5.28 m/S	5.33 m/S
Load	Workpiece mass	2 kgf (max. 4 kgf)	5 kgf (max. 10 kgf)	5 kgf (max. 10 kgf)	5 kgf (max. 10 kgf)	10 kgf (max. 20 kgf)
	Allowable inertia moment at end	0.0225 kgf·m <sup>2</sup>	0.0663 kgf·m <sup>2</sup>	0.0663 kgf·m <sup>2</sup>	0.0663 kgf·m <sup>2</sup>	0.1 kgf·m <sup>2</sup>
Repeatability	X, Y (plane)	±0.02 mm	±0.02 mm	±0.02 mm	±0.03 mm	±0.03 mm
	Axis 3 (vertical)	±0.01 mm	±0.01 mm	±0.01 mm	±0.01 mm	±0.02 mm
	Axis 4 (wrist rotation)	±0.03°	±0.03°	±0.03°	±0.03°	±0.03°
Drive system		AC servo motor	AC servo motor	AC servo motor	AC servo motor	AC servo motor
User wiring	Input	5 nos.	5 nos.	5 nos.	5 nos.	5 nos.
	Output	4 nos.	4 nos.	4 nos.	4 nos.	4 nos.
User air piping		2 pcs.	2 pcs.	2 pcs.	2 pcs.	2 pcs.
Robot body	Mass	38 kgf	55 kgf	60 kgf	70 kgf	90 kgf
	Painting color	Misty white	Misty white	Misty white	Misty white	Misty white

Table 1.2 Basic Specifications of SR7000 Robot Controller

No.	Item		Specification	Remarks
1	No. of controlled axes		Simultaneous control of max. 5 axes.	
2	Operation mode		PTP, CP (linear interpolation, circular interpolation), short-cut	
3	Servo system		Digital servo	
4	Storage capacity		Approx. 6400 points + 12800 steps	512 K bytes
5	No. of registrable programs		Max. 256	
6	Auxiliary memory		3.5 inch FDD unit (MS-DOS format) (option)	1.44 M bytes
7	Storage		Battery backed up RAM	
8	Position detection		Absolute encoders (Battery backed up at power failure)	
9	Teaching method	Point display	Remote: To be guided through teach pendant. Coordinate value: Entry of X, Y, Z, C, T data through teach pendant. Servo-free: Manual movement of arm.	
		Entry of program	Editing through teach pendant.	
10	External I/O signal		32 inputs and 24 outputs	
11	Hand control signal		9 lines (5 inputs and 4 outputs)	
12	External operation signal	Input	Program selection, start, stop, reset, etc.	
		Output	Servo ON, ready, fault, cycle mode, etc.	
13	Serial communication port		RS232C or RS422 three ports (RS422 option) Software for personal computer and printer is standard-equipped.	Among them, one port is used exclusively for the pendant.
14	Speed setting		Override, speed limit, program instruction 1 ~ 100 % for each	
15	Acceleration/deceleration speed setting		Program instruction 1 ~ 100 %	
16	Torque limit		Program instruction 0 ~ 300 %	
17	Teaching box		Teach pendant	
18	Coordinate system		Base, work, tool (Setting of multiple work or tool coordinate systems are possible.)	

No.	Item		Specification	Remarks
19	Operation limit		Soft limit	
20	Self-diagnostic function		Error detection	
21	Interruptive function		Start of interruptive program by input signal, timer, etc.	
22	Operation mode		Internal-automatic, external-automatic, external communication	
23	Operation	Internal	Continue, cycle, step, motion step (segment), machine lock	
		External	Cycle, continue	
24	Basic controller	Outer dimensions	430 (W) □ 230 (H) □ 330 (D) mm	
		Mass	18 kgf	
		Painting color	Ivory, gray	
25	Power supply		200 ~ 230 VAC (3 phases), 50/60 Hz	

## 1.4 COORDINATE SYSTEM

A coordinate system comes in a world coordinate system, base coordinate system and tool coordinate system. Once the coordinate system is established, positions where the robot has to move can be set by coordinate values.

A function which offsets the coordinate system is also provided, and even if the robot position or tool has been changed, the entire program need not be modified accordingly.

In addition to the above, a work coordinate system is also available, which is useful to create position data for palletizing operation.

Positional relationship of respective coordinate systems is shown in Fig. 1.3.

Fig. 1.3

- (1) World coordinate system  
A coordinate system the user defines in a space at arranging equipment or workpieces is called the "world coordinate system."
- (2) Base coordinate system  
A Cartesian coordinate system based on the robot center is called the "base coordinate system." Normally, each axis is set based on the origin (0°) orientation. The base coordinate system can be offset by entering a deviation of each axis of the world coordinate system. Thus, each time the coordinate system is changed, operation points need not be taught to the robot.
- (3) Tool coordinate system  
A Cartesian coordinate system based on the tool set surface (i.e., flange surface) of the robot end effector is called the "tool coordinate system."  
Like the base coordinate system, the tool coordinate system can also be offset so that the robot can move on the basis of the tool edge. Thus, the operator can teach the robot based on the tool edge.
- (4) Work coordinate system  
A coordinate system defined in an actual working space, such as workpiece layout and pallet, is called the "work coordinate system." Thus, data can be created easily at palletizing or offline teaching.

## 1.5 SYSTEM CONFIGURATION

Basically, the robot system is composed of the basic robot, basic controller and teach pendant. The controller has comprehensive interface functions to allow construction of various systems. Fig. 1.4 shows the maximum system configuration.

The basic controller consists of the control panel, CPU printed board serving as the control center, relay printed boards relaying external output signals and other units (such as servo driver).

- \* An external control unit required for external-automatic operation is not provided, which should be prepared by the user at job site.
- \* A system disk (used for cold-starting the system) is attached to the controller. Keep it in your custody.



Fig. 1.4 Maximum System Configuration

## Equipment configuration by operation

Equipment configuration by operation is illustrated below.

## (1) Maximum configuration

Maximum system configuration, including options.

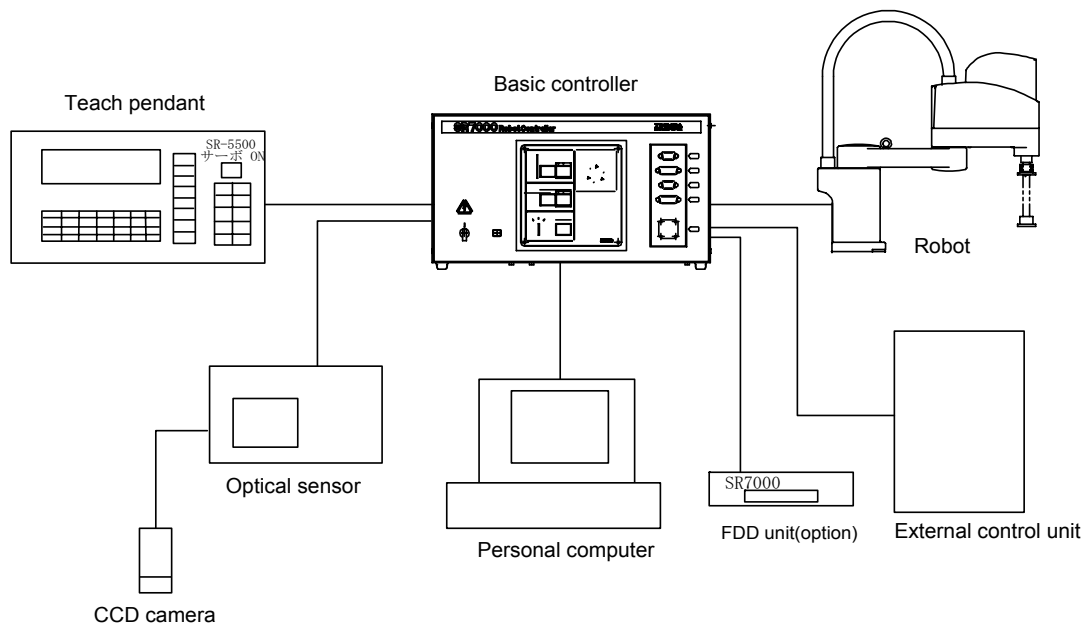

## (2) Manual guidance, teaching of positions by manual guidance and program editing

These operations can be executed, using the same equipment configuration.

It is possible to remote-control the robot through the teach pendant, which is called the "manual guidance." This operation is used when the robot is only to be moved manually or taught the operating positions by manual guidance.

Program editing is also possible by using this configuration.

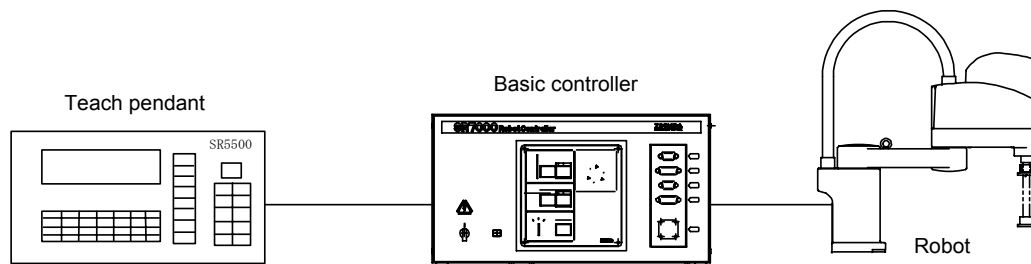

- (3) Internally controlled automatic operation  
Operation of the robot according to files (programs and position data) loaded to the controller is called the "automatic operation." The automatic operation can be controlled internally and externally.  
Start and stop of the robot through the control panel of the controller is called the "internally controlled automatic operation."

Note: Automatic operation is possible by connecting or disconnecting the teach pendant to or from the controller.  
When the teach pendant is disconnected, connect a dummy plug to the teach pendant connector. Unless the dummy plug is connected, the servo power cannot be turned on.

- (4) Externally controlled automatic operation  
Automatic start and stop of the robot with external signals is called the "externally controlled automatic operation."
- (5) Floppy disk  
Files (programs and position data) stored in the controller can be saved in floppy disks (3.5 inch), using an optional FDD unit. It is also possible to load the data in the floppy disks into the controller.
- (6) Automatic operation, using optical sensors (option)  
Automatic operation is possible by using an optical sensor system while recognizing the items subject to the operation and compensating position data.

STE 58760

## 1.6 NAMES AND FUNCTIONS OF SR7000 CONTROLLER

The start up operation is conducted using the control panel and teach pendant. The external views of the control panel and teach pendant are shown in Figures 1.5 and 1.6.

### 1.6.1 Control Panel

The control panel is used to turn on and off the power and perform automatic operation. This paragraph outlines names and functions of the controls. The numbers referenced accord with those in Figure 1.5.

1. Main power switch:  
Power switch for the controller.
2. Circuit protector:  
Circuit protector for the controller control circuit.
3. J1 connector:  
Connector for communication channel 1.
4. J2 connector:  
Connector for communication channel 2.
5. TP connector:  
Connector for connecting the teach pendant.
6. FDD connector:  
Connector for floppy disk drive unit(optional).
7. EMERGENCY switch:  
Switch which unconditionally stops the robot operation. When this switch is pressed, the servo power is turned off and an emergency stop state signal is output. Once this switch is pressed, it is locked in the pressed position. To unlock this switch, turn the switch in the direction of the arrow.
8. SERVO POWER OFF switch:  
A switch which turns off the servo power to stop robot operation. When the servo power is turned off, the lamp on the "OFF" switch lights.

9. SERVO POWER ON switch:  
A switch which turns on the servo power. When the servo power is turned on, the lamp on the "ON" switch lights and a servo ON state signal is output. Unless the servo power is turned on, the robot cannot be operated.
10. STOP switch:  
A switch which stops automatic operation. When this switch is pressed in the automatic operation mode, the lamp on the "STOP" switch lights and the robot stops automatic operation after it completes the current operation. When the robot stops, the "START" switch lamp turns off.
11. START switch:  
A switch which starts automatic operation. When the robot starts automatic operation, the lamp on the "START" switch lights.
12. CYCLE STOP switch:  
A switch which selects the mode that performs one cycle of automatic operation. This operation mode is called the cycle operation mode. In the cycle operation mode, automatic operation stops after the robot has executed the program. When the cycle operation mode is selected, the lamp on the "CYCLE STOP" switch lights.
13. PC connector:  
Connector for connecting a personal computer substituting for a floppy disk unit.
14. MASTER MODE KEY switch:  
A key switch which selects one of robot modes; external automatic mode (EXT), internal automatic mode (INT), and manual mode (MANU). The modes selected with this switch are called master modes.
15. POWER LED:  
Power lamp for the controller. When the main power is turned on, the "POWER" lamp lights.
16. FAULT LED:  
Error lamp for the controller. When a fault is detected, the "FAULT" lamp blinks.
17. Buzzer:  
When a fault is detected, the buzzer beeps. When the STOP switch is pressed, the buzzer stops beeping.

## 1.6.2 Teach Pendant

The teach pendant is used to guide the robot, teach the robot, and check error messages. This paragraph outlines names and functions of the controls. The numbers referenced accord with those in Figure 1.6.

### 1. Emergency switch:

A switch which unconditionally stops robot operation. When this switch is pressed, the power to the servo motors is turned off and an emergency stop state signal is output. When this switch is pressed, it is locked in the pressed state. To unlock this switch, turn the switch again.

### 2. Function keys:

Keys which select one of functions displayed at the bottom of the LCD screen. The function to be selected depends on the mode being executed in the controller.

### 3. Alphanumeric keys:

Keys which enter alphabet characters, numeric characters, and symbols. To enter characters marked on the upper key positions, press the keys while holding down the "Shift" key. To enter characters marked on the lower key positions, simply press the keys.

### 4. Esc key:

A key which cancels characters and instruction being entered.

### 5. Ins key:

A key which inserts new characters between those which have been entered. After this key is pressed, characters being entered are inserted at the position just preceding the cursor. This mode is called the insert mode. When the insert key is pressed again while the insert mode is in effect, the insert mode is canceled. After the insert mode is canceled, characters newly entered will replace existing characters. This mode is called the replace mode.

6. Del key:

The delete key deletes a character which has been entered. Whenever this key is pressed, one character at the cursor is deleted. In the replace mode, the portion being deleted becomes blank. In the insert mode, characters following those being deleted are pushed right by one space every time a character is deleted.

7. Bs key:

The Bs key deletes a character which has been entered. Whenever this key is pressed, the character just preceding the cursor is deleted. After a character is deleted, the cursor moves left one position along with any characters that follow.

8. Ctrl key:

Used together with other key to mainly cancel an input command.

9. Shift key:

The shift key is used to enter characters marked on the upper positions of alphanumeric keys. When any key is pressed while this key is held, the character marked on the top of the key is entered.

10. Alt key:

The Alt key edits programs and data. This key is used along with other keys.

11. Exec key:

The execution key is used mainly to enter data.

12. →←↑↓ key (Cursor keys):

Cursor keys move the cursor right, left, up, and down, respectively.

13. Error key:

The error indication key indicates the contents of an error being detected by the controller on the LCD display. When this key is pressed, the contents of the error are indicated on LCD display of the teach pendant.

14. Utility key:

A key which executes auxiliary controller functions.

15. Aux. signal key:

A key which operates the robot hand and air control axis. These signals are defined as auxiliary signals in the system configuration file.



16. Move key:  
A key which moves the robot to a previously taught position. When teaching positions, specify the position to which you want to move the robot and press this key. The robot will then move to the specified position. While pressing the move key, it is necessary to press the Deadman Switch 23. On the other hand, if the move key is released while the robot is moving, the robot will stop midway.
17. Coordinate key:  
A key which selects a coordination system along which to guide the robot. The LED will light up for the coordinate system currently selected.
18. Teach Speed keys:  
Keys which select a robot travel speed to manually guide the robot. High, Med., and Low represent high speed, medium speed, and low speed, respectively. The LED will light up for the speed currently selected.
19. Control key:  
A key which selects the guidance method for the robot in manual operation. The free mode is used when moving the robot by hand. Inching is a mode where the robot is moved a constant amount whenever the Guidance key (22) is pressed. The Jog is a mode where the robot is moved while the Guidance key is pressed. The LED will light up for the mode currently selected.
20. Feed hold key:  
A key which temporarily stops the current robot operation. When this key is pressed while the robot is moving, the robot stops moving temporarily. In this state, when this key is pressed again, the robot resumes its operation. While the robot is in the temporarily stop state, the LED will be lit.
21. Servo power ON switch:  
A switch which turns on the servo power. When the servo power is turned on, the LED lights up and a servo state ON signal is output. When the servo power is not turned on, the robot cannot be operated.
22. XYZCT keys (Guidance keys):  
Keys which manually guide the robot. The left-hand key and right-hand key of each axis accord with the + direction and - direction, respectively. When one of these keys and the Deadman Switch 23 are pressed, the robot can be guided. However, it is impossible to operate more than one axis at a time.

23. Deadman switches:

Switches which are used to manually guide the robot. Unless one of these keys is pressed, the robot cannot be manually guided. If this key is released while the robot is guided, the robot stops. Although there are six Deadman switches on the rear side of the teach pendant, to guide the robot, you only have to press at least one of them.

24. Liquid Crystal Display (LCD)

Display area is 8 lines × 42 columns.

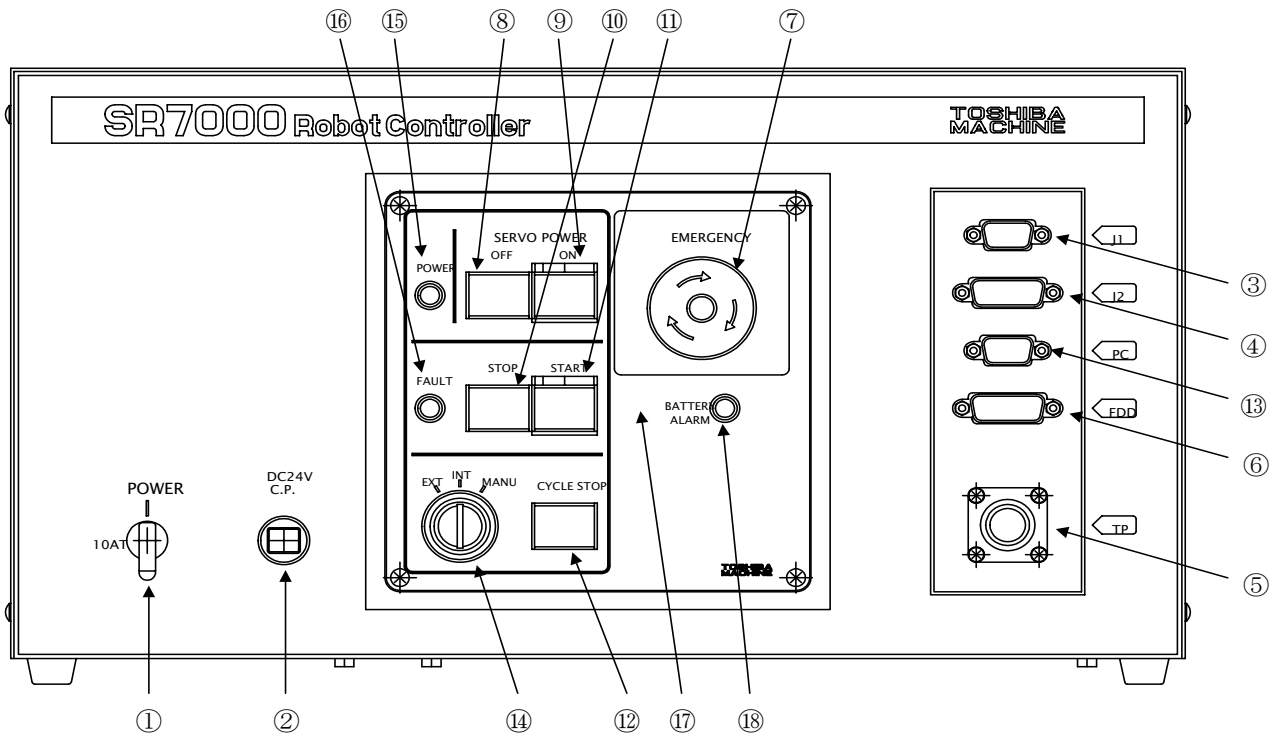

Fig. 1.5 External View of Controller Panel

STE 58760

Fig. 1.6 External View of Teach Pendant

## CHAPTER 2

### POWER ON TO MANUAL GUIDANCE

This chapter outlines how to turn on the power and how to manually guide the robot. For details of how to create a robot language program, how to teach positions to the robot, and how to perform an automatic operation, see Chapter 4, "Example of Simple Operation". Before actually operating the robot, it is necessary to check that the cables have been correctly connected. For details of how to install the robot, see the Transportation and Installation Manual.

The operation procedure from the power ON operation to manual guidance operation is as follows:

- (1) Turn on the main power of the controller.
- (2) Set the environmental conditions of the controller.
- (3) Turn on the servo power.
- (4) Manually guide each axis and check that the robot works correctly.
- (5) Perform the manual guidance operation and check the robot operation.
- (6) Set the operation range.
- (7) Turn off the power supply.

Note)

When performing operations described in this chapter, be sure to place the MASTER MODE KEY switch in the "MANU" (manual mode) position.

## 2.1 TURNING ON MAIN POWER

After checking that there are no problems with the controller and robot cable connections, turn on the main power to start up the robot. There are two methods to turn on the main power; cold starting and hot starting. Normally, only the hot starting is required. For details, see Para. 2.1.2.

### 2.1.1 Cold Starting

After cold starting has been conducted, programs and data necessary for operating the robot are loaded from the floppy disk to the controller. Once the cold starting has been effected, it need not be repeated unless the robot went wrong. If there is some problem with the robot, perform hot starting.

#### Caution

If an abnormality has generated or the POWER LED lamp on the control panel remains off after the main power switch of the controller was turned on, turn off the main power immediately and confirm the wiring. Otherwise, you will be struck by an electric shock or a fire will break out.

#### Caution

When the cold start operation is conducted, the contents of the controller memory (including a robot language program, position data, and user parameters) are initialized. To prevent user data from being erased, be careful not to unintentionally conduct the cold start operation. Be sure to back up the user programs. It is also recommended to always back up all user programs.

Conduct the cold start operation in the following manner.

- (1) Insert the system disk into the FDD unit (option). (For the connections, see the Interface Manual.)
- (2) Hold the floppy disk in the manner that the label side is up and the disk shutter (metal cover) enters the FDD first. Lightly insert the attached floppy disk (system disk) into the FDD unit until a click is heard.

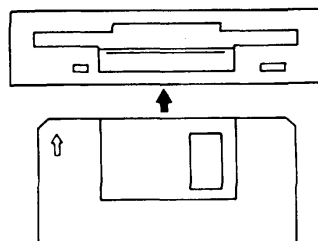

Note)

The disk provides a write-protection tab which prevents the user from mistakenly erasing the contents. When using the system disk, prior to inserting it into the FDD, make sure to slide the write-protection tab outward. When the tab is in the outward position (figure (a)), data cannot be written on the floppy disk. On the other hand, when the tab is in the inward position (figure (b)), data can be written on the floppy disk. In any case, slide the tab all the way until a click sound is heard.

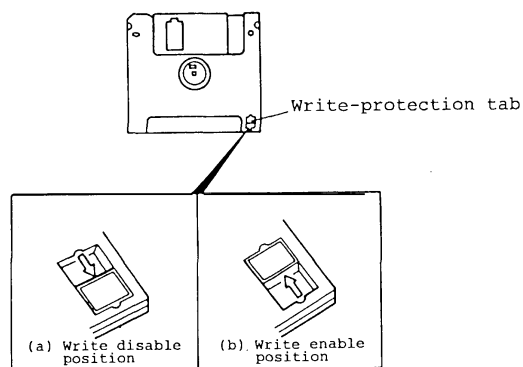

(3) Turn on the MAIN POWER switch on the control panel.

Turn on the MAIN POWER switch on the control panel. When the main power is turned on, the POWER LED will light up.

Note)

Should the "POWER LED" not light even if the MAIN POWER switch is turned on, or should any fault occur, immediately turn off the MAIN POWER switch and check the cables connected to the controller.

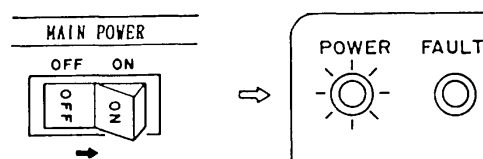

- (4) The contents of the system disk are read in by the controller.

The LED on the FDD blinks several times and the contents of the floppy disk are read to the controller. When the controller is correctly started up, the following message appears on the LCD screen on the teach pendant.

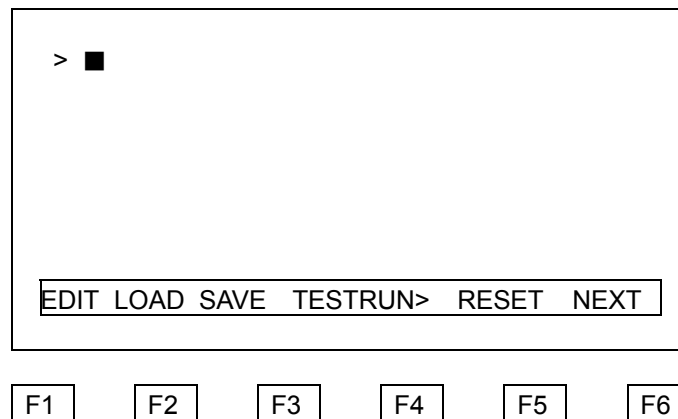

When the cold start operation is conducted, the controller works as follows.

When the power is turned on, the controller reads in the system programs from the system disk. While the system programs are read, the lamp on the "START" switch blinks. When the system programs have been read in from the disk, the lamps on the "START", "STOP" and "CYCLE STOP" switches light up for 0.5 sec. After that, the lamp on the "STOP" switch lights up and the screen as shown above appears. After that, files of parameters and so forth are read to the controller. After all the required files are read to the controller, the contents in the automatic execution file are executed. In this state, the controller can be operated.

For details of the automatic execution file, see 3.5, "Batch Process".

When an error occurs during the cold start operation, take proper action corresponding to the error message appearing on the screen.

- (5) After the controller has been started up, remove the system disk from the FDD. When pressing the FDD pushbutton, the floppy disk is slightly ejected from the disk entrance. Hold the label portion of the disk and remove the disk.



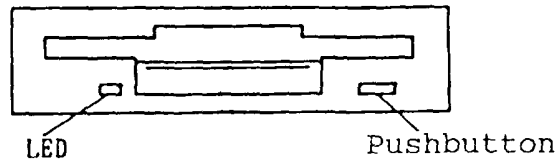

Note)

While the LED on the FDD lights or blinks, be certain not to remove the floppy disk from the entrance. Otherwise, the FDD, floppy disk, and/or controller may be damaged.

The cold start operation is now complete.

### 2.1.2 Hot Starting

While programs and data necessary to operate the controller are stored in memory of the controller, the controller can be started up directly without performing the cold start operation, which is called the "hot start". Once the cold start operation has been conducted, unless any fault occurs in the robot system, it is not necessary to conduct the cold start operation again.



#### Caution

If an abnormality has generated or the POWER LED lamp on the control panel remains off after the main power switch of the controller was turned on, turn off the main power immediately and confirm the wiring. Otherwise, you will be struck by an electric shock or a fire will break out.

When hot starting has been done, the controller enters a program reset status.

Conduct the hot start operation in the following manner.

- (1) Turn on the MAIN POWER switch on the control panel.

Turn on the MAIN POWER switch on the control panel. When the MAIN POWER is turned on, the "POWER LED" on the control panel will light up.

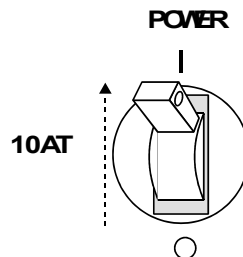

## Note 1)

Should the "POWER LED" on the control panel not light even if the MAIN POWER switch is turned on, or should any fault occur in the system, immediately turn off the Main Power switch and check the cables connected to the controller.

## Note 2)

If the system disk was in the FDD unit when the main power was turned on, the controller will perform cold start. Before turning on the main power, check to see that the system disk has not been inserted into the FDD unit.

## Note 3)

If a floppy disk which contains any of the files CONSTRUC. SYS, SYSTEM. PAR, USER. PAR, EXTRNSEL. SYS, SCOL. LIB, ALARM.MES, or AUTOSTR. BAT has been inserted into the FDD unit, the contents of the files will be read to the controller when the main power is turned on. For an outline of each file, see Chapter 5.

(2) The controller starts up.

When the controller has been correctly started up, the following message appears on the LCD display on the teach pendant

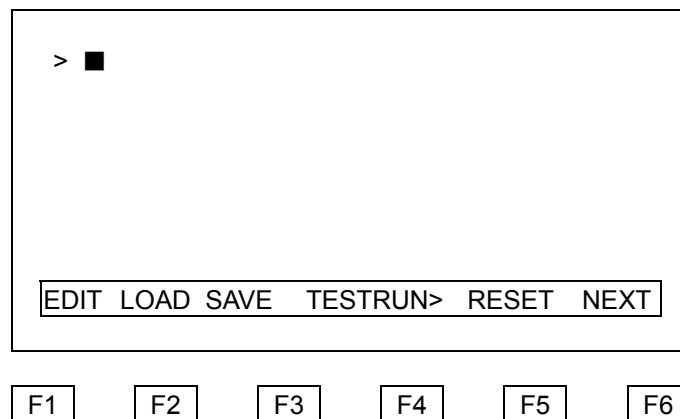

During hot start-up, the controller works as follows: When the main power is turned on, the controller reads in the contents of the floppy disk in the FDD. Unless the system disk has not been inserted, the system stored in the controller conducts hot starting. During the hot start operation, the lamp on the "START" switch on the control panel blinks. When the controller is started up, all the lamps on the "START", "STOP" and "CYCLE STOP" switches light for approx. 0.5 sec. After that, the lamp on the "STOP" switch lights and the screen as shown above appears. After that, files for parameters and so forth are read in from the floppy disk to the controller. Any required files are read to the controller.

After all the files have been read, the automatic execution file is executed. In this state, the controller can be operated.

For details of the automatic execution file, see 3.5, "Batch Processing".

If an error occurs during the hot start operation, take proper action corresponding to the error message which appears on the display. If the controller cannot be started up using the hot start operation, conduct the cold start.

The hot start operation is now complete.

## 2.2 SETTING CONTROLLER ENVIRONMENTAL CONDITIONS

Before operating the robot system, it is necessary to set data for the controller. This data is stored in the system configuration file (file name: CONSTRUC. SYS).

In addition, the controller requires the operator to set date and time.

This data setting is referred to as setting the environmental conditions of the controller. Details of how to set individual data items are described in Chapter 3, "Setting Environmental Conditions for the SR7000 Controller". This paragraph outlines setting environmental conditions for the controller.

Controller environmental conditions should be set only when the robot is installed. The included system disk stores standard environmental condition values corresponding to the robot being delivered. If the operator does not need to change the preset values, he or she can use them as they are. (Date and time have been set at the factory.)

Set the environmental condition values of the controller in the following manner.

- (1) Set the current date and time.
- (2) Check the contents of the system configuration file.
- (3) When selecting files to be executed with external input signals, create an external selection file.
- (4) When changing the contents of the system configuration file or when creating the external selection file, the contents should be saved on a floppy disk.
- (5) Turn off the power supply of the controller and then start up the controller using the hot start operation.

For details of how to set environmental condition values of the controller, see Chapter 3, "Setting Environmental Conditions for the SR7000 Controller"

## 2.3 TURNING THE SERVO POWER ON

The power supplied to the servo motors of the robot is called servo power. Unless the servo power is turned on, the robot will not work. Furthermore, before the operator enters the dangerous area of the robot, make sure to turn off the servo power.

Turn on the servo power in the following manner.

### Caution

- If the robot moves abnormally at servo power ON, press the EMERGENCY STOP switch immediately to turn the servo power off.
- If anyone enters the robot working range, turn the servo power off beforehand.

- (1) Open the transparent cover of the "SERVO POWER ON" switch on the control panel and press the switch. When the servo power is turned on, the lamp on the "SERVO POWER ON" switch will light up.

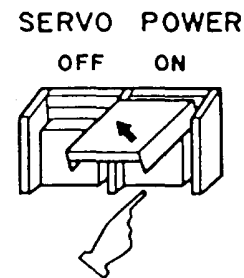

#### Note 1)

When the contacts of the emergency stop signal and servo OFF signal are open, or when no cable is connected to the TP (Teach Pendant) connector on the control panel, the servo power cannot be turned on. For controller cable connections, see the Transportation and Installation manual. Connect the teach pendant or a dummy connector to the TP connector on the control panel. In addition, when the emergency stop (EMERGENCY) switch is pressed on the teach pendant or the control panel, the servo power will not be turned on.

#### Note 2)

If the robot misoperates when the servo power is turned on, immediately press the emergency stop switch and turn off the servo power.

## 2.4 MANUAL GUIDANCE OF EACH AXIS

The operation where the robot is operated using the teach pendant is called manual guidance. When the servo power is turned on, conduct manual guidance for each axis and check to see that the robot works correctly. When actually operating the robot, make absolutely sure that the robot will not hit anybody or anything.

Conduct manual guidance in the following manner.

### Caution

- If the guidance is performed manually, DO NOT enter the robot dangerous area.
- If the robot moves abnormally, immediately effect an emergency stop.
- If the robot will not move in the specified direction, consult Toshiba Machine.

- (1) Select the joint coordinate mode as the coordinates.

Press the "Coordinate" key on the teach pendant several times until the "Joint" LED lights up.

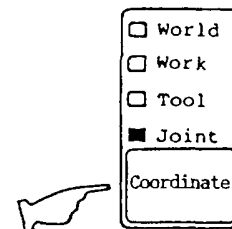

- (2) Set the guide speed to low.

Press the "Teach Speed" key on the teach pendant several times until the "Low" LED lights up.

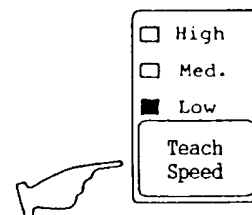

(3) Press the deadman switch.

Press one of the six deadman switches on the rear side of the teach pendant. While guiding the robot, press this switch inside. The robot will not work while the switch is released.

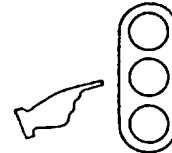

(4) Press one of the XYZCT keys.

At the time, the joint (axis) corresponding to the switch being pressed moves. The XYZCT keys correspond to axes 1 to 5, respectively. Check that the robot works for all axes. In addition, check that the right joint moves in the right direction in accordance with the guidance key being pressed. The number and types of joints and the direction thereof depend on the robot type. For details, see the Transportation and Installation Manual.

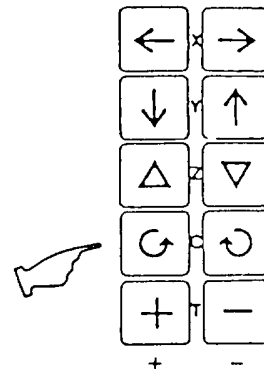

Note 1)

While the teach speed is set low speed, the robot will move at a very low speed. Thus, it seems that the robot stops even while guided. This does not mean the robot is malfunctioning.

Note 2)

When two or more of the XYZCT keys are pressed, the robot will not work. In addition, when any key other than the deadman switch and Servo ON switch on the teach pendant is pressed, the robot will not work.

## Note 3)

In the horizontally articulated type robots, there is an axial interference between the joint axes. For example, when the axis 2 is moved, the servo motors of axes 3 and 4 also move to keep axis Z in the same place. When an axis is operated and another axis also moves, it is conceivable that set parameters are incorrect. In this case, contact us at the after-sale service department or our agent in your territory.

(5) Check that the robot soft limit switches work correctly.

Guide each axis to the motion limit position and check that it works correctly. When the robot detects a motion limit position, an error message appears on the teach pendant. The robot cannot be guided out from the soft limit.

(6) Set the guide speed to the middle and high speed and guide the robot

Press the "Teach Speed" key on the teach pendant several times until the "Med." or "High" LED lights. After that, press the desired XYZCT key and guide the robot. Check that the robot moves smoothly.

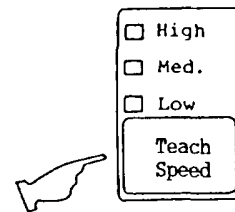



## 2.5 MANUAL GUIDANCE OPERATION

The manual guidance operation can move the robot along various coordinate systems as well as moving each joint (axis). The operation which guides each joint of the robot is named JOINT guidance, while the operation which guides the robot along a coordinate system is named coordinate guidance. The operator can select either the world, work, or tool coordinate system in which to move the robot. The coordinate system in which the robot moves depends on the robot type. For details of the robot's coordinate system, see the Introductory Manual.

When operating the robot, take care that the robot does not hit workers or anything else. Because manual guidance is conducted in the manual mode, it is necessary to place the MASTER MODE KEY switch on the control panel in the "MANU" (manual mode) position.

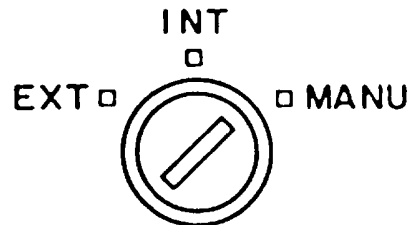

Conduct manual guidance for the robot in the following manner.

### Caution

- If the guidance is performed manually, DO NOT enter the robot dangerous area.
- If the robot moves abnormally, immediately effect an emergency stop.
- If the robot will not move in the specified direction, consult Toshiba Machine.

(1) Select the desired coordinates system.

Press the "Coordinate" key on the teach pendant several times to select the desired coordinate system.

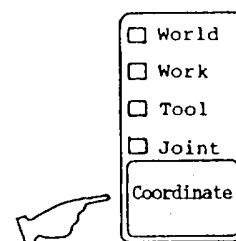

When the "World" LED lights up, the robot will move along the world coordinate system.  
 When the "Work" LED lights up, the robot will move along the work coordinates system.  
 When the "Tool" LED lights up, the robot will move along the tool coordinate system.  
 When the "Joint" LED lights up, each joint of the robot will move separately.

- (2) Set the guide speed to low speed.

Press the "Teach Speed" key on the teach pendant several times until the "Low" LED lights up.

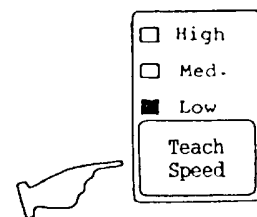

- (3) Press the deadman switch.

Press one of six deadman switches on the rear side of the teach pendant. While guiding the robot, keep this switch held inside. While the switch is released, the robot will not work.

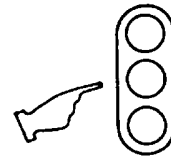

- (4) Press one of the XYZCT keys.

The joint (axis) corresponding to the switch being pressed moves. The XYZCT keys correspond to axes 1 to 5, respectively. Check that the robot works for all axes. In addition, check that the right joint moves in the right direction in accordance with the guidance key being pressed. The number and types of joints and the direction thereof depend on the robot type. For details, see the Introductory Manual.

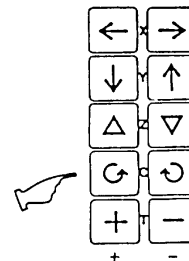

Note 1)

While the teach speed is set low speed, the robot will move at a very low speed. Thus, it seems that the robot stops even while guided. This does not mean the robot is malfunctioning.

Note 2)

When two or more keys of the XYZCT keys are pressed, the robot will not work.

Note 3)

If the robot does not move in the direction being specified, it is conceivable that set parameters are incorrect. In this case, call us at the after-sale service department.

(5) Set the teach speed to the middle speed and high speed and guide the robot.

Press the "Teach Speed" key on the teach pendant several times until the "Med." or "High" LED lights up. After that, press the desired XYZCT key and guide the robot. Check that the robot moves smoothly.

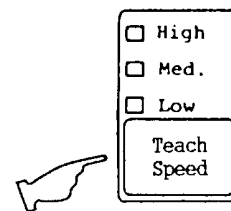

## 2.6 MOTION RANGE LIMIT

In executing the automatic operation or in teaching a position, the operation range and the teaching range of the robot can be limited. When they are limited, the robot is not moved to a position out of the operation range in the automatic operation, so that the position out of the operation range cannot be taught. The limitation of the operation range is called the joint limit. The joint limit should be set in two directions of + direction and - direction of each joint.

The joint limit can be set in the following two methods. 1st method: Guide the robot and teach positions. 2nd method: Input the position of each joint with numeric values from the teach pendant.

When a joint limit is changed, software which used to work may not work anymore. Thus, any joint limit should not be unintentionally changed.

Each joint limit has been set to the maximum motion range at the factory. Unless there is necessity to change a joint limit, use it as it has been set at the factory.

Note)

The joint limit values are stored in the user parameter file (USER.PAR). Before the operator changes the joint limit values, it is recommended to back up the user parameter file. For an instruction of how to back up the file, see 5.5, "Backing Up Files".

### 2.6.1 Setting Joint Limit Values by Teaching

The joint limit values are taught in the following manner.

- (1) Check that controller monitor command menu appears at the bottom of the LCD display on the teach pendant.

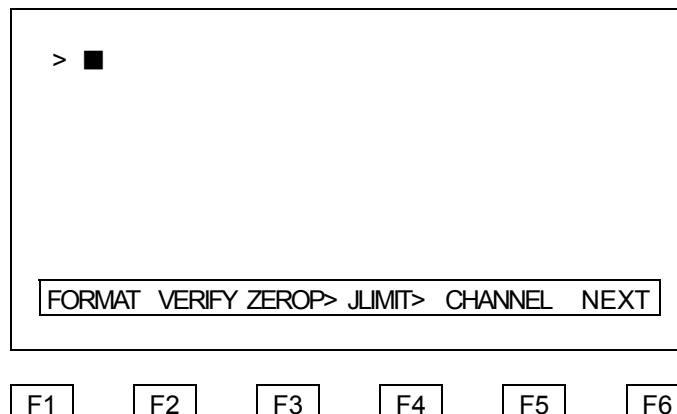

- (2) Whenever you press the "F6" key on the teach pendant, the monitor command menu accordingly changes. Repeat this key operation until the "JLIMIT>" command appears on the LCD display.

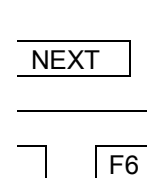

- (3) Press the function key which accords with the "JLIMIT>" command. After that, the LCD display on the teach pendant shows the following screen.

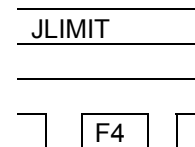

TRAVEL	JOINT	<NEGATIVE>	<POSITIVE>
[mm]	<T1>	-5.868	111.000
or	<T2>	-138.000	138.000
[deg]	<T3>	-0.500	200.500
	<T4>	-400.000	400.000
	<T5>	-5729.578	5729.578
>			
<div style="border: 1px solid black; padding: 2px; display: inline-block;">                     N1-mem P1-mem N2-mem P2-mem N3-mem &lt;next&gt;                 </div>			



- (4) Guide each axis of the robot to the position where the joint limit has been set.  
 (5) Store the joint limit position value of each axis.

After guiding each axis of the robot to the position where the joint limit has been set, store the position value by pressing the related function key on the teach pendant. Above the function keys, a menu such as "Pi-mem", "N1-mem" corresponding to the controller axes appears. The first letter "P" and "N" represent + direction and - direction of each joint axis. In addition, the letter following "P" or "N" accords with the robot joint number. Press the key corresponding to the axis and direction where the joint limit is taught.

If the corresponding axis and direction do not appear on the display, press the "F6" key.

Pressing the "F6" key causes the messages at the bottom of the display to change to those of remaining axes.

- (6) Last, press the "Esc" key to complete the joint limit setting.

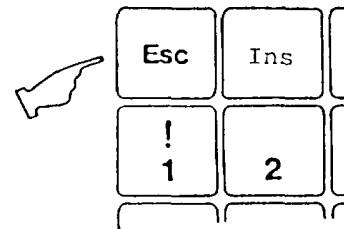

## 2.6.2 Setting Joint Limit by Numeric Value Entry

Set the joint limit by entering numeric values in the following manner.

- (1) Check that the controller monitor command menu appears at the bottom of the LCD display on the teach pendant.

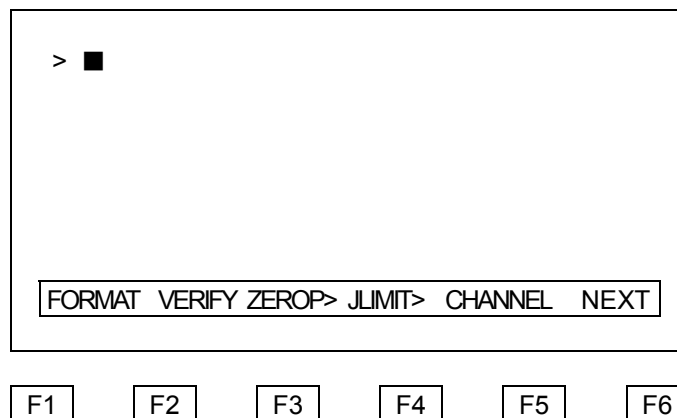

- (2) When you press the "F6" key on the teach pendant, the monitor command menu changes accordingly.

Repeat this key operation until the "JLIMIT>" command appears on the LCD display.

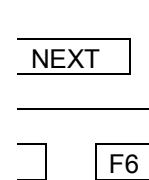

- (3) Press the function key which corresponds with the "JLIMIT>" command. The LCD display on the teach pendant should then show the following screen.

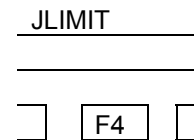

TRAVEL	JOINT	<NEGATIVE>	<POSITIVE>
[mm]	<T1>	-5.868	111.000
or	<T2>	-138.000	138.000
[deg]	<T3>	-0.500	200.500
	<T4>	-400.000	400.000
	<T5>	-5729.578	5729.578
>_			
N1-mem P1-mem N2-mem P2-mem N3-mem			<next>



- (4) Enter joint limit values with numeric keys.

The joint limit position value of the axis to be set should be entered in units of millimeters or degrees.

- (5) Store the joint limit position value of each axis.

After entering the joint limit position values, press the function key on the teach pendant to store them. Above the function keys, a menu having "P1-mem" "N1-mem ...". corresponding to the controller axes appears. The first letter "P" and "N" represent + direction and - direction of each joint axis. In addition, the number following "P" or "N" accords with the robot joint number. Press the key corresponding to the axis and direction for which the joint limit is to be set.

If the corresponding axis and direction do not appear on the display, press the "F6" key.

Pressing the "F6" key causes the messages at the bottom of the display to change to those of remaining axes.

Example)

When setting the joint limit in the minus direction of axis 1 to -90 degrees, enter the following keys in sequence.

[ - ] [ 9 ] [ 0 ] [ Exec ] [ F1 ]

TRAVEL	JOINT	<NEGATIVE>	<POSITIVE>
[mm]	<T1>	-5.868	111.000
Or	<T2>	-138.000	138.000
[deg]	<T3>	-0.500	200.500
	<T4>	-400.000	400.000
	<T5>	-5729.578	5729.578
> -90			
N1-mem P1-mem N2-mem P2-mem N3-mem <next>			

[ F1 ] [ F2 ] [ F3 ] [ F4 ] [ F5 ] [ F6 ]

(6) Last, press the "Esc" key to complete the joint limit setting.

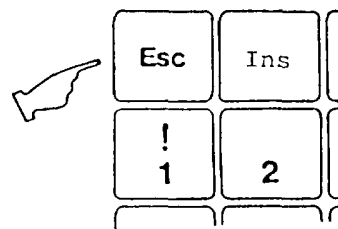

(7) Finally, turn off the controller power, then effect a hot-start. The joint limit setting becomes effective. (For details of how to turn the power off, see Para. 2.7.)



## 2.7 TURNING OFF THE POWER

After the robot operation is complete, turn off the controller power (main power and servo power). When the main power is turned off, the servo power also turns off at that time. Generally, one turns off the servo power first and then turns off the main power. It is also possible to turn off the power source at the controller connection.

### 2.7.1 Turning OFF Servo Power

Turn off the servo power in the following manner.

- (1) Check that the robot is stopped.

Avoid turning off the power while the robot is moving if at all possible.

- (2) Press the "SERVO OFF" switch on the control panel.

When the servo power is turned off, the lamp on the switch should light up.

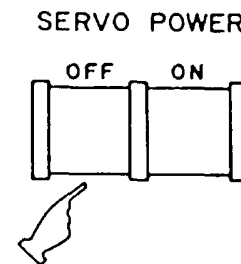

### 2.7.2 Turning OFF the Main Power

Turn off the main power in the following manner.

- (1) Check that the robot is stopped.

Avoid turning off the power if at all possible while the robot is moving.

If the robot is operating in the automatic operation mode, cancel the automatic operation mode. If the main power is turned off while the robot is in the automatic operation mode, the contents of the program may be lost.

- (2) Turn off the servo power.

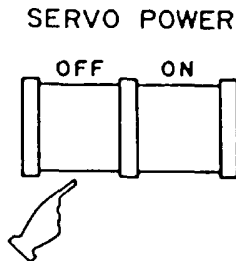

- (3) Check that the FDD unit (option) is not in operation.

While the FDD is in operation, the LED on the FDD will be lit up. When the power is turned off while the LED is still lit, the contents of the floppy disk in the FDD may be damaged. While the FDD is in operation, do not turn off the main power. In addition, to protect the contents of the floppy disk, it is necessary to remove the disk from the FDD, before turning off the main power.

Note)

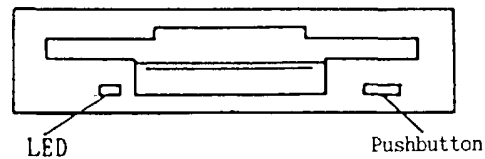

If the main power is turned off and then turned on while the system disk is inserted in the FDD, the controller will be cold started. To prevent this, be sure to turn off the main power after removing the disk from the FDD.

- (4) Check that no editing is being conducted with the controller.

If the main power is turned off while a robot language program is being edited, while position data is being taught, or while parameters are being edited, data being edited or set may be lost. (Moreover, other data may be also lost). Editing should be completed before turning off the main power.

(5) Turn off the Main Power switch on the control panel.

When the main power is turned off, the "POWER LED" on the control panel turns off.

## CHAPTER 3

### SETTING ENVIRONMENTAL CONDITIONS FOR THE SR7000 CONTROLLER

The operator should set items such as the robot configuration and the communication channel modes before he or she operates the robot system. The operator should set the date and time for the controller for file management and fault display information. The operation for setting such data is called controller environmental condition setting. Except for the date and time, such data is stored in a system configuration file (CONSTRUC. SYS).

In addition, to use external signals to select a file to be executed, it is necessary to first create an external selection file (EXTRNSEL. SYS).

This chapter describes how to set individual data which defines the environmental conditions of the controller.

#### 3.1 SETTING DATE AND TIME

The controller provides a clock function which indicates the current date and time. When the robot system detects an error, the function indicates the date and time when the error occurred along with a related error message.

Date and time have been set at factory. However, when the controller power has been turned off for a long time, the controller clock may become off. In this case, it is necessary to reset the correct date and time.

Note)

The accuracy of the controller clock is within 15 sec per month. Thus, it is necessary to periodically check and adjust the clock.

##### 3.1.1 Setting Date

Set the current date in the following manner.

- (1) Turn on the controller main power and place the MASTER MODE KEY switch on the control panel in the "MANU" position. The following monitor command menu will appear at the bottom on the teach pendant LCD display.

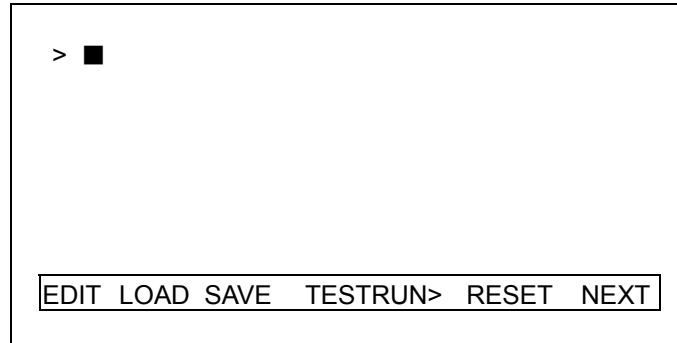

- (2) The command mode menu will change whenever you press the "F6" key. Repeat until the "DATE" command appears.

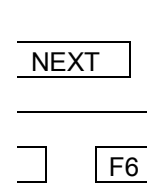

- (3) Press the function key corresponding to the "DATE" command. The following function key menu will then appear.

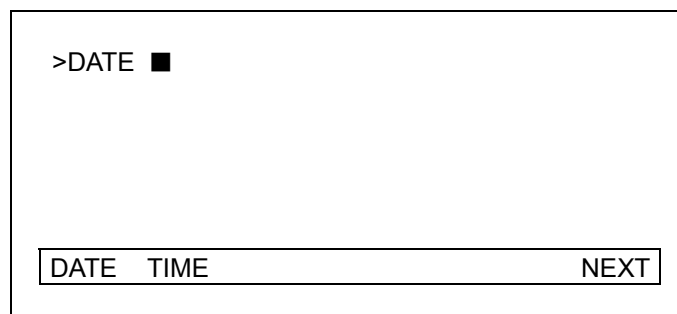
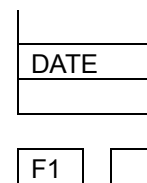

(4) Enter the current year, month, and day.

Example)

Let's assume that the current date is January 1, 1998. enter the current date values, enter the following data.

[9] [8] [-] [0] [1] [-] [0] [1] [Exec]

If you press the "Exec" key without entering a new year, month, and day, the current year, month, and day will appear.

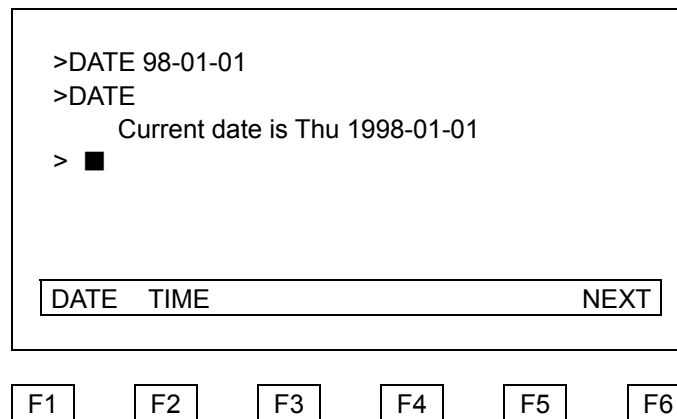

Note)

If invalid data was entered, a message "Incorrect new date" appears on the display. At the time, enter correct data.

### 3.1.2 Setting Time

Set the current time in the following manner.

- (1) Turn on the controller main power and place the MASTER MODE KEY switch on the control panel in the "MANU" position. The following monitor command menu appears at the bottom of the teach pendant LCD display.

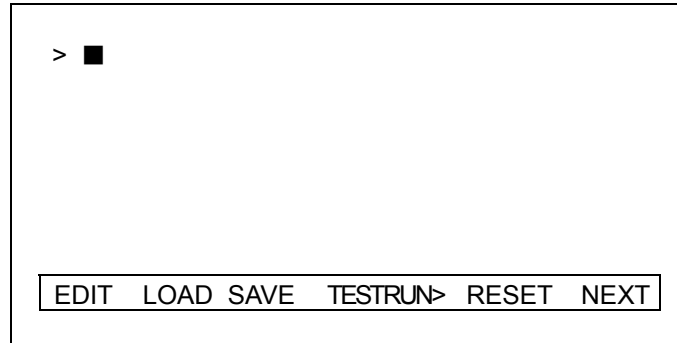

- (2) The command menu will change whenever you press the "F6" key on the teach pendant. Repeat until the "TIME" command appears.

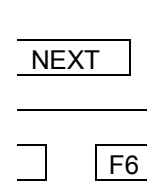

- (3) Press the function key corresponding to the command. The following screen will appear.

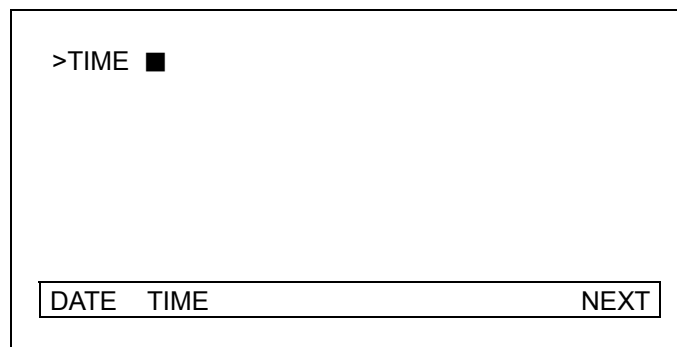
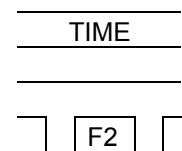

(4) Enter the current time. Example)

Assume that the current time is 2:50:45 p.m. To set correct time, enter the following data.

[1] [4] [:] [5] [0] [:] [4] [5] [Exec]

If you press the "Exec" key without entering new hour, minute, and second values, the current time values will appear on the display.

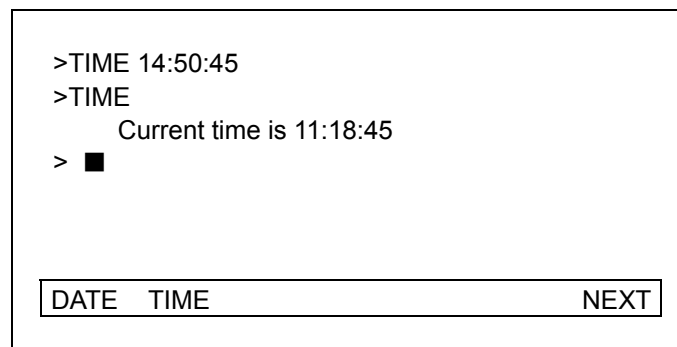

Note 1)

Time values should be entered in the 24 hour system rather than the 12 hour system.

Note 2)

If invalid time values are entered, a message "Incorrect new time" appears. At the time, enter the correct time.



### 3.2 CHANGING FILE DATA

To edit files including the system configuration file, use the screen editor function. The basic operation of the screen editor is as follows:

- (1) Turn on the main power of the controller and place the MASTER MODE KEY switch on the control panel in the "MANU" position. The following controller monitor command menu appears at the bottom of the teach pendant LCD display.

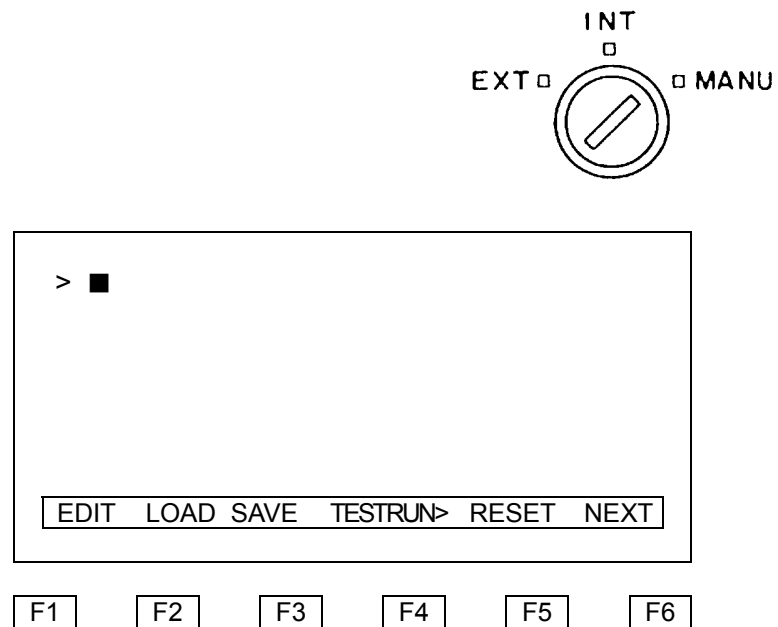

- (2) Whenever you press the teach pendant "F6" key, the monitor command menu changes accordingly. Repeat this key operation until the "EDIT" command appears.

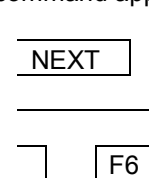

- (3) Press the function key corresponding to the "EDIT" command. The following command menu will appear.

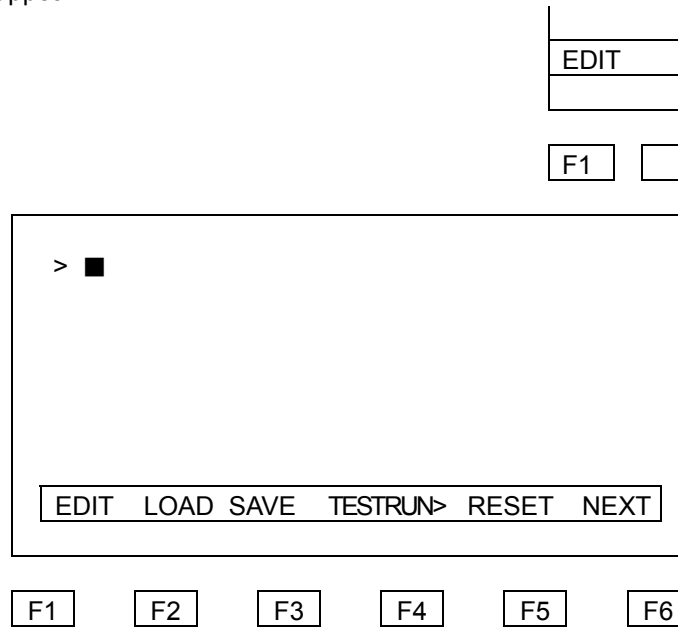

- (4) Enter a file name to be edited. To edit the system configuration file, enter the following.

[C] [O] [N] [S] [T] [R] [U] [C] [.] [S] [Y] [S]

To edit the external selection file, enter the following.

[E] [X] [T] [R] [N] [S] [E] [L] [.] [S] [Y] [S]

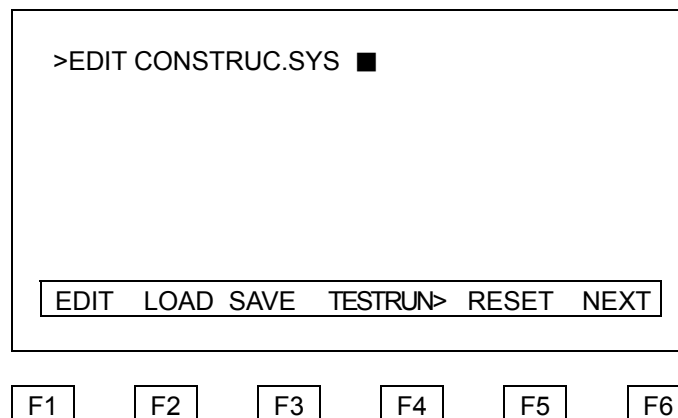

If incorrect data has been entered, press the "Bs" key to delete the immediately preceding character.

- (5) Press the "Exec" key on the teach pendant. The number of files being stored in the RAM drive of the controller, the number of empty bytes of the memory, and the name of the file to be edited appear on the LCD display. If an incorrect file name has been entered, by using the "Bs" key, move the cursor to the incorrect character and correct the file name.

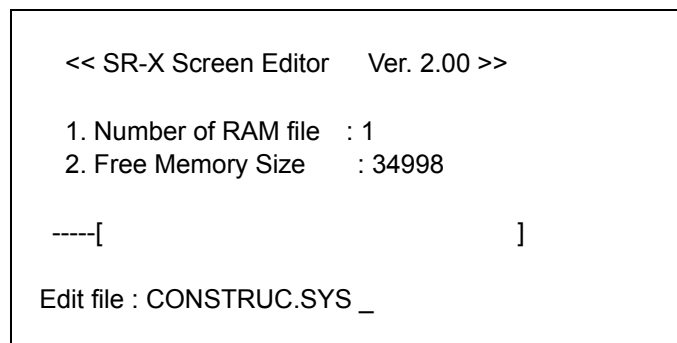

When the file name is correct, press the "Exec" key. The contents of the current file appear on the LCD display.

- (6) Change the contents of the file which appear on the LCD display. Using the screen editor, move the cursor to a character to be changed and conduct the edit operation. The cursor position is indicated with a character which blinks alternately in black and white or with a underline which simply blinks. The edit operation is conducted in the following methods.

- (a) Selecting the insert or replace mode:

The mode where characters being entered are inserted just before the cursor position is named the insert mode. In the insert mode, a character where the cursor is indicated with a blinking underline. The mode where old characters are replaced with those being entered is the replace mode. In the replace mode, the cursor is positioned blinks alternately in black and white.

The "Ins" key changes between the insert mode and replace mode.

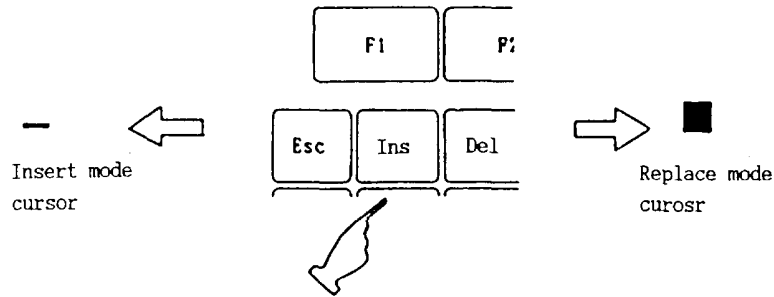

(b) Moving the cursor position:

Press the "←", "→", "↑", and "↓" keys to move the cursor where you want.

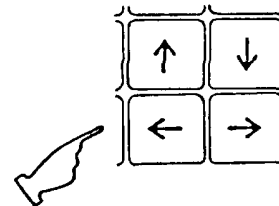

(c) Deleting a character using the "BS" key:

When you press the "Bs" key, the character just preceding the cursor is deleted. After the character is deleted, the cursor moves left one position. Each character following the cursor also moves left by one position.

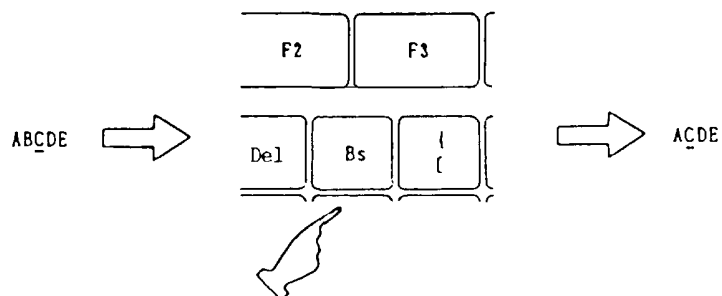

(d) Deleting a character using the "Del" key:

When you press the "Del" key, one character at the cursor is deleted. Each character following the character being deleted moves left by one position.

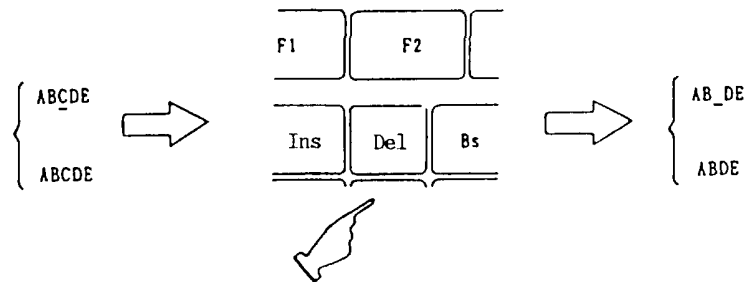

(e) Entering characters:

Enter characters using the alphanumeric keys on the teach pendant. To enter a character marked on the upper position of the key, press that key while also pressing the "Shift" key. To enter a character marked on the lower position of the key, simply press that key. At the end of each line, press the "Exec" key.

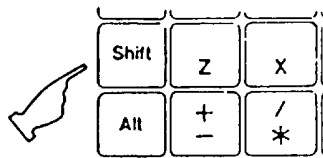

For other functions which are available in the screen editor, see the Operating Manual.

(7) Quitting the edit operation:

After editing the file, press the "X" key while pressing the "Alt" key.

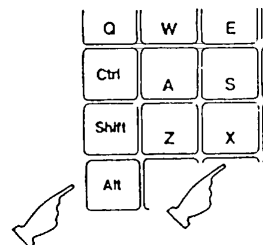

Note)

Before exiting the edit function, check that the edited data is correct.

- (8) Starting up the controller with the edited file. In order to validate (make effective) the changes, first turn off the main power and then hot start the controller.

Note 1)

Before changing the contents of a file, it is recommended to back up the file with a floppy disk. For details of how to back up a file, see 5.5, "Backing Up Files".

Note 2)

If the contents of the system configuration file were changed for the worse when they were edited, read the CONSTRUC. SYS file from the attached system disk of the controller and conduct the edit operation all over again. For details of how to load the file, see 5.5, "Backing Up Files".

### 3.3 SETTING THE SYSTEM CONFIGURATION

The configuration of the robot system has been set in the robot configuration file. Thus, it is not necessary for the user to change the system configuration. However, depending on the application of the robot system, the contents of the system configuration file may have to be changed. This paragraph describes the contents of the system configuration file. For details of how to set and change data, see 3.2, "Changing File Data".

#### **Caution**

DO NOT change the data of system configuration files (0) ~ (5) without our prior permission.

#### 3.3.1 Outline of Data

The following data has been set in the system configuration file.

(0) Robot type

Specifies whether the robot type is the horizontal rotating multi-joint type or the Cartesian coordinate system type.

(1) Robot axis configuration

Specifies which of the 6 joint axis of the robot are to be used.

(2) Type of joint

Specifies whether the joint type of the robot is a directly moving joint or rotating joint.

(3) Construction of servo

Specifies the number of axis which the servo motors to be used.

(4) Gravity compensated axis

Specifies the axes for which gravity compensation is to be performed. For an axis where gravity compensation is specified, in the servo free state, the arm is controlled so that it does not drop under its own weight. The servo free state is a state where the position control mechanism of the servo motor is turned off so that the robot can be manually moved. For a horizontal multi-joint robot, only axis 3 can be set as a gravity compensated axis.

(5) Motor revolving direction  
Specifies the basic direction in which the motor revolves (i.e., CW or CCW). SR-7000 can use only axis 1 to axis 4, and specify zero for axis 5 and axis 6.

(6) Not used (spare)

(7) Not used (spare)

(8) Not used (spare)

(9) Control method for external automatic mode

Specifies whether the system is to be controlled using I/O signals or data communication from a host computer.

(10) Not used (spare)

(11) File selection signal line

Specifies an external input signal to be used to select a file which is to be externally executed.

(12) Speed in low speed instruction mode

Sets a speed at which the robot works when a low speed instruction signal is input.

(13) Communication mode

Sets a communication channel mode used for data communication.

(14) Auxiliary signal line

Sets auxiliary signals used for hand and air control axes of the robot.

(15) Storage

Sets the use of a floppy disk unit or a substitute personal computer.

(16) Not used (spare)



### 3.3.2 File Format

The system configuration file is created in the following format.

```

SYSTEM CONSTRUCTION PARAMETER FILE      "CONSTRUC.SYS"

[0.] ROBOT SPECIFICATION      (C)

="SR-HS"

[1.] CONSTRUCTION OF MANIPULATOR.      {=0:WITHOUT,=1:WITH} (I)

=1 1 1 1 0 0

[2.] TYPE OF JOINT{=0:LINEAR.=1:ROTATE, 1ST JOINT TO 5TH}

=1 1 0 1 0 0

[3.] CONSTRUCTION OF SERVO.            {=0:WITHOUT,=1:WITH} (I)

=1 1 1 1 0 0

[4.] SPECIFY FOR GRAVITY COMPENSATION

           IN SERVO FREE MODE.      {=0:OFF,=1:ON} (I)

=0 0 1 0 0 0

[5.] NOT USE

=0 0 0 0 0 0

[6.] NOT USE

=0 0 0 0 0 0

[7.] NOT USE

=128

[8.] NOT USE

=255

```

[9.] SPECIFY FOR OPERATE MODE IN EXTERNAL AUTO.

{=0:EXT. SIGNAL, =1:COMPUTER} (I)

=0

[10.] NOT USE

=0

[11.] SPECIFY FOR EXTERNAL FILE SELECTION SIGNAL.

{1<=CH NO.<=24, 1<= LENGTH <=8} (I)

=17 8

[12.] SLOW SPEED RATE {0< RATE <100} (C) [%]

[13.] MODE OF SERIAL CHANNEL. {2ND CH. TO 5TH CH.}

{LOGICAL CHANNEL NAME = PRT | HOST | COM1 | COM2 | COM3 | COM4} (C)  
 {NO USE. SPARE} (I)  
 {PROTOCOL SELECTION  
 , =0:FREE RUN CONTROL,  
 , =1:SIMPLE PROTOCOL WITH SUM CHECK,  
 , =2:SIMPLE WITHOUT SUM CHECK, } (I)  
 {TRANSMIT SPEED =9600 | 4800 | 2400 | 1200} (I) [BPS]  
 {CHARACTER BIT = 7 | 8} (I)  
 {PARITY BIT =0:WITHOUT,=1:ODD,=2:EVEN} (I)  
 {STOP BIT =1 | 2} (I)

= "PRT" 0 0 1200 7 2 1 {MODE OF CHANNEL COM1}  
 = "COM1" 0 0 2400 7 2 2 {MODE OF CHANNEL COM2}  
 = "HOST" 0 1 2400 8 1 1 {MODE OF CHANNEL COM3}  
 = "COM2" 0 0 4800 7 2 1 {Not used}

## [14.] MODE OF AIR DRIVEN AXIS.

{SPECIFY FOR USE OR NOT USE.       =0:NOT USE,=1:USE}	(I)
{NO USE. SPARE.}	(I)
{TYPE OF VALVE =0:SINGLE SOLENOID, =1:DOUBLE SOLENOID}	(I)
{SPECIFY OF OPERATE CH. NO.}	(I)
{NO USE. SPARE.}	(I)

=1 0 0 208 0

=1 0 1 209 0

=1 0 1 211 0

=1 0 1 213 0

=0 0 0 0 0

=0 0 0 0 0

[15.] Option FD (0) &amp; External computer (1) flag (I)

=0

[16.] NOT USE

=0 0 0

Specify data on lines which start with "=". This type of line is called a data line. All other lines are comment lines. The controller interprets data in the order that the lines appear. The numbers in [ ] of the above example accord with data numbers as described in 3.3.1, "Outline of Data". Data types accord with data lines as follows.

Line No.	contents	Remarks
1	Robot type	
2	Robot axis configuration	For 6 axes
3	Type of joint	For 6 axes
4	Construction of servo	For 6 axes
5	Gravity compensation axis	For 6 axes
6	Motor revolving direction	For 6 axes
7	Not used	
8	Not used	
9	Not used	
10	Control method in external automatic mode	
11	Not used	
12	File selection signal line	
13	Speed in low speed instruction mode	0 ~ 100
14	Communication mode	Communication channel 1
15	Communication mode	Communication channel 2
16	Communication mode	Communication channel 3
17	Not used	
~23	Auxiliary signal line	For 6 points (1 point line)
24	Storage selection	
25	Not used	

For details of individual data, see the following paragraph.

### 3.3.3 Details of Data

This paragraph describes details of individual data of the system configuration file.

#### (0) Robot type

Specifies the robot type to be used.

For horizontally articulated types ... [= "SR-HS"]  
 For Cartesian coordinate system types ... [= "SR-L"]

#### (1) Robot axis configuration

Specifies which of the jointed axes 1 to 4 are to be used. The setting is to be changed when the number of axes of the robot is less than four, or when a servo motor is to be used outside of the robot. The data are to be specified for 4 axes separated with a space. To use an axis, set that axis to "1". To not use an axis, set that axis to "0".

Example)

When the Z axis is not used for a horizontally articulated type robot, set the data to [= 1 1 0 1].

Note 1)

Robot axes vary by robot type. For details of the robot axes, see the Transportation and Installation Manual.

Note 2)

This data should be set for all four axes.

#### (2) Type of joint

Specifies whether the joint type of the robot is a directly moving joint or rotating joint. The data are to be specified for 5 axes separated with a space. To use the linear moving axis, set that axis to "0." To use the rotating joint, set the axis to "1."

Example)

When axes 1, 2, and 4 use the rotating joint and axes 3 and 5 use the linear moving joint, set to [= 1 1 0 1 0].

## Note 1)

The number of joint axes depends on the robot type. For details, see the Transportation and Installation Manual.

## Note 2)

This data should be set for all five axes.

## (3) Construction of servo

Specifies axes for which servo motors are used. Each setting for five axes should be separated with a space. To use the servo motor for an axis, set that axis to "1"; to not use the servo motor for an axis, set that axis to "0".

## Example)

To use the servo motors for all five axes, set this data to [= 1 1 1 1 1].

## Note)

This data should be set for all the five axes.

## (4) Gravity compensated axis

Specifies an axis for which gravity compensation is performed. Each axis where gravity compensation is performed is controlled so that the arm does not drop by its own weight when the servo free state takes effect. In the servo free state, position control by the servo motor is turned off and the robot can be manually moved. Each data for five axes should be separated with a space. To perform gravity compensation for an axis, set that axis to "1". To not perform the gravity compensation for an axis, set that axis to "0".

## Example)

When performing the gravity compensation only for the axis Z (axis 3), set to [= 0 0 1 0 0].

Note 1)

This data should be set for all the five axes.

Note 2)

For a horizontally articulated robot, do not specify any axes other than the axis Z (axis 3) for gravity compensation.

- (5) Motor revolving direction  
Specifies to coincide the robot operating direction with the motor revolving direction.

Example)

When moving all axes in the CW direction, set [0 0 0 0 0].

Note 1)

The motor revolving direction differs with each motor.

Note 2)

This data should be set for all five axes.

- (6) Not used (spare)  
(7) Not used (spare)  
(8) Not used (spare)  
(9) Control method in external automatic mode

Specifies whether to use I/O signals or data from a host computer to control the robot in the external automatic mode. To use I/O signals, set to "0". To use data from a host computer, set to "1".

Example)

To use I/O signals for controlling the robot in the external automatic mode, this should be set to [=0].

- (10) Control of host computer communication protocol  
Specifies whether checksum should be included or not in the host computer communication mode.

Example)

Host computer communication, without procedure ... [= 0]

- (11) File selection signal line

Specifies an input signal to select a file to be executed from the outside of the controller using input signals. Specifies up to 8 consecutive signal points from among the 32 input signal points ranging from point 1 to point 32. Data should be specified by assigning the signal number of the beginning of the signal and the number of signal points.

Example)

To use the 8 signal points ranging from input signal point numbers 17 to 24, this line should be set to [= 17 8].

- (12) Speed in the low speed command

Specifies the speed at which the robot works when a low speed command signal is input. Specifies the percent of the maximum speed at which the robot is to move when a low speed command signal is input while in the automatic operation mode.

Example)

To specify 25% of the maximum speed, this data should be set to [= 25].

Note)

The speed should be specified with an integer in the range of 0 to 100.

- (13) Communication mode

Sets the modes of the communication channels to be used for data communication. Specifications should be made for communication channels 1 to 3. The communication channels 1 to 3 accord with the connectors J1 to J3 of the SR7000 controller. Set each channel in the following format.

[= (Name) (Spare) (Procedure)  
(Speed) (Character length) (Parity) (Stop bit length)]



**(Name)**

Specifies the name of device to be connected. The name of the device is specified with one of the following abbreviations. If it is not specified, the abbreviation of the communication channel is specified.

Printer	...	"PRT"
Host computer	...	"HOST"
Communication channel 1	(default) ...	"COM1"
Communication channel 2	...	"COM2"
Communication channel 3	...	"COM3"

The name "HOST" can be used only for one communication channel.

**(Spare)**

This data should be always set to "0".

**(Procedure)**

When "HOST" is specified for (name), specify the procedure used for data communication. For details, see the Communication Manual.

No procedure	...	0
Simple procedure (presence of check sum)	...	1
Simple procedure (absence of check sum)	...	2

Unless (name) is "HOST", data communication is done without any procedure.

**(Rate)**

Specifies the rate of data communication. Select one of the following rates.

9600 bps	...	9600
4800 bps	...	4800
2400 bps	...	2400
1200 bps	...	1200

**(Character length)**

Specifies the character length for communication.

8 bits	.8
7 bits	.7

(Parity)

Specifies whether to check the parity of each character to be communicated.

Absence of parity check	... 0
Odd parity	... 1
Even parity	... 2

(Stop bit length)

Specifies the stop bit length of each character to be communicated.

1 bit	... 1
2 bits	... 2

Data should be separated by commas and specified in sequence. The data of each channel should be specified on four lines in sequence.

Example)

Assume that communication channel 1 is to be used for a printer and communication channel 2 is to be used for the host computer.

```
[="PRT"    0 0 1200 8 0 1
 ="HOST"   0 1 2400 7 1 2
 ="COM3"   0 0 2400 8 1 2
 ="COM2"   0 0 4800 7 2 2]
```

In this example, communication channel 1 is set to "printer, no procedure, 1200 bps, 8 bit characters, no parity check, and 1 stop bit". Communication channel 2 is set to "host computer, simple procedure (presence of check sum), 2400 bps, 7 bit characters, odd parity, 2 stop bits". Communication channel 3 is not set to any port with no procedure, 2400 bps, 8 bit characters, odd parity, 2 stop bits". Communication channel 2 is not set to any port with 4800 bps, 7 bit characters, even parity, 2 stop bits".

Note 1)

Set all the four channels for the communication mode. (As channel 4 is unused, however, it should be set as the dummy.)

Note 2)

The communication channel 0 (COM0) is a channel dedicated for the teach pendant. The parameters for this channel cannot be changed.

## (14) Auxiliary signal line

The auxiliary signal line is used to specify auxiliary signals used for the hand and air control axes of the robot. Set the auxiliary signals for all six points. The parameters for each axis are to be set in the following format.

[= (Use/Not use) (Spare) (Solenoid) (Signal number) (Spare)]

(Use/Not use)

Specifies whether to use the control axis. Six data lines are assigned for auxiliary signal lines, and all of them should be specified as follows:

To not use the control axis, set to "0". To use the control axis, set to "1".

(Spare)

This should be always set to "0".

(Solenoid)

Specifies the type of a solenoid valve which drives the axis. When a double solenoid is used, two consecutive output signals are sent out exclusively.

Single solenoid	... 0
Double solenoid	... 1

(Signal number)

Specifies an auxiliary signal number to be used. Signals with a signal number in the range of 200 to 299 can be used for auxiliary signals. For details of output signal numbers, see the Interface Manual. When a double solenoid is used, specify the lower number of two consecutive output signal numbers.

(Spare)

This should be always set to "0". Each data should be separated with a space.

Example)

Assume that the auxiliary signal 209 is used for a single solenoid. Set this to [= 1 0 0 209 0].

Note 1)

All the auxiliary signal lines should be set for all six points.

Note 2)

The parameters of this data are effective only for auxiliary signals which are operated by the teach pendant. Even if a double solenoid is specified, signals are *not* exclusively output in the automatic operation mode. In this case, create a program so that the signals are exclusively output.

Note 3)

When the power is turned on, even if the double solenoid has been specified, the output signal is in the off state.

(15) Selection of storage

Selects either a floppy disk unit or a personal computer substituting for the floppy disk unit.

Example)

When the floppy disk unit is used, set [0].

(16) Not used (spare)

## 3.4 SETTING EXTERNAL SELECTION FILES

To select a file to be executed using external input signals, the name of the file should have first been registered in the external selection file (EXTRNSEL. SYS). This paragraph describes the contents of the external selection file. For details of how to create and change this file, see 3.2, "Changing File Data".

Note)

To select a file to be executed from outside of the controller, it is necessary to specify an input signal line to be used for selecting the file as well as creating the external selection file. For details of the system configuration file, see 3.3, "Setting System Configuration".

### 3.4.1 Signals Used for Selecting File

To select a file, use a signal having up to 8 consecutive signal points among 32 input signal points. Signals used to select a file are specified in the system configuration file. Change the data line corresponding to the file selection signal line in the system configuration file in accordance with the signals to be used.

Example)

When using the 6 points (extending from points 10 to 15) of an input signal, change the data line of the system configuration file as follows.

```
[9.]SPECIFY FOR EXTERNAL FILE SELECTION SIGNAL
                                     [1<=CH.NO. <=24,1<=LENGTH<=8]
= 10 6
```

To actually select a file, take the timing using a strobe signal and acknowledge signal. For details of the signal timing for selecting a file, see the Interface Manual.

Any signal used for selecting a file is read in as a file selection number. The file selection number is one digit numeric value in binary notation representing the conversion of the state of each input signal being specified. The smallest input signal number of the input signals being specified is treated as bit 0, and, in order, each bit corresponds with its input signal number. The ON and OFF states of each signal correspond with 1 and 0, respectively.

(Example)

File selection numbers when using 6 signal points (extending from signal points 10 to 15) are as follows:

Input signal						File selection number	
15	14	13	12	11	10	Binary	Decimal
OFF	OFF	OFF	OFF	OFF	OFF	000000	0
OFF	OFF	OFF	OFF	OFF	ON	000001	1
OFF	OFF	OFF	OFF	ON	OFF	000010	2
..	..	..	..	..	..	.....	.
OFF	ON	OFF	ON	OFF	ON	010101	21
..	..	..	..	..	..	.....	.
ON	OFF	ON	OFF	ON	OFF	101010	42
..	..	..	..	..	..	.....	.
ON	ON	ON	ON	ON	OFF	111110	62
ON	ON	ON	ON	ON	ON	111111	63

### 3.4.2 Contents of File

The names of files written in robot language are registered on one line at a time in the external selection file. Each file name corresponds with the file selection number, which is determined by subtracting a 1 from the number on which the file is registered. The file on line 1 accords with the file selection number 0; the file on line 2 accords with the file selection number 1; and so on. The number of characters per line should be 12 characters. For an example of how to create a robot language program file, see Chapter 4, "Example of Simple Operation"

For a detailed description, see the Operating Manual. For details on robot language, see the Robot Language Manual.

The following are examples of external selection files.

```

    000 MAIN0. SRC
    000 MAIN1. SRC
    000 MAIN2. SRC
    000 MAIN3. SRC
    000 MAIN4. SRC
    000 MAIN5. SRC
    000 MAIN6. SRC
    000 MAIN7. SRC
    ← 12 characters →

```

In the above example, when the file selection number is 0, the file MAIN0. SRC is selected; when it is 1, the file MAIN1. SRC is selected; and so on.

Note 1)

Files registered in the external selection file must be in the memory of the controller. Any file which is not in the controller memory cannot be selected.

Note 2)

When a file to be executed is selected externally, the file corresponding to the line of the external selection file is selected. Thus, be careful with the order of file names in the external selection file.

Note 3)

When registering file names in the external selection file, do not place a blank line between any file names.

Note 4)

If the file name to be registered consists of less than 12 characters, include a space or spaces before the file name to make the total number of characters 12. DO NOT enter a space or character at the 13th character and after.

## 3.5 BATCH PROCESSING

The SR7000 controller provides a function which sequentially executes a set of commands entered from the teach pendant. This function is named a batch processing. To conduct a batch processing, it is necessary to describe commands in the order of execution in a file. This type of file is named a batch file. When a batch file name is used like a command, commands listed in that batch file are executed in sequence.

### 3.5.1 Batch File

A file where commands are to be executed in a batch is called a batch file. The extension for all batch files should be ".BAT".

The following table lists commands available for batch processing. For details of how to use each command, see the Operating Manual.

Command name	Available mode	Function
LOAD	MANU , AUTO	Reads a file from a floppy disk.
SAVE	MANU	Writes a file to a floppy disk.
RESET	MANU , AUTO	Resets the execution environmental conditions of the controller.
COPY	MANU , AUTO	Copies a file.
DEL	MANU , AUTO	Deletes a file.
FORMAT	MANU	Formats a floppy disk.
CHANNEL	MANU , AUTO	Enables a communication channel.
DATE	MANU	Displays and sets date.
TIME	MANU	Displays and sets time.
REN	MANU	Changes the name of a file.
MODE	AUTO	Specifies automatic operation as the operation mode.
MSPEED	AUTO	Sets the speed override.
LSPEED	AUTO	Sets the speed limit.
SELECT	AUTO	Selects a file to be executed.
DO	AUTO	Directly executes a robot language command.



Note 1)

"AUTO" in the "Available mode" column represents the internal automatic mode, the external automatic mode, and the test operation mode. "MANU" represents the manual mode (all modes beside the automatic modes listed above).

Note 2)

When any command which is not effective in the current mode is used, an error occurs and the command will not be executed. In this case, any command where an error occurs is skipped and the remaining commands are executed in sequence.

Note 3)

When a batch processing is specified in another batch processing, the former batch processing is complete when the last command of the latter batch processing being called is complete.

Note 4)

In the automatic operation mode, batch processing cannot be executed.

Note 5)

Controller operation which are effective in a batch processing are as follows:

EMERGENCY STOP, SERVO ON, and SERVO OFF

Note 6)

Commands specified for batch processing are immediately processed without any prompt to the operator such as "Press Y key to delete the file".

In a batch file, commands of the controller should be listed in the order of the execution. For details of how to edit a file, see 3.2, "Changing File Data".

Any batch file is executed by entering its name (without the extension) from the teach pendant just like with any command.

Example)

An example of a batch processing which reads files from a floppy disk.

```
File name: FLOAD. BAT
LOADPRO1
LOADPRO2
LOADPRO3
LOADPRO4
LOADPROS
LOADPRO6
```

To execute the above batch file, enter the following from the teach pendant.

```
[F] [L] [O] [A] [D] [Exec]
```

When the batch processing is executed, the controller reads the file PRO1 to PRO6 from a floppy disk to the RAM drive in the controller.

Note 1)

In the external automatic mode, batch files cannot be executed from the teach pendant.

Note 2)

As opposed to selecting a program, batch files cannot be selected or executed using external input signals.

Note 3)

Unless a batch file is in the controller RAM drive, it cannot be executed.

### 3.5.2 Automatic Execution File

A batch file which is executed just after the controller power is turned on is called an automatic execution file. The contents of the automatic execution file are just like any other batch file, although the file name of the automatic execution file is AUTOSTR. BAT.

The automatic execution file can be used to select a file in the external automatic mode. For details of how to edit files, see 3.2, "Changing File Data".

Example)

To select a file which is to be executed just after the power is turned on in the external automatic mode:

```
File name: AUTOSTR.BAT
          SELECT PRO1
```

In order to execute the above automatic execution file, it must first have been stored in the RAM drive of the controller and the MASTER MODE KEY switch on the control panel must have been placed in either the "INT" or "EXT" position. In this situation, after the power of the controller is turned on and the hot start operation is complete, file PRO1 is selected as a file to be executed.

Note)

When the MASTER MODE KEY switch is in the "MANU" position, when the controller power is turned on, a program will not be selected because an execution of the SELECT command results in an error.

### 3.5.3 Using Batch Processing Effectively

Batch processing is effective for executing a predetermined process by pushing just a few keys. For example, when a process which reads files stored on a floppy disk to the controller is described as a batch file, all the required files can be read by just running the batch file.

Likewise, when replacing a file in the controller with another file to change system operation, a prepared batch file corresponding to the system change can be readily executed.

Example)

When reading files stored on a floppy disk into the controller after a cold start, the files to be read in and a batch file can be stored on the floppy disk in advance.

```
File name: ALOAD. BAT
LOADCONSTRUC .SYS
LOADSYSTEM. PAR
LOADUSER. PAR
LOAD*. PRO
```

## Procedure:

- (1) Start the controller using the cold start operation.
- (2) Insert the floppy disk containing the files into the FDD unit.
- (3) Read the batch file to the controller.

```
[C] [O] [P] [Y] [ ] [A] [:] [A] [L] [O] [A]
[D] [.] [B] [A] [T] [ ] [R] [:] [Exec]
```

- (4) Execute the batch file.

```
[A] [L] [O] [A] [D] [Exec]
```

After that, batch processing is executed, which causes the system configuration file (CONSTRUC. SYS), system parameter file (SYSTEM. PAR), user parameter file (USER. PAR), and any program files whose extension is ".PRO" to be read to the RAM drive of the controller.

## Note)

Save files on a floppy disk other than the system disk. To prevent the contents of the system disk from being accidentally altered, it is strongly recommended to place the write protect tab of the floppy disk in the write disable position.

## 3.6 PROGRAM EXECUTION ENVIRONMENT

### 3.6.1 Program Execution Environment

The following items are conditions for automatically operating a program.

① Execution file

A file for automatically operating the robot. Normally, this file is selected by using the "SELECT" command in the internal automatic mode.

In the external automatic mode, the execution file can be selected by using an external control signal.

② Execution step

A step for executing a program. Even if the automatic operation of the program is stopped, the program can be executed from the subsequent step.

③ Variables

Variables used in the program.

④ Digital output signals

Output signals for synchronously operating a robot language program and peripheral units.

Basically, the output signals are specified by the robot language program.

Once the signal is output, it is kept on until the off command is executed.

When the power is turned off, the signal is turned off. When the power is turned on, all the output signals are in the off state.

⑤ Auxiliary output signals

Signals for controlling an end effector such as a hand. Basically, the auxiliary output signals are specified by the robot language program.

Once the signal is output, it is kept on until the off command is executed.

When the power is turned off, the signal is turned off. When the power is turned on, all the output signals are in the off state.

## ⑥ Operation modes

There are three operation modes; step, cycle, and continue. The step operation mode can be selected only in the test operation mode. In the internal operation mode, the operation mode is selected by the "MODE" command or by the "CYCLE STOP" switch on the control panel. In the external automatic mode, the operation mode is selected by an external control signal.

## ⑦ Speed override (MSPEED)

The speed of the automatic operation is decreased in the entire program. The speed override is set by the "MSPEED" command in the internal automatic mode or in the test operation mode. Even if the mode is changed, the setting value is stored. When the power is turned on, the speed override is set to 100%.

## ⑧ Speed limit (LSPEED)

A speed limit in the automatic operation. The speed limit is set by the "LSPEED" command in the internal automatic mode or in the test operation mode. Even if the mode is changed, the setting value is stored. In the test operation mode, the speed limit is limited to 25%. In addition, with the low speed command signal, which is an external control signal, the speed limit is restricted to 25%. When the power is turned on, the speed limit is set to 100%.

## ⑨ Machine lock

A function for executing the automatic operation without operating the robot. The machine lock is available only in the test operation mode. It can be set by using the "MACHINE" command. When the power is turned on, the robot is not in the machine lock state.

## ⑩ Coordinate system

A coordinate system for operating the robot is set. For details, see 3.7, "SETTING COORDINATE SYSTEM."

Only ① to ③ above are stored as the program execution environmental data.

The coordinate system being set is not initialized even if the program is hot-started.

Other items are initialized when the program is hot-started.

### 3.6.2 Resetting Execution Environment

To reset the execution environmental data of the program, the "RESET" command can be used. The "RESET" command can be used in the manual mode or in the internal automatic mode. In the external automatic mode, an external control signal has the same function as the "RESET" command. For details of the external control signal, see "INTERFACE MANUAL."

To execute the "RESET" command, select "RESET" by using the function key, specify a desired data item by using the alphanumeric keys, and then press the "Exec" key. The following are reset types.

① Program reset (RESET PROG)

Initializes all execution environmental data of the program. The execution step of the program is placed at the beginning of the program. All variables are initialized.

② Step reset (RESET STEP)

Only the execution step of the program is placed at the beginning of the program. The variables are not initialized.

③ Cycle reset (RESET CYCLE)

The execution step of the program becomes a step with label "RCYCLE." The variables are not initialized.

④ Output signal reset (RESET SIG)

All digital output signals are turned off. The optional extension inputs/outputs are also turned off. The auxiliary signals are not turned off.

### 3.6.3 Reset Timing of Program Execution Environment

The program execution environmental data are reset under the following conditions.

- ① When the program is cold-started.
- ② When a file other than the present file is selected as the execution file.  
(When the same file as the present file is selected again, the program execution environment is not reset.)
- ③ When the program reset operation is executed.
- ④ When the program is hot-started. (No global variable is initialized, however.)

When the power is turned off before the automatic operation is completed, the global variable data may be lost.

To execute the program from the initial state, use the "RESET PROG" command.

To execute the program in the initial state when the power is turned on, specify the "RESET PROG" command for the automatic execution file (file name: AUTOSTR, BAT).



## 3.7 SETTING COORDINATE SYSTEM

A coordinate system can be set according to the application of the robot.

When the robot is guided to an actual operation position and the position is taught to the robot, it is not necessary to set a coordinate system.

When a coordinate system is set unintentionally, the teaching operation of the position becomes complicated. Unless otherwise required, it is recommended to operate the robot in the initial state without setting a coordinate system.

A coordinate system should be set in the following cases.

- ① To manually guide the robot along a coordinate system other than the base coordinate system.
- ② To represent an operation position by means of a relative position of a workpiece when the same operation is conducted for two or more workpieces.
- ③ To perform a linear interpolation/circular interpolation in accordance with the edge of the tool.
- ④ When the installation position of the robot is changed, to use the position data which was used in a previous operation.

### 3.7.1 Robot Coordinate Systems

The robot has five coordinate systems; world coordinate system, base coordinate system, work coordinate system, mechanical interface coordinate system, and tool coordinate system.

- ① World coordinate system (absolute coordinate system)

A coordinate system intrinsic to the operation place where the robot is installed. The world coordinate system can be set regardless of the robot. Generally, a coordinate system where the installation reference point of the robot is the zero point is selected (namely, the base coordinate system is selected).

- ② Base coordinate system (machine coordinate system)

A coordinate system intrinsic to the robot. This coordinate system is intrinsic to the structure of the robot. Generally, the installation reference point of the robot becomes the zero point.

③ Work coordinate system (operation coordinate system)

A coordinate system intrinsic to work for which the robot is operated. The zero point of the work coordinate system is set at the reference point of the work. It is also determined by the operation of the robot.

④ Mechanical interface coordinate system

A coordinate system in which the position of an end effector of the robot is set to the zero point. As the robot is moved, this coordinate system is accordingly moved.

⑤ Tool coordinate system

A coordinate system where the end of an end effector of the robot is set to the zero point. As the robot is moved, this coordinate system is accordingly moved.

The base coordinate system and the work coordinate system are set in accordance with the world coordinate system.

The tool coordinate system is set in accordance with the mechanical interface coordinate system.

(The base coordinate system and the mechanical interface coordinate system are determined only depending on the mechanism of the robot. The world coordinate system is relatively determined by setting the base coordinate system.)

In the initial state where the coordinate system has not been set, the world coordinate system and the work coordinate system accord with the base coordinate system, while the tool coordinate system accords with the mechanical interface coordinate system.

### 3.7.2 Teaching Coordinate Data

When setting and using a coordinate system, it is necessary to teach coordinate data for giving the coordinate system.

#### (1) Coordinate data

Coordinate data are data for giving a new coordinate system by means of an original coordinate system.

Coordinate data are structured as follows.

(Coordinate data name) = X, Y, Z, C

Coordinate data name : A name representing coordinate data with up to 10 characters starting with an alphanumeric character.

X, Y, Z : X, Y, and Z axis values of the zero position of the new coordinate system viewed from the original coordinate system (unit: mm).

C : Amount of rotation around axis Z between the new coordinate system and the original coordinate system (unit: deg).

The new coordinate system is that the original coordinate system is horizontally moved for axes X, Y, and Z and then the original coordinate system is rotated for C around the new axis Z.

#### (2) Teaching coordinate data

Like position data, coordinate data are taught to individual files. There are three teaching methods; ① numeric value input method, ② one-point teaching method and ③ two-point teaching method.

The coordinate data are taught in the following manner.

- a) Place the master key switch on the control panel in the "MANU" position.  
The monitor command of the controller is displayed at the bottom of the LCD of the teach pendant.

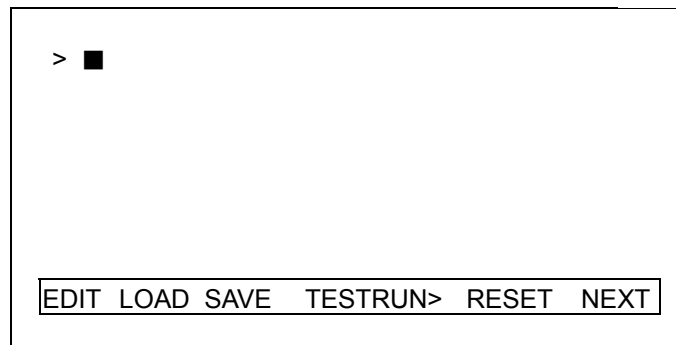
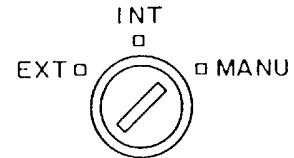

- b) By pressing the teach pendant [F6] key, the display of the monitor command is changed. Press the [F6] key until the [EDIT] command appears.
- c) Press the function key according to the [EDIT].
- d) Input the file name of coordinate data to be taught and then press the [Exec] key. At that time, the LCD displays the following screen.

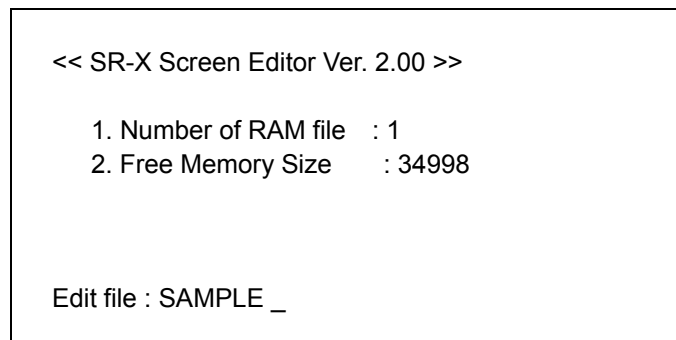

- e) When the file name at the bottom of the screen is correct, press the [Exec] key once again. If the file name is incorrect, press the [Bs] key to move the cursor to the field of the file name, correct the file name, and then press the [Exec] key. At that time, the LCD displays the program of the file. When a new file is specified, "new file is created" appears at the bottom of the screen.

```

PROGRAM SAMPLE
MOVE P1
MOVE P2
END
-
----[   SAMPLE   1   5   ]

```

- f) Press the [F1] key on the teach pendant. At that time, the system exits from the edit mode and enters the data editor mode. When position data have been taught to the file, the data are displayed. When the position data have not been taught to the file, "no data exist" is displayed.

```

----- POINT/World -----
-

```

No exist data

By pressing the [F1] key, the system returns back to the program edit mode.

- g) By pressing the [F4] key, the edit data are changed from the position data (POINT/World) to the coordinate data (TRANS) and the load data (PAYLOAD). At that time, select the coordinate data (TRANS). When the coordinate data have been taught to the file, the data are displayed. When the coordinate data have not been taught to the file, message "no exist data" is displayed.

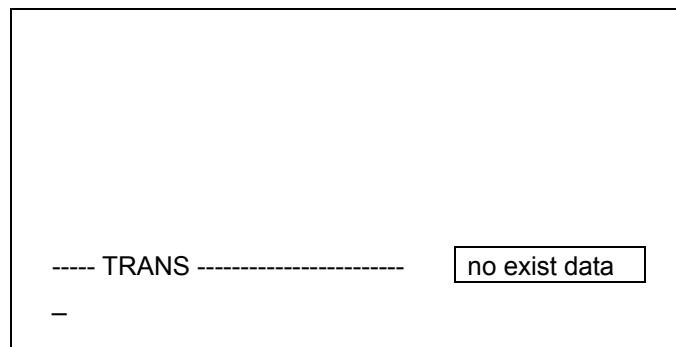

- h) Input a coordinate name to be taught. By using the alphanumeric keys, input a coordinate name to be taught. At that time, the coordinate name being taught is displayed at the bottom of the LCD display. To change the coordinate data which have been taught, by using the cursor keys [ ↑ ] and [ ↓ ], select the coordinate name of the coordinate data to be changed. When the coordinate name is selected by using the cursor keys, it is reversely indicated.
- i) Teach coordinate data
- ① In case the coordinate data are input with numeric values. Input values of axes X, Y, Z, and C following the coordinate name displayed at the bottom of the LCD display.

"TABLE 1 = 10, 20, 30, 45"  
 Coordinate name X Y Z C

Fields not entered are treated as 0.

To partially change data which has been taught, input "\*" for fields not to be changed.

Last, by pressing the [Exec] key, the coordinate data are stored.

② In the case of one-point/two-point teaching mode:

1) By pressing the [Exec] key, the screen is changed as follows.

Record mode of TRANS data

1 1-Point teaching  
2 2-Point teaching

----- TRANS -----  
Select teaching mode and type [Exec] Key

2) By using the cursor keys [↑] and [↓], select the desired teaching mode.

For the one-point teaching mode, select "1-Point teaching." For the two-point teaching mode, select "2-Point teaching."

i) In case of the one-point teaching mode:

----- TRANS -----  
TABLE1                      \*\* 1-Point teaching \*\*

Guide the end of the robot tool to the zero point of the coordinate system to be taught and match its orientation to that of the coordinate system to be taught. By pressing the [Exec] key, the coordinate data are stored.

ii) In case of the two-point teaching mode:

```

----- TRANS -----
TABLE1                ** 2-Point teach ** origin
  
```

Guide the end of the robot tool to the zero point of the coordinate system to be taught. By pressing the [Exec] key, the zero point of the coordinate system is stored. The system prompts the input of the direction of the axis X of the coordinate system to be taught.

```

----- TRANS -----
TABLE1                ** 2-Point teach ** X-dir
  
```

Guide the end of the robot tool to the position in the positive direction of the axis X of the coordinate system to be taught. By pressing the [Exec] key, the coordinate system is stored.

j) Specifying work coordinate system

To use the coordinate data being taught as the work coordinate system, it is necessary to specify the data as the work coordinate system. Data used for the tool coordinate system and the base coordinate system can be selected directly rather than specifying the coordinate system.

The work coordinate system is specified in the following manner.

- ① By using the cursor keys [ ↑ ] and [ ↓ ], select the coordinate system name of the coordinate data to be used as the work coordinate system. When the coordinate data are selected, they are reversely indicated.
- ② Press the [F5] key. [\*] is placed at the beginning of the coordinate system name specified for the work coordinate system.



TABLE1	=10.000,10.000,0.000,0.000
TABLE2	=20.000,20.000,0.000,0.000
* TABLE3	=30.000,30.000,0.000,0.000
TABLE4	=40.000,40.000,0.000,0.000
TABLE5	=50.000,50.000,0.000,0.000
----- TRANS -----	
Defined the new work : TABLE3	

k) Quitting teaching operation of coordinate data

By pressing the [F4] key, the edit data are changed from the coordinate data (TRANS) to the load data (PAYLOAD) and the position data (POINT/World). To subsequently teach other data, select the mode according to the data to be taught.

To exit to the program edit mode, press the [F1] key.

To quit the file edit mode, press the [X] key while the [Alt] key is held.

### 3.7.3 Selecting Coordinate System in Data Editor Mode

A coordinate system can be selected in the data editor mode. Before selecting each coordinate, it is necessary to enter the system in the data editor mode in accordance with the procedure described in 3.7.2 (2) a) to f).

(1) Selecting work coordinate system

Position data to be taught to the robot are stored as a coordinate value at the tool end in the work coordinate system. Thus, to teach the robot position, it is necessary to select the required coordinate system. In the initial state, the work coordinate system accords with the world coordinate system. In case the work coordinate system is not required, it is not necessary to select the work coordinate system. The coordinate data used for the work coordinate system should have been specified as the work coordinate system in advance. For details for specifying the work coordinate system, see 3.7.2 (2) j). The work coordinate system is selected in the following manner.

- a) Enter the system in the data editor mode in accordance with the procedure described in 3.7.2 (2) a) to f).

- b) When the edit data are not position data (POINT/World), press the [F4] key to change the edit data to the position data.

```

----- POINT/World -----
-

```

- c) Press the [F5] key  
At that time, the LCD displays the coordinate data specified as the work coordinate system.  
".system" represents the current setting value of the work coordinate system.

```

.system  (O)  0.000,0.000,0.000,0.000
.world   (O)  0.000,0.000,0.000,0.000
.base    (O)  0.000,0.000,0.000,0.000
TABLE3  (O)  30.000,30.000,0.000,0.000

----- Work Select -----
Current : .world

```

The value in parentheses following the coordinate name represents the number of position data records taught in the work coordinate system.

- d) By using the cursor keys [+1 and +], reversely indicate the coordinate data to be selected and then press the [Exec] key. At that time, the teaching screen of the position data for the work coordinate system being selected appears.  
When ".world" is selected, the work coordinate system accords with the world coordinate system.  
When ".base" is selected, the work coordinate system accords with the base coordinate system.  
When the position data taught in the selected work coordinate system is present, it is displayed.  
When the position data have not been taught in the selected work coordinate system, "no exist data" is displayed.

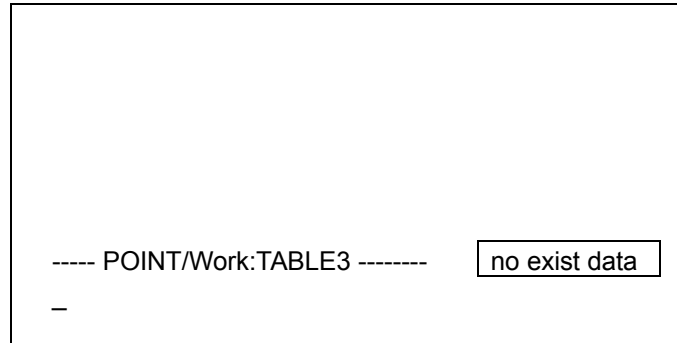

- e) Teach the position for the selected work coordinate system.  
When the position data are taught, they are stored in the specified position in the work coordinate system. The position data are taught in the following manner.
- ① By using the alphanumeric keys, input position data name to be taught. The input characters are displayed at the bottom of the LCD display.  
When position data have been taught, the position data name currently selected is displayed at the bottom of the LCD display.  
To teach a new position, press the [Esc] key and cancel the position name. After that, input a desired position data name.  
To change the position data which have been taught, by using the cursor keys [ ↑ ] and [ ↓ ], reversely indicate the position data name to be changed and then select it.
  - ② Teach the desired position.
- 1) In the case that the position data are input by numeric values:  
Input values of the axes X, Y, Z, C, T, and orientation following the position data name displayed at the bottom of the LCD display.

"POINT 1 = 10, 20, 30, 40, 0/LEFTY"  
Position data name X Y Z C T orientation

X,Y,Z,C,T : Coordinate values in work coordinate system.  
Orientation : Orientation of arm of horizontally articulated type robot  
"RIGHTY" : Right shoulder type  
"LEFTY" : Left shoulder type

Values omitted in the fields are treated as 0. When the orientation is omitted, the orientation at the position is not defined. To omit part of the data being taught, input "" for fields which are not changed.

Last, by pressing the [Exec] key, the coordinate data are stored.

- 2) In case the robot is guided for teaching coordinate data:  
Guide the robot to a position to be taught and press the [Exec] key so that the present robot position is stored.
- f) Stop the data editor

To return the system back to the program edit mode, press the [F1] key.  
To quit the file edit mode, press the [X] key while the [Alt] key is held.

## (2) Selecting tool coordinate system

To perform a linear interpolation or circular interpolation in accordance with the end of the end effector mounted on the robot, use the tool coordinate system. When the tool coordinate system has not been set, the robot position is calculated at the center of the flange surface of the tool shaft.

The tool coordinate system is selected in the following manner.

- a) Enter the system in the data editor mode in accordance with the procedure described in 3.7.2 (2) a) to f).
- b) By pressing the [F4] key, the edit data are changed from the position data (POINT/World) to the coordinate data (TRANS) and the load data (PAYLOAD). Select the coordinate data (TRANS). At that time, the coordinate data which have been taught are displayed.

TABLE1	=10.000,10.000,0.000,0.000
TABLE2	=20.000,20.000,0.000,0.000
TABLE3	=30.000,30.000,0.000,0.000
TABLE4	=40.000,40.000,0.000,0.000
TABLE5	=50.000,50.000,0.000,0.000
----- TRANS -----	
TABLE1	

- c) Press the [T] key while the [Alt] key is held. The tool coordinate system currently selected is displayed at the bottom of the LCD display.

<input type="text" value=".system"/>	=0.000,0.000,0.000,0.000
TABLE1	=10.000,10.000,0.000,0.000
TABLE2	=20.000,20.000,0.000,0.000
TABLE3	=30.000,30.000,0.000,0.000
TABLE4	=40.000,40.000,0.000,0.000
TABLE5	=50.000,50.000,0.000,0.000
----- TRANS/Tool Select -----	
Current : .system =0.000,0.000,0.000,0.000	

- d) By using the cursor keys [↑] and [↓], reversely indicate the coordinate name of the coordinate data to be selected and then press the [Exec] key. The coordinate data being selected are selected as the tool coordinate system and then the previous screen appears.

<input type="text" value="TABLE1"/>	=10.000,10.000,0.000,0.000
TABLE2	=20.000,20.000,0.000,0.000
TABLE3	=30.000,30.000,0.000,0.000
TABLE4	=40.000,40.000,0.000,0.000
TABLE5	=50.000,50.000,0.000,0.000
----- TRANS -----	
<input type="text" value="TABLE1"/>	

To not select the tool coordinate system, press the [Esc] key.

- e) Quit  
By pressing the [F4] key, the edit data are changed from the coordinate data (TRANS) to load data (PAYLOAD) and position data (POINT/World). To subsequently teach other data, select the desired mode according to the data to be taught.  
To return the system back to the program edit mode, press the [F1] key.

To quit the file edit mode, press the [X] key while the [Alt] key is held.

## (3) Selecting base coordinate system

The base coordinate system is determined just depending on the position where the robot is installed. To set a coordinate system other than the base coordinate system as the world coordinate system, it is necessary to select the base coordinate system viewed from the world coordinate system and then relatively set the world coordinate system. Since the world coordinate system is the basic coordinate system for operating the robot, once the coordinate system is set, do not unintentionally change the coordinate system.

When no data have been set, the base coordinate system accords to the world coordinate system. Normally, use the coordinate system as it is.

The base coordinate system is selected in the following manner.

- a) Enter the system in the data editor mode in accordance with the procedure described in 3.7.2 (2) a) to f).
- b) By pressing the [F4] key, the edit data are changed from the position data (POINT/World) to the coordinate data (TRANS) and the load data (PAYLOAD). Select the coordinate data (TRANS). At that time, the coordinate data which have been taught are displayed.

TABLE1	=10.000,10.000,0.000,0.000
TABLE2	=20.000,20.000,0.000,0.000
TABLE3	=30.000,30.000,0.000,0.000
TABLE4	=40.000,40.000,0.000,0.000
TABLE5	=50.000,50.000,0.000,0.000
----- TRANS -----	
TABLE1	

- c) Press the [B] key while the [Alt] key is held. At that time, the base coordinate system currently selected is displayed at the bottom of the LCD screen.

<input type="text" value=".system"/>	=0.000,0.000,0.000,0.000
TABLE1	=10.000,10.000,0.000,0.000
TABLE2	=20.000,20.000,0.000,0.000
TABLE3	=30.000,30.000,0.000,0.000
TABLE4	=40.000,40.000,0.000,0.000
TABLE5	=50.000,50.000,0.000,0.000
----- TRANS/Base Select -----	
Current : .system =0.000,0.000,0.000,0.000	

- d) By using the cursor keys [↑] and [↓], reversely indicate the coordinate name of the coordinate data to be selected and then press the [Exec] key. The coordinate data being selected are selected as the base coordinate system and then the former screen appears.

<input type="text" value="TABLE1"/>	=10.000,10.000,0.000,0.000
TABLE2	=20.000,20.000,0.000,0.000
TABLE3	=30.000,30.000,0.000,0.000
TABLE4	=40.000,40.000,0.000,0.000
TABLE5	=50.000,50.000,0.000,0.000
----- TRANS -----	
<input type="text" value="TABLE1"/>	

To not select the base coordinate system, press the [Esc] key.

- e) Quit

By pressing the [F4] key, the edit data are changed from the coordinate data (TRANS) to load data (PAYLOAD) and position data (POINT/World). To subsequently teach other data, select a desired mode in accordance with the data to be taught.

To return the system back to the program edit mode, press the [F1] key.

To quit the file edit mode, press the [X] key while the [Alt] key is held.

### 3.7.4 Selecting Coordinate System in Utility Mode

The work coordinate system and the tool coordinate system can be selected in the utility mode. However, coordinate data which can be selected as the coordinate system are those taught to a file.

The function for selecting the base coordinate system is not provided in the utility mode

#### (1) Selecting file

To select a coordinate system in the utility mode, a file where coordinate data have been taught should have been selected as an execution file.

To select the execution file, it is necessary to execute the "SELECT" command in the test operation mode or the internal automatic mode.

Once a file is selected as the execution file, even after the power is turned off, it is still selected. The execution file is lost under the following conditions.

- ① When the program is cold-started.
- ② When "RESET" is input by the "SELECT" command.

#### (2) Selecting work coordinate system

Coordinate data which can be selected as the work coordinate system should be specified as the work coordinate system. It is necessary to specify coordinate data to be used as the work coordinate system in accordance with 3.7.2 (2).

The work coordinate system is selected in the following manner.



- a) By pressing the [UTILITY] key on the teach pendant, the system enters the utility mode.

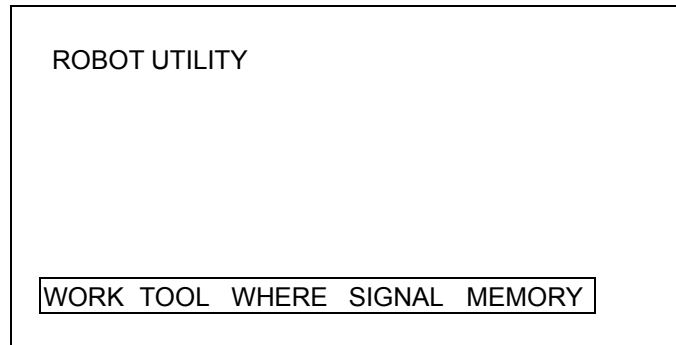

- b) Press the function key according to "WORK." At that time, data specified as the work coordinate system are displayed.

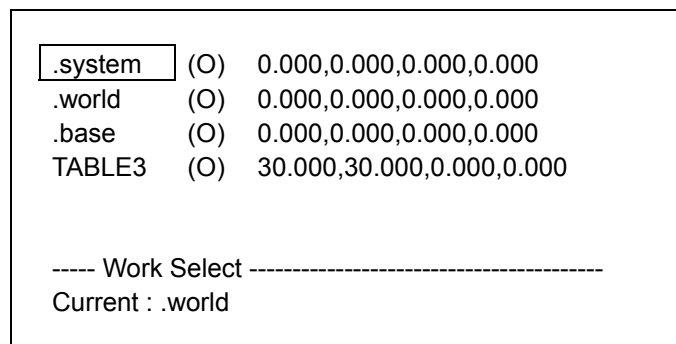

The value in parentheses following the coordinate name represents the number of position data records taught in the work coordinate system.

- c) By using the cursor keys [↑] and [↓], reversely indicate the coordinate name of the coordinate data to be selected and then press the [Exec] key. The coordinate data being selected are selected as the work coordinate system and then the utility mode screen appears.  
When ".world" and ".base" are selected, the work coordinate system accords with the world coordinate system and the base coordinate system, respectively. To not select the work coordinate system, press the [Esc] key.

- d) Quit the utility mode.

By pressing the [Esc] key, the system exists from the utility mode and then the previous screen appears.

- (3) Selecting tool coordinate system

The tool coordinate system is selected in the following manner

- a) By pressing the [UTILITY] key on the teach pendant, the system enters the utility mode and the utility mode screen appears.

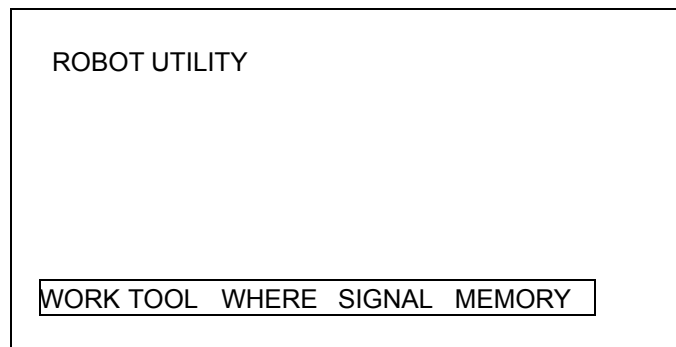

- b) Press the function key according to "TOOL."

At that time, the coordinate data which have been taught to the execution file are displayed.

<code>.system</code>	=0.000,0.000,0.000,0.000
TABLE1	=10.000,10.000,0.000,0.000
TABLE2	=20.000,20.000,0.000,0.000
TABLE3	=30.000,30.000,0.000,0.000
TABLE4	=40.000,40.000,0.000,0.000
TABLE5	=50.000,50.000,0.000,0.000
----- WORK Select -----	
Current : <code>.system</code>	=0.000,0.000,0.000,0.000

- c) By using the cursor keys [ ↑ ] and [ ↓ ], reversely indicate the coordinate name of the coordinate data to be selected and then press the [Exec] key. The coordinate data being selected are selected as the tool coordinate system and then the system returns back to the utility mode. At that time, the utility mode screen appears. To not select the tool coordinate system, press the [Esc] key.
- d) Quit the utility mode.  
By pressing the [Esc] key, the system exits from the utility mode and displays the previous screen.

### 3.7.5 Selecting Coordinate System Using Robot Language

The robot language is provided with three system variables "WORK," "BASE," and "TOOL" according to the work, base, and tool coordinate systems.

By substituting coordinate data into each system variable, the robot coordinate system can be changed.

For details of the robot language, see "ROBOT LANGUAGE MANUAL."

### 3.7.6 Timing of Changing Coordinate System

The timing of changing the coordinate system of the robot is as follows.

- ① When a coordinate system is selected in the data editor mode or the utility mode, the selected coordinate system becomes valid.
- ② When coordinate data are substituted into system variables TOOL and BASE in the robot language, after the existing operation is completed, the selected coordinate becomes valid (the short cut operation is cancelled).
- ③ When coordinate data are substituted into system variables TOOL and BASE by using WITH clause in the robot language, the coordinate system is selected before the existing operation is completed.
- ④ When coordinate data are substituted into system variable WORK in the robot language, the work coordinate system becomes valid upon execution of the operation command in the robot language.
- ⑤ When a file the same as the execution file is edited, the coordinate data which have been selected as the present system setting value are still selected.  
When a file different from the execution file is edited, the tool and base coordinate systems and the work coordinate system are initialized to [.SYSTEM] and [.WORLD], respectively.

- ⑥ When the program is either cold-started or hot-started, all coordinate systems are initialized.

## Free Manuals Download Website

<http://myh66.com>

<http://usermanuals.us>

<http://www.somanuals.com>

<http://www.4manuals.cc>

<http://www.manual-lib.com>

<http://www.404manual.com>

<http://www.luxmanual.com>

<http://aubethermostatmanual.com>

Golf course search by state

<http://golfingnear.com>

Email search by domain

<http://emailbydomain.com>

Auto manuals search

<http://auto.somanuals.com>

TV manuals search

<http://tv.somanuals.com>