

TP-LINK®

User Guide

H5R & H5E

AV500 Hybrid Wi-Fi Starter Kit

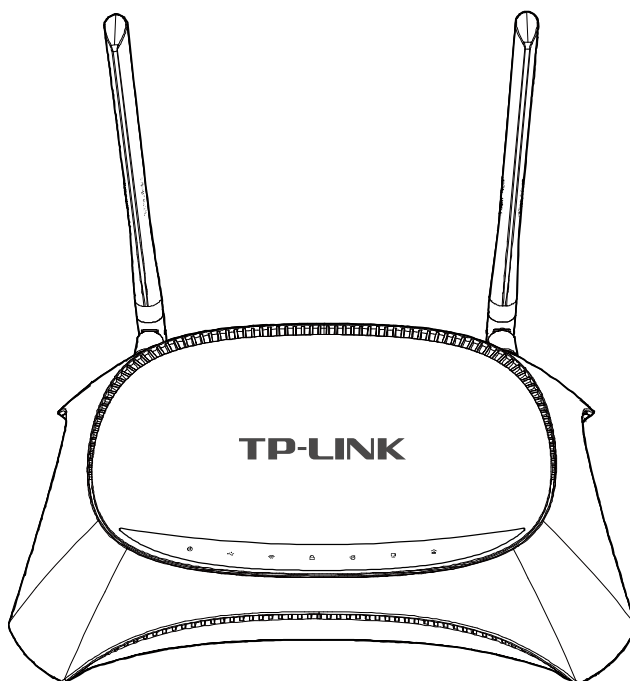

REV1.0.0
1910010938

COPYRIGHT & TRADEMARKS

Specifications are subject to change without notice. **TP-LINK**[®] is a registered trademark of TP-LINK TECHNOLOGIES CO., LTD. Other brands and product names are trademarks or registered trademarks of their respective holders.

No part of the specifications may be reproduced in any form or by any means or used to make any derivative such as translation, transformation, or adaptation without permission from TP-LINK TECHNOLOGIES CO., LTD. Copyright © 2013 TP-LINK TECHNOLOGIES CO., LTD. All rights reserved.

<http://www.tp-link.com>

FCC STATEMENT



This equipment has been tested and found to comply with the limits for a Class B digital device, pursuant to part 15 of the FCC Rules. These limits are designed to provide reasonable protection against harmful interference in a residential installation. This equipment generates, uses and can radiate radio frequency energy and, if not installed and used in accordance with the instructions, may cause harmful interference to radio communications. However, there is no guarantee that interference will not occur in a particular installation. If this equipment does cause harmful interference to radio or television reception, which can be determined by turning the equipment off and on, the user is encouraged to try to correct the interference by one or more of the following measures:

- Reorient or relocate the receiving antenna.
- Increase the separation between the equipment and receiver.
- Connect the equipment into an outlet on a circuit different from that to which the receiver is connected.
- Consult the dealer or an experienced radio/ TV technician for help.

This device complies with part 15 of the FCC Rules. Operation is subject to the following two conditions:

- 1) This device may not cause harmful interference.
- 2) This device must accept any interference received, including interference that may cause undesired operation.

Any changes or modifications not expressly approved by the party responsible for compliance could void the user's authority to operate the equipment.

Note: The manufacturer is not responsible for any radio or TV interference caused by unauthorized modifications to this equipment. Such modifications could void the user's authority to operate the equipment.

FCC RF Radiation Exposure Statement:

This equipment complies with FCC RF radiation exposure limits set forth for an uncontrolled environment. This device and its antenna must not be co-located or operating in conjunction with any other antenna or transmitter.

“To comply with FCC RF exposure compliance requirements, this grant is applicable to only Mobile Configurations. The antennas used for this transmitter must be installed to provide a separation distance of at least 20 cm from all persons and must not be co-located or operating in conjunction with any other antenna or transmitter.”

CE Mark Warning



This is a class B product. In a domestic environment, this product may cause radio interference, in which case the user may be required to take adequate measures.

National Restrictions

This device is intended for home and office use in all EU countries (and other countries following the EU directive 1999/5/EC) without any limitation except for the countries mentioned below:

Country	Restriction	Reason/remark
Bulgaria	None	General authorization required for outdoor use and public service
France	Outdoor use limited to 10 mW e.i.r.p. within the band 2454-2483.5 MHz	Military Radiolocation use. Refarming of the 2.4 GHz band has been ongoing in recent years to allow current relaxed regulation. Full implementation planned 2012
Italy	None	If used outside of own premises, general authorization is required
Luxembourg	None	General authorization required for network and service supply(not for spectrum)
Norway	Implemented	This subsection does not apply for the geographical area within a radius of 20 km from the centre of Ny-Ålesund
Russian Federation	None	Only for indoor applications

Note: Please don't use the product outdoors in France.

Canadian Compliance Statement

This device complies with Industry Canada license-exempt RSS standard(s). Operation is subject to the following two conditions:

- (1) This device may not cause interference, and
- (2) This device must accept any interference, including interference that may cause undesired operation of the device.

Cet appareil est conforme aux norms CNR exemptes de licence d'Industrie Canada. Le fonctionnement est soumis aux deux conditions suivantes:

(1) cet appareil ne doit pas provoquer d'interférences et

(2) cet appareil doit accepter toute interférence, y compris celles susceptibles de provoquer un fonctionnement non souhaité de l'appareil.

This device has been designed to operate with the antennas listed in Appendix C. Antennas not included in this list or having a greater gain are strictly prohibited for use with this device. The required antenna impedance is 50 ohms.

To reduce potential radio interference to other users, the antenna type and its gain should be so chosen that the equivalent isotropically radiated power (e.i.r.p.) is not more than that permitted for successful communication.

Industry Canada Statement

Complies with the Canadian ICES-003 Class B specifications.

Cet appareil numérique de la classe B est conforme à la norme NMB-003 du Canada.

This device complies with RSS 210 of Industry Canada. This Class B device meets all the requirements of the Canadian interference-causing equipment regulations.

Cet appareil numérique de la Classe B respecte toutes les exigences du Règlement sur le matériel brouilleur du Canada.

Korea Warning Statements

당해 무선설비는 운용중 전파혼신 가능성이 있음.

NCC Notice & BSMI Notice

注意!

依據 低功率電波輻射性電機管理辦法

第十二條 經型式認證合格之低功率射頻電機，非經許可，公司、商號或使用者均不得擅自變更頻率、加大功率或變更原設計之特性或功能。

第十四條 低功率射頻電機之使用不得影響飛航安全及干擾合法通行；經發現有干擾現象時，應立即停用，並改善至無干擾時方得繼續使用。前項合法通信，指依電信規定作業之無線電信。低功率射頻電機需忍受合法通信或工業、科學以及醫療用電波輻射性電機設備之干擾。

安全諮詢及注意事項

- 請使用原裝電源供應器或只能按照本產品注明的電源類型使用本產品。
- 清潔本產品之前請先拔掉電源線。請勿使用液體、噴霧清潔劑或濕布進行清潔。
- 注意防潮，請勿將水或其他液體潑灑到本產品上。
- 插槽與開口供通風使用，以確保本產品的操作可靠並防止過熱，請勿堵塞或覆蓋開口。
- 請勿將本產品置放於靠近熱源的地方。除非有正常的通風，否則不可放在密閉位置中。
- 請不要私自打開機殼，不要嘗試自行維修本產品，請由授權的專業人士進行此項工作。



Продукт сертифіковано згідно с правилами системи УкрСЕПРО на відповідність вимогам нормативних документів та вимогам, що передбачені чинними законодавчими актами України.



Safety Information

- When product has power button, the power button is one of the way to shut off the product; when there is no power button, the only way to completely shut off power is to disconnect the product or the power adapter from the power source.
- Don't disassemble the product, or make repairs yourself. You run the risk of electric shock and voiding the limited warranty. If you need service, please contact us.
- Avoid water and wet locations.

This product can be used in the following countries:

AT	BG	BY	CA	CZ	DE	DK	EE
ES	FI	FR	GB	GR	HU	IE	IT
LT	LV	MT	NL	NO	PL	PT	RO
RU	SE	SK	TR	UA			

DECLARATION OF CONFORMITY

For the following equipment:

Product Description: **AV500 Hybrid Wi-Fi Starter Kit**

Model No.: **H5R & H5E**

Trademark: **TP-LINK**

We declare under our own responsibility that the above products satisfy all the technical regulations applicable to the product within the scope of Council Directives:

Directives 1999/5/EC, Directives 2004/108/EC, Directives 2006/95/EC, Directives 1999/519/EC, Directives 2011/65/EU

The above product is in conformity with the following standards or other normative documents

ETSI EN 300 328 V1.7.1: 2006

ETSI EN 301 489-1 V1.9.2:2011& ETSI EN 301 489-17 V2.2.1:2012

EN 55022:2010

EN 55024:2010

EN 61000-3-2:2006+A1:2009+A2:2009

EN 61000-3-3:2008

EN 60950-1:2006+A11: 2009+A1:2010+A12:2011

EN 62311:2008

EN 301 893

EN 302 502

The product carries the CE Mark:

CE 1588 

Person responsible for making this declaration:



Yang Hongliang
Product Manager of International Business

Date of issue: 2013

CONTENTS

Package Contents	1
Chapter 1. Introduction	2
1.1 Product Overview	2
1.2 Conventions	2
1.3 Main Features	2
1.3.1 H5R	2
1.3.2 H5E	3
1.4 Panel Layout	4
1.4.1 H5R	4
1.4.2 H5E	7
Chapter 2. Hardware Connection	9
2.1 System Requirements	9
2.2 Installation Environment Requirements	9
2.3 Connecting Hardware.....	9
Chapter 3. Quick Installation Guide	11
3.1 TCP/IP Configuration	11
3.2 Quick Installation Guide	12
3.2.1 Configure the Router	12
3.2.2 Unify and Extend Wi-Fi Network via AP Clone	21
Chapter 4. Configuring the Router	23
4.1 Login	23
4.2 Status	23
4.3 Quick Setup.....	24
4.4 Network	25
4.4.1 WAN	25
4.4.2 LAN	33
4.4.3 MAC Clone	34
4.5 Dual Band Selection.....	35
4.6 Wireless 2.4GHz	36
4.6.1 Wireless Settings.....	36
4.6.2 WPS	38
4.6.3 Wireless Security.....	40

4.6.4	Wireless MAC Filtering	43
4.6.5	Wireless Advanced	45
4.6.6	Wireless Statistics.....	47
4.7	Wireless 5GHz	48
4.7.1	Wireless Settings.....	48
4.7.2	WPS	49
4.7.3	Wireless Security.....	52
4.7.4	Wireless MAC Filtering	55
4.7.5	Wireless Advanced	57
4.7.6	Wireless Statistics.....	58
4.8	Powerline	59
4.8.1	Network Settings	59
4.8.2	Station Settings.....	60
4.8.3	QoS Setting	61
4.9	Extender List	63
4.10	DHCP	64
4.10.1	DHCP Settings	64
4.10.2	DHCP Clients List.....	65
4.10.3	Address Reservation	66
4.11	USB Settings.....	67
4.11.1	Storage Sharing.....	67
4.11.2	FTP Server	69
4.11.3	Media Server	71
4.11.4	Print Server.....	73
4.11.5	User Accounts	73
4.12	NAT	75
4.13	Forwarding	75
4.13.1	Virtual Servers	75
4.13.2	Port Triggering.....	77
4.13.3	DMZ.....	79
4.13.4	UPnP	80
4.14	Security	81
4.14.1	Basic Security.....	81
4.14.2	Advanced Security.....	83
4.14.3	Local Management	84
4.14.4	Remote Management	85

4.15 Parental Control	86
4.16 Access Control	89
4.16.1 Rule	89
4.16.2 Host	94
4.16.3 Target.....	96
4.16.4 Schedule.....	98
4.17 Advanced Routing.....	100
4.17.1 Static Routing List.....	100
4.17.2 System Routing Table.....	101
4.18 Bandwidth Control.....	102
4.18.1 Control Settings.....	102
4.18.2 Rules List.....	103
4.19 IP & MAC Binding Setting	104
4.19.1 Binding Settings.....	104
4.19.2 ARP List.....	105
4.20 Dynamic DNS.....	106
4.20.1 Comexe DDNS	106
4.20.2 Dyndns DDNS	107
4.20.3 No-IP DDNS	108
4.21 System Tools.....	109
4.21.1 Time Setting.....	110
4.21.2 Diagnostic.....	111
4.21.3 Firmware Upgrade.....	113
4.21.4 Factory Defaults	114
4.21.5 Backup & Restore.....	115
4.21.6 Reboot.....	115
4.21.7 Password.....	116
4.21.8 System Log.....	116
4.21.9 Statistics	118
Chapter 5. Configuring the Extender.....	121
5.1 Login	121
5.2 Status	121
5.3 Network.....	122
5.3.1 LAN	122
5.4 Wireless	123

5.4.1	Wireless Statistics.....	123
5.5	Powerline	124
5.5.1	Network Settings	124
5.5.2	Station Settings.....	125
5.6	System Tools.....	126
5.6.1	Firmware Upgrade.....	126
5.6.2	Factory Defaults	127
5.6.3	Backup & Restore.....	128
5.6.4	Reboot.....	129
5.6.5	Password.....	129
5.6.6	System Log.....	130
Appendix A:	FAQ	131
Appendix B:	Configuring the PCs.....	136
Appendix C:	Specifications	139
Appendix D:	Glossary	141

Package Contents

The following items should be found in your package:

- One H5R (AV500 Hybrid Wi-Fi Dual Band Router)
- One H5E (AV500 Hybrid Wi-Fi Extender)
- One power adapter for the H5R
- Two Ethernet cables
- One Quick Installation Guide
- Resource CD, including:
 - This User Guide
 - Management Utility
 - Other helpful information

 **Note:**

Make sure that the package contains the above items. If any of the listed items are damaged or missing, please contact your distributor.

Chapter 1. Introduction

Thank you for choosing the H5R & H5E AV500 Hybrid Wi-Fi Starter Kit.

1.1 Product Overview

The H5R & H5E AV500 Hybrid Wi-Fi Starter Kit is designed to meet wireless Internet access needs of SOHO (Small Office/Home Office) users, concentrating on solving the wireless signal coverage problem.

The H5R integrates the functions of powerline adapter and wireless router. Based on IEEE 802.11n, the H5R supports up to 300Mbps (2.4GHz) + 300Mbps (5GHz) wireless connection with other wireless clients. It is compatible with IEEE 802.11g and IEEE 802.11b products when using the 2.4GHz band and compatible with IEEE 802.11a products when using the 5GHz band. Apart from its practical functions and superior performance, the H5R is easy to manage and provides multiple protection measures to effectively ensure the security of wireless Internet access.

The H5E integrates the functions of powerline adapter and wireless AP (access point). Adopting the mainstream Homeplug AV standard, it can be plugged into any wall socket and works with the H5R to transmit data over the existing electrical wiring (powerline network) in users' houses at a rate of 500Mbps. At the same time, it can also extend the H5R's 2.4GHz wireless network to provide wireless access for more devices.

The H5R and H5E can form a network only after AP clone is completed between them. AP clone ensures network security, and it can be established easily by using the AP CLONE/PAIR button. After AP clone is completed, the H5E will automatically synchronize 2.4GHz wireless settings with the H5R.

1.2 Conventions

The router or H5R mentioned in this guide stands for AV500 Hybrid Wi-Fi Dual Band Router while the extender or H5E stands for AV500 Hybrid Wi-Fi Extender without any explanation.

1.3 Main Features

1.3.1 H5R

- Complies with IEEE 802.11n to provide a wireless data rate of up to 300Mbps (2.4GHz) + 300Mbps (5GHz).
- Complies with HomePlug AV to provide a powerline data rate of up to 500Mbps within the transmission distance (under the same electric meter) of 300 meters.

- Provides one 10/100/1000M Auto-Negotiation RJ45 Internet port, four 10/100/1000M Auto-Negotiation RJ45 Ethernet ports, supporting Auto MDI/MDIX.
- Provides a USB port supporting storage/FTP/Media/Print Server.
- Supports AP clone.
- Supports WPA/WPA2, WPA-PSK/WPA2-PSK authentication, TKIP/AES encryption security.
- Shares data and Internet access for users, supporting Dynamic IP/Static IP/PPPoE Internet access.
- Works in 2.4GHz or 5GHz radio bands, doubling your network capability.
- Supports Virtual Server, Special Application and DMZ host.
- Supports UPnP, Dynamic DNS, Static Routing.
- Provides Automatic-connection and Scheduled Connection on certain time to the Internet.
- Provides built-in NAT and DHCP server supporting static IP address distributing.
- Supports Parental Control and Access Control.
- Connects Internet on demand and disconnects from the Internet when idle for PPPoE.
- Provides 64/128-bit WEP encryption security and wireless LAN ACL (Access Control List).
- Supports Flow Statistics.
- Supports firmware upgrade and Web management.

1.3.2 H5E

- Complies with IEEE 802.11n to provide a wireless data rate of up to 300Mbps and supports automatic adjusting of the wireless data rate.
- Complies with HomePlug AV to provide a powerline data rate of up to 500Mbps within the transmission distance (under the same electric meter) of 300 meters.
- Provides two 10/100M Ethernet ports for wired connection of devices.
- Supports AP clone.
- Supports 128-bit AES encryption to ensure data transmission security.
- Supports firmware upgrade and Web management.
- Works at voltage range 100V–240V and frequency 50/60Hz.

1.4 Panel Layout

1.4.1 H5R

➤ Front panel

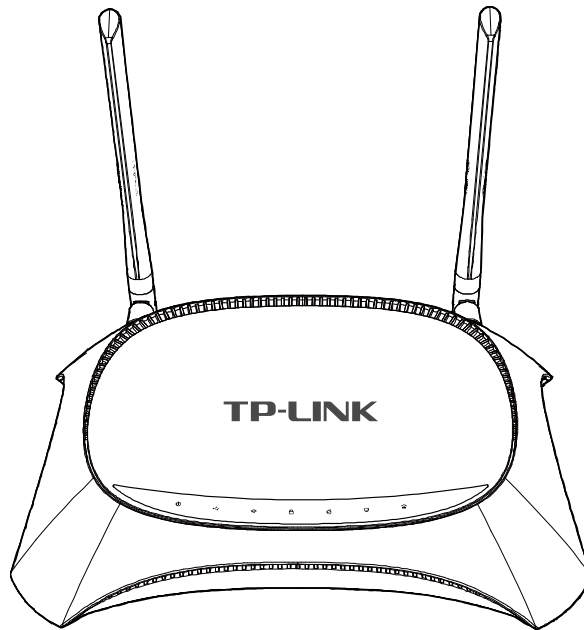





Figure 1-1 Front panel

Seven LEDs are located on the router's front panel.

LED	Status	Description
 (Power)	Off	The router is off.
	On	The router is on or has completed AP clone.
	Blink	The router is performing AP clone.
 (USB)	Off	No storage device or printer is plugged into the USB port.
	On	A storage device or printer is connected to the USB port.
 (Wireless)	Off	The wireless function is disabled.
	On	The wireless function is enabled.
 (WPS)	Off	The WPS process hasn't been started or has been stopped.
	Blink Slowly	A wireless device is connecting to the network using the WPS function.
	On	A wireless device has been successfully added to the network using the WPS function.
	Blink Quickly	A wireless device failed to be added to the network using the WPS function.



 (WAN)	Off	The WAN port is not connected.
	On	The WAN port is connected.
	Blink	The WAN port is transferring data.
 (LAN)	Off	No LAN port is connected.
	On	At least one LAN port is connected.
 (Powerline)	Off	The router hasn't formed a powerline network.
	On	The router has formed a powerline network.
	Blink	The powerline network is transferring data.

Table 1-1 LED description

 **Note:**

- 1) After a device is successfully added to the network by WPS function, the WPS LED will keep on for about 5 minutes and then turn off.
- 2) You can stop the WPS process as follows:
 - If you start the WPS process on the “**Wireless 2.4GHz** → **WPS** → **Add a New Device**” or “**Wireless 5GHz** → **WPS** → **Add a New Device**” page, you can click **Stop** on the current page to stop the process.
 - If you start the WPS process by pressing the router's Reset/WPS button, you need to click **Stop** on both pages.

The WPS LED turns off after you stop the WPS process.

- 3) The router is set to working concurrently in 2.4GHz and 5GHz by default. If you desire to choose the working frequency, please refer to [4.5 Dual Band Selection](#).

➤ **Rear panel**

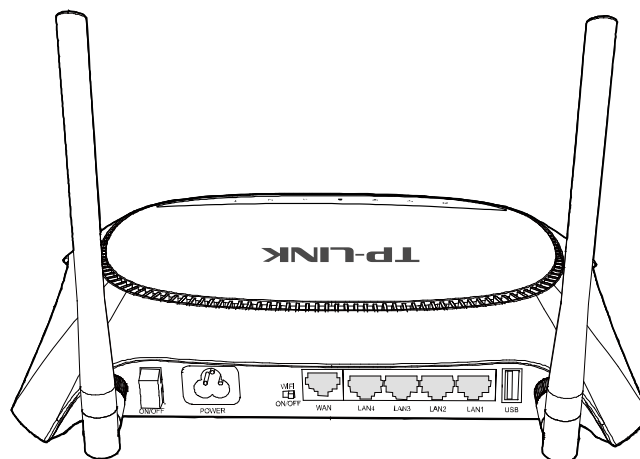

Figure 1-2 Rear panel

The following parts are located on the router's front panel.

Part	Description
Wireless antennas	Use these antennas to receive and transmit wireless data.
ON/OFF switch	Use this switch to power on/off the router.
Power socket	Use this socket to connect the power adapter that is provided with the router.
WIFI ON/OFF switch	Use this switch to enable or disable the wireless function.
WAN port (Internet port)	Use this port to connect the DSL/cable modem or Ethernet.
LAN ports (Ethernet ports)	Use these ports to connect local PC(s) to the router.
USB port	Use this port to connect a USB storage device or USB printer.

Table 1-2 Part description

➤ **Side panel**

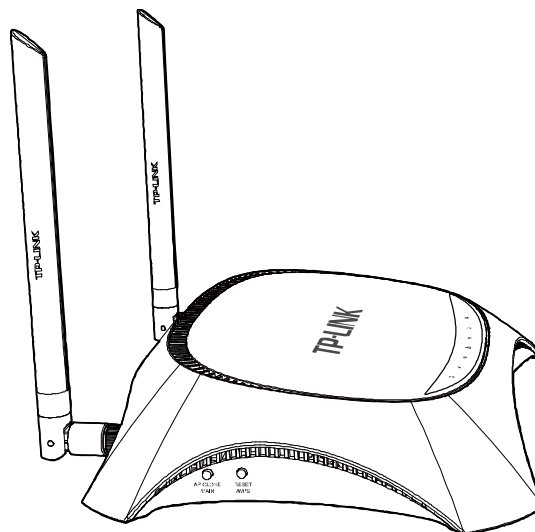

Figure 1-3 Side panel

Two buttons are located on the router's side panel.

Button	Description
AP CLONE /PAIR	Use this button to perform AP clone. For details, please refer to 3.2.2 Unify and Extend the Network via AP Clone .
RESET/WPS	Press this button for less than 5 seconds to enable the WPS function. If your client device such as wireless adapter supports WPS (Wi-Fi Protected Setup), use this button to automatically establish a WPA secure connection between the client device and the router. Press this button for more than 10 seconds to restore the router to factory defaults.

Table 1-3 Button description

1.4.2 H5E

➤ Front panel

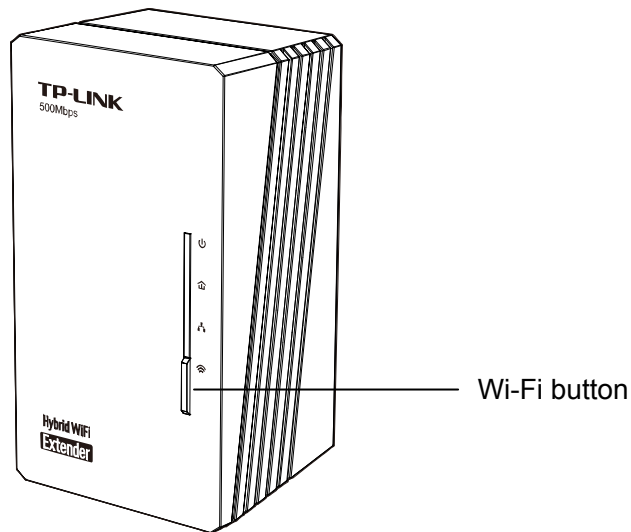

Figure 1-4 Front panel

Four LEDs and one button are located on the extender’s front panel.





LED	Status	Description
 (Power)	Off	The extender is off.
	Blink Quickly	The extender is performing AP clone with the AP CLONE/PAIR button pressed.
	Blink Slowly	The extender is performing AP clone without the AP CLONE/PAIR button pressed. The extender failed to perform AP clone.
	On	The extender is on or has completed AP clone.
 (Powerline)	On	The extender is connected to a powerline network.
	Off	The extender isn't connected to any powerline network.
	Blink	The extender is transferring data.
 (Ethernet)	On	At least one Ethernet port is connected.
	Off	No Ethernet port is connected.
 (Wireless)	Off	The wireless function is disabled.
	Blink	The wireless function is enabled.

Table 1-4 LED description

Button	Description
Wi-Fi button	Press this button for 5 seconds to enable or disable the wireless function.

Table 1-5 Button description

➤ Bottom panel

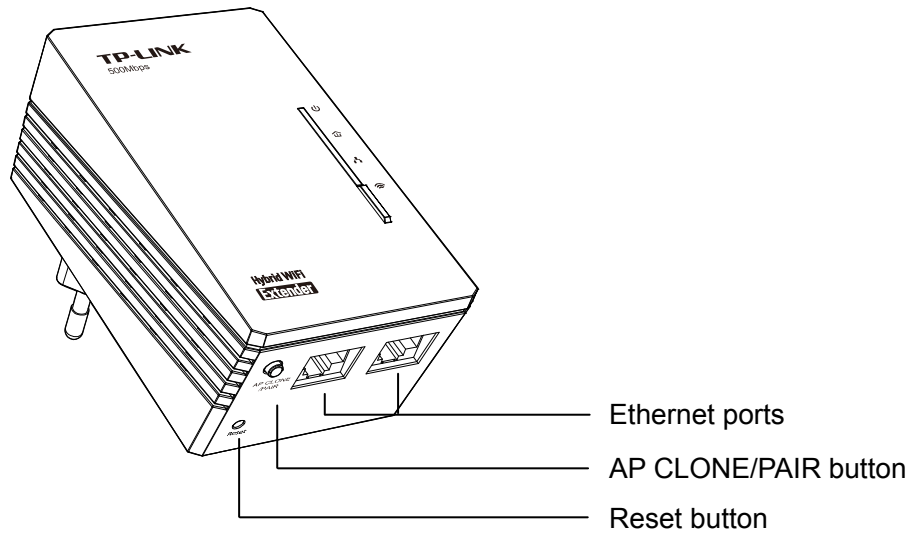

Figure 1-5 Bottom panel

The following parts are located on the extender's bottom panel.

Part	Description
AP CLONE /PAIR button	Use this button to perform AP clone. For details, please refer to 3.2.2 Unify and Extend the Network via AP Clone . Press this button for more than 10 seconds to make the extender leave the powerline network.
Reset button	Press this button for more than 10 seconds to restore the extender to factory defaults.
Ethernet ports	Use these ports to connect local PC(s) to the extender.

Table 1-6 Part description

Chapter 2. Hardware Connection

2.1 System Requirements

- Broadband Internet access service (DSL/Cable/Ethernet)
- One DSL/cable modem that has an RJ45 connector (which is not necessary if the router is connected directly to the Ethernet)
- PCs with a working Ethernet adapter and an Ethernet cable with RJ45 connectors
- TCP/IP protocol on each PC
- Web browser, such as Microsoft Internet Explorer, Mozilla Firefox or Apple Safari

2.2 Installation Environment Requirements

- Place the router in a well ventilated place far from any heater or heating vent
- Avoid direct irradiation of any strong light (such as sunlight)
- Keep at least 2 inches (5 cm) of clear space around the router
- Operating Temperature: 0°C~40°C (32°F~104°F)
- Operating Humidity: 10%~90%RH, Non-condensing

2.3 Connecting Hardware

Before connecting the router and extender, make sure your PC is connected to the Internet through the broadband service successfully. If there is any problem, please contact your ISP. After that, please connect the router and extender according to the following steps. Don't forget to pull out the power plug and keep your hands dry.

1. Connect the WAN port of the router to the Internet with an Ethernet cable.
2. Connect a LAN port of the router to your computer with another Ethernet cable.
3. Connect the power socket of the router to a wall socket with the supplied power adapter.
4. Plug the extender into a nearby wall socket.
5. Turn on the ON/OFF switch to power on the router and wait for 1 minute.

 **Note:**

- 1) The router and extender must be plugged into wall sockets under the same electric meter.
- 2) Configure the router before performing AP clone.

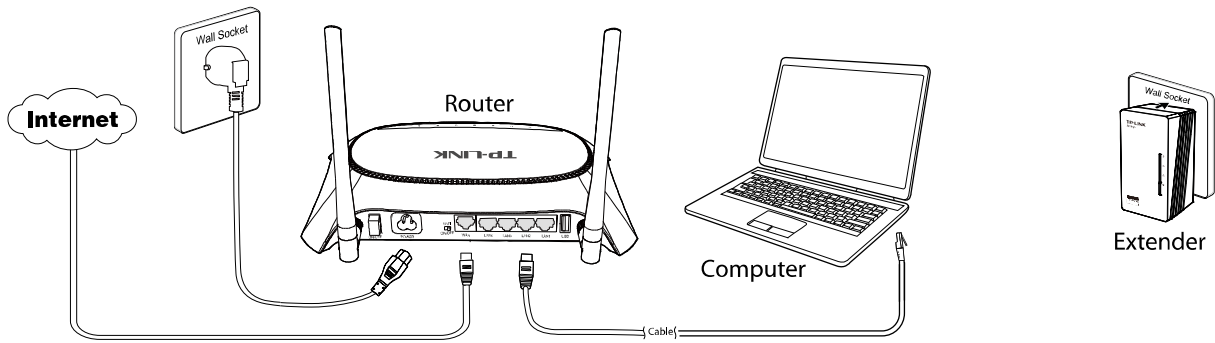

Figure 2-1 Hardware connection

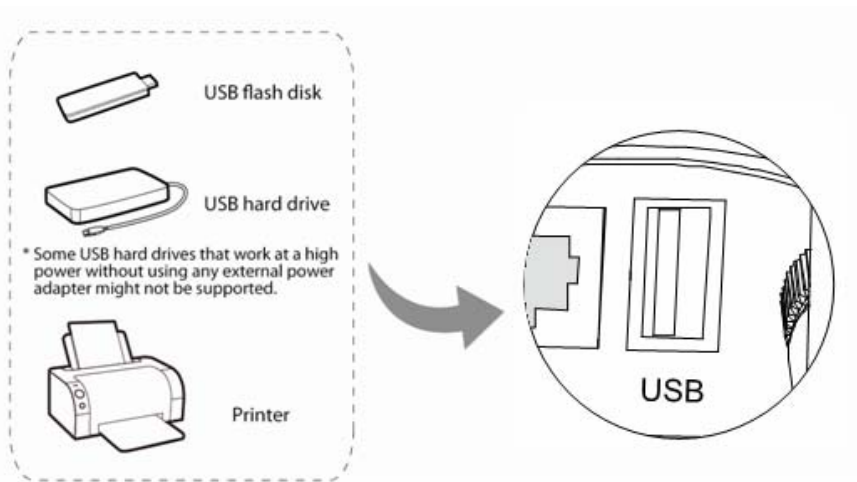

Figure 2-2 USB connection

Note:

If you want to use the router to share files or printer, plug a USB storage device to the USB port or connect the printer to the router with a matching cable.

Chapter 3. Quick Installation Guide

This chapter will show you how to configure the basic functions of your AV500 Hybrid Wi-Fi Starter Kit using Quick Setup Wizard within minutes.

3.1 TCP/IP Configuration

The default IP address of the router is **192.168.1.1** and the default subnet mask is 255.255.255.0. These values can be changed as you desire. In this guide, we use all the default values for description.

Connect the local PC to the Ethernet ports of the router and then you can configure the IP address for your PC by the following method: Set up the TCP/IP Protocol in "**Obtain an IP address automatically**" mode on your PC. If you need instructions as to how to do this, please refer to [Appendix B: Configuring the PC](#). Then the built-in DHCP server will assign IP address for the PC.

Now, you can run the Ping command in the command prompt to verify the network connection between your PC and the router. The following example is in Windows 2000 OS.

Open a command prompt, type *ping 192.168.1.1*, and then press **Enter**.

- If the result displayed is similar to the Figure 3-1, it means the connection between your PC and the router has been established well.

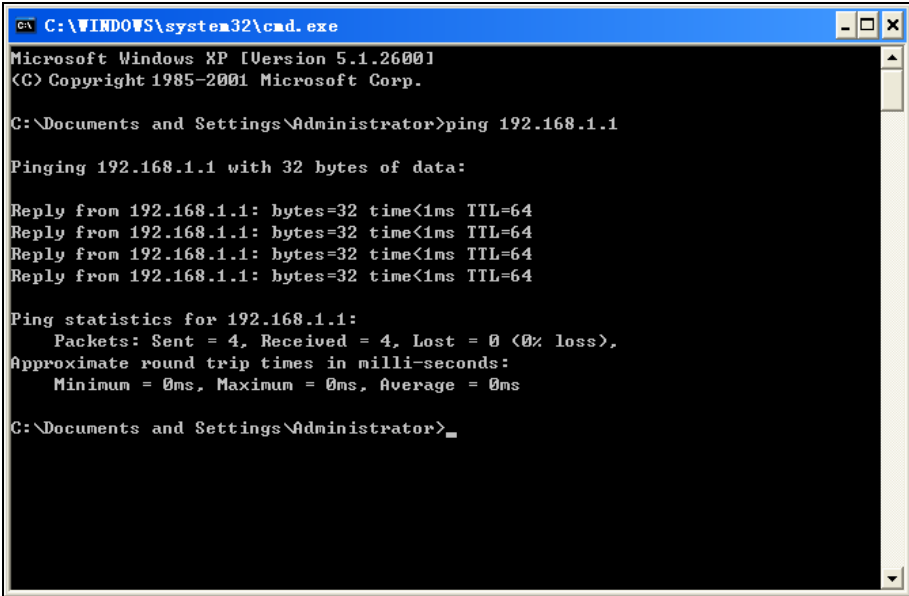

```
C:\WINDOWS\system32\cmd.exe
Microsoft Windows XP [Version 5.1.2600]
(C) Copyright 1985-2001 Microsoft Corp.

C:\Documents and Settings\Administrator>ping 192.168.1.1

Pinging 192.168.1.1 with 32 bytes of data:

Reply from 192.168.1.1: bytes=32 time<1ms TTL=64
Reply from 192.168.1.1: bytes=32 time<1ms TTL=64
Reply from 192.168.1.1: bytes=32 time<1ms TTL=64
Reply from 192.168.1.1: bytes=32 time<1ms TTL=64

Ping statistics for 192.168.1.1:
    Packets: Sent = 4, Received = 4, Lost = 0 (0% loss),
    Approximate round trip times in milli-seconds:
        Minimum = 0ms, Maximum = 0ms, Average = 0ms

C:\Documents and Settings\Administrator>
```

Figure 3-1 Success result of Ping command

- If the result displayed is similar to Figure 3-2, it means the connection between your PC and the router failed.

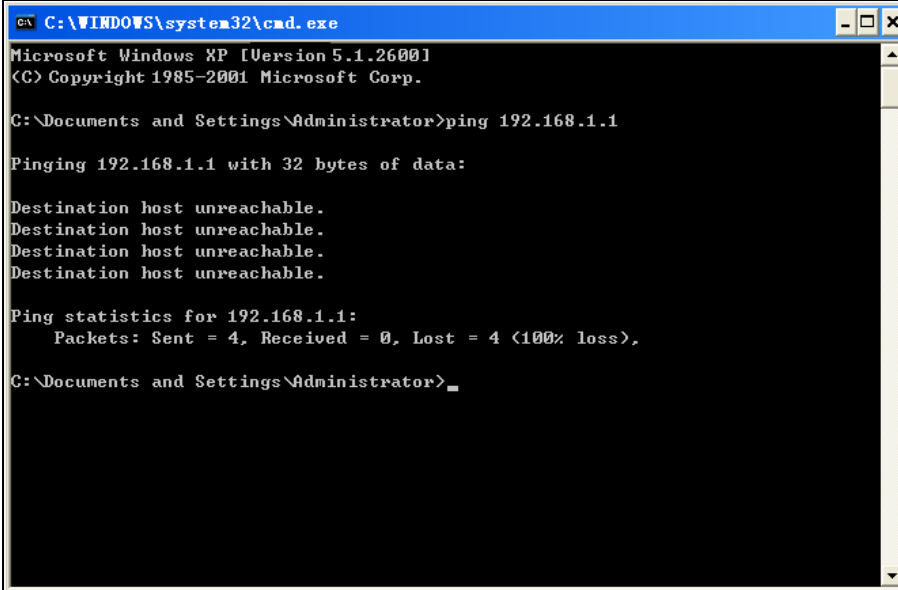

```

C:\WINDOWS\system32\cmd.exe
Microsoft Windows XP [Version 5.1.2600]
(C) Copyright 1985-2001 Microsoft Corp.

C:\Documents and Settings\Administrator>ping 192.168.1.1

Pinging 192.168.1.1 with 32 bytes of data:

Destination host unreachable.
Destination host unreachable.
Destination host unreachable.
Destination host unreachable.

Ping statistics for 192.168.1.1:
    Packets: Sent = 4, Received = 0, Lost = 4 (100% loss),

C:\Documents and Settings\Administrator>_

```

Figure 3-2 Failure result of Ping command

Please check the connection following these steps:

1. Is the connection between your PC and the router correct?

 **Note:**

The LAN LED on the router and the LEDs on your PC's adapter should be lit.

2. Is the TCP/IP configuration for your PC correct?

 **Note:**

If the router's IP address is 192.168.1.1, your PC's IP address must be within the range of 192.168.1.2–192.168.1.254.

3. Is the default LAN IP of the router correct?

 **Note:**

If the LAN IP of the modem connected with your router is 192.168.1.x, the default LAN IP of the router will automatically switch from 192.168.1.1 to 192.168.0.1 to avoid IP conflict. Therefore, in order to verify the network connection between your PC and the router, you can open a command prompt, type *ping 192.168.0.1*, and then press **Enter**.

3.2 Quick Installation Guide

3.2.1 Configure the Router

With a Web-based utility, it is easy to configure and manage the AV500 Hybrid Wi-Fi Starter Kit. The Web-based utility can be used on any Windows, Macintosh or UNIX OS with a Web browser, such as Microsoft Internet Explorer, Mozilla Firefox or Apple Safari.

1. To access the configuration utility of the router, open a web-browser, type <http://tplinklogin.net> in the address field and press **Enter**.

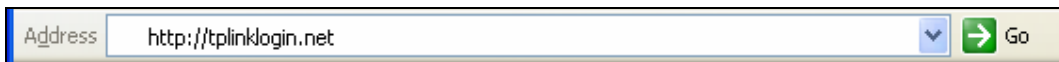

Figure 3-3 Log in to the router

After a moment, a login window will appear, similar to Figure 3-4. Enter **admin** for the user name and password, both in lower-case letters. Then click the **OK** button or press the **Enter** key.

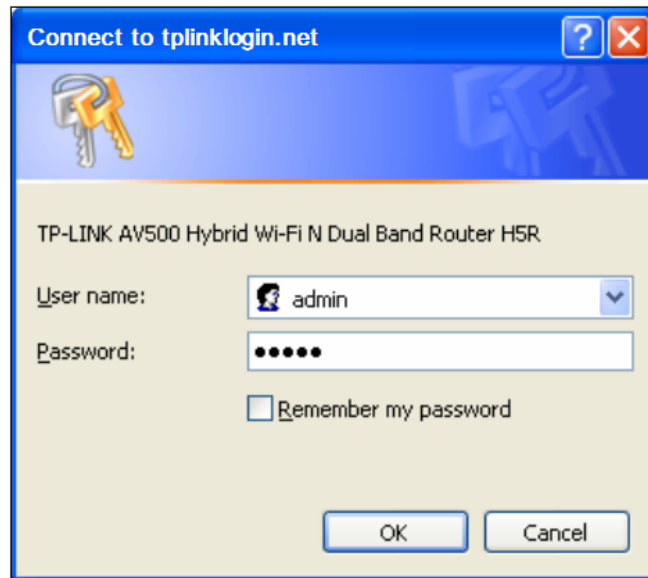

Figure 3-4 Login Windows

Note:

If the above screen does not pop up, it means that your Web-browser has been set to use a proxy. Go to “**Tools** → **Internet Options** → **Connections** → **LAN Settings**“. In the screen that appears, cancel the **Using Proxy** checkbox, and click **OK** to finish it.

2. After successfully log in, you can click the **Quick Setup** menu to quickly configure your router.

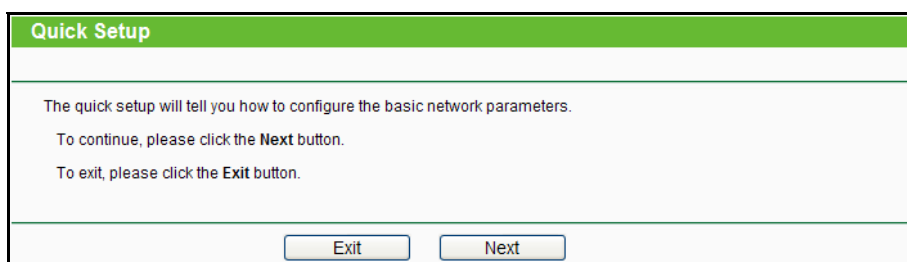

Figure 3-5 Quick Setup

Note:

The router will automatically detect the Internet connection. If the Internet is available, the router will direct you to **Step 5**; otherwise, you need to continue with **Step 3**.

3. Select **Auto-Detect** to detect the Internet connection type and then click **Next**.

Figure 3-6 WAN Connection Type

The router provides **Auto-Detect** function and supports five types of WAN connection: **Dynamic IP**, **Static IP**, **PPPoE/Russian PPPoE**, **L2TP/Russian L2TP**, and **PPTP/Russian PPTP**. It's recommended that you make use of the **Auto-Detect** function. If you are sure of what kind of connection type your ISP provides, you can select the very type and click **Next** to go on configuring.

4. If you select **Auto-Detect**, the router will automatically detect the connection type your ISP provides. Make sure the cable is securely plugged into the Internet port before detection. The appropriate configuration page will be displayed when an active Internet service is successfully detected by the router.
- 1) If the connection type is **Dynamic IP**, the MAC Clone page (as shown in Figure 3-7) will appear. In most cases, there is no need to clone the MAC address. You can select “**No, ...**” and then click **Next**. If it is necessary in your case, please select “**Yes, ...**”, click the **Clone MAC Address** button, and then click **Next**.

Figure 3-7 Quick Setup – MAC Clone

- 2) If the connection type is **Static IP**, the next screen will appear as shown in Figure 3-8. Configure the following parameters and then click **Next** to continue.

Figure 3-8 Quick Setup - Static IP

- **IP Address** - This is the WAN IP address as seen by external users on the Internet (including your ISP). Your ISP will provide you with the IP address you need to enter here. Enter the IP address into the field.
 - **Subnet Mask** - The Subnet Mask is used for the WAN IP address. Your IPS will provide you with the subnet mask which is usually 255.255.255.0.
 - **Default Gateway** - Your ISP will provide you with the Gateway address which is the ISP server's address. Enter the gateway IP address into the box if required.
 - **Primary DNS** - Enter the DNS Server IP address into the box if required.
 - **Secondary DNS** - (Optional) If your ISP provides another DNS server, enter it into this field.
- 3) If the connection type is **PPPoE/Russian PPPoE**, the next screen will appear as shown in Figure 3-9. Configure the following parameters and then click **Next** to continue.

Figure 3-9 Quick Setup – PPPoE

- **User Name/Password** - Enter the user name and password provided by your ISP. These fields are case-sensitive.

- **Confirm Password** - Enter the password again to make sure that the password is correct.

Check the radio button of **Dynamic/Static IP** to activate the secondary connection if your ISP provides an extra Connection type such as Dynamic/Static IP to connect to a local area network.

- 4) If the connection type is **L2TP/ Russian L2TP**, the next screen will appear as shown in Figure 3-10. Configure the following parameters and then click **Next** to continue.

Figure 3-10 Quick Setup – L2TP

- **User Name/Password** - Enter the user name and password provided by your ISP. These fields are case-sensitive.

Select **Static IP** if IP address, subnet mask, gateway and DNS server address have been provided by your ISP. Then please enter server IP address or domain name provided by your ISP, and also enter the corresponding parameters.

Select **Dynamic IP** if none of the above parameters are provided. Then you just need to enter server IP address or domain name provided by your ISP.

- 5) If the connection type is **PPTP/Russian PPTP**, the next screen will appear as shown in Figure 3-11. Configure the following parameters and then click **Next** to continue.

Figure 3-11 Quick Setup – PPTP

- **User Name/Password** - Enter the user name and password provided by your ISP. These fields are case-sensitive.

Select **Static IP** if IP address, subnet mask, gateway and DNS server address have been provided by your ISP. Then please enter server IP address or domain name provided by your ISP, and also enter the corresponding parameters.

Select **Dynamic IP** if none of the above parameters are provided. Then you just need to enter server IP address or domain name provided by your ISP.

5. After finishing WAN Connection Type selection, the **Dual Band Selection** page will appear as shown in Figure 3-12. Here we select “**Concurrently with 2.4GHz and 5GHz (802.11 a/b/g/n)**”, meaning that the router uses 2.4GHz and 5GHz bands at the same time. Then click **Next** to continue.

Figure 3-12 Quick Setup – Dual Band Selection

- **2.4GHz** - You can use the 2.4GHz band to connect to many classic wireless devices like gaming consoles, laptops, DVRs, ect.
 - **5GHz** - This band is less crowded and is used for time-sensitive music, video streaming or gaming. Using this band can avoid interference with 2.4GHz networks or noisy devices like cordless phones and microwave ovens.
6. Configure the basic parameters for 2.4GHz wireless network in the following screen as shown in Figure 3-13, and then click **Next**.

Figure 3-13 Quick Setup – Wireless 2.4GHz

- **Wireless Radio** - Displays whether the wireless function is enabled or not.
- **Wireless Network Name** - Also called the SSID (Service Set Identification). Enter a value of up to 32 characters. The same name must be assigned to all wireless devices in your network. The default SSID is set to be TP-LINK_2.4GHz_XXXXXX. This value is case-sensitive. For example, *TEST* is NOT the same as *test*.
- **Region** - Select your region from the drop-down list. This field specifies the region where the wireless function of the router can be used. It may be illegal to use the wireless function of the router in a region other than one of those specified in this field. If

your country or region is not listed, please contact your local government agency for assistance.

 **Note:**

Limited by local law regulations, version for North America does not have region selection option.

- **Mode** - This field determines the wireless mode which the router works on.
 - **11b only/11g only/11n only** - Select the corresponding mode if you are using 802.11b, 802.11g or 802.11n wireless clients only.
 - **11bg mixed** – Select this mode if you are using both 802.11b and 802.11g wireless clients.
 - **11bgn mixed** - Select this mode if you are using a mix of 802.11b, 11g, and 11n wireless clients.
 - **Channel Width** - Select any channel width from the drop-down list. The default setting is “Auto”, which can adjust the channel width for your clients automatically.
 - **Channel** - This field determines which wireless channel will be used. It is not necessary to change the wireless channel unless you notice interference problems with another nearby access point. If you select “Auto”, then the router will select the best channel automatically.
 - **Wireless Security**
 - **Disable Security** - The wireless security function can be enabled or disabled. If disabled, the wireless stations will be able to connect the router without encryption.
 - **Enable Security (WPA-PSK/WPA2-PSK)** – It's selected by default, with the default PSK password the same as the default PIN code.
 - **No Change** - If you choose this option, wireless security configuration will not change.
7. Configure the basic parameters for 5GHz wireless network in the following screen as shown in Figure 3-14, and then click **Next**.

Quick Setup - Wireless 5GHz

Wireless Radio: Enable

Wireless Network Name: DEF (Also called the SSID)

Region: United States

Warning: Ensure you select a correct country to conform local law. Incorrect settings may cause interference.

Band: 5GHz

Mode: 11n mixed

Channel Width: Auto

Channel: Auto

Wireless Security:

Disable Security

Enable Security(WPA-PSK/WPA2-PSK)

PSK Password: D1E2F3G4
(You can enter ASCII characters between 8 and 63 or Hexadecimal characters between 8 and 64.)

Not Change

Back Next

Figure 3-14 Quick Setup – Wireless 5GHz

- **Wireless Radio** - Displays whether the wireless function is enabled or not.
- **Wireless Network Name** - Also called the SSID (Service Set Identification). Enter a value of up to 32 characters. The same name must be assigned to all wireless devices in your network. The default SSID is set to be TP-LINK_5GHz_XXXXXX. This value is case-sensitive. For example, *TEST* is NOT the same as *test*.
- **Region** - Select your region from the drop-down list. This field specifies the region where the wireless function of the router can be used. It may be illegal to use the wireless function of the router in a region other than one of those specified in this field. If your country or region is not listed, please contact your local government agency for assistance.

Note:

Limited by local law regulations, version for North America does not have region selection option.

- **Mode** - This field determines the wireless mode which the router works on.
 - **11a only/11n only** - Select the corresponding mode if you are using 802.11a or 802.11n wireless clients only.
 - **11n mixed** - Select if you are using both 802.11a and 802.11n wireless clients.
- **Channel Width** - Select any channel width from the drop-down list. The default setting is “Auto”, which can adjust the channel width for your clients automatically.
- **Channel** - This field determines which wireless channel will be used. It is not necessary to change the wireless channel unless you notice interference problems with another

nearby access point. If you select “Auto”, then the router will select the best channel automatically.

➤ **Wireless Security**

- **Disable Security** - The wireless security function can be enabled or disabled. If disabled, the wireless stations will be able to connect the router without encryption.
- **Enable Security (WPA-PSK/WPA2-PSK)** – It's selected by default, with the default PSK password the same as the default PIN code.
- **No Change** - If you chose this option, wireless security configuration will not change!

8. Click the **Reboot** button to complete the quick setup.

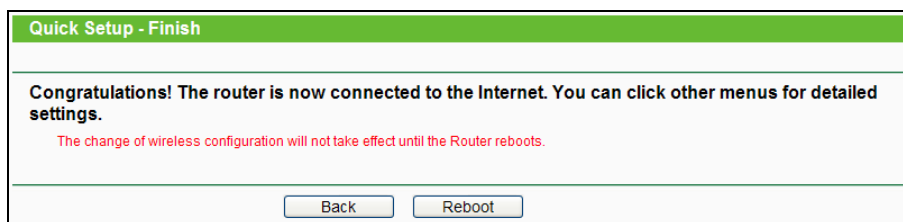

Figure 3-15 Quick Setup – Finish

3.2.2 Unify and Extend Wi-Fi Network via AP Clone

To unify and extend your network, you can set up a network between the router and the extender via powerline pairing and AP clone.

Powerline pairing enables the router and the extender to form a secured network. AP clone enables the extender to automatically synchronize wireless settings (such as the SSID and wireless password) with the router, providing you a secured network roaming experience.

Please follow the steps below to get started.

Note:

The router supports both 2.4GHz and 5GHz networks while the extender supports only 2.4GHz network. So the extender can only synchronize wireless settings of 2.4GHz network.

1. Plug the extender into a wall socket near the router.
2. Press the AP CLONE/PAIR button on the router's side panel and the router's Power LED will blink.

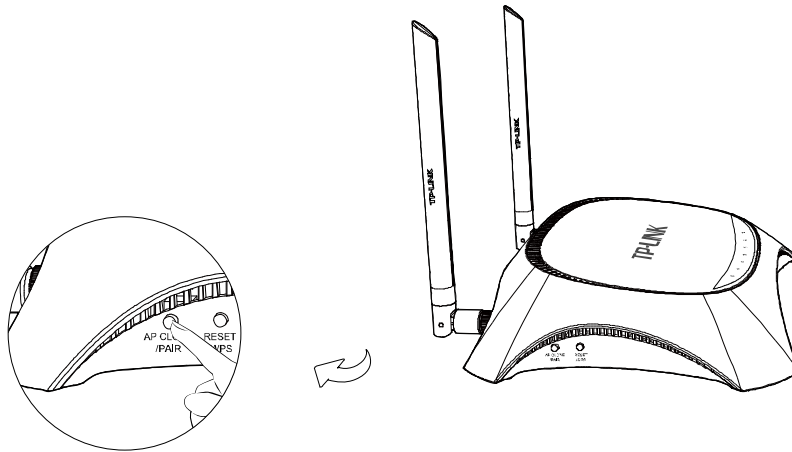

3. Press the AP CLONE/PAIR button on the extender's bottom and the extender's Power LED will blink quickly. In about 20 seconds, both Powerline LEDs will be solid on, indicating that the router and the extender have formed a powerline network. Then both Power LEDs will be solid on, indicating that the AP clone process is completed.

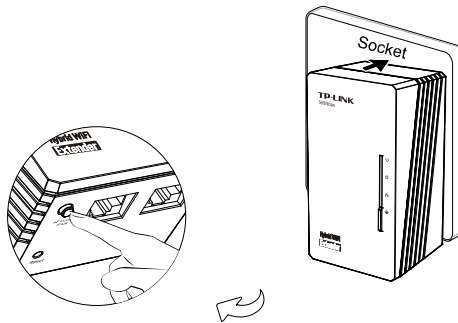

4. Place the extender in your desired location. The extender will automatically synchronize wireless settings with the router whenever the router's wireless settings are changed.

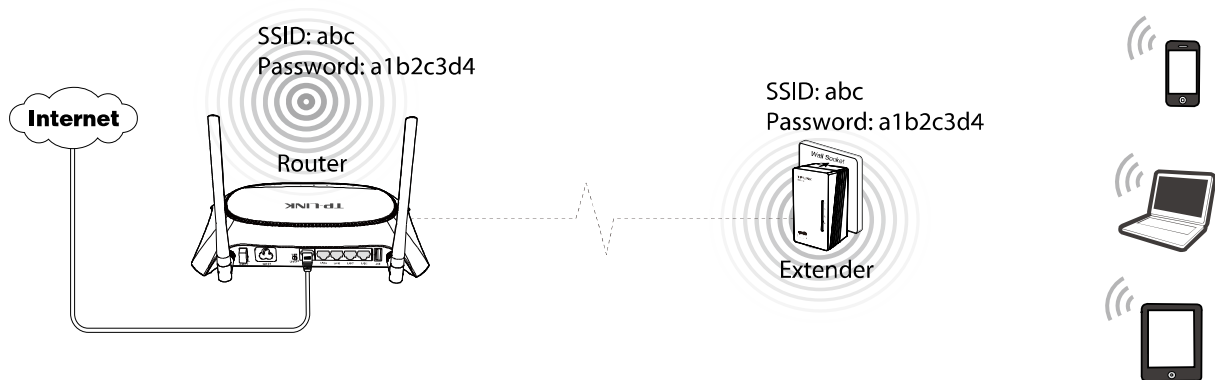

Chapter 4. Configuring the Router

This chapter will describe the key functions and configuration way of the router's Web management page.

4.1 Login

After your successful login, you will see the main menus on the left of the Web-based utility. On the right, there are the corresponding explanations and instructions.

Status
Quick Setup
Network
Dual Band Selection
Wireless 2.4GHz
Wireless 5GHz
Powerline
Extender List
DHCP
USB Settings
NAT
Forwarding
Security
Parental Control
Access Control
Advanced Routing
Bandwidth Control
IP & MAC Binding
Dynamic DNS
System Tools

The detailed explanations for each Web page's key function are listed below.

4.2 Status

The Status page provides the current status information about the router. All information is read-only.

Status		
Firmware Version:	3.13.22 Build 131022 Rel.50287n MAC-QCA7420-1.1.0.844-01-20120919-FINAL_005r11_20131021_001	
Hardware Version:	H5R v1 00000000	
Powerline		
MAC Address:	00-05-29-54-00-01	
Device Password:	FVDL-AVKV-JNKS-ESBU	
Network Name:	TP-LINK_052036	
LAN		
MAC Address:	00-05-30-05-20-36	
IP Address:	192.168.1.1	
Subnet Mask:	255.255.255.0	
Wireless 2.4GHz		
Wireless Radio:	Enabled	
Name (SSID):	abc	
Mode:	11bgn mixed	
Channel:	Automatic (Current channel 6)	
Channel Width:	Automatic	
MAC Address:	00-05-30-05-20-35	
Wireless 5GHz		
Wireless Radio:	Enabled	
Name (SSID):	DEF	
Mode:	11an mixed	
Channel:	Automatic (Current channel 157)	
Channel Width:	Automatic	
MAC Address:	00-05-30-05-20-36	
WAN		
MAC Address:	50-E5-49-C7-64-6E	
IP Address:	172.29.74.31	Static IP
Subnet Mask:	255.255.255.0	
Default Gateway:	172.29.74.1	
DNS Server:	172.31.1.1 , 0.0.0.0	
Traffic Statistics		
	Received	Sent
Bytes:	18887	25610
Packets:	132	186
System Up Time:	0 day(s) 00:01:55	
	<input type="button" value="Refresh"/>	

Figure 4-1 Router Status

4.3 Quick Setup

Please refer to [3.2 Quick Installation Guide](#).

4.4 Network

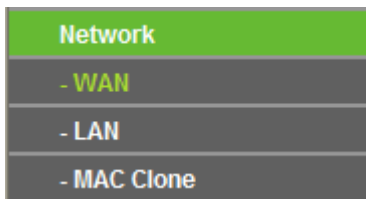

Figure 4-2 Network menu

There are three submenus under the Network menu (shown in Figure 4-2): **WAN**, **LAN** and **MAC Clone**. Click any of them, and you will be able to configure the corresponding function.

4.4.1 WAN

Choose menu “**Network** → **WAN**”, and then you can configure the IP parameters of the WAN on the screen below.

1. If your ISP provides the DHCP service, please choose **Dynamic IP** type, and the router will automatically get IP parameters from your ISP. You can see the page as follows (Figure 4-3):

 A screenshot of the WAN configuration page. The title is 'WAN'. The 'WAN Connection Type' is set to 'Dynamic IP'. There is a 'Detect' button and a 'Detecting...' status indicator. Below this are fields for 'IP Address', 'Subnet Mask', and 'Default Gateway', all set to '0.0.0.0'. There are 'Renew' and 'Release' buttons. The 'MTU Size (in bytes)' is set to '1500' with a note: '(The default is 1500, do not change unless necessary.)'. There is a checkbox for 'Use These DNS Servers' which is unchecked. Below it are fields for 'Primary DNS' and 'Secondary DNS', both set to '0.0.0.0' with '(Optional)' next to the secondary field. The 'Host Name' is set to 'H5R'. At the bottom, there is a checkbox for 'Get IP with Unicast DHCP (It is usually not required.)' which is unchecked, and a 'Save' button.

Figure 4-3 WAN – Dynamic IP

This page displays the WAN IP parameters assigned dynamically by your ISP, including IP address, Subnet Mask, Default Gateway, etc. Click the **Renew** button to renew the IP parameters from your ISP. Click the **Release** button to release the IP parameters.

- **MTU Size** - The normal **MTU** (Maximum Transmission Unit) value for most Ethernet networks is 1500 Bytes. It is not recommended that you change the default **MTU Size** unless required by your ISP.
- **Use These DNS Servers** - If your ISP gives you one or two DNS addresses, select **Use These DNS Servers** and enter the primary and secondary addresses into the correct fields. Otherwise, the DNS servers will be assigned dynamically from your ISP.

 **Note:**

If you find error when you go to a website after entering the DNS addresses, it is likely that your DNS servers are set up improperly. You should contact your ISP to get DNS server addresses.

- **Host Name** - This option specifies the host name of the router.
- **Get IP with Unicast DHCP** - A few ISPs' DHCP servers do not support the broadcast applications. If you cannot get the IP Address normally, you can choose this option. (It is rarely required.)

Click the **Save** button to save your settings.

2. If your ISP provides a static or fixed IP Address, Subnet Mask, Gateway and DNS setting, select **Static IP**. The Static IP settings page will appear, shown in Figure 4-4.

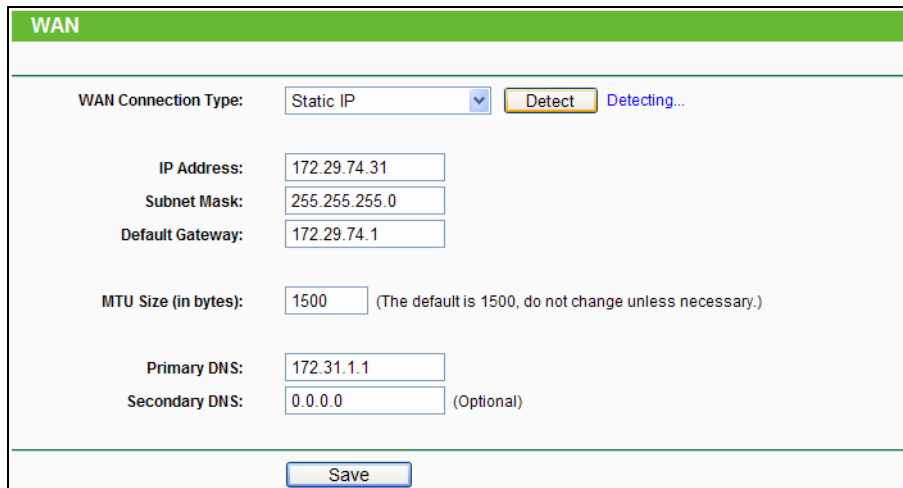

WAN

WAN Connection Type: Detecting...

IP Address:

Subnet Mask:

Default Gateway:

MTU Size (in bytes): (The default is 1500, do not change unless necessary.)

Primary DNS:

Secondary DNS: (Optional)

Figure 4-4 WAN - Static IP

- **IP Address** - Enter the IP address in dotted-decimal notation provided by your ISP.
- **Subnet Mask** - Enter the subnet Mask in dotted-decimal notation provided by your ISP, usually is 255.255.255.0.
- **Default Gateway** - (Optional) Enter the gateway IP address in dotted-decimal notation provided by your ISP.

- **MTU Size** - The normal **MTU** (Maximum Transmission Unit) value for most Ethernet networks is 1500 Bytes. It is not recommended that you change the default **MTU Size** unless required by your ISP.
- **Primary/Secondary DNS** - (Optional) Enter one or two DNS addresses in dotted-decimal notation provided by your ISP.

Click the **Save** button to save your settings.

3. If your ISP provides a PPPoE connection, select **PPPoE/Russia PPPoE** option. And you should enter the following parameters (Figure 4-5):

The screenshot shows the WAN configuration interface. At the top, there is a green header with the text 'WAN'. Below the header, the 'WAN Connection Type' is set to 'PPPoE/Russia PPPoE' in a dropdown menu. To the right of this dropdown is a 'Detect' button, which is currently disabled and shows 'Detecting...' in blue text. Below this, the 'PPPoE Connection' section contains three input fields: 'User Name:', 'Password:', and 'Confirm Password:'. The 'Secondary Connection' section has three radio buttons: 'Disabled' (which is selected), 'Dynamic IP', and 'Static IP (For Dual Access/Russia PPPoE)'. The 'Wan Connection Mode' section has four radio buttons: 'Connect on Demand', 'Connect Automatically' (which is selected), 'Time-based Connecting', and 'Connect Manually'. Under 'Connect on Demand' and 'Connect Manually', there is a 'Max Idle Time' field set to '15' minutes. Under 'Time-based Connecting', there are two sets of time input fields: 'Period of Time: from 0 : 0 (HH:MM) to 23 : 59 (HH:MM)'. At the bottom of the form, there are three buttons: 'Connect', 'Disconnect', and 'Disconnected!'. At the very bottom of the page, there are two buttons: 'Save' and 'Advanced'.

Figure 4-5 WAN - PPPoE

- **User Name/Password** - Enter the user name and password provided by your ISP. These fields are case-sensitive.
- **Secondary Connection** - It's available only for PPPoE Connection. If your ISP provides an extra Connection type such as Dynamic/Static IP to connect to a local area network, then you can check the radio button of Dynamic/Static IP to activate this secondary connection.
 - **Disabled** - The Secondary Connection is disabled by default, so there is PPPoE connection only. This is recommended.
 - **Dynamic IP** - You can check this radio button to use Dynamic IP as the secondary connection to connect to the local area network provided by ISP.
 - **Static IP** - You can check this radio button to use Static IP as the secondary connection to connect to the local area network provided by ISP.

- **Connect on Demand** - In this mode, the Internet connection can be terminated automatically after a specified inactivity period (**Max Idle Time**) and be re-established when you attempt to access the Internet again. If you want your Internet connection keeps active all the time, please enter "0" in the **Max Idle Time** field. Otherwise, enter the number of minutes you want to have elapsed before your Internet access disconnects.
- **Connect Automatically** - The connection can be re-established automatically when it was down.
- **Time-based Connecting** - The connection will only be established in the period from the start time to the end time (both are in HH:MM format).

 **Note:**

Only when you have set the system time on **System Tools** -> **Time Settings** page, the **Time-based Connecting** function can take effect.

- **Connect Manually** - You can click the **Connect/Disconnect** button to connect/disconnect immediately. This mode also supports the **Max Idle Time** function as **Connect on Demand** mode. The Internet connection can be disconnected automatically after a specified inactivity period and re-established when you attempt to access the Internet again.

Click the **Connect** button to connect immediately. Click the **Disconnect** button to disconnect immediately.

Caution: Sometimes the connection cannot be terminated although you specify a time to **Max Idle Time** because some applications are visiting the Internet continually in the background.

If you want to do some advanced configurations, please click the **Advanced** button, and the page shown in Figure 4-6 will then appear:

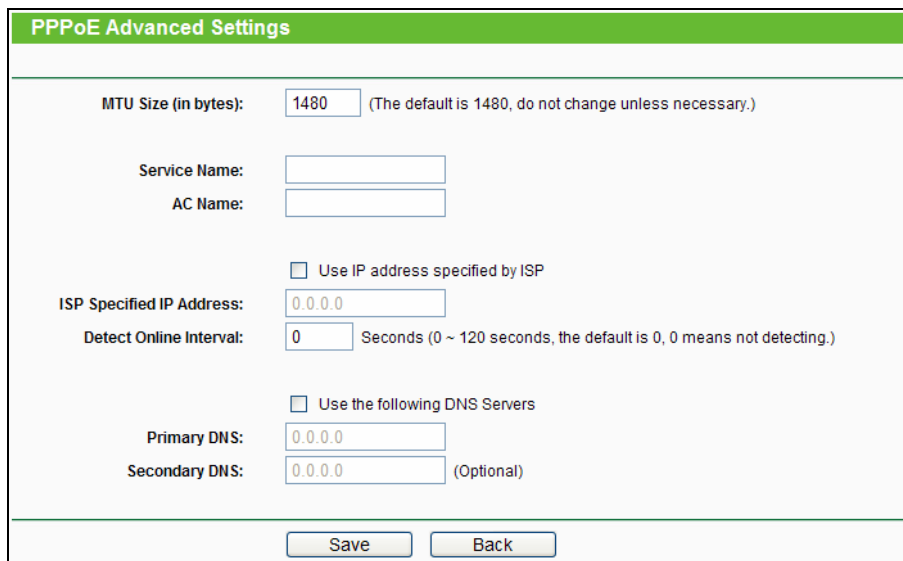

Figure 4-6 PPPoE Advanced Settings

- **MTU Size** - The default MTU size is “1480” bytes, which is usually fine. It is not recommended that you change the default **MTU Size** unless required by your ISP.
- **Service Name/AC Name** - The service name and AC (Access Concentrator) name should not be configured unless you are sure it is necessary for your ISP. In most cases, leaving these fields blank will work.
- **ISP Specified IP Address** - If your ISP does not automatically assign IP addresses to the router during login, please click “**Use IP address specified by ISP**” check box and enter the IP address provided by your ISP in dotted-decimal notation.
- **Detect Online Interval** - The router will detect Access Concentrator online at every interval. The default value is “0”. You can input the value between “0” and “120”. The value “0” means no detect.
- **Primary DNS/Secondary DNS** - If your ISP does not automatically assign DNS addresses to the router during login, please click “**Use the following DNS servers**” check box and enter the IP address in dotted-decimal notation of your ISP’s primary DNS server. If a secondary DNS server address is available, enter it as well.

Click the **Save** button to save your settings.

4. If your ISP provides BigPond Cable (or Heart Beat Signal) connection, please select **BigPond Cable**. And you should enter the following parameters (Figure 4-7):

The screenshot shows the WAN configuration interface for a BigPond Cable connection. The page has a green header with the text 'WAN'. Below the header, the 'WAN Connection Type' is set to 'BigPond Cable' in a dropdown menu. There are input fields for 'User Name' and 'Password'. The 'Auth Server' field contains 'sm-server', and the 'Auth Domain' field is empty. The 'MTU Size (in bytes)' is set to '1500', with a note: '(The default is 1500. Do not change it unless necessary.)'. There are three radio button options: 'Connect on Demand' (selected), 'Connect Automatically', and 'Connect Manually'. Each radio button option has a 'Max Idle Time' field set to '15' minutes, with a note: '(0 means remaining active all the time.)'. At the bottom of the form, there are three buttons: 'Connect', 'Disconnect', and 'Disconnected!'. A 'Save' button is located at the very bottom of the page.

Figure 4-7 WAN - BigPond Cable

- **User Name/Password** - Enter the user name and password provided by your ISP. These fields are case-sensitive.

- **Auth Server** - Enter the authenticating server IP address or host name.
- **Auth Domain** - Type in the domain suffix server name based on your location.
e.g.
NSW / ACT - **nsw.bigpond.net.au**
VIC / TAS / WA / SA / NT - **vic.bigpond.net.au**
QLD - **qld.bigpond.net.au**
- **MTU Size** - The normal **MTU** (Maximum Transmission Unit) value for most Ethernet networks is 1500 Bytes. It is not recommended that you change the default **MTU Size** unless required by your ISP.
- **Connect on Demand** - In this mode, the Internet connection can be terminated automatically after a specified inactivity period (**Max Idle Time**) and be re-established when you attempt to access the Internet again. If you want your Internet connection keeps active all the time, please enter "0" in the **Max Idle Time** field. Otherwise, enter the number of minutes you want to have elapsed before your Internet access disconnects.
- **Connect Automatically** - The connection can be re-established automatically when it was down.
- **Connect Manually** - You can click the **Connect/Disconnect** button to connect/disconnect immediately. This mode also supports the **Max Idle Time** function as **Connect on Demand** mode. The Internet connection can be disconnected automatically after a specified inactivity period and re-established when you attempt to access the Internet again.

Click the **Connect** button to connect immediately. Click the **Disconnect** button to disconnect immediately.

Caution: Sometimes the connection cannot be terminated although you specify a time to Max Idle Time because some applications are visiting the Internet continually in the background.

Click the **Save** button to save your settings.

5. If your ISP provides L2TP connection, please select **L2TP/Russia L2TP** option. And you should enter the following parameters (Figure 4-8):

The screenshot shows the WAN configuration interface for L2TP/Russia L2TP. The interface includes the following fields and options:

- WAN Connection Type:** L2TP/Russia L2TP (selected)
- User Name:** [Empty text box]
- Password:** [Empty text box]
- Connect/Disconnect buttons:** [Connect] [Disconnect] **Disconnected!**
- Dynamic IP/Static IP:** Dynamic IP Static IP
- DNS:** 0.0.0.0 , 0.0.0.0
- Internet IP Address:** 0.0.0.0
- Internet DNS:** 0.0.0.0 , 0.0.0.0
- MTU Size (in bytes):** 1460 (The default is 1460, do not change unless necessary.)
- Max Idle Time:** 15 minutes (0 means remain active at all times.)
- WAN Connection Mode:**
 - Connect on Demand
 - Connect Automatically
 - Connect Manually
- Save button:** [Save]

Figure 4-8 WAN - L2TP/Russia L2TP

- **User Name/Password** - Enter the user name and password provided by your ISP. These fields are case-sensitive.
- **Dynamic IP/ Static IP** - Choose either as you are given by your ISP. Click the **Connect** button to connect immediately. Click the **Disconnect** button to disconnect immediately.
- **Connect on Demand** - You can configure the router to disconnect from your Internet connection after a specified period of inactivity (**Max Idle Time**). If your Internet connection has been terminated due to inactivity, **Connect on Demand** enables the router to automatically re-establish your connection as soon as you attempt to access the Internet again. If you wish to activate **Connect on Demand**, check the radio button. If you want your Internet connection to remain active at all times, enter 0 in the **Max Idle Time** field. Otherwise, enter the number of minutes you want to have elapsed before your Internet connection terminates.
- **Connect Automatically** - Connect automatically after the router is disconnected. To use this option, check the radio button.
- **Connect Manually** - You can configure the router to make it connect or disconnect manually. After a specified period of inactivity (**Max Idle Time**), the router will disconnect from your Internet connection, and you will not be able to re-establish your connection automatically as soon as you attempt to access the Internet again. To use this option, check the radio button. If you want your Internet connection to remain active at all times, enter "0" in the **Max Idle Time**

field. Otherwise, enter the number of minutes that you wish to have the Internet connecting last unless a new link is requested.

Caution: Sometimes the connection cannot be disconnected although you specify a time to **Max Idle Time**, because some applications are visiting the Internet continually in the background.

Click the **Save** button to save your settings.

6. If your ISP provides PPTP connection, please select **PPTP/Russia PPTP** option. And you should enter the following parameters (Figure 4-9):

The screenshot shows the WAN settings interface. At the top, there is a green header with the text 'WAN'. Below it, the 'WAN Connection Type' is set to 'PPTP/Russia PPTP'. There are input fields for 'User Name' and 'Password'. Below these are 'Connect' and 'Disconnect' buttons, with the status 'Disconnected!' displayed. The 'Dynamic IP' option is selected with a radio button. The 'DNS' field contains '0.0.0.0, 0.0.0.0'. The 'Internet IP Address' and 'Internet DNS' fields also contain '0.0.0.0'. The 'MTU Size (in bytes)' is set to '1420' with a note '(The default is 1420, do not change unless necessary.)'. The 'Max Idle Time' is set to '15' minutes with a note '(0 means remain active at all times.)'. The 'WAN Connection Mode' has three options: 'Connect on Demand' (selected), 'Connect Automatically', and 'Connect Manually'. A 'Save' button is located at the bottom of the form.

Figure 4-9 PPTP Settings

- **User Name/Password** - Enter the user name and password provided by your ISP. These fields are case-sensitive.
- **Dynamic IP/ Static IP** - Choose either as you are given by your ISP and enter the ISP's IP address or the domain name.

If you choose static IP and enter the domain name, you should also enter the DNS assigned by your ISP. And click the **Save** button.

Click the **Connect** button to connect immediately. Click the **Disconnect** button to disconnect immediately.

- **Connect on Demand** - You can configure the router to disconnect from your Internet connection after a specified period of inactivity (**Max Idle Time**). If your Internet connection has been terminated due to inactivity, **Connect on Demand** enables the router to

automatically re-establish your connection as soon as you attempt to access the Internet again. If you wish to activate **Connect on Demand**, check the radio button. If you want your Internet connection to remain active at all times, enter "0" in the **Max Idle Time** field. Otherwise, enter the number of minutes you want to have elapsed before your Internet connection terminates.

- **Connect Automatically** - Connect automatically after the router is disconnected. To use this option, check the radio button.
- **Connect Manually** - You can configure the router to make it connect or disconnect manually. After a specified period of inactivity (**Max Idle Time**), the router will disconnect from your Internet connection, and you will not be able to re-establish your connection automatically as soon as you attempt to access the Internet again. To use this option, click the radio button. If you want your Internet connection to remain active at all times, enter "0" in the **Max Idle Time** field. Otherwise, enter the number in minutes that you wish to have the Internet connecting last unless a new link is requested.

Caution: Sometimes the connection cannot be disconnected although you specify a time to **Max Idle Time** because some applications are visiting the Internet continually in the background.

Click the **Save** button to save your settings.

 **Note:**

If you don't know how to choose the appropriate connection type, click the **Detect** button to allow the router to automatically search your Internet connection for servers and protocols. The connection type will be reported when an active Internet service is successfully detected by the router. This report is for your reference only. To make sure the connection type your ISP provides, please refer to the ISP. The various types of Internet connections that the router can detect are as follows:

- **PPPoE** - Connections which use PPPoE that requires a user name and password.
- **Dynamic IP** - Connections which use dynamic IP address assignment.
- **Static IP** - Connections which use static IP address assignment.

The router can not detect PPTP/L2TP/BigPond connections with your ISP. If your ISP uses one of these protocols, then you must configure your connection manually.

4.4.2 LAN

Choose menu "**Network** → **LAN**", and then you can configure the IP parameters of the LAN on the screen as below.

Figure 4-10 LAN

- **MAC Address** - The physical address of the router. The value can't be changed.
- **IP Address** - Enter the IP address of your router or reset it in dotted-decimal notation (factory default: 192.168.1.1).
- **Subnet Mask** - An address code that determines the size of the network. Normally use 255.255.255.0 as the subnet mask.

 **Note:**

- 1) If you change the IP Address of LAN, you must use the new IP Address to log in to the router.
- 2) If the new LAN IP Address you set is not in the same subnet with the previous one, the IP Address pool of the DHCP server will change accordingly at the same time, while the Virtual Server and DMZ Host will not take effect until they are re-configured.

4.4.3 MAC Clone

Choose menu “**Network** → **MAC Clone**”, and then you can configure the MAC address of the WAN on the screen below, Figure 4-11:

Figure 4-11 MAC Address Clone

Some ISPs require that you register the MAC address of your adapter. Changes are rarely needed here.

- **WAN MAC Address** - This field displays the current MAC address of the Internet port. If your ISP requires you to register the MAC address, please enter the correct MAC address into this field in XX-XX-XX-XX-XX-XX format (X is any hexadecimal digit).
- **Your PC's MAC Address** - This field displays the MAC address of the PC that is managing the router. If the MAC address is required, you can click the **Clone MAC Address** button and this MAC address will fill in the **WAN MAC Address** field.

Click **Restore Factory MAC** to restore the MAC address of Internet port to the factory default value.

Click the **Save** button to save your settings.

 **Note:**

Only the PC on your LAN can use the **MAC Address Clone** function.

4.5 Dual Band Selection

Choose menu “**Dual Band Selection**”, and you can choose the working frequency for your router. It is recommended that your computers and devices running video and voice applications use the 5GHz band, while your guest access and computers that are only browsing the web use the 2.4GHz band.

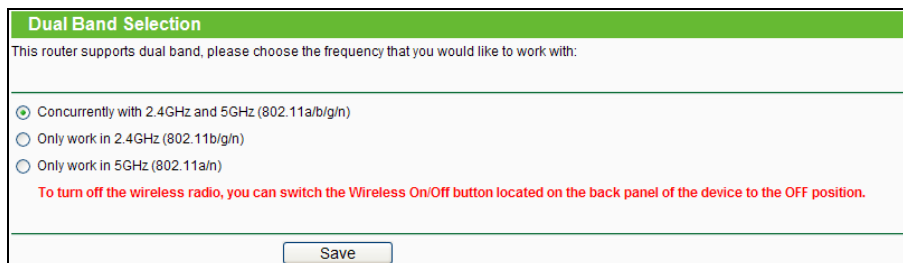

Dual Band Selection

This router supports dual band, please choose the frequency that you would like to work with:

Concurrently with 2.4GHz and 5GHz (802.11a/b/g/n)

Only work in 2.4GHz (802.11b/g/n)

Only work in 5GHz (802.11a/n)

To turn off the wireless radio, you can switch the Wireless On/Off button located on the back panel of the device to the OFF position.

Save

Figure 4-12 Dual Band Selection

➤ **Advantages of 5GHz:**

The 5GHz band is less likely to be congested. The 2.4GHz frequency range is much more prone to interference, as it is commonly used by other wireless networks in the area, as well as cordless phones, garage door openers and other home appliances and consumer products.

➤ **Disadvantages of 5GHz:**

In general, the higher the frequency of a wireless signal is, the shorter its range. Thus, 2.4GHz networks cover a substantially larger range than 5GHz wireless networks. In particular, the higher frequency wireless signals of 5GHz networks do not penetrate solid objects nearly as well as 2.4GHz signals, limiting their reach inside homes.

4.6 Wireless 2.4GHz

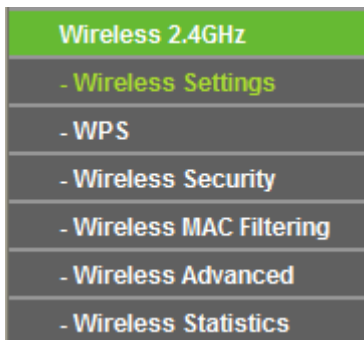

Figure 4-13 Wireless 2.4GHz menu

There are six submenus under the Wireless menu (shown in Figure 4-13): **Wireless Settings**, **WPS**, **Wireless Security**, **Wireless MAC Filtering**, **Wireless Advanced** and **Wireless Statistics**. Click any of them, and you will be able to configure the corresponding function.

4.6.1 Wireless Settings

Choose menu “**Wireless 2.4GHz** → **Wireless Settings**”, and then you can configure the basic settings for the wireless network of 2.4GHz on this page.

 A configuration page titled 'Wireless Settings (2.4GHz)'. It contains the following fields:

- Wireless Network Name:** A text input field containing 'abc' with a note '(Also called the SSID)'.
- Region:** A dropdown menu set to 'United States'.
- Warning:** A text block stating 'Ensure you select a correct country to conform local law. Incorrect settings may cause interference.'
- Mode:** A dropdown menu set to '11bgn mixed'.
- Channel Width:** A dropdown menu set to 'Auto'.
- Channel:** A dropdown menu set to 'Auto'.
- Enable SSID Broadcast:** A checked checkbox.
- Save:** A button at the bottom.

Figure 4-14 Wireless Settings – 2.4GHz

- **Wireless Network Name** - Also called the SSID (Service Set Identification). Enter a value of up to 32 characters. The same name must be assigned to all wireless devices in your network. Considering your wireless network security, the default SSID is set to be TP-LINK_2.4GHz_XXXXXX. This value is case-sensitive. For example, *TEST* is NOT the same as *test*.
- **Region** - Select your region from the drop-down list. This field specifies the region where the wireless function of the router can be used. It may be illegal to use the wireless function of

the router in a region other than one of those specified in this field. If your country or region is not listed, please contact your local government agency for assistance.

When you select your local region from the drop-down list, click the **Save** button, then the Note Dialog appears. Click **OK**.

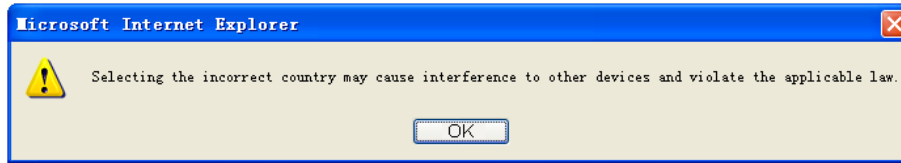

Note Dialog

Note:

Limited by local law regulations, version for North America does not have region selection option.

- **Mode** - Select the desired mode.
 - **11b only/11g only/11n only** - Select the corresponding mode if you are using 802.11b, 802.11g or 802.11n wireless clients only.
 - **11bg mixed** - Select this mode if you are using both 802.11b and 802.11g wireless clients.
 - **11bgn mixed** - Select this mode if you are using a mix of 802.11b, 11g, and 11n wireless clients. It is strongly recommended that you set the Mode to **802.11bgn mixed**, so that all of 802.11b, 802.11g, and 802.11n wireless stations can connect to the router.
- **Channel Width** - Select the channel width from the drop-down list. The default setting is **Auto**, which can adjust the channel width for your clients automatically.

Note:

If **11b only**, **11g only** or **11bg mixed** is selected in the **Mode** field, the **Channel Width** selecting field will turn grey and the value will become 20M, which is unable to be changed.

- **Channel** - This field determines which operating frequency will be used. The default channel is set to **Auto**, so the AP will choose the best channel automatically. It is not necessary to change the wireless channel unless you notice interference problems with another nearby access point.
- **Enable SSID Broadcast** - When wireless clients survey the local area for wireless networks to associate with, they will detect the SSID broadcast by the router. If you select the **Enable SSID Broadcast** checkbox, the Wireless router will broadcast its name (SSID) on the air.

4.6.2 WPS

Choose menu “**Wireless 2.4GHz** → **WPS**”, and then you can see the screen as shown in Figure 4-15. This section will guide you to add your client device to an existing network quickly by WPS (Wi-Fi Protected Setup) function.

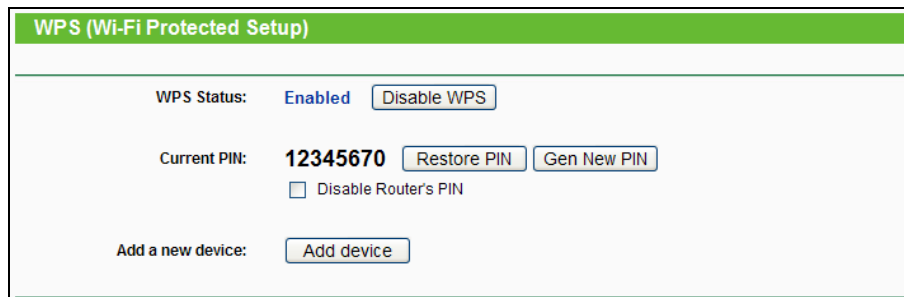

Figure 4-15 WPS

- **WPS Status** - Enable or disable the WPS function here.
- **Current PIN** - The current value of the router's PIN displayed here. The default PIN of the router can be found in the label or User Guide.
- **Restore PIN** - Restore the PIN of the router to its default value.
- **Gen New PIN** - Click this button, and then you can get a new random value for the router's PIN. You can ensure the network security by generating a new PIN.
- **Disable Router's PIN** - If this box is checked, wireless clients will not be able to connect to the wireless network by using PIN code.
- **Add device** - You can add a new device to the existing network manually by clicking this button.

If your client device supports Wi-Fi Protected Setup (WPS), you can establish a wireless connection between your client device and the router using either Push Button Configuration (PBC) method or PIN method.

Note:

To build a successful connection by WPS, you should also do the corresponding configuration of the new device for WPS function meanwhile.

I. Use the WPS Button

Use this method if your client device has a WPS (Wi-Fi Protected Setup) button.

Step 1: Press the RESET/WPS button on the side panel of the router, as shown in Figure 4-16.

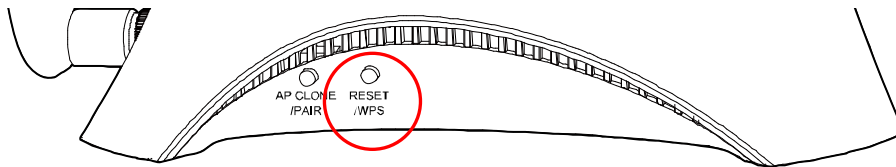

Figure 4-16

Or you can keep the default WPS status as **Enabled** and click the **Add device** button in Figure 4-15. Then choose “**Press the button of the new device in two minutes**” and click **Connect**, shown in Figure 4-17.

Add A New Device

Enter the new device's PIN.
PIN:

Press the button of the new device in two minutes.

Figure 4-17 Add A New Device

Step 2: Press and hold the WPS button of the client device directly.

Step 3: The WPS LED blinks for two minutes during the Wi-Fi Protected Setup process.

Step 4: When the WPS LED is on, the client device has successfully connected to the router.

Step 5: Refer back to your client device or its documentation for further instructions.

II. Enter the client device's PIN on the router

Use this method if your client device does not have the WPS button, but has a Wi-Fi Protected Setup PIN number.

Step 1: Keep the default WPS status as **Enabled** and click the **Add device** button in Figure 4-15, then Figure 4-18 will appear.

Add A New Device

Enter the new device's PIN.
PIN:

Press the button of the new device in two minutes.

Figure 4-18 Add A New Device

Step 2: Enter the PIN number from the client device in the field on the above WPS screen. Then click **Connect** button.

Step 3: “Connecting succeeded!” will appear on the screen of Figure 4-18, which means the client device has successfully connected to the router.

III. Enter the router’s PIN on your client device

Use this method if your client device asks for the router’s PIN number.

Step 1: On the client device, enter the PIN number listed on the router’s Wi-Fi Protected Setup screen, shown in Figure 4-15 (It is also labeled on the bottom of the router).

Step 2: The WPS LED blinks for two minutes during the Wi-Fi Protected Setup process.

Step 3: When the WPS LED is on, the client device has successfully connected to the router.

Step 4: Refer back to your client device or its documentation for further instructions.

Note:

- 1) The WPS LED on the router will light on for five minutes if the device has been successfully added to the network.
- 2) The WPS function cannot be configured if the Wireless Function of the router is disabled. Please make sure the Wireless Function is enabled before configuring the WPS.

4.6.3 Wireless Security

Choose menu “**Wireless 2.4GHz** → **Wireless Security**”, and then you can configure the security settings of your wireless network.

There are five wireless security modes supported by the router: WPA-Personal, WPA2-Personal, WPA-Enterprise, WPA2-Enterprise, and WEP.

Figure 4-19 Wireless Security

- **Disable Security** - If you do not want to use wireless security, check this radio button. But it's strongly recommended to choose one of the following modes to enable security.
- **WPA/WPA2-Personal** - It's the WPA/WPA2 authentication type based on pre-shared passphrase. The router is configured by this security type by default.
 - **Version** - you can choose the version of the WPA-PSK security on the drop-down list. The default setting is **Automatic**, which can select **WPA-PSK** (Pre-shared key of WPA) or **WPA2-PSK** (Pre-shared key of WPA2) automatically based on the wireless station's capability and request.
 - **Encryption** - When **WPA-PSK** or **WPA** is set as the Authentication Type, you can select either **Automatic**, or **TKIP** or **AES** as Encryption.

 **Note:**

If you check the **WPA/WPA2-Personal** radio button and choose TKIP encryption, you will find a notice in red as shown in Figure 4-20.

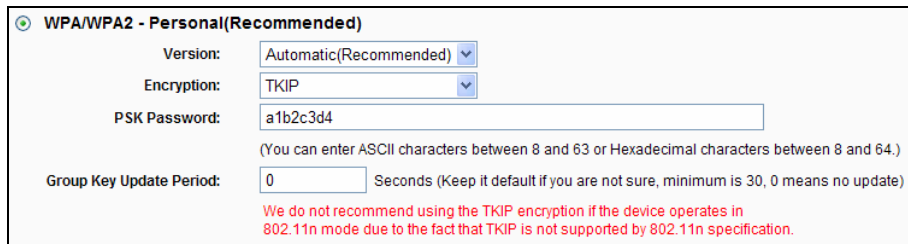

Figure 4-20 WPA/WPA2 – Personal

- **PSK Password** - You can enter 8 to 63 ASCII characters or 8 to 64 Hexadecimal characters. The default password is the same with the default PIN code, which is labeled on the bottom of the router or can be found in Figure 4-15.
 - **Group Key Update Period** - Specify the group key update interval in seconds. The value should be 30 or above. Enter 0 to disable the update.
- **WPA/WPA2- Enterprise** - It's based on Radius Server.
- **Version** - you can choose the version of the WPA security on the drop-down list. The default setting is **Automatic**, which can select **WPA** (Wi-Fi Protected Access) or **WPA2** (WPA version 2) automatically based on the wireless station's capability and request.
 - **Encryption** - You can select either **Automatic**, or **TKIP** or **AES**.

 **Note:**

If you check the **WPA/WPA2-Enterprise** radio button and choose TKIP encryption, you will find a notice in red as shown in Figure 4-21.

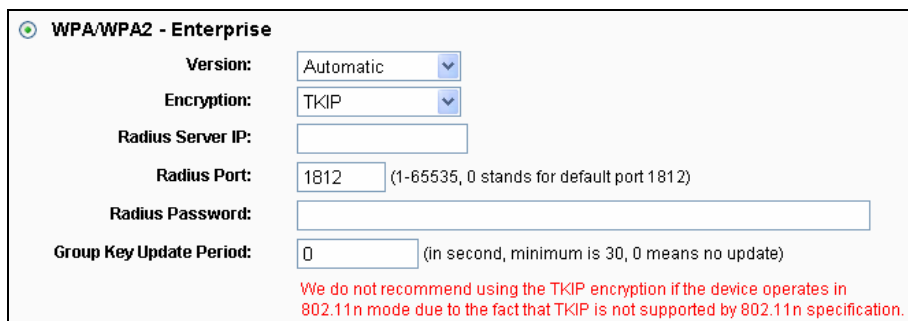
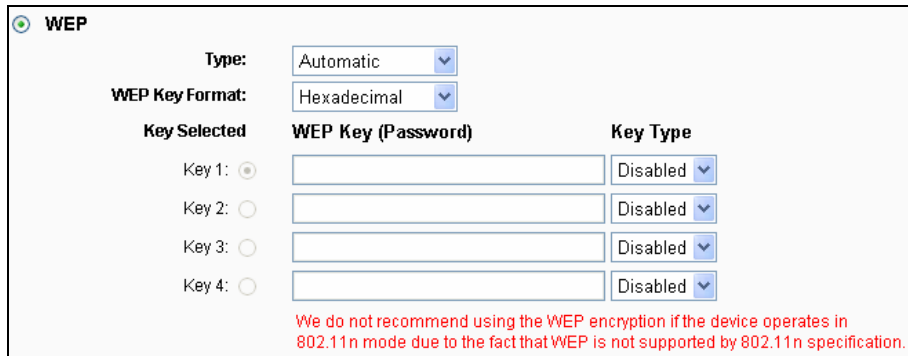

Figure 4-21 WPA/WPA2 - Enterprise

- **Radius Server IP** - Enter the IP address of the Radius server.
 - **Radius Port** - Enter the port number of the Radius server.
 - **Radius Password** - Enter the password for the Radius server.
 - **Group Key Update Period** - Specify the group key update interval in seconds. The value should be 30 or above. Enter 0 to disable the update.
- **WEP** - It is based on the IEEE 802.11 standard. If you check this radio button, you will find a notice in red as show in Figure 4-22.



WEP

Type: Automatic

WEP Key Format: Hexadecimal

Key Selected	WEP Key (Password)	Key Type
Key 1: <input checked="" type="radio"/>		Disabled
Key 2: <input type="radio"/>		Disabled
Key 3: <input type="radio"/>		Disabled
Key 4: <input type="radio"/>		Disabled

We do not recommend using the WEP encryption if the device operates in 802.11n mode due to the fact that WEP is not supported by 802.11n specification.

Figure 4-22 WEP

- **Type** - you can choose the type for the WEP security on the drop-down list. The default setting is **Automatic**, which can select **Shared Key** or **Open System** authentication type automatically based on the wireless station's capability and request.
- **WEP Key Format** - **Hexadecimal** and **ASCII** formats are provided here. **Hexadecimal** format stands for any combination of hexadecimal digits (0-9, a-f, A-F) in the specified length. **ASCII** format stands for any combination of keyboard characters in the specified length.
- **WEP Key** - Select which of the four keys will be used and enter the matching WEP key that you create. Make sure these values are identical on all wireless stations in your network.
- **Key Type** - You can select the WEP key length (64-bit, or 128-bit.) for encryption. "Disabled" means this WEP key entry is invalid.

64-bit - You can enter 10 hexadecimal digits (any combination of 0-9, a-f, A-F, zero key is not promoted) or 5 ASCII characters.

128-bit - You can enter 26 hexadecimal digits (any combination of 0-9, a-f, A-F, zero key is not promoted) or 13 ASCII characters.

Note:

If you do not set the key, the wireless security function is still disabled even if you have selected Shared Key as Authentication Type.

Be sure to click the **Save** button to save your settings on this page.

4.6.4 Wireless MAC Filtering

Choose menu "**Wireless 2.4GHz** → **Wireless MAC Filtering**", and then you can control the wireless access by configuring the **Wireless MAC Filtering** function, shown in Figure 4-23.

Wireless MAC Filtering

Wireless MAC Filtering: **Disabled**

Filtering Rules

Deny the stations specified by any enabled entries in the list to access.
 Allow the stations specified by any enabled entries in the list to access.

ID	MAC Address	Status	Description	Modify
1	00-0A-EB-B0-00-0B	Enabled	Wireless station A	Modify Delete

Figure 4-23 Wireless MAC Filtering

- **Wireless MAC Filtering** - Enable or disable wireless MAC filtering. To filter wireless users by MAC Address, click **Enable**. The default setting is **Disabled**.
- **MAC Address** - The wireless station's MAC address that you want to filter.
- **Status** - The status of this entry, either **Enabled** or **Disabled**.
- **Description** - A simple description of the wireless station.

To Add a Wireless MAC Address filtering entry, click the **Add New...** button. The "**Add or Modify Wireless MAC Address Filtering entry**" page will appear, shown in Figure 4-24:

Add or Modify Wireless MAC Address Filtering entry

MAC Address:

Description:

Status:

Figure 4-24 Add or Modify Wireless MAC Address Filtering entry

To add or modify a MAC Address Filtering entry, follow these instructions:

1. Enter the appropriate MAC Address into the **MAC Address** field. The format of the MAC Address is XX-XX-XX-XX-XX-XX (X is any hexadecimal digit). For example: 00-0A-EB-B0-00-0B.
2. Give a simple description for the wireless station in the **Description** field. For example: Wireless station A.
3. Select **Enabled** or **Disabled** for this entry on the **Status** drop-down list.
4. Click the **Save** button to save this entry.

To modify or delete an existing entry:

1. Click the **Modify** in the entry you want to modify. If you want to delete the entry, click the **Delete**.

2. Modify the information.
3. Click the **Save** button.

Click the **Enable All** button to make all entries enabled

Click the **Disabled All** button to make all entries disabled.

Click the **Delete All** button to delete all entries.

Click the **Next** button to go to the next page.

Click the **Previous** button to return to the previous page.

For example: If you desire that the wireless station A with MAC address 00-0A-EB-B0-00-0B and the wireless station B with MAC address 00-0A-EB-00-07-5F are able to access the router, but all the other wireless stations cannot access the router, you can configure the **Wireless MAC Address Filtering** list by following these steps:

1. Click the **Enable** button to enable this function.
2. Select the radio button "**Allow the entries specified by any enabled entries in the list to access**" for **Filtering Rules**.
3. Delete all or disable all entries if there are any entries already.
4. Click the **Add New...** button.
 - 1) Enter the MAC address 00-0A-EB-B0-00-0B/00-0A-EB-00-07-5F in the **MAC Address** field.
 - 2) Enter wireless station A/B in the **Description** field.
 - 3) Select **Enabled** in the **Status** drop-down list.
 - 4) Click the **Save** button.
 - 5) Click the **Back** button.

The filtering rules that configured should be similar to the following list:

Filtering Rules				
<input type="radio"/> Deny the stations specified by any enabled entries in the list to access.				
<input checked="" type="radio"/> Allow the stations specified by any enabled entries in the list to access.				
ID	MAC Address	Status	Description	Modify
1	00-0A-EB-B0-00-0B	Enabled	wireless station A	Modify Delete
2	00-0A-EB-00-07-5F	Enabled	wireless station B	Modify Delete

4.6.5 Wireless Advanced

Choose menu "**Wireless 2.4GHz → Wireless Advanced**", and then you can configure the advanced settings of your wireless network.

Figure 4-25 Wireless Advanced

- **Transmit Power** - Here you can specify the transmit power of router. You can select High, Middle or Low which you would like. High is the default setting and is recommended.
- **Beacon Interval** - Enter a value between 40 and 1000 milliseconds for Beacon Interval here. The beacons are the packets sent by the router to synchronize a wireless network. Beacon Interval value determines the time interval of the beacons. The default value is 100.
- **RTS Threshold** - Here you can specify the RTS (Request to Send) Threshold. If the packet is larger than the specified RTS Threshold size, the router will send RTS frames to a particular receiving station and negotiate the sending of a data frame. The default value is 2346.
- **Fragmentation Threshold** - This value is the maximum size determining whether packets will be fragmented. Setting the Fragmentation Threshold too low may result in poor network performance because of excessive packets. 2346 is the default setting and is recommended. (This value cannot be changed when 11N-series wireless mode is used.)
- **DTIM Interval** - This value determines the interval of the Delivery Traffic Indication Message (DTIM). A DTIM field is a countdown field informing clients of the next window for listening to broadcast and multicast messages. When the router has buffered broadcast or multicast messages for associated clients, it sends the next DTIM with a DTIM Interval value. You can specify the value between 1-15 Beacon Intervals. The default value is 1, which indicates the DTIM Interval is the same as Beacon Interval.
- **Enable WMM** - WMM function can guarantee the packets with high-priority messages being transmitted preferentially. It is strongly recommended.
- **Enable Short GI** - This function is recommended for it will increase the data capacity by reducing the guard interval time.
- **Enabled AP Isolation** - This function can isolate wireless stations on your network from each other. Wireless devices will be able to communicate with the router but not with each other. To use this function, check this box. AP Isolation is disabled by default.

Note:

If you are not familiar with the setting items in this page, it's strongly recommended to keep the provided default values; otherwise it may result in lower wireless network performance.

4.6.6 Wireless Statistics

Choose menu "Wireless 2.4GHz → Wireless Statistics", and then you can see the MAC Address, Current Status, Received Packets and Sent Packets for each connected wireless station.

Wireless Statistics				
Current Connected Wireless Stations numbers:		1	<input type="button" value="Refresh"/>	
ID	MAC Address	Current Status	Received Packets	Sent Packets
1	D8-31-CF-02-FA-FE	WPA2-PSK	131	88
		<input type="button" value="Previous"/>	<input type="button" value="Next"/>	

Figure 4-26 Wireless Statistics

- **MAC Address** - The connected wireless station's MAC address
- **Current Status** - The connected wireless station's running status, one of STA-AUTH/ STA-ASSOC/ STA-JOINED/ WPA/ WPA-PSK/ WPA2/ WPA2-PSK/ AP-UP/ AP-DOWN/ Disconnected
- **Received Packets** - Packets received by the station
- **Sent Packets** - Packets sent by the station

You cannot change any of the values on this page. To update this page and to show the current connected wireless stations, click the **Refresh** button.

If the numbers of connected wireless stations go beyond one page, click the **Next** button to go to the next page and click the **Previous** button to return the previous page.

Note:

This page will be refreshed automatically every 5 seconds.

4.7 Wireless 5GHz

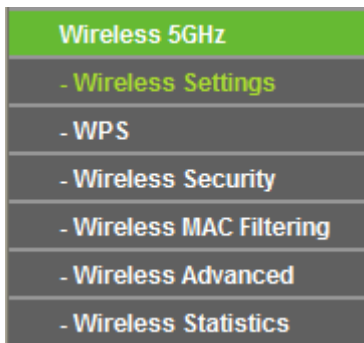

Figure 4-27 Wireless 5GHz menu

There are six submenus under the Wireless menu (shown in Figure 4-13): **Wireless Settings**, **WPS**, **Wireless Security**, **Wireless MAC Filtering**, **Wireless Advanced** and **Wireless Statistics**. Click any of them, and you will be able to configure the corresponding function.

4.7.1 Wireless Settings

Choose menu "**Wireless 5GHz** → **Wireless Settings**", and then you can configure the basic settings for the wireless network of 5GHz on this page.

 A screenshot of the "Wireless Settings (5GHz)" configuration page. The page has a green header with the title. Below the header, there are several configuration fields:

- Wireless Network Name:** A text input field containing "DEF" with a note "(Also called the SSID)".
- Region:** A dropdown menu set to "United States".
- Warning:** A text block stating "Ensure you select a correct country to conform local law. Incorrect settings may cause interference."
- Mode:** A dropdown menu set to "11an mixed".
- Channel Width:** A dropdown menu set to "Auto".
- Channel:** A dropdown menu set to "Auto".
- Enable SSID Broadcast:** A checked checkbox.

 At the bottom of the page is a "Save" button.

Figure 4-28 Wireless Settings – 5GHz

- **Wireless Network Name** - Also called the SSID (Service Set Identification). Enter a value of up to 32 characters. The same name must be assigned to all wireless devices in your network. Considering your wireless network security, the default SSID is set to be TP-LINK_5GHz_XXXXXX. This value is case-sensitive. For example, *TEST* is NOT the same as *test*.
- **Region** - Select your region from the drop-down list. This field specifies the region where the wireless function of the router can be used. It may be illegal to use the wireless function of

the router in a region other than one of those specified in this field. If your country or region is not listed, please contact your local government agency for assistance.

When you select your local region from the drop-down list, click the **Save** button, then the Note Dialog appears. Click **OK**.

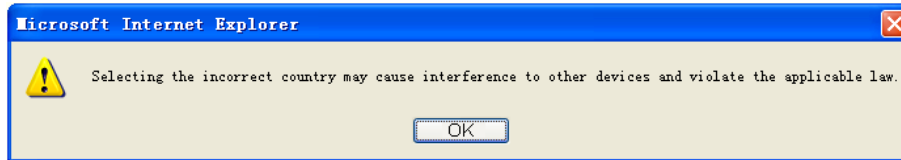

Note Dialog

 **Note:**

Limited by local law regulations, version for North America does not have region selection option.

➤ **Mode**

- **11a only/11n only** - Select the corresponding mode if you are using 802.11a or 802.11n wireless clients only.
- **11an mixed** - Select this mode if you are using both 802.11a and 802.11n wireless clients. It is strongly recommended that you set the Mode **11an mixed**, so that all of 802.11a and 802.11n wireless stations can connect to the router.

➤ **Channel Width** - Select the channel width from the drop-down list. The default setting is automatic, which can adjust the channel width for your clients automatically.

➤ **Channel** - This field determines which operating frequency will be used. The default channel is set to **Auto**, so the router will choose the best channel automatically. It is not necessary to change the wireless channel unless you notice interference problems with another nearby access point.

➤ **Enable SSID Broadcast** - When wireless clients survey the local area for wireless networks to associate with, they will detect the SSID broadcast by the router. If you select the **Enable SSID Broadcast** checkbox, the Wireless router will broadcast its name (SSID) on the air.

4.7.2 WPS

Choose menu "**Wireless 5GHz → WPS**", and then you can the screen as shown in Figure 4-29. This section will guide you to add a new wireless device to an existing network quickly by WPS (Wi-Fi Protected Setup) function.

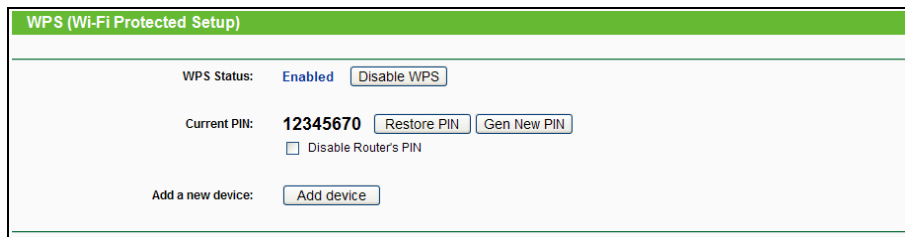

Figure 4-29 WPS

- **WPS Status** - Enable or disable the WPS function here.
- **Current PIN** - The current value of the router's PIN displayed here. The default PIN of the router can be found in the label or User Guide.
- **Restore PIN** - Restore the PIN of the router to its default.
- **Gen New PIN** - Click this button, and then you can get a new random value for the router's PIN. You can ensure the network security by generating a new PIN.
- **Disable Router's PIN** - If this box is checked, wireless clients will not be able to connect to the wireless network by using PIN code.
- **Add device** - You can add a new device to the existing network manually by clicking this button.

If your client device supports Wi-Fi Protected Setup (WPS), you can establish a wireless connection between your client device and the router using either Push Button Configuration (PBC) method or PIN method.

 **Note:**

To build a successful connection by WPS, you should also do the corresponding configuration of the new device for WPS function meanwhile.

I. Use the WPS Button

Use this method if your client device has a WPS (Wi-Fi Protected Setup) button.

Step 1: Press the RESET/WPS button on the side panel of the router, as shown in Figure 4-30.

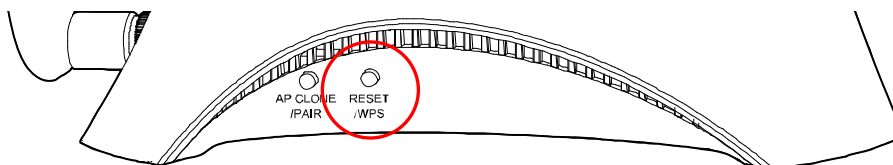

Figure 4-30

Or you can keep the default WPS status as **Enabled** and click the **Add device** button in Figure 4-29. Then choose “**Press the button of the new device in two minutes**” and click **Connect**, shown in Figure 4-31.

The screenshot shows a web interface titled "Add A New Device". It has a green header bar with the title. Below the header, there are two radio button options. The first option is "Enter the new device's PIN." with a text input field labeled "PIN:". The second option is "Press the button of the new device in two minutes." and is currently selected, indicated by a filled green circle. At the bottom of the form, there are two buttons: "Back" and "Connect".

Figure 4-31 Add A New Device

Step 2: Press and hold the WPS button of the client device directly.

Step 3: The WPS LED blinks for two minutes during the Wi-Fi Protected Setup process.

Step 4: When the WPS LED is solid on, the client device has successfully connected to the router.

Step 5: Refer back to your client device or its documentation for further instructions.

II. Enter the client device's PIN on the router

Use this method if your client device does not have the WPS button, but has a Wi-Fi Protected Setup PIN number.

Step 1: Keep the default WPS status as **Enabled** and click the **Add device** button in Figure 4-29, then Figure 4-32 will appear.

The screenshot shows the same "Add A New Device" web interface. In this version, the first option "Enter the new device's PIN." is selected, indicated by a filled green circle. The "PIN:" text input field is present but empty. The second option "Press the button of the new device in two minutes." is unselected. The "Back" and "Connect" buttons are still at the bottom.

Figure 4-32 Add A New Device

Step 2: Enter the PIN number from the client device in the field on the above WPS screen. Then click **Connect** button.

Step 3: "**Connecting succeeded!**" will appear on the screen of Figure 4-32, which means the client device has successfully connected to the router.

III. Enter the router's PIN on your client device

Use this method if your client device asks for the router's PIN number.

Step 1: On the client device, enter the PIN number listed on the router's Wi-Fi Protected Setup screen, shown in Figure 4-29 (It is also labeled on the bottom of the router).

Step 2: The WPS LED blinks for two minutes during the Wi-Fi Protected Setup process.

Step 3: When the WPS LED is on, the client device has successfully connected to the router.

Step 4: Refer back to your client device or its documentation for further instructions.

Note:

- 1) The WPS LED on the router will light on for five minutes if the device has been successfully added to the network.
- 2) The WPS function cannot be configured if the Wireless Function of the router is disabled. Please make sure the Wireless Function is enabled before configuring the WPS.

4.7.3 Wireless Security

Choose menu “**Wireless 5GHz** → **Wireless Security**”, and then you can configure the security settings of your wireless network.

There are five wireless security modes supported by the router: WPA-Personal, WPA2-Personal, WPA-Enterprise, WPA2-Enterprise, and WEP.

Figure 4-33 Wireless Security

- **Disable Security** - If you do not want to use wireless security, check this radio button. But it's strongly recommended to choose one of the following modes to enable security.
- **WPA/WPA2-Personal** - It's the WPA/WPA2 authentication type based on pre-shared passphrase. The router is configured by this security type by default.

- **Version** - you can choose the version of the WPA-PSK security on the drop-down list. The default setting is **Automatic**, which can select **WPA-PSK** (Pre-shared key of WPA) or **WPA2-PSK** (Pre-shared key of WPA) automatically based on the wireless station's capability and request.
- **Encryption** - When **WPA-PSK** or **WPA** is set as the Authentication Type, you can select either **Automatic**, or **TKIP** or **AES** as Encryption.

 **Note:**

If you check the **WPA/WPA2-Personal** radio button and choose TKIP encryption, you will find a notice in red as shown in Figure 4-34.

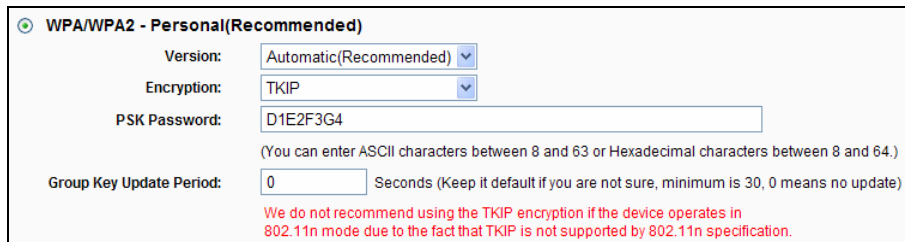

WPA/WPA2 - Personal(Recommended)

Version: Automatic(Recommended) ▼

Encryption: TKIP ▼

PSK Password: D1E2F3G4
(You can enter ASCII characters between 8 and 63 or Hexadecimal characters between 8 and 64.)

Group Key Update Period: 0 Seconds (Keep it default if you are not sure, minimum is 30, 0 means no update)

We do not recommend using the TKIP encryption if the device operates in 802.11n mode due to the fact that TKIP is not supported by 802.11n specification.

Figure 4-34 WPA/WPA2 – Personal

- **PSK Password** - You can enter 8 to 63 ASCII characters or 8 to 64 Hexadecimal characters. The default password is the same with the default PIN code, which is labeled on the bottom of the router or can be found in Figure 4-29.
 - **Group Key Update Period** - Specify the group key update interval in seconds. The value should be 30 or above. Enter 0 to disable the update.
- **WPA /WPA2- Enterprise** - It's based on Radius Server.
- **Version** - you can choose the version of the WPA security on the drop-down list. The default setting is **Automatic**, which can select **WPA** (Wi-Fi Protected Access) or **WPA2** (WPA version 2) automatically based on the wireless station's capability and request.
 - **Encryption** - You can select either **Automatic**, or **TKIP** or **AES**.

 **Note:**

If you check the **WPA/WPA2-Enterprise** radio button and choose TKIP encryption, you will find a notice in red as shown in Figure 4-35.

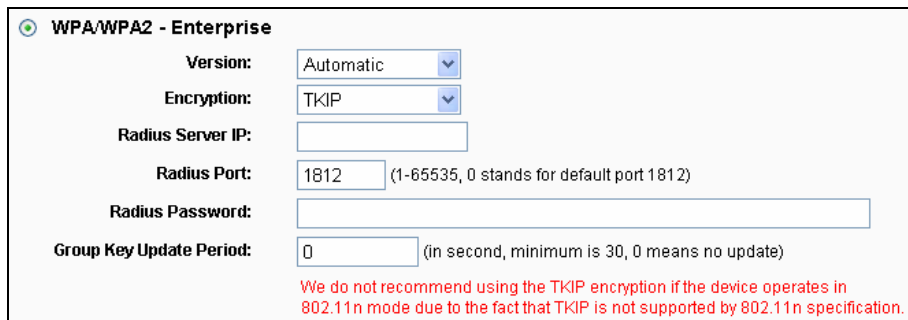

WPA/WPA2 - Enterprise

Version: Automatic

Encryption: TKIP

Radius Server IP:

Radius Port: 1812 (1-65535, 0 stands for default port 1812)

Radius Password:

Group Key Update Period: 0 (in second, minimum is 30, 0 means no update)

We do not recommend using the TKIP encryption if the device operates in 802.11n mode due to the fact that TKIP is not supported by 802.11n specification.

Figure 4-35 WPA/WPA2 - Enterprise

- **Radius Server IP** - Enter the IP address of the Radius server.
 - **Radius Port** - Enter the port number of the Radius server.
 - **Radius Password** - Enter the password for the Radius server.
 - **Group Key Update Period** - Specify the group key update interval in seconds. The value should be 30 or above. Enter 0 to disable the update.
- **WEP** - It is based on the IEEE 802.11 standard. If you check this radio button, you will find a notice in red as show in Figure 4-36.

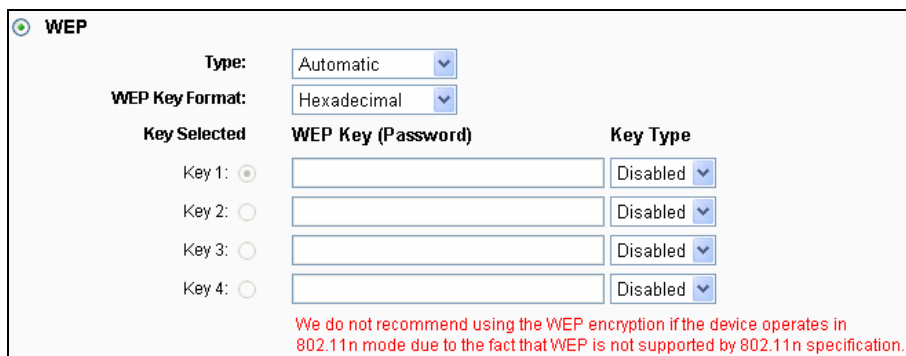

WEP

Type: Automatic

WEP Key Format: Hexadecimal

Key Selected	WEP Key (Password)	Key Type
Key 1: <input checked="" type="radio"/>	<input type="text"/>	Disabled
Key 2: <input type="radio"/>	<input type="text"/>	Disabled
Key 3: <input type="radio"/>	<input type="text"/>	Disabled
Key 4: <input type="radio"/>	<input type="text"/>	Disabled

We do not recommend using the WEP encryption if the device operates in 802.11n mode due to the fact that WEP is not supported by 802.11n specification.

Figure 4-36 WEP

- **Type** - you can choose the type for the WEP security on the drop-down list. The default setting is **Automatic**, which can select **Shared Key** or **Open System** authentication type automatically based on the wireless station's capability and request.
- **WEP Key Format** - **Hexadecimal** and **ASCII** formats are provided here. **Hexadecimal** format stands for any combination of hexadecimal digits (0-9, a-f, A-F) in the specified length. **ASCII** format stands for any combination of keyboard characters in the specified length.
- **WEP Key** - Select which of the four keys will be used and enter the matching WEP key that you create. Make sure these values are identical on all wireless stations in your network.

- **Key Type** - You can select the WEP key length (64-bit, or 128-bit.) for encryption. "Disabled" means this WEP key entry is invalid.

64-bit - You can enter 10 hexadecimal digits (any combination of 0-9, a-f, A-F, zero key is not promoted) or 5 ASCII characters.

128-bit - You can enter 26 hexadecimal digits (any combination of 0-9, a-f, A-F, zero key is not promoted) or 13 ASCII characters.

 **Note:**

If you do not set the key, the wireless security function is still disabled even if you have selected Shared Key as Authentication Type.

Be sure to click the **Save** button to save your settings on this page.

4.7.4 Wireless MAC Filtering

Choose menu "**Wireless** → **MAC Filtering**", and then you can control the wireless access by configuring the **Wireless MAC Filtering** function, shown in Figure 4-23.

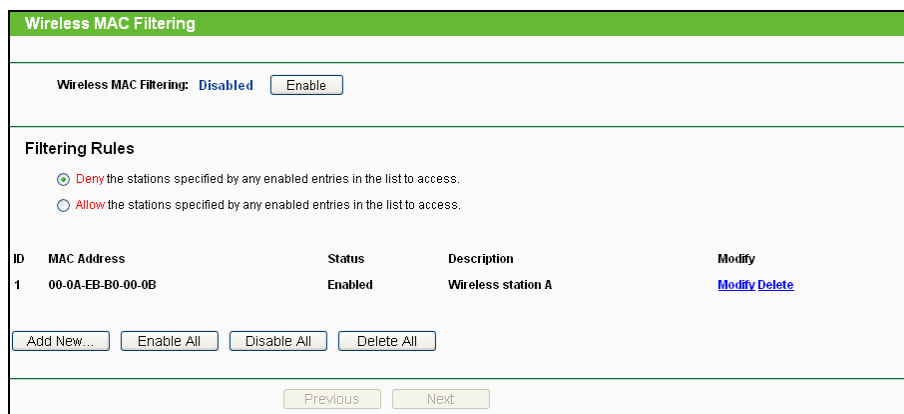

ID	MAC Address	Status	Description	Modify
1	00-0A-EB-B0-00-0B	Enabled	Wireless station A	Modify Delete

Figure 4-37 Wireless MAC Filtering

- **Wireless MAC Filtering** - Enable or disable wireless MAC filtering. To filter wireless users by MAC Address, click **Enable**. The default setting is **Disabled**.
- **MAC Address** - The wireless station's MAC address that you want to filter.
- **Status** - The status of this entry, either **Enabled** or **Disabled**.
- **Description** - A simple description of the wireless station.

To Add a Wireless MAC Address filtering entry, click the **Add New...** button. The "**Add or Modify Wireless MAC Address Filtering entry**" page will appear, shown in Figure 4-24:

Figure 4-38 Add or Modify Wireless MAC Address Filtering entry

To add or modify a MAC Address Filtering entry, follow these instructions:

1. Enter the appropriate MAC Address into the **MAC Address** field. The format of the MAC Address is XX-XX-XX-XX-XX-XX (X is any hexadecimal digit). For example: 00-0A-EB-B0-00-0B.
2. Give a simple description for the wireless station in the **Description** field. For example: Wireless station A.
3. Select **Enabled** or **Disabled** for this entry on the **Status** drop-down list.
4. Click the **Save** button to save this entry.

To modify or delete an existing entry:

1. Click the **Modify** in the entry you want to modify. If you want to delete the entry, click the **Delete**.
2. Modify the information.
3. Click the **Save** button.

Click the **Enable All** button to make all entries enabled

Click the **Disabled All** button to make all entries disabled.

Click the **Delete All** button to delete all entries.

Click the **Next** button to go to the next page.

Click the **Previous** button to return to the previous page.

For example: If you desire that the wireless station A with MAC address 00-0A-EB-B0-00-0B and the wireless station B with MAC address 00-0A-EB-00-07-5F are able to access the router, but all the other wireless stations cannot access the router, you can configure the **Wireless MAC Address Filtering** list by following these steps:

1. Click the **Enable** button to enable this function.
2. Select the radio button "**Allow the entries specified by any enabled entries in the list to access**" for **Filtering Rules**.
3. Delete all or disable all entries if there are any entries already.
4. Click the **Add New...** button.

5. Enter the MAC address 00-0A-EB-B0-00-0B/00-0A-EB-00-07-5F in the **MAC Address** field.
6. Enter wireless station A/B in the **Description** field.
7. Select **Enabled** in the **Status** drop-down list.
8. Click the **Save** button.
9. Click the **Back** button.

The filtering rules that configured should be similar to the following list:

Filtering Rules				
<input type="radio"/> Deny the stations specified by any enabled entries in the list to access.				
<input checked="" type="radio"/> Allow the stations specified by any enabled entries in the list to access.				
ID	MAC Address	Status	Description	Modify
1	00-0A-EB-B0-00-0B	Enabled	wireless station A	Modify Delete
2	00-0A-EB-00-07-5F	Enabled	wireless station B	Modify Delete

4.7.5 Wireless Advanced

Choose menu “**Wireless → Wireless Advanced**”, and then you can configure the advanced settings of your wireless network.

Wireless Advanced

Transmit Power:	High	▼	
Beacon Interval :	100	(40-1000)	
RTS Threshold:	2346	(1-2346)	
Fragmentation Threshold:	2346	(256-2346)	
DTIM Interval:	1	(1-15)	
<input checked="" type="checkbox"/> Enable WMM <input checked="" type="checkbox"/> Enable Short GI <input type="checkbox"/> Enable AP Isolation			
<input type="button" value="Save"/>			

Figure 4-39 Wireless Advanced

- **Transmit Power** - Here you can specify the transmit power of router. You can select High, Middle or Low which you would like. High is the default setting and is recommended.
- **Beacon Interval** - Enter a value between 40 and 1000 milliseconds for Beacon Interval here. The beacons are the packets sent by the router to synchronize a wireless network. Beacon Interval value determines the time interval of the beacons. The default value is 100.
- **RTS Threshold** - Here you can specify the RTS (Request to Send) Threshold. If the packet is larger than the specified RTS Threshold size, the router will send RTS frames to a particular receiving station and negotiate the sending of a data frame. The default value is 2346.
- **Fragmentation Threshold** - This value is the maximum size determining whether packets will be fragmented. Setting the Fragmentation Threshold too low may result in poor network

performance because of excessive packets. 2346 is the default setting and is recommended. (This value cannot be changed when 11N-series wireless mode is used.)

- **DTIM Interval** - This value determines the interval of the Delivery Traffic Indication Message (DTIM). A DTIM field is a countdown field informing clients of the next window for listening to broadcast and multicast messages. When the router has buffered broadcast or multicast messages for associated clients, it sends the next DTIM with a DTIM Interval value. You can specify the value between 1-15 Beacon Intervals. The default value is 1, which indicates the DTIM Interval is the same as Beacon Interval.
- **Enable WMM - WMM** function can guarantee the packets with high-priority messages being transmitted preferentially. It is strongly recommended.
- **Enable Short GI** - This function is recommended for it will increase the data capacity by reducing the guard interval time.
- **Enabled AP Isolation** - This function can isolate wireless stations on your network from each other. Wireless devices will be able to communicate with the router but not with each other. To use this function, check this box. AP Isolation is disabled by default.

 **Note:**

If you are not familiar with the setting items in this page, it's strongly recommended to keep the provided default values; otherwise it may result in lower wireless network performance.

4.7.6 Wireless Statistics

Choose menu “**Wireless** → **Wireless Statistics**”, and then you can see the MAC Address, Current Status, Received Packets and Sent Packets for each connected wireless station.

Wireless Statistics				
Current Connected Wireless Stations numbers: 1 <input type="button" value="Refresh"/>				
ID	MAC Address	Current Status	Received Packets	Sent Packets
1	E8-99-C4-E1-E9-B8	WPA2-PSK	384	136
<input type="button" value="Previous"/> <input type="button" value="Next"/>				

Figure 4-40 Wireless Statistics

- **MAC Address** - The connected wireless station's MAC address
- **Current Status** - The connected wireless station's running status, one of **STA-AUTH/ STA-ASSOC/ STA-JOINED/ WPA/ WPA-PSK/ WPA2/ WPA2-PSK/ AP-UP/ AP-DOWN/ Disconnected**
- **Received Packets** - Packets received by the station
- **Sent Packets** - Packets sent by the station

You cannot change any of the values on this page. To update this page and to show the current connected wireless stations, click the **Refresh** button.

If the numbers of connected wireless stations go beyond one page, click the **Next** button to go to the next page and click the **Previous** button to return the previous page.

 **Note:**

This page will be refreshed automatically every 5 seconds.

4.8 Powerline

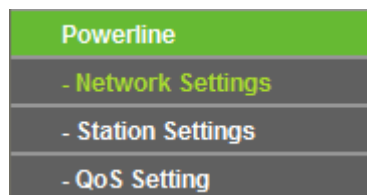
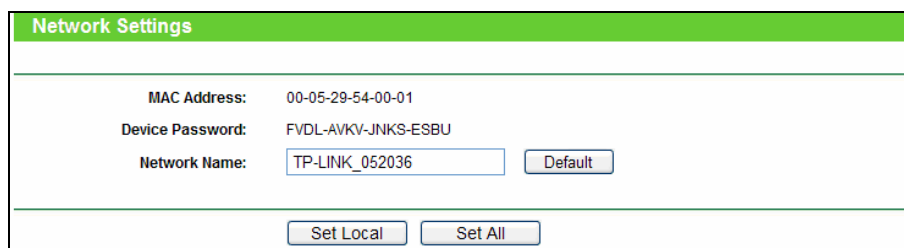

Figure 4-41 Powerline menu

There are three submenus under the Powerline menu (shown in Figure 4-41): **Network Settings**, **Station Settings** and **QoS Setting**. Click any of them, and you will be able to configure the corresponding function.

4.8.1 Network Settings

Choose menu "**Powerline** → **Network Settings**", and you can configure the network name of the router or all the stations in current network on this page.

 A screenshot of a web interface titled "Network Settings". It has a green header bar. Below the header, there are three rows of settings:

- MAC Address: 00-05-29-54-00-01
- Device Password: FVDL-AVKV-JNKS-ESBU
- Network Name: TP-LINK_052036 (with a "Default" button next to it)

 At the bottom of the form, there are two buttons: "Set Local" and "Set All".

Figure 4-42 Network Settings

- **MAC Address** - The powerline physical address of the router. The value can not be changed.
- **Device Password** - The device password of the router. The value can not be changed.
- **Network Name** - Enter the network name (default: **HomePlugAV**).

Click the **Default** button to restore the default network name.

Click the **Set Local** button to set the network name for only the router.

Click the **Set All** button to set the network names for the router and all current network stations whose passwords have been correctly entered.

Note:

Clicking the **Set Local** button will make all current network stations leave the router's network since the router's network name changes but the stations' network name remains unchanged.

Clicking the **Set All** button will not change the network names for the stations that are powered off or those whose passwords haven't been correctly entered in the **Station Settings** page.

4.8.2 Station Settings

Choose menu "**Powerline** → **Station Settings**", and you can view remote stations in the current network and enter, modify or delete their passwords and names on this page.

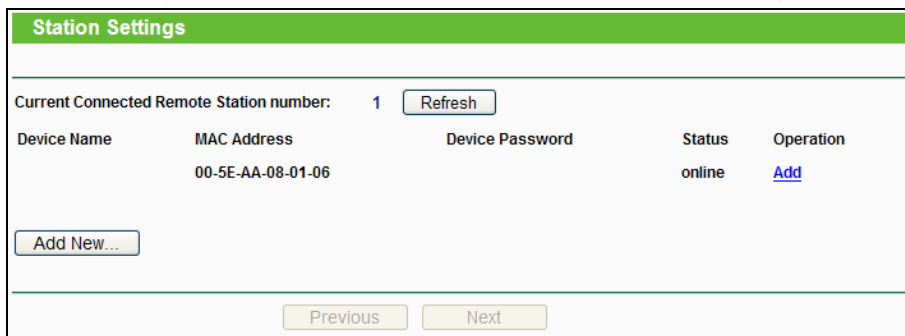

Figure 4-43 Station Settings

- **MAC Address** - The remote station's MAC address. The value can not be changed.
- **Device Password** - The security ID of remote station.
- **Device Name** - The name used for identifying a station.

To add or modify a station entry, click the **Add** or **Modify** button in the **Operation** column and follow these instructions:

1. Enter the station password in **Device Password** field. The password is in XXXX-XXXX-XXXX-XXXX format. For example, GQAG-URPZ-NOKG-HIXV.
2. Enter a name you want to give the station in the **Device Name** field or leave it empty. For example, Station A.
3. Click the **Save** button to save this entry.

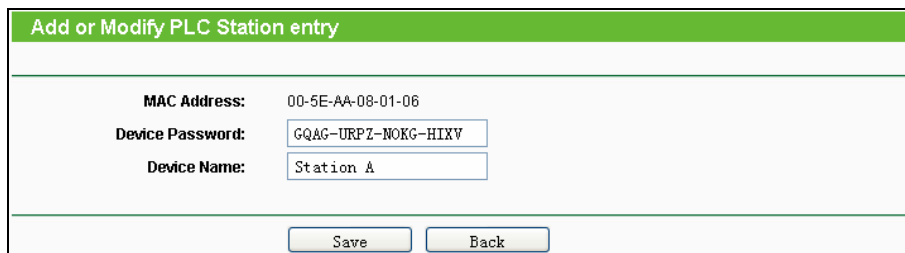
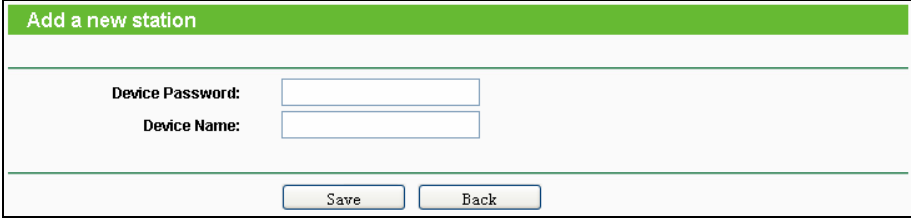

Figure 4-44 Add or Modify PLC Station entry

Click the **Delete** button in the operation column to delete a station entry.

Click the **Add New...** button to add a station into current network. The steps are the same as adding a station entry.



Add a new station	
Device Password:	<input type="text"/>
Device Name:	<input type="text"/>
<input type="button" value="Save"/> <input type="button" value="Back"/>	

Figure 4-45 Add a new station

Click the **Refresh** button to update the current connected stations.

Click the **Next** button to go to the next page and click the **Previous** button to return to the previous page.

 **Note:**

You can do **Add** or **Modify** operation only when the remote station is connected. If the remote station which you entered the password is power off or leave the current network, you can only do **Delete** operation.

4.8.3 QoS Setting

Choose menu "**Powerline** → **QoS Setting**", and you can configure the QoS (quality of service) parameters of the router on this page.

QoS Settings

Simple Application Mapping

- Internet
- Online Game
- Audio or Video
- Voice over IP

Advanced Priority Mapping

VLAN Tag **TOS Bits**

0:	CAP1	CAP1
1:	CAP0	CAP0
2:	CAP0	CAP0
3:	CAP1	CAP1
4:	CAP2	CAP2
5:	CAP2	CAP2
6:	CAP3	CAP3
7:	CAP3	CAP3

Unicast Priority: CAP1 Mcast Priority: CAP1

IGMP Priority: CAP3 AV Stream Priority: CAP2

Figure 4-46 QoS Settings

- **Simple Application Mapping** - The group allows you to choose what type of traffic with the highest user priority you will use your local device for by pitching on one of the following four radios:
 - **Internet** - The Internet Application Mapping be use to Internet server.
 - **Online Game** - The Online Game Application Mapping be use to Online Game server.
 - **Audio or Video** - The Audio or Video Application Mapping be use to Audio or Video server.
 - **Voice over IP** - The Voice over IP Application Mapping be use to Voice over IP server.
- **Advanced Priority Mapping** - The group sets VLAN priority and TOS priority to CAP mapping and other priority.
 - **VLAN Tags** - Host frames can be priority classified based on VLAN CoS bits. Each combination of the CoS bits can be independently assigned to a priority queue.
 - **TOS Bits** - Classification can be based on TOS priority bits in the same manner as the VLAN CoS bits.
 - **Unicast Priority** - Unicast frames are those destined to a unique MAC addresses. These frames to CAP1 by default.
 - **Mcast Priority** - Multicast frames not managed by IGMP and broadcast frames such as ARP frames are transmitted at the specified priority, default is CAP1.

- **IGMP Priority** - IGMP frames are defined by the Internet Group Management Protocol and represent management messages passed between various network infrastructure components. As a management protocol, these frames are by default classified at the highest CAP3 by default.
- **AV Stream Priority** - AV Stream is placed in the specified priority queue, default is CAP2.

 **Note:**

1. CAP3 is the highest priority while CAP0 is the lowest priority. CAP3 is used for the delivery of voice and urgent MMEs and control messages such as IGMP and MLD, CAP2 is used for the delivery of video and non urgent MMEs, CAP0 and CAP1 are used for delivery of best effort data.
2. If both VLAN and TOS are enabled and a frame is found that contains both, VLAN Tags will override TOS Bits.

Click the **Save** button to save your settings.

4.9 Extender List

Choose menu “**Extender List**”, and you can view basic information about the extenders connected to the router on this page.

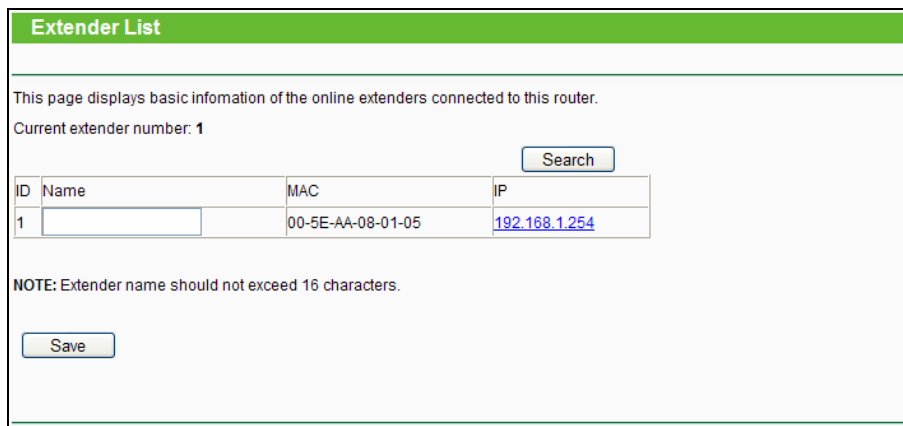

Extender List

This page displays basic information of the online extenders connected to this router.
Current extender number: 1

ID	Name	MAC	IP
1	<input type="text"/>	00-5E-AA-08-01-05	192.168.1.254

NOTE: Extender name should not exceed 16 characters.

Figure 4-47 Extender List

- **Name** - The name used for identifying an extender. You can name your extenders for easy identification and management.
- **MAC** - The extender's MAC address.
- **IP** - The extender's IP address. You can click the hyperlink to go to the extender's web management page.

Click **Search** to update the extender list.

Click **Save** to save the settings.

4.10 DHCP

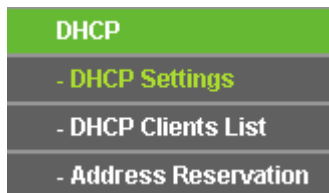

Figure 4-48 DHCP menu

There are three submenus under the DHCP menu (shown in Figure 4-48), **DHCP Settings**, **DHCP Clients List** and **Address Reservation**. Click any of them, and you will be able to configure the corresponding function.

4.10.1 DHCP Settings

Choose menu “**DHCP** → **DHCP Settings**”, and then you can configure the DHCP Server on the page as shown in Figure 4-49. The router is set up by default as a DHCP (Dynamic Host Configuration Protocol) server, which provides the TCP/IP configuration for all the PC(s) that are connected to the router on the LAN.

 A screenshot of the 'DHCP Settings' configuration page. The page has a green header with the title 'DHCP Settings'. Below the header, there are several configuration options:

- DHCP Server:** Radio buttons for 'Disable' and 'Enable'. 'Enable' is selected.
- Start IP Address:** Text input field containing '192.168.1.100'.
- End IP Address:** Text input field containing '192.168.1.199'.
- Address Lease Time:** Text input field containing '120', followed by the text 'minutes (1~2880 minutes, the default value is 120)'.
- Default Gateway:** Text input field containing '192.168.1.1' with '(optional)' to its right.
- Default Domain:** Text input field with '(optional)' to its right.
- Primary DNS:** Text input field containing '0.0.0.0' with '(optional)' to its right.
- Secondary DNS:** Text input field containing '0.0.0.0' with '(optional)' to its right.

 At the bottom of the form is a 'Save' button.

Figure 4-49 DHCP Settings

- **DHCP Server - Enable or Disable** the DHCP server. If you disable the server, you must have another DHCP server within your network or else you must configure the computer manually.
- **Start IP Address** - Specify an IP address for the DHCP Server to start with when assigning IP addresses. 192.168.1.100 is the default start address.
- **End IP Address** - Specify an IP address for the DHCP Server to end with when assigning IP addresses. 192.168.1.199 is the default end address.
- **Address Lease Time** - The **Address Lease Time** is the amount of time a network user will be allowed connection to the router with their current dynamic IP Address. Enter the amount

of time in minutes and the user will be "leased" this dynamic IP Address. After the time is up, the user will be automatically assigned a new dynamic IP address. The range of the time is 1 ~ 2880 minutes. The default value is 120 minutes.

- **Default Gateway** - (Optional.) It is suggested to input the IP address of the Ethernet port of the router. The default value is 192.168.1.1.
- **Default Domain** - (Optional.) Input the domain name of your network.
- **Primary DNS** - (Optional.) Input the DNS IP address provided by your ISP or consult your ISP.
- **Secondary DNS** - (Optional.) Input the IP address of another DNS server if your ISP provides two DNS servers.

 **Note:**

To use the DHCP server function of the router, you must configure all computers on the LAN as "Obtain an IP Address automatically".

4.10.2 DHCP Clients List

Choose menu "DHCP → DHCP Clients List", and then you can view the information about the clients attached to the router in the screen as shown in Figure 4-50.

DHCP Clients List				
ID	Client Name	MAC Address	Assigned IP	Lease Time
1	tplink22765	50-E5-49-C7-64-6E	192.168.1.102	01:44:23
2	android-5b603ffb2b802828	E8-99-C4-E1-E9-B8	192.168.1.101	01:55:40
3	rewe-35d498fd59	00-25-22-4A-91-85	192.168.1.100	01:37:01

Figure 4-50 DHCP Clients List

- **Client Name** - The name of the DHCP client
- **MAC Address** - The MAC address of the DHCP client
- **Assigned IP** - The IP address that the router has allocated to the DHCP client
- **Lease Time** - The time of the DHCP client leased. After the dynamic IP address has expired, a new dynamic IP address will be automatically assigned to the user.

You cannot change any of the values on this page. To update this page and to show the current attached devices, click the **Refresh** button.

4.10.3 Address Reservation

Choose menu “**DHCP** → **Address Reservation**”, and then you can view and add a reserved address for clients via the next screen (shown in Figure 4-51). When you specify a reserved IP address for a PC on the LAN, that PC will always receive the same IP address each time when it accesses the DHCP server. Reserved IP addresses should be assigned to the servers that require permanent IP settings.

Address Reservation				
ID	MAC Address	Reserved IP Address	Status	Modify
1	14-CF-92-0C-08-49	192.168.1.168	Enabled	Modify Delete

Figure 4-51 Address Reservation

- **MAC Address** - The MAC address of the PC for which you want to reserve an IP address.
- **Reserved IP Address** - The IP address reserved for the PC by the router.
- **Status** - The status of this entry, either **Enabled** or **Disabled**.

To Reserve an IP address:

1. Click the **Add New...** button. Then Figure 4-52 will pop up.
2. Enter the MAC address (in XX-XX-XX-XX-XX-XX format.) and IP address (in dotted-decimal notation) of the computer for which you want to reserve an IP address.
3. Click the **Save** button.

Add or Modify an Address Reservation Entry	
MAC Address:	<input type="text" value="14-CF-92-0C-08-49"/>
Reserved IP Address:	<input type="text" value="192.168.1.168"/>
Status:	Enabled <input type="button" value="v"/>

Figure 4-52 Add or Modify an Address Reservation Entry

To modify or delete an existing entry:

1. Click the **Modify** in the entry you want to modify. If you want to delete the entry, click the **Delete**.
2. Modify the information.
3. Click the **Save** button.

Click the **Enable/Disabled All** button to make all entries enabled/disabled

Click the **Delete All** button to delete all entries.

Click the **Next** button to go to the next page and Click the **Previous** button to return the previous page.

4.11 USB Settings

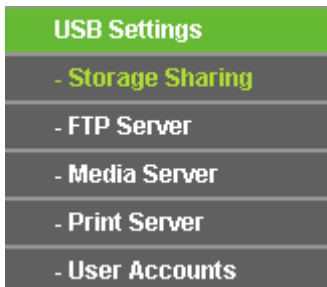

Figure 4-53 USB Settings menu

There are five submenus under the USB Settings menu (shown in Figure 4-53), **Storage Sharing**, **FTP Server**, **Media Server**, **Print Server** and **User Accounts**. Click any of them, and you will be able to configure the corresponding function.

4.11.1 Storage Sharing

Choose menu "**USB Settings** → **Storage Sharing**", and then you can configure a USB disk drive attached to the router, view volume and share properties such as volume name, capacity, used space, and free space, etc on this page as shown below.

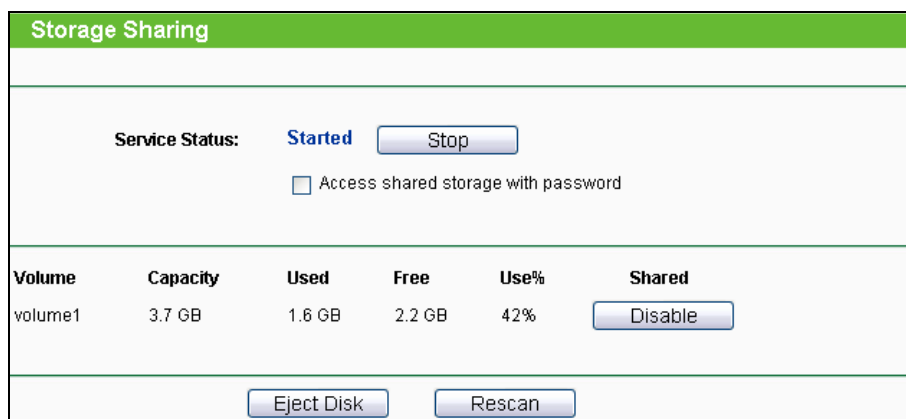

Figure 4-54 Storage Sharing

- **Service Status** - Indicates the Network Sharing service's current status. You can click the **Start** button to start the Storage Sharing service and click the **Stop** button to stop it.
- **Access shared storage with password** - If this checkbox is checked, users need to enter user name and password when accessing the shared storage. You can set user name and password on the "**USB Settings** → **User Accounts**" page.

- **Volume** - The volume name of the USB drive the users have access to.
- **Capacity** - The storage capacity of the USB driver.
- **Used** - The used space of the USB driver.
- **Free** - The available space of the USB driver.
- **Use%** - The percentage of the used space.
- **Shared** - Indicates the shared or non-shared status of the volume. When the volume is shared, you can click the **Disable** to stop sharing the volume; when volume is non-shared, you can click the **Enable** button to share the volume.

Click the **Start** button to start the Network Sharing service.

Click the **Stop** button to stop the Network Sharing service.

Click the **Eject Disk** button to safely remove the USB storage device that is connected to USB port. This takes the drive offline. A message (as shown in Figure 4-55) will appear on your web browser when it is safe to detach the USB disk. Click **OK**.

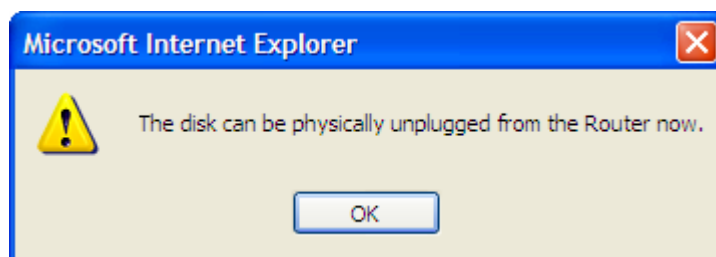

Figure 4-55 Safe Unplug Message

Click the **Rescan** button to start a new scan.

Follow the instructions below to share your USB storage:

1. Plug an external USB hard disk drive or USB flash drive into this router.
2. Click the **Rescan** button to find the USB drive that has been attached to the router.
3. Click the **Start** button to start the Storage Sharing service.
4. Click the **Enable** button under **Shared** to enable the disk to share.
5. Press **Windows + R** to open the **Run** dialog box, type <http://tplinklogin.net> and press **Enter**. Then you can access the shared storage.

Note:

- 1) The router can automatically locate new USB drive. But to display the information about your USB device, you need to click the **Rescan** button manually.
- 2) The new settings will not take effect until you restart the service.

- 3) To unplug the USB drive, click **Eject Disk** button first. Simply pulling USB drive out of the USB port can cause damage to the device and loss of data.
- 4) Mounted volumes are subject to the 8-volume limit, so you cannot access more than 8 volumes on the USB storage device.
- 5) If you change the storage settings during the storage connection is established, then the changes will not take effect until the router or the client is rebooted.

4.11.2 FTP Server

Choose menu “**USB Settings** → **FTP Server**”, and then you can create an FTP server that can be accessed from the Internet or your local network.

Name	Partition	Folder	Modify
folder1	volume1	volume1/Learning	Edit Delete

Figure 4-56 FTP Server Configuration

- **Service Status** - Indicates the FTP Server's current status. You can click the **Start** button to start the FTP Server and click the **Stop** button to stop it.
- **Internet Access** - Select **Enable** to allow access of the FTP server from the Internet. Otherwise, select **Disable** to only allow local network access.
- **Service Port** - Enter the FTP Port number to use. The default is 21.
- **Internet Address** - Displays the address for Internet users to access the FTP server you created. It is the same as the WAN IP address of this router.
- **Public Address** - Displays the address for users in a private LAN to access the FTP server you created. It is displayed only when your WAN connection type is PPPOE/PPTP/L2TP and a secondary connection IP address is available. It is the same as the secondary connection IP address.
- **Name** - This folder's display name.
- **Partition** - The volume that the folder resides.
- **Folder** - The real full path of the specified folder.

To set up your FTP Server, please follow the instructions below:

1. Plug an external USB hard disk drive or USB flash drive into this router.
2. Click the **Enable/Disable** radio box to enable/disable Internet access to FTP from Internet port.
3. Specify a port for the FTP server to use (The default port number is 21).
4. The **Internet Address** displays the WAN IP address of this router, so that other users can access FTP via this address.
5. If WAN type is PPPoE/PPTP/L2TP, two connections will be available. Therefore, users can access FTP server via two connections. Users in a private LAN can access ftp server via **Public Address** while Internet users can access ftp server via **Internet Address**.
6. Click the **Start** button to start the ftp server.

To add a new folder, follow the instructions below.

1. Click **Add New Folder to Share** in Figure 4-56.

Figure 4-57 Add or Modify Share Folder

2. Select the **Share entire partition** checkbox or a specific folder option.
3. Enter display name of the share folder in **Display Name** field.
4. Click the **Save** button to save the settings.

You can click the **upper** button to go to the upper folder.

You can click the **Back** button to return to the FTP server configuration page.

Note:

- 1) The max share folders number is 10. If you want to share a new folder when the number has reached 10, you can delete an existing share folder and then add a new one.
- 2) If you want to change the FTP settings, you need to restart FTP Server to make the changes take effect.

4.11.3 Media Server

Choose menu “**USB Settings** → **Media Server**”, and then you can create media server that allows you to share stored content with other computers and devices on your home network and on the Internet.

Name	File System	Folder	Delete

Figure 4-58 Media Server Setting

- **Server Name** - The name of this Media Server.
- **Server Status** - Indicates the Media Server's current status, started or stopped. You can click the **Start** button to start the Media Server and click the **Stop** button to stop it.
- **Name** - The display name of this folder.
- **File System** - The file system type on the partition can be FAT32 or NTFS.
- **Folder** - The real full path of the specified folder.
- **Delete** - You can delete the share folder by click **Delete**.

To set up your media server, please follow the instructions below:

1. Plug an external USB hard disk drive or USB flash drive into this router, and then the screen will appear as shown in Figure 4-59.

Name	File System	Folder	Delete

Figure 4-59 Media Server Setting

2. Click the **Start** button to start the media server, and then the screen will appear as shown in Figure 4-60.

Name	File System	Folder	Delete

Figure 4-60 Media Server Setting

3. Click the **Add share folder** button to specify a folder as the search path of media server. The screen will then appear as shown in Figure 4-61.

Figure 4-61 Add New Folder

- **Display Name** - You can enter a display name for the share folder.
- **Share entire partition** - Choose this option and then the folders contained in this partition will all be shared.
- **Folder Location**- Displays the location of this folder.
- **Select** - Check the radio button to select the folder to share.
- **Folder** - Displays folders that are in current path.
- **Upper** - Click this button to get into the upper folder.
- **Save** - Click this button to save your settings and the page will be redirected to the media server configuration page.
- **Back** - Click this button to discard the settings and just go to the media server configuration page.

- Click the **Scan All button** to scan all the share folders immediately. You can also select the **Auto-scan** checkbox and select an auto-scan interval. In this case, the media server will automatically scan the share folders.

Note:

The max share folders number is 6. If you want share a new folder when the number has reached 6, you can delete a share folder and then add a new one.

4.11.4 Print Server

Choose menu “**USB Settings** → **Print Server**”, and then you can configure print server on this page as shown below.



Figure 4-62 Print Server Setting

There are two states of the print server, they are as follows:

- **Online** - Indicates the print service has been turned on, and no user is using the print service at present. You can click the "**Stop**" button to stop the print service.
- **Offline** - Indicates the print service feature is disabled. You can click "**Start**" button to start the print service.

4.11.5 User Accounts

Choose menu “**USB Settings** → **User Accounts**”, and then you can configure the user name and password for Storage Sharing and FTP Server users. Storage Sharing users can use Internet Explorer to access files on the USB drive. FTP Server users can log into the FTP Server via FTP Client.

User **admin** is the default user account that can access the Storage Sharing and FTP Server. It has Read and Write permissions to Storage Sharing and can access FTP Server.

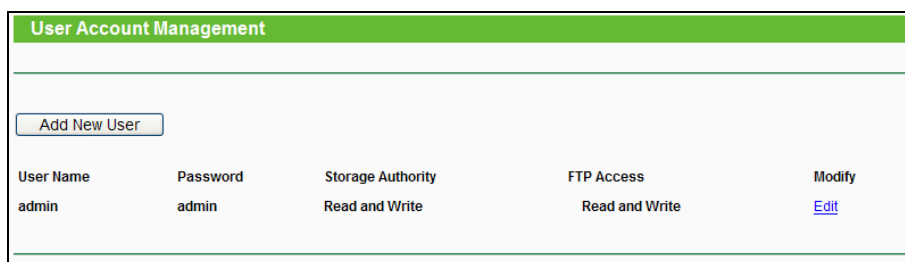

Figure 4-63 User Account Management

To add a new user account, please follow the steps below:

1. Click **Add New User** button, and the screen will appear as shown in Figure 4-64.

Figure 4-64 Add or Modify User Account

- **User Name** - Type the user name that you want to give access to the USB drive. The user name must be composed of alphanumeric symbols not exceeding 15 characters in length.
 - **Password** - Enter the password in the Password field. The password must be composed of alphanumeric symbols not exceeding 15 characters in length. For security purposes, the password for each user account is not displayed.
 - **Confirm Password** - Re-enter the password here.
 - **Storage Authority** – Choose **Read and Write** or **Read Only** from the drop-down list to assign access authority of Storage Sharing to the user.
 - **FTP Access** – Choose **Read and Write**, **No** or **Read Only** from the drop-down list to assign access authority of FTP Server to the user.
 - **Save** - You can click the **Save** button to save your settings.
 - **Back** - You can click the **Back** button to discard the settings and just go to the media server configuration page.
2. Self-define a **User Name**.
 3. Enter the password in the **Password** field.
 4. Re-enter the password in the **Confirm Password** field.
 5. Choose **Read and Write** or **Read Only** from the **Storage Authority** drop-down list.
 6. Choose **Read and Write**, **No** or **Read Only** from the **FTP Access** drop-down list.

Note:

- 1) Please restart the service for the new settings to take effect.
- 2) If you cannot use the new user name and password to access the shares, press **Windows + R** to open the Run dialog box and type **net use \\192.168.1.1 /delete /yes** and press **Enter**. (192.168.1.1 is your router's LAN IP address. If the LAN IP of the modem connected with

your router is 192.168.1.x, the default LAN IP of the router will automatically switch from 192.168.1.1 to 192.168.0.1 to avoid IP conflict; in this case, please try **net use \\192.168.0.1 /delete / yes.**)

4.12 NAT

Choose menu “**NAT**”, and then you can disable or enable the NAT and Hardware NAT Control features. The NAT Rules and Hardware NAT will work properly only when the NAT Control feature is enabled.

Figure 4-65 NAT

- **Current NAT Status** - If **Enabled**, the NAT function and the Forwarding configuration will take effect. If **Disabled**, neither NAT function nor Forwarding configuration will take effect
- **Current Hardware NAT Status** - If **Enabled**, the Hardware NAT feature will take effect. If **Disabled**, the Hardware NAT feature will not take effect.

Note:

The new settings will not take effect until the router reboots.

4.13 Forwarding

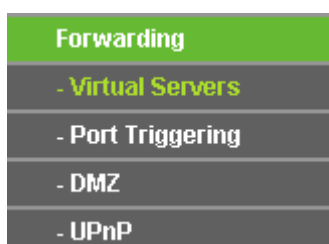

Figure 4-66 Forwarding menu

There are four submenus under the Forwarding menu (shown in Figure 4-66): **Virtual Servers**, **Port Triggering**, **DMZ** and **UPnP**. Click any of them, and you will be able to configure the corresponding function.

4.13.1 Virtual Servers

Choose menu “**Forwarding** → **Virtual Servers**”, and then you can view and add virtual servers in the next screen (shown in Figure 4-67). Virtual servers can be used for setting up public

services on your LAN. A virtual server is defined as a service port, and all requests from Internet to this service port will be redirected to the computer specified by the server IP. Any PC that was used for a virtual server must have a static or reserved IP address because its IP address may change when using the DHCP function.

Figure 4-67 Virtual Servers

To add a new virtual server, please follow the steps below:

1. Click the **Add New...** button. (pop-up Figure 4-68)

Figure 4-68 Add or Modify a Virtual Server Entry

- **Service Port** - The numbers of External Service Ports. You can enter a service port (the format is XX) or a range of service ports (the format is XX – XX; the first XX is the Start port and the second XX is the End port).
- **Internal Port** - The Internal Service Port number of the PC running the service application. You can leave it blank if the **Internal Port** is the same as the **Service Port**, or enter a specific port number when **Service Port** is a single one.
- **IP Address** - The IP address of the PC running the service application.
- **Protocol** - The protocol used for this application, either **TCP**, **UDP**, or **All** (all protocols supported by the router).
- **Status** - The status of this entry. Select "**Enabled**" to enable the virtual service.

- **Common Service Port** - Some common services already exist in the drop-down list. Select the service you want to use from it.
 - **Save** - You can click the **Save** button to save your settings.
 - **Back** - You can click the **Back** button to discard the settings and just go to the virtual Server configuration page.
2. Select the service you want to use from the **Common Service Port** list. If the **Common Service Port** menu does not list the service that you want to use, enter the number of the service port or service port range in the **Service Port** field.
 3. Enter the IP address of the computer running the service application in the **IP Address** field.
 4. Select the protocol used for this application in the **Protocol** drop-down list, either **TCP**, **UDP**, or **All**.
 5. Select the **Enabled** option in the **Status** drop-down list.
 6. Click the **Save** button.

 **Note:**

It is possible that you have a computer or server that has more than one type of available service. If so, select another service, and type the same IP address for that computer or server.

To modify or delete an existing entry:

1. Find the desired entry in the table.
2. Click **Modify** or **Delete** as desired on the **Modify** column.

Click the **Enable/ Disable All** button to make all entries enabled/ disabled.

Click the **Delete All** button to delete all entries.

Click the **Next** button to go to the next page and click the **Previous** button to return to the previous page.

 **Note:**

If you set the service port of the virtual server as 80, you must set the Web management port on **Security → Remote Management** page to be any other value except 80 such as 8080. Otherwise there will be a conflict to disable the virtual server.

4.13.2 Port Triggering

Choose menu "**Forwarding→Port Triggering**", and then you can view and add port triggering in the next screen (shown in Figure 4-69). Some applications require multiple connections, like Internet games, video conferencing, Internet telephoning and so on. Port Triggering is used for some of these applications that cannot work with a pure NAT router.

Figure 4-69 Port Triggering

To add a new rule, follow the steps below.

1. Click the **Add New...** button, the next screen will pop-up as shown in Figure 4-70.

Figure 4-70 Add or Modify a Triggering Entry

- **Trigger Port** - The port for outgoing traffic. An outgoing connection using this port will trigger this rule.
- **Trigger Protocol** - The protocol used for Trigger Ports, either **TCP**, **UDP**, or **All** (all protocols supported by the router).
- **Incoming Port** - The port or port range used by the remote system when it responds to the outgoing request. A response using one of these ports will be forwarded to the PC which triggered this rule. You can input at most 5 groups of ports (or port sections). Every group of ports must be separated with ",", for example, 2000-2038, 2046, 2050-2051, 2085, 3010-3030.
- **Incoming Protocol** - The protocol used for **Incoming Port**, either **TCP**, **UDP**, or **ALL** (all protocols supported by the router).
- **Status** - The status of this entry, Enabled means the Port Triggering entry is enabled.
- **Modify** - To modify or delete an existing entry.
- **Common Applications** - Some popular applications already listed in the drop-down list of **Incoming Protocol**.

2. Select a common application from the **Common Applications** drop-down list, then the **Trigger Port** field and the **Incoming Ports** field will be automatically filled. If the **Common Applications** do not have the application you need, enter the **Trigger Port** and the **Incoming Ports** manually.
3. Select the protocol used for Trigger Port from the **Trigger Protocol** drop-down list, either **TCP**, **UDP**, or **All**.
4. Select the protocol used for Incoming Ports from the **Incoming Protocol** drop-down list, either **TCP** or **UDP**, or **All**.
5. Select **Enabled** in **Status** field.
6. Click the **Save** button to save the new rule.

To modify or delete an existing entry:

1. Find the desired entry in the table.
2. Click **Modify** or **Delete** as desired on the **Modify** column.

Click the **Enable All** button to make all entries enabled.

Click the **Disable All** button to make all entries disabled.

Click the **Delete All** button to delete all entries

Once the router is configured, the operation is as follows:

1. A local host makes an outgoing connection to an external host using a destination port number defined in the **Trigger Port** field.
2. The router records this connection, opens the incoming port or ports associated with this entry in the **Port Triggering** table, and associates them with the local host.
3. When necessary, the external host will be able to connect to the local host using one of the ports defined in the **Incoming Ports** field.



Note:

- 1) When the trigger connection is released, the corresponding opened ports will be closed.
- 2) Each rule can only be used by one host on the LAN at a time. The trigger connection of other hosts on the LAN will be refused.
- 3) **Incoming Ports** ranges cannot overlap each other.

4.13.3 DMZ

Choose menu "**Forwarding**→**DMZ**", and then you can view and configure DMZ host in the screen (shown in Figure 4-71).The DMZ host feature allows one local host to be exposed to the Internet for a special-purpose service such as Internet gaming or videoconferencing. The router forwards packets of all services to the DMZ host. Any PC whose port is being forwarded must have its

DHCP client function disabled and should have a new static IP Address assigned to it because its IP Address may be changed when using the DHCP function.

Figure 4-71 DMZ

To assign a computer or server to be a DMZ server:

1. Click the **Enable** button.
2. Enter the IP address of a local PC that is set to be DMZ host in the **DMZ Host IP Address** field.
3. Click the **Save** button.

4.13.4 UPnP

Choose menu “**Forwarding**→**UPnP**”, and then you can view the information about **UPnP** in the screen (shown in Figure 4-72). The **Universal Plug and Play (UPnP)** feature allows the devices, such as Internet computers, to access the local host resources or devices as needed. UPnP devices can be automatically discovered by the UPnP service application on the LAN.

Figure 4-72 UPnP Setting

- **Current UPnP Status** - UPnP can be enabled or disabled by clicking the **Enable** or **Disable** button. This feature is enabled by default.
- **Current UPnP Settings List** - This table displays the current UPnP information.
 - **App Description** - The description about the application which initiates the UPnP request.

- **External Port** - The port which the router opened for the application.
- **Protocol** - The type of protocol which is opened.
- **Internal Port** - The port which the router opened for local host.
- **IP Address** - The IP address of the local host which initiates the UPnP request.
- **Status** - Either Enabled or Disabled. "Enabled" means that the port is still active; otherwise, the port is inactive.

Click the **Enable** button to enable UPnP.

Click the **Disable** button to disable UPnP.

Click the **Refresh** button to update the Current UPnP Settings List.

4.14 Security



Figure 4-73 Security menu

There are four submenus under the Security menu as shown in Figure 4-73: **Basic Security**, **Advanced Security**, **Local Management**, and **Remote Management**. Click any of them, and you will be able to configure the corresponding function.

4.14.1 Basic Security

Choose menu "**Security** → **Basic Security**", and then you can configure the basic security in the screen as shown in Figure 4-74.

Basic Security	
Firewall	
SPI Firewall:	<input checked="" type="radio"/> Enable <input type="radio"/> Disable
VPN	
PPTP Passthrough:	<input checked="" type="radio"/> Enable <input type="radio"/> Disable
L2TP Passthrough:	<input checked="" type="radio"/> Enable <input type="radio"/> Disable
IPSec Passthrough:	<input checked="" type="radio"/> Enable <input type="radio"/> Disable
ALG	
FTP ALG:	<input checked="" type="radio"/> Enable <input type="radio"/> Disable
TFTP ALG:	<input checked="" type="radio"/> Enable <input type="radio"/> Disable
H323 ALG:	<input checked="" type="radio"/> Enable <input type="radio"/> Disable
RTSP ALG:	<input checked="" type="radio"/> Enable <input type="radio"/> Disable
<input type="button" value="Save"/>	

Figure 4-74 Basic Security

- **Firewall** - A firewall protects your network from the outside world. Here you can enable or disable the router's firewall.
 - **SPI Firewall** - SPI (Stateful Packet Inspection, also known as dynamic packet filtering) helps to prevent cyber attacks by tracking more state per session. It validates that the traffic passing through the session conforms to the protocol. SPI Firewall is enabled by factory default. If you want all the computers on the LAN exposed to the outside world, you can disable it.
- **VPN** - VPN Passthrough must be enabled if you want to allow VPN tunnels using VPN protocols to pass through the router.
 - **PPTP Passthrough** - Point-to-Point Tunneling Protocol (PPTP) allows the Point-to-Point Protocol (PPP) to be tunneled through an IP network. To allow PPTP tunnels to pass through the router, click **Enable**.
 - **L2TP Passthrough** - Layer Two Tunneling Protocol (L2TP) is the method used to enable Point-to-Point sessions via the Internet on the Layer Two level. To allow L2TP tunnels to pass through the router, click **Enable**.
 - **IPSec Passthrough** - Internet Protocol security (IPSec) is a suite of protocols for ensuring private, secure communications over Internet Protocol (IP) networks, through the use of cryptographic security services. To allow IPSec tunnels to pass through the router, click **Enable**.
- **ALG** - It is recommended to enable Application Layer Gateway (ALG) because ALG allows customized Network Address Translation (NAT) traversal filters to be plugged into the

gateway to support address and port translation for certain application layer "control/data" protocols such as FTP, TFTP, H323 etc.

- **FTP ALG** - To allow FTP clients and servers to transfer data across NAT, click **Enable**.
- **TFTP ALG** - To allow TFTP clients and servers to transfer data across NAT, click **Enable**.
- **H323 ALG** - To allow Microsoft NetMeeting clients to communicate across NAT, click **Enable**.
- **RTSP ALG** - To allow some media player clients to communicate with some streaming media servers across NAT, click **Enable**.

Click the **Save** button to save your settings.

4.14.2 Advanced Security

Choose menu "**Security** → **Advanced Security**", and then you can protect the router from being attacked by TCP-SYN Flood, UDP Flood and ICMP-Flood in the screen as shown in Figure 4-75.

Figure 4-75 Advanced Security

- **Packets Statistics Interval (5~60)** - The default value is 10. Select a value between 5 and 60 seconds from the drop-down list. The Packets Statistics Interval value indicates the time section of the packets statistics. The result of the statistics is used for analysis by SYN Flood, UDP Flood and ICMP-Flood.

- **DoS Protection** - Denial of Service protection. Check the Enable or Disable button to enable or disable the DoS protection function. Only when it is enabled, will the flood filters be enabled.

 **Note:**

Dos Protection will take effect only when the **Statistics** in “**System Tool** → **Statistics**” is enabled.

- **Enable ICMP-FLOOD Attack Filtering** - Enable or Disable the ICMP-FLOOD Attack Filtering.
- **ICMP-FLOOD Packets Threshold (5~3600)** - The default value is 50. Enter a value between 5 ~ 3600. When the current ICMP-FLOOD Packets number is beyond the set value, the router will startup the blocking function immediately.
- **Enable UDP-FLOOD Filtering** - Enable or Disable the UDP-FLOOD Filtering.
- **UDP-FLOOD Packets Threshold (5~3600)** - The default value is 500. Enter a value between 5 ~ 3600. When the current UPD-FLOOD Packets number is beyond the set value, the router will startup the blocking function immediately.
- **Enable TCP-SYN-FLOOD Attack Filtering** - Enable or Disable the TCP-SYN-FLOOD Attack Filtering.
- **TCP-SYN-FLOOD Packets Threshold (5~3600)** - The default value is 50. Enter a value between 5 ~ 3600. When the current TCP-SYN-FLOOD Packets numbers is beyond the set value, the router will startup the blocking function immediately.
- **Ignore Ping Packet From WAN Port** - Enable or Disable Ignore Ping Packet From WAN Port. The default setting is disabled. If enabled, the ping packet from the Internet cannot access the router.
- **Forbid Ping Packet From LAN Port** - Enable or Disable Forbid Ping Packet From LAN Port. The default setting is disabled. If enabled, the ping packet from LAN cannot access the router. This function can be used to defend against some viruses.

Click the **Save** button to save the settings.

Click the **Blocked DoS Host List** button to display the DoS host table by blocking.

4.14.3 Local Management

Choose menu “**Security** → **Local Management**”, and then you can configure the management rule in the screen as shown in Figure 4-76. The management feature allows you to deny computers in LAN from accessing the router.

Figure 4-76 Local Management

By default, the radio button “**All the PCs on the LAN are allowed to access the Router's Web-Based Utility**” is checked. If you want to allow PCs with specific MAC Addresses to access the Setup page of the router's Web-Based Utility locally from inside the network, check the radio button “**Only the PCs listed can browse the built-in web pages to perform Administrator tasks**”, and then enter each MAC Address in a separate field. The format for the MAC Address is XX-XX-XX-XX-XX-XX (X is any hexadecimal digit). Only the PCs with MAC address listed can use the password to browse the built-in web pages to perform Administrator tasks while all the others will be blocked.

After click the **Add** button, your PC's MAC Address will be placed in the list above.

Click the **Save** button to save your settings.

 **Note:**

If your PC is blocked but you want to access the router again, use a pin to press and hold the **Reset Button** (hole) on the back panel for about 5 seconds to reset the router's factory defaults on the router's Web-Based Utility.

4.14.4 Remote Management

Choose menu “**Security** → **Remote Management**”, and then you can configure the Remote Management function in the screen as shown in Figure 4-77. This feature allows you to manage your router from a remote location via the Internet.

Figure 4-77 Remote Management

- **Web Management Port** - Web browser access normally uses the standard HTTP service port 80. This router's default remote management web port number is 80. For greater security, you can change the remote management web port to a custom port by entering that number in the box provided. Choose a number between 1 and 65534 but do not use the number of any common service port.
- **Remote Management IP Address** - This is the current address you will use when accessing your router from the Internet. This function is disabled when the IP address is set to the default value of 0.0.0.0. To enable this function change 0.0.0.0 to a valid IP address. If set to 255.255.255.255, then all the hosts can access the router from internet.

 **Note:**

- 1) To access the router, you should type your router's WAN IP address into your browser's address (in IE) or Location (in Navigator) box, followed by a colon and the custom port number. For example, if your router's WAN address is 202.96.12.8, and the port number used is 8080, please enter `http://202.96.12.8:8080` in your browser. Later, you may be asked for the router's password. After successfully entering the username and password, you will be able to access the router's web-based utility.
- 2) Be sure to change the router's default password to a very secure password.

4.15 Parental Control

Choose menu “**Parental Control**”, and then you can configure the parental control in the screen as shown in Figure 4-78. The Parental Control function can be used to control the internet activities of the child, limit the child to access certain websites and restrict the time of surfing.

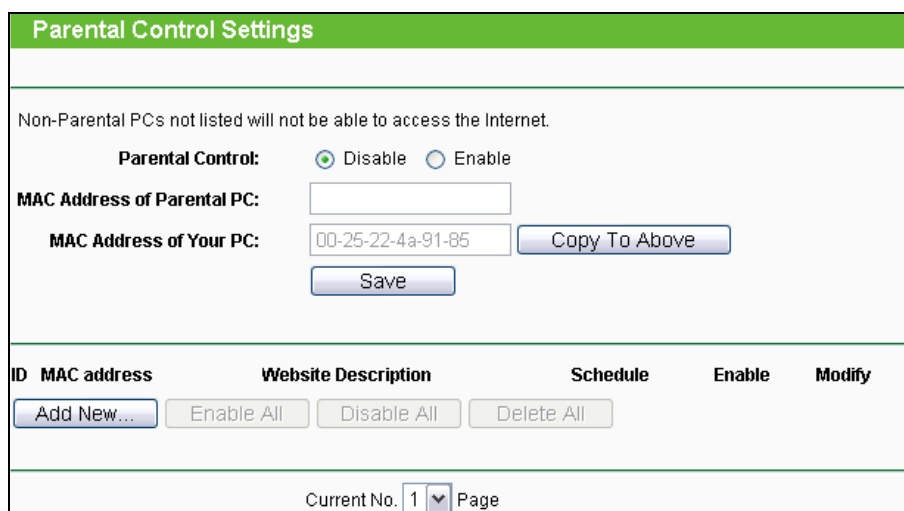

Parental Control Settings

Non-Parental PCs not listed will not be able to access the Internet.

Parental Control: Disable Enable

MAC Address of Parental PC:

MAC Address of Your PC:

ID	MAC address	Website Description	Schedule	Enable	Modify
<input type="button" value="Add New..."/> <input type="button" value="Enable All"/> <input type="button" value="Disable All"/> <input type="button" value="Delete All"/>					

Current No. Page

Figure 4-78 Parental Control Settings

- **Parental Control** - Check **Enable** if you want this function to take effect; otherwise, check **Disable**.

- **MAC Address of Parental PC** - In this field, enter the MAC address of the controlling PC, or you can make use of the **Copy To Above** button below.
- **MAC Address of Your PC** - This field displays the MAC address of the PC that is managing this router. If the MAC Address of your adapter is registered, you can click the **Copy To Above** button to fill this address to the MAC Address of Parental PC field above.
- **Website Description** - Description of the allowed website for the PC controlled.
- **Schedule** - The time period allowed for the PC controlled to access the Internet. For detailed information, please go to "**Access Control** → **Schedule**".
- **Enable** - Check this option to enable a specific entry.
- **Modify** - Here you can edit or delete an existing entry.

To add a new entry, please follow the steps below.

1. Click the **Add New...** button and the next screen will pop-up as shown in Figure 4-79.

The Schedule is based on the time of the Router. The time can be set in "System Tools -> [Time settings](#)".

MAC Address of Child PC:

All MAC Address In Current LAN: --please select--

Website Description:

Effective Time: Anytime

The time schedule can be set in "Access Control -> [Schedule](#)"

Status: Enabled

Figure 4-79 Add or Modify Parental Control Entry

2. Enter the MAC address of the PC (e.g. 00-11-22-33-44-AA) you'd like to control in the **MAC Address of Child PC** field, or you can choose the MAC address from the **All Address in Current LAN** drop-down list.
3. Give a description (e.g. Allow Google) for the website allowed to be accessed in the **Website Description** field.
4. Enter the allowed domain name of the website, either the full name or the keywords (e.g. google) in the **Allowed Domain Name** field. Any domain name with keywords in it (www.google.com, www.google.com.hk) will be allowed.

5. Select from the Effective Time drop-down list the schedule (e.g. Schedule_1) you want. If there are not suitable schedules for you, click the **Schedule** in red below to go to the Advance Schedule Settings page and create the schedule you need.
6. In the Status field, you can select **Enabled** or **Disabled** to enable or disable your entry.
7. Click the **Save** button.

Click the **Enable All** button to enable all the rules in the list.

Click the **Disable All** button to disable all the rules in the list.

Click the **Delete All** button to delete all the entries in the table.

Click the **Next** button to go to the next page, or click the **Previous** button to return to the previous page.

For example: If you desire that the child PC with MAC address 00-11-22-33-44-AA can access www.google.com on Saturday only while the parent PC with MAC address 00-11-22-33-44-BB is without any restriction, you should follow the settings below.

1. Click "**Parental Control**" menu on the left to enter the Parental Control Settings page. Check Enable and enter the MAC address 00-11-22-33-44-BB in the MAC Address of Parental PC field.
2. Click "**Access Control** → **Schedule**" on the left to enter the Schedule Settings page. Click **Add New...** button to create a new schedule with Schedule Description is Schedule_1, Day is Sat and Time is all day-24 hours.
3. Click "**Parental Control**" menu on the left to go back to the Add or Modify Parental Control Entry page:
 - 1) Click **Add New...** button.
 - 2) Enter 00-11-22-33-44-AA in the **MAC Address of Child PC** field.
 - 3) Enter "Allow Google" in the **Website Description** field.
 - 4) Enter "www.google.com" in the **Allowed Domain Name** field.
 - 5) Select "Schedule_1" you create just now from the **Effective Time** drop-down list.
 - 6) In **Status** field, select Enable.
4. Click **Save** to complete the settings.

Then you will go back to the **Parental Control Settings** page and see the following list, as shown in Figure 4-80.

ID	MAC address	Website Description	Schedule	Enable	Modify
1	00-11-22-33-44-AA	Allow Google	Schedule_1	<input checked="" type="checkbox"/>	Edit Delete

Figure 4-80 Parental Control Settings

4.16 Access Control



Figure 4-81 Access Control

There are four submenus under the Access Control menu as shown in Figure 4-81: **Rule**, **Host**, **Target**, and **Schedule**. Click any of them, and you will be able to configure the corresponding function.

4.16.1 Rule

Choose menu “**Access Control** → **Rule**”, and then you can view and set Access Control rules in the screen as shown in Figure 4-82.

Access Control Rule Management

Enable Internet Access Control

Default Filter Policy

Allow the packets specified by any enabled access control policy to pass through the Router

Deny the packets specified by any enabled access control policy to pass through the Router

ID	Rule Name	Host	Target	Schedule	Enable	Modify
	<input type="button" value="Setup Wizard"/>					
<input type="button" value="Add New..."/> <input type="button" value="Enable All"/> <input type="button" value="Disable All"/> <input type="button" value="Delete All"/>						
<input type="button" value="Move"/>		ID	<input type="text"/>	To ID	<input type="text"/>	

Current No. Page

Figure 4-82 Access Control Rule Management

- **Enable Internet Access Control** - Select the check box to enable the Internet Access Control function, so the Default Filter Policy can take effect.
- **Rule Name** - Here displays the name of the rule and this name is unique.
- **Host** - Here displays the host selected in the corresponding rule.
- **Target** - Here displays the target selected in the corresponding rule.
- **Schedule** - Here displays the schedule selected in the corresponding rule.
- **Enable** - Here displays the status of the rule, enabled or not. Check this option to enable a specific entry.
- **Modify** - Here you can edit or delete an existing rule.
- **Setup Wizard** - Click the **Setup Wizard** button to create a new rule entry.
- **Add New...** - Click the **Add New...** button to add a new rule entry.
- **Enable All** - Click the **Enable All** button to enable all the rules in the list.
- **Disable All** - Click the **Disable All** button to disable all the rules in the list.
- **Delete All** - Click the **Delete All** button to delete all the entries in the table.
- **Move** - You can change the entry's order as desired. Enter in the first box the ID number of the entry you want to move and in the second box another ID number, and then click the **Move** button to change the entries' order.
- **Next** - Click the **Next** button to go to the next page.
- **Previous** - Click the **Previous** button to return to the previous page.

There are two methods to add a new rule.

Method One:

1. Click **Setup Wizard** button and the next screen will appear as shown in Figure 4-83.

Quick Setup - Create a Host Entry	
Mode:	IP Address
Host Description:	<input type="text"/>
LAN IP Address:	<input type="text"/> - <input type="text"/>
<input type="button" value="Back"/> <input type="button" value="Next"/>	

Figure 4-83 Quick Setup – Create a Host Entry

- **Mode** - Here are two options, **IP Address** and **MAC Address**. You can select either of them from the drop-down list.
- **Host Description** - In this field, create a unique description for the host (e.g. Host_1).

If the **IP Address** is selected, you can see the following item:

- **LAN IP Address** - Enter the IP address or address range of the host in dotted-decimal format (e.g. 192.168.1.23).

If the MAC Address is selected, you can see the following item:

- **MAC Address** - Enter the MAC address of the host in XX-XX-XX-XX-XX-XX format (e.g. 00-11-22-33-44-AA).
2. Click **Next** when finishing creating the host entry, and the next screen will appear as shown in Figure 4-84.

Figure 4-84 Quick Setup – Create an Access Target Entry

- **Mode** - Here are two options, **IP Address** and **Domain Name**. You can choose either of them from the drop-down list.
- **Target Description** - In this field, create a description for the target. Note that this description should be unique (e.g. Target_1).

If the **IP Address** is selected, you will see the following items:

- **IP Address** - Enter the IP address (or address range) of the target (targets) in dotted-decimal format (e.g. 192.168.1.23).
- **Target Port** - Specify the port or port range for the target. For some common service ports, you can make use of the Common Service Port item below.
- **Protocol** - Here are four options, All, TCP, UDP, and ICMP. Select one of them from the drop-down list for the target.
- **Common Service Port** - Here lists some common service ports. Select one from the drop-down list, and the corresponding port number will be filled in the Target Port field automatically. For example, if you select "FTP", "21" will be filled in the Target Port automatically.

If the **Domain Name** is selected, you will see the following items:

- **Domain Name** - Here you can enter 4 domain names, either the full name or the keywords (for example, google). Any domain name with keywords in it (www.google.com, www.google.cn) will be blocked or allowed.
3. Click **Next** when finishing creating the access target entry, and the next screen will appear as shown in Figure 4-85.

Figure 4-85 Quick Setup – Create an Advanced Schedule Entry

- **Schedule Description** - In this field, create a description for the schedule. Note that this description should be unique (e.g. Schedule_1).
 - **Day** - Choose **Select Days** and select the certain day (days), or choose **Everyday**.
 - **Time** - Select "all day-24 hours", or specify the **Start Time** and **Stop Time** yourself.
 - **Start Time** - Enter the start time in HHMM format (HHMM are 4 numbers). For example 0800 is 8:00.
 - **Stop Time** - Enter the stop time in HHMM format (HHMM are 4 numbers). For example 2000 is 20:00.
4. Click **Next** when finishing creating the advanced schedule entry, and the next screen will appear as shown in Figure 4-86.

Figure 4-86 Quick Setup – Create an Internet Access Control Entry

- **Rule** - In this field, create a name for the rule. Note that this name should be unique (e.g. Rule_1).
 - **Host** - In this field, select a host from the drop-down list for the rule. The default value is the **Host Description** you set just now.
 - **Target** - In this field, select a target from the drop-down list for the rule. The default value is the **Target Description** you set just now.
 - **Schedule** - In this field, select a schedule from the drop-down list for the rule. The default value is the **Schedule Description** you set just now.
 - **Status** - In this field, there are two options, **Enabled** or **Disabled**. Select **Enabled** so that the rule will take effect. Select **Disabled** so that the rule won't take effect.
5. Click **Finish** to complete adding a new rule.

Method Two:

1. Click the **Add New...** button and the next screen will pop up as shown in Figure 4-87.
2. Give a name (e.g. Rule_1) for the rule in the **Rule Name** field.
3. Select a host from the **Host** drop-down list or choose “**Click Here To Add New Host List**”.
4. Select a target from the **Target** drop-down list or choose “**Click Here To Add New Target List**”.
5. Select a schedule from the **Schedule** drop-down list or choose “**Click Here To Add New Schedule**”.
6. In the **Status** field, select **Enabled** or **Disabled** to enable or disable your entry.
7. Click the **Save** button.

Figure 4-87 Add Internet Access Control Entry

For example: If you desire to allow the host with MAC address 00-11-22-33-44-AA to access www.google.com only from 18:00 to 20:00 on Saturday and Sunday, and forbid other hosts in the LAN to access the Internet, you should follow the settings below:

1. Click the submenu **Rule** of **Access Control** in the left to return to the Rule List page. Select **Enable Internet Access Control** and choose "Allow the packets specified by any enabled access control policy to pass through the Router".
2. We recommend that you click **Setup Wizard** button to finish all the following settings.
3. Click the submenu **Host** of **Access Control** in the left to enter the Host List page. Add a new entry with the Host Description is Host_1 and MAC Address is 00-11-22-33-44-AA.
4. Click the submenu **Target** of **Access Control** in the left to enter the Target List page. Add a new entry with the Target Description is Target_1 and Domain Name is www.google.com.
5. Click the submenu **Schedule** of **Access Control** in the left to enter the Schedule List page. Add a new entry with the Schedule Description is Schedule_1, Day is Sat and Sun, Start Time is 1800 and Stop Time is 2000.
6. Click the submenu **Rule of Access Control** in the left, Click **Add New...** button to add a new rule as follows:
 - 1) In Rule Name field, create a name for the rule. Note that this name should be unique, for example Rule_1.
 - 2) In Host field, select Host_1.
 - 3) In Target field, select Target_1.
 - 4) In Schedule field, select Schedule_1.
 - 5) In Status field, select **Enabled**.
 - 6) Click **Save** to complete the settings.

Then you will go back to the **Access Control Rule Management** page and see the following list.

ID	Rule Name	Host	Target	Schedule	Enable	Modify
1	Rule_1	Host_1	Target_1	Schedule_1	<input checked="" type="checkbox"/>	Edit Delete

4.16.2 Host

Choose menu “**Access Control → Host**”, and then you can view and set a Host list in the screen as shown in Figure 4-88. The host list is necessary for the Access Control Rule.

Host Settings			
ID	Host Description	Information	Modify
1	Host_1	IP: 192.168.1.23	Edit Delete
<input type="button" value="Add New..."/> <input type="button" value="Delete All"/>			
<input type="button" value="Previous"/> <input type="button" value="Next"/> Current No. <input type="text" value="1"/> Page			

Figure 4-88 Host Settings

- **Host Description** - Here displays the description of the host and this description is unique.
- **Information** - Here displays the information about the host. It can be IP or MAC.
- **Modify** - To modify or delete an existing entry.

To add a new entry, please follow the steps below.

1. Click the **Add New...** button.
2. In the **Mode** field, select IP Address or MAC Address.
 - 1) If you select IP Address, the screen shown is Figure 4-89.
 - In **Host Description** field, create a unique description for the host (e.g. Host_1).
 - In **LAN IP Address** field, enter the IP address.
 - 2) If you select MAC Address, the screen shown is Figure 4-90.
 - In **Host Description** field, create a unique description for the host (e.g. Host_1).
 - In **MAC Address** field, enter the MAC address.
3. Click the **Save** button to complete the settings.

Click the **Delete All** button to delete all the entries in the table.

Click the **Next** button to go to the next page, or click the **Previous** button to return to the previous page.

The screenshot shows a web form titled "Add or Modify a Host Entry". The "Mode" dropdown menu is set to "IP Address". The "Host Description" field contains the text "Host_1". The "LAN IP Address" field contains "192.168.1.23" followed by a hyphen and an empty input box. At the bottom of the form are two buttons: "Save" and "Back".

Figure 4-89 Add or Modify a Host Entry

The screenshot shows a web form titled "Add or Modify a Host Entry". The "Mode" dropdown menu is set to "MAC Address". The "Host Description" field contains the text "Host_1". The "MAC Address" field contains the text "00-11-22-33-44-AA". At the bottom of the form are two buttons: "Save" and "Back".

Figure 4-90 Add or Modify a Host Entry

For example: If you desire to restrict the internet activities of host with MAC address 00-11-22-33-44-AA, you should first follow the settings below:

1. Click **Add New...** button in Figure 4-88 to enter the **Add or Modify a Host Entry** page.

2. In **Mode** field, select **MAC Address** from the drop-down list.
3. In **Host Description** field, create a unique description for the host (e.g. Host_1).
4. In **MAC Address** field, enter 00-11-22-33-44-AA.
5. Click **Save** to complete the settings.

Then you will go back to the Host Settings page and see the following list.

ID	Host Description	Information	Modify
1	Host_1	MAC: 00-11-22-33-44-AA	Edit Delete

4.16.3 Target

Choose menu “**Access Control** → **Target**”, and then you can view and set a Target list in the screen as shown in Figure 4-91. The target list is necessary for the Access Control Rule.

Target Settings			
ID	Target Description	Information	Modify
1	Target_1	192.168.1.23/21/TCP	Edit Delete

Current No. Page

Figure 4-91 Target Settings

- **Target Description** - Here displays the description about the target and this description is unique.
- **Information** - The target can be IP address, port, or domain name.
- **Modify** - To modify or delete an existing entry.

To add a new entry, please follow the steps below.

1. Click the **Add New...** button.
2. In Mode field, select **IP Address** or **Domain Name**.
3. If you select **IP Address**, the screen shown is Figure 4-92.

The screenshot shows a web form titled "Add or Modify an Access Target Entry". The form has a green header bar with the title. Below the header, there are several fields:

- Mode:** A dropdown menu currently showing "IP Address".
- Target Description:** A single-line text input field.
- IP Address:** Two text input fields separated by a hyphen, for entering the IP address.
- Target Port:** Two text input fields separated by a hyphen, for entering the target port.
- Protocol:** A dropdown menu currently showing "ALL".
- Common Service Port:** A dropdown menu currently showing "--please select--".

 At the bottom of the form, there are two buttons: "Save" and "Back".

Figure 4-92 Add or Modify an Access Target Entry

- 1) In **Target Description** field, create a unique description for the target (e.g. Target_1).
 - 2) In **IP Address** field, enter the IP address of the target.
 - 3) Select a common service from **Common Service Port** drop-down list, so that the **Target Port** will be automatically filled. If the **Common Service Port** drop-down list doesn't have the service you want, specify the **Target Port** manually.
 - 4) In **Protocol** field, select TCP, UDP, ICMP or ALL from the drop-down list.
4. If you select **Domain Name**, the screen shown is Figure 4-93.

The screenshot shows the same web form as Figure 4-92, but with the **Mode** dropdown menu set to "Domain Name". The **Target Description** field remains. The **Domain Name** field is now a multi-line text input area with four stacked boxes for entering domain names. The **IP Address**, **Target Port**, **Protocol**, and **Common Service Port** fields are no longer visible. The "Save" and "Back" buttons remain at the bottom.

Figure 4-93 Add or Modify an Access Target Entry

- 1) In **Target Description** field, create a unique description for the target (e.g. Target_1).
 - 2) In **Domain Name** field, enter the domain name, either the full name or the keywords (for example, google) in the blank. Any domain name with keywords in it (www.google.com, www.google.cn) will be blocked or allowed. You can enter 4 domain names.
5. Click the **Save** button.

Click the **Delete All** button to delete all the entries in the table.

Click the **Next** button to go to the next page, or click the **Previous** button to return to the previous page.

For example: If you desire to restrict the internet activities of host with MAC address 00-11-22-33-44-AA in the LAN to access www.google.com only, you should first follow the settings below:

1. Click **Add New...** button in Figure 4-91 to enter the Add or Modify an Access Target Entry page.
2. In **Mode** field, select Domain Name from the drop-down list.
3. In **Target Description** field, create a unique description for the target (e.g. Target_1).
4. In **Domain Name** field, enter www.google.com.
5. Click **Save** to complete the settings.

Then you will go back to the Target Settings page and see the following list.

ID	Target Description	Information	Modify
1	Target_1	www.google.com	Edit Delete

4.16.4 Schedule

Choose menu “**Access Control** → **Schedule**”, and then you can view and set a Schedule list in the next screen as shown in Figure 4-94. The Schedule list is necessary for the Access Control Rule.

Schedule Settings				
ID	Schedule Description	Day	Time	Modify
1	Schedule_1	Every Day	08:00 - 20:00	Edit Delete

Current No. 1 Page

Figure 4-94 Schedule Settings

- **Schedule Description** - Here displays the description of the schedule and this description is unique.
- **Day** - Here displays the day(s) in a week.
- **Time** - Here displays the time period in a day.
- **Modify** - Here you can edit or delete an existing schedule.

To add a new schedule, follow the steps below:

1. Click **Add New...** button shown in Figure 4-94 and the next screen will pop-up as shown in Figure 4-95.

2. In **Schedule Description** field, create a unique description for the schedule (e.g. Schedule_1).
3. In **Day** field, select the day or days you need.
4. In **Time** field, you can select all day-24 hours or you may enter the Start Time and Stop Time in the corresponding field.
5. Click **Save** to complete the settings.

Click the **Delete All** button to delete all the entries in the table.

Click the **Next** button to go to the next page, or click the **Previous** button to return to the previous page.

Figure 4-95 Advanced Schedule Settings

For example: If you desire to restrict the internet activities of host with MAC address 00-11-22-33-44-AA to access www.google.com only from **18:00 to 20:00** on **Saturday** and **Sunday**, you should first follow the settings below:

1. Click **Add New...** button shown in Figure 4-94 to enter the Advanced Schedule Settings page.
2. In **Schedule Description** field, create a unique description for the schedule (e.g. Schedule_1).
3. In **Day** field, check the Select Days radio button and then select Sat and Sun.
4. In **Time** field, enter 1800 in Start Time field and 2000 in Stop Time field.
5. Click **Save** to complete the settings.

Then you will go back to the Schedule Settings page and see the following list.

ID	Schedule Description	Day	Time	Modify
1	Schedule_1	Sat Sun	18:00 - 20:00	Edit Delete

4.17 Advanced Routing

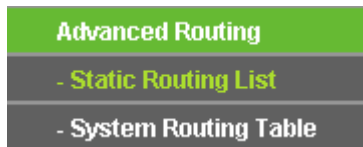

Figure 4-96 Advanced Routing

There are two submenus under the Advanced Routing menu as shown in Figure 4-96: **Static Routing List** and **System Routing Table**. Click any of them, and you will be able to configure the corresponding function.

4.17.1 Static Routing List

Choose menu “**Advanced Routing** → **Static Routing List**”, and then you can configure the static route in the next screen (shown in Figure 4-97). A static route is a pre-determined path that network information must travel to reach a specific host or network.

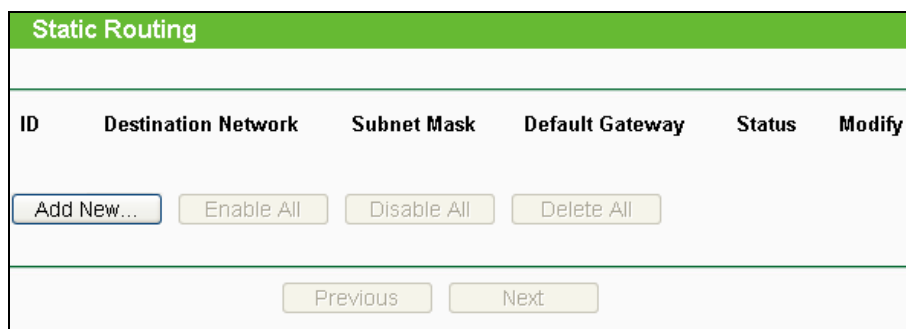

Figure 4-97 Static Routing

To add static routing entries:

1. Click **Add New...** shown in Figure 4-97, you will see the following screen.

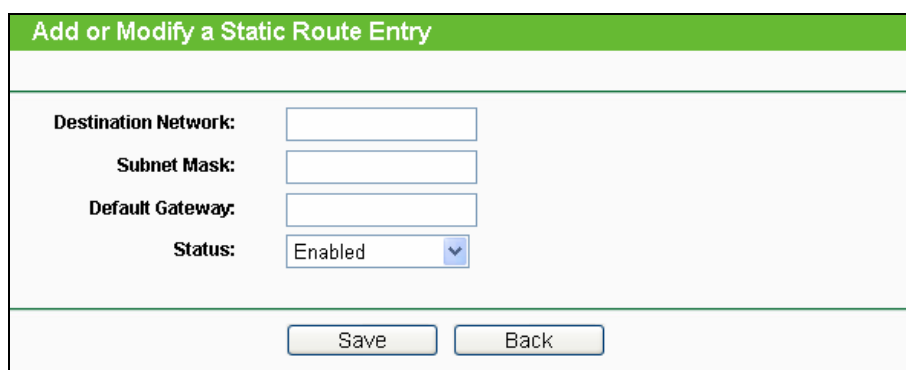

Figure 4-98 Add or Modify a Static Route Entry

2. Enter the following data:

- **Destination Network** - The Destination Network is the address of the network or host that you want to assign to a static route.
 - **Subnet Mask** - The **Subnet Mask** determines which portion of an IP Address is the network portion, and which portion is the host portion.
 - **Default Gateway** - This is the IP Address of the gateway device that allows for contact between the router and the network or host.
3. Select **Enabled** or **Disabled** for this entry on the **Status** drop-down list.
 4. Click the **Save** button to make the entry take effect.

Other configurations for the entries:

Click the **Delete** button to delete the entry.

Click the **Enable All** button to enable all the entries.

Click the **Disable All** button to disable all the entries.

Click the **Delete All** button to delete all the entries.

Click the **Previous** button to view the information in the previous screen, click the **Next** button to view the information in the next screen.

4.17.2 System Routing Table

Choose menu “**Advanced Routing** → **System Routing Table**”, and then you can view the System Routing Table in the next screen (shown in Figure 4-99). System routing table views all of the valid route entries in use. The Destination IP address, Subnet Mask, Gateway, and Interface will be displayed for each entry.

System Routing Table				
ID	Destination Network	Subnet Mask	Gateway	Interface
1	192.168.0.0	255.255.255.0	0.0.0.0	LAN & WLAN
2	1.0.0.0	255.0.0.0	0.0.0.0	WAN
3	239.0.0.0	255.0.0.0	0.0.0.0	LAN & WLAN
4	0.0.0.0	0.0.0.0	1.0.0.1	WAN

Figure 4-99 System Routing Table

- **Destination Network** - The Destination Network is the address of the network or host to which the static route is assigned.
- **Subnet Mask** - The Subnet Mask determines which portion of an IP address is the network portion, and which portion is the host portion.

- **Gateway** - This is the IP address of the gateway device that allows for contact between the router and the network or host.
- **Interface** - This interface tells you either the Destination IP Address is on the **LAN & WLAN** (internal wired and wireless networks), or on the **WAN** (Internet).

4.18 Bandwidth Control



Figure 4-100 Bandwidth Control

There are two submenus under the Bandwidth Control menu as shown in Figure 4-100: **Control Settings** and **Rules List**. Click any of them, and you will be able to configure the corresponding function. The detailed explanations for each submenu are provided below.

4.18.1 Control Settings

Choose menu "**Bandwidth Control** → **Control Settings**", and then you can configure the Egress Bandwidth and Ingress Bandwidth. For optimal control of the bandwidth, please select the right Line Type and ask your ISP for the total bandwidth of the egress and ingress.

 A screenshot of a web form titled "Bandwidth Control Settings". The form has a green header bar. Below the header, there are several fields:

- Enable Bandwidth Control:** An unchecked checkbox.
- Line Type:** Two radio buttons, "ADSL" (which is selected) and "Other".
- Egress Bandwidth:** A text input field containing the number "512" followed by "Kbps".
- Ingress Bandwidth:** A text input field containing the number "2048" followed by "Kbps".

 At the bottom of the form is a "Save" button.

Figure 4-101 Bandwidth Control Settings

- **Enable Bandwidth Control** - Check this box so that the Bandwidth Control settings can take effect.
- **Line Type** - Select the right type for you network connection. If you don't know how to choose, please ask your ISP for the information.
- **Egress Bandwidth** - The upload speed through the Internet port. Its value should be less than 1000000Kbps.
- **Ingress Bandwidth** - The download speed through the Internet port. Its value should be less than 1000000Kbps.

4.18.2 Rules List

Choose menu “**Bandwidth Control → Rules List**”, and then you can view and configure the Bandwidth Control rules in the screen below.

Bandwidth Control Rules List							
ID	Description	Egress Bandwidth(Kbps)		Ingress Bandwidth(Kbps)		Enable	Modify
		Min	Max	Min	Max		
1	192.168.1.2 - 192.168.1.23/21/TCP	0	1000	0	4000	<input checked="" type="checkbox"/>	Modify Delete

Now is the page

Figure 4-102 Bandwidth Control Rules List

- **Description** - This is the information about the rules such as address range.
- **Egress bandwidth** - This field displays the max and mix upload bandwidth through the Internet port, the default is 0.
- **Ingress bandwidth** - This field displays the max and mix download bandwidth through the Internet port, the default is 0.
- **Enable** - This displays the status of the rule.
- **Modify** - Click **Modify** to edit the rule. Click **Delete** to delete the rule.

To add/modify a Bandwidth Control rule, follow the steps below.

1. Click the **Add New...** button. The **Bandwidth Control Rule Settings** page will appear.
2. Enter the information as shown in the below figure.

Bandwidth Control Rule Settings

Enable:

IP Range: -

Port Range: -

Protocol:

	Min Bandwidth(Kbps)	Max Bandwidth(Kbps)
Egress Bandwidth:	<input type="text" value="0"/>	<input type="text" value="1000"/>
Ingress Bandwidth:	<input type="text" value="0"/>	<input type="text" value="4000"/>

Figure 4-103 Bandwidth Control Rule Settings

3. Click the **Save** button.

4.19 IP & MAC Binding Setting

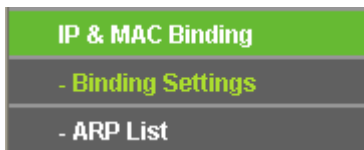

Figure 4-104 IP & MAC Binding menu

There are two submenus under the IP & MAC Binding menu (shown in Figure 4-104): **Binding Settings** and **ARP List**. Click any of them, and you will be able to scan or configure the corresponding function. The detailed explanations for each submenu are provided below.

4.19.1 Binding Settings

Choose menu “**IP & MAC Binding** → **Binding Settings**”, and then you can bind IP addresses and MAC addresses on the following screen.

The screenshot shows the 'Binding Settings' page. At the top, there is a green header 'Binding Settings'. Below it, there is a section for 'ARP Binding' with radio buttons for 'Disable' (selected) and 'Enable', and a 'Save' button. Below this is a table with columns: ID, MAC Address, IP Address, Bind, and Modify. There is one entry with ID 1, MAC Address 50-E5-49-C7-64-6E, IP Address 192.168.1.102, and the Bind checkbox checked. The Modify column contains links for 'Modify' and 'Delete'. Below the table are buttons for 'Add New...', 'Enable All', 'Disable All', 'Delete All', and 'Find'. At the bottom, there are 'Previous' and 'Next' buttons, and a 'Current No.' dropdown set to '1' followed by 'Page'.

ID	MAC Address	IP Address	Bind	Modify
1	50-E5-49-C7-64-6E	192.168.1.102	<input checked="" type="checkbox"/>	Modify Delete

Figure 4-105 Binding Setting

- **MAC Address** - The MAC address of the controlled computer in the LAN.
- **IP Address** - The assigned IP address of the controlled computer in the LAN.
- **Bind** - Check this option to enable ARP binding for a specific device.
- **Modify** - To modify or delete an existing entry.

To add IP & MAC Binding entries, follow the steps below:

1. Click the **Add New...** button. The **IP & MAC Binding Settings** page will appear.
2. Enter the MAC address and IP address.
3. Select the **Bind** checkbox.
4. Click the **Save** button to save it.

Figure 4-106 IP & MAC Binding Setting (Add & Modify)

To modify or delete an existing entry, follow the steps below:

1. Find the desired entry in the table.
2. Click **Modify** or **Delete** as desired on the **Modify** column.

To find an existing entry, follow the steps below:

1. Click the **Find** button. The **Find IP & MAC Binding Entry** page will appear.
2. Enter the MAC address or IP address.
3. Click the **Find** button.

ID	MAC Address	IP Address	Bind	Link
1	50-E5-49-C7-64-6E	192.168.1.102	<input checked="" type="checkbox"/>	To page

Figure 4-107 Find IP & MAC Binding Entry

Click the **Enable All** button to enable all entries.

Click the **Disable All** button to disable all entries.

Click the **Delete All** button to delete all entries.

4.19.2 ARP List

Choose menu “**IP & MAC Binding** → **ARP List**”, and then you can view the ARP list (including all existing IP & MAC binding entries) and configure ARP entries on the following screen.

ID	MAC Address	IP Address	Status	Configure
1	40-61-86-CF-20-7A	192.168.0.101	Unbound	Load Delete

Figure 4-108 ARP List

- **MAC Address** - The MAC address of the controlled computer in the LAN.
- **IP Address** - The assigned IP address of the controlled computer in the LAN.
- **Status** - Indicates whether or not the MAC and IP addresses are bound.
- **Configure** - Load or delete an item.
 - **Load** - Load the item to the IP & MAC Binding list.
 - **Delete** - Delete the item.

Click the **Bind All** button to bind all the current items, available after enable.

Click the **Load All** button to load all items to the IP & MAC Binding list.

Click the **Refresh** button to refresh all items.

 **Note:**

An item could not be loaded to the IP & MAC Binding list if the IP address of the item has been loaded before. Error warning will prompt as well. Likewise, "Load All" only loads the items without interference to the IP & MAC Binding list.

4.20 Dynamic DNS

Choose menu "**Dynamic DNS**", and you can configure the Dynamic DNS function.

The router offers the DDNS (Dynamic Domain Name System) feature, which allows the hosting of a website, FTP server, or e-mail server with a fixed domain name (named by yourself) and a dynamic IP address, and then your friends can connect to your server by entering your domain name no matter what your IP address is. Before using this feature, you need to sign up for DDNS service providers such as www.comexe.cn, www.dyndns.org, or www.no-ip.com. The Dynamic DNS client service provider will give you a password or key.

4.20.1 Comexe DDNS

If the dynamic DNS **Service Provider** you select is Comexe (www.comexe.cn), the page will appear as shown in Figure 4-109.

Figure 4-109 Comexe DDNS Settings

To set up for DDNS, follow these instructions:

1. Enter the **Domain Name** your dynamic DNS service provider gave.
2. Enter the **User Name** for your DDNS account.
3. Enter the **Password** for your DDNS account.
4. Click the **Login** button to login the DDNS service.

Connection Status -The status of the DDNS service connection is displayed here.

Click **Logout** to log out of the DDNS service.

Note:

If you want to login again with another account after a successful login, please click the **Logout** button, then input your new username and password and click the **Login** button.

4.20.2 Dyndns DDNS

If the dynamic DNS **Service Provider** you select is Dyndns (www.dyndns.org), the page will appear as shown in Figure 4-110.

Figure 4-110 DynDNS DDNS Settings

To set up for DDNS, follow these instructions:

1. Enter the **User Name** for your DDNS account.
2. Enter the **Password** for your DDNS account.
3. Enter the **Domain Name** you received from dynamic DNS service provider.
4. Click the **Login** button to login to the DDNS service.

Connection Status -The status of the DDNS service connection is displayed here.

Click **Logout** to logout of the DDNS service.

 **Note:**

If you want to login again with another account after a successful login, please click the **Logout** button, then input your new username and password and click the **Login** button.

4.20.3 No-IP DDNS

If the dynamic DNS **Service Provider** you select is No-IP (www.no-ip.com), the page will appear as shown in Figure 4-111.

Figure 4-111 No-IP DDNS Settings

To set up for DDNS, follow these instructions:

1. Enter the **User Name** for your DDNS account.
2. Enter the **Password** for your DDNS account.
3. Enter the **Domain Name** you received from dynamic DNS service provider.
4. Click the **Login** button to login to the DDNS service.

Connection Status - The status of the DDNS service connection is displayed here.

Click **Logout** to log out the DDNS service.

 **Note:**

If you want to login again with another account after a successful login, please click the **Logout** button, then input your new username and password and click the **Login** button.

4.21 System Tools

System Tools
- Time Settings
- Diagnostic
- Firmware Upgrade
- Factory Defaults
- Backup & Restore
- Reboot
- Password
- System Log
- Statistics

Figure 4-112 System Tools menu

There are nine submenus under the System Tools menu (shown in Figure 4-112): **Time Settings**, **Diagnostic**, **Firmware Upgrade**, **Factory Defaults**, **Backup & Restore**, **Reboot**, **Password**, **System Log** and **Statistics**. Click any of them, and you will be able to configure the corresponding function. The detailed explanations for each submenu are provided below.

4.21.1 Time Setting

Choose menu “**System Tools** → **Time Setting**”, and then you can configure the time on the following screen.

Figure 4-113 Time settings

- **Time Zone** - Select your local time zone.
- **Date** - Enter your local date in MM/DD/YY format.
- **Time** - Enter your local time in HH/MM/SS format.
- **NTP Server 1/NTP Server 2** - Enter the IP address or domain name of the **NTP Server 1** or **NTP Server 2**, and then the router will get the time from the NTP server preferentially. In addition, the router has some build-in NTP servers, so it can get time automatically once it connects to the Internet.
- **Enable Daylight Saving** - Check the box to enable the Daylight Saving function.
- **Start** - The time to start the Daylight Saving. Select the month in the first field, the week in the second field, the day in the third field and the time in the last field.
- **End** - The time to end the Daylight Saving. Select the month in the first field, the week in the second field, the day in the third field and the time in the last field.
- **Daylight Saving Status** - Displays whether the Daylight Saving is in use.

To set time manually:

1. Select your local time zone.

2. Enter your local date in MM/DD/YY format.
3. Enter your local time in HH/MM/SS format.
4. Click **Save**.

To set time automatically:

1. Select your local time zone.
2. Enter the address or domain of **NTP Server 1** or **NTP Server 2**.
3. Click the **Get GMT** button to get system time from Internet if you have connected to the Internet.

To set Daylight Saving:

1. Check the box to enable Daylight Saving.
2. Select the start time from the drop-down lists in the **Start** field.
3. Select the end time from the drop-down lists in the **End** field.
4. Click **Save**.

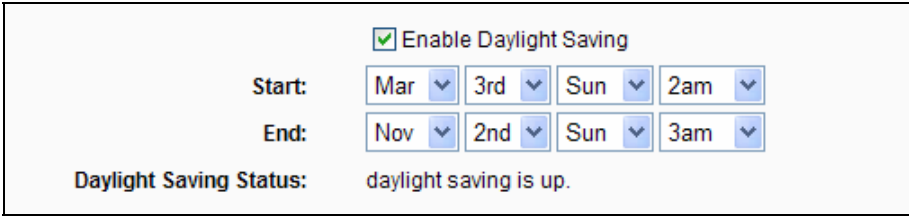

Enable Daylight Saving

Start: Mar 3rd Sun 2am

End: Nov 2nd Sun 3am

Daylight Saving Status: daylight saving is up.

Figure 4-114 Time settings

Note:

- 1) This setting will be used for some time-based functions such as firewall. You must specify your time zone once you log in to the router successfully, otherwise, these functions will not take effect.
- 2) Time settings will be lost if the router is turned off.
- 3) The router will automatically obtain GMT from the Internet if it is configured accordingly.
- 4) The Daylight Saving will take effect one minute after the configurations are completed.

4.21.2 Diagnostic

Choose menu "**System Tools** → **Diagnostic**", and then you can use the **Ping** or **Traceroute** function to check connectivity of your network in the following screen.

Diagnostic Tools

Diagnostic Parameters

Diagnostic Tool: Ping Traceroute

IP Address/ Domain Name:

Ping Count: (1-50)

Ping Packet Size: (4-1472 Bytes)

Ping Timeout: (100-2000 Milliseconds)

Traceroute Max TTL: (1-30)

Diagnostic Results

The Router is ready.

Figure 4-115 Diagnostic Tools

- **Diagnostic Tool** - Check the radio button to select a diagnostic tool.
- **Ping** - This diagnostic tool tests connectivity, reachability, and name resolution to a given host or gateway.
- **Traceroute** - This diagnostic tool tests the performance of a connection.

 **Note:**

You can use ping/traceroute by using the IP address or domain name. If pinging/tracerouting the IP address is successful, but pinging/tracerouting the domain name is not, you might have a name resolution problem. In this case, ensure that the domain name you specified can be resolved by using DNS (Domain Name System) queries.

- **IP Address/Domain Name** - Enter the IP address or domain name of the PC whose connection you wish to diagnose.
- **Pings Count** - Specifies the number of Echo Request messages sent. The default value is 4.
- **Ping Packet Size** - Specifies the number of data bytes to be sent. The default value is 64.
- **Ping Timeout** - Time to wait for a response, in milliseconds. The default value is 800.
- **Traceroute Max TTL** - Set the maximum number of hops (max TTL to be reached) in the path to search for the target (destination). The default value is 20.

Click **Start** to check the connectivity of the Internet.

The **Diagnostic Results** field displays the Ping/Traceroute result.

If the result is similar to the following screen, the connectivity of the Internet is fine.

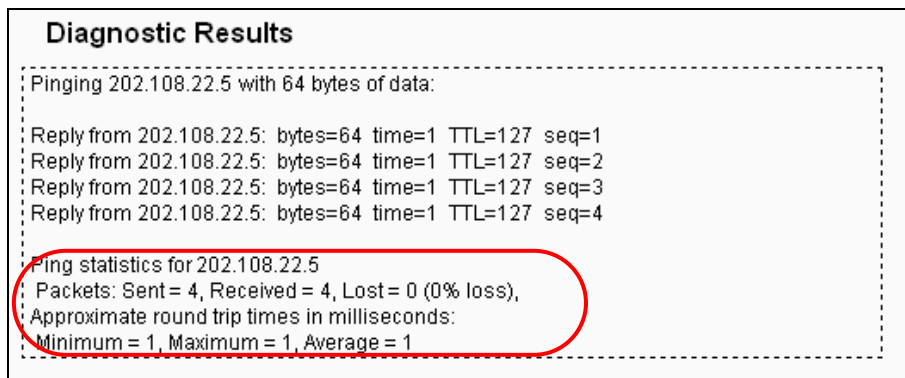

Figure 4-116 Diagnostic Results

 **Note:**

- 1) Only one user can use the diagnostic tools at one time.
- 2) "Ping Count", "Ping Packet Size" and "Ping Timeout" are Ping parameters, and "Traceroute Max TTL" is Traceroute parameter.

4.21.3 Firmware Upgrade

Choose menu "**System Tools** → **Firmware Upgrade**", and then you can update the latest version of firmware for the router on the following screen.

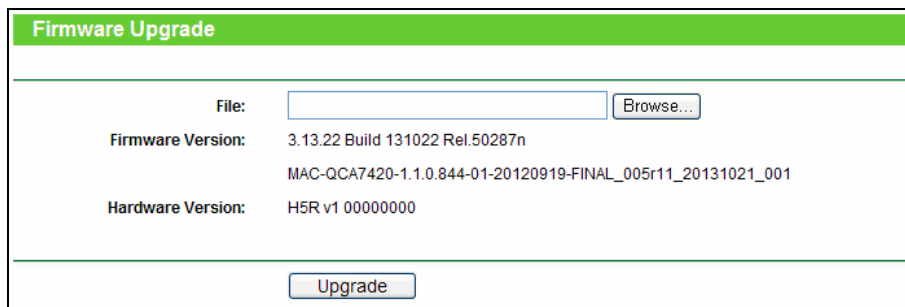

Figure 4-117 Firmware Upgrade

- **Firmware Version** - Displays the current firmware version.
- **Hardware Version** - Displays the current hardware version. The hardware version of the upgrade file must accord with the router's current hardware version.

To upgrade the router's firmware, follow these instructions below:

1. Download a most recent firmware upgrade file from our website (www.tp-link.com).
2. Enter or select the path name → where you save the downloaded file on the computer into the **File** field.

3. Click the **Upgrade** button.
4. The router will reboot while the upgrading has been finished.

 **Note:**

- 1) New firmware versions are posted at <http://www.tp-link.com> and can be downloaded for free. There is no need to upgrade the firmware unless the new firmware has a new feature you want to use. However, when experiencing problems caused by the router rather than the configuration, you can try to upgrade the firmware.
- 2) When you upgrade the router's firmware, you may lose its current configurations, so before upgrading the firmware please write down some of your customized settings to avoid losing important settings.
- 3) Do not turn off or reset the router while the firmware is being upgraded. Loss of power during the upgrade could damage the router.
- 4) The firmware version must correspond to the hardware.
- 5) The upgrade process takes a few moments and the router reboots automatically when the upgrade is complete.

4.21.4 Factory Defaults

Choose menu “**System Tools** → **Factory Defaults**”, and then you can restore the configurations of the router to factory defaults on the following screen.

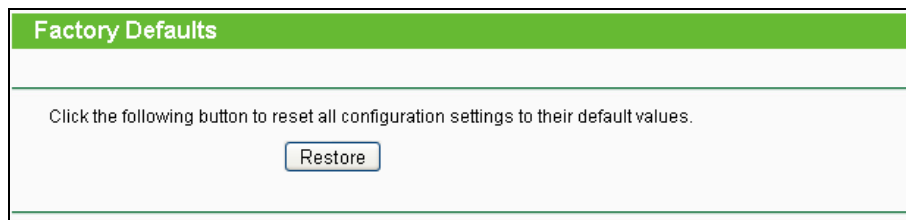

Figure 4-118 Factory Defaults

Click the **Restore** button to reset all configuration settings to their default values.

- Default **User Name**: admin
- Default **Password**: admin
- Default **IP Address**: 192.168.1.1
- Default **Subnet Mask**: 255.255.255.0

 **Note:**

All user-defined settings will be lost after the restoration.

4.21.5 Backup & Restore

Choose menu “**System Tools** → **Backup & Restore**”, and then you can save the current configuration of the router as a backup file and restore the configuration via a backup file as shown in Figure 4-119.

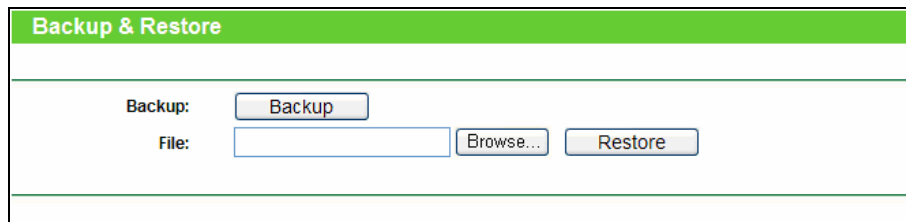

Figure 4-119 Backup & Restore

- Click the **Backup** button to save all configuration settings as a backup file in your local computer.
- To restore the router's configuration, follow these instructions.
 1. Click the **Browse** button to find the configuration file which you want to restore.
 2. Click the **Restore** button to update the configuration with the file whose path is the one you have input or selected in the blank.

 **Note:**

The current configuration will be covered with the uploading configuration file. Wrong process will lead the device unmanaged. The restoring process lasts for 20 seconds and the router will reboot automatically then. Keep the power of the router on during the process, in case of any damage.

4.21.6 Reboot

Choose menu “**System Tools** → **Reboot**”, and then you can reboot the router on the following screen.

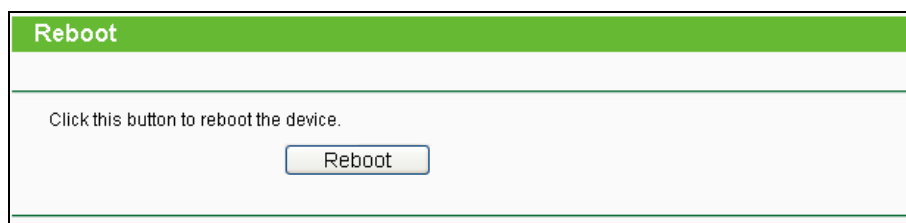

Figure 4-120 Reboot the router

Some settings of the router will take effect only after rebooting, which include:

- Change the LAN IP address (system will reboot automatically).
- Change the DHCP settings.

- Change the Wireless configurations.
- Change the Web management port.
- Upgrade the firmware of the router (system will reboot automatically).
- Restore the router's settings to factory defaults (system will reboot automatically).
- Update the configuration with the file (system will reboot automatically).

4.21.7 Password

Choose menu “**System Tools** → **Password**”, and then you can change the factory default user name and password of the router in the next screen as shown in Figure 4-121.

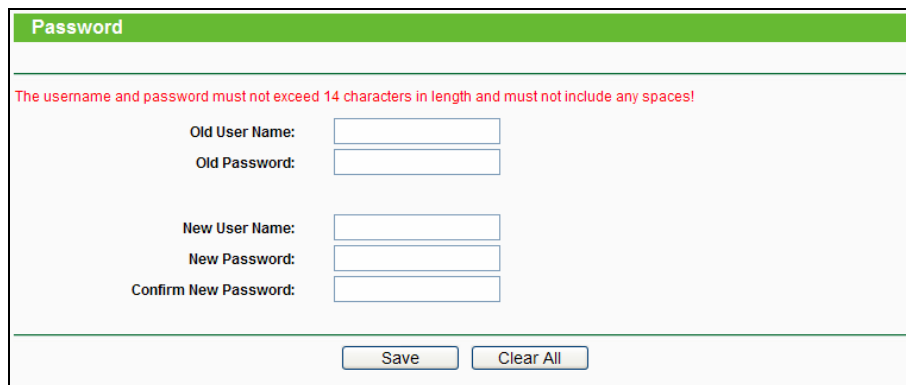

The screenshot shows a web interface titled "Password" with a green header. Below the header, a red warning message states: "The username and password must not exceed 14 characters in length and must not include any spaces!". The form contains six input fields: "Old User Name:", "Old Password:", "New User Name:", "New Password:", and "Confirm New Password:". At the bottom of the form, there are two buttons: "Save" and "Clear All".

Figure 4-121 Password

It is strongly recommended that you change the default user name and password of the router, because all users who try to access the router's Web-based utility or Quick Setup will be prompted for the router's default user name and password.

Note:

The new user name and password must not exceed 14 characters in length and must not include any spaces. Enter the new password twice to confirm it.

Click the **Save** button to save the settings.

Click the **Clear All** button to clear all fields.

4.21.8 System Log

Choose menu “**System Tools** → **System Log**”, and then you can view the logs of the router.

Figure 4-122 System Log

- **Auto Mail Feature** - Indicates whether auto mail feature is enabled or not.
- **Mail Settings** - Set the sending and receiving mailbox addresses, SMTP server address, validation information as well as the timetable for Auto Mail Feature, as shown in Figure 4-123.

Figure 4-123 Mail Account Settings

- **From** - Your mail box address. The router will connect it to send logs.
- **To** - Recipient's mail box address. It will receive the logs sent.

- **SMTP Server** - Your SMTP server. It corresponds with the mailbox filled in the **From** field. You can log on to the relevant website for help if you are not clear with the address.
- **Authentication** - Most SMTP server requires authentication. It is required by most mailboxes that need user name and password to log in.

 **Note:**

When you select the **Authentication** check box, you need to enter your user name and password in the following fields.

- **User Name** - Your mail account name filled in the **From** field. The part behind @ is excluded.
- **Password** - Your mail account password.
- **Confirm The Password** - Enter the password again to confirm.
- **Enable Auto Mail Feature** - Specifies whether to mail logs automatically. After selecting this check box, you can further set either the time or interval for mailing logs.

Click **Save** to save the settings.

Click **Back** to return to the previous page.

- **Log Type** - By selecting the log type, only logs of this type will be shown.
- **Log Level** - By selecting the log level, only logs of this level will be shown.
- **Refresh** - Refresh the page to display the latest log list.
- **Save Log** - Click this button to save all the logs in a txt file.
- **Mail Log** - Click to send an email of current logs manually according to the address and validation information set in Mail Settings.
- **Clear Log** - All the logs will be deleted from the router permanently, not just from the page.

Click the **Next** button to go to the next page, or click the **Previous** button to return to the previous page.

4.21.9 Statistics

Choose menu "**System Tools** → **Statistics**", and then you can view the statistics of the router, including total traffic and current traffic of the last Packets Statistic Interval.

Statistics								
Current Statistics Status:		Disabled		Enable				
Packets Statistics Interval(5-60):		10		Seconds				
		<input type="checkbox"/> Auto-refresh		Refresh				
Sorted Rules:		Sorted by Current Bytes		Reset All		Delete All		
	Total	Current						
IP Address/ MAC Address	Packets	Bytes	Packets	Bytes	ICMP Tx	UDP Tx	SYN Tx	Modify
The current list is empty.								
5		entries per page.		Current No.		1		page
Previous		Next						

Figure 4-124 Statistics

- **Current Statistics Status** - Enable or Disable. The default value is disabled. To enable it, click the **Enable** button. If it is disabled, the function of DoS protection in Security settings will be disabled.
- **Packets Statistics Interval (5-60)** - The default value is 10. Select a value between 5 and 60 seconds in the drop-down list. The Packets Statistic interval indicates the time section of the packets statistic.
- **Sorted Rules** - Choose how the displayed statistics are sorted.

Select the **Auto-refresh** checkbox to refresh automatically.

Click the **Refresh** button to refresh immediately.

Click **Reset All** to reset the values of all the entries to zero.

Click **Delete All** to delete all entries in the table.

Statistics Table:

IP/MAC Address		The IP and MAC address are displayed with related statistics.
Total	Packets	The total number of packets received and transmitted by the router.
	Bytes	The total number of bytes received and transmitted by the router.
Current	Packets	The total number of packets received and transmitted in the last Packets Statistic interval seconds.
	Bytes	The total number of bytes received and transmitted in the last Packets Statistic interval seconds.
	ICMP Tx	The number of the ICMP packets transmitted to WAN per second at the specified Packets Statistics interval. It is shown like "current transmitting rate / Max transmitting rate".
	UDP Tx	The number of UDP packets transmitted to the WAN per second at the specified Packets Statistics interval. It is shown like "current transmitting rate / Max transmitting rate".
	SYN Tx	The number of TCP SYN packets transmitted to the WAN per second at the specified Packets Statistics interval. It is shown like "current transmitting rate / Max transmitting rate".
Modify	Reset	Reset the value of the entry to zero.
	Delete	Delete the existing entry in the table.

There would be 5 entries on each page. Click **Previous** to return to the previous page and **Next** to the next page.

Chapter 5. Configuring the Extender

This chapter will describe the key functions and configuration way of the extender's Web management page.

5.1 Login

To access the web management page of the extender, open a web-browser, type <http://tplinkextender.net> (for wireless connection only) or <http://192.168.1.254> in the address field and press **Enter**. Then, use the default user name and password (**admin/admin**) to log in.

After your successful login, you will see the main menus on the left of the Web-based utility. On the right, there are the corresponding explanations and instructions.

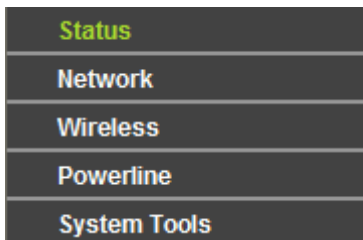
A vertical list of five menu items: Status, Network, Wireless, Powerline, and System Tools. The 'Status' item is highlighted in green.

Status
Network
Wireless
Powerline
System Tools

The detailed explanations for each Web page's key function are listed below.

5.2 Status

The Status page provides the current status information about the extender. All information is read-only.

Status	
Firmware Version:	1.0.0 Build 131028 Rel.61978n MAC-QCA7420-1.1.0.844-01-20120919-FINAL_005e11_20131025_001
Hardware Version:	H5E 1.0 00000000
Powerline	
MAC Address:	00-5E-AA-08-01-06
Device Password:	GGAG-URPZ-NOKG-HIXV
Network Name:	Unknown Network Name
LAN	
MAC Address:	00-5E-AA-08-01-05
IP Address:	192.168.1.254
Subnet Mask:	255.255.255.0
Wireless	
Wireless Radio:	Enable
Name (SSID):	abc
Mode:	11bgn mixed
Channel:	Auto (Current channel 1)
Channel Width:	Automatic
MAC Address:	00-5E-AA-08-01-05
System Up Time:	0 days 00:00:47 Refresh

Figure 5-1 Status

5.3 Network



Figure 5-2 Network menu

There is only one submenu under the Network menu (shown in Figure 5-2): **LAN**. Click it, and you will be able to configure the corresponding function.

5.3.1 LAN

Choose menu “**Network** → **LAN**”, and then you can configure the IP parameters of the LAN on the screen as below.

LAN	
MAC Address:	00-5E-AA-08-01-05
IP Address:	<input type="text" value="192.168.1.254"/>
Subnet Mask:	<input type="text" value="255.255.255.0"/> ▼
<input type="button" value="Save"/>	

Figure 5-3 LAN

- **MAC Address** - The physical address of the extender. The value can't be changed.

- **IP Address** - Enter the IP address of your extender or reset it in dotted-decimal notation (factory default: 192.168.1.254).
- **Subnet Mask** - An address code that determines the size of the network. Normally use 255.255.255.0 as the subnet mask.

 **Note:**

If you change the IP Address of LAN, you must use the new IP Address to log in to the extender.

5.4 Wireless



Figure 5-4 Wireless menu

There is only one submenu under the Network menu (shown in Figure 5-4): **Wireless Statistics**. Click it, and you will be able to configure the corresponding function.

5.4.1 Wireless Statistics

Choose menu “**Wireless → Wireless Statistics**”, and then you can see the MAC Address, Current Status, Received Packets and Sent Packets for each connected wireless station.

Wireless Statistics				
Current Connected Wireless Stations number: 1 <input type="button" value="Refresh"/>				
ID	MAC Address	Current Status	Received Packets	Sent Packets
1	D8-31-CF-02-FA-FE	WPA2-PSK	46	29
<input type="button" value="Previous"/> <input type="button" value="Next"/>				

Figure 5-5 Wireless Statistics

- **MAC Address** - The connected wireless station's MAC address
- **Current Status** - The connected wireless station's running status, one of **STA-AUTH/ STA-ASSOC/ STA-JOINED/ WPA/ WPA-PSK/ WPA2/ WPA2-PSK/ AP-UP/ AP-DOWN/ Disconnected**
- **Received Packets** - Packets received by the station
- **Sent Packets** - Packets sent by the station

You cannot change any of the values on this page. To update this page and to show the current connected wireless stations, click the **Refresh** button.

If the numbers of connected wireless stations go beyond one page, click the **Next** button to go to the next page and click the **Previous** button to return the previous page.

Note:

This page will be refreshed automatically every 5 seconds.

5.5 Powerline

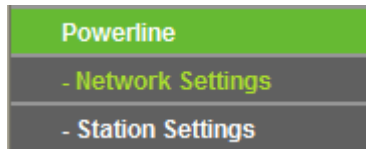

Figure 5-6 Powerline menu

There are two submenus under the Powerline menu (shown in Figure 5-6): **Network Settings** and **Station Settings**. Click any of them, and you will be able to configure the corresponding function.

5.5.1 Network Settings

Choose menu “**Powerline** → **Network Settings**”, and you can configure the network name of the extender or all the stations in current network on this page.

 A screenshot of a web interface titled 'Network Settings'. It has a green header bar. Below the header, there are three rows of settings:

- MAC Address: 00-5E-AA-08-01-06
- Device Password: GQAG-URPZ-NOKG-HIXV
- Network Name: A text input field containing 'Unknown Network Name' and a 'Default' button to its right.

 At the bottom of the form are two buttons: 'Set Local' and 'Set All'.

Figure 5-7 Network Settings

- **MAC Address** - The powerline physical address of the extender. The value can not be changed.
- **Device Password** - The device password of the extender. The value can not be changed.
- **Network Name** - Enter the network name (default: **HomePlugAV**).

Click the **Default** button to restore the default network name.

Click the **Set Local** button to set the network name for only the extender.

Click the **Set All** button to set the network names for the extender and all current network stations whose passwords have been correctly entered.

Note:

Clicking the **Set Local** button will make the extender leave the router's network since the extender's network name changes but the router's network name remains unchanged.

Clicking the **Set All** button will not change the network names for the stations that are powered off or those whose passwords haven't been correctly entered in the **Station Settings** page.

5.5.2 Station Settings

Choose menu "**Powerline** → **Station Settings**", and you can view remote stations in the current network and enter, modify or delete their passwords and names on this page.

Device Name	MAC Address	Device Password	Status	Operation
	00-05-29-54-00-01		online	Add

Figure 5-8 Station Settings

- **Device Name** - The name used for identifying a station.
- **MAC Address** - The remote station's MAC address. The value can not be changed.
- **Device Password** - The security ID of remote station.

To add or modify a station entry, click the **Add** or **Modify** button in the **Operation** column and follow these instructions:

1. Enter the station password in **Device Password** field. The password is in XXXX-XXXX-XXXX-XXXX format. For example, FVDL-AVKV-JNKS-ESBU.
2. Enter a name you want to give the station in the **Device Name** field or leave it empty. For example, Station A.
3. Click the **Save** button to save this entry.

Figure 5-9 Add or Modify PLC Station entry

Click the **Delete** button in the operation column to delete a station entry.

Click the **Add New...** button to add a station into current network. The steps are the same as adding a station entry.

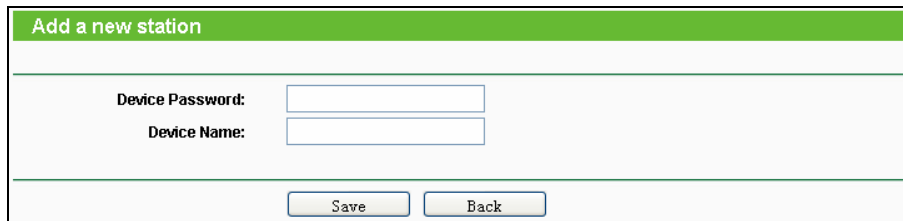

Figure 5-10 Add a new station

Click the **Refresh** button to update the current connected stations.

Click the **Next** button to go to the next page and click the **Previous** button to return to the previous page.

 **Note:**

You can do **Add** or **Modify** operation only when the remote station is connected. If the remote station which you entered the password is power off or leave the current network, you can only do **Delete** operation.

5.6 System Tools

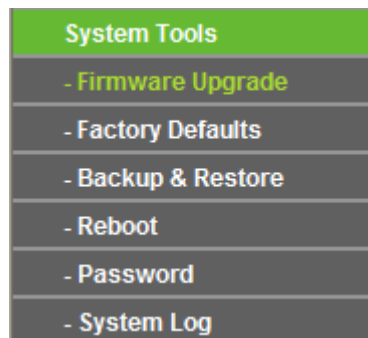

Figure 5-11 System Tools menu

There are six submenus under the System Tools menu (shown in Figure 5-11): **Firmware Upgrade**, **Factory Defaults**, **Backup & Restore**, **Reboot**, **Password**, and **System Log**. Click any of them, and you will be able to configure the corresponding function. The detailed explanations for each submenu are provided below.

5.6.1 Firmware Upgrade

Choose menu "**System Tools** → **Firmware Upgrade**", and then you can update the latest version of firmware for the extender on the following screen.

Figure 5-12 Firmware Upgrade

- **Firmware Version** - Displays the current firmware version.
- **Hardware Version** - Displays the current hardware version. The hardware version of the upgrade file must accord with the extender's current hardware version.

To upgrade the extender's firmware, follow these instructions below:

1. Download a most recent firmware upgrade file from our website (www.tp-link.com).
2. Enter or select the path name where you save the downloaded file on the computer into the **File Name** blank.
3. Click the **Upgrade** button.
4. The extender will reboot while the upgrading has been finished.

 **Note:**

- 1) New firmware versions are posted at www.tp-link.com and can be downloaded for free. There is no need to upgrade the firmware unless the new firmware has a new feature you want to use. However, when experiencing problems caused by the extender rather than the configuration, you can try to upgrade the firmware.
- 2) When you upgrade the extender's firmware, you may lose its current configurations, so before upgrading the firmware please write down some of your customized settings to avoid losing important settings.
- 3) Do not turn off the extender or press the Reset button while the firmware is being upgraded. Loss of power during the upgrade could damage the extender.
- 4) The firmware version must correspond to the hardware.
- 5) The upgrade process takes a few moments and the extender restarts automatically when the upgrade is complete.

5.6.2 Factory Defaults

Choose menu "**System Tools** → **Factory Defaults**", and then you can restore the configurations of the extender to factory defaults on the following screen.

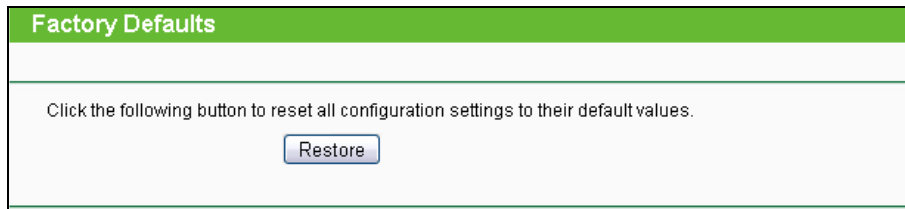

Figure 5-13 Factory Defaults

Click the **Restore** button to reset all configuration settings to their default values.

- Default **User Name**: admin
- Default **Password**: admin
- Default **IP Address**: 192.168.1.254
- Default **Subnet Mask**: 255.255.255.0

 **Note:**

All user-defined settings will be lost after the restoration.

5.6.3 Backup & Restore

Choose menu “**System Tools** → **Backup & Restore**”, and then you can save the current configuration of the extender as a backup file and restore the configuration via a backup file as shown in Figure 5-14.

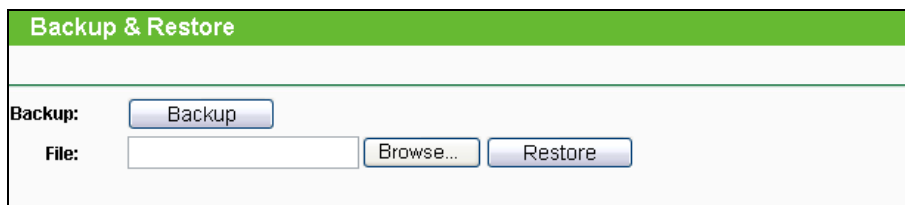

Figure 5-14 Backup & Restore

Click the **Backup** button to save all configuration settings as a backup file in your local computer.

- To restore the extender's configuration, follow these instructions.
 1. Click the **Browse** button to find the configuration file which you want to restore.
 2. Click the **Restore** button to update the configuration with the file whose path is the one you have input or selected in the blank.

 **Note:**

The current configuration will be covered with the uploading configuration file. Wrong process will lead the device unmanaged. The restoring process lasts for 20 seconds and the extender will reboot automatically then. Keep the power of the extender on during the process, in case of any damage.

5.6.4 Reboot

Choose menu “**System Tools** → **Reboot**”, and then you can click the **Reboot** button to reboot the extender via the next screen.

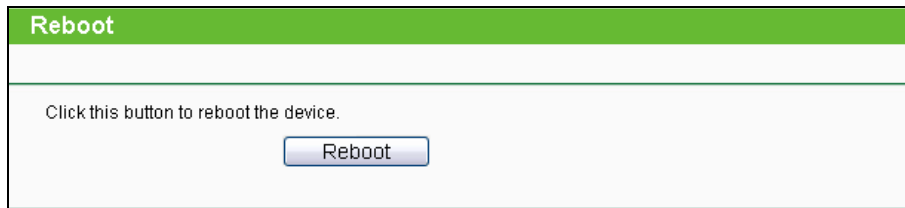

Figure 5-15 Reboot the extender

Some settings of the extender will take effect only after rebooting, which include

- Change the LAN IP Address (system will reboot automatically).
- Upgrade the firmware of the extender (system will reboot automatically).
- Restore the extender's settings to factory defaults (system will reboot automatically).
- Update the configuration with the file (system will reboot automatically).

5.6.5 Password

Choose menu “**System Tools** → **Password**”, and then you can change the factory default user name and password of the extender in the next screen as shown in Figure 5-16.

Figure 5-16 Password

It is strongly recommended that you change the default user name and password of the extender, because all users who try to access the extender's Web-based utility will be prompted for the extender's default user name and password.

Note:

The new user name and password must not exceed 14 characters in length and must not include any spaces. Enter the new password twice to confirm it.

Click the **Save** button to save the settings.

Click the **Clear All** button to clear all fields.

5.6.6 System Log

Choose menu "**System Tools** → **System Log**", and then you can view the logs of the extender.



Figure 5-17 System Log

- **Refresh** - Refresh the page to show the latest log list.
- **Clear All** - All the logs will be deleted from the Extender permanently, not just from the page.

Appendix A: FAQ

1. How do I configure the router for ADSL/cable users to access the Internet?

- 1) Configure the ADSL/cable modem to RFC1483 bridge model.
- 2) Connect the Ethernet cable from your ADSL/cable modem to the Internet port on the router, and plug the telephone cord into the Line port of the ADSL/cable modem.
- 3) Log in to the router and choose menu “**Network** → **WAN**”. On the **WAN** page, select “PPPoE/Russia PPPoE” for WAN connection type. Type the user name and password provided by your ISP, confirm the password, and click **Connect**.

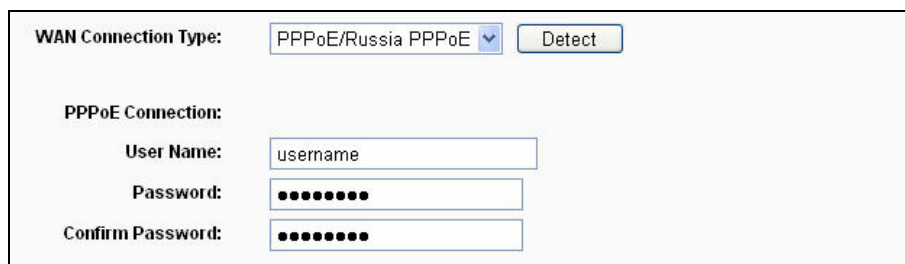

Figure A-1 PPPoE Connection Type

- 4) If your ADSL/cable lease is in “pay-according-time” mode, select “Connect on Demand” or “Connect Manually” for Internet connection mode, and set an appropriate Max Idle Time to avoid wasting paid time. Otherwise, you can select “Connect Automatically” for Internet connection mode.

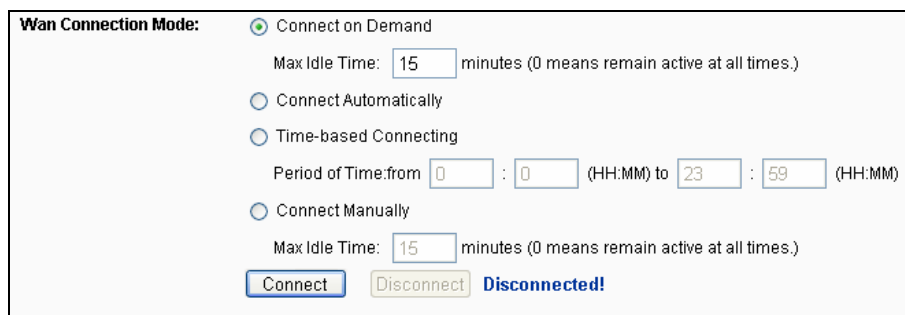

Figure A-2 PPPoE Connection Mode

Note:

Sometimes the connection cannot be disconnected although you specify a Max Idle Time. This is because some applications are visiting the Internet continually in the background.

2. How do I configure the router for Ethernet users to access the Internet?

- 1) Log in to the router and choose menu “**Network** → **WAN**”. On the **WAN** page, select “Dynamic IP” for WAN connection type, and click **Save**.

- 2) (Optional) If your ISP requires that you register the MAC address of your adapter (which is connected to your ADSL/cable modem during installation), follow the below steps to clone MAC address:
 - a. Choose menu "**Network** → **MAC Clone**".
 - b. On the **MAC Clone** page, click **Clone MAC Address** to fill your PC's MAC address in the "WAN MAC Address" field, or manually type a proper MAC address (in XX-XX-XX-XX-XX-XX format) into the "WAN MAC Address" field.
 - c. Click **Save**.

Figure A-3 MAC Clone

3. I want to use Netmeeting, what do I need to do?

If you want to start Netmeeting as a host, you don't need to do anything with the router.

If you want to start Netmeeting as a response, you need to configure Virtual Server or DMZ Host and make sure the H323 ALG is enabled.

- 1) How to configure Virtual Server: Log in to the router, choose menu "**Forwarding** → **Virtual Servers**". On the **Virtual Servers** page, click **Add New**. On the **Add or Modify a Virtual Server Entry** page, enter "1720" for the "Service Port" field, and enter your IP address (for example, 192.168.0.169) for the "IP Address" field. Then, select **Enabled** for Status and click **Save**.

Figure A-4 Virtual Servers

Figure A-5 Add or Modify a Virtual server Entry

 **Note:**

Your peer side should call you by using your WAN IP, which is displayed on the **Status** page.

- 2) How to configure DMZ Host: Log in to the router, choose menu “**Forwarding** → **DMZ**”. On the **DMZ** page, click the **Enable** radio button and type your IP address (for example, 192.168.0.169) into the “DMZ Host IP Address” field. Then, click **Save**.

Figure A-6 DMZ

- 3) How to enable H323 ALG: Log in to the router, choose menu “**Security** → **Basic Security**”. On the **Basic Security** page, check the **Enable** radio button next to **H323 ALG**. Then, click **Save**.

Basic Security	
Firewall	
SPI Firewall:	<input checked="" type="radio"/> Enable <input type="radio"/> Disable
VPN	
PPTP Passthrough:	<input checked="" type="radio"/> Enable <input type="radio"/> Disable
L2TP Passthrough:	<input checked="" type="radio"/> Enable <input type="radio"/> Disable
IPSec Passthrough:	<input checked="" type="radio"/> Enable <input type="radio"/> Disable
ALG	
FTP ALG:	<input checked="" type="radio"/> Enable <input type="radio"/> Disable
TFTP ALG:	<input checked="" type="radio"/> Enable <input type="radio"/> Disable
H323 ALG:	<input checked="" type="radio"/> Enable <input type="radio"/> Disable
RTSP ALG:	<input checked="" type="radio"/> Enable <input type="radio"/> Disable
<input type="button" value="Save"/>	

Figure A-7 Basic Security

4. I want to build a Web Server on the LAN, what should I do?

- 1) Change the Web management port number as follows to avoid interference from the Web server port 80:

Log in to the router, choose menu "**Security** → **Remote Management**". On the **Remote Management** page, type a port number other than 80, such as 88, into the "Web Management Port" field. Click **Save** and reboot the router.

Remote Management	
Web Management Port:	<input type="text" value="88"/>
Remote Management IP Address:	<input type="text" value="0.0.0.0"/> (Enter 255.255.255.255 for all)
<input type="button" value="Save"/>	

Figure A-8 Remote Management

 **Note:**

After the above configuration takes effect, you can visit the router via the website <http://192.168.1.1:88> (Router LAN IP:Web Management Port).

If the LAN IP of the modem connected with your router is 192.168.1.x, the default LAN IP of the router will automatically switch from 192.168.1.1 to 192.168.0.1 to avoid IP conflict; in this case, please try <http://192.168.0.1:88>.

2) Configure Virtual Server as follows:

Log in to the router, choose menu “**Forwarding** → **Virtual Servers**”. On the **Virtual Servers** page, click **Add New**. On the **Add or Modify a Virtual Server** page, enter “80” in the “Service Port” field, and enter your IP address (for example, 192.168.0.169) in the “IP Address” field. Then, select **Enabled** for Status and click **Save**.

ID	Service Port	Internal Port	IP Address	Protocol	Status	Modify
<input type="button" value="Add New..."/> <input type="button" value="Enable All"/> <input type="button" value="Disable All"/> <input type="button" value="Delete All"/>						
<input type="button" value="Previous"/> <input type="button" value="Next"/>						

Figure A-9 Virtual Servers

Service Port: (XX-XX or XX)
 Internal Port: (XX, Only valid for single Service Port or leave it blank)
 IP Address:
 Protocol:
 Status:
 Common Service Port:

Figure A-10 Add or Modify a Virtual server Entry

5. The wireless stations cannot connect to the router, what should I do?

- 1) Make sure that the WIFI ON/OFF switch has been turned on.
- 2) Make sure that the wireless stations' SSID accords with the router's SSID.
- 3) Make sure the wireless stations have the right encryption key if the router is encrypted.
- 4) If the wireless connection is ready but you can't access the router, check the IP addresses of your wireless stations.

Appendix B: Configuring the PCs

In this section, we'll introduce how to install and configure the TCP/IP correctly in Windows XP. First make sure your Ethernet adapter is working, refer to the adapter's manual if needed.

1. Install TCP/IP component

- 1) On the Windows taskbar, click the **Start** button, point to **Settings**, and then click **Control Panel**.
- 2) Click the **Network and Internet Connections** icon, and then click the **Network Connections** tab in the appearing window.
- 3) Right-click the icon that showed below, select **Properties** on the prompt page.

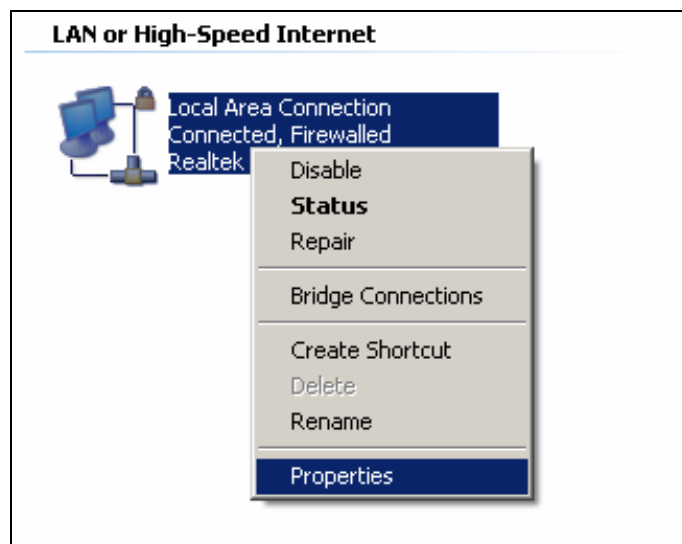

Figure B-1

- 4) In the prompt page that showed below, double-click **Internet Protocol (TCP/IP)**.

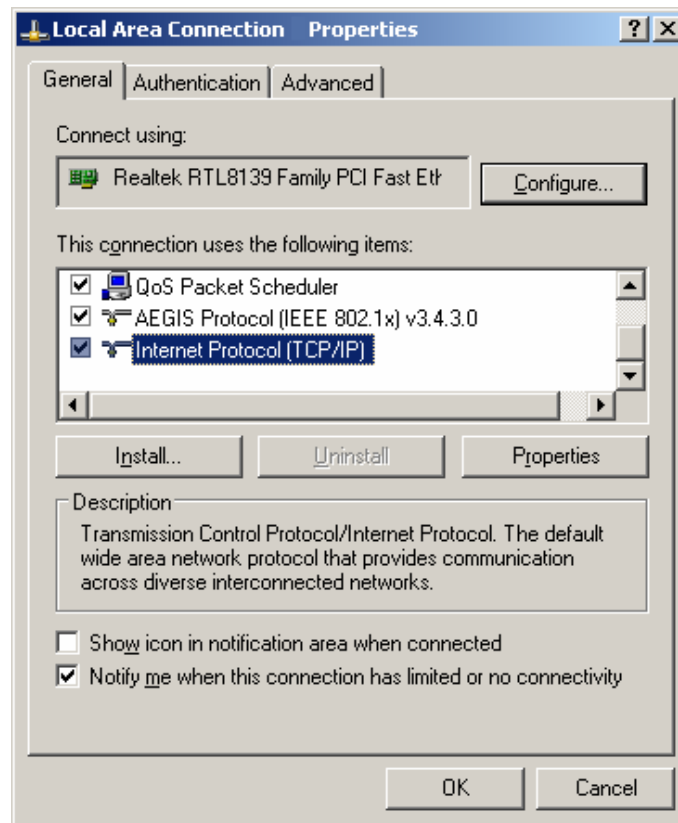

Figure B-2

- 5) The **TCP/IP Properties** window will display and the **IP Address** tab is open on this window by default.

- 6) Select **Obtain an IP address automatically** and **Obtain DNS server automatically**, and click **OK**.

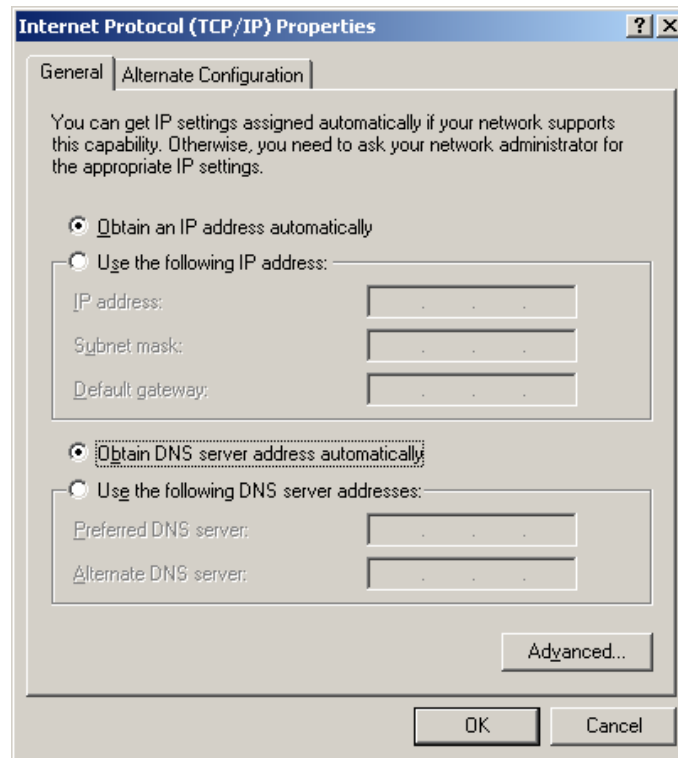

Figure B-3

Appendix C: Specifications

H5R:

Hardware Features	
Standards and Protocols	HomePlug AV, IEEE 802.3, IEEE 802.3u, IEEE 802.3ab, IEEE 802.11n, IEEE 802.11g, IEEE 802.11b, IEEE 802.11a
Ports	One 10/100/1000M Internet RJ45 port; Four 10/100/1000M Ethernet RJ45 ports; supporting Auto MDI/MDIX; One USB port supporting storage/FTP/Media/Print Server;
Button	AP CLONE/PAIR, RESET/WPS
LED Indicator	Power, USB, Wireless, WPS, WAN, LAN, Powerline
Safe & Emissions	CE,FCC,ROHS
Data Rate	Powerline: 500Mbps Wireless: 300Mbps(2.4G) + 300Mbps(5G)
Antenna Gain	1.5dBi@2.4-2.5GHz, 5dBi@4.9-5.825GHz
Range	300 Meters over electrical circuit
Software Features	
Modulation Technology	HomePlug AV:Powerline:OFDM 4096/1024/256/64/16/8-QAM,QPSK,BPSK and ROBO Modulation IEEE802.11n/g/a: QPSK,BPSK,16-QAM,64-QAM for OFDM IEEE802.11b: CCK,DQPSK,DBPSK
Encryption	Powerline Security:128-bit AES Wireless Security:WEP, WPA/WPA2, WPA-PSK/WPA2-PSK Encryption
Others	
System Requirements	Windows 2000/XP/2003/Vista, Windows 7/8, Mac, Linux
Environment	Operating Temperature: 0°C~40°C (32°F ~104°F) Storage Temperature: -40°C~70°C (-40°F ~158°F) Operating Humidity: 10%~90% non-condensing Storage Humidity: 5%~90% non-condensing

* Only 2.412GHz~2.462GHz is allowed to be used in USA, which means only channels 1~11 are available for American users to choose.

H5E:

Hardware Features	
Standards and Protocols	HomePlug AV, IEEE802.3, IEEE802.3u, IEEE802.11b,IEEE802.11g, IEEE802.11n
Ports	Two 10/100Mbps Ethernet RJ45 Ports
Button	AP CLONE/PAIR, Wi-Fi, Reset
LED Indicator	PWR, PLC, ETH, Wireless
Safe & Emissions	CE,FCC,ROHS
Data Rate	Powerline: 500Mbps Wireless: 300Mbps
Antenna Gain	2dBi@2.4-2.5GHz
Range	300 Meters over electrical circuit
Software Features	
Modulation Technology	HomePlug AV:Powerline:OFDM 4096/1024/256/64/16/8-QAM,QPSK,BPSK and ROBO Modulation IEEE802.11n/g: QPSK,BPSK,16-QAM,64-QAM for OFDM IEEE802.11b: CCK,DQPSK,DBPSK
Encryption	Powerline Security:128-bit AES Wireless Security:WEP, WPA/WPA2, WPA-PSK/WPA2-PSK Encryption
Others	
System Requirements	Windows 2000/XP/2003/Vista, Windows 7/8, Mac, Linux
Environment	Operating Temperature: 0°C~40°C (32°F ~104°F) Storage Temperature: -40°C~70°C (-40°F ~158°F) Operating Humidity: 10%~90% non-condensing Storage Humidity: 5%~90% non-condensing

Appendix D: Glossary

- **802.11a** - an amendment to the IEEE 802.11 wireless local network specifications that defined requirements for an orthogonal frequency division multiplexing (OFDM) communication system. It uses the same core protocol as the original standard, operates in 5 GHz band, and uses a 52-subcarrier OFDM with a maximum raw data rate of 54 Mbit/s.
- **802.11n** - 802.11n builds upon previous 802.11 standards by adding MIMO (multiple-input multiple-output). MIMO uses multiple transmitter and receiver antennas to allow for increased data throughput via spatial multiplexing and increased range by exploiting the spatial diversity, perhaps through coding schemes like Alamouti coding. The Enhanced Wireless Consortium (EWC) was formed to help accelerate the IEEE 802.11n development process and promote a technology specification for interoperability of next-generation wireless local area networking (WLAN) products.
- **802.11b** - The 802.11b standard specifies a wireless networking at 11 Mbps using direct-sequence spread-spectrum (DSSS) technology and operating in the unlicensed radio spectrum at 2.4GHz, and WEP encryption for security. 802.11b networks are also referred to as Wi-Fi networks.
- **802.11g** - specification for wireless networking at 54 Mbps using direct-sequence spread-spectrum (DSSS) technology, using OFDM modulation and operating in the unlicensed radio spectrum at 2.4GHz, and backward compatibility with IEEE 802.11b devices, and WEP encryption for security.
- **DDNS (Dynamic Domain Name System)** - The capability of assigning a fixed host and domain name to a dynamic Internet IP Address.
- **DHCP (Dynamic Host Configuration Protocol)** - A protocol that automatically configure the TCP/IP parameters for the all the PC(s) that are connected to a DHCP server.
- **DMZ (Demilitarized Zone)** - A Demilitarized Zone allows one local host to be exposed to the Internet for a special-purpose service such as Internet gaming or videoconferencing.
- **DNS (Domain Name System)** - An Internet Service that translates the names of websites into IP addresses.
- **Domain Name** - A descriptive name for an address or group of addresses on the Internet.
- **DSL (Digital Subscriber Line)** - A technology that allows data to be sent or received over existing traditional phone lines.
- **ISP (Internet Service Provider)** - A company that provides access to the Internet.
- **MTU (Maximum Transmission Unit)** - The size in bytes of the largest packet that can be transmitted.

- **NAT (Network Address Translation)** - NAT technology translates IP addresses of a local area network to a different IP address for the Internet.
- **PPPoE (Point to Point Protocol over Ethernet)** - PPPoE is a protocol for connecting remote hosts to the Internet over an always-on connection by simulating a dial-up connection.
- **SSID (Service Set Identifier)** - A thirty-two character (maximum) alphanumeric key identifying a wireless local area network. For the wireless devices in a network to communicate with each other, all devices must be configured with the same SSID. This is typically the configuration parameter for a wireless PC card. It corresponds to the ESSID in the wireless Access Point and to the wireless network name.
- **WEP (Wired Equivalent Privacy)** - A data privacy mechanism based on a 64-bit or 128-bit or 152-bit shared key algorithm, as described in the IEEE 802.11 standard.
- **Wi-Fi** - A trade name for the 802.11b wireless networking standard, given by the Wireless Ethernet Compatibility Alliance (WECA, see <http://www.wi-fi.net>), an industry standards group promoting interoperability among 802.11b devices.
- **WLAN (Wireless Local Area Network)** - A group of computers and associated devices communicate with each other wirelessly, which network serving users are limited in a local area.

Free Manuals Download Website

<http://myh66.com>

<http://usermanuals.us>

<http://www.somanuals.com>

<http://www.4manuals.cc>

<http://www.manual-lib.com>

<http://www.404manual.com>

<http://www.luxmanual.com>

<http://aubethermostatmanual.com>

Golf course search by state

<http://golfingnear.com>

Email search by domain

<http://emailbydomain.com>

Auto manuals search

<http://auto.somanuals.com>

TV manuals search

<http://tv.somanuals.com>