

TP-LINK®

User Guide

TD-W8962ND

300Mbps Wireless N ADSL2+ Modem Router



Rev: 1.0.0
1910010687

COPYRIGHT & TRADEMARKS

Specifications are subject to change without notice. **TP-LINK**[®] is a registered trademark of TP-LINK TECHNOLOGIES CO., LTD. Other brands and product names are trademarks or registered trademarks of their respective holders.

No part of the specifications may be reproduced in any form or by any means or used to make any derivative such as translation, transformation, or adaptation without permission from TP-LINK TECHNOLOGIES CO., LTD. Copyright © 2012 TP-LINK TECHNOLOGIES CO., LTD. All rights reserved.

<http://www.tp-link.com>

FCC STATEMENT



This equipment has been tested and found to comply with the limits for a Class B digital device, pursuant to part 15 of the FCC Rules. These limits are designed to provide reasonable protection against harmful interference in a residential installation. This equipment generates, uses and can radiate radio frequency energy and, if not installed and used in accordance with the instructions, may cause harmful interference to radio communications. However, there is no guarantee that interference will not occur in a particular installation. If this equipment does cause harmful interference to radio or television reception, which can be determined by turning the equipment off and on, the user is encouraged to try to correct the interference by one or more of the following measures:

- Reorient or relocate the receiving antenna.
- Increase the separation between the equipment and receiver.
- Connect the equipment into an outlet on a circuit different from that to which the receiver is connected.
- Consult the dealer or an experienced radio/ TV technician for help.

This device complies with part 15 of the FCC Rules. Operation is subject to the following two conditions:

- 1) This device may not cause harmful interference.
- 2) This device must accept any interference received, including interference that may cause undesired operation.

Any changes or modifications not expressly approved by the party responsible for compliance could void the user's authority to operate the equipment.

Note: The manufacturer is not responsible for any radio or TV interference caused by unauthorized modifications to this equipment. Such modifications could void the user's authority to operate the equipment.

FCC RF Radiation Exposure Statement

This equipment complies with FCC RF radiation exposure limits set forth for an uncontrolled environment. This device and its antenna must not be co-located or operating in conjunction with any other antenna or transmitter.

“To comply with FCC RF exposure compliance requirements, this grant is applicable to only Mobile Configurations. The antennas used for this transmitter must be installed to provide a separation distance of at least 20 cm from all persons and must not be co-located or operating in conjunction with any other antenna or transmitter.”

CE Mark Warning



This is a class B product. In a domestic environment, this product may cause radio interference, in which case the user may be required to take adequate measures.

This device has been designed to operate with the antennas listed below, and having a maximum gain of 3 dBi. Antennas not included in this list or having a gain greater than 3 dBi are strictly prohibited for use with this device. The required antenna impedance is 50 ohms.

To reduce potential radio interference to other users, the antenna type and its gain should be so chosen that the equivalent isotropically radiated power (e.i.r.p.) is not more than that permitted for successful communication.”

Canadian Compliance Statement

This device complies with Industry Canada license-exempt RSS standard(s). Operation is subject to the following two conditions:

- (1) This device may not cause interference, and
- (2) This device must accept any interference, including interference that may cause undesired operation of the device.

Cet appareil est conforme aux norms CNR exemptes de licence d'Industrie Canada. Le fonctionnement est soumis aux deux conditions suivantes:

- (1) cet appareil ne doit pas provoquer d'interférences et
- (2) cet appareil doit accepter toute interférence, y compris celles susceptibles de provoquer un fonctionnement non souhaité de l'appareil.

Industry Canada Statement

Complies with the Canadian ICES-003 Class B specifications.

Cet appareil numérique de la classe B est conforme à la norme NMB-003 du Canada.

This device complies with RSS 210 of Industry Canada. This Class B device meets all the requirements of the Canadian interference-causing equipment regulations.

Cet appareil numérique de la Classe B respecte toutes les exigences du Règlement sur le matériel brouilleur du Canada.

Korea Warning Statements

당해 무선설비는 운용중 전파혼신 가능성이 있음.

NCC Notice

經型式認證合格之低功率射頻電機，非經許可，公司、商號或使用者均不得擅自變更頻率、加大功率或變更原設計之特性及功能。

低功率射頻電機之使用不得影響飛航安全及干擾合法通信；經發現有干擾現象時，應立即停用，並改善至無干擾時方得繼續使用。前項合法通信，指依電信法規定作業之無線電通信。低功率射頻電機須忍受合法通信或工業、科學及醫療用電波輻射性電機設備之干擾。

UkrSEPRO



Продукт сертифіковано згідно с правилами системи УкрСЕПРО на відповідність вимогам нормативних документів та вимогам, що передбачені чинними законодавчими актами України.

Safety Information

- When product has power button, the power button is one of the way to shut off the product; when there is no power button, the only way to completely shut off power is to disconnect the product or the power adapter from the power source.
- Don't disassemble the product, or make repairs yourself. You run the risk of electric shock and voiding the limited warranty. If you need service, please contact us.
- Avoid water and wet locations.

This product can be used in the following countries:

AT	BG	BY	CA	CZ	DE	DK	EE
ES	FI	FR	GB	GR	HU	IE	IT
LT	LV	MT	NL	NO	PL	PT	RO
RU	SE	SK	TR	UA			

DECLARATION OF CONFORMITY

For the following equipment:

Product Description: 300Mbps Wireless N ADSL2+ Modem Router

Model No.: **TD-W8962ND**

Trademark: **TP-LINK**

We declare under our own responsibility that the above products satisfy all the technical regulations applicable to the product within the scope of Council Directives:

Directives 1999/5/EC, Directives 2004/108/EC, Directives 2006/95/EC, Directives 1999/519/EC, Directives 2011/65/EU

The above product is in conformity with the following standards or other normative documents

ETSI EN 300 328 V1.7.1: 2006

ETSI EN 301 489-1 V1.8.1:2008& ETSI EN 301 489-17 V2.1.1:2009

EN 55022:2006 +A1:2007

EN 55024:1998+A1:2001+A2:2003

EN 61000-3-2:2006+A1:2009+A2:2009

EN 61000-3-3:2008

EN60950-1:2006+A11:2009+A1:2010

EN62311:2008

The product carries the CE Mark:



Person is responsible for marking this declaration:

A handwritten signature in black ink, appearing to read 'Yang Hongliang', is written over a light gray rectangular background.

Yang Hongliang

Product Manager of International Business

Date of issue: 2012

TP-LINK TECHNOLOGIES CO., LTD

Building 24 (floors 1, 3, 4, 5), and 28 (floors 1-4) Central Science and Technology Park,
Shennan Rd, Nanshan, Shenzhen, China

CONTENTS

Package Contents	1
Chapter 1. Product Overview.....	2
1.1 Overview of the Modem Router	2
1.2 Main Features.....	3
1.3 Panel Layout.....	4
1.3.1 The Front Panel	4
1.3.2 The Back Panel.....	5
Chapter 2. Connecting the Modem Router	7
2.1 System Requirements	7
2.2 Installation Environment Requirements	7
2.3 Connecting the Modem Router.....	8
Chapter 3. Quick Installation Guide	10
3.1 Configuring the PC	10
3.2 Quick Installation Guide.....	13
3.2.1 Wireless ADSL Router	15
3.2.2 Wireless Router.....	19
Chapter 4. Configuring the Modem Router	22
4.1 Login.....	22
4.2 Status.....	22
4.3 Quick Setup	23
4.4 System Mode.....	23
4.5 Network.....	24
4.5.1 WAN Settings.....	24
4.5.2 Interface Grouping	31
4.5.3 LAN Settings	32
4.5.4 MAC Clone.....	33
4.5.5 ALG Settings.....	34
4.5.6 DSL Settings	35
4.6 DHCP Server	35
4.6.1 DHCP Settings.....	35
4.6.2 Clients List.....	37

4.6.3	Address Reservation.....	37
4.6.4	Conditional Pool.....	38
4.7	Wireless.....	40
4.7.1	Basic Settings.....	40
4.7.2	WPS Settings.....	42
4.7.3	Wireless Security.....	44
4.7.4	Wireless MAC Filtering.....	46
4.7.5	Wireless Advanced.....	47
4.7.6	Wireless Status.....	48
4.8	Route Settings.....	49
4.8.1	Default Gateway.....	49
4.8.2	Static Route.....	49
4.8.3	RIP Settings.....	50
4.9	Forwarding.....	51
4.9.1	Virtual Servers.....	51
4.9.2	Port Triggering.....	52
4.9.3	DMZ.....	54
4.9.4	UPnP.....	54
4.10	Parent Control.....	55
4.11	Firewall.....	56
4.11.1	Rule.....	57
4.11.2	LAN Host.....	58
4.11.3	WAN Host.....	59
4.11.4	Schedule.....	60
4.11.5	DDoS.....	61
4.12	Bandwidth Control.....	62
4.13	IP&MAC Binding.....	63
4.13.1	Binding Setting.....	63
4.13.2	ARP List.....	64
4.14	Dynamic DNS.....	65
4.15	Diagnostic.....	66
4.16	System Tools.....	67
4.16.1	System Log.....	67
4.16.2	Time Settings.....	68
4.16.3	Manage Control.....	69
4.16.4	CWMP Settings.....	69

4.16.5 SNMP Settings	70
4.16.6 Backup & Restore.....	71
4.16.7 Factory Defaults.....	71
4.16.8 Firmware Upgrade.....	72
4.16.9 Reboot	73
4.16.10 Statistics.....	73
Appendix A: Specifications	75
Appendix B: Troubleshooting	76
Appendix C: Technical Support	85

Package Contents

The following contents should be found in your package:

- One TD-W8962ND 300Mbps Wireless N ADSL2+ Modem Router
- One Power Adapter for TD-W8962ND 300Mbps Wireless N ADSL2+ Modem Router
- Quick Installation Guide
- One RJ45 cable
- Two RJ11 cables
- One ADSL splitter
- One Resource CD for TD-W8962ND 300Mbps Wireless N ADSL2+ Modem Router, including:
 - This User Guide
 - Other Helpful Information

 **Note:**

Make sure that the package contains the above items. If any of the listed items are damaged or missing, please contact your distributor.

Chapter 1. Product Overview

Thank you for choosing the **TD-W8962ND 300Mbps Wireless N ADSL2+ Modem Router**.

1.1 Overview of the Modem Router

The TD-W8962ND 300Mbps Wireless N ADSL2+ Modem Router integrates 4-port Switch, Firewall, NAT-Router and Wireless AP. Powered by 2x2 MIMO technology, the Wireless N Router delivers exceptional range and speed, which can fully meet the need of Small Office/Home Office (SOHO) networks and the users demanding higher networking performance.

The TD-W8962ND 300Mbps Wireless N ADSL2+ Modem Router utilizes integrated ADSL2+ transceiver and high speed MIPS CPU. The Modem Router supports full-rate ADSL2+ connectivity conforming to the ITU and ANSI specifications.

In addition to the basic DMT physical layer functions, the ADSL2+ PHY supports dual latency ADSL2+ framing (fast and interleaved) and the I.432 ATM Physical Layer.

The Modem Router provides up to 300Mbps wireless connection with other 802.11n wireless clients. The incredible speed makes it ideal for handling multiple data streams at the same time, which ensures your network stable and smooth. The performance of this 802.11n wireless Router will give you the unexpected networking experience at speed 650% faster than 802.11g. It is also compatible with all IEEE 802.11g and IEEE 802.11b products.

With multiple protection measures, including SSID broadcast control and wireless LAN 64/128 WEP encryption, Wi-Fi protected Access (WPA2-PSK, WPA-PSK), as well as advanced Firewall protections, the TD-W8962ND 300Mbps Wireless N ADSL2+ Modem Router provides complete data privacy.

The Modem Router provides flexible access control, so that parents or network administrators can establish restricted access policies for children or staff. It also supports Virtual Server and DMZ host for Port Triggering, and then the network administrators can manage and monitor the network in real time with the remote management function.

Since the Modem Router is compatible with virtually all the major operating systems, it is very easy to manage. Quick Setup Wizard is supported and detailed instructions are provided step by step in this user guide. Before installing the Modem Router, please look through this guide to know all the Modem Router's functions.

1.2 Main Features

- Four 10/100Mbps Auto-Negotiation RJ45 LAN ports (Auto MDI/MDIX), one RJ11 port.
- Provides external splitter.
- Adopts Advanced DMT modulation and demodulation technology.
- Supports bridge mode and Router function.
- Multi-user sharing a high-speed Internet connection.
- Downstream data rates up to 24Mbps, upstream data rates up to 3.5Mbps (With Annex M enabled).
- Supports long transfers, the max line length can reach to 6.5Km.
- Supports remote configuration and management through SNMP and CWMP.
- Supports PPPoE, it allows connecting the internet on demand and disconnecting from the Internet when idle.
- Provides reliable ESD and surge-protect function with quick response semi-conductive surge protection circuit.
- High speed and asymmetrical data transmit mode, provides safe and exclusive bandwidth.
- Supports All ADSL industrial standards.
- Compatible with all mainstreams DSLAM (CO).
- Provides integrated access of internet and route function which face to SOHO user.
- Real-time Configuration and device monitoring.
- Supports Multiple PVC (Permanent Virtual Circuit).
- Built-in DHCP server.
- Built-in firewall, supporting IP/MAC filter, Application filter and URL filter.
- Supports Virtual Server, DMZ host and IP Address Mapping.
- Supports Dynamic DNS, UPnP and Static Routing.
- Supports system log and flow Statistics.
- Supports firmware upgrade and Web management.
- Provides WPA-PSK/WPA2-PSK data security, TKIP/AES encryption security.
- Provides 64/128-bit WEP encryption security and wireless LAN ACL (Access Control List).
- Supports Ethernet WAN (EWAN).
- Supports Bandwidth Control.

1.3 Panel Layout

1.3.1 The Front Panel



Figure 1-1

The Modem Router’s LEDs are located on the front panel (View from left to right). They indicate the device’s working status. For details, please refer to LED Explanation.

LED Explanation:

Name	Status	Indication
⏻(Power)	On	The Modem Router is powered on.
	Off	The Modem Router is off. Please ensure that the power adapter is connected correctly.
⚡(ADSL)	On	ADSL line is synchronized and ready to use.
	Flash	The ADSL negotiation is in progress.
	Off	ADSL synchronization fails. Please refer to Note 1 for troubleshooting.
🌐(Internet)	On	The network is available with a successful Internet connection.
	Flash	There is data being transmitted or received via the Internet.
	Off	There is no successful Internet connection or the Modem Router is operating in Bridge mode. Please refer to Note 2 for troubleshooting.
📶(WLAN)	On	Wireless is enabled but no data is being transmitted.
	Flash	The Modem Router is sending or receiving data over the wireless network.
	Off	Wireless function is disabled.
🔒(WPS)	On	A wireless device has been successfully added to the network by WPS function.
	Slow Flash	WPS handshaking is in process and will continue for about 2 minutes. Please press the WPS button on other wireless devices that you want to add to the network while the LED is flashing.
	Quick Flash	A wireless device has failed to be added to the network by WPS function. Please refer to 4.6.2 WPS Settings for more information.

 (LAN1-4)	On	There is a device connected to this LAN port.
	Flash	The Modem Router is sending or receiving data over this LAN port.
	Off	There is no device connected to this LAN port.

Note:

1. If the ADSL LED is off, please check your Internet connection first. Refer to [2.3 Connecting the Modem Router](#) for more information about how to make Internet connection correctly. If you have already made a right connection, please contact your ISP to make sure if your Internet service is available now.
2. If the Internet LED is off, please check your ADSL LED first. If your ADSL LED is also off, please refer to [Note 1](#). If your ADSL LED is GREEN ON, please check your Internet configuration. You may need to check this part of information with your ISP and make sure everything have been input correctly.

1.3.2 The Back Panel

The Modem Router's ports, where the cables are connected, and RESET button are located on the back

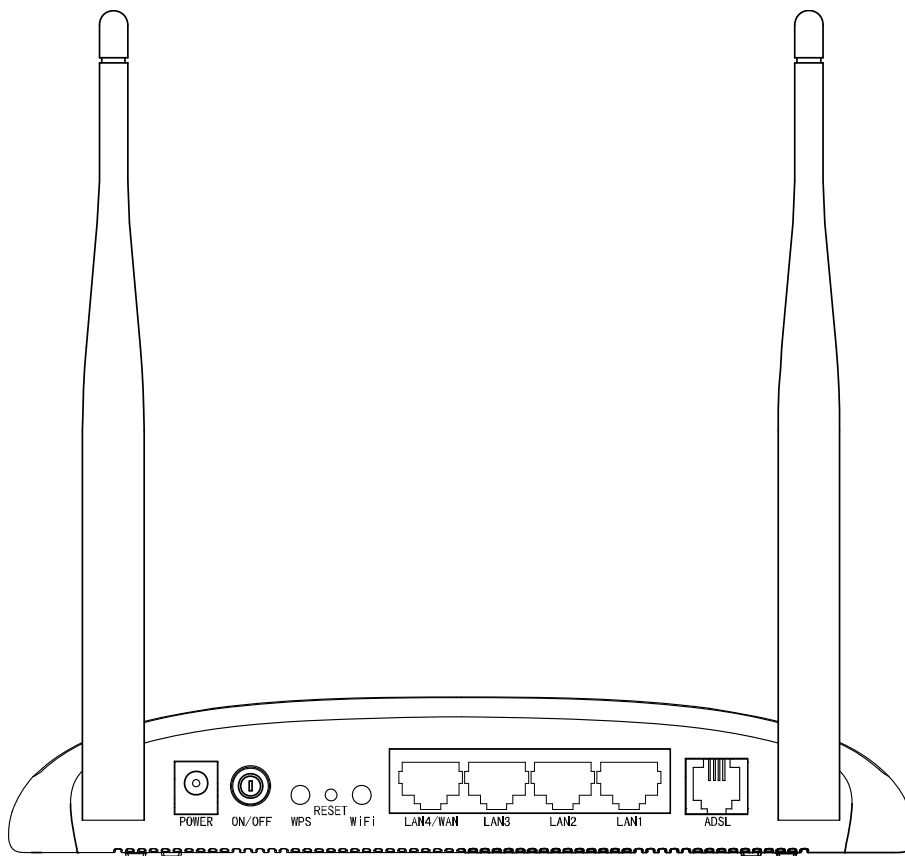

Figure 1-2

- **POWER:** The Power plug is where you will connect the power adapter.
- **ON/OFF:** The switch for the power.

- **WPS:** The switch for the WPS function. For details, please refer to [4.6.2 WPS Settings](#).
- **RESET:** There are two ways to reset the Modem Router's factory defaults.
Method one: With the Modem Router powered on, use a pin to press and hold the Reset button for at least 5 seconds. And the Modem Router will reboot to its factory default settings.
Method two: Restore the default setting from "Maintenance-SysRestart" of the Modem Router's Web-based Utility.
- **WiFi:** The switch for the WiFi function.
- **LAN1, LAN2, LAN3, LAN4/WAN:** Through these ports, you can connect the Modem Router to your PC or the other Ethernet network devices. Enable EWAN function and you will be able to connect to Cable/FTTH/VDSL/ADSL device.
- **ADSL:** Through the port, you can connect the Modem Router with the telephone. Or you can connect them by an external separate splitter. For details, please refer to [2.3 Connecting the Modem Router](#).
- **Antennas:** Used for wireless operation and data transmit.

Chapter 2. Connecting the Modem Router

2.1 System Requirements

- Broadband Internet Access Service (DSL/Cable/Ethernet).
- PCs with a working Ethernet Adapter and an Ethernet cable with RJ45 connectors.
- TCP/IP protocol on each PC.
- Web browser, such as Microsoft Internet Explorer, Mozilla Firefox or Apple Safari.

2.2 Installation Environment Requirements

- The Product should not be located where it will be exposed to moisture or excessive heat.
- Place the Modem Router in a location where it can be connected to the various devices as well as to a power source.
- Make sure the cables and power cord are safely placed out of the way so they do not create a tripping hazard.
- The Modem Router can be placed on a shelf or desktop.
- Keep away from the strong electromagnetic radiation and the device of electromagnetic sensitive.

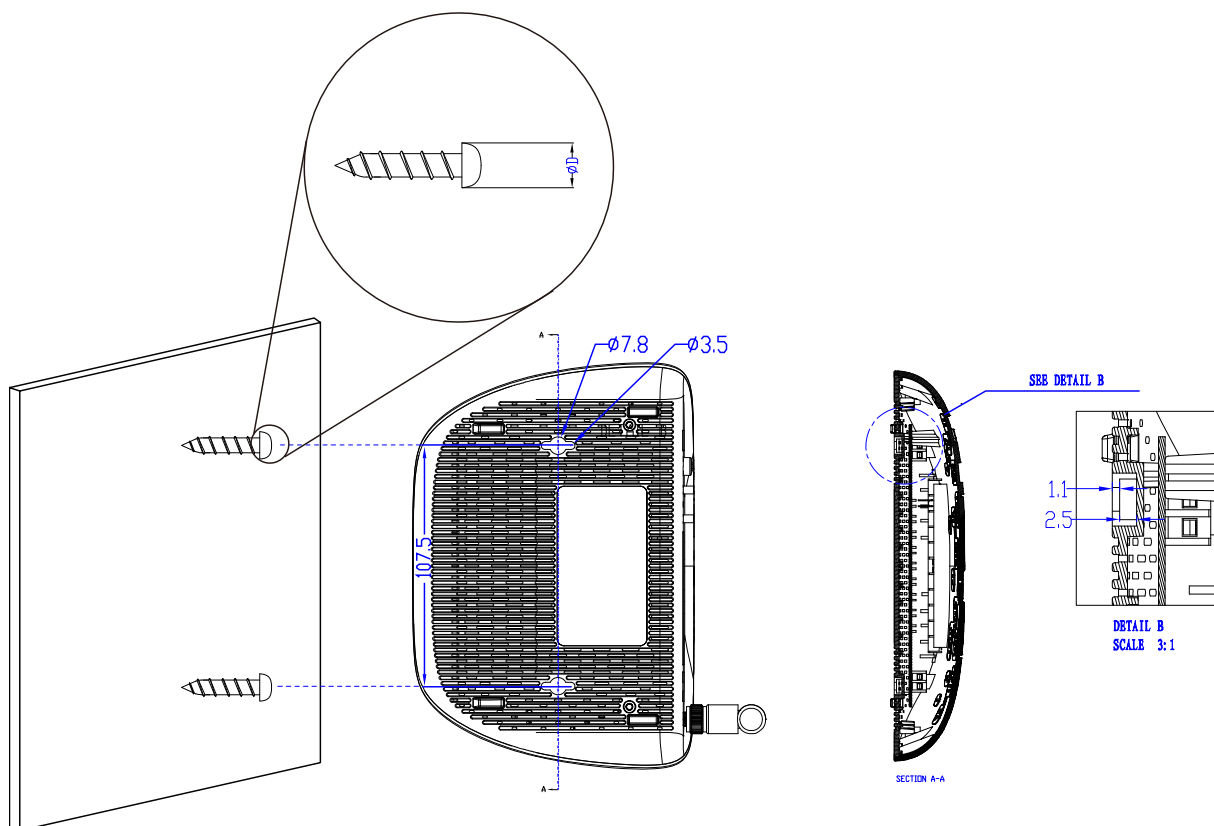

Figure 2-1 Wall-mount Install

 **Note:**

The diameter of the screw, $3.5\text{mm} < D < 7.8\text{mm}$, and the distance of two screws is 107.5mm. The screw that project from the wall need around 4mm based, and the length of the screw need to be at least 20mm to withstand the weight of the product.

2.3 Connecting the Modem Router

Before installing the device, please make sure your broadband service provided by your ISP is available. If there is any problem, please contact your ISP. Before cable connection, cut off the power supply and keep your hands dry. You can follow the steps below to install it.

Step 1: Connect the ADSL Line.

Method one: Plug one end of the twisted-pair ADSL cable into the ADSL port on the rear panel of , and insert the other end into the wall socket.

Method two: You can use a separate splitter. External splitter can divide the data and voice, and then you can access the Internet and make calls at the same time. The external splitter has three ports:

- LINE: Connect to the wall jack
- PHONE: Connect to the phone sets
- MODEM: Connect to the ADSL port of

Plug one end of the twisted-pair ADSL cable into the ADSL port on the rear panel of . Connect the other end to the MODEM port of the external splitter.

Step 2: Connect the Ethernet cable. Attach one end of a network cable to your computer's Ethernet port or a regular hub/switch port, and the other end to the LAN port on the Modem Router.

Step 3: Power on the computers and LAN devices.

Step 4: Attach the power adapter. Connect the power adapter to the power connector on the rear of the device and plug in the adapter to a electrical outlet or power extension. The electrical outlet shall be installed near the device and shall be easily accessible.

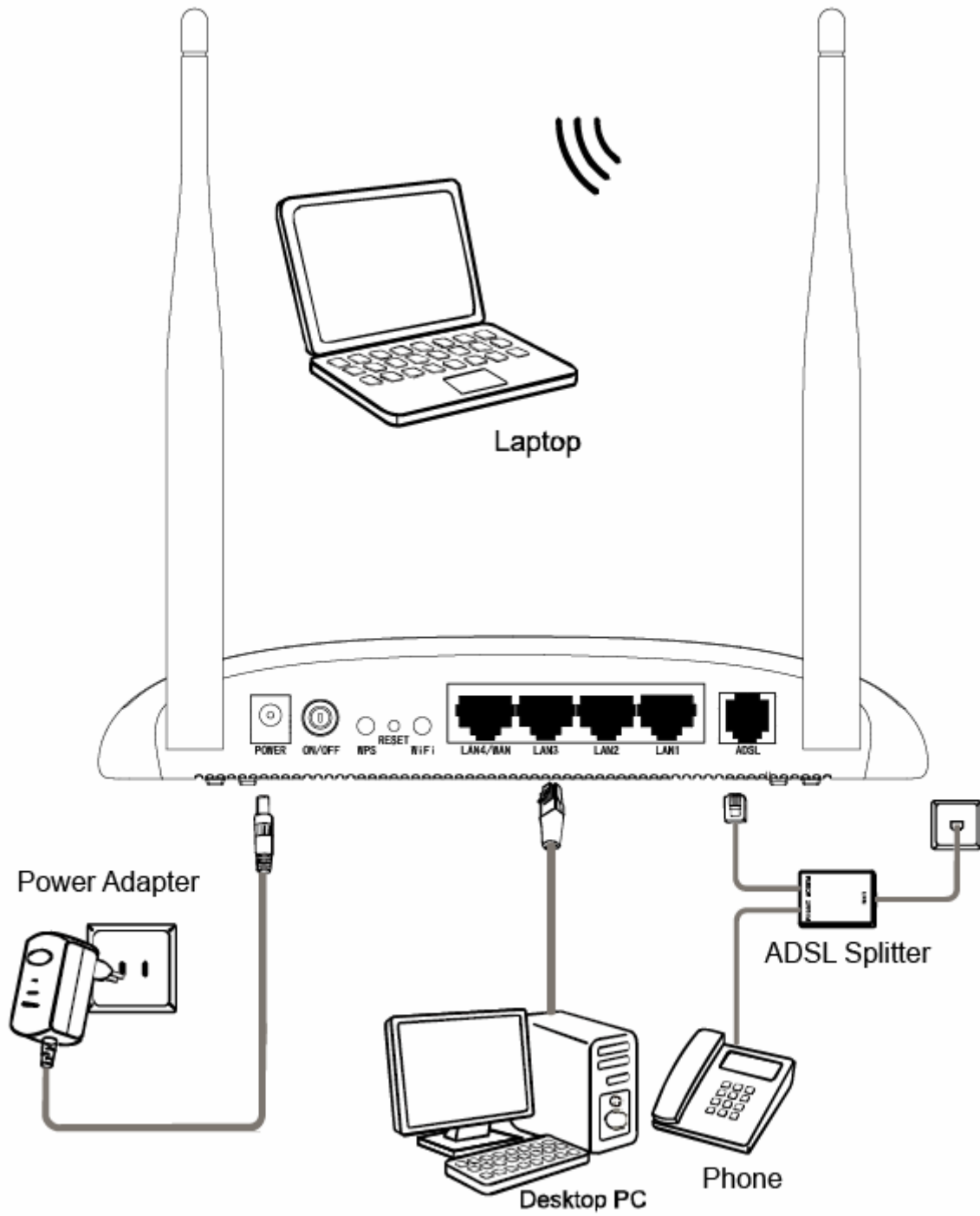

Figure 2-2

Chapter 3. Quick Installation Guide

3.1 Configuring the PC

After you directly connect your PC to the Modem Router or connect your adapter to a Hub/Switch which has connected to the Modem Router, you need to configure your PC's IP address. Follow the steps below to configure it.

Step 1: Click the **Start** menu on your desktop, right click **My Network Places**, and then select **Properties** (shown in Figure 3-1).

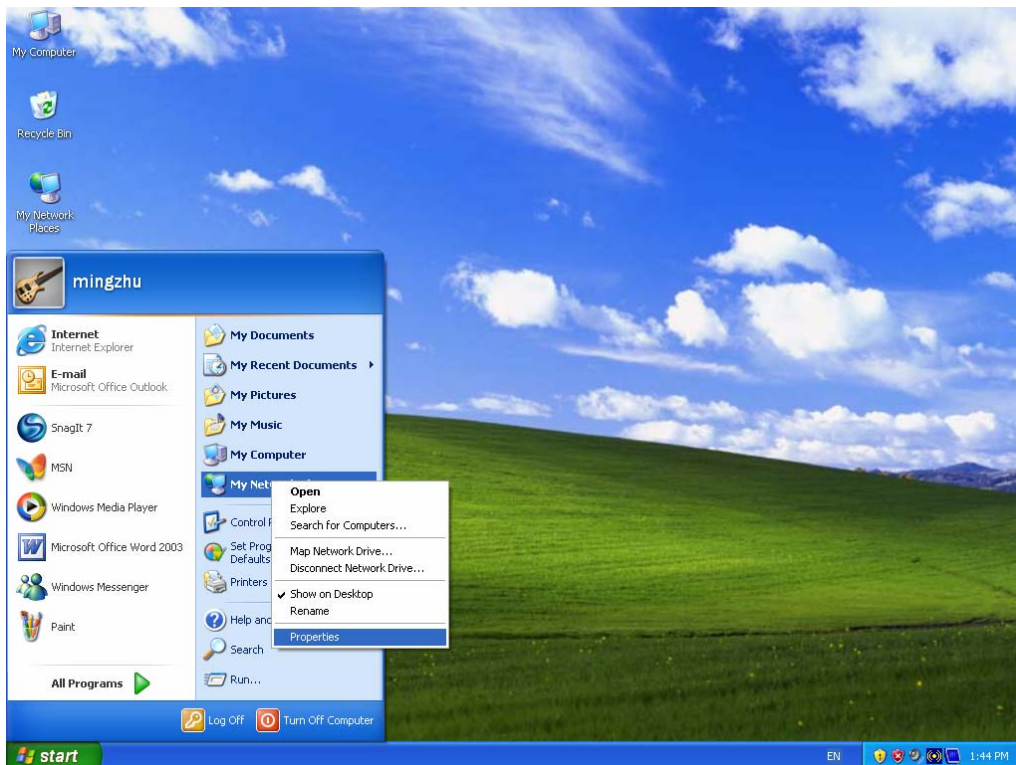

Figure 3-1

Step 2: Right click **Local Area Connection (LAN)**, and then select **Properties**.

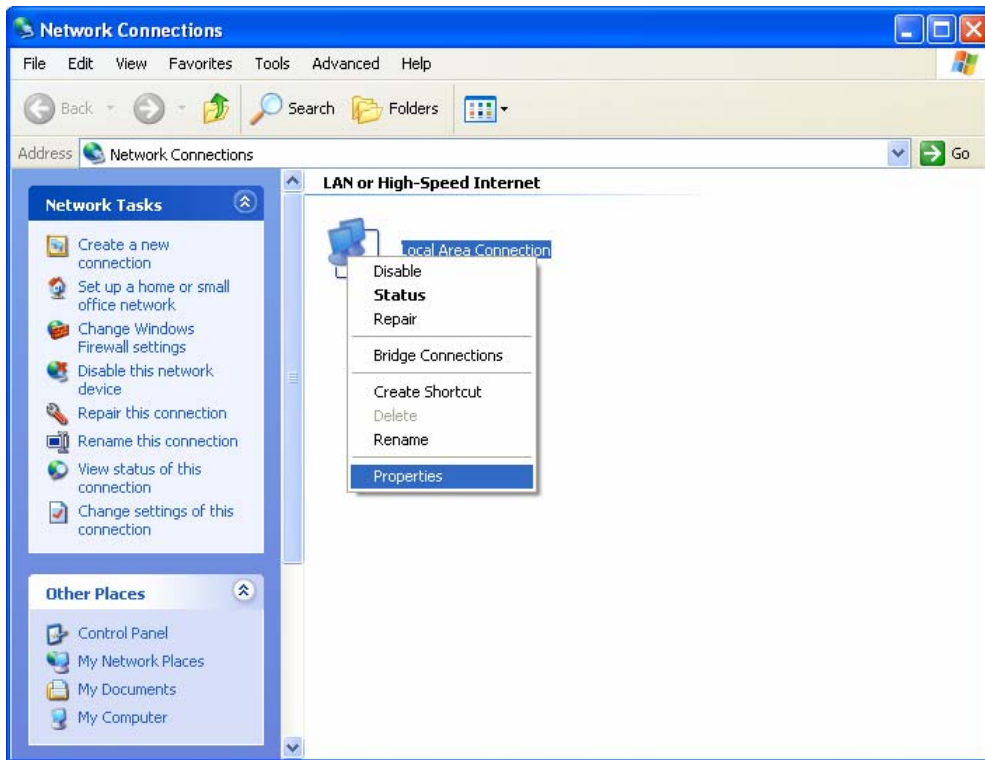

Figure 3-2

Step 3: Select **General** tab, highlight **Internet Protocol (TCP/IP)**, and then click the **Properties** button.

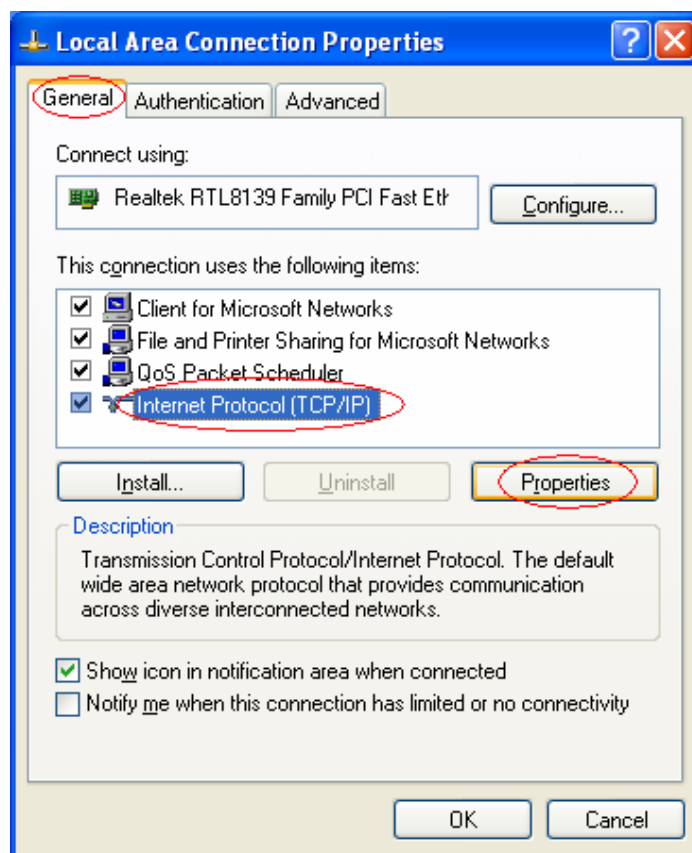

Figure 3-3

Step 4: Configure the IP address as Figure 3-4 shows. After that, click **OK**.

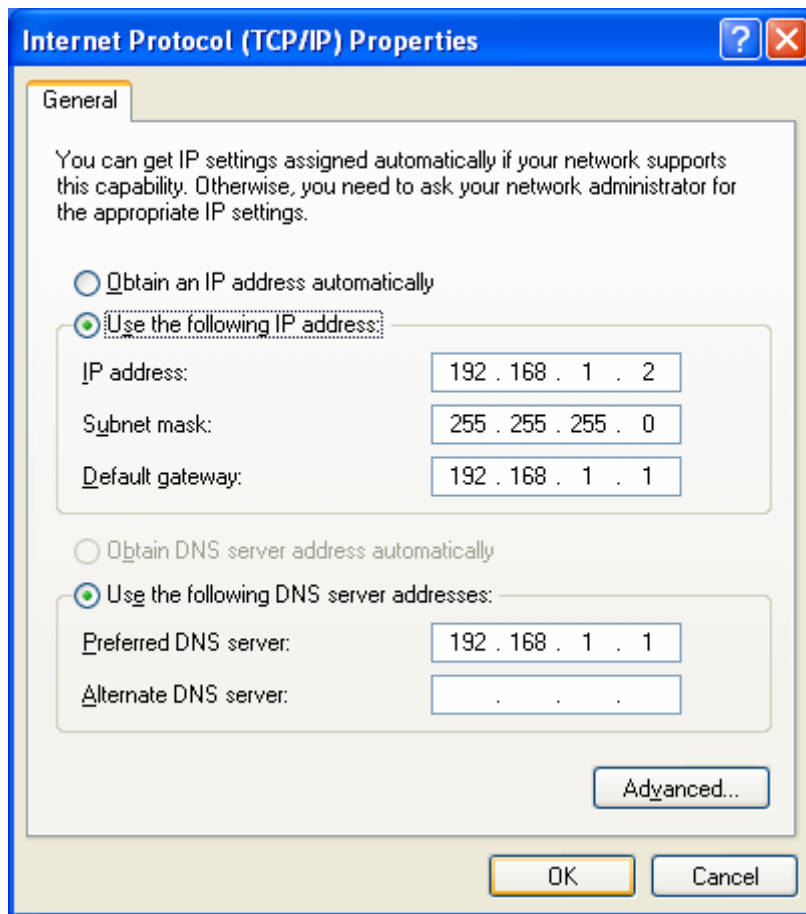

Figure 3-4

Note:

You can configure the PC to get an IP address automatically, select “Obtain an IP address automatically” and “Obtain DNS server address automatically” in the screen above.

Now, you can run the Ping command in the command prompt to verify the network connection. Please click the **Start** menu on your desktop, select **run** tab, type **cmd** or **command** in the field and press **Enter**. Type **ping 192.168.1.1** on the next screen, and then press **Enter**.

If the result displayed is similar to the screen below, the connection between your PC and the Modem Router has been established.

```
Pinging 192.168.1.1 with 32 bytes of data:
Reply from 192.168.1.1: bytes=32 time<1ms TTL=64
Reply from 192.168.1.1: bytes=32 time<1ms TTL=64
Reply from 192.168.1.1: bytes=32 time<1ms TTL=64
Reply from 192.168.1.1: bytes=32 time<1ms TTL=64

Ping statistics for 192.168.1.1:
    Packets: Sent = 4, Received = 4, Lost = 0 (0% loss),
Approximate round trip times in milli-seconds:
    Minimum = 0ms, Maximum = 0ms, Average = 0ms
```

Figure 3-5

If the result displayed is similar to the screen shown below, it means that your PC has not connected to the Modem Router.

```
Pinging 192.168.1.1 with 32 bytes of data:
Request timed out.
Request timed out.
Request timed out.
Request timed out.

Ping statistics for 192.168.1.1:
    Packets: Sent = 4, Received = 0, Lost = 4 (100% loss),
```

Figure 3-6

You can check it following the steps below:

1) Is the connection between your PC and the Modem Router correct?

The LEDs of LAN port which you link to the device and the LEDs on your PC's adapter should be lit.

2) Is the TCP/IP configuration for your PC correct?

If the Modem Router's IP address is 192.168.1.1, your PC's IP address must be within the range of 192.168.1.2 ~ 192.168.1.254.

3.2 Quick Installation Guide

With a Web-based utility, it is easy to configure and manage the TD-W8962ND 300Mbps Wireless N ADSL2+ Modem Router. The Web-based utility can be used on any Windows, Macintosh or UNIX OS with a Web browser, such as Microsoft Internet Explorer, Mozilla Firefox or Apple Safari.

1. To access the configuration utility, open a web-browser and type the default address `http://192.168.1.1` in the address field of the browser.



Figure 3-7

After a moment, a login window will appear, similar to the Figure 3-8. Enter **admin** for the User Name and Password, both in lower case letters. Then click the **OK** button or press the **Enter** key.



Figure 3-8

 **Note:**

- 1) Do not mix up the user name and password with your ADSL account user name and password which are needed for PPP connections.
- 2) If the above screen does not pop up, it means that your Web-browser has been set to a proxy. Go to **Tools** menu→**Internet Options**→**Connections**→**LAN Settings**, in the screen that appears, cancel the Using Proxy checkbox, and click **OK** to finish it.
2. After your successful login, you will see the Login screen as shown in Figure 3-9. Click **Quick Setup** menu to access **Quick Setup Wizard**.

Status	Basic Status																							
Quick Setup	Device Information																							
System Mode	Firmware version: 0.8.0.1.0 v0009.0 Build 120810 Rel.33839n																							
Network	Hardware version: TD-W8962ND v1 00000000																							
DHCP Server	System up time: 0 day(s) 00:24:12																							
Wireless	DSL																							
Route Settings	Line Status: DSL Disconnected																							
Forwarding	DSL Modulation Type: Multimode																							
Parent Control	Annex Type: Annex A/L/M																							
Firewall	<table border="1"> <thead> <tr> <th></th> <th>Upstream</th> <th>Downstream</th> </tr> </thead> <tbody> <tr> <td>Current Rate (Kbps)</td> <td>0</td> <td>0</td> </tr> <tr> <td>Max Rate (Kbps)</td> <td>0</td> <td>0</td> </tr> <tr> <td>SNR Margin (db)</td> <td>0</td> <td>0</td> </tr> <tr> <td>Line Attenuation (db)</td> <td>0</td> <td>0</td> </tr> <tr> <td>Errors (Pkts)</td> <td>0</td> <td>0</td> </tr> </tbody> </table>							Upstream	Downstream	Current Rate (Kbps)	0	0	Max Rate (Kbps)	0	0	SNR Margin (db)	0	0	Line Attenuation (db)	0	0	Errors (Pkts)	0	0
	Upstream	Downstream																						
Current Rate (Kbps)	0	0																						
Max Rate (Kbps)	0	0																						
SNR Margin (db)	0	0																						
Line Attenuation (db)	0	0																						
Errors (Pkts)	0	0																						
Bandwidth Control	WAN																							
IP & MAC Binding	<table border="1"> <thead> <tr> <th>Name</th> <th>Connection Type</th> <th>VPI/VCI</th> <th>IP/Mask</th> <th>Gateway</th> <th>DNS</th> <th>Status</th> </tr> </thead> <tbody> <tr> <td></td> <td></td> <td></td> <td></td> <td></td> <td></td> <td></td> </tr> </tbody> </table>						Name	Connection Type	VPI/VCI	IP/Mask	Gateway	DNS	Status											
Name	Connection Type	VPI/VCI	IP/Mask	Gateway	DNS	Status																		
Dynamic DNS	LAN																							
Diagnostic	MAC Address: 40:16:9F:BF:51:06																							
System Tools	IP Address: 192.168.1.1																							
	Subnet Mask: 255.255.255.0																							
	DHCP: Enabled																							
	WLAN																							
	Status: Enabled																							
	SSID: TP-LINK_BF5106																							
	Channel: Auto(Channel 11)																							
	Channel Width: Auto																							
	Mode: 11bgn Mixed																							
	Encryption: None																							
	MAC Address: 40:16:9F:BF:51:06																							
	Max Tx Rate: 300Mbps																							
	WDS Status: Disabled																							

Figure 3-9

- The Modem Router provides two system mode: Wireless ADSL Router and Wireless Router. Choose the right mode which you need, then click **Next**.

Quick Setup - System Mode

This page is for the choosing of system mode. See the result in the "WAN Settings".

Choose system mode:

Wireless ADSL Router

Wireless Router

Previous
Next

Figure 3-10

3.2.1 Wireless ADSL Router

- Change the VPI or VCI values which are used to define a unique path for your connection. **If you are unsure, please consult your ISP.** Click **Next**.

Figure 3-11

2. Please select the connection type given by your ISP.

Figure 3-12

A. Configuration for PPPoE/PPPoA

Enter the **Username**, **Password** given by your ISP, and then click **Next**.

Figure 3-13

 **Note:**

If you are using the Modem Router on a new DSL line and have not completed your DSL provider's online registration, you may be using a generic username and password. When registration is completed, you will need to update the username and password if you have created a new one.

B. Configuration for Dynamic IP or Bridge

This type doesn't need to be configured.

C. Configuration for Static IP or IPoA

Enter the **Static IP** or **IPoA** information provided by your ISP manually, and then click **Next**.

Figure 3-14

3. The wireless settings page will appear as shown below. You can create a unique and easy-to-remember name for your wireless network or just keep the default SSID. Then select **Region**, **Channel**, **Mode** and set a Password for your network (Disable Security is not recommended). Then click **Next** to continue.

Figure 3-15

4. On this page, please confirm all parameters. Click **Previous** to modify or click the **Save** button to make the configuration take effect. Here we take PPPoE Connection Type for example

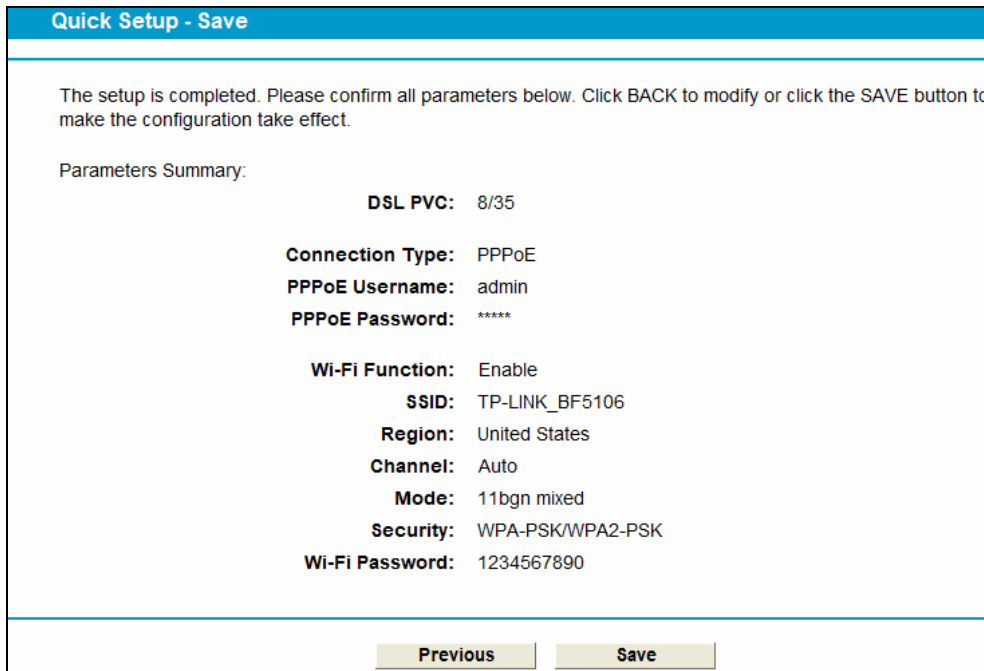

Figure 3-16

5. You will see the **Complete** screen below, click **Reboot** to complete Quick Setup.

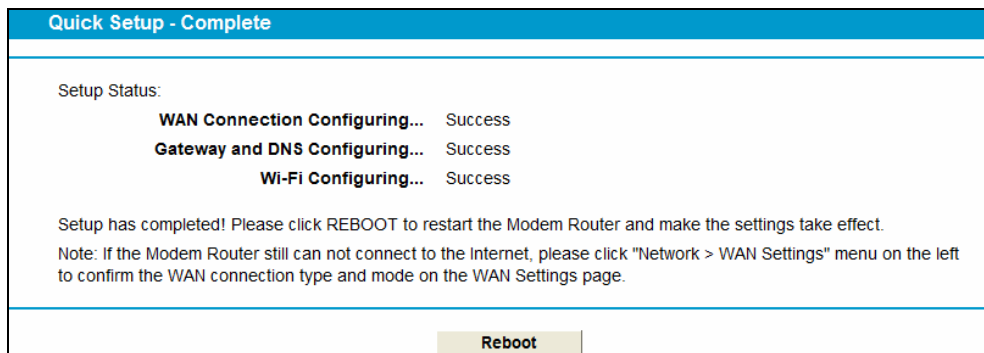

Figure 3-17

Note:

Now, your Modem Router has been configured and is rebooting. Please do not turn off the Modem Router while it's rebooting.

3.2.2 Wireless Router

1. Please select the connection type provided by your ISP.

Figure 3-18

A. Configuration for PPPoE

Enter the **Username**, **Password** given by your ISP, and then click **Next**.

Figure 3-19

Note:

If you are using the Modem Router on a new DSL line and have not completed your DSL provider's online registration, you may be using a generic username and password. When registration is completed, you will need to update the username and password if you have created a new one.

B. Configuration for Dynamic IP

This type doesn't need to be configured.

C. Configuration for Static IP

Enter the **Static IP** information provided by your ISP manually, and then click **Next**.

Figure 3-20

- The wireless settings page will appear as shown below. You can create a unique and easy-to-remember name for your wireless network or just keep the default SSID. Then select **Region**, **Channel**, **Mode** and set a Password for your network (Disable Security is not recommended). Then click **Next** to continue.

Figure 3-21

- On this page, please confirm all parameters. Click **Previous** to modify or click the **Save** button to make the configuration take effect. Here we take PPPoE Connection Type for example

Quick Setup - Save

The setup is completed. Please confirm all parameters below. Click BACK to modify or click the SAVE button to make the configuration take effect.

Parameters Summary:

DSL PVC: 8/35

Connection Type: PPPoE
PPPoE Username: admin
PPPoE Password: *****

Wi-Fi Function: Enable
SSID: TP-LINK_BF5106
Region: United States
Channel: Auto
Mode: 11bgn mixed
Security: WPA-PSK/WPA2-PSK
Wi-Fi Password: 1234567890

Figure 3-22

4. You will see the **Complete** screen below, click **Reboot** to complete Quick Setup.

Quick Setup - Complete

Setup Status:

WAN Connection Configuring... Success
Gateway and DNS Configuring... Success
Wi-Fi Configuring... Success

Setup has completed! Please click REBOOT to restart the Modem Router and make the settings take effect.
 Note: If the Modem Router still can not connect to the Internet, please click "Network > WAN Settings" menu on the left to confirm the WAN connection type and mode on the WAN Settings page.

Figure 3-23

 **Note:**

Now, your Modem Router has been configured and is rebooting. Please do not turn off the Modem Router while it's rebooting.

Chapter 4. Configuring the Modem Router

This chapter will show each Web page's key function and the configuration way.

4.1 Login

After your successful login, you will see the fifteen main menus on the left of the Web-based utility. On the right, there are the corresponding explanations and instructions.



Status
Quick Setup
System Mode
Network
DHCP Server
Wireless
Route Settings
Forwarding
Parent Control
Firewall
Bandwidth Control
IP & MAC Binding
Dynamic DNS
Diagnostic
System Tools

The detailed explanations for each Web page's key function are listed below.

4.2 Status

Choose “**Status**”, you can see the corresponding information about **Device Information**, **DSL**, **WAN**, **LAN** and **WLAN**.

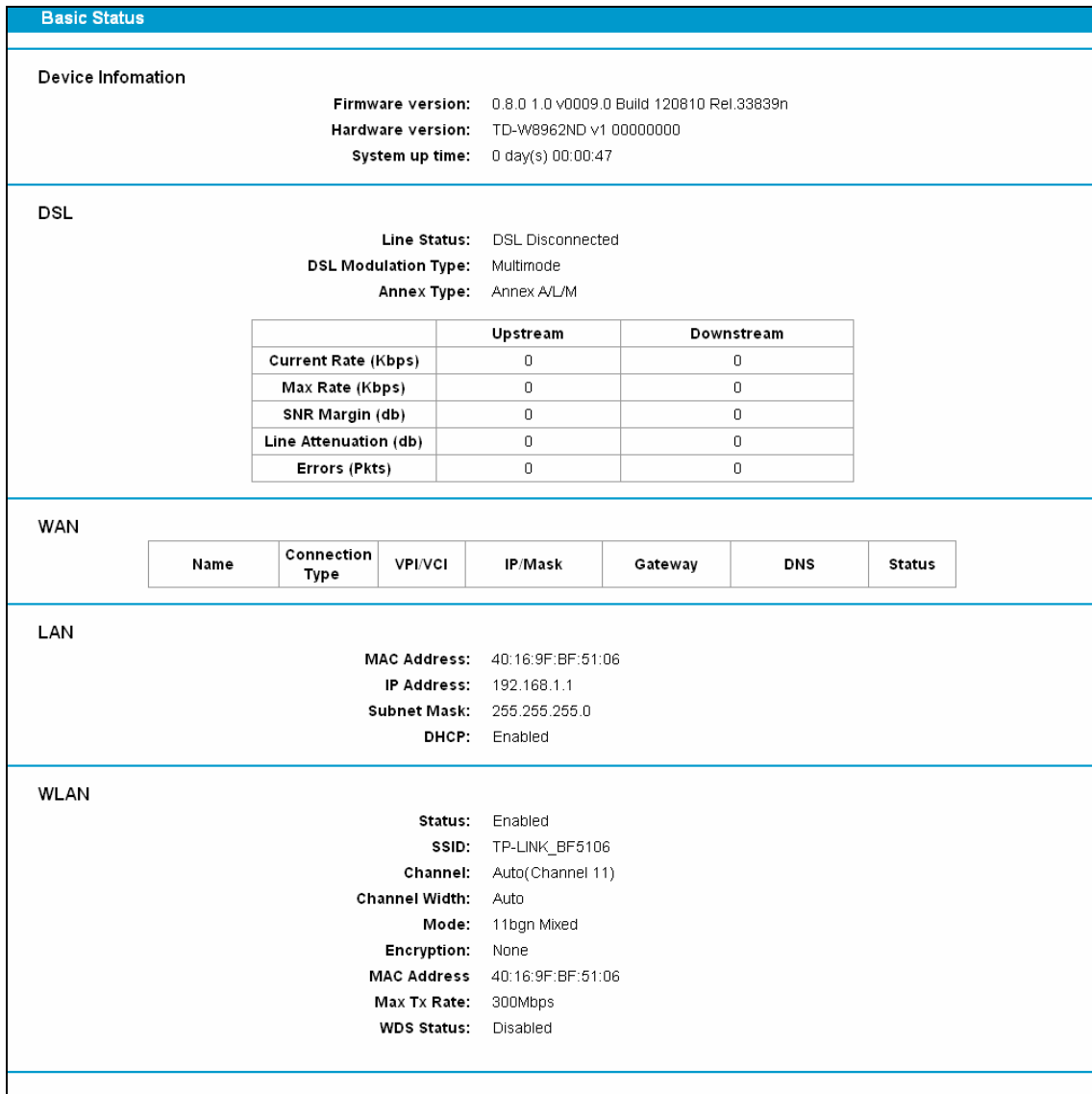

Figure 4-1

4.3 Quick Setup

Please refer to Section [3.2 Quick Installation Guide](#).

4.4 System Mode

The Modem Router provides two system modes: Wireless ADSL Router and Wireless Router. You can choose the right mode which you need, then click **Save**.

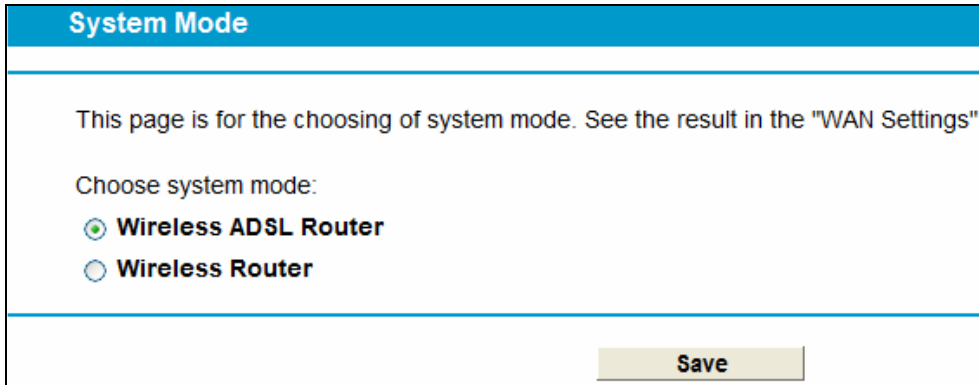
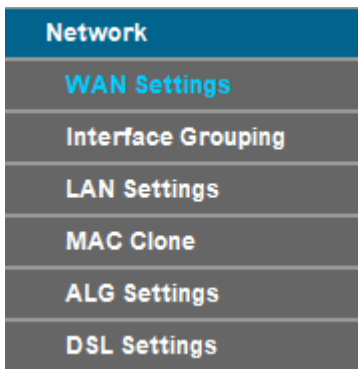

Figure 4-2

4.5 Network

Choose “**Network**”, there are many submenus under the main menu. Click any one of them, and you will be able to configure the corresponding function.



4.5.1 WAN Settings

Choose “**Network**”→“**WAN Settings**”, and you will see the WAN Port Information Table in the screen similar to Figure 4-3, which describes the WAN port settings and the relevant manipulation to each interface. There are five different configurations for the connection types, which are Static IP, Dynamic IP, PPPoE, IPoA, and Bridge. You can select the corresponding types according to your needs.

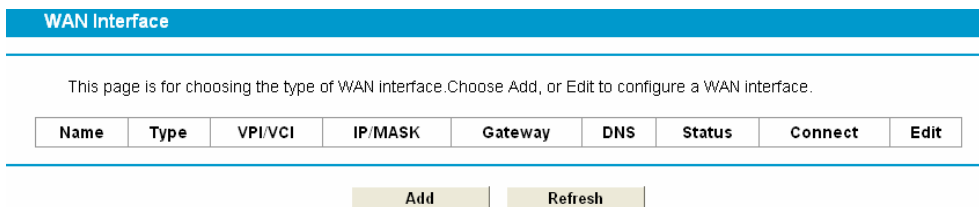

Figure 4-3

Click **Add** to add a new entry, you can configure the parameters for ATM and WAN Service in the next screen (shown in Figure 4-4).

WAN Configuration

WAN port can be set on this page.

ATM Configuration

VPI(0-255):

VCI(1-65535):

Hide -

Notice: Do not change the parameters below unless necessary!

Encapsulation Mode: LLC

ATM Qos Type: UBR

PCR: Frames/s

SCR: Frames/s

MBS: Frames/s

WAN Service Setup

WAN Connection Type: PPPoE

PPP Username:

PPP Password:

Confirm Password:

Choose the right connection type according to your needs:

- Connect on demand. The connection will be automatically on when there is internet access
Max Idle Time: minutes (0 means remain active at all time)
- Connect automatically. The connection will be automatically on after startup or disconnection
- Connect manually user connects manually
Max Idle Time: minutes (0 means remain active at all time)

Authentication Method: AUTO_AUTH

Default Gateway: Current Connection

Hide -

Service Name: (do not change unless necessary)

Server Name: (do not change unless necessary)

MTU(bytes): (1480 as default, do not change unless necessary)

Enable Fullcone NAT

Enable SPI Firewall

Enable IGMP Proxy

Use IP address specified by ISP

Echo request interval: (0-120 seconds, 0 means no request)

Set DNS server manually

Save Back

Figure 4-4

4.5.1.1 Static IP

Select this option if your ISP provides static IP information to you. You should set static IP address, IP subnet mask, and gateway address in the screen below.

WAN Configuration

WAN port can be set on this page.

ATM Configuration

VPI(0-255): 0

VCI(1-65535): 35

Notice:Do not change the parameters below unless necessary!

Encapsulation Mode: LLC

ATM Qos Type: UBR

PCR: 0 Frames/s

SCR: 0 Frames/s

MBS: 0 Frames/s

WAN Service Setup

WAN Connection Type: Static IP

IP Address: 0.0.0.0

Subnet Mask: 0.0.0.0

Gateway: 0.0.0.0 (Optional)

DNS Server: 0.0.0.0 (Optional)

Secondary DNS server: 0.0.0.0 (Optional)

Default Gateway: Current Connection

MTU(bytes): 1500 (1500 as default,do not change unless necessary)

Enable NAT

Enable Fullcone NAT

Enable SPI Firewall

Enable IGMP Proxy

Save Back

Figure 4-5

ATM Configuration:

- **VPI (0~255):** Identifies the virtual path between endpoints in an ATM network. The valid range is from 0 to 255. Please input the value provided by your ISP.
- **VCI (1~65535):** Identifies the virtual channel endpoints in an ATM network. The valid range is from 1 to 65535 (1 to 31 is reserved for well-known protocols). Please input the value provided by your ISP.

Click **Advanced**, advanced selections of ATM Configuration can be shown.

- **Encapsulation Mode:** Select the encapsulation mode for the Static IP Address. Here you can leave it default.
- **ATM Qos Type:** Select ATM Qos Type provided by ISP, and the type is UBR by default.

WAN Service Setup:

- **IP Address:** Enter the IP address in dotted-decimal notation provided by your ISP.
- **Subnet Mask:** Enter the subnet Mask in dotted-decimal notation provided by your ISP, usually is 255.255.255.0.
- **Default Gateway (Optional):** Enter the gateway IP address in dotted-decimal notation provided by your ISP.
- **DNS Server/ Secondary DNS Server:** Here you can set DNS Server (at least one) manually. The Route will use this DNS Server for priority.
- **Default Gateway:** select a WAN Interface from the drop-down list as the IPv4 default gateway.

- **MTU (bytes):** Maximum Transmission Unit Size. Check this box then you can change the MTU size. The default **MTU** value is 1500 Bytes. It is not recommended that you change the default value unless required by your ISP.
- **Enable NAT:** This technology translates the IP addresses of a local area network to a different IP address for the Internet. If this Modem Router is hosting your network's connection to the Internet, please select the check box. If another Router exists in your network, you don't need to select the option.
- **Enable Fullcone NAT:** It is a type of NAT, if not enabled, the default NAT will act.
- **Enable SPI Firewall:** A SPI firewall enhances network's security. Select the option to use a firewall, or else without a firewall.
- **Enable IGMP Proxy:** IGMP (Internet Group Management Protocol) is used to manage multicasting on TCP/IP networks. Some ISPs use IGMP to perform remote configuration for client devices, such as the Modem Router. The default value is disabled, and if you are not sure, please contact your ISP or just leave it.

Click the **Save** button to save the settings.

4.5.1.2 Dynamic IP

Select this option, the Modem Router will be able to obtain IP network information dynamically from a DHCP server provided by your ISP.

The screenshot shows the WAN Configuration page. At the top, it says 'WAN port can be set on this page.' Below that is the 'ATM Configuration' section with VPI(0-255) set to 0 and VCI(1-65535) set to 32. A notice states: 'Notice: Do not change the parameters below unless necessary!' followed by 'Encapsulation Mode: LLC', 'ATM Qos Type: UBR', and fields for PCR, SCR, and MBS. The 'WAN Service Setup' section shows 'WAN Connection Type' as 'Dynamic IP', with IP Address, Subnet Mask, and Gateway all set to 0.0.0.0. Below this are checkboxes for 'Enable NAT' (checked), 'Enable Fullcone NAT' (unchecked), 'Enable SPI Firewall' (unchecked), 'Enable IGMP Proxy' (checked), and 'Get IP with Unicast' (unchecked). At the bottom, there is a 'Set DNS server manually' checkbox (unchecked) and a 'Host Name' field containing 'TD-W8962ND'. A 'Save' button is located at the bottom center.

Figure 4-6

Click **Advanced**, advanced selections for WAN Service Setup can be shown.

- **MTU (bytes):** Maximum Transmission Unit Size. Check this box then you can change the MTU size. The default **MTU** value is 1500 Bytes. It is not recommended that you change the default value unless required by your ISP.
- **Enable NAT:** This technology translates the IP addresses of a local area network to a different IP address for the Internet. If this Modem Router is hosting your network's connection to the

Internet, please select the check box. If another Router exists in your network, you don't need to select the option.

- **Enable Fullcone NAT:** It is a type of NAT, if not enabled, the default NAT will act.
- **Enable SPI Firewall:** A SPI firewall enhances network's security. Select the option to use a firewall, or else without a firewall.
- **Enable IGMP Proxy:** IGMP (Internet Group Management Protocol) is used to manage multicasting on TCP/IP networks. Some ISPs use IGMP to perform remote configuration for client devices, such as the Modem Router. The default value is disabled, and if you are not sure, please contact your ISP or just leave it.
- **Get IP Unicast:** This is disabled by default. The minority of DHCP Server of ISP will not support to enable this. When the Route is connected right but IP cannot get, you can select this box.
- **Primary DNS Server/ Secondary DNS Server:** Choose "Set DNS Server manually", you can set DNS Server (at least one) manually here. The Route will use this DNS Server for priority.

Click the **Save** button to save the settings.

4.5.1.3 PPPoE

If your ISP provides a **PPPoE** connection and you need to use an ATM Interface, choose **PPPoE** in the drop-down list, and then the screen will be displayed as below.

The screenshot shows the WAN Configuration page with the following sections:

- WAN Configuration** (Title)
- WAN port can be set on this page.
- ATM Configuration**
 - VPI(0-255): 0
 - VC(1-65535): 32
- Notice: Do not change the parameters below unless necessary!
- Encapsulation Mode:** LLC
- ATM Qos Type:** UBR
- PCR: 0 Frames/s
- SCR: Frames/s
- MBS: Frames/s

- WAN Service Setup**
 - WAN Connection Type:** PPPoE
 - PPP Username: []
 - PPP Password: []
 - Confirm Password: []
- Choose the right connection type according to your needs:
 - Connect on demand. The connection will be automatically on when there is internet access. Max Idle Time: 15 minutes (0 means remain active at all time)
 - Connect automatically. The connection will be automatically on after startup or disconnection.
 - Connect manually, user connects manually. Max Idle Time: 15 minutes (0 means remain active at all time)
- Authentication Method:** AUTO_AUTH
- Default Gateway:** Current Connection

- Service Name:** [] (do not change unless necessary)
- Server Name:** [] (do not change unless necessary)
- MTU(bytes):** 1480 (1480 as default, do not change unless necessary)
- Enable Fullcone NAT:**
- Enable SPI Firewall:**
- Enable IGMP Proxy:**
- Use IP address specified by ISP:**
- Echo request interval:** 30 (0-120 seconds, 0 means no request)
- Set DNS server manually:**

Buttons: Save, Back

Figure 4-7

- **PPP Username/Password/Confirm Password:** Enter the User Name, Password and Confirm Password provided by your ISP. These fields are case-sensitive.

- **Authentication Method:** Select the **Authentication Method** from the drop-down list, the default method is **AUTO_AUTH**, and you can leave it as a default setting.
- **Choose the right connection type according to your needs:** For PPPoE connection, you can select **Connect on demand** or **Connect automatically** or **Connect manually**. Connect on demand is dependent on the traffic. If there is no traffic (or **Idle** for a pre-specified period of time), the connection will tear down automatically. And once there is traffic send or receive, the connection will be automatically on.

Click **Advanced**, advanced selections for WAN Service Setup can be shown.

- **Service Name/Server Name:** Enter the Service Name and Server Name if it was provided by your ISP. You can leave them blank, if the ISP doesn't provide them.

4.5.1.4 PPPoA

If your ISP provides a **PPPoA** connection and you need to use an ATM Interface, choose **PPPoA** in the drop-down list, and then the screen will be displayed as below.

The configuration is similar to **PPPoE**. Please refer to the section [4.4.14 PPPoE](#) to configure this part.

The screenshot displays the WAN Configuration interface. At the top, it states 'WAN port can be set on this page.' Below this, the 'ATM Configuration' section includes input fields for 'VPI(0-255):' (set to 0) and 'VCI(1-65535):' (set to 32). A 'Notice' section follows, advising not to change parameters unless necessary. The 'Encapsulation Mode' is set to 'VC-Mux', and 'ATM Qos Type' is set to 'UBR'. Below these are fields for 'PCR:', 'SCR:', and 'MBS:', each with a 'Frames/s' label. The 'WAN Service Setup' section shows 'WAN Connection Type' set to 'PPPoA'. It includes fields for 'PPP Username:', 'PPP Password:', and 'Confirm Password:'. A note asks to 'Choose the right connection type according to your needs:' with three radio button options: 'Connect on demand', 'Connect automatically' (selected), and 'Connect manually'. Below this, 'Authentication Method' is set to 'AUTO_AUTH' and 'Default Gateway' is set to 'Current Connection'. At the bottom, there are checkboxes for 'Enable SPI Firewall', 'Enable IGMP Proxy', 'Use IP address specified by ISP', 'Set DNS server manually', and an 'Echo request interval' set to 30. 'Save' and 'Back' buttons are at the very bottom.

Figure 4-8

4.5.1.5 IPoA

If your ISP provides an IPoA connection, select **IPoA** option for the **WAN service type** on the screen.

The screenshot shows the WAN Configuration page. At the top, it says "WAN port can be set on this page." Below this is the "ATM Configuration" section with input fields for VPI(0-255): 0 and VCI(1-65535): 32. A "Hide" button is to the right. A notice below reads "Notice: Do not change the parameters below unless necessary!". The "Encapsulation Mode" is set to LLC, "ATM Qos Type" to UBR, and PCR, SCR, and MBS are all set to 0 Frames/s. The "WAN Service Setup" section has "WAN Connection Type" set to IPoA. Below this are input fields for IP Address, Subnet Mask, GateWay, DNS Server, and Secondary DNS server, all with default values of 0.0.0.0. The "Default Gateway" is set to "Current Connection". At the bottom, "MTU(bytes)" is 1500, and checkboxes for "Enable NAT", "Enable SPI Firewall", and "Enable IGMP Proxy" are checked. "Save" and "Back" buttons are at the very bottom.

Figure 4-9

- **IP Address/Subnet Mask:** Enter the IP Address and Subnet Mask provided by ISP. If you forget, you can ask your ISP.
- **DNS Server/Secondary DNS Server:** Type in your preferred DNS server.
- **Default Gateway:** select a WAN Interface from the drop-down list as the IPv4 default gateway.

4.5.1.6 Bridge

If you select this type of connection, the modem can be configured to act as a bridging device between your LAN and your ISP. Bridges are devices that enable two or more networks to communicate as if they are two segments of the same physical LAN.

This screenshot is identical to Figure 4-9, but the "WAN Connection Type" dropdown menu is set to "Bridge" instead of "IPoA". All other settings and the layout are the same.

Figure 4-10

Note:

After you finish the Internet configuration, please click **Save** to make the settings take effect.

4.5.2 Interface Grouping

Choose “**Network**”→“**Interface Grouping**”, you can view all the current groups on this page (shown in Figure 4-11).

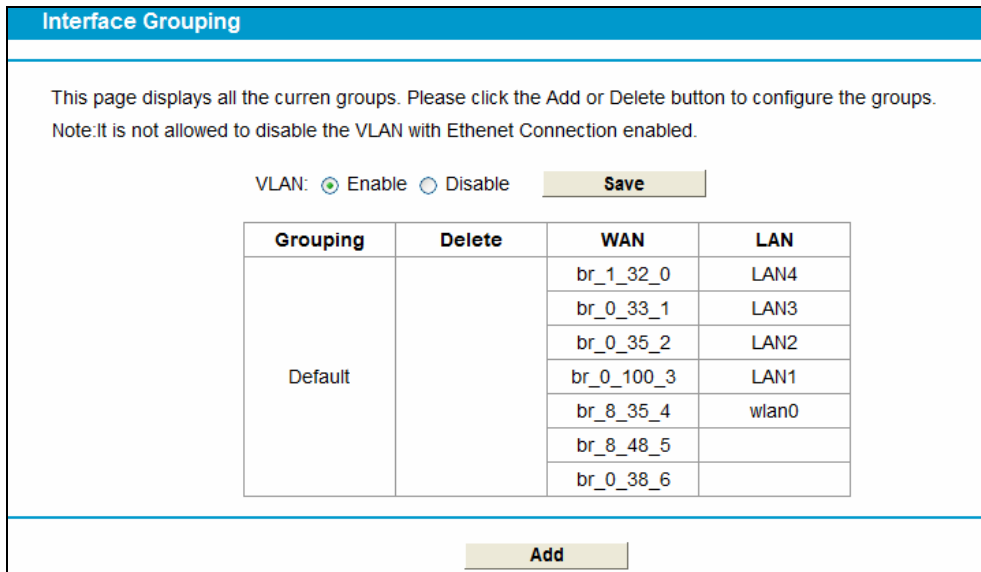

Figure 4-11

- **VLAN:** Enable or disable this function. Virtual LAN (VLAN) is a group of devices on one or more LANs that are configured so that they can communicate as if they were attached to the same LAN, when in fact they are located on a number of different LAN segments. Because VLANs are based on logical instead of physical connections, it is very flexible for user/host management, bandwidth allocation and resource optimization. If you want to active this function, this function must be enabled.

 **Note:**

It is not allowed to disable the VLAN with Ethernet Connection enabled.

To support this feature, you must create mapping groups with appropriate LAN and WAN interfaces using the **Add** button. The **Remove** button will remove the grouping and add the ungrouped interfaces to the Default group. Only the default group has IP interface.

Click the **Add** button. You can add a new interface group in the next screen. For example, you want LAN1 and LAN3 to be a group called Group 1 over br_0_35_0 WAN interface, you can refer to the following figure.

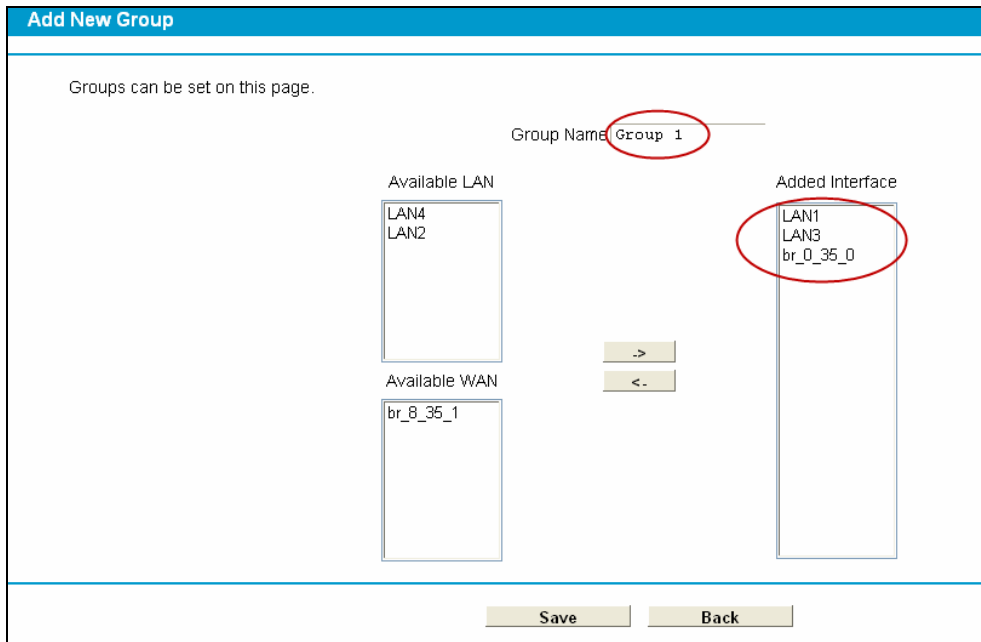

Figure 4-12

Click **Save** to make the entry effective immediately

4.5.3 LAN Settings

Choose “**Network**”→“**LAN Settings**” menu, and you will see the LAN screen (shown in Figure 4-13). Please configure the parameters for LAN ports according to the descriptions below.

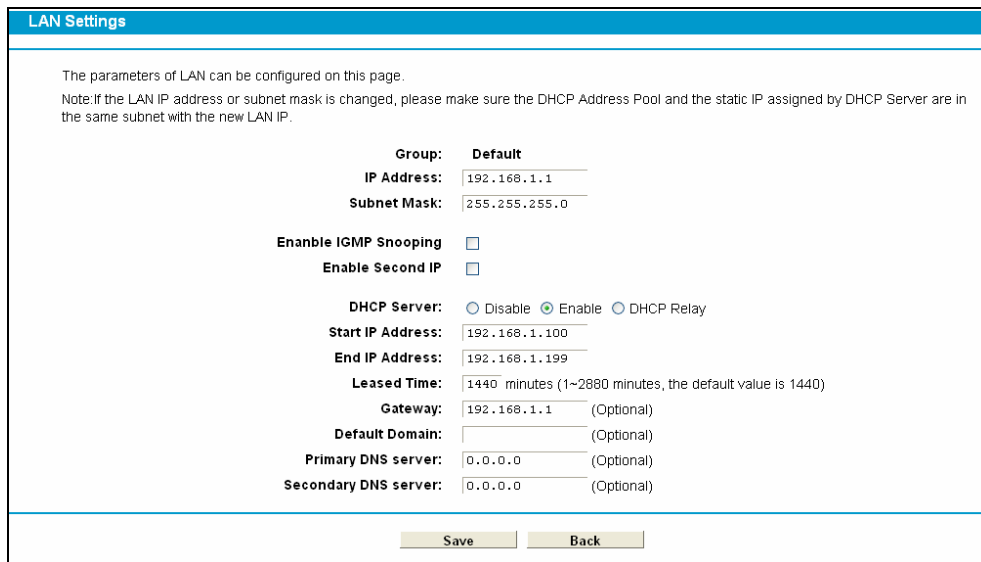

Figure 4-13

- **IP Address:** You can configure the Modem Router’s IP Address and Subnet Mask for LAN Interface.
 - **IP Address:** Enter the Modem Router’s local IP Address, then you can access to the Web-based Utility via the IP Address, the default value is 192.168.1.1.
 - **Subnet Mask:** Enter the Modem Router’s Subnet Mask, the default value is 255.255.255.0.

- **Enable IGMP Snooping:** If you select the option, please choose the IGMP Mode: Standard Mode or Blocking Mode.
- **Enable Second IP:** You can configure the Modem Router's second IP Address and Subnet Mask for LAN Interface through which you can also access to the Web-based Utility as the default IP Address and Subnet Mask.
- **DHCP Server:** These settings allow you to configure the Modem Router's Dynamic Host Configuration Protocol (DHCP) server function. The DHCP server is enabled by default for the Modem Router's Ethernet LAN interface. DHCP service will supply IP settings to computers which are configured to automatically obtain IP settings that are connected to the Modem Router though the Ethernet port. When the Modem Router is set for DHCP, it becomes the default gateway for DHCP client connected to it. Keep in mind that if you change the IP address of the Modem Router, you must change the range of IP addresses in the pool used for DHCP on the LAN.
 - **Start IP Address:** Enter a value for the DHCP server to start with when issuing IP addresses. Because the default IP address for the Modem Router is 192.168.1.1, the default Start IP Address is **192.168.1.100**, and the Start IP Address must be 192.168.1.100 or greater, but smaller than 192.168.1.254.
 - **End IP Address:** Enter a value for the DHCP server to end with when issuing IP addresses. The End IP Address must be smaller than 192.168.1.254. The default End IP Address is **192.168.1.254**.
 - **Leased Time:** The Leased Time is the amount of time in which a network user will be allowed connection to the Modem Router with their current dynamic IP address. Enter the amount of time, in hours, then the user will be "leased" this dynamic IP address. After the dynamic IP address has expired, the user will be automatically assigned a new dynamic IP address. The default is **1440** minutes.

The detailed configuration about DHCP server, please refer to section [4.5 DHCP Server](#).

4.5.4 MAC Clone

Choose menu "**Advanced Setup**"→"**MAC Clone**", you can configure the MAC address of the WAN Interface as shown below.

The WAN Interface List displays the Lay2 Interfaces you have configured on the section [4.4.1 WAN Settings](#), [4.4.2 Ethernet WAN](#) and its default MAC Address. You can select corresponding WAN Interface from the drop-down list and click **Clone** button to clone your current PC MAC, and then click **Save**.

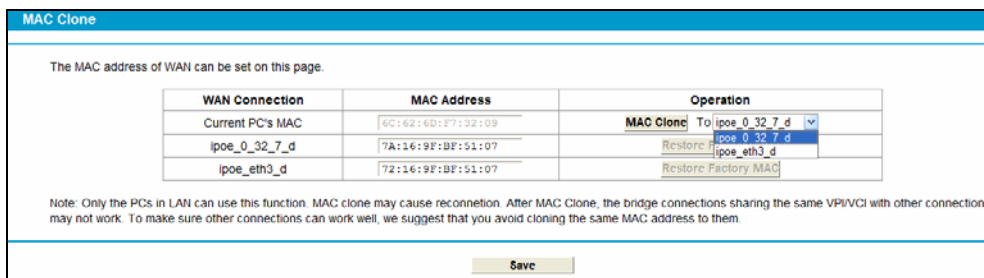

Figure 4-14

Note:

Only the WAN Ports can use MAC Address Clone function. All the clone MAC addresses must not be the same with each other.

4.5.5 ALG Settings

Choose menu “**Advanced Setup**”→“**ALG Settings**”, and then you can configure the basic security in the screen as shown in Figure 4-15.

Application Layer Gateway Settings

This page allows you to enable or disable gateway of application layer.

Virtual Private Network(VPN)

PPTP Passthrough: Enable Disable

L2TP Passthrough: Enable Disable

IPSec Passthrough: Enable Disable

Application Layer Gateway(ALG)

FTP ALG: Enable Disable

TFTP ALG: Enable Disable

Save

Figure 4-15

- **Virtual Private Network (VPN)** - VPN Passthrough must be enabled if you want to allow VPN tunnels using VPN protocols to pass through the Modem Router.
 - **PPTP Passthrough** - Point-to-Point Tunneling Protocol (PPTP) allows the Point-to-Point Protocol (PPP) to be tunneled through an IP network. To allow PPTP tunnels to pass through the Modem Router, click **Enable**.
 - **L2TP Passthrough** - Layer Two Tunneling Protocol (L2TP) is the method used to enable Point-to-Point sessions via the Internet on the Layer Two level. To allow L2TP tunnels to pass through the Modem Router, click **Enable**.
 - **IPSec Passthrough** - Internet Protocol security (IPSec) is a suite of protocols for ensuring private, secure communications over Internet Protocol (IP) networks, through the use of cryptographic security services. To allow IPSec tunnels to pass through the Modem Router, click **Enable**.
- **Application Layer Gateway (ALG)** - It is recommended to enable Application Layer Gateway (ALG) because ALG allows customized Network Address Translation (NAT) traversal filters to be plugged into the gateway to support address and port translation for certain application layer "control/data" protocols such as FTP, TFTP etc.
 - **FTP ALG** - To allow FTP clients and servers to transfer data across NAT, click **Enable**.
 - **TFTP ALG** - To allow TFTP clients and servers to transfer data across NAT, click **Enable**.

Click the **Save** button to save your settings.

4.5.6 DSL Settings

Choose “**Advanced Setup**”→“**DSL Settings**”, you can select the DSL Modulation Type and Annex Type in the next screen. The DSL feature can be selected when you meet the physical connection problem. Please check the proper settings with your Internet service provider.

Figure 4-16

- **DSL Modulation Type:** Select the DSL operation Modulation Type which your DSL connection uses.
- **Annex Type:** Select the DSL operation Annex Type which your DSL connection uses.

Click the **Save** button to save your settings.

4.6 DHCP Server

Choose “**DHCP Server**”, you can see the next submenus:



Click any of them, and you will be able to configure the corresponding function.

4.6.1 DHCP Settings

Choose menu “**DHCP Server**”→“**DHCP Settings**”, you can configure the DHCP Server on the page as shown in Figure 4-17. The Modem Router is set up by default as a DHCP (Dynamic Host Configuration Protocol) server, which provides the TCP/IP configuration for all the PC(s) that are connected to the Modem Router on the LAN.

DHCP Settings

This page allows you to set DHCP server which provides TCP/IP configuration for all the PCs connected to the Modem Router in the LAN.

Groups: Default
IP Address: 192.168.1.1
Subnet Mask: 255.255.255.0
DHCP Server: Disable Enable DHCP Relay

Start IP Address:
End IP Address:
Address Lease Time: minutes (1~2880 minutes, the default value is 1440)
Default Gateway: (Optional)
Default Domain: (Optional)
Primary DNS: (Optional)
Secondary DNS: (Optional)

Figure 4-17

- **Start IP Address:** Enter a value for the DHCP server to start with when issuing IP addresses. Because the default IP address for the Modem Router is 192.168.1.1, the default Start IP Address is **192.168.1.100**, and the Start IP Address must be 192.168.1.100 or greater, but smaller than 192.168.1.254.
- **End IP Address:** Enter a value for the DHCP server to end with when issuing IP addresses. The End IP Address must be smaller than 192.168.1.254. The default End IP Address is **192.168.1.254**.
- **Address Lease Time:** The Leased Time is the amount of time in which a network user will be allowed connection to the Modem Router with their current dynamic IP address. Enter the amount of time, in hours, then the user will be "leased" this dynamic IP address. After the dynamic IP address has expired, the user will be automatically assigned a new dynamic IP address. The default is **24** hours.
- **Default Gateway** - (Optional.) It is suggested to input the IP address of the LAN port of the Modem Router. The default value is 192.168.1.1.
- **Default Domain** - (Optional.) Input the domain name of your network.
- **Primary DNS** - (Optional.) Input the DNS IP address provided by your ISP or consult your ISP.
- **Secondary DNS** - (Optional.) Input the IP address of another DNS server if your ISP provides two DNS servers.
- **DHCP Relay:** Select **Relay**, then you will see the next screen, and the Modem Router will work as a DHCP Relay. A DHCP relay is a computer that forwards DHCP data between computers that request IP addresses and the DHCP server that assigns the addresses. Each of the device's interfaces can be configured as a DHCP relay. If it is enabled, the DHCP requests from local PCs will forward to the DHCP server runs on WAN side. To have this function working properly, please run on router mode only, disable the DHCP server on the LAN port, and make sure the routing table has the correct routing entry.

Groups:	Default
IP Address:	192.168.1.1
Subnet Mask:	255.255.255.0
DHCP Server:	<input type="radio"/> Disable <input type="radio"/> Enable <input checked="" type="radio"/> DHCP Relay
Remote Server's IP Address:	<input type="text" value="0.0.0.0"/>
Note: You have to disable NAT of the WAN connections. Or the DHCP Relay may not take effect!	
<input type="button" value="Save"/>	

 **Note:**

- 1) To use the DHCP server function of the Modem Router, you must configure all computers on the LAN as "Obtain an IP Address automatically".
- 2) You have to disable NAT of the WAN connections, or the DHCP Relay may not take effect.
- 3) If you select **Disabled**, the DHCP function will not take effect.

Click the **Save** button to save your settings.

4.6.2 Clients List

Choose menu "**DHCP Server**"→"**Clients List**", you can view the information about the clients attached to the Modem Router in the screen as shown in Figure 4-18.

DHCP Clients List				
This page displays the information of DHCP clients.				
ID	Client Name	MAC Address	IP Address	Valid Time
1	tplink13468	40:61:86:E5:B2:DC	192.168.1.100	23:42:05
<input type="button" value="Refresh"/>				

Figure 4-18

- **Client Name:** The name of the DHCP client
- **MAC Address:** The MAC address of the DHCP client
- **IP Address:** The IP address that the Modem Router has allocated to the DHCP client
- **Valid Time:** The time of the DHCP client leased. After the dynamic IP address has expired, a new dynamic IP address will be automatically assigned to the user.

You cannot change any of the values on this page. To update this page and to show the current attached devices, click the **Refresh** button.

4.6.3 Address Reservation

Choose menu "**DHCP Server**"→"**Address Reservation**", you can view and add a reserved address for clients via the next screen (shown in Figure 4-19).When you specify a reserved IP address for a PC on the LAN, that PC will always receive the same IP address each time when it accesses the DHCP server. Reserved IP addresses should be assigned to the servers that require permanent IP settings.

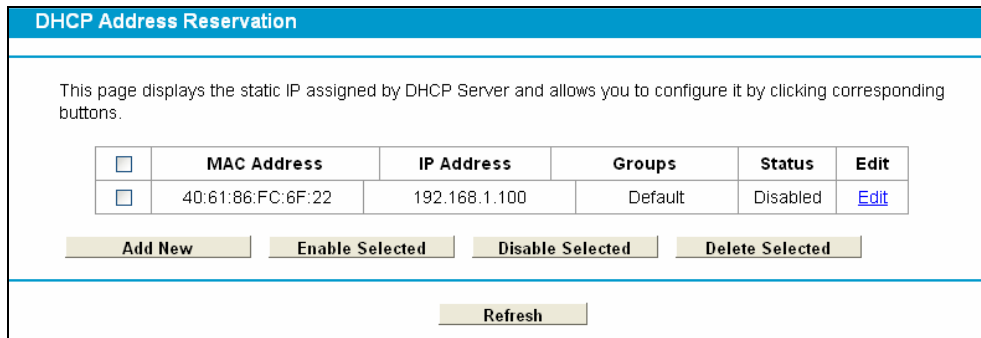

Figure 4-19

- **MAC Address:** The MAC address of the PC for which you want to reserve an IP address.
- **IP Address:** The IP address reserved for the PC by the Modem Router.
- **Status:** The status of this entry either **Enabled** or **Disabled**.

To Reserve an IP address:

1. Click the **Add New** button. Then Figure 4-20 will pop up.
2. Enter the MAC address (in XX:XX:XX:XX:XX:XX format.) and IP address (in dotted-decimal notation) of the computer for which you want to reserve an IP address.
3. Click the **Save** button.

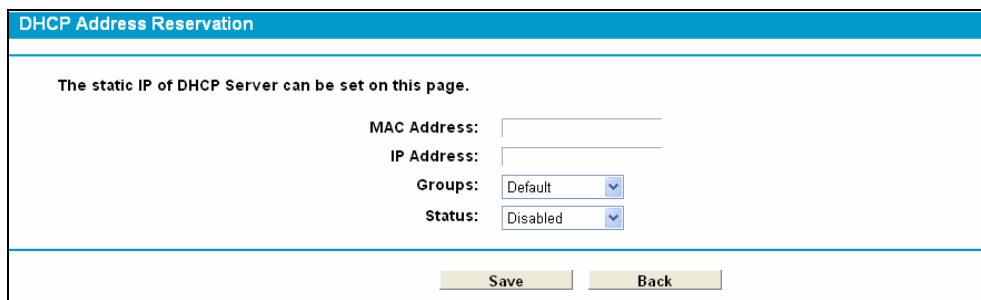

Figure 4-20

To modify or delete an existing entry:

1. Click the **Edit** in the entry you want to modify. If you want to delete the entry, click the **Delete**.
2. Modify the information.
3. Click the **Save** button.

Click the **Enable/Disable Selected** button to make selected entries enabled/disabled.

Click the **Delete Selected** button to selected entries.

4.6.4 Conditional Pool

Choose menu “**DHCP Server**”→“**Conditional Pool**”, you can see the next screen (shown in Figure 4-21). This page displays vendor class settings and allows you to set parameters for vendor class by clicking corresponding buttons.

DHCP Conditional Pool

This page displays vendor class settings and allows you to set parameters for vendor class by clicking corresponding buttons.

<input type="checkbox"/>	Vendor ID	Start IP Address/ End IP Address	Facility	Groups	Status	Edit
<p style="text-align: center;"> <input type="button" value="Add New"/> <input type="button" value="Enable Selected"/> <input type="button" value="Disable Selected"/> <input type="button" value="Delete Selected"/> </p> <p style="text-align: center;"><input type="button" value="Refresh"/></p>						

Figure 4-21

To add a vendor class:

1. Click the **Add New** button. Then Figure 4-22 will pop up.
2. Enter parameters for the vendor class.

Click the **Save** button.

DHCP Conditional Pool

The vendor class IP range can be set on this page.

Facility:

Vendor ID:

Start IP Address:

End IP Address:

Default Gateway:

Device Type:

Add Option:

Option Value:

Groups:

Status:

Figure 4-22

To modify or delete an existing entry:

4. Click the **Edit** in the entry you want to modify. If you want to delete the entry, click the **Delete**.
5. Modify the information.
6. Click the **Save** button.

Click the **Enable/Disable Selected** button to make selected entries enabled/disabled.

Click the **Delete Selected** button to selected entries.

4.7 Wireless

Choose “**Wireless**”, there are six submenus to configure Wireless LAN settings. Click any of them, and you will be able to configure the corresponding function. The detailed explanations for each submenu are provided below.

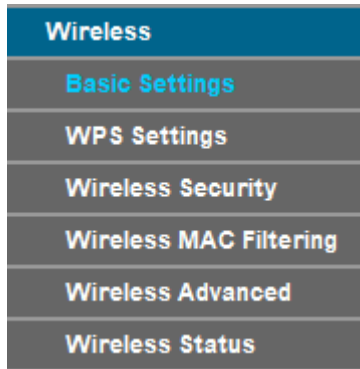

4.7.1 Basic Settings

Choose “**Wireless**”→”**Basic**”, you will see the screen of **Wireless--Basic** settings shown as below. The basic settings for wireless networking are set on this screen.

Figure 4-23

This page allows you to configure basic features of the wireless LAN interface. You can enable or disable the wireless LAN interface, hide the network from active scans, set the wireless network name (also known as SSID) and restrict the channel set based on Region requirements.

- **SSID:** Wireless network name shared among all points in a wireless network. The SSID must be identical for all devices in the wireless network. It is case-sensitive and must not exceed 32 characters (use any of the characters on the keyboard). Make sure this setting is the same for all stations in your wireless network. Type the desired SSID in the space provided.
- **Mode:** Select the desired mode.
 - 11b only:** Select if all of your wireless clients are 802.11b.
 - 11g only:** Select if all of your wireless clients are 802.11g.
 - 11n only:** Select only if all of your wireless clients are 802.11n.
 - 11bg mixed:** Select if you are using both 802.11b and 802.11g wireless clients.

11bgn mixed: Select if you are using a mix of 802.11b, 11g, and 11n wireless clients.

Select the desired wireless mode. When 802.11g mode is selected, only 802.11g wireless stations can be connected to the Modem Router. When 802.11n mode is selected, only 802.11n wireless stations can connect to the Modem Router. It is strongly recommended that you set the Mode to **802.11b&g&n**, and all of 802.11b, 802.11g, and 802.11n wireless stations can connect to the Modem Router.

- **Channel:** Select the channel you want to use from the drop-down List of Channel. This field determines which operating frequency will be used. It is not necessary to change the wireless channel unless you notice interference problems with another nearby access point.
- **Channel Width:** Select the channel width from the drop-down list. The default setting is automatic, which can adjust the channel width for your clients automatically.

 **Note:**

If **11b only**, **11g only**, or **11bgn mixed** is selected in the **Mode** field, the **Channel Width** selecting field will turn grey and the value will become 20M, which is unable to be changed.

- **Enable Wireless Router Radio:** If you want to use wireless features, you must select “Enable Wireless Router Radio”. If you deselect “Enable Wireless Router Radio” option, all the Wireless settings below will be disabled.
- **Enable SSID Broadcast:** When wireless clients survey the local area for wireless networks to associate with, they will detect the SSID broadcast by the Modem Router. If you select the **Enable SSID Broadcast** checkbox, the Wireless Router will broadcast its name (SSID) on the air.
- **Enable WDS:** Check this box to enable WDS. With this function, the Modem Router can bridge two or more Wlans. If this checkbox is selected, you will have to set the following parameters as shown in the figure below. Make sure the following settings are correct.

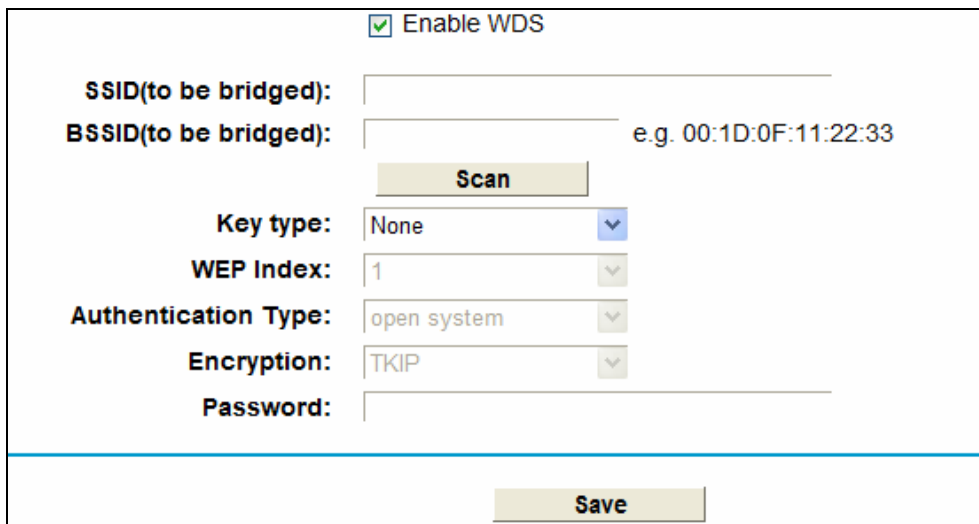

Enable WDS

SSID(to be bridged):

BSSID(to be bridged): e.g. 00:1D:0F:11:22:33

Key type:

WEP Index:

Authentication Type:

Encryption:

Password:

- **SSID (to be bridged):** The SSID of the AP your Modem Router is going to connect to as a client. You can also use the search function to select the SSID to join.
- **BSSID (to be bridged):** The BSSID of the AP your Modem Router is going to connect to as a client. You can also use the search function to select the BSSID to join.
- **Scan:** Click this button, you can search the AP which runs in the current channel.

- **Key type:** This option should be chosen according to the AP's security configuration. It is recommended that the security type is the same as your AP's security type
- **WEP Index:** This option should be chosen if the key type is WEP(ASCII) or WEP(HEX). It indicates the index of the WEP key.
- **Auth Type:** This option should be chosen if the key type is WEP(ASCII) or WEP(HEX). It indicates the authorization type of the Root AP.
- **Password:** If the AP your Modem Router is going to connect needs password, you need to fill the password in this blank.

Click **Save** to save your settings.

4.7.2 WPS Settings

This section will guide you to add a new wireless device to an existing network quickly by **WPS** (also called **QSS**) function.

- a). Choose menu "**WPS Settings**", and you will see the next screen (shown in Figure 4-24).

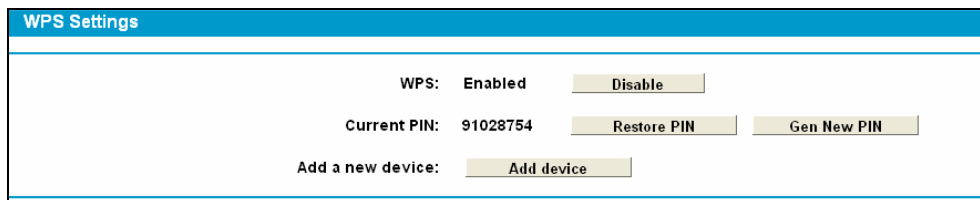

Figure 4-24

- **WPS:** Enable or disable the WPS function here.
- **Current PIN:** The current value of the Modem Router's PIN is displayed here. The default PIN of the Modem Router can be found in the label or User Guide.
- **Restore PIN:** Restore the PIN of the Modem Router to its default.
- **Gen New PIN:** Click this button, and then you can get a new random value for the Modem Router's PIN. You can ensure the network security by generating a new PIN.
- **Add device:** You can add a new device to the existing network manually by clicking this button.

- b). To add a new device:

If the wireless adapter supports Wi-Fi Protected Setup (WPS), you can establish a wireless connection between wireless adapter and Modem Router using either Push Button Configuration (PBC) method or PIN method.

Note:

To build a successful connection by WPS, you should also do the corresponding configuration of the new device for WPS function meanwhile.

I. Use the Wi-Fi Protected Setup Button

Use this method if your client device has a Wi-Fi Protected Setup button.

Step 1: Press the WPS button on the back panel of the Modem Router, as shown in the following figure.

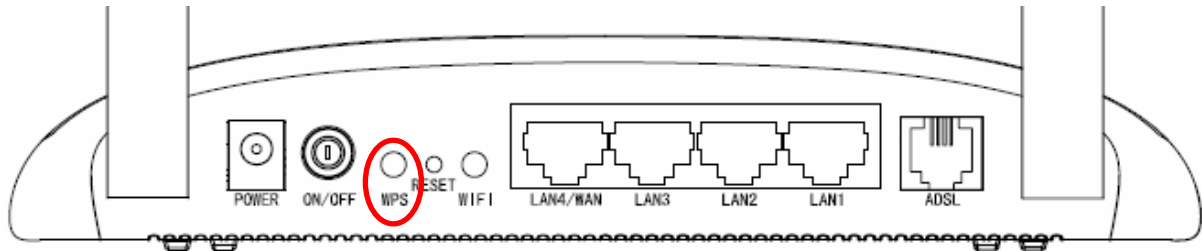

You can also keep the default WPS Status as **Enabled** and click the **Add device** button in Figure 4-24, then Choose “**Press the button of the new device in two minutes**” and click **Connect**. (Shown in the following figure)

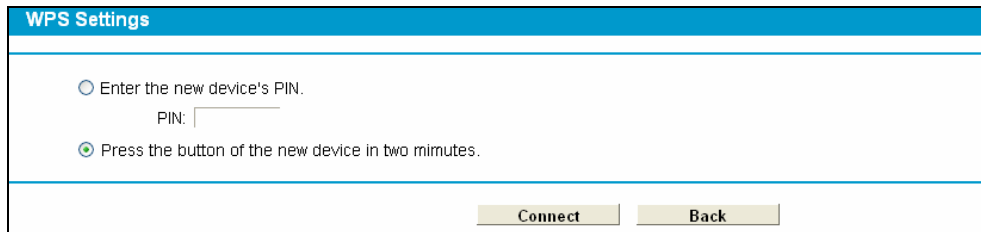

Figure 4-25

Step 2: Press and hold the WPS button of the client device directly.

Step 3: The Wi-Fi Protected Setup LED flashes for two minutes during the Wi-Fi Protected Setup process.

Step 4: When the WPS LED is on, the client device has successfully connected to the Modem Router

Refer back to your client device or its documentation for further instructions.

II. Enter the client device’s PIN on the Modem Router

Use this method if your client device has a Wi-Fi Protected Setup PIN number.

Step 1: Keep the default WPS Status as **Enabled** and click the **Add device** button in Figure 4-24, then the following screen will appear.

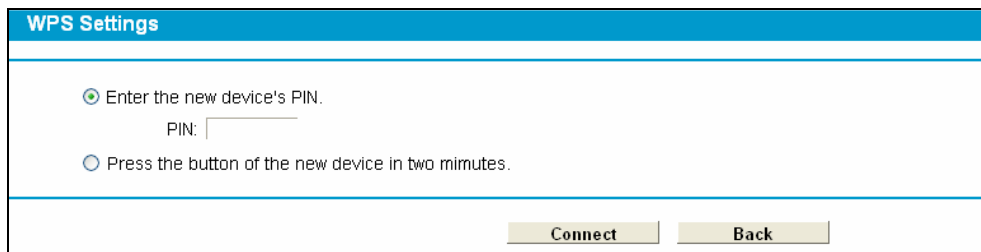

Figure 4-26

Step 2: Enter the PIN number from the client device in the field on the above WPS screen. Then click **Connect** button.

Step 3: “**Connect successfully**” will appear on the screen of Figure 4-26, which means the client device has successfully connected to the Modem Router.

III. Enter the Modem Router’s PIN on your client device

Use this method if your client device asks for the Modem Router’s PIN number.

Step 1: On the client device, enter the PIN number listed on the Modem Router’s Wi-Fi Protected Setup screen. (It is also labeled on the bottom of the Modem Router.)

Step 2: The Wi-Fi Protected Setup LED flashes for two minutes during the Wi-Fi Protected Setup process.

Step 3: When the WPS LED is on, the client device has successfully connected to the Modem Router.

Step 4: Refer back to your client device or its documentation for further instructions.

Note:

- 1) The WPS LED on the Modem Router will light green for five minutes if the device has been successfully added to the network.
- 2) The WPS function cannot be configured if the Wireless Function of the Modem Router is disabled. Please make sure the Wireless Function is enabled before configuring the WPS.

4.7.3 Wireless Security

Choose menu “**Wireless**”→” **Wireless Security**”, you can configure the security settings of your wireless network.

There are three wireless security modes supported by the Modem Router: WEP (Wired Equivalent Privacy), WPA-PSK (Pre-Shared Key), WPA2-PSK (Pre-Shared Key).

Figure 4-27

- **Disable Wireless Security:** If you do not want to use wireless security, check this radio button. But it’s strongly recommended to choose one of the following modes to enable security.
- **WEP:** It is based on the IEEE 802.11 standard. If you check this radio button, you will find a notice in red as show in Figure 4-27.

Figure 4-28

- **Auth Type** - you can choose the type for the WEP security on the drop-down list. The default setting is **Automatic**, which can select **Shared Key** or **Open System** authentication type automatically based on the wireless station's capability and request.
- **WEP Key Format** - **Hexadecimal** and **ASCII** formats are provided here. **Hexadecimal** format stands for any combination of hexadecimal digits (0-9, a-f, A-F) in the specified length. **ASCII** format stands for any combination of keyboard characters in the specified length.
- **WEP Key** - Select which of the four keys will be used and enter the matching WEP key that you create. Make sure these values are identical on all wireless stations in your network.
- **Key Type** - You can select the WEP key length (64-bit, or 128-bit, or 152-bit.) for encryption. "Disabled" means this WEP key entry is invalid.

64-bit - You can enter 10 hexadecimal digits (any combination of 0-9, a-f, A-F, zero key is not promoted) or 5 ASCII characters.

128-bit - You can enter 26 hexadecimal digits (any combination of 0-9, a-f, A-F, zero key is not promoted) or 13 ASCII characters.

152-bit - You can enter 32 hexadecimal digits (any combination of 0-9, a-f, A-F, zero key is not promoted) or 16 ASCII characters.

 **Note:**

If you do not set the key, the wireless security function is still disabled even if you have selected Shared Key as Authentication Type.

- **WPA-PSK /WPA2-PSK:** It's based on Radius Server.
 - **Auth type** - you can choose the version of the WPA security on the drop-down list. The default setting is **Auto**, which can select **WPA** (Wi-Fi Protected Access) or **WPA2** (WPA version 2) automatically based on the wireless station's capability and request.
 - **Encryption** - You can select either **Auto**, or **TKIP** or **AES**.
 - **PSK Password** - You can enter ASCII characters between 8 and 63 characters or 8 to 64 Hexadecimal characters.
 - **Group Key Update Period** - Specify the group key update interval in seconds. The value should be 30 or above. Enter 0 to disable the update.

Be sure to click the **Save** button to save your settings on this page.

4.7.4 Wireless MAC Filtering

Choose menu “**Wireless**” → “**MAC Filtering**”, you can control the wireless access by configuring the **Wireless MAC Filtering** function, shown in Figure 4-29.

Figure 4-29

To filter wireless users by MAC Address, click **Enable**. The default setting is **Disabled**.

- **MAC Address:** The wireless station's MAC address that you want to filter.
- **Status:** The status of this entry, either **Enabled** or **Disabled**.
- **Description:** A simple description of the wireless station.

To Add a Wireless MAC Address filtering entry, click the **Add New** button. The following page will appear, shown in Figure 4-30:

Figure 4-30

To add or modify a MAC Address Filtering entry, follow these instructions:

1. Enter the appropriate MAC Address into the **MAC Address** field. The format of the MAC Address is XX:XX:XX:XX:XX:XX (X is any hexadecimal digit). For example: 00:1D:0F:11:22:33.
2. Give a simple description for the wireless station in the **Description** field. For example: Wireless station A.
3. Select **Enabled** or **Disabled** for this entry on the **Status** drop-down list.
4. Click the **Save** button to save this entry.

To edit or delete an existing entry:

1. Click the **Edit** in the entry you want to modify.
2. Modify the information.
3. Click the **Save** button.

Click the **Enable/ Disabled Selected** button to make selected entries enabled or disabled.

Click the **Delete Selected** button to selected entries.

For example: If you desire that the wireless station A with MAC address 00:1D:0F:11:22:33 and the wireless station B with MAC address 00:0A:EB:00:07:5F are able to access the Modem Router, but all the other wireless stations cannot access the Modem Router, you can configure the **Wireless MAC Address Filtering** list by following these steps:

1. Click the **Enable** button to enable this function.
2. Select the radio button “**Allow the stations specified by any enabled entries in the list to access**” for **Filtering Rules**.
3. Delete all or disable all entries if there are any entries already.
4. Click the **Add New** button.
 - 1) Enter the MAC address 00:1D:0F:11:22:33/00:0A:EB:00:07:5F in the **MAC Address** field.
 - 2) Enter wireless station A/B in the **Description** field.
 - 3) Select **Enabled** in the **Status** drop-down list.
 - 4) Click the **Save** button.
 - 5) Click the **Back** button.

The filtering rules that configured should be similar to the following list:

Filtering Rules

Deny the stations specified by any enabled entries in the list to access.

Allow the stations specified by any enabled entries in the list to access.

<input type="checkbox"/>	MAC Address	Status	Description	Edit
<input type="checkbox"/>	00:1D:0F:11:22:33	Enabled	Wireless station A	Edit
<input type="checkbox"/>	00:0A:EB:00:07:5F	Enabled	Wireless station B	Edit

4.7.5 Wireless Advanced

Choose menu “**Wireless**”→”**Wireless Advanced**”, you can configure the advanced settings of your wireless network.

Wireless Lan Advanced Setting

Transmit Power: 100%

Beacon Interval: 100 (25-1000)

RTS Threshold: 2346 (1-2346)

Fragmentation Threshold: 2346 (256-2346)

DTIM Interval: 1 (1-255)

Enable Short GI

Enable Client isolation

Enable WMM

Figure 4-31

- **Transmit Power:** Here you can specify the transmit power of Modem Router. You can select High, Middle or Low which you would like. High is the default setting and is recommended.
- **Beacon Interval:** Enter a value between 25-1000 milliseconds for Beacon Interval here. The

beacons are the packets sent by the Modem Router to synchronize a wireless network. Beacon Interval value determines the time interval of the beacons. The default value is 100.

- **RTS Threshold:** Here you can specify the RTS (Request to Send) Threshold. If the packet is larger than the specified RTS Threshold size, the Modem Router will send RTS frames to a particular receiving station and negotiate the sending of a data frame. The default value is 2346.
- **Fragmentation Threshold:** This value is the maximum size determining whether packets will be fragmented. Setting the Fragmentation Threshold too low may result in poor network performance because of excessive packets. 2346 is the default setting and is recommended.
- **DTIM Interval:** This value determines the interval of the Delivery Traffic Indication Message (DTIM). A DTIM field is a countdown field informing clients of the next window for listening to broadcast and multicast messages. When the Modem Router has buffered broadcast or multicast messages for associated clients, it sends the next DTIM with a DTIM Interval value. You can specify the value between 1-255 Beacon Intervals. The default value is 1, which indicates the DTIM Interval is the same as Beacon Interval.
- **Enable Short GI:** This function is recommended for it will increase the data capacity by reducing the guard interval time.
- **Enabled Client isolation:** This function can isolate wireless stations on your network from each other. Wireless devices will be able to communicate with the Modem Router but not with each other. To use this function, check this box. Client isolation is disabled by default.
- **Enable WMM:** WMM function can guarantee the packets with high-priority messages being transmitted preferentially. It is strongly recommended.

 **Note:**

If you are not familiar with the setting items in this page, it's strongly recommended to keep the provided default values; otherwise it may result in lower wireless network performance.

4.7.6 Wireless Status

Choose menu “**Wireless**”→“**Wireless Status**”, you can see the MAC Address, Current Status, Received Packets and Sent Packets for each connected wireless station.

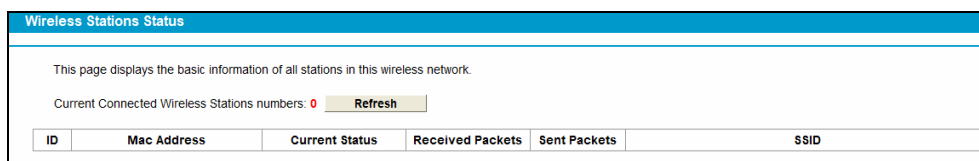

ID	Mac Address	Current Status	Received Packets	Sent Packets	SSID
This page displays the basic information of all stations in this wireless network.					
Current Connected Wireless Stations numbers: 0 <input type="button" value="Refresh"/>					

Figure 4-32

- **MAC Address:** The connected wireless station's MAC address
- **Current Status:** The connected wireless station's running status, one of **STA-AUTH/ STA-ASSOC/ STA-JOINED/ WPA/ WPA-PSK/ WPA2/ WPA2-PSK/ AP-UP/ AP-DOWN/ Disconnected**
- **Received Packets:** Packets received by the station
- **Sent Packets:** Packets sent by the station

You cannot change any of the values on this page. To update this page and to show the current connected wireless stations, click on the **Refresh** button.

4.8 Route Settings

Choose “**Route Settings**”, it includes three menus: **Default Gateway**, **Static Route** and **RIP Settings**. The detailed descriptions are provided below.

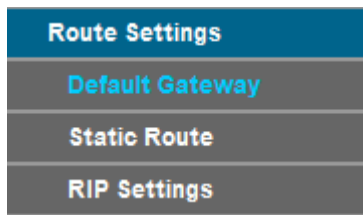

4.8.1 Default Gateway

Choose “**Route Settings**”→“**Default Gateway**”, you can see the Default Gateway screen. You can select a WAN Interface from the drop-down list as the system default gateway.

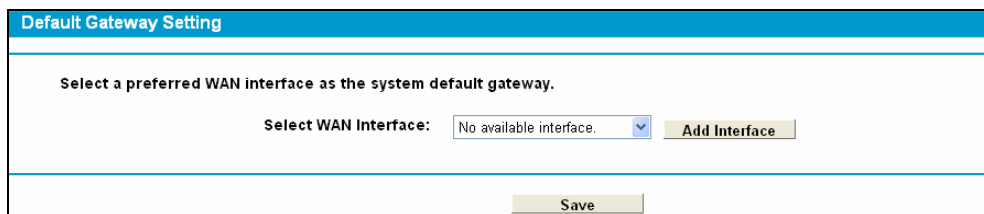

Figure 4-33

Click the **Add Interface** button, you can add WAN Interfaces.

Click the **Save** button to save your settings.

4.8.2 Static Route

Choose “**Route Settings**”→ “**Static Route**”. You can see the Static Route screen, this screen allows you to configure the static routes (shown in Figure 4-34). A static route is a pre-determined path that network information must travel to reach a specific host or network.

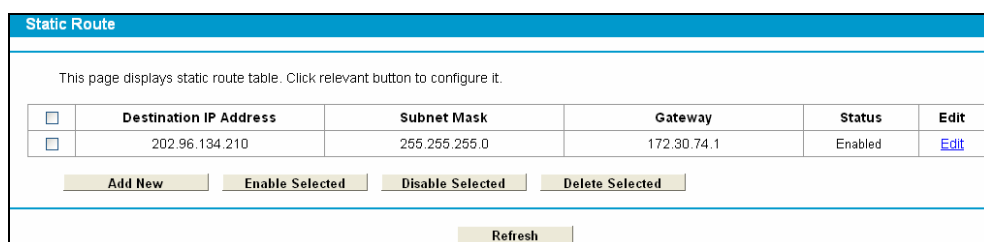

Figure 4-34

To add static routing entries:

1. Click the **Add New** button in Figure 4-34, and you will see the screen as shown in Figure 4-35.

Figure 4-35

2. Enter the following data:
 - **Destination IP Address:** The **Destination IP Address** is the address of the network or host that you want to assign to a static route.
 - **Subnet Mask:** The **Subnet Mask** determines which portion of an IP Address is the network portion, and which portion is the host portion.
 - **Gateway:** Here you should type the Gateway address correctly, and the option for **Interface** will adopt the default Gateway address for the Static Route.
 - **Interface:** Select the Interface name in the text box, or else, the default Use Interface will be adopted for the Static Route.
 - **Status:** Select **Enabled** or **disabled** from the drop-down list.
3. Click **Save** to save your settings as shown in Figure 4-35.

To modify or delete an existing entry:

1. Find the desired entry in the table.
2. Click **Edit** as desired on the **Edit** column.

Click the **Enable/ Disabled Selected** button to make selected entries enabled/ disabled.

Click the **Delete Selected** button to delete selected entries.

4.8.3 RIP Settings

Choose “**Route Settings**”→“**RIP Settings**”, you can see the RIP (Routing Information Protocol) screen which allows you to configure the RIP.

Figure 4-36

Note:

RIP cannot be configured on the WAN Interface which has NAT enabled (such as PPPoE).

4.9 Forwarding

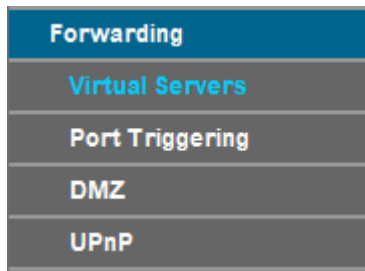

There are four submenus under the Forwarding menu: **Virtual Servers**, **Port Triggering**, **DMZ** and **UPnP**. Click any of them, and you will be able to configure the corresponding function.

4.9.1 Virtual Servers

Choose menu “**Forwarding**” → “**Virtual Servers**”, and then you can view and add virtual servers in the next screen (shown in Figure 4-37). Virtual servers can be used for setting up public services on your LAN. A virtual server is defined as a service port, and all requests from Internet to this service port will be redirected to the computer specified by the server IP. Any PC that was used for a virtual server must have a static or reserved IP address because its IP address may change when using the DHCP function.

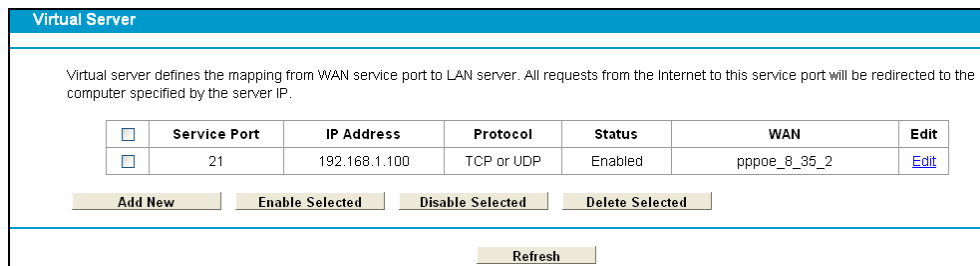

Figure 4-37

- **Service Port:** The numbers of External Service Ports. You can enter a service port or a range of service ports (the format is XXX – YYY; XXX is the Start port and YYY is the End port).
- **IP Address:** The IP address of the PC running the service application.
- **Protocol:** The protocol used for this application, either **TCP**, **UDP**, or **All** (all protocols supported by the Modem Router).
- **Status:** The status of this entry, "Enabled" means the virtual server entry is enabled.
- **Edit:** To modify or delete an existing entry.

To setup a virtual server entry:

1. Click the **Add New** button. (pop-up Figure 4-38)
2. Select the service you want to use from the **Common Service Port** list. If the **Common Service Port** menu does not list the service that you want to use, enter the number of the service port or service port range in the **Service Port** field.
3. Select the service you want to use from the **Use Interface** list.
4. Enter the IP address of the computer running the service application in the **IP Address** field.
5. Select the protocol used for this application in the **Protocol** drop-down list, either **TCP**, **UDP**,

or **All**.

6. Select the **Enabled** option in the **Status** drop-down list.

Click the **Save** button.

Figure 4-38

Note:

It is possible that you have a computer or server that has more than one type of available service. If so, select another service, and type the same IP address for that computer or server.

To modify or delete an existing entry:

1. Find the desired entry in the table.
2. Click **Edit** as desired on the **Edit** column.

Click the **Enable/ Disabled Selected** button to make selected entries enabled/ disabled.

Click the **Delete Selected** button to delete selected entries.

Note:

If you set the service port of the virtual server as 80, you must set the Web management port on **System Tools → Remote Management** page to be any other value except 80 such as 8080. Otherwise there will be a conflict to disable the virtual server.

4.9.2 Port Triggering

Choose menu **“Forwarding”→ “Port Triggering”**, you can view and add port triggering in the next screen (shown in Figure 4-39). Some applications require multiple connections, like Internet games, video conferencing, Internet telephoning and so on. Port Triggering is used for some of these applications that cannot work with a pure NAT Modem Router.

	Trigger Port	Trigger Protocol	Open Port	Open Protocol	Status	Edit
<input type="checkbox"/>	6112	TCP or UDP	6112	TCP or UDP	Enable	Edit

Figure 4-39

To add a new rule, follow the steps below.

1. Click the **Add New** button, the next screen will pop-up as shown in Figure 4-40.
2. Select a common application from the **Common Service Port** drop-down list, then the **Trigger Port** field and the **Open Ports** field will be automatically filled. If the **Common Service Port** do not have the application you need, enter the **Trigger Port** and the **Open Ports** manually.
3. Select the protocol used for Trigger Port from the **Trigger Protocol** drop-down list, either **TCP**, **UDP**, or **All**.
4. Select the protocol used for Incoming Ports from the **Incoming Protocol** drop-down list, either **TCP** or **UDP**, or **All**.
5. Select **Enable** in **Status** field.
6. Click the **Save** button to save the new rule.

Figure 4-40

- **Trigger Port:** The port for outgoing traffic. An outgoing connection using this port will trigger this rule.
- **Trigger Protocol:** The protocol used for Trigger Ports, either **TCP**, **UDP**, or **All** (all protocols supported by the Modem Router).
- **Open Port:** The port or port range used by the remote system when it responds to the outgoing request. A response using one of these ports will be forwarded to the PC which triggered this rule. You can input at most 5 groups of ports (or port sections). Every group of ports must be separated with ",", for example, 2000-2038, 2046, 2050-2051, 2085, 3010-3030.
- **Open Protocol:** The protocol used for **Incoming Port**, either **TCP**, **UDP**, or **ALL** (all protocols supported by the Modem Router).
- **Status:** The status of this entry, Enabled means the Port Triggering entry is enabled.
- **Modify:** To modify or delete an existing entry.
- **Common Service Port:** Some popular applications already listed in the drop-down list of **Open Protocol**.

To modify or delete an existing entry:

1. Find the desired entry in the table.
2. Click **Edit** as desired on the **Edit** column.

Click the **Enable/ Disabled Selected** button to make selected entries enabled/ disabled.

Click the **Delete Selected** button to delete selected entries.

Once the Modem Router is configured, the operation is as follows:

1. A local host makes an outgoing connection to an external host using a destination port number defined in the **Trigger Port** field.
2. The Modem Router records this connection, opens the incoming port or ports associated with this entry in the **Port Triggering** table, and associates them with the local host.
3. When necessary, the external host will be able to connect to the local host using one of the ports defined in the **Incoming Ports** field.

 **Note:**

1. When the trigger connection is released, the corresponding opened ports will be closed.
2. Each rule can only be used by one host on the LAN at a time. The trigger connection of other hosts on the LAN will be refused.
3. **Open Ports** ranges cannot overlap each other.

4.9.3 DMZ

Choose menu “**Forwarding**→**DMZ**”, and then you can view and configure DMZ host in the screen (shown in Figure 4-41).The DMZ host feature allows one local host to be exposed to the Internet for a special-purpose service such as Internet gaming or videoconferencing. The Modem Router forwards packets of all services to the DMZ host. Any PC whose port is being forwarded must have its DHCP client function disabled and should have a new static IP Address assigned to it because its IP Address may be changed when using the DHCP function.

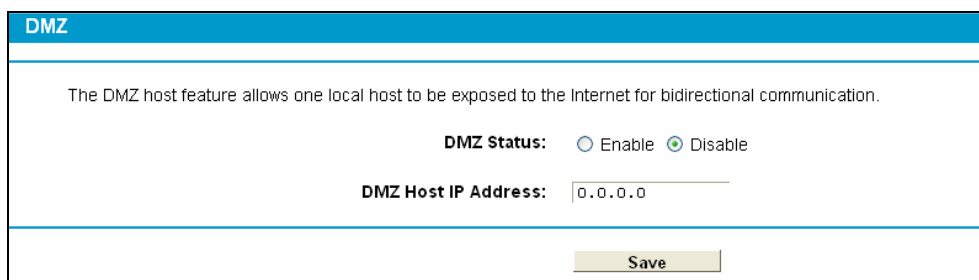

DMZ

The DMZ host feature allows one local host to be exposed to the Internet for bidirectional communication.

DMZ Status: Enable Disable

DMZ Host IP Address:

Save

Figure 4-41

To assign a computer or server to be a DMZ server:

1. Click the **Enable** button.
2. Enter the IP address of a local PC that is set to be DMZ host in the **DMZ Host IP Address** field.
3. Click the **Save** button.

4.9.4 UPnP

Choose menu “**Forwarding**→**UPnP**”, and then you can view the information about **UPnP** in the screen (shown in Figure 4-42). The **Universal Plug and Play (UPnP)** feature allows the devices, such as Internet computers, to access the local host resources or devices as needed. UPnP devices can be automatically discovered by the UPnP service application on the LAN.

The screenshot shows the 'UPnP config' page. At the top, it says 'This page displays UPnP status and settings.' Below that, the 'Current UPnP Status' is 'Disabled', with 'Enable' and 'Disable' buttons. Underneath is the 'Current UPnP Settings List' table, which is currently empty. At the bottom, there is a 'Refresh' button.

ID	App Description	External Port	Protocol	Internal Port	IP Address	Status
----	-----------------	---------------	----------	---------------	------------	--------

Figure 4-42

- **Current UPnP Status:** UPnP can be enabled or disabled by clicking the **Enable** or **Disable** button. This feature is enabled by default.
- **Current UPnP Settings List:** This table displays the current UPnP information.
 - **App Description:** The description about the application which initiates the UPnP request.
 - **External Port:** The port which the Modem Router opened for the application.
 - **Protocol:** The type of protocol which is opened.
 - **Internal Port:** The port which the Modem Router opened for local host.
 - **IP Address:** The IP address of the local host which initiates the UPnP request.
 - **Status:** Either Enabled or Disabled. "Enabled" means that the port is still active; otherwise, the port is inactive.

Click the **Enable** button to enable UPnP.

Click the **Disable** button to disable UPnP.

Click the **Refresh** button to update the Current UPnP Settings List.

4.10 Parent Control

Choose menu "**Parent Control**", and you can configure the parental control in the screen as shown in Figure 4-43. The Parental Control function can be used to control the internet activities of the child, limit the child to access certain websites and restrict the time of surfing.

Parent Control

Parental Control function can be used to control the Internet activities of the child, limit the child to access specified websites in specified time.

Enable Parental Control

MAC Address Of Parental PC:

MAC Address of Current PC: [Copy to Above](#)

MAC Address - 1:

MAC Address - 2:

MAC Address - 3:

MAC Address - 4:

MAC Address in current LAN:

Apply To:

Start Time:

End Time:

Time	0:00	1:00	2:00	3:00	4:00	5:00	6:00	7:00	8:00	9:00	10:00	11:00	12:00	13:00	14:00
Sun.															
Mon.															
Tues.															
Wed.															
Thur.															
Fri.															
Sat.															

Add URL:

(It will not take effect until you save it.)

Figure 4-43

- **Enable Parental Control:** Check the box if you want this function to take effect. This function is disabled by default.
 - **MAC Address of Parental PC:** In this field, enter the MAC address of the controlling PC, or you can make use of the **Copy To Above** button below.
 - **MAC Address of Current PC:** This field displays the MAC address of the PC that is managing this Modem Router. If the MAC Address of your adapter is registered, you can click the Copy To Above button to fill this address to the MAC Address of Parental PC field above.
 - **Add URL:** Here you can input the net addresses which the child is allowed to access.
- Click the **Save** button to save your settings.

4.11 Firewall

Firewall
Rule
LAN Host
WAN Host
Schedule
DDoS

There are four submenus under the Firewall menu: **Rule**, **LAN Host**, **WAN Host**, **Schedule** and **DDoS**. Click any of them, and you will be able to configure the corresponding function.

4.11.1 Rule

Choose menu “**Firewall**” → “**Rule**”, and then you can view and set Access Control rules in the screen as shown in Figure 4-44.

The router can restrict the internet behavior of lan host. You can enable or disable this function on this page, and set default rules. Furthermore, you can set flexible combination rules by selecting proper "Lan Host", "Wan Host" and "Schedule" to construct the integrated and powerful internet control rules.

Enable Firewall

Default Filtering Rules:

- Allow** the packets not specified by any filtering rules to pass through the device
- Deny** the packets not specified by any filtering rules to pass through the device

Note: The modem router will first try to match the packet with the enabled filtering rules one by one in the list and apply the first matching rule. If the packet is not specified by any filtering rules in the list, then the Default Filtering Rule will take effect.

<input type="checkbox"/>	Description	Lan Host	Target	Schedule	Pass	Status	Edit
<input type="button" value="Add New"/> <input type="button" value="Enable Selected"/> <input type="button" value="Disable Selected"/> <input type="button" value="Delete Selected"/>							

Figure 4-44

- **Enable Firewall:** Select the check box to enable the Firewall function, so the Default Filtering Rules can take effect.
- **Description:** Here displays the description of the rule and this name is unique.
- **LAN Host:** Here displays the host selected in the corresponding rule.
- **Target:** Here displays the target selected in the corresponding rule.
- **Schedule:** Here displays the schedule selected in the corresponding rule.
- **Status:** Here displays the status of the rule, enabled or not.
- **Edit:** Here you can edit or delete an existing rule.
- **Add New:** Click the **Add New** button to add a new rule entry.
- **Enable Selected:** Click the **Enable Selected** button to enable the selected rules in the list.
- **Disable Selected:** Click the **Disable Selected** button to disable the selected rules in the list.
- **Delete Selected:** Click the **Delete Selected** button to delete the selected entries in the table.

The methods to add a new rule:

1. Click the **Add New** button and the next screen will pop up as shown in Figure 4-45.
2. Give a name (e.g. Rule_1) for the rule in the **Description** field.
3. Select a host from the **LAN Host** drop-down list or choose “**Add LAN Host**”.
4. Select a target from the **WAN Host** drop-down list or choose “**Add WAN Host**”.
5. Select a schedule from the **Schedule** drop-down list or choose “**Add Schedule**”.
6. In the **Action** field, select **Deny** or **Allow** to deny or allow your entry.
7. In the **Status** field, select **Enabled** or **Disabled** to enable or disable your entry.
8. In the **Direction** field, select **IN** or **OUT** from the drop-down list for the direction.
9. In the **Protocol** field, here are four options, All, TCP, UDP, and ICMP. Select one of them from the drop-down list for the target.

10. Click the **Save** button.

Figure 4-45

4.11.2 LAN Host

Choose menu “**Firewall**” → “**LAN Host**”, and then you can view and set a Host list in the screen as shown in Figure 4-46.

	Description	Address Info	Edit
<input type="checkbox"/>	Host_1	192.168.1.88	Edit

Figure 4-46

- **Description:** Here displays the description of the host and this description is unique.
- **Address Info:** Here displays the information about the host. It can be IP or MAC.
- **Edit:** To modify an existing entry.

To add a new entry, please follow the steps below.

1. Click the **Add New** button.
2. In the **Mode** field, select IP Address or MAC Address.
 - If you select IP Address, please follow the steps below:
 - 1) In **Description** field, create a unique description for the host (e.g. Host_1).
 - 2) In **IP Address** field, enter the IP address.
 - If you select MAC Address, please follow the steps below:
 - 1) In **Description** field, create a unique description for the host (e.g. Host_1).
 - 2) In **MAC Address** field, enter the MAC address.
3. Click the **Save** button to complete the settings.

Click the **Delete Selected** button to delete the selected entries in the table.

4.11.3 WAN Host

Choose menu “**Firewall**” → “**WAN Host**”, and then you can view and set a Host list in the screen as shown in Figure 4-47.

WAN HOST			
<input type="checkbox"/>	Description	Details	Edit
<input type="checkbox"/>	Host_1	202.114.71.2	Edit

Buttons: Add New, Delete Selected

Figure 4-47

- **Description:** Here displays the description about the WAN and this description is unique.
- **Details:** The details can be IP address, port, or domain name.
- **Edit:** To modify an existing entry.

To add a new entry, please follow the steps below.

1. Click the **Add New** button.
2. In Mode field, select **IP Address**, **MAC Address** or **URL Address**.

If you select **IP Address**, the screen shown is Figure 4-48.

Mode: IP Address

Description: _____

IP Address: _____ - _____

Port: _____ - _____

Buttons: Save, Back

Figure 4-48

- 1) In **Description** field, create a unique description for the host (e.g. Host_1).
- 2) In **IP Address** field, enter the IP address.

If you select **MAC Address**, the screen shown is Figure 4-49.

Mode: MAC Address

Description: _____

MAC Address: _____

Buttons: Save, Back

Figure 4-49

- 1) In **Description** field, create a unique description for the host (e.g. Host_1).
- 2) In **MAC Address** field, enter the MAC address.

If you select **URL Address**, the screen shown is Figure 4-50.

Figure 4-50

- 1) In **Description** field, create a unique description for the host (e.g. Host_1).
- 2) Enter the URL address in the **Add URL Address** field, and then click the **Add** button. The URL address will be shown in the **Detail** table. If you click the **Delete** button, the existing URL address in the **Detail** table can be deleted.
3. Click the **Save** button to complete the settings.

4.11.4 Schedule

Choose menu “**Firewall**” → “**Schedule**”, and then you can view and set a Schedule list in the next screen as shown in Figure 4-51.

	Description	Edit
<input type="checkbox"/>		
<input type="checkbox"/>	Schedule_1	Edit

Figure 4-51

- **Description:** Here displays the description of the schedule and this description is unique.
- **Edit:** Here you can modify an existing schedule.

To add a new schedule, follow the steps below:

1. Click **Add New** button and the next screen will pop-up as shown in Figure 4-52.
2. In **Description** field, create a unique description for the schedule (e.g. Schedule_1).
3. In **Apply To** field, select the day or days you need.
4. In time field, you can select all day-24 hours or you may enter the **Start Time** and **Stop Time** in the corresponding field.
5. Click **Save** to complete the settings.

Click the **Clear Schedule** button to clear your settings in the table.

Schedule can be set on this page.

Description: _____

Apply To: Start Time: End Time:

Time	0:00	1:00	2:00	3:00	4:00	5:00	6:00	7:00	8:00	9:00	10:00	11:00	12:00	1:00	2:00
Sun.															
Mon.															
Tues.															
Wed.															
Thur.															
Fri.															
Sat.															

Figure 4-52

Click the **Delete Selected** button to delete the selected entries in the table.

4.11.5 DDoS

Choose menu **“Firewall”** → **“DDoS”**, and then you can view and set DDoS in the next screen as shown in Figure 4-53.

DDoS Parameters can be set on this page.

DoS Protection: Enable Disable
 (Note: DoS Protection will not take effect only when the Traffic Statistics is enabled.)

Enable ICMP-Flood Attack Filtering
ICMP-Flood Packets Threshold (5-3600): packets/second

Enable UDP-Flood Attack Filtering
UDP-Flood Packets Threshold (5-3600): packets/second

Enable TCP-SYN-Flood Attack Filtering
TCP-SYN-Flood Packets Threshold (5-3600): packets/second

Forbid ping packets from LAN port

Figure 4-53

- **DoS protection** - Denial of Service protection. Check the Enable or Disable button to enable or disable the DoS protection function. Only when it is enabled, will the flood filters be enabled.

Note:

Dos Protection will take effect only when the **Traffic Statistics** in **“System Tool → Traffic Statistics”** is enabled.

- **Enable ICMP-Flood Attack Filtering** - Enable or Disable the ICMP-Flood Attack Filtering.
- **ICMP-Flood Packets Threshold (5~3600)** - The default value is 50. Enter a value between 5 ~ 3600. When the current ICMP-Flood Packets number is beyond the set value, the Modem Router will startup the blocking function immediately.
- **Enable UDP-Flood Filtering** - Enable or Disable the UDP-Flood Filtering.
- **UDP-Flood Packets Threshold (5~3600)** - The default value is 500. Enter a value between 5 ~ 3600. When the current UPD-Flood Packets number is beyond the set value, the Modem Router will startup the blocking function immediately.
- **Enable TCP-SYN-Flood Attack Filtering** - Enable or Disable the TCP-SYN-Flood Attack Filtering.
- **TCP-SYN-Flood Packets Threshold (5~3600)** - The default value is 50. Enter a value between 5 ~ 3600. When the current TCP-SYN-Flood Packets numbers is beyond the set value, the Modem Router will startup the blocking function immediately.
- **Forbid ping packet from LAN port** - Enable or Disable Forbid ping packet from LAN port. The default setting is disabled. If enabled, the ping packet from LAN cannot access the Modem Router. This function can be used to defend against some viruses.

Click the **Save** button to save the settings.

Click the **Blocked DoS Host List** button to display the DoS host table by blocking.

4.12 Bandwidth Control

Choose menu “**Bandwidth Control**”, and then you can view and configure the corresponding function in the next screen as shown in Figure 4-54.

Figure 4-54

In this screen you can configure the Upstream Bandwidth and Downstream Bandwidth. The values you configure should be less than 100000Kbps. For optimal control of the bandwidth, please select the right Line Type and ask your ISP for the total bandwidth of the egress and ingress.

- **Enable Bandwidth Control:** Check this box so that the Bandwidth Control settings can take effect.
- **Line Type:** Select the right type for you network connection. If you don't know how to choose, please ask your ISP for the information.
- **Total Upstream Bandwidth** - The upload speed through the WAN port.

- **Total Downstream Bandwidth** - The download speed through the WAN port.

In this screen you can also configure the Bandwidth Control rules.

- **Description:** This is the information about the rules such as address range.
- **Upstream bandwidth:** This field displays the max and mix upload bandwidth through the WAN port, the default is 0.
- **Downstream bandwidth:** This field displays the max and mix download bandwidth through the WAN port, the default is 0.
- **Edit:** Click **Edit** to modify the rule.

To add/modify a Bandwidth Control rule, follow the steps below.

1. Click **Add New** shown in Figure 4-54, you will see a new screen shown in Figure 4-55.
2. Enter the information like the screen shown below.

Figure 4-55

3. Click the **Save** button.

4.13 IP&MAC Binding

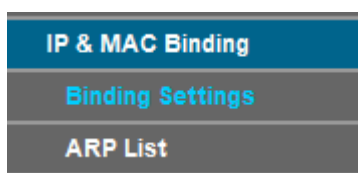

There are two submenus under the IP &MAC Binding menu: **Binding Settings** and **ARP List**. Click any of them, and you will be able to scan or configure the corresponding function. The detailed explanations for each submenu are provided below.

4.13.1 Binding Setting

This page displays the **IP & MAC Binding Setting** table; you can operate it in accord with your desire (shown in Figure 4-56).

This page displays the ARP List. Please click corresponding button to configure IP-MAC Binding entries.

ARP Binding Enable Disable

<input type="checkbox"/>	MAC Address	IP Address	Status	Edit
<input type="checkbox"/>	40:61:86:FC:74:29	192.168.1.100	Bound	Edit

Figure 4-56

- **MAC Address:** The MAC address of the controlled computer in the LAN.
- **IP Address:** The assigned IP address of the controlled computer in the LAN.
- **Bound:** Check this option to enable ARP binding for a specific device.
- **Edit:** To modify or delete an existing entry.

When you want to add or modify an IP & MAC Binding entry, you can click the **Add New** button or **Edit** button, and then you will go to the next page. This page is used for adding or modifying an IP & MAC Binding entry (shown in Figure 4-57).

This page allows you to set IP-MAC Binding entries.

MAC Address:

IP Address:

Bind

Figure 4-57

To add IP & MAC Binding entries, follow the steps below.

1. Click the **Add New** button as shown in Figure 4-56.
2. Enter the MAC Address and IP Address.
3. Select the Bind checkbox.
4. Click the **Save** button to save it.

To modify or delete an existing entry, follow the steps below.

1. Find the desired entry in the table.
2. Click **Edit** as desired on the **Edit** column.

Click the **Enable/ Disable Selected** button to make selected entries enabled or disabled.

Click the **Delete Selected** button to delete selected entries.

4.13.2 ARP List

To manage the computer, you could observe the computers in the LAN by checking the relationship of MAC address and IP address on the ARP list, and you could also configure the

items on the ARP list. This page displays the ARP List; it shows all the existing IP & MAC Binding entries (shown in Figure 4-58).

ARP List			
<input type="checkbox"/>	MAC Address	IP Address	Status
<input type="checkbox"/>	6c:62:6d:f7:32:09	192.168.1.100	UnLoaded
<input type="button" value="Load Selected"/>		<input type="button" value="Delete Selected"/>	
<input type="button" value="Refresh"/>			

Figure 4-58

- **MAC Address:** The MAC address of the controlled computer in the LAN.
- **IP Address:** The assigned IP address of the controlled computer in the LAN.
- **Status:** Indicates whether or not the MAC and IP addresses are bound.
- **Load:** Load the item to the IP & MAC Binding list.

Click the **Load Selected** button to load selected items to the IP & MAC Binding list.

Click the **Refresh** button to refresh all items.

4.14 Dynamic DNS

Choose menu “**Dynamic DNS**”, and you can configure the Dynamic DNS function.

The Modem Router offers the **DDNS** (Dynamic Domain Name System) feature, which allows the hosting of a website, FTP server, or e-mail server with a fixed domain name (named by yourself) and a dynamic IP address, and then your friends can connect to your server by entering your domain name no matter what your IP address is. Before using this feature, you need to sign up for DDNS service providers such as www.dyndns.com. The Dynamic DNS client service provider will give you a password or key.

DDNS Settings	
Parameters of DDNS 'Oray.net' can be set on this page.	
Service URL: Apply Help	
Service Provider:	www.oray.com <input type="button" value="Go to register..."/>
User Name:	<input type="text"/>
Password:	<input type="password"/>
Enable DDNS	<input type="checkbox"/>
Connection Status:	Disconnected
Service Type:	---
Domain Information:	None
<input type="button" value="Login"/>	<input type="button" value="Logout"/>
<input type="button" value="Save"/>	

Figure 4-59

- **Service Provider:** This field displays the service provider of DDNS.
- **Domain Name:** Enter the Domain name you received from dynamic DNS service provider.
- **Username & Password:** Type the “User Name” and “Password” for your DDNS account.
- **Enable DDNS:** Activate the DDNS function or not.
- **Login/ Logout:** Login to or logout of the DDNS service.

4.15 Diagnostic

Choose “**Diagnostic**”, you can view the test results for the connectivity of the physical layer and protocol layer for both LAN and WAN sides in the screen. Select the desired type and click the start button.

Diagnostics Tools

The router's internet connection status can be tested on this page. Please select the desired type and click the start button.

Diagnostics Type

- Test internet surfing
- Test internet surfing
- Test WAN interface connection

Figure 4-60

4.16 System Tools

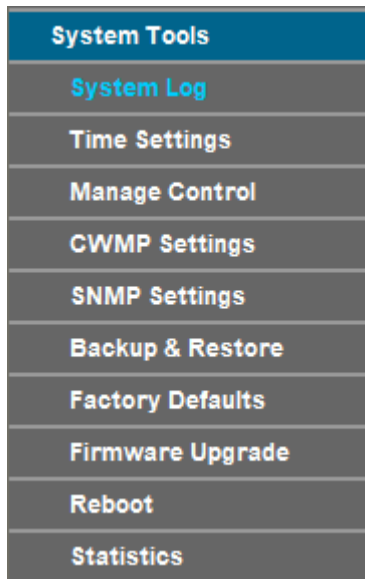

Choose menu “**System Tools**”, and you can see the submenus under the main menu: **System Log**, **Time Settings**, **Manage Control**, **CWMP Settings**, **SNMP Settings**, **Backup & Restore**, **Factory Defaults**, **Firmware Upgrade**, **Reboot** and **Statistics**. Click any of them, and you will be able to configure the corresponding function. The detailed explanations for each submenu are provided below.

4.16.1 System Log

Choose menu “**System Tools**” → “**System Log**”, and then you can view the logs of the Modem Router.

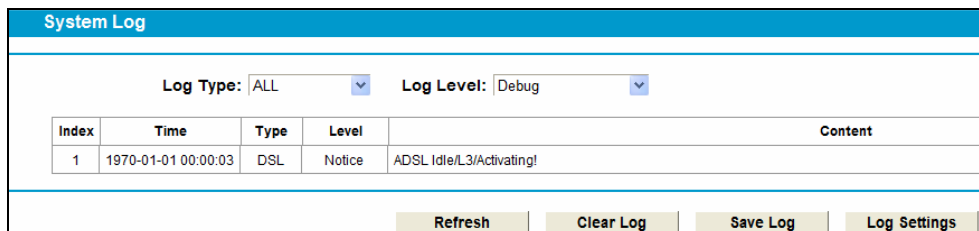

Figure 4-61

- **Log Type:** By selecting the log type, only logs of this type will be shown.
- **Log Level:** By selecting the log level, only logs of this level will be shown.
- **Refresh:** Refresh the page to show the latest log list.
- **Clear Log:** All the logs will be deleted from the Modem Router permanently, not just from the page.
- **Save Log:** Click to save all the logs in a txt file.
- **Log Settings:** Click to set the logs in the screen (shown in Figure 4-62).

Figure 4-62

- **Save Locally:** If **Save Locally** is selected, events will be recorded in the local memory.
- **Minimum Level:** Select the Minimum level in the drop-down list, for the Minimum Level, all logged events above or equal to the selected level will be displayed.
- **Save Remotely:** If **Save Remotely** is selected, events will be sent to the specified IP address and UDP port of the remote system log server.

Click the **Save** button to save your settings.

4.16.2 Time Settings

Choose menu “**System Tools**” → “**Time Settings**”, and then you can configure the time on the following screen.

Figure 4-63

- **Time Zone:** Select your local time zone from this pull down list.
- **Date:** Enter your local date in MM/DD/YY into the right blanks.
- **Time:** Enter your local time in HH/MM/SS into the right blanks.
- **NTP Server 1 / NTP Server 2:** Enter the address or domain of the **NTP Server 1** or **NTP Server 2**, and then the Modem Router will get the time from the NTP Server preferentially. In addition, the Modem Router built-in some common NTP Servers, so it can get time automatically once it connects the Internet.

To set time manually:

1. Select your local time zone.
2. Enter the **Date** in Year/Month/Day format.
3. Enter the **Time** in Hour/Minute/Second format.
4. Click **Save**.

To set time automatically:

1. Select your local time zone.
2. Enter the address or domain of the **NTP Server 1** or **NTP Server 2**.
3. Click the **Get GMT** button to get system time from Internet if you have connected to the Internet.

4.16.3 Manage Control

Choose “**System Tools**” → “**Manage Control**”, you can see the screen (shown in Figure 4-62)

Manage Control		
Current User Status		
User Type:	Admin	
User Name:	admin	
Host IP Address:	192.168.1.100	
Host MAC Address:	6C:62:6D:F7:32:09	
Account Management		
Old Password:	<input type="text"/>	
New User Name:	<input type="text"/>	
New Password:	<input type="text"/>	
Confirm Password:	<input type="text"/>	
Service Configuration		
	HTTP Service	Host(IP/MAC)
Local Management	Port <input type="text" value="80"/>	<input type="text"/>
Remote Management	Enable <input type="checkbox"/> Port <input type="text" value="80"/>	<input type="text"/>
<input type="button" value="Save"/>		

Figure 4-64

- **Current User Status:** This box displays the information about **User Type**, **User Name**, **Host IP Address** and **Host MAC Address**.
- **Account Management:** Here you can set the account user information about **Old Password**, **New User Name**, **New Password** and **Confirm Password**.
- **Service Configuration:** Here you can modify the port of the Modem Router’s web management interface and limit the hosts which can login this Modem Router’s web management interface.

4.16.4 CWMP Settings

Choose “**System Tools**” → “**CWMP Settings**”, you can configure the CWMP function in the screen.

The Modem Router offers CWMP feature. The function supports TR-069 protocol which collects information, diagnoses the devices and configures the devices automatically via ACS (Auto-Configuration Server).

Figure 4-65

- **CWMP:** Select enable the CWMP function.
- **Inform:** Enable or disable the function. If enabled, the information will be informed to ACS server periodically.
- **Inform Interval:** Enter the interval time here.
- **ACS URL:** Enter the website of ACS which is provided by your ISP.
- **ACS User Name/Password:** Enter the User Name and password to login the ACS server.
- **Interface used by TR-069 client:** Select the interface used by TR-069 client.
- **Display SOAP messages on serial console:** Enable or disable this function.
- **Connection Request User Name/Password:** Enter the User Name and Password that provided the ACS server to login the Modem Router.
- **Connection Request Path:** Enter the path that connects to the ACS server.
- **Connection Request Port:** Enter the port that connects to the ACS server.
- **Connection Request URL:** Enter the URL that connects to the ACS server.

4.16.5 SNMP Settings

Choose “**Management**”→“**SNMP Agent**”, you can see the SNMP-Configuration screen as shown below.

SNMP (Simple Network Management Protocol) has been widely applied in the computer networks currently, which is used for ensuring the transmission of the management information between any two nodes. In this way, network administrators can easily search and modify the information on any node on the network. Meanwhile, they can locate faults promptly and implement the fault diagnosis, capacity planning and report generating.

Figure 4-66

An **SNMP Agent** is an application running on the Modem Router that performs the operational role of receiving and processing SNMP messages, sending responses to the SNMP manager, and sending traps when an event occurs. So a router contains SNMP "agent" software can be monitored and/or controlled by SNMP Manager using SNMP messages.

4.16.6 Backup & Restore

Choose menu “**System Tools**” → “**Backup & Restore**”, and then you can save the current configuration of the Modem Router as a backup file and restore the configuration via a backup file as shown in Figure 4-67.

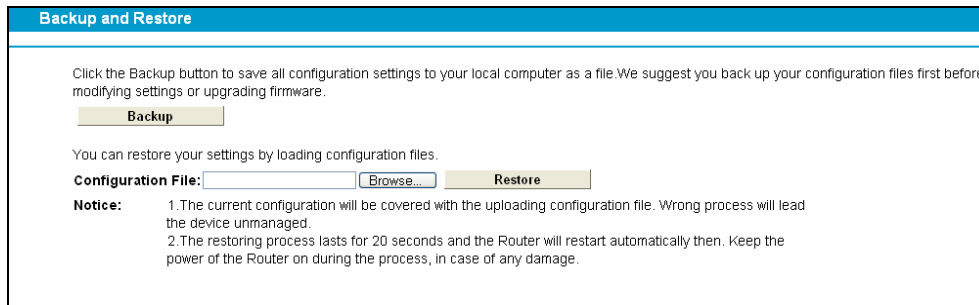

Figure 4-67

- Click the **Backup** button to save all configuration settings as a backup file in your local computer.
- To upgrade the Modem Router 's configuration, follow these instructions.
 - Click the **Browse** button to find the configuration file which you want to restore.
 - Click the **Restore** button to update the configuration with the file whose path is the one you have input or selected in the blank.

 **Note:**

The current configuration will be covered with the uploading configuration file. Wrong process will lead the device unmanaged. The restoring process lasts for 20 seconds and the Modem Router will restart automatically then. Keep the power of the Modem Router on during the process, in case of any damage.

4.16.7 Factory Defaults

Choose menu “**System Tools** → **Factory Defaults**”, and then and you can restore the configurations of the Modem Router to factory defaults on the following screen

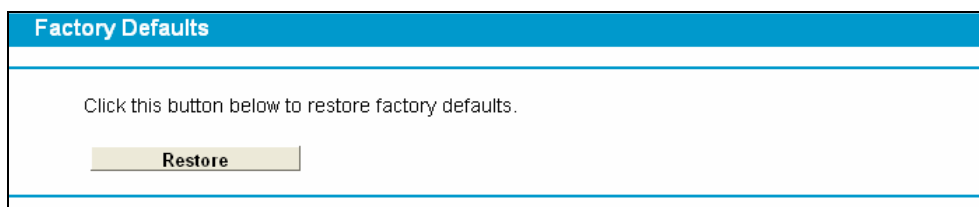

Figure 4-68

Click the **Restore** button to reset all configuration settings to their default values.

- The default **User Name**: admin

- The default **Password**: admin
- The default **Subnet Mask**: 255.255.255.0

 **Note:**

All changed settings will be lost when defaults are restored.

4.16.8 Firmware Upgrade

Choose menu “**System Tools** → **Firmware Upgrade**”, and then you can update the latest version of firmware for the Modem Router on the following screen.

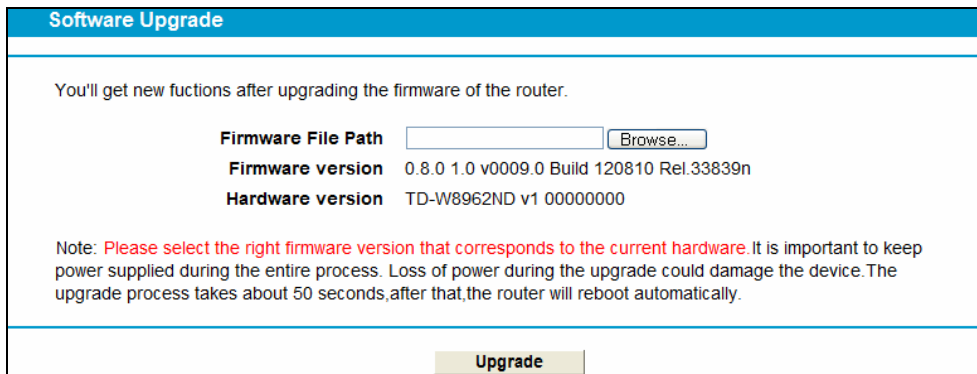

Figure 4-69

- **Firmware Version:** Displays the current firmware version.
- **Hardware Version:** Displays the current hardware version. The hardware version of the upgrade file must accord with the Modem Router’s current hardware version.

To upgrade the Modem Router's firmware, follow these instructions below:

- 1) Download a most recent firmware upgrade file from our website (www.tp-link.com).
- 2) Enter or select the path name where you save the downloaded file on the computer into the **File Name** blank.
- 3) Click the **Upgrade** button.
- 4) The Modem Router will reboot while the upgrading has been finished.

 **Note:**

- 1) New firmware versions are posted at <http://www.tp-link.com> and can be downloaded for free. There is no need to upgrade the firmware unless the new firmware has a new feature you want to use. However, when experiencing problems caused by the Modem Router rather than the configuration, you can try to upgrade the firmware.
- 2) When you upgrade the Modem Router's firmware, you may lose its current configurations, so before upgrading the firmware please write down some of your customized settings to avoid losing important settings.
- 3) Do not turn off the Modem Router or press the Reset button while the firmware is being upgraded. Loss of power during the upgrade could damage the Modem Router.
- 4) The firmware version must correspond to the hardware.
- 5) The upgrade process takes a few moments and the Modem Router restarts automatically

when the upgrade is complete.

4.16.9 Reboot

Choose menu “**System Tools**” → “**Reboot**”, and then you can click the **Reboot** button to reboot the Modem Router via the next screen.

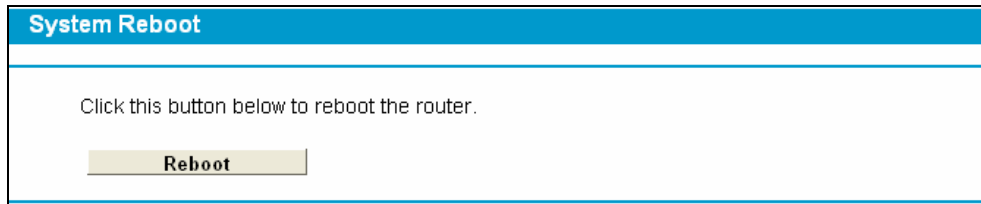

Figure 4-70

Some settings of the Modem Router will take effect only after rebooting, which include

- Change the LAN IP Address (system will reboot automatically).
- Change the DHCP Settings.
- Change the Wireless configurations.
- Change the Web Management Port.
- Upgrade the firmware of the Modem Router (system will reboot automatically).
- Restore the Modem Router's settings to factory defaults (system will reboot automatically).
- Update the configuration with the file (system will reboot automatically).

4.16.10 Statistics

Choose menu “**System Tools**” → “**Statistics**”, and then you can view the statistics of the Modem Router, including total traffic and current traffic of the last Packets Statistic Interval.

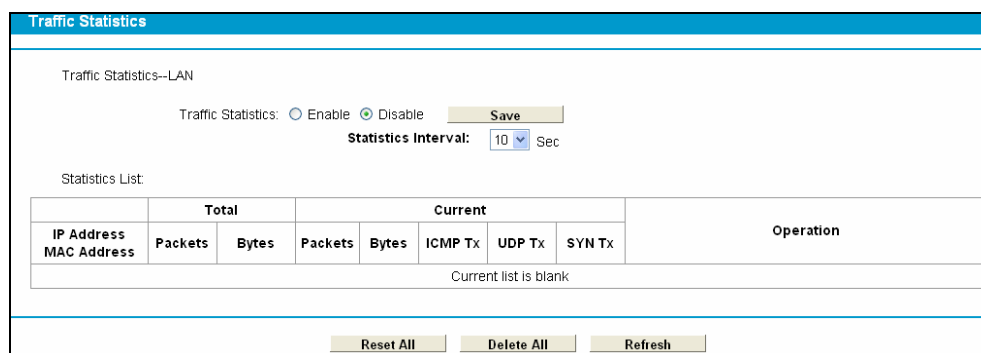

Figure 4-71

- **Statistics Status:** Enable or Disable. The default value is disabled. To enable it, click the **Enable**. If it is disabled, the function of DoS protection in Security settings will be disabled.
- **Statistics Interval (5-60):** The default value is 10. Select a value between 5 and 60 seconds in the drop-down list. The Packets Statistic interval indicates the time section of the packets statistic.

Click **Reset All** to reset the values of all the entries to zero.

Click **Delete All** to delete all entries in the table.

Click the **Refresh** button to refresh immediately.

Statistics Table:

IP/MAC Address		The IP and MAC address are displayed with related statistics.
Total	Packets	The total number of packets received and transmitted by the Modem Router.
	Bytes	The total number of bytes received and transmitted by the Modem Router.
Current	Packets	The total number of packets received and transmitted in the last Packets Statistic interval seconds.
	Bytes	The total number of bytes received and transmitted in the last Packets Statistic interval seconds.
	ICMP Tx	The number of the ICMP packets transmitted to WAN per second at the specified Packets Statistics interval. It is shown like "current transmitting rate / Max transmitting rate".
	UDP Tx	The number of UDP packets transmitted to the WAN per second at the specified Packets Statistics interval. It is shown like "current transmitting rate / Max transmitting rate".
	SYN Tx	The number of TCP SYN packets transmitted to the WAN per second at the specified Packets Statistics interval. It is shown like "current transmitting rate / Max transmitting rate".
Operation	Reset	Reset the value of the entry to zero.
	Delete	Delete the existing entry in the table.

Appendix A: Specifications

General	
Standards and Protocols	ANSI T1.413, ITU G.992.1, ITU G.992.2, ITU G.992.3, ITU G.992.5, IEEE 802.11b, IEEE 802.11g, IEEE 802.11n, IEEE 802.3, IEEE 802.3u, IEEE 802.1p, IEEE802.11e TCP/IP, PPPoA, PPPoE, SNTP, HTTP, DHCP, ICMP, NAT
Safety & Emission	FCC, CE
Ports	Four 10/100M Auto-Negotiation RJ45 ports (Auto MDI/MDIX) One RJ11 port
LEDs	⏻ Power, ⚡ ADSL, 🌐 Internet, 📶 WLAN, 🔒 WPS, 🖨️ 1,2,3,4(LAN),
Network Medium	10Base-T: UTP category 3, 4, 5 cable 100Base-TX: UTP category-5 Max line length: 6.5Km
Data Rates	Downstream: Up to 24Mbps Upstream: Up to 3.5Mbps (With Annex M enabled)
System Requirement	Internet Explorer 5.0 or later, Netscape Navigator 6.0 or later Win 9x/ ME/ 2000/ XP/ Vista/ 7
Physical and Environment	
Working Temperature	0°C ~ 40°C
Working Humidity	10% ~ 90% RH (non-condensing)
Storage Temperature	-40°C ~ 70°C
Storage Humidity	5% ~ 90% RH (non-condensing)

Appendix B: Troubleshooting

T1. How do I restore my Modem Router’s configuration to its factory default settings?

With the Modem Router powered on, press and hold the **RESET** button on the rear panel for 8 to 10 seconds before releasing it.

 **Note:**

Once the Modem Router is reset, the current configuration settings will be lost and you will need to re-configure the Modem Router.

T2. What can I do if I don’t know or forget my password?

- 1) Restore the Modem Router’s configuration to its factory default settings. If you don’t know how to do that, please refer to **T1**.
- 2) Use the default user name and password: **admin, admin**.
- 3) Try to configure your Modem Router once again by following the instructions in [4.1 Login](#).

T3. What can I do if I cannot access the web-based configuration page?

- 1) Configure your computer’s IP Address.

For Windows XP OS

Go to **Start > Control Panel**, you will then see the following page.

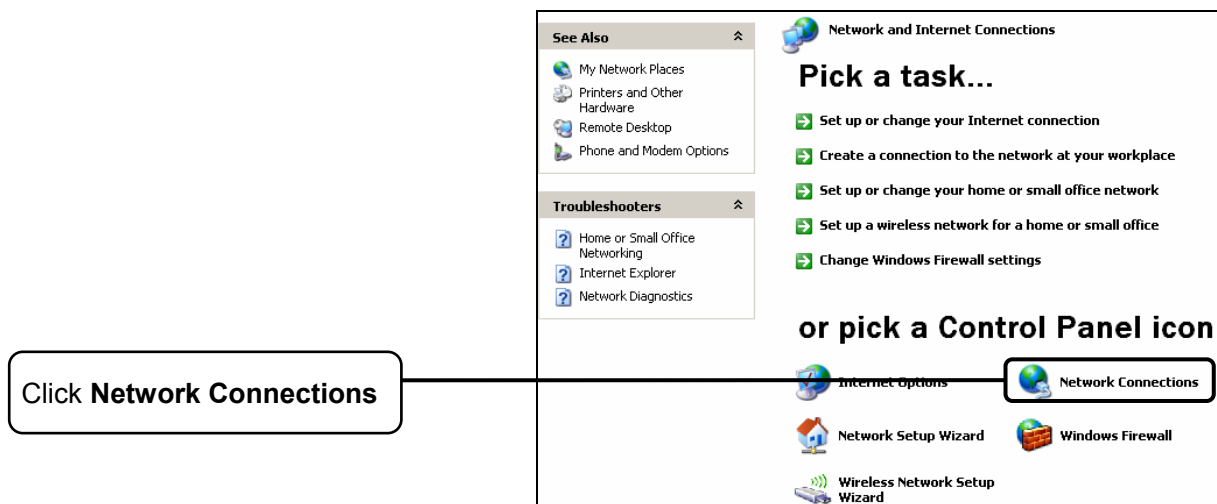
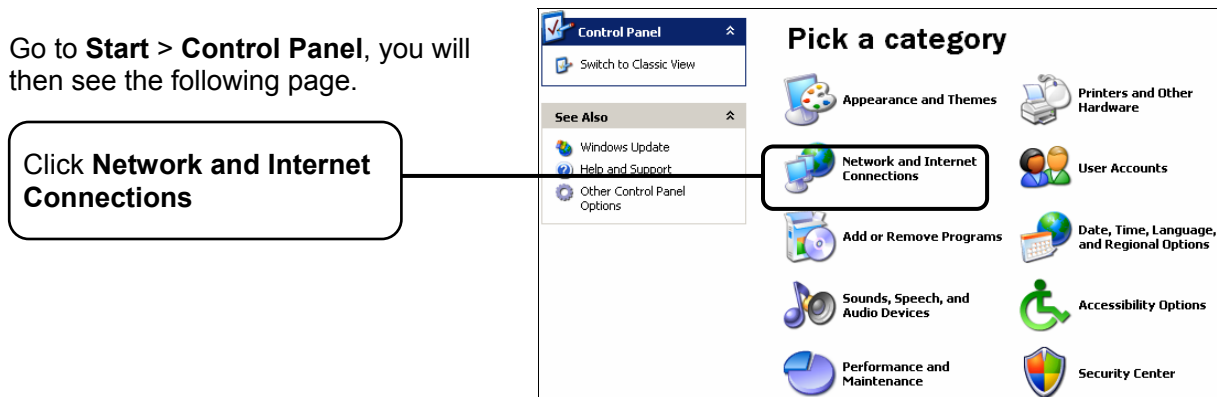

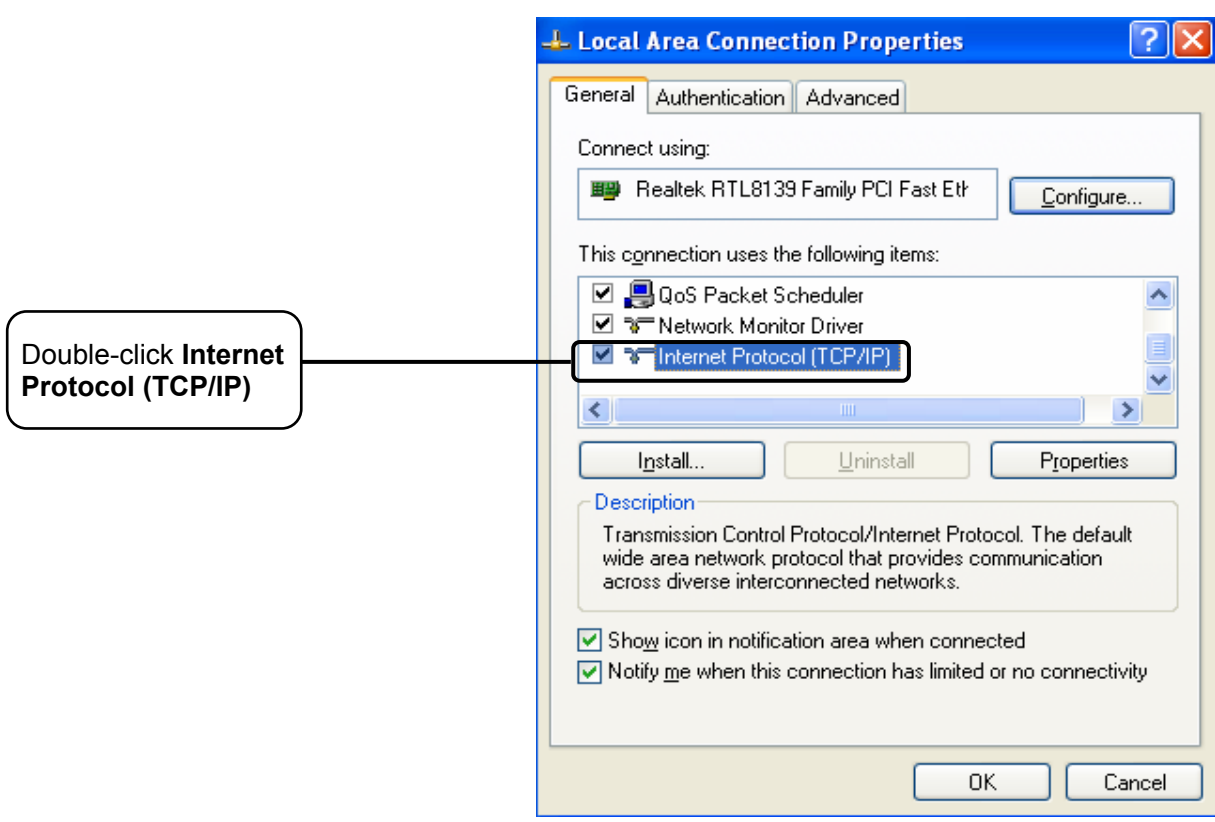
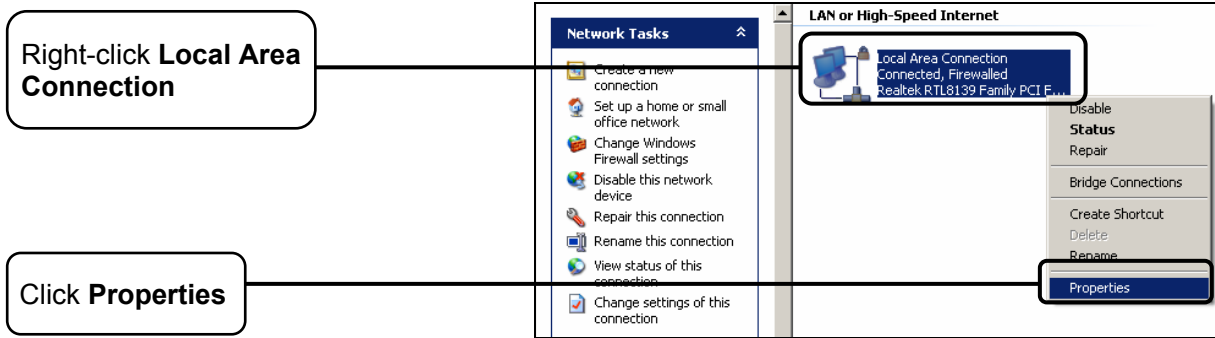

The screenshot shows the 'Internet Protocol (TCP/IP) Properties' dialog box. It has a 'General' tab selected. The text inside reads: 'You can get IP settings assigned automatically if your network supports this capability. Otherwise, you need to ask your network administrator for the appropriate IP settings.'

Three callout boxes point to specific settings:

- The first callout, 'Select Obtain an IP address automatically', points to the radio button labeled 'Obtain an IP address automatically'.
- The second callout, 'Select Obtain DNS server address automatically', points to the radio button labeled 'Obtain DNS server address automatically'.
- The third callout, 'Click OK', points to the 'OK' button at the bottom right of the dialog.

Other visible elements include the 'Advanced...' button and the 'Cancel' button.

The screenshot shows the 'Local Area Connection Properties' dialog box. It has three tabs: 'General', 'Authentication', and 'Advanced'. The 'General' tab is selected.

The 'Connect using:' section shows 'Realtek RTL8139 Family PCI Fast Eth' with a 'Configure...' button.

The 'This connection uses the following items:' section contains a list of items with checkboxes:

- QoS Packet Scheduler
- Network Monitor Driver
- Internet Protocol (TCP/IP)

Below the list are buttons for 'Install...', 'Uninstall', and 'Properties'.

The 'Description' section contains the text: 'Transmission Control Protocol/Internet Protocol. The default wide area network protocol that provides communication across diverse interconnected networks.'

At the bottom, there are two checked options:

- Show icon in notification area when connected
- Notify me when this connection has limited or no connectivity

A callout box labeled 'Click OK' points to the 'OK' button at the bottom right of the dialog.

For Windows Vista OS

Go to **Start > Settings > Control Panel**, and then you will see the following page.

Click **View network status and tasks**

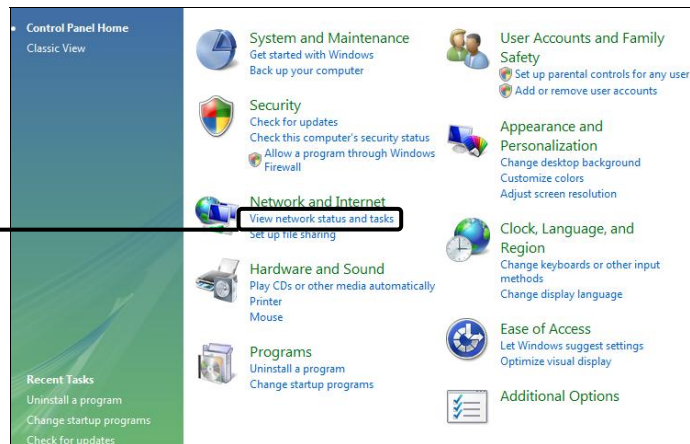

Click **View status**

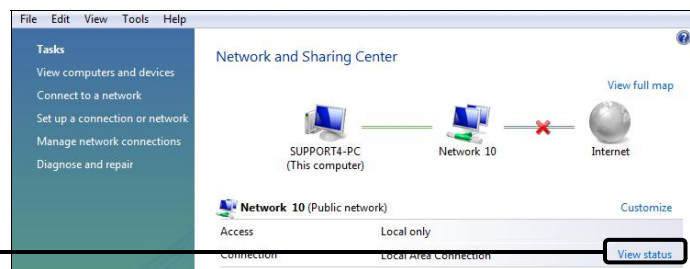

Click **Properties**

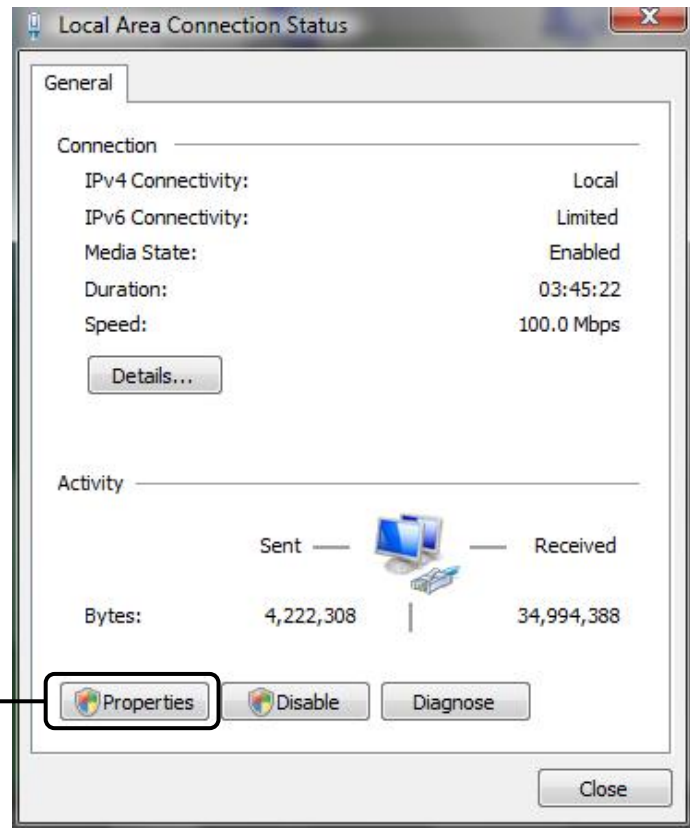

Double-click **Internet Protocol Version 4 (TCP/IPv4)**

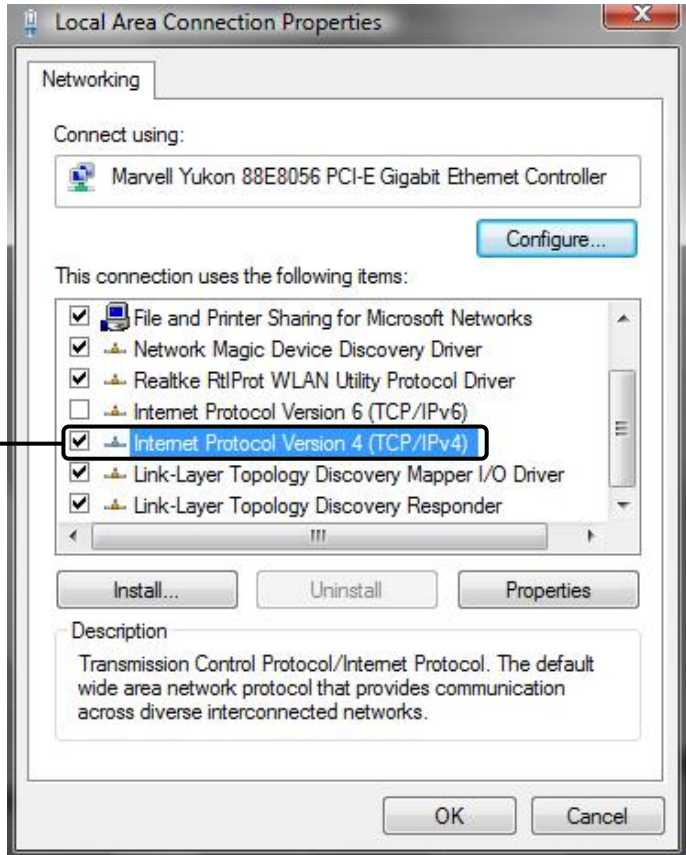

Select **Obtain an IP address automatically**

Select **Obtain DNS server address automatically**

Click **OK**

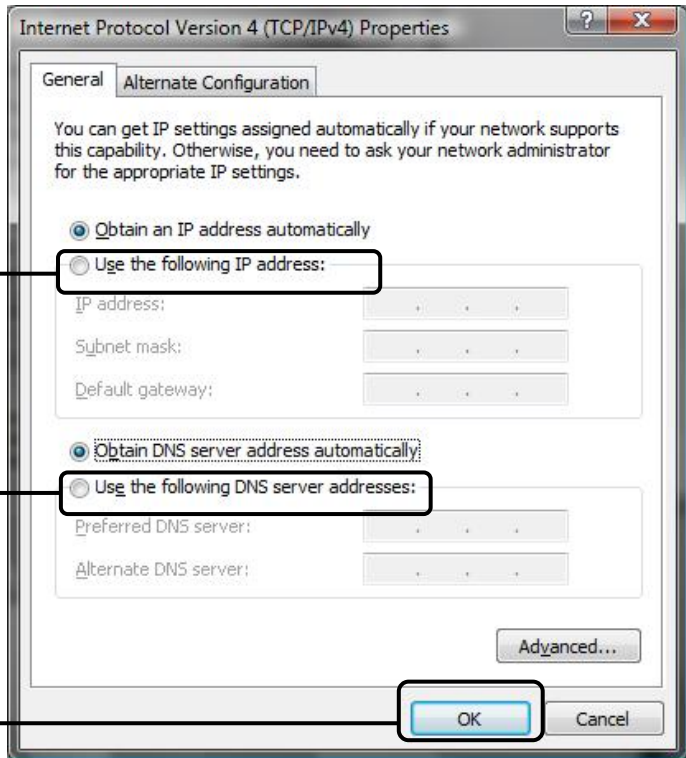

For Windows 7 OS

Go to **Start > Settings > Control Panel**, and then you will see the following page.

Click **View network status and tasks**

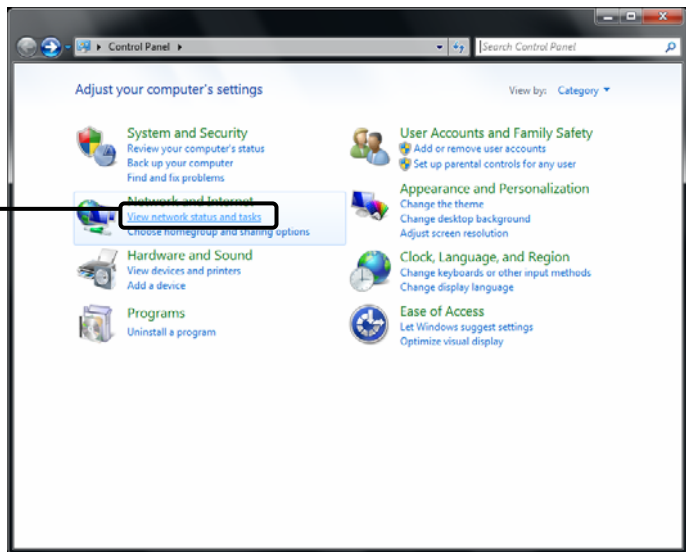

Click **Change adapter settings**

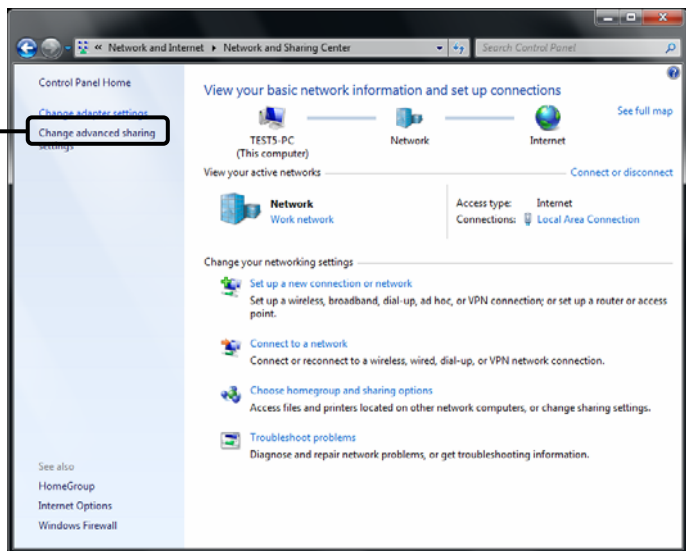

Right-click **Local Area Connection**

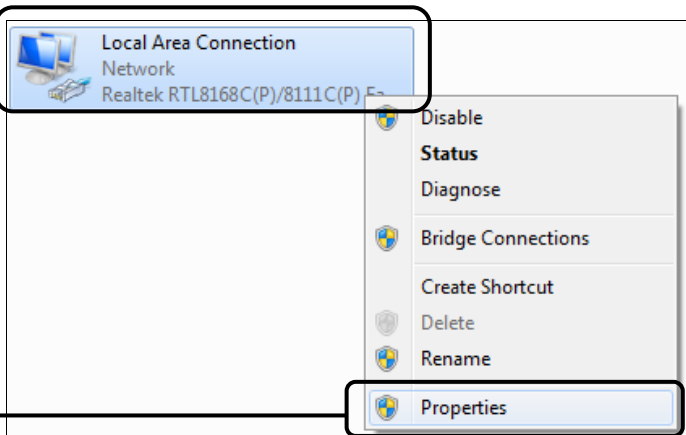

Click **Properties**

Double-click **Internet Protocol Version 4 (TCP/IPv4)**

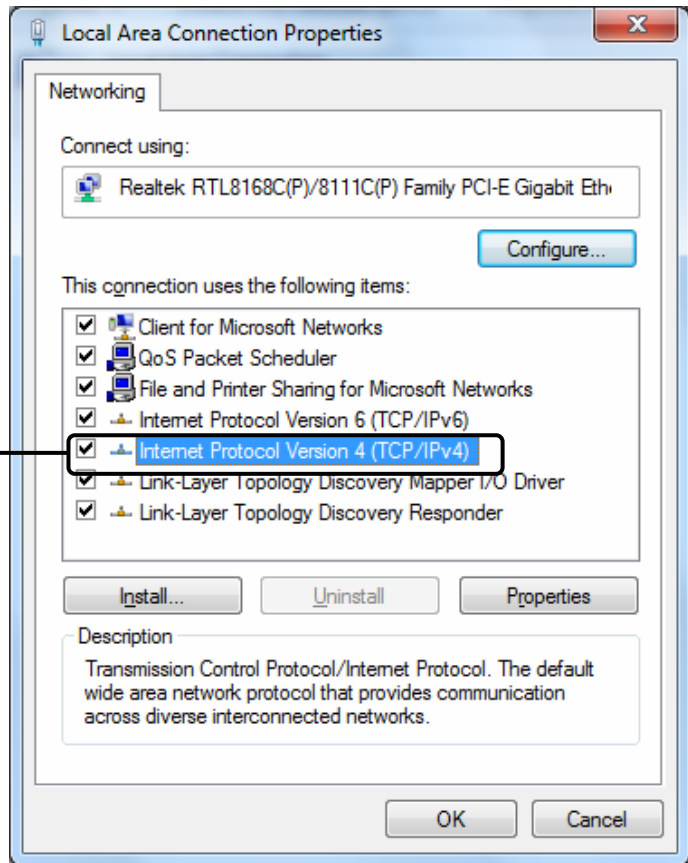

Select **Obtain an IP address automatically**

Select **Obtain DNS server address automatically**

Click **OK**

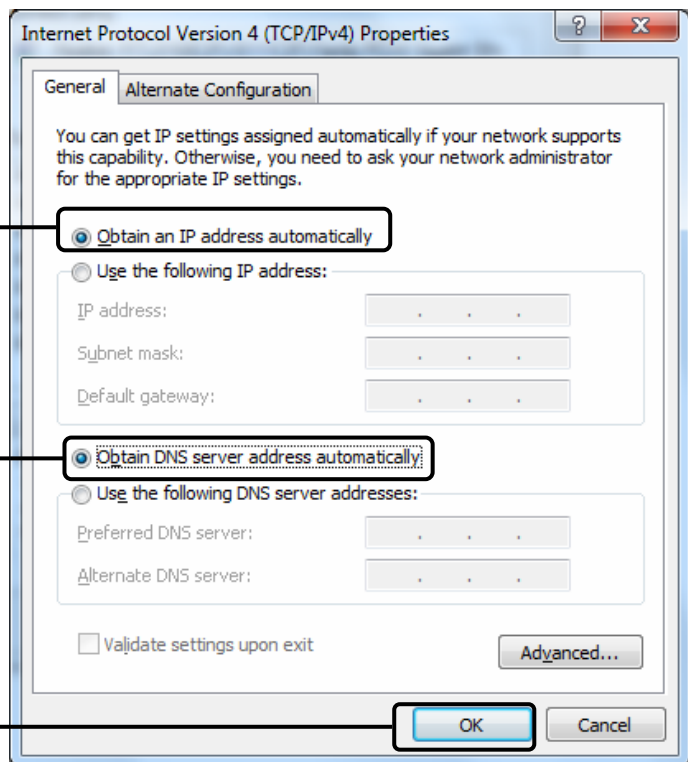

2) Configure your IE browser

Open your IE browser, click **Tools** tab and you will see the following screen.

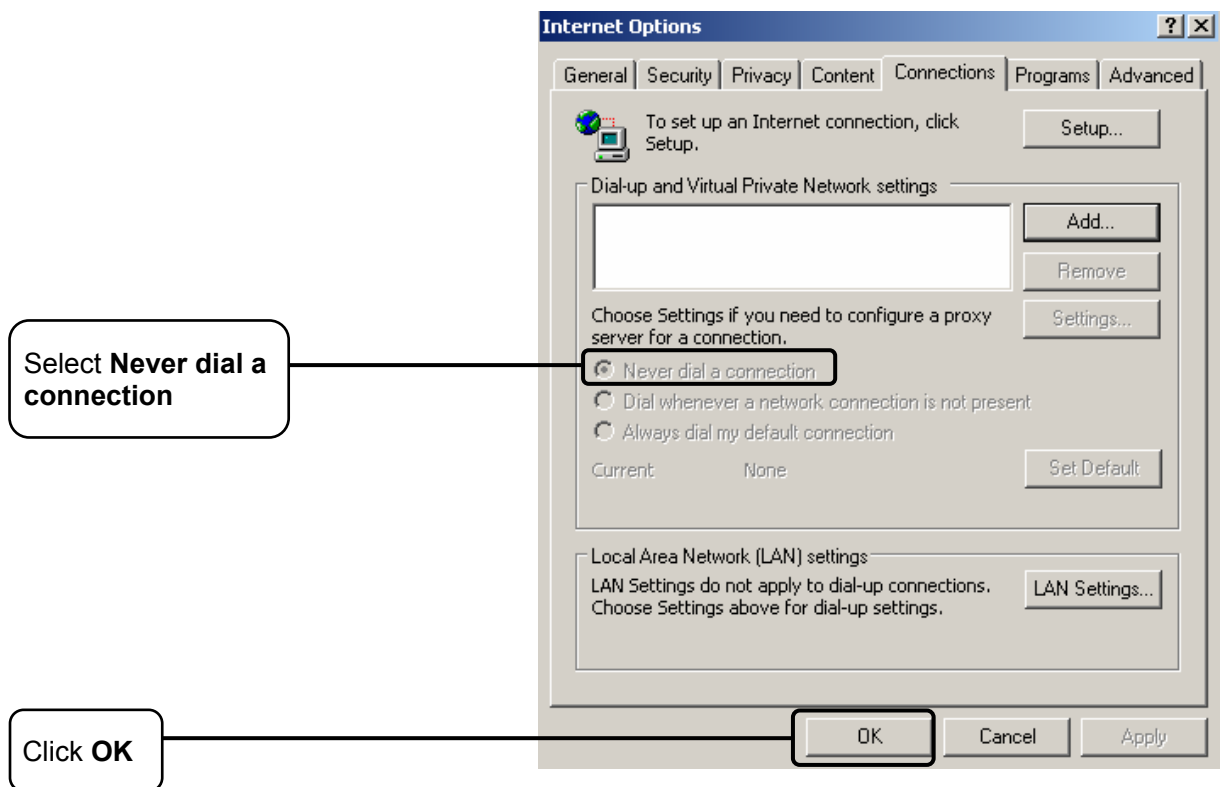
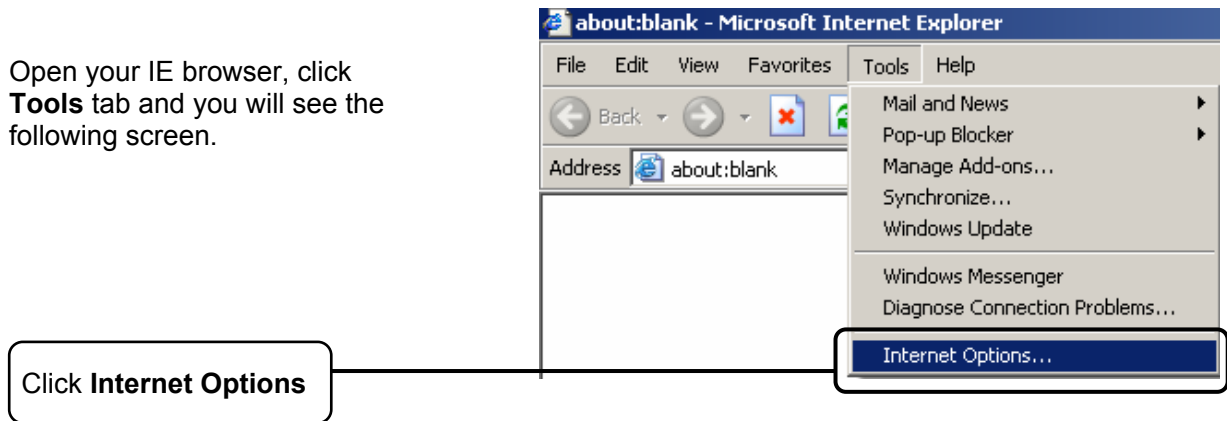

Now, try to log on to the Web-based configuration page again after the above settings have been configured. If you still cannot access the configuration page, please restore your Modem Router's factory default settings and reconfigure your Modem Router following the instructions in [4.1 Login](#). Please feel free to contact our Technical Support if the problem still exists.

T4. What can I do if I cannot access the Internet?

- 1) Check to see if all the connectors are connected well, including the telephone line, Ethernet cables and power adapter.
- 2) Check to see if you can log on to the web management page of the Modem Router. If you can, try the following steps. If you cannot, please set your computer referring to **T3** then try to see if you can access the Internet. If the problem persists, please go to the next step.

- 3) Consult your ISP and make sure all the VPI/VCI, Connection Type, account username and password are correct. If there are any mistakes, please correct the settings and try again.
- 4) If you still cannot access the Internet, please restore your Modem Router to its factory default settings and reconfigure your Modem Router by following the instructions in [4.1 Login](#).
- 5) Please feel free to contact our Technical Support if the problem still exists.

Note:

For more details about Troubleshooting and Technical Support contact information, please log on to our Technical Support Website: <http://www.tp-link.com/en/support>

Appendix C: Technical Support

Technical Support

- For more troubleshooting help, go to:
<http://www.tp-link.com/en/support/faq>
- To download the latest Firmware, Driver, Utility and User Guide, go to:
<http://www.tp-link.com/en/support/download>
- For all other technical support, please contact us by using the following details:

Global

Tel: +86 755 26504400
E-mail: support@tp-link.com
Service time: 24hrs, 7 days a week

UK

Tel: +44 (0) 845 147 0017
E-mail: support.uk@tp-link.com
Service time: 24hrs, 7 days a week

Turkey

Tel: 444 19 25 (Turkish Service)
E-mail: support.tr@tp-link.com
Service time: 9:00 AM to 9:00 PM
7 days a week

Ukraine

Tel: 0-800-505-508
E-mail: support.ua@tp-link.com
Service time: Monday to Friday
14:00 PM to 22:00 PM

Brazil

Toll Free: 0800-770-4337 (Portuguese Service)
E-mail: suporte.br@tp-link.com
Service time: Monday to Saturday
08:00 AM to 08:00 PM

France

Tel: +33 (0) 820 800 860 (French service)
Email: support.fr@tp-link.com
Fee: 0.118 EUR/min from France
Service time: Monday to Friday 9:00 AM to 6:00 PM (Except French Bank holidays)

Russian Federation

Tel: 8 (499) 754-55-60
8 (800) 250-55-60 (toll-free call from any RF region)
E-mail: support.ru@tp-link.com
Service time: From 10:00 to 18:00 (Moscow time)
*Except weekends and holidays in Russian Federation

Switzerland

Tel: +41 (0) 848 800998 (German Service)
E-mail: support.ch@tp-link.com
Fee: 4-8 Rp/min, depending on rate of different time
Service time: Monday to Friday 9:00 AM to 6:00 PM. GMT+ 1 or GMT+ 2 (Daylight Saving Time)

Singapore

Tel: +65 62840493
E-mail: support.sg@tp-link.com
Service time: 24hrs, 7 days a week

USA/Canada

Toll Free: +1 866 225 8139
E-mail: support.usa@tp-link.com
Service time: 24hrs, 7 days a week

Australia / New Zealand

Tel: AU 1300 87 5465
NZ 0800 87 5465
E-mail: support.au@tp-link.com (Australia)
support.nz@tp-link.com (New Zealand)
Service time: 24hrs, 7 days a week

Italy

Tel: +39 0230519020
E-mail: support.it@tp-link.com
Service time: Monday to Friday
9:00 AM to 1:00PM, 2:00PM to 6:00 PM

Indonesia

Tel: (+62) 021 6259 135
E-mail : support.id@tp-link.com
Service time : Monday to Friday
9:00 -12:00; 13:00 -18:00
*Except public holidays

Malaysia

Tel: 1300 88 875465 (1300 88TPLINK)
Email: support.my@tp-link.com
Service time: 24hrs, 7 days a week

Poland

Tel: +48 (0) 801 080 618 / +48 22 7217563 (if calls from mobile phone)
E-mail: support.pl@tp-link.com
Service time: Monday to Friday
9:00 AM to 5:00 PM. GMT+1 or GMT+2 (Daylight Saving Time)

Germany / Austria

Tel: +49 1805 875465 (German Service)
+49 1805 TPLINK
E-mail: support.de@tp-link.com
Fee: 0.14 EUR/min from the German fixed phone network and up to 0.42 EUR/min from mobile phone
Service time: Monday to Friday 9:00 AM to 6:00 PM. GMT+ 1 or GMT+ 2 (Daylight Saving Time in Germany)
*Except bank holidays in Hesse

Free Manuals Download Website

<http://myh66.com>

<http://usermanuals.us>

<http://www.somanuals.com>

<http://www.4manuals.cc>

<http://www.manual-lib.com>

<http://www.404manual.com>

<http://www.luxmanual.com>

<http://aubethermostatmanual.com>

Golf course search by state

<http://golfingnear.com>

Email search by domain

<http://emailbydomain.com>

Auto manuals search

<http://auto.somanuals.com>

TV manuals search

<http://tv.somanuals.com>