

# TP-LINK®

## User Guide

### TD-W9980

**N600 Wireless Dual Band Gigabit VDSL2 Modem Router**



Rev: 1.0.0  
1910010923

## COPYRIGHT & TRADEMARKS

Specifications are subject to change without notice. **TP-LINK**<sup>®</sup> is a registered trademark of TP-LINK TECHNOLOGIES CO., LTD. Other brands and product names are trademarks or registered trademarks of their respective holders.

No part of the specifications may be reproduced in any form or by any means or used to make any derivative such as translation, transformation, or adaptation without permission from TP-LINK TECHNOLOGIES CO., LTD. Copyright © 2014 TP-LINK TECHNOLOGIES CO., LTD. All rights reserved.

<http://www.tp-link.com>

## FCC STATEMENT



This equipment has been tested and found to comply with the limits for a Class B digital device, pursuant to part 15 of the FCC Rules. These limits are designed to provide reasonable protection against harmful interference in a residential installation. This equipment generates, uses and can radiate radio frequency energy and, if not installed and used in accordance with the instructions, may cause harmful interference to radio communications. However, there is no guarantee that interference will not occur in a particular installation. If this equipment does cause harmful interference to radio or television reception, which can be determined by turning the equipment off and on, the user is encouraged to try to correct the interference by one or more of the following measures:

- Reorient or relocate the receiving antenna.
- Increase the separation between the equipment and receiver.
- Connect the equipment into an outlet on a circuit different from that to which the receiver is connected.
- Consult the dealer or an experienced radio/ TV technician for help.

This device complies with part 15 of the FCC Rules. Operation is subject to the following two conditions:

- 1) This device may not cause harmful interference.
- 2) This device must accept any interference received, including interference that may cause undesired operation.

Any changes or modifications not expressly approved by the party responsible for compliance could void the user's authority to operate the equipment.

Note: The manufacturer is not responsible for any radio or tv interference caused by unauthorized modifications to this equipment. Such modifications could void the user's authority to operate the equipment.

## FCC RF Radiation Exposure Statement

This equipment complies with FCC RF radiation exposure limits set forth for an uncontrolled environment. This device and its antenna must not be co-located or operating in conjunction with any other antenna or transmitter.

"To comply with FCC RF exposure compliance requirements, this grant is applicable to only Mobile Configurations. The antennas used for this transmitter must be installed to provide a separation distance of at least 20 cm from all persons and must not be co-located or operating in conjunction with any other antenna or transmitter."

## CE Mark Warning



This is a class B product. In a domestic environment, this product may cause radio interference, in which case the user may be required to take adequate measures.

## National Restrictions

This device is intended for home and office use in all EU countries (and other countries following the EU directive 1999/5/EC) without any limitation except for the countries mentioned below:

Country	Restriction	Reason/remark
Bulgaria	None	General authorization required for outdoor use and public service
France	Outdoor use limited to 10 mW e.i.r.p. within the band 2454-2483.5 MHz	Military Radiolocation use. Refarming of the 2.4 GHz band has been ongoing in recent years to allow current relaxed regulation. Full implementation planned 2012
Italy	None	If used outside of own premises, general authorization is required
Luxembourg	None	General authorization required for network and service supply(not for spectrum)
Norway	Implemented	This subsection does not apply for the geographical area within a radius of 20 km from the centre of Ny-Ålesund
Russian Federation	None	Only for indoor applications

Note: Please don't use the product outdoors in France.

## Canadian Compliance Statement

This device complies with Industry Canada license-exempt RSS standard(s). Operation is subject to the following two conditions:

- (1) This device may not cause interference, and
- (2) This device must accept any interference, including interference that may cause undesired operation of the device.

Cet appareil est conforme aux norms CNR exemptes de licence d'Industrie Canada. Le fonctionnement est soumis aux deux conditions suivantes:

- (1) cet appareil ne doit pas provoquer d'interférences et
- (2) cet appareil doit accepter toute interférence, y compris celles susceptibles de provoquer un fonctionnement non souhaité de l'appareil.

This device has been designed to operate with the antennas listed below, and having a maximum gain of 5 dBi. Antennas not included in this list or having a gain greater than 5 dBi are strictly prohibited for use with this device. The required antenna impedance is 50 ohms.

To reduce potential radio interference to other users, the antenna type and its gain should be so chosen that the equivalent isotropically radiated power (e.i.r.p.) is not more than that permitted for successful communication.

## Industry Canada Statement

Complies with the Canadian ICES-003 Class B specifications.

Cet appareil numérique de la classe B est conforme à la norme NMB-003 du Canada.

This device complies with RSS 210 of Industry Canada. This Class B device meets all the requirements of the Canadian interference-causing equipment regulations.

Cet appareil numérique de la Classe B respecte toutes les exigences du Règlement sur le matériel brouilleur du Canada.

## Korea Warning Statements:

당해 무선설비는 운용중 전파혼신 가능성이 있음.

## NCC Notice& BSMI Notice:

注意！

依據 低功率電波輻射性電機管理辦法

第十二條 經型式認證合格之低功率射頻電機，非經許可，公司、商號或使用者均不得擅自變更頻率、加大功率或變更原設計之特性或功能。

第十四條 低功率射頻電機之使用不得影響飛航安全及干擾合法通行；經發現有干擾現象時，應立即停用，並改善至無干擾時方得繼續使用。前項合法通信，指依電信規定作業之無線電信。低功率射頻電機需忍受合法通信或工業、科學以及醫療用電波輻射性電機設備之干擾。

減少電磁波影響，請妥適使用。

安全諮詢及注意事項

- 請使用原裝電源供應器或只能按照本產品注明的電源類型使用本產品。
- 清潔本產品之前請先拔掉電源線。請勿使用液體、噴霧清潔劑或濕布進行清潔。
- 注意防潮，請勿將水或其他液體潑灑到本產品上。
- 插槽與開口供通風使用，以確保本產品的操作可靠並防止過熱，請勿堵塞或覆蓋開口。
- 請勿將本產品置放於靠近熱源的地方。除非有正常的通風，否則不可放在密閉位置中。
- 請不要私自打開機殼，不要嘗試自行維修本產品，請由授權的專業人士進行此項工作。



Продукт сертифіковано згідно с правилами системи УкрСЕПРО на відповідність вимогам нормативних документів та вимогам, що передбачені чинними законодавчими актами України.



## Safety Information

- When product has power button, the power button is one of the way to shut off the product; when there is no power button, the only way to completely shut off power is to disconnect the product or the power adapter from the power source.
- Don't disassemble the product, or make repairs yourself. You run the risk of electric shock and voiding the limited warranty. If you need service, please contact us.
- Avoid water and wet locations.

This product can be used in the following countries:

AT	BG	BY	CA	CZ	DE	DK	EE
ES	FI	FR	GB	GR	HU	IE	IT
LT	LV	MT	NL	NO	PL	PT	RO
RU	SE	SK	TR	UA			

## DECLARATION OF CONFORMITY

For the following equipment:

Product Description: N600 Wireless Dual Band Gigabit VDSL2 Modem Router

Model No.: **TD-W9980**

Trademark: **TP-LINK**

We declare under our own responsibility that the above products satisfy all the technical regulations applicable to the product within the scope of Council Directives:

Directives 1999/5/EC, Directives 2004/108/EC, Directives 2006/95/EC, Directives 1999/519/EC, Directives 2011/65/EU

The above product is in conformity with the following standards or other normative documents

**EN 300 328 V1.7.1: 2006**

**EN 301 489-1 V1.9.2:2011& EN 301 489-17 V2.2.1:2012**

**EN 55022:2010**

**EN 55024:2010**

**EN 61000-3-2:2006+A1:2009+A2:2009**

**EN 61000-3-3:2008**

**EN60950-1:2006+A11: 2009+A1:2010+A12:2011**

**EN62311:2008**

**EN 301 893**

*The product carries the CE Mark:*

**CE 1588** 

Person responsible for making this declaration:



Yang Hongliang

Product Manager of International Business

Date of issue: 2014

TP-LINK TECHNOLOGIES CO., LTD

Building 24 (floors 1, 3, 4, 5), and 28 (floors 1-4) Central Science and Technology Park,  
Shennan Rd, Nanshan, Shenzhen, China

# CONTENTS

<b>Package Contents .....</b>	<b>1</b>
<b>Chapter 1. Product Overview.....</b>	<b>2</b>
1.1 Overview of the Modem Router .....	2
1.2 Main Features.....	3
1.3 Panel Layout.....	4
1.3.1 The Front Panel .....	4
1.3.2 The Back Panel.....	6
<b>Chapter 2. Connecting the Modem Router .....</b>	<b>7</b>
2.1 System Requirements .....	7
2.2 Installation Environment Requirements .....	7
2.3 Connecting the Modem Router.....	8
<b>Chapter 3. Quick Installation Guide .....</b>	<b>9</b>
3.1 TCP/IP Configuration.....	9
3.2 Quick Installation Guide.....	10
<b>Chapter 4. Configuring the Modem Router .....</b>	<b>16</b>
4.1 Login.....	16
4.2 Status.....	16
4.3 Quick Setup .....	17
4.4 Operation Mode .....	18
4.5 Network.....	18
4.5.1 WAN Settings.....	19
4.5.2 Interface Grouping .....	34
4.5.3 LAN Settings .....	35
4.5.4 IPv6 LAN Settings.....	37
4.5.5 MAC Clone.....	38
4.5.6 ALG Settings.....	39
4.5.7 DSL Settings .....	40
4.5.8 IPSec VPN .....	40
4.6 DHCP Server .....	43
4.6.1 DHCP Settings.....	44
4.6.2 Clients List.....	45



4.6.3	Address Reservation.....	45
4.6.4	Conditional Pool.....	46
4.7	Dual Band Selection.....	47
4.8	Wireless 2.4GHz.....	48
4.8.1	Basic Settings.....	48
4.8.2	WPS Settings.....	50
4.8.3	Wireless Security.....	53
4.8.4	Wireless MAC Filtering.....	55
4.8.5	Wireless Advanced.....	56
4.8.6	Wireless Status.....	58
4.9	Wireless 5GHz.....	58
4.9.1	Basic Settings.....	58
4.9.2	WPS Settings.....	60
4.9.3	Wireless Security.....	62
4.9.4	Wireless MAC Filtering.....	64
4.9.5	Wireless Advanced.....	65
4.9.6	Wireless Status.....	66
4.10	Guest Network.....	67
4.10.1	Basic Settings.....	67
4.10.2	Guest Network Status.....	69
4.11	USB Settings.....	69
4.11.1	USB Mass Storage.....	69
4.11.2	User Accounts.....	70
4.11.3	Storage Sharing.....	71
4.11.4	FTP Server.....	73
4.11.5	Media Server.....	74
4.11.6	Print Server.....	75
4.12	Route Settings.....	76
4.12.1	Default Gateway.....	76
4.12.2	Static Route.....	76
4.12.3	IPv6 Static Route.....	77
4.12.4	RIP Settings.....	78
4.13	Forwarding.....	79
4.13.1	Virtual Servers.....	79
4.13.2	Port Triggering.....	80
4.13.3	DMZ.....	82

4.13.4 UPnP .....	83
4.14 Parental Control .....	84
4.15 IPv4 Firewall .....	85
4.15.1 Rule .....	85
4.15.2 LAN Host .....	86
4.15.3 WAN Host .....	87
4.15.4 Schedule .....	88
4.16 IPv6 Firewall .....	89
4.16.1 IPv6 Rule .....	90
4.16.2 IPv6 LAN Host .....	91
4.16.3 IPv6 WAN Host .....	92
4.16.4 IPv6 Schedule .....	92
4.17 IPv6 Tunnel .....	93
4.18 Bandwidth Control .....	96
4.19 IP&MAC Binding .....	97
4.19.1 Binding Settings .....	97
4.19.2 ARP List .....	98
4.20 Dynamic DNS .....	99
4.21 Diagnostic .....	99
4.22 System Tools .....	100
4.22.1 System Log .....	100
4.22.2 Time Settings .....	101
4.22.3 Manage Control .....	102
4.22.4 CWMP Settings .....	103
4.22.5 SNMP Settings .....	104
4.22.6 Backup & Restore .....	104
4.22.7 Factory Defaults .....	105
4.22.8 Firmware Upgrade .....	105
4.22.9 Reboot .....	106
4.22.10 Statistics .....	107
4.23 Logout .....	108
<b>Appendix A: Specifications .....</b>	<b>109</b>
<b>Appendix B: Troubleshooting .....</b>	<b>110</b>
<b>Appendix C: Technical Support .....</b>	<b>113</b>

# Package Contents

The following contents should be found in your package:

- One TD-W9980 N600 Wireless Dual Band Gigabit VDSL2 Modem Router
- One Power Adapter for TD-W9980 N600 Wireless Dual Band Gigabit VDSL2 Modem Router
- Quick Installation Guide
- One RJ45 cable
- Two RJ11 cables
- One VDSL splitter
- One Resource CD for TD-W9980 N600 Wireless Dual Band Gigabit VDSL2 Modem Router, including:
  - This User Guide
  - Other Helpful Information

 **Note:**

Make sure that the package contains the above items. If any of the listed items are damaged or missing, please contact your distributor.

# Chapter 1. Product Overview

Thank you for choosing the **TD-W9980 N600 Wireless Dual Band Gigabit VDSL2 Modem Router**.

## 1.1 Overview of the Modem Router

The TD-W9980 N600 Wireless Dual Band Gigabit VDSL2 Modem Router integrates 4-port Switch, Firewall, NAT-Router and Wireless AP. The Modem Router delivers exceptional range and speed, which can fully meet the need of Small Office/Home Office (SOHO) networks and the users demanding higher networking performance.

The TD-W9980 N600 Wireless Dual Band Gigabit VDSL2 Modem Router utilizes integrated VDSL2 transceiver and high speed MIPS CPU. The modem router supports full-rate VDSL2 connectivity conforming to the ITU and ANSI specifications.

In addition to the basic DMT physical layer functions, the VDSL2 PHY supports dual latency VDSL2 framing (fast and interleaved) and the I.432 ATM Physical Layer.

The modem router provides up to 300Mbps (2.4GHz) + 300Mbps (5GHz) wireless connection with other 802.11n wireless clients. The incredible speed makes it ideal for handling multiple data streams at the same time, which ensures your network stable and smooth. The performance of this 802.11n wireless Router will give you the unexpected networking experience at speed much faster than 802.11g. It is also compatible with all IEEE 802.11g and IEEE 802.11b products.

With multiple protection measures, including SSID broadcast control and wireless LAN 64/128 WEP encryption, Wi-Fi protected Access (WPA2-PSK, WPA-PSK), as well as advanced Firewall protections, the TD-W9980 N600 Wireless Dual Band Gigabit VDSL2 Modem Router provides complete data privacy.

The modem router provides flexible access control, so that parents or network administrators can establish restricted access policies for children or staff. It also supports Virtual Server and DMZ host for Port Triggering, and then the network administrators can manage and monitor the network in real time with the remote management function.

Since the modem router is compatible with virtually all the major operating systems, it is very easy to manage. Quick Setup Wizard is supported and detailed instructions are provided step by step in this user guide. Before installing the modem router, please look through this guide to know all the modem router's functions.

## 1.2 Main Features

- Complies with IEEE 802.11n to provide a wireless data rate of up to 300Mbps (2.4GHz) + 300Mbps (5GHz).
- Four 10/100/1000Mbps Auto-Negotiation RJ45 LAN ports (Auto MDI/MDIX), one RJ11 port.
- Provides external splitter.
- Adopts Advanced DMT modulation and demodulation technology.
- Supports bridge mode and Router function.
- Multi-user sharing a high-speed Internet connection.
- Downstream data rates up to 100Mbps, upstream data rates up to 100Mbps.
- Supports long transfers, the max line length can reach to 6.5Km.
- Supports remote configuration and management through SNMP and CWMP.
- Supports PPPoE, it allows connecting the internet on demand and disconnecting from the Internet when idle.
- Provides reliable ESD and surge-protect function with quick response semi-conductive surge protection circuit.
- High speed and asymmetrical data transmit mode, provides safe and exclusive bandwidth.
- Compatible with all mainstreams DSLAM (CO).
- Provides integrated access of internet and route function which face to SOHO user.
- Real-time Configuration and device monitoring.
- Supports Multiple PVC (Permanent Virtual Circuit).
- Built-in DHCP server.
- Built-in firewall, supporting IP/MAC filter and URL filter.
- Supports Virtual Server, DMZ host and Port Triggering.
- Supports Dynamic DNS, UPnP and Static Routing.
- Supports system log and flow Statistics.
- Supports firmware upgrade and Web-Management page.
- Provides WPA-PSK/WPA2-PSK data security, TKIP/AES encryption security.
- Provides 64/128-bit WEP encryption security and wireless LAN ACL (Access Control List).
- Supports USB Storage Sharing, Print Server, FTP Server, Media Server.
- Supports Ethernet WAN (EWAN).
- Supports Bandwidth Control.
- Supports IPv6.
- Supports VDSL.

## 1.3 Panel Layout

### 1.3.1 The Front Panel







Figure 1-1

The modem router's LEDs are located on the front panel (View from left to right). They indicate the device's working status. For details, please refer to LED Explanation.

#### LED Explanation:

Name	Status	Indication
⏻(Power)	On	The modem router is powered on.
	Off	The modem router is off. Please ensure that the power adapter is connected correctly.
📶(DSL)	On	DSL line is synchronized and ready to use.
	Flash	The DSL negotiation is in progress.
	Off	DSL synchronization fails. Please refer to <a href="#">Note 1</a> for troubleshooting.
🌐(Internet)	On	The network is available with a successful Internet connection.
	Flash	There is data being transmitted or received via the Internet.
	Off	There is no successful Internet connection or the modem router is operating in Bridge mode. Please refer to <a href="#">Note 2</a> for troubleshooting.

 (Wireless 2.4GHz)	Flash	Wireless is enabled. The modem router is working on 2.4GHz radio band.
	Off	Wireless is disabled.
 (Wireless 5GHz)	Flash	Wireless is enabled. The modem router is working on 5GHz radio band.
	Off	Wireless is disabled.
 (WPS)	On	A wireless device has been successfully added to the network by WPS function.
	Slow Flash	WPS handshaking is in process and will continue for about 2 minutes. Please press the WPS button on other wireless devices that you want to add to the network while the LED is flashing.
	Quick Flash	A wireless device has failed to be added to the network by WPS function. Please refer to <a href="#">4.8.2 WPS Settings</a> for more information.
 (LAN1-4)	On	There is a device connected to this LAN port.
	Flash	The modem router is sending or receiving data over this LAN port.
	Off	There is no device connected to this LAN port.
 (USB on the back panel)	On	A storage device or printer has connected to the USB port.
	Flash	There is data being transmitted or received via the USB port.
	Off	No storage device or printer is plugged into the USB port.

 **Note:**

1. If the DSL LED is off, please check your Internet connection first. Refer to [2.3 Connecting the Modem Router](#) for more information about how to make Internet connection correctly. If you have already made a right connection, please contact your ISP to make sure if your Internet service is available now.
2. If the Internet LED is off, please check your DSL LED first. If your DSL LED is also off, please refer to [Note 1](#). If your DSL LED is GREEN ON, please check your Internet configuration. You may need to check this part of information with your ISP and make sure everything have been input correctly.

### 1.3.2 The Back Panel



Figure 1-2

- **VDSL:** Through the port, you can connect the modem router with the telephone. Or you can connect them by an external separate splitter. For details, please refer to [2.3 Connecting the Modem Router](#).
- **USB1, USB2:** The USB port connects to a USB storage device or a USB printer.
- **WPS:** The switch for the WPS function. For details, please refer to [4.8.2 WPS Settings](#).
- **RESET:** There are two ways to reset the modem router's factory defaults.  
**Method one:** With the modem router powered on, use a pin to press and hold the Reset button for at least 5 seconds. And the modem router will reboot to its factory default settings.  
**Method two:** Restore the default setting from [4.22.7 Factory Defaults](#) of the modem router's Web-based management page.
- **WiFi:** The switch for the WiFi function. Move it to left /right to enable/disable the WiFi function.
- **LAN4/WAN, LAN3, LAN2, LAN1:** Through these ports, you can connect the modem router to your PC or the other Ethernet network devices. In wireless router mode you will be able to connect to Cable/FTTH/VDSL/ADSL device.
- **ON/OFF:** The switch for the power.
- **POWER:** The Power plug is where you will connect the power adapter.
- **Antennas:** Used for wireless operation and data transmit.



# Chapter 2. Connecting the Modem Router

## 2.1 System Requirements

- Broadband Internet Access Service (DSL/Cable/Ethernet).
- PCs with a working Ethernet Adapter and an Ethernet cable with RJ45 connectors.
- TCP/IP protocol on each PC.
- Web browser, such as Microsoft Internet Explorer, Mozilla Firefox or Apple Safari.

## 2.2 Installation Environment Requirements

- The Product should not be located where it will be exposed to moisture or excessive heat.
- Place the modem router in a location where it can be connected to the various devices as well as to a power source.
- Make sure the cables and power cord are safely placed out of the way so they do not create a tripping hazard.
- The modem router can be placed on a shelf or desktop.
- Keep away from the strong electromagnetic radiation and the device of electromagnetic sensitive.

Generally, TD-W9980 is placed on a horizontal surface. The device also can be mounted on the wall as shown in Figure 2-1.

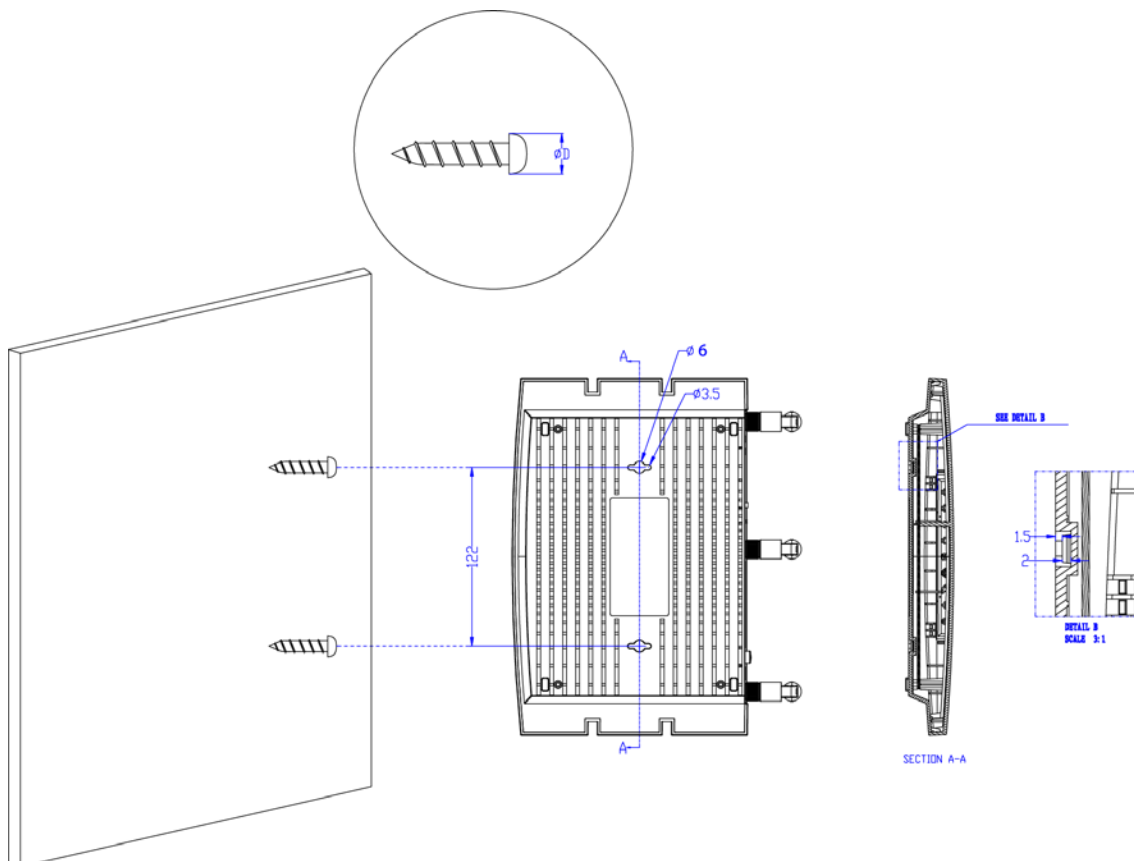

Figure 2-1 Wall-mount install

**Note:**

The diameter of the screw,  $3.5\text{mm} < D < 6\text{mm}$ , and the distance of two screws is 122mm. The screw that project from the wall need around 4mm based, and the length of the screw need to be at least 20mm to withstand the weight of the product.

## 2.3 Connecting the Modem Router

Before installing the device, please make sure your broadband service provided by your ISP is available. If there is any problem, please contact your ISP. Before cable connection, cut off the power supply and keep your hands dry. You can follow the steps below to install it.

**Step 1:** Connect the VDSL Line.

**Method one:** Plug one end of the twisted-pair VDSL cable into the VDSL port on the rear panel of TD-W9980, and insert the other end into the wall socket.

**Method two:** You can use a separate splitter. External splitter can divide the data and voice, and then you can access the Internet and make calls at the same time. The external splitter has three ports:

- LINE: Connect to the wall jack
- PHONE: Connect to the phone sets
- MODEM: Connect to the VDSL port of TD-W9980

Plug one end of the twisted-pair VDSL cable into the VDSL port on the rear panel of TD-W9980. Connect the other end to the MODEM port of the external splitter.

**Step 2:** Connect the Ethernet cable. Attach one end of a network cable to your computer's Ethernet port or a regular hub/switch port, and the other end to the LAN port on the modem router TD-W9980.

**Step 3:** Power on the computers and LAN devices.

**Step 4:** Attach the power adapter. Connect the power adapter to the power connector on the rear of the device and plug in the adapter to an electrical outlet or power extension. The electrical outlet shall be installed near the device and shall be easily accessible.

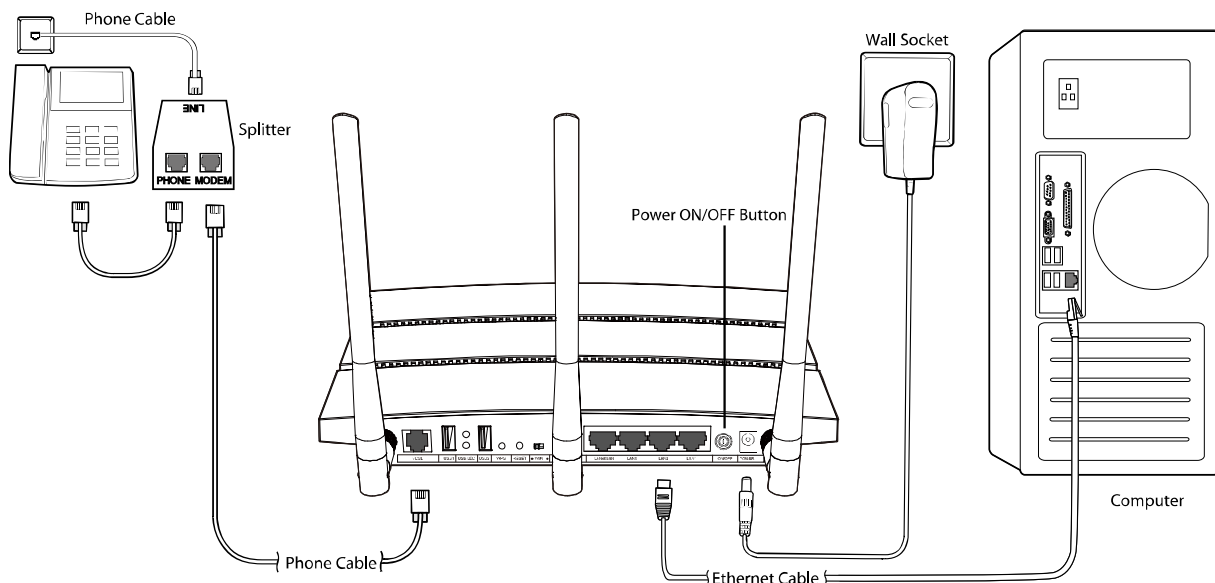

Figure 2-2

## Chapter 3. Quick Installation Guide

This chapter will show you how to configure the basic functions of your TD-W9980 N600 Wireless Dual Band Gigabit VDSL2 Modem Router using **Quick Setup Wizard** within minutes.

### 3.1 TCP/IP Configuration

The default IP address of the TD-W9980 N600 Wireless Dual Band Gigabit VDSL2 Modem Router is 192.168.1.1. And the default Subnet Mask is 255.255.255.0. These values can be changed as you desire. In this guide, we use all the default values for description.

Connect the local PC to the LAN/WAN port of the modem router. And then you can configure the IP address for your PC in the following way.

- Obtain an IP address automatically
  - 1) Set up the TCP/IP Protocol in "**Obtain an IP address automatically**" mode on your PC. If you need instructions as to how to do this, please refer to [Appendix B: Trouble shooting](#).
  - 2) Then the built-in DHCP server will assign IP address for the PC.

Now, you can run the Ping command in the command prompt to verify the network connection. Please click the **Start** menu on your desktop, select **run** tab, type **cmd or command** in the field and press **Enter**. Type **ping 192.168.1.1** on the next screen, and then press **Enter**.

If the result displayed is similar to the screen below, the connection between your PC and the modem router has been established.

```
Pinging 192.168.1.1 with 32 bytes of data:
Reply from 192.168.1.1: bytes=32 time<1ms TTL=64
Reply from 192.168.1.1: bytes=32 time<1ms TTL=64
Reply from 192.168.1.1: bytes=32 time<1ms TTL=64
Reply from 192.168.1.1: bytes=32 time<1ms TTL=64

Ping statistics for 192.168.1.1:
    Packets: Sent = 4, Received = 4, Lost = 0 (0% loss),
Approximate round trip times in milli-seconds:
    Minimum = 0ms, Maximum = 0ms, Average = 0ms
```

Figure 3-1

If the result displayed is similar to the screen shown below, it means that your PC has not connected to the modem router.

```
Pinging 192.168.1.1 with 32 bytes of data:
Request timed out.
Request timed out.
Request timed out.
Request timed out.

Ping statistics for 192.168.1.1:
    Packets: Sent = 4, Received = 0, Lost = 4 (100% loss),
```

Figure 3-2

You can check it following the steps below:

1) **Is the connection between your PC and the modem router correct?**

The LEDs of LAN port which you link to the device and the LEDs on your PC's adapter should be lit.

2) **Is the TCP/IP configuration for your PC correct?**

If the modem router's IP address is 192.168.1.1, your PC's IP address must be within the range of 192.168.1.2 ~ 192.168.1.254.

## 3.2 Quick Installation Guide

With a Web-based management page, it is easy to configure and manage the TD-W9980 N600 Wireless Dual Band Gigabit VDSL2 Modem Router. The Web-based management page can be used on any Windows, Macintosh or UNIX OS with a Web browser, such as Microsoft Internet Explorer, Mozilla Firefox or Apple Safari.

1. To access the configuration utility, open a web-browser and type the default address [http://tplinkmodem.net/](http://tplinkmodem.net) in the address field of the browser.



Figure 3-3

After a moment, a login window will appear, similar to the Figure 3-4. Enter **admin** for the User Name and Password, both in lower case letters. Then click the **Login** button or press the **Enter** key.



Figure 3-4

**Note:**

- 1) Do not mix up the user name and password with your DSL account user name and password which are needed for PPP connections.
  - 2) If the above screen does not pop up, it means that your Web-browser has been set to a proxy. Go to **Tools** menu → **Internet Options** → **Connections** → **LAN Settings**, in the screen that appears, cancel the Using Proxy checkbox, and click **OK** to finish it.
2. After your successful login, you will see the Login screen as shown in Figure 3-5. Click **Quick Setup** menu to access **Quick Setup Wizard** and then click **Next**.

Figure 3-5

3. Select your **Region** and **Time Zone** from the drop-down list, then click **Next**.

Figure 3-6

4. The modem router supports two modes: **xDSL Modem Router Mode** and **Wireless Router Mode**. Choose your desired mode and then click **Next**.

Figure 3-7

- **xDSL Modem Router Mode:** In this mode, the device enables multi-users to share Internet via xDSL using its VDSL port and share it wirelessly at 300Mbps wireless 802.11n speeds.

➤ **Wireless Router Mode:** In this mode, the device enables multi-users to share Internet via Ethernet WAN (EWAN) using its interchangeable LAN/WAN port and share it wirelessly at 300Mbps wireless 802.11n speeds.

● **xDSL Modem Router Mode**

- 1) Select your **ISP** from the drop-down list, then click **Next**.

Quick Setup - Select ISP

Please select your ISP(Internet Service Provider).

ISP List: ADSL\_BT

PVC: 0/38

Connection Type: PPPoA

Encapsulation Mode: VCMUX

Back Next

Figure 3-8

 **Note:**

If your ISP is not listed, please select **others**, you can select the **L2 Interface Type**, enter the values given by your ISP, then click **Next**.

Quick Setup - DSL

Please select dsl modulation type, then enter the PVC or the VID.  
Current DSL modulation type is VDSL, and ADSL wan connections are disabled.

L2 Interface Type: VDSL

Enable Vlan ID:

VID: 1 (1-4094)

Back Next

- 2) Select the connection type provided by your ISP.

Quick Setup - xDSL Connection Type

Please select the connection type provided by your ISP.

- PPPoE** (Require a username and password, PPP over Ethernet)
- PPPoA** (Require a username and password, PPP over ATM)
- Dynamic IP** (Get dynamic IP from ISP, also called IPoE Dynamic IP)
- Static IP** (Manually set the static IP address provided by your ISP, also called IPoE Static IP)
- IPoA** (Manually set the static IP address provided by your ISP, also called IP Over ATM)
- Bridge** (Dial up from the single computer or router)

Back Next

Figure 3-9

- 3) Here we use **PPPoE** as an example. Enter the PPPoE Username and Password provided by your ISP. After confirming the password, click **Next** to continue.

Quick Setup - PPPoE

Please enter the Username and Password. If you forget them, please consult your ISP.

Username:

Password:

Confirm password:

Back Next

Figure 3-10

- **Wireless Router Mode**

- 1) Select the connection type provided by your ISP.

Quick Setup - Ethernet WAN Type

Please select the connection type provided by your ISP.

- PPPoE** (Use this option if you used to run a specified program such as "Broadband Connection" on the computer with Username and Password provided by your ISP)
- Dynamic IP** (Use this option if you are immediately online once your computer directly plugs into your Cable/DSL modem without any setting changes or signing-in)
- Static IP** (Manually set the static IP address provided by your ISP)

Back Next

Figure 3-11

- 2) Here we use **PPPoE** as an example. Enter the PPPoE Username and Password provided by your ISP. After confirming the password, click **Next** to continue.

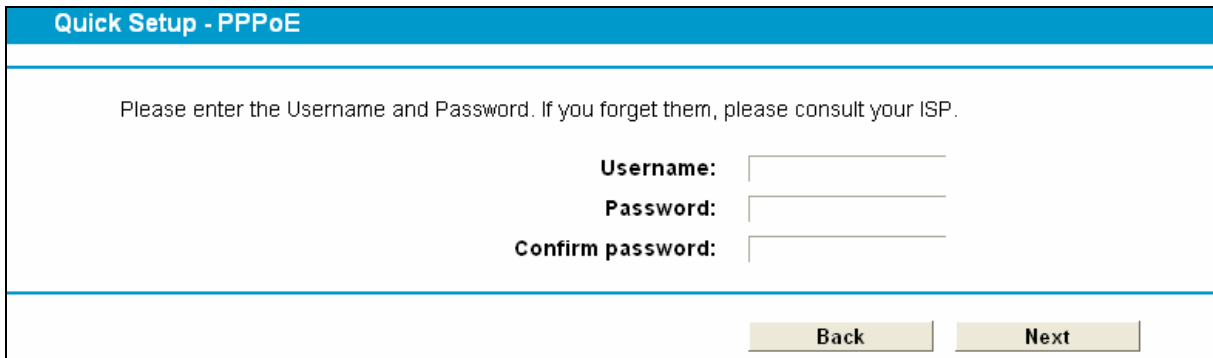

Quick Setup - PPPoE

Please enter the Username and Password. If you forget them, please consult your ISP.

Username:

Password:

Confirm password:

Back Next

Figure 3-12

5. Configure the basic parameters for 2.4GHz wireless network in the following screen as shown in Figure 3-13, and then click **Next**.

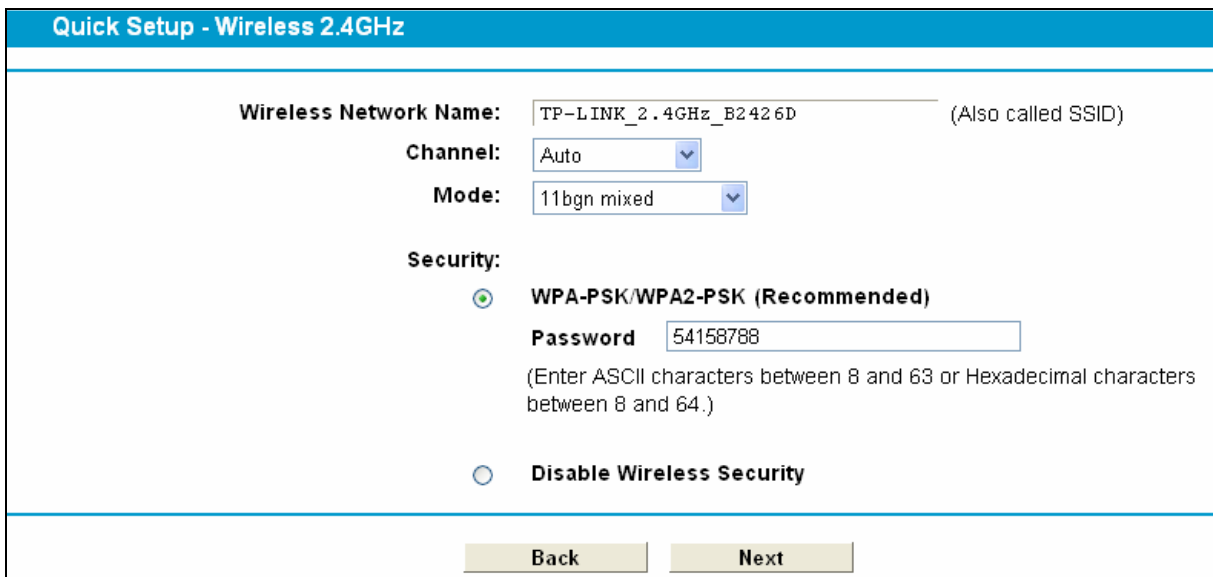

Quick Setup - Wireless 2.4GHz

Wireless Network Name:  (Also called SSID)

Channel:

Mode:

Security:

WPA-PSK/WPA2-PSK (Recommended)

Password:

(Enter ASCII characters between 8 and 63 or Hexadecimal characters between 8 and 64.)

Disable Wireless Security

Back Next

Figure 3-13

6. Configure the basic parameters for 5GHz wireless network in the following screen as shown in Figure 3-14, and then click **Next**.

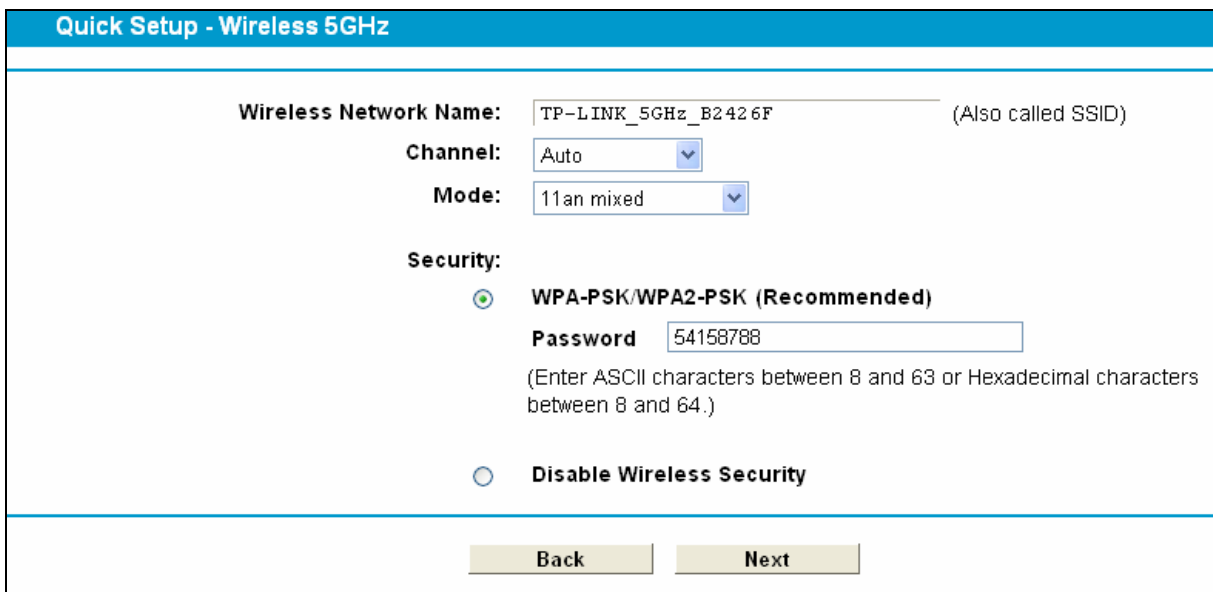

Quick Setup - Wireless 5GHz

Wireless Network Name:  (Also called SSID)

Channel:

Mode:

Security:

WPA-PSK/WPA2-PSK (Recommended)

Password:

(Enter ASCII characters between 8 and 63 or Hexadecimal characters between 8 and 64.)

Disable Wireless Security

Back Next

Figure 3-14



7. On this page, please confirm all parameters. Click **Back** to modify or click the **Save** button to save your configuration.

**Quick Setup - Confirm**

The Quick Setup is completed. Please confirm all the parameters below. Click BACK button to modify or click SAVE button to save your configuration.

Parameters Summary:

<b>Region:</b>	United Kingdom
<b>Time Zone:</b>	+00:00
<b>ADSL PVC:</b>	0/38
<b>Connection Type:</b>	PPPoE
<b>Username:</b>	user
<b>Password:</b>	*****
<b>Wireless 2.4GHz:</b> Enabled	
<b>Wireless Network Name(SSID):</b>	TP-LINK_2.4GHz_B2426D
<b>Channel:</b>	Auto
<b>Mode:</b>	11bgn mixed
<b>Security:</b>	WPA-PSK/WPA2-PSK
<b>Wireless Password:</b>	54158788
<b>Wireless 5GHz:</b> Enabled	
<b>Wireless Network Name(SSID):</b>	TP-LINK_5GHz_B2426F
<b>Channel:</b>	Auto
<b>Mode:</b>	11an mixed
<b>Security:</b>	WPA-PSK/WPA2-PSK
<b>Wireless Password:</b>	54158788

Figure 3-15

8. You will see the **Complete** screen below, click **Finish** to complete these settings.

**Quick Setup - Complete**

Setup Status:

<b>Time Zone Configuring:</b>	Success
<b>Operation Mode Configuring:</b>	Success
<b>WAN Connection Configuring:</b>	Success
<b>Gateway and DNS Configuring:</b>	Success
<b>Wireless 2.4GHz Configuring:</b>	Success
<b>Wireless 5GHz Configuring:</b>	Success

Quick Setup has completed. Please click Finish button to exit.

Note: If the Modem Router still can not connect to the Internet, please click "Network > WAN Settings" menu on the left to confirm the WAN connection type and mode on the WAN Settings page.

Figure 3-16

## Chapter 4. Configuring the Modem Router

This chapter will show each Web page's key function and the configuration.

### 4.1 Login

After your successful login, you will see the twenty-two main menus on the left of the Web-based management page. On the right, there are the corresponding explanations and instructions.

Status
Quick Setup
Operation Mode
Network
DHCP Server
Dual Band Selection
Wireless 2.4GHz
Wireless 5GHz
Guest Network
USB Settings
Route Settings
Forwarding
Parent Control
IPv4 Firewall
IPv6 Firewall
IPv6 Tunnel
Bandwidth Control
IP & MAC Binding
Dynamic DNS
Diagnostic
System Tools
Logout

The detailed explanations for each Web page's key function are listed below.

### 4.2 Status

Choose "**Status**", you can see the corresponding information about **Device Information**, **DSL**, **WAN**, **LAN** and **Wireless**.

**Basic Status**

---

**Device Information**

**Firmware Version:** 0.6.0 1.3 v0021.0 Build 140120 Rel.35163n  
**Hardware Version:** TD-W9980 v1 00000000  
**System Up Time:** 0 day(s) 21:42:21

---

**DSL**

**Line Status:** Disconnected  
**DSL Modulation Type:** Multimode  
**Annex Type:** Annex A/B/L/M

	Upstream	Downstream
<b>Current Rate (Kbps)</b>	0	0
<b>Max Rate (Kbps)</b>	0	0
<b>SNR Margin (dB)</b>	0	0
<b>Line Attenuation (dB)</b>	0	0
<b>Errors (Pkts)</b>	0	0

---

**WAN**

Name	Connection Type	VPI/VCI or VID	IP/Mask	Gateway	DNS	Status
<b>IPv6 WAN</b>						
Name	Connection Type	VPI/VCI or VID	IPv6 Address/Prefix Length	Gateway	DNSv6	Status
< >						

---

**LAN**

**MAC Address:** C0:4A:00:B2:42:6D  
**IP Address:** 192.168.1.1  
**Subnet Mask:** 255.255.255.0  
**DHCP:** Enabled

**IPv6 LAN**

**IPv6 Address:** N/A  
**Prefix Length:** 64  
**Autoconfiguration Type:** RADVD

---

**Wireless 2.4GHz**

**Status:** Enabled  
**SSID:** TP-LINK\_2.4GHz\_B2426D  
**Channel:** Auto(Channel 6)  
**Channel Width:** Auto  
**Mode:** 11bgn mixed  
**Encryption:** WPA-PSK/WPA2-PSK  
**MAC Address:** C0:4A:00:B2:42:6D  
**Max Tx Rate:** 300Mbps  
**WDS Status:** Disabled

---

**Wireless 5GHz**

**Status:** Enabled  
**SSID:** TP-LINK\_5GHz\_B2426F  
**Channel:** Auto(Channel 48)  
**Channel Width:** Auto  
**Mode:** 11an mixed  
**Encryption:** WPA-PSK/WPA2-PSK  
**MAC Address:** C0:4A:00:B2:42:6F  
**Max Tx Rate:** 300Mbps

Figure 4-1

### 4.3 Quick Setup

Please refer to Section [3.2 Quick Installation Guide](#).

## 4.4 Operation Mode

Choose “**Operation Mode**”, and you will see the screen as shown in Figure 4-2. Select your desired mode and then click **Save**.

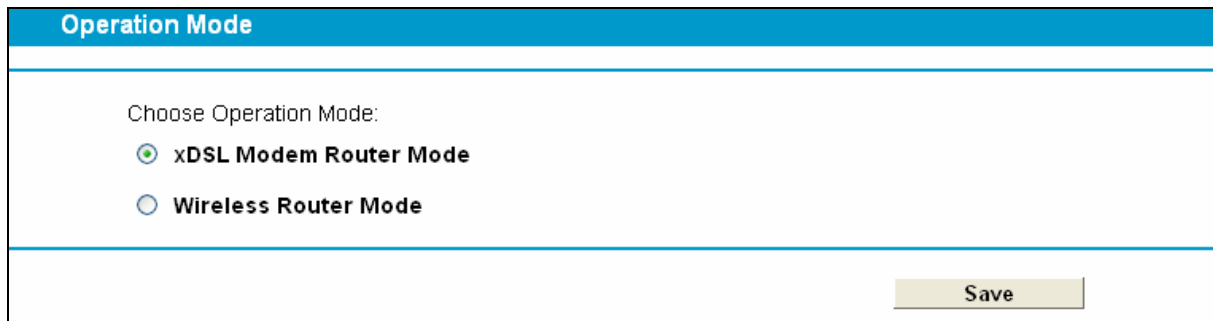
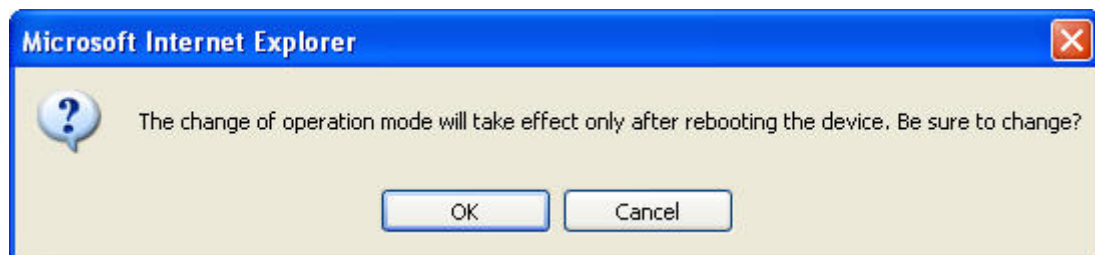

Figure 4-2

- **xDSL Modem Router Mode:** In this mode, the device enables multi-users to share Internet via xDSL using its VDSL port and share it wirelessly at 300Mbps wireless 802.11n speeds.
- **Wireless Router Mode:** In this mode, the device enables multi-users to share Internet via Ethernet WAN (EWAN) using its interchangeable LAN4/WAN port and share it wirelessly at 300Mbps wireless 802.11n speeds.

After you click the **Save** button, the Note Dialog will appear. Click **OK** and then the modem router will reboot. Please wait.



Note Dialog

## 4.5 Network

Choose “**Network**”, there are many submenus under the main menu. Click any one of them, and you will be able to configure the corresponding function.

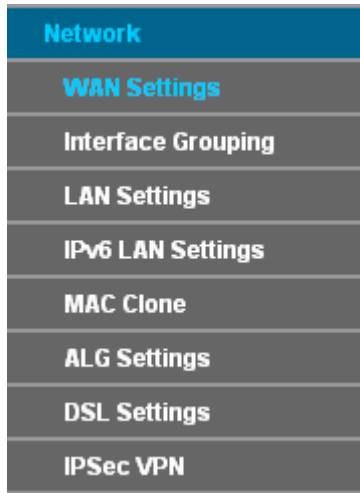

### 4.5.1 WAN Settings

Choose “**Network**”→“**WAN Settings**”, and you will see the WAN Port Information Table in the screen similar to Figure 4-3.

#### 4.5.1.1 VDSL WAN Settings

For **VDSL** mode, there are four different connection types, which are Static IP, Dynamic IP, PPPoE and Bridge. You can select the corresponding types according to your needs.

xDSL WAN Interface										
<p>This page shows the information of the entire xDSL WAN interface.            Current DSL modulation type is <b>VDSL</b>, and ADSL wan connections are disabled.</p>										
Name	Type	VPI/VCI or VID	IPv4	IPv6	IP/Mask	Gateway	DNS	Status	Connect	Action
<input type="button" value="Add"/> <input type="button" value="Refresh"/>										

Figure 4-3

Click **Add** to add a new entry, you can configure the parameters for PTM and WAN Service in the next screen (shown in Figure 4-4).

WAN Settings	
DSL Modulation Type	DSL Modulation Type: <input type="text" value="VDSL"/>
PTM Configuration	Enable Vlan ID <input checked="" type="checkbox"/> VLAN ID (1-4094): <input type="text" value="1"/>
WAN Service Setup	Connection Type: <input type="text" value="PPPoE"/> PPP Username: <input type="text"/> PPP Password: <input type="text"/> Confirm password: <input type="text"/> Connection Mode: <input checked="" type="radio"/> Always on <input type="radio"/> Connect on demand <input type="radio"/> Connect manually Max Idle Time: <input type="text" value="15"/> minutes (0 means remain active at all time) Authentication Type: <input type="text" value="AUTO_AUTH"/> Enable IPv4: <input checked="" type="checkbox"/> Enable IPv6: <input type="checkbox"/> Default Gateway: <input type="text" value="Current Connection"/>
<input type="button" value="Advance"/>	
<input type="button" value="Save"/> <input type="button" value="Back"/>	

Figure 4-4

DSL Modulation Type:

- **DSL Modulation Type:** The modem router supports two modulation types: ADSL and VDSL, you can select the corresponding types according to your needs.

PTM Configuration:

- **Enable VLAN ID:** Check the box to enable the Virtual LAN ID.
- **VLAN ID (1~4049):** This indicates the VLAN group, and the valid range is from 1 to 4049.

### 1) Static IP

Select this option if your ISP provides static IP information to you. You should set static IP address, IP subnet mask, and gateway address in the screen below.

WAN Settings	
DSL Modulation Type	DSL Modulation Type: <input type="text" value="VDSL"/>
PTM Configuration	Enable Vlan ID: <input checked="" type="checkbox"/> VLAN ID (1-4094): <input type="text" value="1"/>
WAN Service Setup	Connection Type: <input type="text" value="Static IP"/> Enable IPv4: <input checked="" type="checkbox"/> IP Address: <input type="text" value="0.0.0.0"/> Subnet Mask: <input type="text" value="0.0.0.0"/> Gateway: <input type="text" value="0.0.0.0"/> (optional) DNS Server: <input type="text" value="0.0.0.0"/> (optional) Secondary DNS Server: <input type="text" value="0.0.0.0"/> (optional) Enable IPv6: <input checked="" type="checkbox"/> IPv6 Address: <input type="text" value="::"/> Prefix Length: <input type="text" value="64"/> IPv6 Gateway: <input type="text" value="::"/> (optional) IPv6 DNS Server: <input type="text" value="::"/> (optional) Secondary IPv6 DNS Server: <input type="text" value="::"/> (optional) Default Gateway: <input type="text" value="Current Connection"/> IPv6 Default Gateway: <input type="text" value="Current Connection"/> MTU(Bytes): <input type="text" value="1500"/> (1500 as default, do not change unless necessary) <span style="float: right;">Hide ^</span> Enable NAT: <input checked="" type="checkbox"/> Enable Fullcone NAT: <input type="checkbox"/> Enable SPI Firewall: <input type="checkbox"/> Enable IGMP Proxy: <input checked="" type="checkbox"/>
<input type="button" value="Save"/> <input type="button" value="Back"/>	

Figure 4-5

## WAN Service Setup:

- **Enable IPv4:** Check the box to enable IPv4.
- **IP Address:** Enter the IP address in dotted-decimal notation provided by your ISP.
- **Subnet Mask:** Enter the subnet Mask in dotted-decimal notation provided by your ISP, usually is 255.255.255.0.
- **Default Gateway (Optional):** Enter the gateway IP address in dotted-decimal notation provided by your ISP.
- **DNS Server/ Secondary DNS Server:** Here you can set DNS Server (at least one) manually. The Route will use this DNS Server for priority.
- **Enable IPv6:** Check the box to enable IPv6.
- **IPv6 Address:** Enter the IPv6 address provided by your ISP.
- **Prefix Length:** Enter the prefix length of the IPv6 address. The default value is 64.
- **IPv6 Gateway:** Enter the gateway IPv6 address provided by your ISP.
- **IPv6 DNS Server / Secondary IPv6 DNS Server:** Here you can set IPv6 DNS Server (at least one) manually. The Route will use this IPv6 DNS Server for priority.
- **Default Gateway:** Select a WAN Interface from the drop-down list as the IPv4 default gateway.

- **IPv6 Default Gateway:** Select a WAN Interface from the drop-down list as the IPv6 default gateway.

Click **Advance**, advanced selections of WAN Service Setup can be shown.

- **MTU (bytes):** Maximum Transmission Unit Size. Check this box then you can change the MTU size. The default **MTU** value is 1500 Bytes. It is not recommended that you change the default value unless required by your ISP.
- **Enable NAT:** This technology translates the IP addresses of a local area network to a different IP address for the Internet. If this modem router is hosting your network's connection to the Internet, please select the check box. If another Router exists in your network, you don't need to select the option.
- **Enable Fullcone NAT:** It is a type of NAT, if not enabled, the default NAT will act.
- **Enable SPI Firewall:** A SPI firewall enhances network's security. Select the option to use a firewall, or else without a firewall.
- **Enable IGMP Proxy:** IGMP (Internet Group Management Protocol) is used to manage multicasting on TCP/IP networks. Some ISPs use IGMP to perform remote configuration for client devices, such as the modem router. The default value is disabled, and if you are not sure, please contact your ISP or just leave it.

Click the **Save** button to save the settings.

## 2) Dynamic IP

Select this option, the modem router will be able to obtain IP network information dynamically from a DHCP server provided by your ISP.

WAN Settings	
DSL Modulation Type	DSL Modulation Type: <input type="text" value="VDSL"/>
PTM Configuration	Enable Vlan ID <input checked="" type="checkbox"/> VLAN ID (1-4094): <input type="text" value="1"/>
WAN Service Setup	Connection Type: <input type="text" value="Dynamic IP"/> Enable IPv4: <input checked="" type="checkbox"/> IP Address: <input type="text" value="0.0.0.0"/> Subnet Mask: <input type="text" value="0.0.0.0"/> Gateway: <input type="text" value="0.0.0.0"/> Enable IPv6: <input type="checkbox"/> Default Gateway: <input type="text" value="Current Connection"/>
	MTU(Bytes): <input type="text" value="1500"/> (1500 as default, do not change unless necessary) <span style="float: right;">Hide</span>
	Enable NAT: <input checked="" type="checkbox"/> Enable Fullcone NAT: <input type="checkbox"/> Enable SPI Firewall: <input type="checkbox"/> Enable IGMP Proxy: <input checked="" type="checkbox"/> Get IP with Unicast: <input type="checkbox"/> (It is usually not required) Set DNS server manually: <input type="checkbox"/> Host Name: <input type="text" value="TD-W9980"/>
	<input type="button" value="Save"/> <input type="button" value="Back"/>

Figure 4-6

Click **Advance**, advanced selections for WAN Service Setup can be shown.



- **MTU (bytes):** Maximum Transmission Unit Size. Check this box then you can change the MTU size. The default **MTU** value is 1500 Bytes. It is not recommended that you change the default value unless required by your ISP.
- **Enable NAT:** This technology translates the IP addresses of a local area network to a different IP address for the Internet. If this modem router is hosting your network's connection to the Internet, please select the check box. If another Router exists in your network, you don't need to select the option.
- **Enable Fullcone NAT:** It is a type of NAT, if not enabled, the default NAT will act.
- **Enable SPI Firewall:** A SPI firewall enhances network's security. Select the option to use a firewall, or else without a firewall.
- **Enable IGMP Proxy:** IGMP (Internet Group Management Protocol) is used to manage multicasting on TCP/IP networks. Some ISPs use IGMP to perform remote configuration for client devices, such as the modem router. The default value is disabled, and if you are not sure, please contact your ISP or just leave it.
- **Get IP with Unicast:** This is disabled by default. The minority of DHCP Server of ISP will not support to enable this. When the Route is connected right but IP cannot get, you can select this box.
- **Set DNS Server manually:** Choose "Set DNS Server manually", you can set DNS Server manually here. The modem router will use this DNS Server for priority.
- **Get IPv6 Address with Unicast:** This is disabled by default. The minority of DHCPv6 Server of ISP will not support to enable this. When the modem router is connected right but cannot get IPv6 address, you can select this box.
- **Set IPv6 DNS Server manually:** Choose "Set IPv6 DNS Server manually", you can set IPv6 DNS Server manually here. The modem router will use this IPv6 DNS Server for priority.
- **Host Name:** Here displays model No. of your modem router.

Click the **Save** button to save the settings.

### 3) PPPoE

If your ISP provides a **PPPoE** connection and you need to use an ATM Interface, choose **PPPoE** in the drop-down list, and then the screen will be displayed as below.

WAN Settings	
DSL Modulation Type	DSL Modulation Type: <input type="text" value="VDSL"/>
PTM Configuration	Enable Vlan ID <input checked="" type="checkbox"/> VLAN ID (1-4094): <input type="text" value="1"/>
WAN Service Setup	Connection Type: <input type="text" value="PPPoE"/>  PPP Username: <input type="text"/> PPP Password: <input type="text"/> Confirm password: <input type="text"/>  Connection Mode: <input checked="" type="radio"/> Always on <input type="radio"/> Connect on demand <input type="radio"/> Connect manually Max Idle Time: <input type="text" value="15"/> minutes (0 means remain active at all time)  Authentication Type: <input type="text" value="AUTO_AUTH"/>  Enable IPv4: <input checked="" type="checkbox"/> Enable IPv6: <input type="checkbox"/>  Default Gateway: <input type="text" value="Current Connection"/>
	<div style="text-align: right;"><a href="#">Hide</a></div> Service Name: <input type="text"/> (do not change unless necessary) Server Name: <input type="text"/> (do not change unless necessary) MTU(Bytes): <input type="text" value="1480"/> (1480 as default, do not change unless necessary)  Enable Fullcone NAT: <input type="checkbox"/> Enable SPI Firewall: <input type="checkbox"/> Enable IGMP Proxy: <input checked="" type="checkbox"/> Use IP address specified by ISP: <input type="checkbox"/> Echo request interval: <input type="text" value="30"/> (0-120 seconds, 0 means no request) Set DNS server manually: <input type="checkbox"/>
	<input type="button" value="Save"/> <input type="button" value="Back"/>

Figure 4-7

- **PPP Username/Password/Confirm Password:** Enter the User Name, Password and Confirm Password provided by your ISP. These fields are case-sensitive.
- **Connection Mode:** For PPPoE connection, you can select **Always on** or **Connect on demand** or **Connect manually**. Connect on demand is dependent on the traffic. If there is no traffic (or **Idle**) for a pre-specified period of time, the connection will drop down automatically. And once there is traffic send or receive, the connection will be automatically on.
- **Authentication Type:** Select the **Authentication Type** from the drop-down list, the default method is **AUTO\_AUTH**, and you can leave it as a default setting.
- **Enable IPv4:** Check this box to enable IPv4.
- **Enable IPv6:** Check this box to enable IPv6.
- **Default Gateway:** Select a WAN connection from the drop-down list as the IPv4 default gateway.
- **IPv6 Default Gateway:** Select a WAN connection from the drop-down list as the IPv6 default gateway.

Click **Advance**, advanced selections for WAN Service Setup can be shown.

- **Service Name/Server Name:** Enter the Service Name and Server Name if it was provided by your ISP. You can leave them blank, if the ISP doesn't provide them.

- **MTU (bytes):** Maximum Transmission Unit Size. Check this box then you can change the MTU size. The default **MTU** value is 1500 Bytes. It is not recommended that you change the default value unless required by your ISP.
- **Enable Fullcone NAT:** It is a type of NAT, if not enabled, the default NAT will act.
- **Enable SPI Firewall:** A SPI firewall enhances network's security. Select the option to use a firewall, or else without a firewall.
- **Enable IGMP Proxy:** IGMP (Internet Group Management Protocol) is used to manage multicasting on TCP/IP networks. Some ISPs use IGMP to perform remote configuration for client devices, such as the modem router. The default value is disabled, and if you are not sure, please contact your ISP or just leave it.
- **Use IP address specified by ISP:** Choose "Use IP address specified by ISP", you can enter the IP address provided by your ISP.
- **Set DNS Server manually:** Choose "Set DNS Server manually", you can set DNS Server manually here. The modem router will use this DNS Server for priority.
- **Use IPv6 address specified by ISP:** Choose "Use IPv6 address specified by ISP", you can enter the IPv6 address provided by your ISP.
- **Set IPv6 DNS Server manually:** Choose "Set IPv6 DNS Server manually", you can set IPv6 DNS Server manually here. The modem router will use this IPv6 DNS Server for priority.

Click the **Save** button to save the settings.

#### 4) Bridge

If you select this type of connection, the modem router can be configured to act as a bridging device between your LAN and your ISP. Bridges are devices that enable two or more networks to communicate as if they are two segments of the same physical LAN.

**WAN Settings**

**ATM Configuration**

VPI (0-255): 8

VCI (1-65535): 35

Notice: Do not change the parameters below unless necessary! Hide

Encapsulation Mode: LLC

ATM QoS Type: UBR

PCR: 0 frames/s

SCR: frames/s

MBS: frames/s

**WAN Service Setup**

Connection Type: Bridge

Save Back

Figure 4-8

#### **Note:**

After you finishing the Internet configuration, please click **Save** to make the settings take effect.

### 4.5.1.2 ADSL WAN Settings

For **ADSL** mode, there are six different configurations for the connection types, which are Static IP, Dynamic IP, PPPoE, PPPoA, IPoA and Bridge. You can select the corresponding types according to your needs.

Name	Type	VPI/VCI or VID	IPv4	IPv6	IP/Mask	Gateway	DNS	Status	Connect	Action
<input type="button" value="Add"/> <input type="button" value="Refresh"/>										

Figure 4-9

Click **Add** to add a new entry, you can configure the parameters for PTM and WAN Service in the next screen (shown in Figure 4-10).

**DSL Modulation Type**  
DSL Modulation Type: ADSL

**ATM Configuration**  
VPI (0-255): 8  
VCI (1-65535): 35

**WAN Service Setup**  
Connection Type: PPPoE  
PPP Username:   
PPP Password:   
Confirm password:   
Connection Mode:  Always on  
 Connect on demand  
 Connect manually  
Max Idle Time: 15 minutes (0 means remain active at all time)  
Authentication Type: AUTO\_AUTH  
Enable IPv4:   
Enable IPv6:   
Default Gateway: Current Connection

Figure 4-10

DSL Modulation Type:

- **DSL Modulation Type:** The modem router supports two modulation types: ADSL and VDSL, you can select the corresponding types according to your needs.

ATM Configuration:

- **VPI (0~255):** Identifies the virtual path between endpoints in an ATM network. The valid range is from 0 to 255. Please input the value provided by your ISP.
- **VCI (1~65535):** Identifies the virtual channel endpoints in an ATM network. The valid range is from 1 to 65535 (1 to 31 is reserved for well-known protocols). Please input the value provided by your ISP.

## 1) Static IP

Select this option if your ISP provides static IP information to you. You should set static IP address, IP subnet mask, and gateway address in the screen below.

The screenshot shows the WAN Settings configuration page. It is divided into three main sections: DSL Modulation Type, ATM Configuration, and WAN Service Setup.

- DSL Modulation Type:** A dropdown menu is set to 'ADSL'.
- ATM Configuration:**
  - VPI (0-255): 8
  - VCI (1-65535): 35
  - Encapsulation Mode: LLC
  - ATM QoS Type: UBR
  - PCR: 0 frames/s
  - SCR: frames/s
  - MBS: frames/s
- WAN Service Setup:**
  - Connection Type: Static IP
  - Enable IPv4:
  - IP Address: 0.0.0.0
  - Subnet Mask: 0.0.0.0
  - Gateway: 0.0.0.0 (optional)
  - DNS Server: 0.0.0.0 (optional)
  - Secondary DNS Server: 0.0.0.0 (optional)
  - Enable IPv6:
  - Default Gateway: Current Connection
  - MTU(Bytes): 1500 (1500 as default, do not change unless necessary)
  - Enable NAT:
  - Enable Fullcone NAT:
  - Enable SPI Firewall:
  - Enable IGMP Proxy:

At the bottom of the page, there are 'Save' and 'Back' buttons.

Figure 4-11

Click **Advance**, advanced selections of ATM Configuration can be shown.

- **Encapsulation Mode:** Select the encapsulation mode for the Static IP Address. Here you can leave it default.
- **ATM Qos Type:** Select ATM Qos Type provided by ISP, and the type is UBR by default.

WAN Service Setup:

- **Enable IPv4:** Check the box to enable IPv4.
- **IP Address:** Enter the IP address in dotted-decimal notation provided by your ISP.
- **Subnet Mask:** Enter the subnet Mask in dotted-decimal notation provided by your ISP, usually is 255.255.255.0.
- **Default Gateway (Optional):** Enter the gateway IP address in dotted-decimal notation provided by your ISP.
- **DNS Server/ Secondary DNS Server:** Here you can set DNS Server (at least one) manually. The Route will use this DNS Server for priority.
- **Enable IPv6:** Check the box to enable IPv6.
- **IPv6 Address:** Enter the IPv6 address provided by your ISP.

- **Prefix Length:** Enter the prefix length of the IPv6 address. The default value is 64.
- **IPv6 Gateway:** Enter the gateway IPv6 address provided by your ISP.
- **IPv6 DNS Server / Secondary IPv6 DNS Server:** Here you can set IPv6 DNS Server (at least one) manually. The Route will use this IPv6 DNS Server for priority.
- **Default Gateway:** Select a WAN Interface from the drop-down list as the IPv4 default gateway.
- **IPv6 Default Gateway:** Select a WAN Interface from the drop-down list as the IPv6 default gateway.

Click **Advance**, advanced selections of WAN Service Setup can be shown.

- **MTU (bytes):** Maximum Transmission Unit Size. Check this box then you can change the MTU size. The default **MTU** value is 1500 Bytes. It is not recommended that you change the default value unless required by your ISP.
- **Enable NAT:** This technology translates the IP addresses of a local area network to a different IP address for the Internet. If this modem router is hosting your network's connection to the Internet, please select the check box. If another Router exists in your network, you don't need to select the option.
- **Enable Fullcone NAT:** It is a type of NAT, if not enabled, the default NAT will act.
- **Enable SPI Firewall:** A SPI firewall enhances network's security. Select the option to use a firewall, or else without a firewall.
- **Enable IGMP Proxy:** IGMP (Internet Group Management Protocol) is used to manage multicasting on TCP/IP networks. Some ISPs use IGMP to perform remote configuration for client devices, such as the modem router. The default value is disabled, and if you are not sure, please contact your ISP or just leave it.

Click the **Save** button to save the settings.

## 2) Dynamic IP

Select this option, the modem router will be able to obtain IP network information dynamically from a DHCP server provided by your ISP.

WAN Settings	
DSL Modulation Type	DSL Modulation Type: ADSL
<b>ATM Configuration</b> VPI (0-255): 8 VCI (1-65535): 35 Notice: Do not change the parameters below unless necessary!	
Encapsulation Mode:	LLC
ATM QoS Type:	UBR
PCR:	0 frames/s
SCR:	frames/s
MBS:	frames/s
<b>WAN Service Setup</b> Connection Type: Dynamic IP Enable IPv4: <input checked="" type="checkbox"/> IP Address: 0.0.0.0 Subnet Mask: 0.0.0.0 Gateway: 0.0.0.0 Enable IPv6: <input type="checkbox"/> Default Gateway: Current Connection MTU(Bytes): 1500 (1500 as default, do not change unless necessary) Enable NAT: <input checked="" type="checkbox"/> Enable Fullcone NAT: <input type="checkbox"/> Enable SPI Firewall: <input type="checkbox"/> Enable IGMP Proxy: <input checked="" type="checkbox"/> Get IP with Unicast: <input type="checkbox"/> (It is usually not required) Set DNS server manually: <input type="checkbox"/> Host Name: TD-W9980	
<input type="button" value="Save"/> <input type="button" value="Back"/>	

Figure 4-12

Click **Advance**, advanced selections for WAN Service Setup can be shown.

- **MTU (bytes):** Maximum Transmission Unit Size. Check this box then you can change the MTU size. The default **MTU** value is 1500 Bytes. It is not recommended that you change the default value unless required by your ISP.
- **Enable NAT:** This technology translates the IP addresses of a local area network to a different IP address for the Internet. If this modem router is hosting your network's connection to the Internet, please select the check box. If another Router exists in your network, you don't need to select the option.
- **Enable Fullcone NAT:** It is a type of NAT, if not enabled, the default NAT will act.
- **Enable SPI Firewall:** A SPI firewall enhances network's security. Select the option to use a firewall, or else without a firewall.
- **Enable IGMP Proxy:** IGMP (Internet Group Management Protocol) is used to manage multicasting on TCP/IP networks. Some ISPs use IGMP to perform remote configuration for client devices, such as the modem router. The default value is disabled, and if you are not sure, please contact your ISP or just leave it.
- **Get IP with Unicast:** This is disabled by default. The minority of DHCP Server of ISP will not support to enable this. When the Route is connected right but IP cannot get, you can select this box.

- **Set DNS Server manually:** Choose “Set DNS Server manually”, you can set DNS Server manually here. The modem router will use this DNS Server for priority.
- **Get IPv6 Address with Unicast:** This is disabled by default. The minority of DHCPv6 Server of ISP will not support to enable this. When the modem router is connected right but IPv6 address cannot get, you can select this box.
- **Set IPv6 DNS Server manually:** Choose “Set IPv6 DNS Server manually”, you can set IPv6 DNS Server manually here. The modem router will use this IPv6 DNS Server for priority.
- **Host Name:** Here displays model No. of your modem router.

Click the **Save** button to save the settings.

### 3) PPPoE

If your ISP provides a **PPPoE** connection and you need to use an ATM Interface, choose **PPPoE** in the drop-down list, and then the screen will be displayed as below.

WAN Settings

---

**DSL Modulation Type**

DSL Modulation Type: ADSL

---

**ATM Configuration**

VPI (0-255):

VCI (1-65535):

[Hide](#)

---

Notice: Do not change the parameters below unless necessary!

Encapsulation Mode: LLC

ATM QoS Type: UBR

PCR:  frames/s

SCR:  frames/s

MBS:  frames/s

---

**WAN Service Setup**

Connection Type: PPPoE

PPP Username:

PPP Password:

Confirm password:

Connection Mode:

Always on

Connect on demand

Connect manually

Max Idle Time: 15 minutes (0 means remain active at all time)

Authentication Type: AUTO\_AUTH

Enable IPv4:

Enable IPv6:

Default Gateway: Current Connection

---

Service Name:  (do not change unless necessary)

Server Name:  (do not change unless necessary)

MTU(Bytes):  (1480 as default, do not change unless necessary)

Enable Fullcone NAT:

Enable SPI Firewall:

Enable IGMP Proxy:

Use IP address specified by ISP:

Echo request interval:  (0-120 seconds, 0 means no request)

Set DNS server manually:

---

Figure 4-13



- **PPP Username/Password/Confirm Password:** Enter the User Name, Password and Confirm Password provided by your ISP. These fields are case-sensitive.
- **Connection Mode:** For PPPoE connection, you can select **Always on** or **Connect on demand** or **Connect manually**. Connect on demand is dependent on the traffic. If there is no traffic (or **Idle**) for a pre-specified period of time, the connection will tear down automatically. And once there is traffic send or receive, the connection will be automatically on.
- **Authentication Type:** Select the **Authentication Type** from the drop-down list, the default method is **AUTO\_AUTH**, and you can leave it as a default setting.
- **Enable IPv4:** Check this box to enable IPv4.
- **Enable IPv6:** Check this box to enable IPv6.
- **Default Gateway:** Select a WAN connection from the drop-down list as the IPv4 default gateway.
- **IPv6 Default Gateway:** Select a WAN connection from the drop-down list as the IPv6 default gateway.

Click **Advance**, advanced selections for WAN Service Setup can be shown.

- **Service Name/Server Name:** Enter the Service Name and Server Name if it was provided by your ISP. You can leave them blank, if the ISP doesn't provide them.
- **MTU (bytes):** Maximum Transmission Unit Size. Check this box then you can change the MTU size. The default **MTU** value is 1500 Bytes. It is not recommended that you change the default value unless required by your ISP.
- **Enable Fullcone NAT:** It is a type of NAT, if not enabled, the default NAT will act.
- **Enable SPI Firewall:** A SPI firewall enhances network's security. Select the option to use a firewall, or else without a firewall.
- **Enable IGMP Proxy:** IGMP (Internet Group Management Protocol) is used to manage multicasting on TCP/IP networks. Some ISPs use IGMP to perform remote configuration for client devices, such as the modem router. The default value is disabled, and if you are not sure, please contact your ISP or just leave it.
- **Use IP address specified by ISP:** Choose "Use IP address specified by ISP", you can enter the IP address provided by your ISP.
- **Set DNS Server manually:** Choose "Set DNS Server manually", you can set DNS Server manually here. The modem router will use this DNS Server for priority.
- **Use IPv6 address specified by ISP:** Choose "Use IPv6 address specified by ISP", you can enter the IPv6 address provided by your ISP.
- **Set IPv6 DNS Server manually:** Choose "Set IPv6 DNS Server manually", you can set IPv6 DNS Server manually here. The modem router will use this IPv6 DNS Server for priority.

Click the **Save** button to save the settings.

#### 4) PPPoA

If your ISP provides a **PPPoA** connection and you need to use an ATM Interface, choose **PPPoA** in the drop-down list, and then the screen will be displayed as below.

The configuration is similar to **PPPoE**. Please refer to the section **3) PPPoE** to configure this part.

WAN Settings	
<b>DSL Modulation Type</b>	DSL Modulation Type: ADSL
<b>ATM Configuration</b>	VPI (0-255): 8 VCI (1-65535): 35 Notice: Do not change the parameters below unless necessary! Encapsulation Mode: VC-Mux ATM QoS Type: UBR PCR: 0 frames/s SCR: frames/s MBS: frames/s
<b>WAN Service Setup</b>	Connection Type: PPPoA PPP Username: PPP Password: Confirm password: Connection Mode: <ul style="list-style-type: none"> <li><input checked="" type="radio"/> Always on</li> <li><input type="radio"/> Connect on demand</li> <li><input type="radio"/> Connect manually</li> </ul> Max Idle Time: 15 minutes (0 means remain active at all time) Authentication Type: AUTO_AUTH Default Gateway: Current Connection
	MTU(Bytes): 1480 (1480 as default, do not change unless necessary) Enable SPI Firewall: <input type="checkbox"/> Enable IGMP Proxy: <input checked="" type="checkbox"/> Use IP address specified by ISP: <input type="checkbox"/> Echo request interval: 30 (0-120 seconds, 0 means no request) Set DNS server manually: <input type="checkbox"/>
	<div style="text-align: right;"> <input type="button" value="Save"/> <input type="button" value="Back"/> </div>

Figure 4-14

## 5) IPoA

If your ISP provides an IPoA connection, select **IPoA** option for the **Connection Type** on the screen.

WAN Settings	
DSL Modulation Type	DSL Modulation Type: ADSL
ATM Configuration	VPI (0-255): 8 VCI (1-65535): 35 Notice: Do not change the parameters below unless necessary! Encapsulation Mode: LLC ATM QoS Type: UBR PCR: 0 frames/s SCR: frames/s MBS: frames/s
WAN Service Setup	Connection Type: IPv4A IP Address: 0.0.0.0 Subnet Mask: 0.0.0.0 Gateway: 0.0.0.0 DNS Server: 0.0.0.0 (optional) Secondary DNS Server: 0.0.0.0 (optional) Default Gateway: Current Connection MTU(Bytes): 1500 (1500 as default, do not change unless necessary) Enable NAT: <input checked="" type="checkbox"/> Enable SPI Firewall: <input type="checkbox"/> Enable IGMP Proxy: <input checked="" type="checkbox"/>
<input type="button" value="Save"/> <input type="button" value="Back"/>	

Figure 4-15

- **IP Address/Subnet Mask:** Enter the IP Address and Subnet Mask provided by ISP. If you forget, you can ask your ISP.
- **DNS Server/Secondary DNS Server:** Type in your preferred DNS server.
- **Default Gateway:** Select a WAN Interface from the drop-down list as the IPv4 default gateway.

## 6) Bridge

If you select this type of connection, the modem router can be configured to act as a bridging device between your LAN and your ISP. Bridges are devices that enable two or more networks to communicate as if they are two segments of the same physical LAN.

WAN Settings	
DSL Modulation Type	DSL Modulation Type: ADSL
ATM Configuration	VPI (0-255): 8 VCI (1-65535): 35 Notice: Do not change the parameters below unless necessary!
	Encapsulation Mode: LLC ATM QoS Type: UBR PCR: 0 frames/s SCR: frames/s MBS: frames/s
WAN Service Setup	Connection Type: Bridge
<input type="button" value="Save"/> <input type="button" value="Back"/>	

Figure 4-16

 **Note:**

After you finishing the Internet configuration, please click **Save** to make the settings take effect.

## 4.5.2 Interface Grouping

Choose “**Network**”→“**Interface Grouping**”, you can view all the current groups on this page (shown in Figure 4-17).

Interface Grouping			
This page displays all the current groups.			
Group	Delete	WAN Interface	LAN Interface
Default			LAN4
			LAN3
			LAN2
			LAN1
			Wi-Fi_2.4G
			Wi-Fi_5G
<input type="button" value="Add"/>			
<input checked="" type="checkbox"/> Enable the Virtual LAN Ports feature Note: It is not allowed to disable the VLAN with Ethernet WAN Connection enabled.			

Figure 4-17

- **Enable the Virtual LAN Ports feature:** Virtual LAN (VLAN) is a group of devices on one or more LANs that are configured so that they can communicate as if they were attached to the same LAN. Because VLANs are based on logical instead of physical connections, it is very flexible for user/host management, bandwidth allocation and resource optimization. If you want to active Interface Grouping function, please check the box to enable the Virtual LAN Ports feature.

 **Note:**

It is not allowed to disable the VLAN with Ethernet Connection enabled.

To support this feature, you must create mapping groups with appropriate LAN and WAN interfaces using the **Add** button. The **Remove** button will remove the grouping and add the ungrouped interfaces to the Default group. Only the default group has IP interface.

Click the **Add** button. You can add a new interface group in the next screen. For example, you want LAN1 and LAN3 to be a group called Group 1 over br\_ptm\_1\_0 WAN interface, you can refer to the following figure.

The screenshot shows the 'Add New Group' configuration interface. At the top, the 'Group Name' field is set to 'Group1'. Below this, there are two columns: 'Available LAN' and 'Added Interface'. The 'Available LAN' list contains 'Wi-Fi\_2.4G', 'Wi-Fi\_5G', 'LAN4', and 'LAN2'. The 'Added Interface' list contains 'LAN1', 'LAN3', and 'br\_ptm\_1\_0'. Between the columns are two buttons: '>' and '<'. At the bottom, there are two buttons: 'Save' and 'Back'.

Figure 4-18

Click **Save** to make the entry effective immediately

### 4.5.3 LAN Settings

Choose “**Network**”→“**LAN Settings**” menu, and you will see the LAN screen (shown in Figure 4-19). Please configure the parameters for LAN ports according to the descriptions below.

LAN Settings

Note: If the LAN IP address or subnet mask is changed, please make sure the DHCP Address Pool and the static IP assigned by DHCP Server are in the same subnet with the new LAN IP.

<b>Group:</b>	Default	
<b>IP Address:</b>	<input type="text" value="192.168.1.1"/>	
<b>Subnet Mask:</b>	<input type="text" value="255.255.255.0"/>	
<b>Enable IGMP Snooping:</b>	<input checked="" type="checkbox"/>	
<b>Enable Second IP:</b>	<input type="checkbox"/>	
<b>DHCP Server:</b>	<input type="radio"/> Disable <input checked="" type="radio"/> Enable <input type="radio"/> DHCP Relay	
<b>Start IP Address:</b>	<input type="text" value="192.168.1.100"/>	
<b>End IP Address:</b>	<input type="text" value="192.168.1.199"/>	
<b>Leased Time:</b>	<input type="text" value="1440"/> minutes (1~2880 minutes, the default value is 1440)	
<b>Gateway:</b>	<input type="text" value="192.168.1.1"/>	(optional)
<b>Default Domain:</b>	<input type="text"/>	(optional)
<b>DNS Server:</b>	<input type="text" value="0.0.0.0"/>	(optional)
<b>Secondary DNS Server:</b>	<input type="text" value="0.0.0.0"/>	(optional)

Figure 4-19

- **IP Address:** You can configure the modem router's IP Address and Subnet Mask for LAN Interface.
  - **IP Address:** Enter the modem router's local IP Address, then you can access to the Web-based management page via the IP Address, the default value is 192.168.1.1.
  - **Subnet Mask:** Enter the modem router's Subnet Mask, the default value is 255.255.255.0.
- **Enable IGMP Snooping:** If you select the option, please choose the IGMP Mode: Standard Mode or Blocking Mode.
- **Enable Second IP:** You can configure the modem router's second IP Address and Subnet Mask for LAN Interface through which you can also access to the Web-based management page as the default IP Address and Subnet Mask.
- **DHCP Server:** These settings allow you to configure the modem router's Dynamic Host Configuration Protocol (DHCP) server function. The DHCP server is enabled by default for the modem router's Ethernet LAN interface. DHCP service will supply IP settings to computers which are configured to automatically obtain IP settings that are connected to the modem router though the Ethernet port. When the modem router is set for DHCP, it becomes the default gateway for DHCP client connected to it. Keep in mind that if you change the IP address of the modem router, you must change the range of IP addresses in the pool used for DHCP on the LAN.
  - **Start IP Address:** Enter a value for the DHCP server to start with when issuing IP addresses. Because the default IP address for the modem router is 192.168.1.1, the default Start IP Address is **192.168.1.100**, and the Start IP Address must be 192.168.1.100 or greater, but smaller than 192.168.1.254.

- **End IP Address:** Enter a value for the DHCP server to end with when issuing IP addresses. The End IP Address must be smaller than 192.168.1.254. The default End IP Address is **192.168.1.254**.
- **Leased Time:** The Leased Time is the amount of time in which a network user will be allowed connection to the modem router with their current dynamic IP address. Enter the amount of time, in hours, then the user will be “leased” this dynamic IP address. After the dynamic IP address has expired, the user will be automatically assigned a new dynamic IP address. The default is **1440** minutes.

The detailed configuration about DHCP server, please refer to section [4.6 DHCP Server](#).

#### 4.5.4 IPv6 LAN Settings

Choose menu “**Network**”→“**IPv6 LAN Settings**”, you can configure LAN IPv6 interface for your modem router.

Figure 4-20

➤ **Address Autoconfiguration Type:** Select a type to assign IPv6 addresses to the computers in your LAN. RADVD and DHCPv6 Server are provided.

- 1) If RADVD is selected, it doesn't need to be configured.
- 2) If DHCPv6 Server is selected, please complete the following parameters.

Figure 4-21

- **Start IPv6 Address:** Enter a value for the DHCPv6 server to start with when issuing IPv6 addresses.
- **End IPv6 Address:** Enter a value for the DHCPv6 server to end with when issuing IPv6 addresses.

- **Leased Time:** The Leased Time is the amount of time in which a network user will be allowed connection to the modem router with their current dynamic IPv6 address. Enter the amount of time, in hours, then the user will be “leased” this dynamic IPv6 address. After the dynamic IPv6 address has expired, the user will be automatically assigned a new dynamic IPv6 address. The default is 86400 seconds.
- **Site Prefix Configuration Type:** Select a type to assign prefix to IPv6 addresses. Delegated and Static are provided.
- 1) If Delegated is selected, please complete the following parameters.

**Site Prefix Configuration Type:**  Delegated  Static

**Prefix Delegated WAN Connection:** No available interface. ▾

Figure 4-22

- **Prefix Delegated WAN Connection:** Select a WAN connection form the drop-down list to assign prefix.
- 2) If Static is selected, please complete the following parameters.

**Site Prefix Configuration Type:**  Delegated  Static

**Site Prefix:**

**Site Prefix Length:**

Figure 4-23

- **Site Prefix:** Enter a value for the site prefix.
- **Site Prefix Length:** Enter a value for the site prefix length.

Click the **Save** button to save the settings.

#### 4.5.5 MAC Clone

Choose menu “**Network**”→“**MAC Clone**”, you can configure the MAC address of the WAN Interface as shown below.

The WAN Interface List displays the WAN Interfaces you have configured on the section [4.5.1 WAN Settings](#) and its default MAC Address. You can select corresponding WAN Interface from the drop-down list and click **Clone MAC To** button to clone your current PC MAC, and then click **Save**.

WAN Connection	MAC Address	Operation
Current PC's MAC	40:61:86:FC:74:93	Clone MAC To ▾

Note:

1. MAC clone may cause reconnection.
2. After MAC Clone, the bridge connections sharing the same VPI/VCI with other connections may not work.

**Save**

Figure 4-24



 **Note:**

Only the WAN Ports can use MAC Address Clone function. All the clone MAC addresses must not be the same with each other.

#### 4.5.6 ALG Settings

Choose menu “**Network**”→“**ALG Settings**”, and then you can configure the basic security in the screen as shown in Figure 4-25.

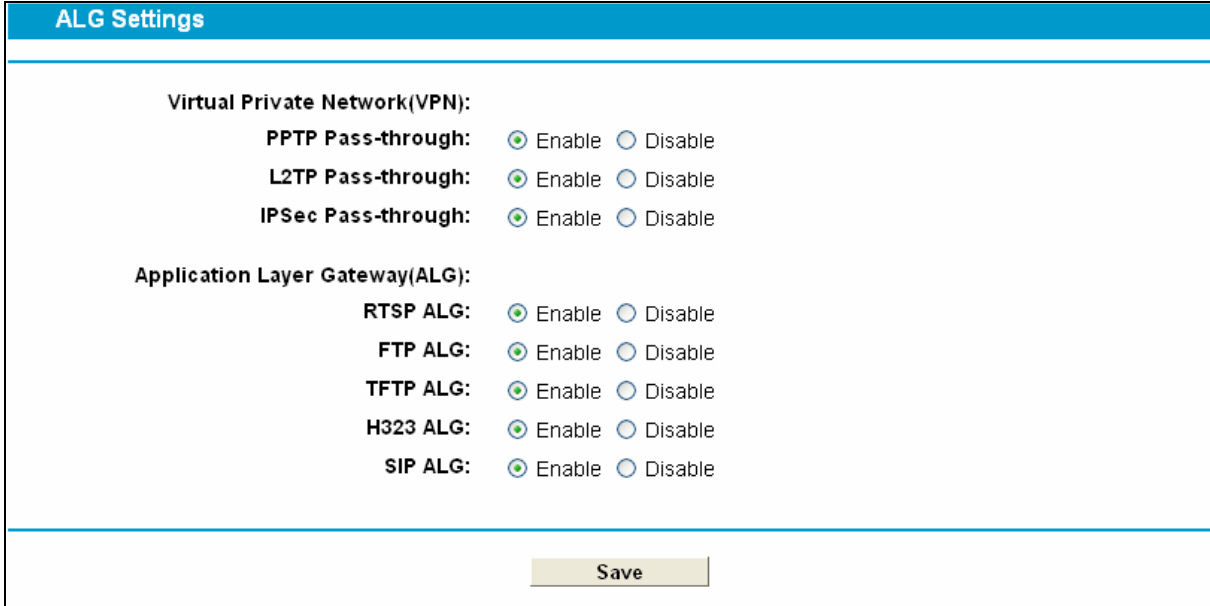

Figure 4-25

- **Virtual Private Network (VPN):** VPN Passthrough must be enabled if you want to allow VPN tunnels using VPN protocols to pass through the modem router.
  - **PPTP Passthrough:** Point-to-Point Tunneling Protocol (PPTP) allows the Point-to-Point Protocol (PPP) to be tunneled through an IP network. To allow PPTP tunnels to pass through the modem router, click **Enable**.
  - **L2TP Passthrough:** Layer Two Tunneling Protocol (L2TP) is the method used to enable Point-to-Point sessions via the Internet on the Layer Two level. To allow L2TP tunnels to pass through the modem router, click **Enable**.
  - **IPSec Passthrough:** Internet Protocol security (IPSec) is a suite of protocols for ensuring private, secure communications over Internet Protocol (IP) networks, through the use of cryptographic security services. To allow IPSec tunnels to pass through the modem router, click **Enable**.
  
- **Application Layer Gateway (ALG):** It is recommended to enable Application Layer Gateway (ALG) because ALG allows customized Network Address Translation (NAT) traversal filters to be plugged into the gateway to support address and port translation for certain application layer "control/data" protocols such as FTP, TFTP etc.
  - **FTP ALG:** To allow FTP clients and servers to transfer data across NAT, click **Enable**.
  - **TFTP ALG:** To allow TFTP clients and servers to transfer data across NAT, click **Enable**.

- **H323 ALG:** To allow H323 clients and servers to transfer data across NAT, click **Enable**.
- **SIP ALG:** To allow SIP clients and servers to transfer data across NAT, click **Enable**.

Click the **Save** button to save your settings.

#### 4.5.7 DSL Settings

Choose “**Advanced Setup**”→“**DSL Settings**”, you can select the DSL Modulation Type and Annex Type in the next screen. The DSL feature can be selected when you meet the physical connection problem. Please check the proper settings with your Internet service provider.

Figure 4-26

- **DSL Modulation Type:** Select the DSL operation Modulation Type which your DSL connection uses.
- **Annex Type:** Select the DSL operation Annex Type which your DSL connection uses.

Click the **Save** button to save your settings.

#### 4.5.8 IPSec VPN

Choose “**Network**”→“**IPSec VPN**”, you can Add/Remove or Enable/Disable the IPSec tunnel connections on the screen as shown in Figure 4-27.

Figure 4-27

This section will guide you to configure a VPN tunnel between two TD-W9980s. The topology is as follows.

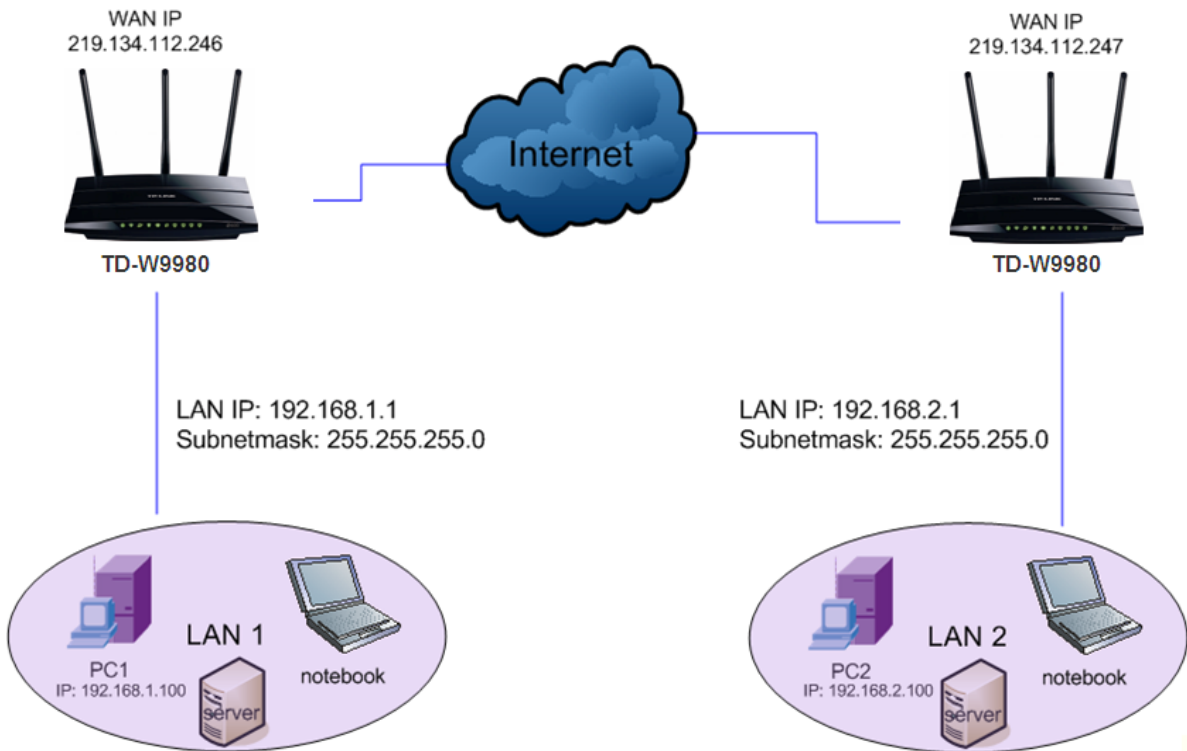

 **Note:**

You could also use other VPN Routers to set VPN tunnels with TD-W9980. TD-W9980 supports up to 10 VPN tunnels simultaneously.

Click **Add New Connection** in Figure 4-27 and then you will enter the screen shown in Figure 4-28.

IPSec Settings	
IPSec Connection Name:	Connection name
Remote IPsec Gateway Address(URL):	0.0.0.0
Tunnel access from local IP addresses:	Subnet
IP Address for VPN:	0.0.0.0
IP Subnetmask:	255.255.255.0
Tunnel access from remote IP addresses:	Subnet
IP Address for VPN:	0.0.0.0
IP Subnetmask:	255.255.255.0
Key Exchange Method:	Auto(IKE)
Authentication Method:	Pre-Shared Key
Pre-Shared Key:	psk_key
Perfect Forward Secrecy:	Enable
<a href="#">Show Advanced Settings</a>	
<a href="#">Save/Apply</a>	

Figure 4-28

- **IPSec Connection Name:** Enter a name for your VPN.
- **Remote IPsec Gateway Address (URL):** Enter the destination gateway IP address in the box which is the public WAN IP or Domain Name of the remote VPN server endpoint. (For example: Input **219.134.112.247** in **Device1**, Input **219.134.112.246** in **Device 2**)

- **Tunnel access from local IP addresses:** Choose Subnet if you want the Whole LAN to join the VPN network, or else choose Single Address if you want single IP to join the VPN network.
- **IP Address for VPN:** Enter the IP address of your LAN. (For example: Input **192.168.1.1** in **Device1**, Input **192.168.2.1** in **Device2**)
- **IP Subnetmask:** Enter the Subnet mask of your LAN. ( For example: Input **255.255.255.0** in both **Device1** and **Device2**)
- **Tunnel access from remote IP addresses:** Choose Subnet if you want the Remote Whole LAN to join the VPN network, or else choose Single Address if you want single IP to join the VPN network.
- **IP Address for VPN:** Enter the IP address of the Remote LAN. ( For example: Input **192.168.2.1** in **Device1**, Input **192.168.1.1** in **Device2**)
- **IP Subnetmask:** Enter the subnetmask of the remote LAN. ( For example: Input **255.255.255.0** in both **Device1** and **Device2**)
- **Key Exchange Method:** Select Auto (IKE) or Manual.
- **Authentication Method:** Select Pre-Shared Key (recommended).
- **Pre-Shared Key:** Input the Pre-Shared key for Authentication. (For example: Input 12345678)
- **Perfect Forward Secrecy:** PFS is an additional security protocol.

**We recommend you leave the Advanced Settings as default value.**

After complete the basic settings and click Save/Apply in both **Device1** and **Device2**, PCs in LAN1 could communicate with PCs in remote LAN2. (For example: You can ping the IP address of PC2 which is 192.168.2.100 in PC1)

 **Note:**

The VPN Servers Endpoint from both ends must use the same pre-shared keys and Perfect Forward Secrecy settings.

Click **Show Advanced Settings** and then you can configure the Advanced Settings.

Hide Advanced Settings

**==Phase 1==**

**Mode:**

**My Identifier Type:**

**My Identifier:**

**Remote Identifier Type:**

**Remote Identifier:**

**Encryption Algorithm:**

**Integrity Algorithm:**

**Select Diffie-Hellman Group for Key Exchange:**

**Key Life Time:(Seconds)**

**==Phase 2==**

**Encryption Algorithm:**

**Integrity Algorithm:**

**Select Diffie-Hellman Group for Key Exchange:**

**Key Life Time:(Seconds)**

Figure 4-29

- **Mode:** Select Main Mode to configure the standard negotiation parameters for IKE phase1.
- **Aggressive Mode:** Select Aggressive Mode to configure IKE phase1 of the VPN Tunnel to carry out negotiation in a shorter amount of time. (Not Recommended-Less Secure)

 **Note:**

The difference between the two is that aggressive mode will pass more information in fewer packets, with the benefit of slightly faster connection establishment, at the cost of transmitting the identities of the security firewall in the clear. When using aggressive mode, some configuration parameters such as Diffie-Hellman groups, and PFS can not be negotiated, resulting in a greater importance of having "compatible" configuration on both ends.

- **Key Life Time:** Enter the number of seconds for the IPSec lifetime. It is the period of time to pass before establishing a new IPSec security association (SA) with the remote endpoint. The default value is 3600.

 **Note:**

If you want to change the default settings of **Advanced Settings**, please make sure that both VPN server endpoints use the same Encryption Algorithm, Integrity Algorithm, Diffie-Hellman Group and Key Life time in both **phase1** and **phase2**.

## 4.6 DHCP Server

Choose "DHCP Server", you can see the next submenus:

<b>DHCP Server</b>
DHCP Settings
Clients List
Address Reservation
Conditional Pool

Click any of them, and you will be able to configure the corresponding function.

#### 4.6.1 DHCP Settings

Choose menu “**DHCP Server**”→“**DHCP Settings**”, you can configure the DHCP Server on the page as shown in Figure 4-30. The modem router is set up by default as a DHCP (Dynamic Host Configuration Protocol) server, which provides the TCP/IP configuration for all the PC(s) that are connected to the modem router on the LAN.

DHCP Settings

This page allows you to set DHCP server which provides TCP/IP configuration for all the PCs connected to the Modern Router in the LAN.

<b>Groups:</b>	Default
<b>IP Address:</b>	192.168.1.1
<b>Subnet Mask:</b>	255.255.255.0
<b>DHCP Server:</b>	<input type="radio"/> Disable <input checked="" type="radio"/> Enable <input type="radio"/> DHCP Relay

<b>Start IP Address:</b>	<input type="text" value="192.168.1.100"/>
<b>End IP Address:</b>	<input type="text" value="192.168.1.199"/>
<b>Address Lease Time:</b>	<input type="text" value="1440"/> minutes (1~2880 minutes, the default value is 120)
<b>Default Gateway:</b>	<input type="text" value="192.168.1.1"/> (optional)
<b>Default Domain:</b>	<input type="text"/> (optional)
<b>Primary DNS:</b>	<input type="text" value="0.0.0.0"/> (optional)
<b>Secondary DNS:</b>	<input type="text" value="0.0.0.0"/> (optional)

Figure 4-30

- **Start IP Address:** Enter a value for the DHCP server to start with when issuing IP addresses. Because the default IP address for the modem router is 192.168.1.1, the default Start IP Address is **192.168.1.100**, and the Start IP Address must be 192.168.1.100 or greater, but smaller than 192.168.1.254.
- **End IP Address:** Enter a value for the DHCP server to end with when issuing IP addresses. The End IP Address must be smaller than 192.168.1.254. The default End IP Address is **192.168.1.254**.
- **Address Lease Time:** The Leased Time is the amount of time in which a network user will be allowed connection to the modem router with their current dynamic IP address. Enter the amount of time, in hours, then the user will be “leased” this dynamic IP address. After the dynamic IP address has expired, the user will be automatically assigned a new dynamic IP address. The default is **24** hours.
- **Default Gateway** - (Optional.) It is suggested to input the IP address of the LAN port of the modem router. The default value is 192.168.1.1.
- **Default Domain** - (Optional.) Input the domain name of your network.
- **Primary DNS** - (Optional.) Input the DNS IP address provided by your ISP or consult your ISP.

- **Secondary DNS** - (Optional.) Input the IP address of another DNS server if your ISP provides two DNS servers.
- **DHCP Relay:** Select **Relay**, then you will see the next screen, and the modem router will work as a DHCP Relay. A DHCP relay is a computer that forwards DHCP data between computers that request IP addresses and the DHCP server that assigns the addresses. Each of the device's interfaces can be configured as a DHCP relay. If it is enabled, the DHCP requests from local PCs will forward to the DHCP server runs on WAN side. To have this function working properly, please run on router mode only, disable the DHCP server on the LAN port, and make sure the routing table has the correct routing entry.

<b>Groups:</b>	Default
<b>IP Address:</b>	192.168.1.1
<b>Subnet Mask:</b>	255.255.255.0
<b>DHCP Server:</b>	<input type="radio"/> Disable <input type="radio"/> Enable <input checked="" type="radio"/> DHCP Relay
<b>Remote Server's IP Address:</b>	<input type="text" value="0.0.0.0"/>
<small>Note: You have to disable NAT of the WAN connections. Or the DHCP Relay may not take effect!</small>	
<input type="button" value="Save"/>	

 **Note:**

- 1) To use the DHCP server function of the modem router, you must configure all computers on the LAN as "Obtain an IP Address automatically".
- 2) You have to disable NAT of the WAN connections, or the DHCP Relay may not take effect.
- 3) If you select **Disabled**, the DHCP function will not take effect.

Click the **Save** button to save your settings.

#### 4.6.2 Clients List

Choose menu "**DHCP Server**"→"**Clients List**", you can view the information about the clients attached to the modem router in the screen as shown in Figure 4-31.

DHCP Clients List				
This page displays the information of DHCP clients.				
ID	Client Name	MAC Address	IP Address	Valid Time
1	tplink13488	40:61:86:E5:B2:DC	192.168.1.100	23:42:05
<input type="button" value="Refresh"/>				

Figure 4-31

- **Client Name:** The name of the DHCP client
- **MAC Address:** The MAC address of the DHCP client
- **IP Address:** The IP address that the modem router has allocated to the DHCP client
- **Valid Time:** The time of the DHCP client leased. After the dynamic IP address has expired, a new dynamic IP address will be automatically assigned to the user.

To update this page and to show the current wireless devices, click the **Refresh** button.

#### 4.6.3 Address Reservation

Choose menu "**DHCP Server**"→"**Address Reservation**", you can view and add a reserved address for clients via the next screen (shown in Figure 4-32).When you specify a reserved IP address for a PC on the LAN, that PC will always receive the same IP address each time when it

accesses the DHCP server. Reserved IP addresses should be assigned to the servers that require permanent IP settings.

DHCP Address Reservation					
This page displays the static IP assigned by DHCP Server and allows you to configure it by clicking corresponding buttons.					
<input type="checkbox"/>	MAC Address	IP Address	Group	Status	Edit
<input type="checkbox"/>	40:61:86:FC:6F:22	192.168.1.100	Default	Disabled	<a href="#">Edit</a>
<input type="button" value="Add New"/>		<input type="button" value="Enable Selected"/>		<input type="button" value="Disable Selected"/>	
<input type="button" value="Refresh"/>					

Figure 4-32

- **MAC Address:** The MAC address of the PC for which you want to reserve an IP address.
- **IP Address:** The IP address reserved for the PC by the modem router.
- **Status:** The status of this entry either **Enabled** or **Disabled**.

#### To Reserve an IP address:

1. Click the **Add New** button. Then Figure 4-33 will pop up.
2. Enter the MAC address (in XX:XX:XX:XX:XX:XX format.) and IP address (in dotted-decimal notation) of the computer for which you want to reserve an IP address.
3. Click the **Save** button.

DHCP Address Reservation	
The static IP of DHCP Server can be set on this page.	
MAC Address:	<input type="text"/>
IP Address:	<input type="text"/>
Groups:	<input type="text" value="Default"/>
Status:	<input type="text" value="Disabled"/>
<input type="button" value="Save"/> <input type="button" value="Back"/>	

Figure 4-33

#### To modify or delete an existing entry:

1. Click the **Edit** in the entry you want to modify. If you want to delete the entry, click the **Delete**.
2. Modify the information.
3. Click the **Save** button.

Click the **Enable/Disable Selected** button to make selected entries enabled/disabled.

Click the **Delete Selected** button to selected entries.

#### 4.6.4 Conditional Pool

Choose menu “**DHCP Server**”→“**Conditional Pool**”, you can see the next screen (shown in Figure 4-34). This page displays vendor class settings and allows you to set parameters for vendor class by clicking corresponding buttons.



DHCP Conditional Pool						
This page displays vendor class settings and allows you to set parameters for vendor class by clicking corresponding buttons.						
<input type="checkbox"/>	Vendor ID	Start IP Address/ End IP Address	Facility	Groups	Status	Edit
<input type="button" value="Add New"/>		<input type="button" value="Enable Selected"/>		<input type="button" value="Disable Selected"/>		<input type="button" value="Delete Selected"/>
<input type="button" value="Refresh"/>						

Figure 4-34

**To add a vendor class:**

1. Click the **Add New** button. Then Figure 4-35 will pop up.
2. Enter parameters for the vendor class.

Click the **Save** button.

DHCP Conditional Pool	
The vendor class IP range can be set on this page.	
Facility:	<input type="text"/>
Vendor ID:	<input type="text"/>
Start IP Address:	<input type="text"/>
End IP Address:	<input type="text"/>
Default Gateway:	<input type="text"/>
Device Type:	<input type="text" value="PC"/>
Add Option:	<input type="text" value="Option 241"/>
Option Value:	<input type="text"/>
Groups:	<input type="text" value="Default"/>
Status:	<input type="text" value="Disabled"/>
<input type="button" value="Save"/> <input type="button" value="Back"/>	

Figure 4-35

**To modify or delete an existing entry:**

4. Click the **Edit** in the entry you want to modify. If you want to delete the entry, click the **Delete**.
5. Modify the information.
6. Click the **Save** button.

Click the **Enable/Disable Selected** button to make selected entries enabled/disabled.

Click the **Delete Selected** button to selected entries.

## 4.7 Dual Band Selection

Choose menu “**Dual Band Selection**”, and you can choose the working frequency for your modem router. It is recommended that your computers and devices running video and voice applications use the 5GHz band, while your guest access and computers that are only browsing the web use the 2.4GHz band.

Dual Band Selection
<p>The wireless working band can be configured on this page.</p> <p>Note: To turn OFF the wireless radio, you can switch the Wireless On/Off button located on the back panel of the device to the OFF position.</p> <p> <input checked="" type="radio"/> <b>Concurrently with 2.4GHz and 5GHz band (802.11a/b/g/n)</b>  <input type="radio"/> <b>Only work in 2.4GHz band (802.11b/g/n)</b>  <input type="radio"/> <b>Only work in 5GHz band (802.11a/n)</b> </p>
<input type="button" value="Save"/>

Figure 4-36

- **Concurrently with 2.4GHz and 5GHz (802.11a/b/g/n):** Choose this option, and then the modem router will work concurrently in 2.4GHz and 5GHz frequency.
- **Only work in 2.4GHz band (802.11b/g/n):** Choose this option, and then the modem router will only work in 2.4GHz frequency. You can use the 2.4GHz band to connect to many classic wireless devices like gaming consoles, laptops, DVRs, ect.
- **Only work in 5GHz band (802.11a/n):** Choose this option, and then the modem router will only work in 5GHz frequency. This band is less crowded and is used for time-sensitive music, video streaming or gaming. Using this band can avoid interference with 2.4GHz networks or noisy devices like cordless phones and microwave ovens.

## 4.8 Wireless 2.4GHz

<b>Wireless 2.4GHz</b>
<b>Basic Settings</b>
<b>WPS Settings</b>
<b>Wireless Security</b>
<b>Wireless MAC Filtering</b>
<b>Wireless Advanced</b>
<b>Wireless Status</b>

There are six submenus under the Wireless menu: **Basic Settings**, **WPS Settings**, **Wireless Security**, **Wireless MAC Filtering**, **Wireless Advanced** and **Wireless Status**. Click any of them, and you will be able to configure the corresponding function.

### 4.8.1 Basic Settings

Choose menu "**Wireless 2.4GHz**" → "**Basic Settings**", you can configure the basic settings for the wireless network of 2.4GHz on this page.

Figure 4-37

- **SSID:** Wireless network name shared among all points in a wireless network. The SSID must be identical for all devices in the wireless network. It is case-sensitive and must not exceed 32 characters (use any of the characters on the keyboard). Make sure this setting is the same for all stations in your wireless network. Type the desired SSID in the space provided. The default SSID is set to be TP-LINK\_2.4GHz\_XXXXXX.
- **Region:** Select your region from the drop-down list. This field specifies the region where the wireless function of the modem router can be used. It may be illegal to use the wireless function of the modem router in a region other than one of those specified in this field. If your country or region is not listed, please contact your local government agency for assistance.

 **Note:**

Limited by local law regulations, version for North America does not have region selection option.

- **Mode:** Select the desired mode.
  - 11b only:** Select if all of your wireless clients are 802.11b.
  - 11g only:** Select if all of your wireless clients are 802.11g.
  - 11n only:** Select only if all of your wireless clients are 802.11n.
  - 11bg mixed:** Select if you are using both 802.11b and 802.11g wireless clients.
  - 11bgn mixed:** Select if you are using a mix of 802.11b, 11g, and 11n wireless clients.

Select the desired wireless mode. When 802.11g mode is selected, only 802.11g wireless stations can be connected to the modem router. When 802.11n mode is selected, only 802.11n wireless stations can connect to the modem router. It is strongly recommended that you set the Mode to **802.11b&g&n**, and all of 802.11b, 802.11g, and 802.11n wireless stations can connect to the modem router.
- **Channel:** Select the channel you want to use from the drop-down List of Channel. This field determines which operating frequency will be used. It is not necessary to change the wireless channel unless you notice interference problems with another nearby access point.
- **Channel Width:** Select the channel width from the drop-down list. The default setting is automatic, which can adjust the channel width for your clients automatically.

 **Note:**

If **11b only**, **11g only**, or **11bg mixed** is selected in the **Mode** field, the **Channel Width** selecting field will turn grey and the value will become 20M, which is unable to be changed.

- **Enable SSID Broadcast:** When wireless clients survey the local area for wireless networks to associate with, they will detect the SSID broadcast by the modem router. If you select the **Enable SSID Broadcast** checkbox, the Wireless Router will broadcast its name (SSID) on the air.
- **Enable WDS:** Check this box to enable WDS. With this function, the modem router can bridge two or more Wlans. If this checkbox is selected, you will have to set the following parameters as shown in the figure below. Make sure the following settings are correct.

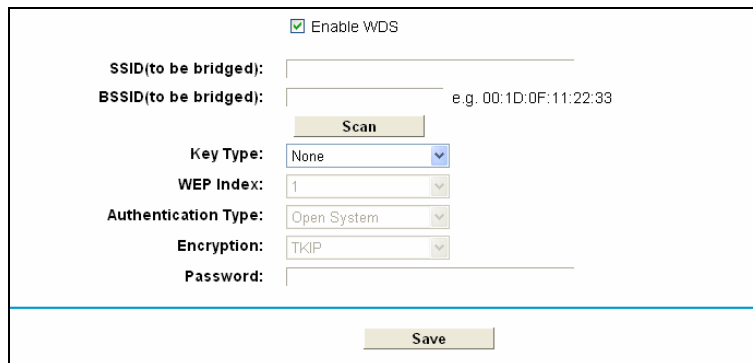

Enable WDS  
 SSID(to be bridged):   
 BSSID(to be bridged):  e.g. 00:1D:0F:11:22:33  
  
 Key Type:   
 WEP Index:   
 Authentication Type:   
 Encryption:   
 Password:

- **SSID (to be bridged):** The SSID of the AP your modem router is going to connect to as a client. You can also use the search function to select the SSID to join.
- **BSSID (to be bridged):** The BSSID of the AP your modem router is going to connect to as a client. You can also use the search function to select the BSSID to join.
- **Scan:** Click this button, you can search the AP which runs in the current channel.
- **Key type:** This option should be chosen according to the AP's security configuration. It is recommended that the security type is the same as your AP's security type
- **WEP Index:** This option should be chosen if the key type is WEP(ASCII) or WEP(HEX). It indicates the index of the WEP key.
- **Auth Type:** This option should be chosen if the key type is WEP(ASCII) or WEP(HEX). It indicates the authorization type of the Root AP.
- **Password:** If the AP your modem router is going to connect needs password, you need to fill the password in this blank.

Click **Save** to save your settings.

## 4.8.2 WPS Settings

This section will guide you to add a new wireless device to an existing network quickly by **WPS** (also called **QSS**) function.

- a). Choose menu "**WPS Settings**", and you will see the next screen (shown in Figure 4-38).

WPS Settings	
WPS:	Enabled <input type="button" value="Disable"/>
Current PIN:	12345670 <input type="button" value="Restore PIN"/> <input type="button" value="Generate New PIN"/>
	<input type="checkbox"/> Disable Modem Router's PIN
Add a new device:	<input type="button" value="Add device"/>

Figure 4-38

- **WPS:** Enable or disable the WPS function here.
- **Current PIN:** The current value of the modem router's PIN is displayed here. The default PIN of the modem router can be found in the label or User Guide.
- **Restore PIN:** Restore the PIN of the modem router to its default.
- **Gen New PIN:** Click this button, and then you can get a new random value for the modem router's PIN. You can ensure the network security by generating a new PIN.
- **Add device:** You can add a new device to the existing network manually by clicking this button.

b). To add a new device:

If the wireless adapter supports Wi-Fi Protected Setup (WPS), you can establish a wireless connection between wireless adapter and modem router using either Push Button Configuration (PBC) method or PIN method.

#### Note:

To build a successful connection by WPS, you should also do the corresponding configuration of the new device for WPS function meanwhile.

#### I. Use the Wi-Fi Protected Setup Button

Use this method if your client device has a Wi-Fi Protected Setup button.

**Step 1:** Press the WPS button on the back panel of the modem router, as shown in the following figure.



You can also keep the default WPS Status as **Enabled** and click the **Add device** button in Figure 4-38, then Choose “**Press the button of the new device in two minutes**” and click **Connect**. (Shown in the following figure)

WPS Settings	
<input type="radio"/>	Enter the new device's PIN. PIN: <input type="text"/>
<input checked="" type="radio"/>	Press the button of the new device in two minutes.
<input type="button" value="Connect"/> <input type="button" value="Back"/>	

Figure 4-39

**Step 2:** Press and hold the WPS button of the client device directly.

**Step 3:** The Wi-Fi Protected Setup LED flashes for two minutes during the Wi-Fi Protected Setup process.

**Step 4:** When the WPS LED is on, the client device has successfully connected to the modem router.

Refer back to your client device or its documentation for further instructions.

## II. Enter the client device's PIN on the modem router

Use this method if your client device has a Wi-Fi Protected Setup PIN number.

**Step 1:** Keep the default WPS Status as **Enabled** and click the **Add device** button in Figure 4-38, then the following screen will appear.

Figure 4-40

**Step 2:** Enter the PIN number from the client device in the field on the above WPS screen. Then click **Connect** button.

**Step 3:** “**Connect successfully**” will appear on the screen of Figure 4-40, which means the client device has successfully connected to the modem router.

## III. Enter the modem router's PIN on your client device

Use this method if your client device asks for the modem router's PIN number.

**Step 1:** On the client device, enter the PIN number listed on the modem router's Wi-Fi Protected Setup screen. (It is also labeled on the bottom of the modem router.)

**Step 2:** The Wi-Fi Protected Setup LED flashes for two minutes during the Wi-Fi Protected Setup process.

**Step 3:** When the WPS LED is on, the client device has successfully connected to the modem router.

**Step 4:** Refer back to your client device or its documentation for further instructions.

### Note:

- 1) The WPS LED on the modem router will light green for five minutes if the device has been successfully added to the network.
- 2) The WPS function cannot be configured if the Wireless Function of the modem router is disabled. Please make sure the Wireless Function is enabled before configuring the WPS.

### 4.8.3 Wireless Security

Choose menu “**Wireless 2.4GHz**” → “**Wireless Security**”, you can configure the security settings of your wireless network.

There are three wireless security modes supported by the modem router: WPA/WPA2 – Personal, WPA/WPA2 – Enterprise, WEP (Wired Equivalent Privacy).

Wireless Security Settings

Note: WEP security, WPA/WPA2 - Enterprise authentication and TKIP encryption are not supported with WPS enabled.  
For network security, it is strongly recommended to enable wireless security and use WPA2-PSK AES encryption.

Disable Wireless Security

WPA/WPA2 - Personal (Recommended)

Authentication Type:

Encryption:

Wireless Password:   
(Enter ASCII characters between 8 and 63 or Hexadecimal characters between 8 and 64.)

Group Key Update Period:  (seconds, minimum is 30, 0 means no update)

WPA/WPA2 - Enterprise

Authentication Type:

Encryption:

RADIUS Server IP:

RADIUS Server Port:  (1-65535, 0 stands for default port 1812)

RADIUS Server Password:

Group Key Update Period:  (In second, minimum is 30, 0 means no update)

WEP

Authentication Type:

WEP Key Format:

Selected Key:	WEP Key	Key Type
Key 1: <input checked="" type="radio"/>	<input type="text"/>	<input type="text" value="Disabled"/>
Key 2: <input type="radio"/>	<input type="text"/>	<input type="text" value="Disabled"/>
Key 3: <input type="radio"/>	<input type="text"/>	<input type="text" value="Disabled"/>
Key 4: <input type="radio"/>	<input type="text"/>	<input type="text" value="Disabled"/>

Figure 4-41

- **Disable Wireless Security:** If you do not want to use wireless security, check this radio button. But it's strongly recommended to choose one of the following modes to enable security.
- **WPA/WPA2-Personal:** It's the WPA/WPA2 authentication type based on pre-shared passphrase. The modem router is configured by this security type by default.
  - **Authentication Type:** You can choose the type for the WPA/WPA2-Personal security on the drop-down list. The default setting is **Auto**, which can select **WPA-PSK** or **WPA2-PSK** authentication type automatically based on the wireless station's capability and request.
  - **Encryption:** You can select **Auto**, **TKIP** or **AES** as Encryption.
  - **Wireless Password:** You can enter ASCII characters between 8 and 63 characters or 8 to 64 Hexadecimal characters. The default password is the same with the default PIN code, which is labeled on the bottom of the Router or can be found in Figure 4-38.
  - **Group Key Update Period:** Specify the group key update interval in seconds. The value should be 30 or above. Enter 0 to disable the update.
- **WPA/WPA2 – Enterprise:** It's based on Radius Server.

WPA/WPA2 - Enterprise

Authentication Type:

Encryption:

RADIUS Server IP:

RADIUS Server Port:

RADIUS Server Password:

(Enter ASCII characters between 8 and 63 or Hexadecimal characters between 8 and 64.)

Group Key Update Period:  (in second, minimum is 30, 0 means no update)

- **Authentication Type:** You can choose the type for the WPA/WPA2-Personal security on the drop-down list. The default setting is **Auto**, which can select **WPA-PSK** or **WPA2-PSK** authentication type automatically based on the wireless station's capability and request.
- **Encryption:** You can select **Auto**, **TKIP** or **AES** as Encryption.
- **RADIUS Server IP:** Enter the IP address of the Radius Server.
- **RADIUS Server Port:** Enter the port that radius service used.
- **RADIUS Server Password:** Enter the password for the Radius Server.
- **Group Key Update Period:** Specify the group key update interval in seconds. The value should be 30 or above. Enter 0 to disable the update.

➤ **WEP:** It is based on the IEEE 802.11 standard.

WEP

Authentication Type:

WEP Key Format:

Selected Key: **WEP Key**

	Key Type
Key 1: <input checked="" type="radio"/>	<input type="text"/> Disabled
Key 2: <input type="radio"/>	<input type="text"/> Disabled
Key 3: <input type="radio"/>	<input type="text"/> Disabled
Key 4: <input type="radio"/>	<input type="text"/> Disabled

- **Authentication Type:** You can choose the type for the WPA/WPA2-Personal security on the drop-down list. The default setting is **Auto**, which can select **WPA-PSK** or **WPA2-PSK** authentication type automatically based on the wireless station's capability and request.
- **WEP Key Format:** **Hexadecimal** and **ASCII** formats are provided here. **Hexadecimal** format stands for any combination of hexadecimal digits (0-9, a-f, A-F) in the specified length. **ASCII** format stands for any combination of keyboard characters in the specified length.
- **WEP Key:** Select which of the four keys will be used and enter the matching WEP key that you create. Make sure these values are identical on all wireless stations in your network.
- **Key Type:** You can select the WEP key length (64-bit, or 128-bit.) for encryption. "Disabled" means this WEP key entry is invalid.

**64-bit:** You can enter 10 hexadecimal digits (any combination of 0-9, a-f, A-F, zero key is not promoted) or 5 ASCII characters.

**128-bit:** You can enter 26 hexadecimal digits (any combination of 0-9, a-f, A-F, zero key is not promoted) or 13 ASCII characters.



**Note:**

If you do not set the key, the wireless security function is still disabled even if you have selected Shared Key as Authentication Type.

Be sure to click the **Save** button to save your settings on this page.

#### 4.8.4 Wireless MAC Filtering

Choose menu “**Wireless 2.4GHz**” → “**Wireless MAC Filtering**”, you can control the wireless access by configuring the **Wireless MAC Filtering** function, shown in Figure 4-42.

Wireless MAC Filtering settings

You can configure the Wireless MAC Filtering to control the wireless access on this page.

**Wireless MAC Filtering:** Enabled

Filtering Rules

**Deny** the stations specified by any enabled entries in the list to access.

**Allow** the stations specified by any enabled entries in the list to access.

<input type="checkbox"/>	MAC Address	Status	Description	Edit
<input type="checkbox"/>	00:1D:0F:11:22:33	Enabled	Wireless station A	<a href="#">Edit</a>

Figure 4-42

To filter wireless users by MAC Address, click **Enable**. The default setting is **Disabled**.

- **MAC Address:** The wireless station's MAC address that you want to filter.
- **Status:** The status of this entry either **Enabled** or **Disabled**.
- **Description:** A simple description of the wireless station.

To Add a Wireless MAC Address filtering entry, click the **Add New** button. The following page will appear, shown in Figure 4-43:

Wireless MAC Filtering settings

You can configure the Wireless MAC Filtering to control the wireless access on this page.

**MAC Address:**  e.g. 00:1D:0F:11:22:33

**Description:**

**Status:**

Figure 4-43

**To add or modify a MAC Address Filtering entry, follow these instructions:**

1. Enter the appropriate MAC Address into the **MAC Address** field. The format of the MAC Address is XX:XX:XX:XX:XX:XX (X is any hexadecimal digit). For example: 00:1D:0F:11:22:33.
2. Give a simple description for the wireless station in the **Description** field. For example: Wireless station A.
3. Select **Enabled** or **Disabled** for this entry on the **Status** drop-down list.

- Click the **Save** button to save this entry.

**To edit or delete an existing entry:**

- Click the **Edit** in the entry you want to modify.
- Modify the information.
- Click the **Save** button.

Click the **Enable/ Disabled Selected** button to make selected entries enabled or disabled.

Click the **Delete Selected** button to selected entries.

**For example:** If you desire that the wireless station A with MAC address 00:1D:0F:11:22:33 and the wireless station B with MAC address 00:0A:EB:00:07:5F are able to access the modem router, but all the other wireless stations cannot access the Modem router, you can configure the **Wireless MAC Address Filtering** list by following these steps:

- Click the **Enable** button to enable this function.
- Select the radio button “**Allow the stations specified by any enabled entries in the list to access**” for **Filtering Rules**.
- Delete all or disable all entries if there are any entries already.
- Click the **Add New** button.
  - Enter the MAC address 00:1D:0F:11:22:33/00:0A:EB:00:07:5F in the **MAC Address** field.
  - Enter wireless station A/B in the **Description** field.
  - Select **Enabled** in the **Status** drop-down list.
  - Click the **Save** button.

The filtering rules that configured should be similar to the following list:

Filtering Rules

**Deny** the stations specified by any enabled entries in the list to access.

**Allow** the stations specified by any enabled entries in the list to access.

	MAC Address	Status	Description	Edit
<input type="checkbox"/>	00:1D:0F:11:22:33	Enabled	Wireless station A	<a href="#">Edit</a>
<input type="checkbox"/>	00:0A:EB:00:07:5F	Enabled	Wireless station B	<a href="#">Edit</a>

#### 4.8.5 Wireless Advanced

Choose menu “**Wireless 2.4GHz**”→“**Wireless Advanced**”, you can configure the advanced settings of your wireless network.

Wireless Lan Advanced Settings

Notice: Wireless mode included 11n, Fragmentation Threshold will be set to default value.

<b>Transmit Power:</b>	<input type="text" value="100%"/>	
<b>Beacon Interval:</b>	<input type="text" value="100"/>	(25-1000)
<b>RTS Threshold:</b>	<input type="text" value="2346"/>	(1-2346)
<b>Fragmentation Threshold:</b>	<input type="text" value="2346"/>	(256-2346)
<b>DTIM Interval:</b>	<input type="text" value="1"/>	(1-255)
	<input checked="" type="checkbox"/>	Enable Short GI
	<input type="checkbox"/>	Enable Client isolation
	<input checked="" type="checkbox"/>	Enable WMM

Figure 4-44

- **Transmit Power:** Here you can specify the transmit power of modem router. You can select High, Middle or Low which you would like. High is the default setting and is recommended.
- **Beacon Interval:** Enter a value between 25-1000 milliseconds for Beacon Interval here. The beacons are the packets sent by the modem router to synchronize a wireless network. Beacon Interval value determines the time interval of the beacons. The default value is 100.
- **RTS Threshold:** Here you can specify the RTS (Request to Send) Threshold. If the packet is larger than the specified RTS Threshold size, the modem router will send RTS frames to a particular receiving station and negotiate the sending of a data frame. The default value is 2346.
- **Fragmentation Threshold:** This value is the maximum size determining whether packets will be fragmented. Setting the Fragmentation Threshold too low may result in poor network performance because of excessive packets. 2346 is the default setting and is recommended.
- **DTIM Interval:** This value determines the interval of the Delivery Traffic Indication Message (DTIM). A DTIM field is a countdown field informing clients of the next window for listening to broadcast and multicast messages. When the modem router has buffered broadcast or multicast messages for associated clients, it sends the next DTIM with a DTIM Interval value. You can specify the value between 1-255 Beacon Intervals. The default value is 1, which indicates the DTIM Interval is the same as Beacon Interval.
- **Enable Short GI:** This function is recommended for it will increase the data capacity by reducing the guard interval time.
- **Enabled Client isolation:** This function can isolate wireless stations on your network from each other. Wireless devices will be able to communicate with the modem router but not with each other. To use this function, check this box. Client isolation is disabled by default.
- **Enable WMM:** WMM function can guarantee the packets with high-priority messages being transmitted preferentially. It is strongly recommended.

 **Note:**

If you are not familiar with the setting items in this page, it's strongly recommended to keep the provided default values; otherwise it may result in lower wireless network performance.

### 4.8.6 Wireless Status

Choose menu “**Wireless 2.4GHz**”→“**Wireless Status**”, you can see the MAC Address, Current Status, Received Packets and Sent Packets for each connected wireless station.

Wireless Stations Status				
This page displays the basic information of all stations in this wireless network.				
Current Connected Wireless Stations numbers: 0 <input type="button" value="Refresh"/>				
ID	MAC Address	Current Status	Received Packets	Sent Packets

Figure 4-45

- **MAC Address:** The connected wireless station's MAC address
- **Current Status:** The connected wireless station's running status, one of STA-AUTH/ STA-ASSOC/ STA-JOINED/ WPA/ WPA-PSK/ WPA2/ WPA2-PSK/ AP-UP/ AP-DOWN/ Disconnected
- **Received Packets:** Packets received by the station
- **Sent Packets:** Packets sent by the station

To update this page and to show the current connected wireless stations, click on the **Refresh** button.

## 4.9 Wireless 5GHz

Wireless 5GHz
Basic Settings
WPS Settings
Wireless Security
Wireless MAC Filtering
Wireless Advanced
Wireless Status

There are five submenus under the Wireless menu: **Basic Settings**, **WPS Settings**, **Wireless Security**, **Wireless MAC Filtering**, **Wireless Advanced** and **Wireless Status**. Click any of them, and you will be able to configure the corresponding function.

### 4.9.1 Basic Settings

Choose menu “**Wireless 5GHz**” → “**Basic Settings**”, you can configure the basic settings for the wireless network of 2.4GHz on this page.

Wireless Basic Settings	
<b>SSID:</b>	TP-LINK_5GHz_130969
<b>Region:</b>	United States
<b>Warning:</b>	Ensure you select a correct country to conform local law. Incorrect settings may cause interference.
<b>Mode:</b>	11an mixed
<b>Channel:</b>	Auto
<b>Channel Width:</b>	Auto
	<input checked="" type="checkbox"/> Enable SSID Broadcast
<input type="button" value="Save"/>	

Figure 4-46

- **SSID:** Wireless network name shared among all points in a wireless network. The SSID must be identical for all devices in the wireless network. It is case-sensitive and must not exceed 32 characters (use any of the characters on the keyboard). Make sure this setting is the same for all stations in your wireless network. Type the desired SSID in the space provided. The default SSID is set to be TP-LINK\_5GHz\_XXXXXX.
- **Region:** Select your region from the drop-down list. This field specifies the region where the wireless function of the modem router can be used. It may be illegal to use the wireless function of the modem router in a region other than one of those specified in this field. If your country or region is not listed, please contact your local government agency for assistance.

 **Note:**

Limited by local law regulations, version for North America does not have region selection option.

- **Mode:** Select the desired mode.
  - 11a only** - Select if all of your wireless clients are 802.11a. When 802.11a mode is selected, only 802.11a wireless stations can connect to the Router.
  - 11n only**- Select only if all of your wireless clients are 802.11n. When 802.11n mode is selected, only 802.11n wireless stations can connect to the Router.
  - 11an mixed** - Select if you are using both 802.11a and 802.11n wireless clients. It is strongly recommended that you set the Mode 11an mixed, and all of 802.11a and 802.11n wireless stations can connect to the Router.
- **Channel:** Select the channel you want to use from the drop-down List of Channel. This field determines which operating frequency will be used. It is not necessary to change the wireless channel unless you notice interference problems with another nearby access point.
- **Channel Width:** Select the channel width from the drop-down list. The default setting is automatic, which can adjust the channel width for your clients automatically.

 **Note:**

If **11a only** is selected in the **Mode** field, the **Channel Width** selecting field will turn grey and the value will become 20M, which is unable to be changed.

- **Enable SSID Broadcast:** When wireless clients survey the local area for wireless networks to associate with, they will detect the SSID broadcast by the modem router. If you select the

Enable **SSID Broadcast** checkbox, the Wireless Router will broadcast its name (SSID) on the air.

Click **Save** to save your settings.

## 4.9.2 WPS Settings

This section will guide you to add a new wireless device to an existing network quickly by **WPS** (also called **QSS**) function.

a). Choose menu "**WPS Settings**", and you will see the next screen (shown in Figure 4-47).

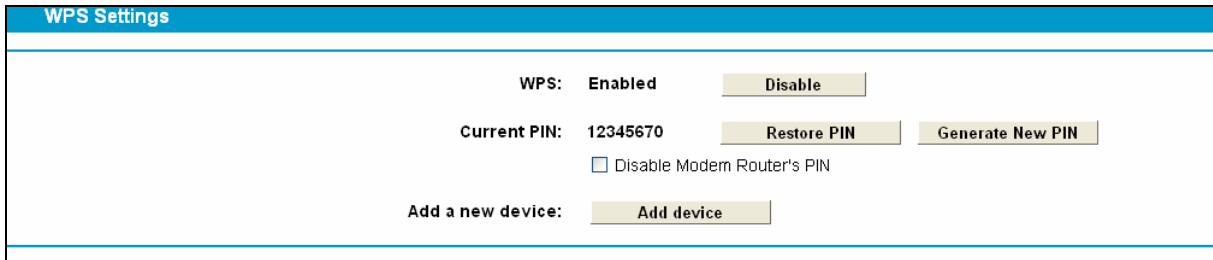

Figure 4-47

- **WPS:** Enable or disable the WPS function here.
- **Current PIN:** The current value of the modem router's PIN is displayed here. The default PIN of the modem router can be found in the label or User Guide.
- **Restore PIN:** Restore the PIN of the modem router to its default.
- **Gen New PIN:** Click this button, and then you can get a new random value for the modem router's PIN. You can ensure the network security by generating a new PIN.
- **Add device:** You can add a new device to the existing network manually by clicking this button.

b). To add a new device:

If the wireless adapter supports Wi-Fi Protected Setup (WPS), you can establish a wireless connection between wireless adapter and modem router using either Push Button Configuration (PBC) method or PIN method.

### Note:

To build a successful connection by WPS, you should also do the corresponding configuration of the new device for WPS function meanwhile.

### I. Use the Wi-Fi Protected Setup Button

Use this method if your client device has a Wi-Fi Protected Setup button.

**Step 1:** Press the WPS button on the back panel of the modem router, as shown in the following figure.



You can also keep the default WPS Status as **Enabled** and click the **Add device** button in Figure 4-47, then Choose “**Press the button of the new device in two minutes**” and click **Connect**. (Shown in the following figure)

The screenshot shows the 'WPS Settings' page. At the top, there is a blue header with the text 'WPS Settings'. Below the header, there are two radio button options. The first option is 'Enter the new device's PIN.' with a text input field labeled 'PIN:'. The second option is 'Press the button of the new device in two minutes.' and this option is selected, indicated by a filled radio button. At the bottom of the page, there are two buttons: 'Connect' and 'Back'.

Figure 4-48

**Step 2:** Press and hold the WPS button of the client device directly.

**Step 3:** The Wi-Fi Protected Setup LED flashes for two minutes during the Wi-Fi Protected Setup process.

**Step 4:** When the WPS LED is on, the client device has successfully connected to the modem router.

Refer back to your client device or its documentation for further instructions.

## II. Enter the client device's PIN on the modem router

Use this method if your client device has a Wi-Fi Protected Setup PIN number.

**Step 1:** Keep the default WPS Status as **Enabled** and click the **Add device** button in Figure 4-47, then the following screen will appear.

The screenshot shows the 'WPS Settings' page. At the top, there is a blue header with the text 'WPS Settings'. Below the header, there are two radio button options. The first option is 'Enter the new device's PIN.' with a text input field labeled 'PIN:'. This option is selected, indicated by a filled radio button. The second option is 'Press the button of the new device in two minutes.' and this option is unselected, indicated by an empty radio button. At the bottom of the page, there are two buttons: 'Connect' and 'Back'.

Figure 4-49

**Step 2:** Enter the PIN number from the client device in the field on the above WPS screen. Then click **Connect** button.

**Step 3:** “**Connect successfully**” will appear on the screen of Figure 4-49, which means the client device has successfully connected to the modem router.

## III. Enter the modem router's PIN on your client device

Use this method if your client device asks for the modem router's PIN number.

**Step 1:** On the client device, enter the PIN number listed on the modem router's Wi-Fi Protected Setup screen. (It is also labeled on the bottom of the modem router.)

**Step 2:** The Wi-Fi Protected Setup LED flashes for two minutes during the Wi-Fi Protected Setup process.

**Step 3:** When the WPS LED is on, the client device has successfully connected to the modem router.

**Step 4:** Refer back to your client device or its documentation for further instructions.

 **Note:**

- 1) The WPS LED on the modem router will light green for five minutes if the device has been successfully added to the network.
- 2) The WPS function cannot be configured if the Wireless Function of the modem router is disabled. Please make sure the Wireless Function is enabled before configuring the WPS.

### 4.9.3 Wireless Security

Choose menu “**Wireless 5GHz**”→” **Wireless Security**”, you can configure the security settings of your wireless network.

There are three wireless security modes supported by the modem router: WPA/WPA2 – Personal, WPA/WPA2 – Enterprise, WEP (Wired Equivalent Privacy).

Wireless Security Settings

Note: WEP security, WPA/WPA2 - Enterprise authentication and TKIP encryption are not supported with WPS enabled.  
For network security, it is strongly recommended to enable wireless security and use WPA2-PSK AES encryption.

Disable Wireless Security

WPA/WPA2 - Personal (Recommended)

Authentication Type:

Encryption:

Wireless Password:

(Enter ASCII characters between 8 and 63 or Hexadecimal characters between 8 and 64.)

Group Key Update Period:  (seconds, minimum is 30, 0 means no update)

WPA/WPA2 - Enterprise

Authentication Type:

Encryption:

RADIUS Server IP:

RADIUS Server Port:  (1-65535, 0 stands for default port 1812)

RADIUS Server Password:

Group Key Update Period:  (in second, minimum is 30, 0 means no update)

WEP

Authentication Type:

WEP Key Format:

Selected Key: **WEP Key**

		Key Type
Key 1: <input checked="" type="radio"/>	<input type="text"/>	Disabled
Key 2: <input type="radio"/>	<input type="text"/>	Disabled
Key 3: <input type="radio"/>	<input type="text"/>	Disabled
Key 4: <input type="radio"/>	<input type="text"/>	Disabled

Figure 4-50

- **Disable Wireless Security:** If you do not want to use wireless security, check this radio button. But it's strongly recommended to choose one of the following modes to enable security.
- **WPA/WPA2-Personal** - It's the WPA/WPA2 authentication type based on pre-shared passphrase. The modem router is configured by this security type by default.
  - **Authentication Type:** You can choose the type for the WPA/WPA2-Personal security on the drop-down list. The default setting is **Auto**, which can select **WPA-PSK** or **WPA2-PSK** authentication type automatically based on the wireless station's capability and request.
  - **Encryption:** You can select **Auto**, **TKIP** or **AES** as Encryption.
  - **Wireless Password:** You can enter ASCII characters between 8 and 63 characters or 8 to 64 Hexadecimal characters. The default password is the same with the default PIN code,



which is labeled on the bottom of the Router or can be found in Figure 4-38.

- **Group Key Update Period:** Specify the group key update interval in seconds. The value should be 30 or above. Enter 0 to disable the update.

➤ **WPA/WPA2 – Enterprise:** It's based on Radius Server.

WPA/WPA2 - Enterprise

Authentication Type:

Encryption:

RADIUS Server IP:

RADIUS Server Port:

RADIUS Server Password:

(Enter ASCII characters between 8 and 63 or Hexadecimal characters between 8 and 64.)

Group Key Update Period:  (in second, minimum is 30, 0 means no update)

- **Authentication Type:** You can choose the type for the WPA/WPA2-Personal security on the drop-down list. The default setting is **Auto**, which can select **WPA-PSK** or **WPA2-PSK** authentication type automatically based on the wireless station's capability and request.
- **Encryption:** You can select **Auto**, **TKIP** or **AES** as Encryption.
- **RADIUS Server IP:** Enter the IP address of the Radius Server.
- **RADIUS Server Port:** Enter the port that radius service used.
- **RADIUS Server Password:** Enter the password for the Radius Server.
- **Group Key Update Period:** Specify the group key update interval in seconds. The value should be 30 or above. Enter 0 to disable the update.

➤ **WEP:** It is based on the IEEE 802.11 standard.

WEP

Authentication Type:

WEP Key Format:

Selected Key: WEP Key

Key	Key Type
Key 1: <input checked="" type="radio"/>	<input type="text" value=""/> Disabled
Key 2: <input type="radio"/>	<input type="text" value=""/> Disabled
Key 3: <input type="radio"/>	<input type="text" value=""/> Disabled
Key 4: <input type="radio"/>	<input type="text" value=""/> Disabled

- **Authentication Type:** You can choose the type for the WPA/WPA2-Personal security on the drop-down list. The default setting is **Auto**, which can select **WPA-PSK** or **WPA2-PSK** authentication type automatically based on the wireless station's capability and request.
- **WEP Key Format:** **Hexadecimal** and **ASCII** formats are provided here. **Hexadecimal** format stands for any combination of hexadecimal digits (0-9, a-f, A-F) in the specified length. **ASCII** format stands for any combination of keyboard characters in the specified length.
- **WEP Key:** Select which of the four keys will be used and enter the matching WEP key that you create. Make sure these values are identical on all wireless stations in your network.

- **Key Type:** You can select the WEP key length (64-bit, or 128-bit.) for encryption. "Disabled" means this WEP key entry is invalid.

**64-bit:** You can enter 10 hexadecimal digits (any combination of 0-9, a-f, A-F, zero key is not promoted) or 5 ASCII characters.

**128-bit:** You can enter 26 hexadecimal digits (any combination of 0-9, a-f, A-F, zero key is not promoted) or 13 ASCII characters.

 **Note:**

If you do not set the key, the wireless security function is still disabled even if you have selected Shared Key as Authentication Type.

Be sure to click the **Save** button to save your settings on this page.

#### 4.9.4 Wireless MAC Filtering

Choose menu "**Wireless 5GHz**" → "**Wireless MAC Filtering**", you can control the wireless access by configuring the **Wireless MAC Filtering** function, shown in Figure 4-42.

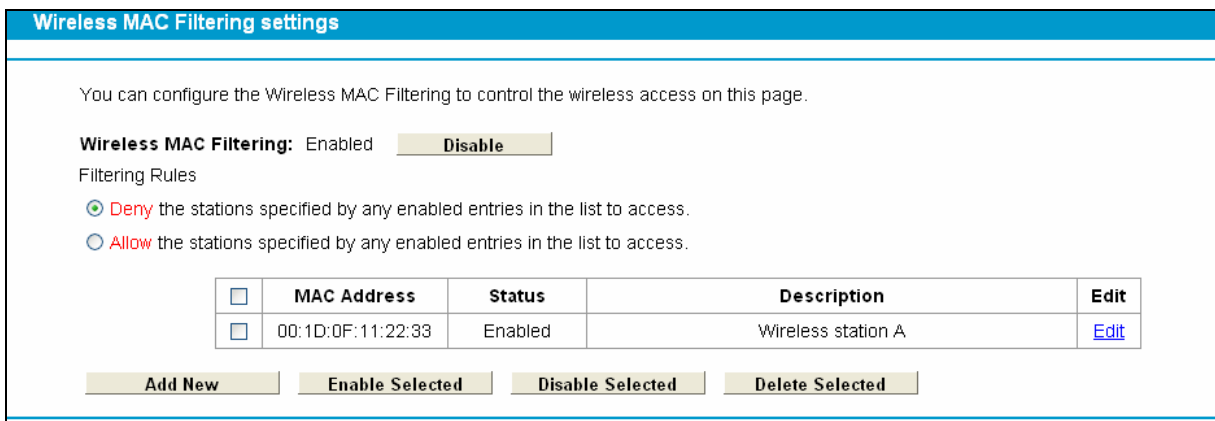

	MAC Address	Status	Description	Edit
<input type="checkbox"/>	00:1D:0F:11:22:33	Enabled	Wireless station A	<a href="#">Edit</a>

Figure 4-51

To filter wireless users by MAC Address, click **Enable**. The default setting is **Disabled**.

- **MAC Address:** The wireless station's MAC address that you want to filter.
- **Status:** The status of this entry, either **Enabled** or **Disabled**.
- **Description:** A simple description of the wireless station.

To Add a Wireless MAC Address filtering entry, click the **Add New** button. The following page will appear, shown in Figure 4-43:

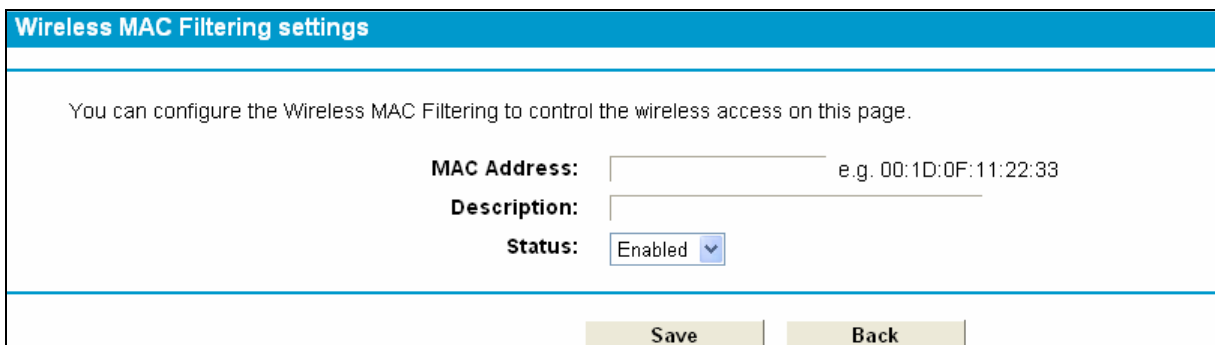

Figure 4-52

**To add or modify a MAC Address Filtering entry, follow these instructions:**

1. Enter the appropriate MAC Address into the **MAC Address** field. The format of the MAC Address is XX:XX:XX:XX:XX:XX (X is any hexadecimal digit). For example: 00:1D:0F:11:22:33.
2. Give a simple description for the wireless station in the **Description** field. For example: Wireless station A.
3. Select **Enabled** or **Disabled** for this entry on the **Status** drop-down list.
4. Click the **Save** button to save this entry.

**To edit or delete an existing entry:**

1. Click the **Edit** in the entry you want to modify.
2. Modify the information.
3. Click the **Save** button.

Click the **Enable/ Disabled Selected** button to make selected entries enabled or disabled.

Click the **Delete Selected** button to selected entries.

**For example:** If you desire that the wireless station A with MAC address 00:1D:0F:11:22:33 and the wireless station B with MAC address 00:0A:EB:00:07:5F are able to access the modem router, but all the other wireless stations cannot access the Modem router, you can configure the **Wireless MAC Address Filtering** list by following these steps:

5. Click the **Enable** button to enable this function.
6. Select the radio button “**Allow the stations specified by any enabled entries in the list to access**” for **Filtering Rules**.
7. Delete all or disable all entries if there are any entries already.
8. Click the **Add New** button.
  - 5) Enter the MAC address 00:1D:0F:11:22:33/00:0A:EB:00:07:5F in the **MAC Address** field.
  - 6) Enter wireless station A/B in the **Description** field.
  - 7) Select **Enabled** in the **Status** drop-down list.
  - 8) Click the **Save** button.

The filtering rules that configured should be similar to the following list:

Filtering Rules

**Deny** the stations specified by any enabled entries in the list to access.

**Allow** the stations specified by any enabled entries in the list to access.

	MAC Address	Status	Description	Edit
<input type="checkbox"/>	00:1D:0F:11:22:33	Enabled	Wireless station A	<a href="#">Edit</a>
<input type="checkbox"/>	00:0A:EB:00:07:5F	Enabled	Wireless station B	<a href="#">Edit</a>

#### 4.9.5 Wireless Advanced

Choose menu “**Wireless 5GHz**”→“**Wireless Advanced**”, you can configure the advanced settings of your wireless network.

Wireless Advanced Settings	
<b>Transmit Power:</b>	100% <input type="button" value="v"/>
<b>Beacon Interval:</b>	100 (25-1000)
<b>RTS Threshold:</b>	2346 (1-2346)
<b>DTIM Interval:</b>	1 (1-255)
	<input checked="" type="checkbox"/> Enable Short GI
	<input type="checkbox"/> Enable Client isolation
	<input checked="" type="checkbox"/> Enable WMM
<input type="button" value="Save"/>	

Figure 4-53

- **Transmit Power:** Here you can specify the transmit power of modem router. You can select High, Middle or Low which you would like. High is the default setting and is recommended.
- **Beacon Interval:** Enter a value between 25-1000 milliseconds for Beacon Interval here. The beacons are the packets sent by the modem router to synchronize a wireless network. Beacon Interval value determines the time interval of the beacons. The default value is 100.
- **RTS Threshold:** Here you can specify the RTS (Request to Send) Threshold. If the packet is larger than the specified RTS Threshold size, the modem router will send RTS frames to a particular receiving station and negotiate the sending of a data frame. The default value is 2346.
- **DTIM Interval:** This value determines the interval of the Delivery Traffic Indication Message (DTIM). A DTIM field is a countdown field informing clients of the next window for listening to broadcast and multicast messages. When the modem router has buffered broadcast or multicast messages for associated clients, it sends the next DTIM with a DTIM Interval value. You can specify the value between 1-255 Beacon Intervals. The default value is 1, which indicates the DTIM Interval is the same as Beacon Interval.
- **Enable Short GI:** This function is recommended for it will increase the data capacity by reducing the guard interval time.
- **Enabled Client isolation:** This function can isolate wireless stations on your network from each other. Wireless devices will be able to communicate with the modem router but not with each other. To use this function, check this box. Client isolation is disabled by default.
- **Enable WMM:** WMM function can guarantee the packets with high-priority messages being transmitted preferentially. It is strongly recommended.

 **Note:**

If you are not familiar with the setting items in this page, it's strongly recommended to keep the provided default values; otherwise it may result in lower wireless network performance.

#### 4.9.6 Wireless Status

Choose menu "**Wireless 5GHz**"→"**Wireless Status**", you can see the MAC Address, Current Status, Received Packets and Sent Packets for each connected wireless station.

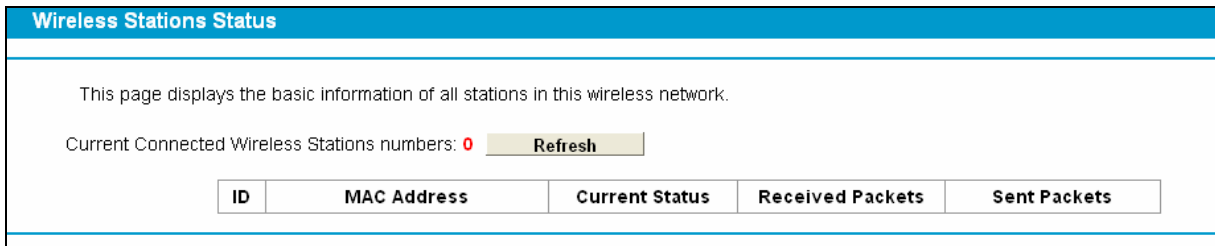

Figure 4-54

- **MAC Address:** The connected wireless station's MAC address
- **Current Status:** The connected wireless station's running status, one of **STA-AUTH/ STA-ASSOC/ STA-JOINED/ WPA/ WPA-PSK/ WPA2/ WPA2-PSK/ AP-UP/ AP-DOWN/ Disconnected**
- **Received Packets:** Packets received by the station
- **Sent Packets:** Packets sent by the station

To update this page and to show the current connected wireless stations, click on the **Refresh** button.

## 4.10 Guest Network



There are two submenus under the Guest Network menu: **Basic Settings** and **Guest Network Status**. Click any of them, and you will be able to scan or configure the corresponding function. The detailed explanations for each submenu are provided below.

### 4.10.1 Basic Settings

Choose menu "**Guest Network**"→"**Basic Settings**", and you will see the screen as shown in Figure 4-55. This feature allows you to create a separate network for your guests without allowing them to access your main network and the computers connected to it.

Figure 4-55

- **Guest Network:** You can choose your Guest Network. When you enable this function, you could set wireless parameters for Guest Network.
- **SSID:** The guest network name. When setting up a Guest network, it is strongly recommended to use a name that easily distinguishes it from your primary network. TP-LINK\_Guest\_2.4GHz/5GHz.
- **Security:** The default value is disabled, but it's strongly recommended to enable WPA/WPA2-Personal. WPA/WPA2-Personal is the WPA/WPA2 authentication type based on pre-shared passphrase.
- **Authentication Type:** Select the Authentication Type from the drop-down list, the default method is **Auto**, and you can leave it as a default setting.
- **Encryption:** You can select either **Auto**, or **TKIP** or **AES**.
- **Wireless Password:** You can enter ASCII characters between 8 and 63 characters or 8 to 64 Hexadecimal characters.
- **Group Key Update Period:** Specify the group key update interval in seconds. The value should be 30 or above. Enter 0 to disable the update.
- **Allow Guests to access my Local Network:** The guests have access to your Local Network, but can not login the modem router's Web-Management page.
- **Allow Guests to access my USB Storage Sharing:** The guests can access the specified files on the USB storage device via the function of USB Storage Sharing, but the function of FTP Server, Media Server and Print Server are not available in Guest Network. For more details please refer to [4.11.3 Storage Sharing](#).
- **Guest Network Isolation:** This function can isolate wireless clients on your guest network from each other. Client isolation is disabled by default.
- **Guest Network Bandwidth Control:** With this function, you can configure the Upstream Bandwidth and Downstream Bandwidth for guest network.

Click **Save** to save your settings.

## 4.10.2 Guest Network Status

Choose menu “**Guest Network**”→“**Guest Network Status**”, you can see the MAC Address, Current Status, Received Packets and Sent Packets for each connected wireless station.

Guest Network Status					
This page displays the basic information of guests in this wireless network.					
Current Connected Guest Network numbers: 0 <input type="button" value="Refresh"/>					
ID	MAC Address	Current Status	Received Packets	Sent Packets	SSID

- **MAC Address:** The connected wireless station's MAC address.
- **Current Status:** The connected wireless station's running status.
- **Received Packets:** Packets received by the station.
- **Sent Packets:** Packets sent by the station.

You cannot change any of the values on this page. To update this page and to show the current connected wireless stations, click on the **Refresh** button.

## 4.11 USB Settings

USB Settings
<b>USB Mass Storage</b>
User Accounts
Storage Sharing
FTP Server
Media Server
Print Server

There are six submenus under the USB Settings menu, **USB Mass Storage**, **User Accounts**, **Storage Sharing**, **FTP Server**, **Media Server** and **Print Server**. Click any of them, and you will be able to configure the corresponding function.

### 4.11.1 USB Mass Storage

Choose menu “**USB Settings** → “**USB Mass Storage**”, you can configure a USB disk drive attached to the modem router and view volume and share properties such as share name, capacity, status, and action, etc on this page as shown below.

**USB Mass Storage**

This page provides the basic information about the connected USB mass storage, to configure Storage Sharing/FTP/Media Server, please click the corresponding menu on the left side.

**USB Mass storage List:**

Disk1: Kingston ( DataTraveler 2.0 ) Rev: 1.00 Connected [Disconnect](#)

Volume	File System	Capacity	Status	Action
sda1	FAT32	1.5 GB	Active	<a href="#">Deactivate</a>

**Note:**

1. Click the REFRESH button to detect your USB device. The Modem Router will automatically activate the first two USB storage devices or up to eight volumes;
2. If you want to use other volumes in your storage device(s), please "Deactivate" some unused volumes and "Activate" the other desired volumes;
3. Click "Disconnect" button before unplugging your USB device to avoid data loss or damage to the device.
4. **Supported USB Mass Storage:** hard disk, flash disk or memory card reader;  
**Supported File System Type:** FAT32 and NTFS;  
**Supported Volumes:** Only two USB storage devices with up to eight volumes could be activated simultaneously, up to four USB storage devices with about eighteen volumes could be recognized.

Figure 4-56

- **Volume:** The volume name of the USB drive the users have access to.
- **File System:** The system of the USB drive.
- **Capacity:** The storage capacity of the USB driver.
- **Status:** Indicates the shared or non-shared status of the volume. **Online** means volume can be shared, while **Offline** means volume can not be shared. If **Deactivate** in Action field is enabled, **Disabled** will be displayed in the Status field, which means volume can not be shared.
- **Action:** When the volume is shared, you can click the **Deactivate** to stop sharing the volume; when volume is non-shared, you can click the **Enable** button to share the volume.

Click **Disconenct** to safely remove the USB storage device that is connected to USB port.

 **Note:**

Before removing the USB storage device, you should click "Disconnect" to make sure that all your data have been saved completely. Removing device directly may cause your USB storage device crashed.

#### 4.11.2 User Accounts

You can specify the user name and password for Storage Sharing and FTP Server users on this page. Storage Sharing users can access the folders by entering the following URL into the address field of your browser or Windows Explorer, such as. \\192.168.1.1. FTP Server users can log into the FTP Server via FTP Client.

There are five users here, which provide means to control the access to the USB mass storage by Storage Sharing or FTP. The Super User has the right to read and write to Storage Sharing and FTP Server.



User Accounts			
This page allows you to configure user accounts for Storage Sharing/FTP Server. Please click Set button to make your configuration take effect.			
Index	Username	Status	Action
1	admin*	Enabled	<input checked="" type="radio"/> Enable <input type="radio"/> Disable
2			
3			
4			
5			

\*: "Super User", It has full-access permission to all active volume(s) and shared folder(s).

Choose Index:

New Username:

New Password:

Confirm password:

Figure 4-57

**To add a new user account, please follow the steps below:**

1. Choose the index from the drop-down list of **Choose Index**.
2. Self-define a **New Username**.
3. Enter the password in the **New Password** field.
4. Re-enter the password in the **Confirm password** field.
5. Click the **Set** button, and then a new entry will be added in the table.

To delete an existing user account, please click **Delete** in the **Action** column.

### 4.11.3 Storage Sharing

Choose menu "**USB Settings**" → "**Storage Sharing**", you can configure a USB disk drive attached to the modem router and view volume and share properties on this page as shown below.

Storage Sharing Settings	
Storage Sharing allows you to share the files on the USB storage device with other computers locally.	
<b>Server Status:</b>	Enabled <input type="button" value="Disable"/>
	<input checked="" type="checkbox"/> Anonymous access to all the volumes
<p>Note:</p> <ol style="list-style-type: none"> <li>1. Storage Sharing function is based on NetBIOS/SMB protocol which is supported by most Windows operating system and some other operating systems.</li> <li>2. anonymous: All active volume(s) will be shared and authentication is not required.</li> <li>3. You will be able to access the folders with the following methods:</li> </ol> <p><b>For Windows OS:</b> Open "Run" window in the Start menu and enter \\(IP Address) or \\(IP Address)(Share Name) e.g. \\192.168.1.1 or \\192.168.1.1\photo;</p> <p><b>For Mac OS:</b> Open "Connect to Server" window in the Go menu and enter smb://(IP Address) or smb://(IP Address)(Share Name) e.g. smb://192.168.1.1 or smb://192.168.1.1/photo.</p>	

Figure 4-58

- **Server Status:** Indicates the Storage Sharing's current status.

- **Anonymous access to all the volumes:** This function is enabled by default, so users can access all activated volumes of Storage Sharing without accounts. If you want to add a shared folder which does not allow anonymous login, uncheck the box to disable this function. And **Folder Table** will be displayed as shown below.

**Folder Table:** (Any changes of this table will not take effect until you Apply it.)

<input type="checkbox"/>	Share Name	Directory	User Access (F: Full-Access, R: Read-Only, N: No-Access)					Status	Edit
			1*	2	3	4	5		
<input type="checkbox"/>	volume	/	F	-	-	-	-	Enabled	<a href="#">Edit</a>

\*: "Super User". It has full-access permission (Read & Write) to all active volume(s) and share folder(s).

Figure 4-59

- **Share Name:** This folder's display name.
- **Directory:** The real full path of the specified folder.
- **User Access:** The authorization of the user is displayed. \* users mean Super Users who have the full-access permission to all activated volumes and share folders. Grey users mean the users who have no right to use this function. Others are common users.
- **Status:** The status of the entry is enabled or disabled.
- **Edit:** Click **Edit** in the table, and then you can modify the entry.

**To add a new folder, follow the instructions below.**

1. Click **Add New Folder** in Figure 4-58.

**Folder Browse**

This page allow you to set a shared folder and access authorization for Storage Sharing service! It will not take effect when Anonymous access been enabled.

**Share Name:**   
**Directory:**

**User Access Control Table:**

Index	User Name	Access Authorization
1*	admin	<input checked="" type="radio"/> Full-Access <input type="radio"/> Read-Only <input type="radio"/> No-Access
2		
3		
4		
5		

\*: "Super User", It has full-access permission to all activated volume(s) and share folder(s).

Figure 4-60

2. Click the **Browse** button, and then select the **Select Volume** from the drop-down list.
3. Enter display name of the share folder in **Share Name** filed.
4. Click the **Apply** button to apply the settings.

You can click the **upper** button to go to the upper folder

Click the **Enable/Disable Selected** button to enable or disable the selected entries.

Click the **Delete Selected** button to delete the selected entries.

**Note:**

1. The max share folders number is 10. If you want to share a new folder when the number has reached 10, you can delete an existing share folder and then add a new one.
2. If you want to change the Storage Sharing settings, you can click the Apply button to make the changes take effect.

#### 4.11.4 FTP Server

Choose menu “**USB Settings**” → “**FTP Server**”, you can create an FTP server that can be accessed from the Internet or your local network.

FTP Server Setting

FTP (File Transfer Protocol) server allows you to share the files on the USB storage device to the local or public network. You will need to define the shared folders and assign the user's authorization for the different folders.

**Server Status:**  Enabled  Disable

**Internet Access:**  Enable  Disable

**Internet Address:** 0.0.0.0

**Service Port:**  (The default is 21. Do not change unless necessary.)

---

**Folder Table:** (Any changes of this table will not take effect until you Apply it.)

	Share name	Directory	User Index (F: Full-Access, R: Read-Only, N: No-Access)					Status	Edit
			1*	2	3	4	5		
<input type="checkbox"/>	volume	/	F	-	-	-	-	Enabled	<a href="#">Edit</a>

\*: "Super User", It has full-access permission to all active volume(s) and shared folder(s).

---

Note:

1. You could be able to access the folders by entering the following URL on Windows Explorer or other FTP software:  
ftp://(IP Address)  
eg. ftp://192.168.1.1
2. FTP Server will get restarted and all your current FTP connections will be terminated after you click Apply button.

Figure 4-61

- **Server Status:** Indicates the FTP Server's current status.
- **Internet Access:** If **Internet Access** is enabled, user(s) in public network can access FTP server via **Internet Address**.
- **Internet Address:** If **Internet Access** is enabled, WAN IP will be displayed here.
- **Service Port:** Enter the FTP Port number to use. The default is 21.
- **Share Name:** This folder's display name.
- **Directory:** The real full path of the specified folder.
- **User Index:** The authorization of the user is displayed.
- **Status:** The status of the entry is enabled or disabled.
- **Edit:** Click **Edit** in the table, and then you can modify the entry.

**To add a new folder, follow the instructions below.**

1. Click **Add New Folder** in Figure 4-61.

**Folder Browse**

This page allow you to set a shared folder and access authorization for Ftp services!

**Share Name:**

**Directory:**

**User Access Control Table:**

Index	User Name	Access Authorization
1*	admin	<input checked="" type="radio"/> Full-Access <input type="radio"/> Read-Only <input type="radio"/> No-Access
2		
3		
4		
5		

\*: "Super User", It has full-access permission to all actived volume(s) and share folder(s).

Figure 4-62

2. Click the **Browse** button, and then select the **Select Volume** from the drop-down list.
3. Enter display name of the share folder in **Share Name** filed.
4. Click the **Apply** button to apply the settings.

You can click the **upper** button to go to the upper folder.

Click the **Enable/Disable Selected** button to enable or disable the selected entries.

Click the **Delete Selected** button to delete the selected entries.

 **Note:**

1. The max share folders number is 10. If you want to share a new folder when the number has reached 10, you can delete an existing share folder and then add a new one.
2. If you want to change the FTP settings, you can click the Apply button to make the changes take effect.

#### 4.11.5 Media Server

Choose menu "**USB Settings**"→"**Media Server**", you can create media server that allows you to share stored content with other computers and devices on your home network and on the Internet.

**Media Server Settings**

**Server Enable:**  Enable  Disable

**Server Name:**

**Content Scan:** Manual Scan:

Auto Scan: Every  hour(s)

Figure 4-63

- **Server Enable:** Select this box to enable this function.
- **Server Name:** The name of this Media Server.

**To add a new share folder for your media server, please follow the instructions below:**

- a) Click **Add New Folder** button, and you will see the screen as shown in Figure 4-64.
- b) Enter the name of the share folder in **Share Name** field.
- c) Click the **Apply** button to apply the configuration.

Figure 4-64

- b) Click the **Scan now** to scan all the share folders immediately. You can also select the **Auto-scan**, at same time, select an auto scan interval time by drop-down list. In this case, the media server will auto scan the share folders.

 **Note:**

The max share folders number is 6. If you want share a new folder when the numbers has been reached to be 6, you can delete a share folder and then add a new one.

#### 4.11.6 Print Server

Choose menu "**USB Settings**"→"**Print Server**", you can configure print server on this page as shown below.

Figure 4-65

There are three states of the print server, they are as follows:

- **Online:** Indicates the print service has been turned on, and no user is using the print services at present. You can click the "**Stop**" button to stop the print service.
- **Offline:** Indicates the print service feature is disabled. You can click "**Start**" button to start the print service.
- **Busy:** Indicates the print service has been turned on, but at this moment other users are using print services.

## 4.12 Route Settings

Choose “**Route Settings**”, it includes four menus: **Default Gateway**, **Static Route IPv6 Static Route and RIP Settings**. The detailed descriptions are provided below.

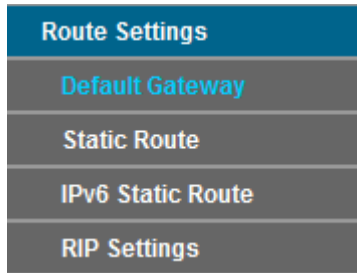

### 4.12.1 Default Gateway

Choose “**Route Settings**”→“**Default Gateway**”, you can see the Default Gateway screen. You can select a WAN Interface from the drop-down list as the system default gateway.

The screenshot shows a form titled 'Default Gateway Setting'. It contains the instruction 'Select a preferred WAN interface as the system default gateway.' Below this is a label 'Select WAN Interface:' followed by a dropdown menu showing 'No available interface.' and an 'Add Interface' button. At the bottom center is a 'Save' button.

Figure 4-66

Click the **Add Interface** button, you can add WAN Interfaces.

Click the **Save** button to save your settings.

### 4.12.2 Static Route

Choose “**Route Settings**”→ “**Static Route**”. You can see the Static Route screen, this screen allows you to configure the static routes (shown in Figure 4-67). A static route is a pre-determined path that network information must travel to reach a specific host or network.

The screenshot shows a page titled 'Static Route'. It contains the text 'This page displays static route table. Click relevant button to configure it.' Below this is a table with the following data:

<input type="checkbox"/>	Destination IP Address	Subnet Mask	Gateway	Status	Edit
<input type="checkbox"/>	202.96.134.210	255.255.255.0	172.30.74.1	Enabled	<a href="#">Edit</a>

Below the table are four buttons: 'Add New', 'Enable Selected', 'Disable Selected', and 'Delete Selected'. At the bottom center is a 'Refresh' button.

Figure 4-67

**To add static routing entries:**

1. Click the **Add New** button in Figure 4-67, and you will see the screen as shown in Figure 4-68.

Static Route information can be set on this page.

**Destination IP Address:** 202.96.134.210

**Subnet Mask:** 255.255.255.0

**Gateway:** 172.30.74.1

**Interface:** LAN

**Status:** Enabled

Save Back

Figure 4-68

2. Enter the following data:

- **Destination IP Address:** The **Destination IP Address** is the address of the network or host that you want to assign to a static route.
- **Subnet Mask:** The **Subnet Mask** determines which portion of an IP Address is the network portion, and which portion is the host portion.
- **Gateway:** Here you should type the Gateway address correctly, and the option for **Interface** will adopt the default Gateway address for the Static Route.
- **Interface:** Select the Interface name in the text box, or else, the default Use Interface will be adopted for the Static Route.
- **Status:** Select **Enabled** or **disabled** from the drop-down list.

3. Click **Save** to save your settings as shown in Figure 4-68.

#### To modify or delete an existing entry:

- 1 Find the desired entry in the table.
- 2 Click **Edit** as desired on the **Edit** column.

Click the **Enable/ Disabled Selected** button to make selected entries enabled/ disabled.

Click the **Delete Selected** button to delete selected entries.

#### 4.12.3 IPv6 Static Route

Choose “**Route Settings**”→ “**IPv6 Static Route**”. You can see the IPv6 Static Route screen. This screen allows you to configure the IPv6 static routes (shown in Figure 4-67). An IPv6 static route is a pre-determined path that network information must travel to reach a specific host or network.

This page displays IPv6 static route table. Click relevant button to configure it.

<input type="checkbox"/>	Destination IPv6 Address/Prefix Length	Gateway	Status	Edit
<p>Add New Enable Selected Disable Selected Delete Selected</p>				

Refresh

Figure 4-69

To add a new entry, follow the instructions below.

1. Click the **Add New** button in Figure 4-69, and you will see the screen as shown in Figure 4-70.

Figure 4-70

2. Enter the following data:
  - **Destination IPv6 Address:** The **Destination IPv6 Address** is the address of the network or host that you want to assign to a static route.
  - **Prefix Length:** The prefix length of the destination IPv6 address.
  - **Gateway:** Here you should type the IPv6 Gateway address correctly, and the option for **Interface** will adopt the default IPv6 Gateway address for the IPv6 Static Route.
  - **Interface:** Select the Interface name from the drop-down list, or else, the default Interface will be adopted for the IPv6 Static Route.
  - **Status:** Select **Enabled** or **Disabled** from the drop-down list.
3. Click **Save** to save your settings.

**To modify or delete an existing entry:**

1. Find the desired entry in the table.
2. Click **Edit** as desired on the **Edit** column.

Click the **Enable/ Disabled Selected** button to make selected entries enabled/ disabled.

Click the **Delete Selected** button to delete selected entries.

#### 4.12.4 RIP Settings

Choose "**Route Settings**"→"**RIP Settings**", you can see the RIP (Routing Information Protocol) screen which allows you to configure the RIP.



RIP Settings			
<p>To activate RIP for the WAN interface, select the desired RIP version and operation and place a check in the 'Enabled' checkbox. To stop RIP on the WAN interface, uncheck the 'Enabled' checkbox. Click the 'Save/Apply' button to start/stop RIP and save the configuration.</p> <p><b>NOTE:</b> RIP cannot be configured on the WAN interface which has NAT enabled.</p>			
Interface	Version	Operation	Enabled
			<input type="checkbox"/>
<input type="button" value="Save"/>			

Figure 4-71

 **Note:**

RIP cannot be configured on the WAN Interface which has NAT enabled (such as PPPoE).

## 4.13 Forwarding

Forwarding
Virtual Servers
Port Triggering
DMZ
UPnP

There are four submenus under the Forwarding menu: **Virtual Servers**, **Port Triggering**, **DMZ** and **UPnP**. Click any of them, and you will be able to configure the corresponding function.

### 4.13.1 Virtual Servers

Choose menu “**Forwarding**” → “**Virtual Servers**”, and then you can view and add virtual servers in the next screen (shown in Figure 4-72). Virtual servers can be used for setting up public services on your LAN. A virtual server is defined as a service port, and all requests from Internet to this service port will be redirected to the computer specified by the server IP. Any PC that was used for a virtual server must have a static or reserved IP address because its IP address may change when using the DHCP function.

Virtual Server						
<p>Virtual server defines the mapping from WAN service port to LAN server. All requests from the Internet to this service port will be redirected to the computer specified by the server IP.</p>						
<input type="checkbox"/>	Service Port	IP Address	Protocol	Status	WAN	Edit
<input type="checkbox"/>	21	192.168.1.100	TCP or UDP	Enabled	pppoe_8_35_2	<a href="#">Edit</a>
<input type="button" value="Add New"/>		<input type="button" value="Enable Selected"/>		<input type="button" value="Disable Selected"/>		<input type="button" value="Delete Selected"/>
<input type="button" value="Refresh"/>						

Figure 4-72

- **Service Port:** The numbers of External Service Ports. You can enter a service port or a range of service ports (the format is XXX – YYY; XXX is the Start port and YYY is the End port).
- **IP Address:** The IP address of the PC running the service application.
- **Protocol:** The protocol used for this application, either **TCP**, **UDP**, or **All** (all protocols)

supported by the modem router).

- **Status:** The status of this entry, "Enabled" means the virtual server entry is enabled.
- **Edit:** To modify or delete an existing entry.

#### To set up a virtual server entry:

1. Click the **Add New** button. (pop-up Figure 4-73)
2. Select the service you want to use from the **Common Service Port** list. If the **Common Service Port** menu does not list the service that you want to use, enter the number of the service port or service port range in the **Service Port** field.
3. Enter the IP address of the computer running the service application in the **IP Address** field.
4. Select the protocol used for this application in the **Protocol** drop-down list, either **TCP**, **UDP**, or **All**.
5. Select the **Enabled** option in the **Status** drop-down list.

Click the **Save** button.

Figure 4-73

#### **Note:**

It is possible that you have a computer or server that has more than one type of available service. If so, select another service, and type the same IP address for that computer or server.

#### To modify or delete an existing entry:

1. Find the desired entry in the table.
2. Click **Edit** as desired on the **Edit** column.

Click the **Enable/ Disabled Selected** button to make selected entries enabled/ disabled.

Click the **Delete Selected** button to delete selected entries.

#### **Note:**

If you set the service port of the virtual server as 80, you must set the Web management port on **System Tools → Manage Control** page to be any other value except 80 such as 8080. Otherwise there will be a conflict to disable the virtual server.

### 4.13.2 Port Triggering

Choose menu "**Forwarding**" → "**Port Triggering**", you can view and add port triggering in the next screen (shown in Figure 4-74). Some applications require multiple connections, like Internet

games, video conferencing, Internet telephoning and so on. Port Triggering is used for some of these applications that cannot work with a pure NAT modem router.

Port Trigger						
Some applications require multiple connections, such as Internet games, video conferences, Internet callings and so on. Due to firewall, these applications cannot work with a pure NAT Router. Port Triggering can help some of these applications deal with this problem.						
<input type="checkbox"/>	Trigger Port	Trigger Protocol	Open Port	Open Protocol	Status	Edit
<input type="checkbox"/>	6112	TCP or UDP	6112	TCP or UDP	Enable	<a href="#">Edit</a>
<input type="button" value="Add New"/>		<input type="button" value="Enable Selected"/>	<input type="button" value="Disable Selected"/>	<input type="button" value="Delete Selected"/>		
<input type="button" value="Refresh"/>						

Figure 4-74

To add a new rule, follow the steps below.

1. Click the **Add New** button, the next screen will pop-up as shown in Figure 4-75.
2. Select a common application from the **Common Service Port** drop-down list, then the **Trigger Port** field and the **Open Ports** field will be automatically filled. If the **Common Service Port** does not have the application you need, enter the **Trigger Port** and the **Open Ports** manually.
3. Select the protocol used for Trigger Port from the **Trigger Protocol** drop-down list, either **TCP**, **UDP**, or **All**.
4. Select the protocol used for Incoming Ports from the **Open Protocol** drop-down list, either **TCP** or **UDP**, or **All**.
5. Select **Enable** in **Status** field.
6. Click the **Save** button to save the new rule.

Port Trigger	
Some applications require multiple connections, such as Internet games, video conferences, Internet callings and so on. Due to firewall, these applications cannot work with a pure NAT Router. Port Triggering can help some of these applications deal with this problem.	
Note: Port Triggering is supported only when there is available interface.	
<b>Interface:</b>	<input type="text" value="No available interfac"/>
<b>Trigger Port:</b>	<input type="text" value=""/> (XX)
<b>Trigger Protocol:</b>	<input type="text" value="ALL"/>
<b>Open Port:</b>	<input type="text" value=""/> (XX or XX-XX or XX-XX,XX)
<b>Open Protocol:</b>	<input type="text" value="ALL"/>
<b>Status:</b>	<input type="text" value="Enabled"/>
<b>Common Service Port:</b>	<input type="text" value="---Please Select---"/>
<input type="button" value="Save"/> <input type="button" value="Back"/>	

Figure 4-75

- **Interface:** Display the default gateway you have ser in [4.5.1 WAN Settings](#).
- **Trigger Port:** The port for outgoing traffic. An outgoing connection using this port will trigger this rule.
- **Trigger Protocol:** The protocol used for Trigger Ports, either **TCP**, **UDP**, or **All** (all protocols supported by the modem router).

- **Open Port:** The port or port range used by the remote system when it responds to the outgoing request. A response using one of these ports will be forwarded to the PC which triggered this rule. You can input at most 5 groups of ports (or port sections). Every group of ports must be separated with ",", for example, 2000-2038, 2046, 2050-2051, 2085, 3010-3030.
- **Open Protocol:** The protocol used for **Incoming Port**, either **TCP**, **UDP**, or **ALL** (all protocols supported by the modem router).
- **Status:** The status of this entry, Enabled means the Port Triggering entry is enabled.
- **Common Service Port:** Some popular applications already listed in the drop-down list of **Open Protocol**.

#### To modify or delete an existing entry:

1. Find the desired entry in the table.
2. Click **Edit** as desired on the **Edit** column.

Click the **Enable/ Disabled Selected** button to make selected entries enabled/ disabled.

Click the **Delete Selected** button to delete selected entries.

#### Once the modem router is configured, the operation is as follows:

1. A local host makes an outgoing connection to an external host using a destination port number defined in the **Trigger Port** field.
2. The modem router records this connection, opens the incoming port or ports associated with this entry in the **Port Triggering** table, and associates them with the local host.
3. When necessary, the external host will be able to connect to the local host using one of the ports defined in the **Incoming Ports** field.



#### Note:

1. When the trigger connection is released, the corresponding opened ports will be closed.
2. Each rule can only be used by one host on the LAN at a time. The trigger connection of other hosts on the LAN will be refused.
3. **Open Ports** ranges cannot overlap each other.

#### 4.13.3 DMZ

Choose menu "**Forwarding**→**DMZ**", and then you can view and configure DMZ host in the screen (shown in Figure 4-76). The DMZ host feature allows one local host to be exposed to the Internet for a special-purpose service such as Internet gaming or videoconferencing. The modem router forwards packets of all services to the DMZ host. Any PC whose port is being forwarded must have its DHCP client function disabled and should have a new static IP Address assigned to it because its IP Address may be changed when using the DHCP function.

Figure 4-76

#### To assign a computer or server to be a DMZ server:

1. Click the **Enable** button.
2. Enter the IP address of a local PC that is set to be DMZ host in the **DMZ Host IP Address** field.
3. Click the **Save** button.

#### 4.13.4 UPnP

Choose menu “**Forwarding→UPnP**”, and then you can view the information about **UPnP** in the screen (shown in Figure 4-77). The **Universal Plug and Play (UPnP)** feature allows the devices, such as Internet computers, to access the local host resources or devices as needed. UPnP devices can be automatically discovered by the UPnP service application on the LAN.

Figure 4-77

- **Current UPnP Status:** UPnP can be enabled or disabled by clicking the **Enable** or **Disable** button. This feature is enabled by default.
- **Current UPnP Settings List:** This table displays the current UPnP information.
  - **App Description:** The description about the application which initiates the UPnP request.
  - **External Port:** The port which the modem router opens for the application.
  - **Protocol:** The type of protocol which is opened.
  - **Internal Port:** The port which the modem router opened for local host.
  - **IP Address:** The IP address of the local host which initiates the UPnP request.
  - **Status:** Either Enabled or Disabled. "Enabled" means that the port is still active; otherwise, the port is inactive.

Click the **Enable** button to enable UPnP.

Click the **Disable** button to disable UPnP.

Click the **Refresh** button to update the Current UPnP Settings List.

## 4.14 Parental Control

Choose menu “**Parental Control**”, and you can configure the parental control in the screen as shown in Figure 4-78. The Parental Control function can be used to control the Internet activities of the child, limit the child to access certain websites and restrict the time of surfing.

Parent Control

Parent Control function can be used to control the Internet activities of children/guests and limit the access to specified websites during specified time period.

Enable Parent Control

MAC Address Of Parental PC:

MAC Address of Current PC: 40:61:86:FC:74:93

MAC Address - 1:

MAC Address - 2:

MAC Address - 3:

MAC Address - 4:

MAC Address in current LAN: 40:61:86:FC:74:93  --Please Select--

Apply To:   00:00  24:00

Time	0:00	1:00	2:00	3:00	4:00	5:00	6:00	7:00	8:00	9:00	10:00	11:00	12:00	13:00	14:00
Sun.															
Mon.															
Tues.															
Wed.															
Thur.															
Fri.															
Sat.															

Add URL:

(It will not take effect until you save it.)

Figure 4-78

- **Enable Parental Control:** Check the box if you want this function to take effect. This function is disabled by default.
- **MAC Address of Parental PC:** In this field, enter the MAC address of the controlling PC, or you can make use of the **Copy To Above** button below.
- **MAC Address of Current PC:** This field displays the MAC address of the PC that is managing this modem router. If the MAC Address of your adapter is registered, you can click the Copy To Above button to fill this address to the MAC Address of Parental PC field above.
- **Add URL:** Here you can input the net addresses which the child is allowed to access.

Click the **Save** button to save your settings.

## 4.15 IPv4 Firewall

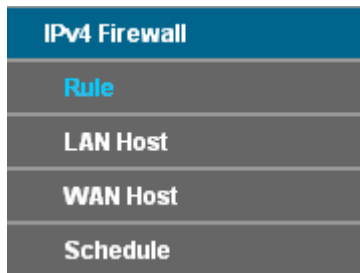

There are four submenus under the Firewall menu: **Rule**, **LAN Host**, **WAN Host** and **Schedule**. Click any of them, and you will be able to configure the corresponding function.

### 4.15.1 Rule

Choose menu “**Firewall**” → “**Rule**”, and then you can view and set Access Control rules in the screen as shown in Figure 4-79.

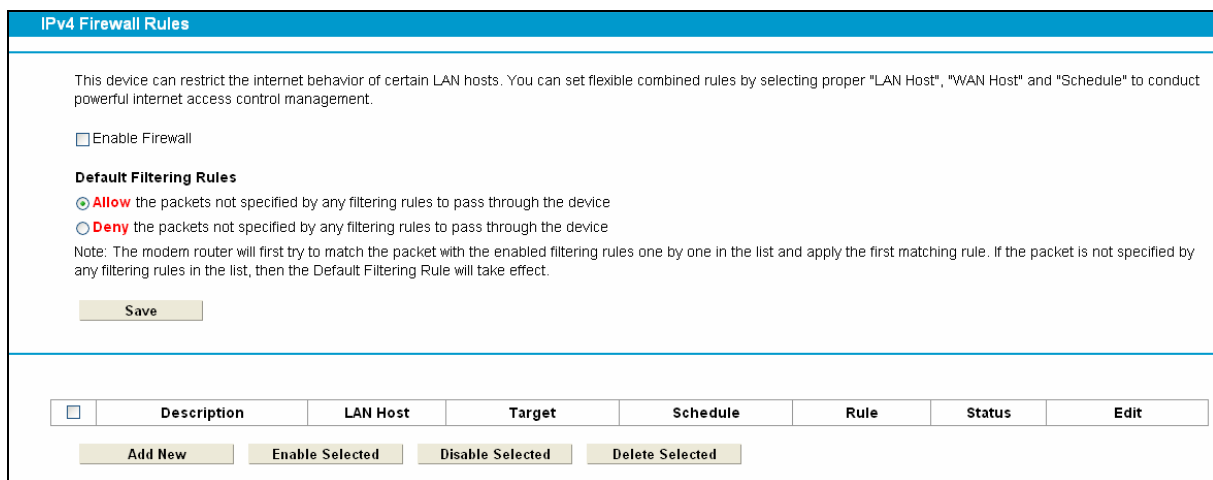

Figure 4-79

- **Enable Firewall:** Select the check box to enable the Firewall function, so the Default Filtering Rules can take effect.
- **Description:** Here displays the description of the rule and this name is unique.
- **LAN Host:** Here displays the host selected in the corresponding rule.
- **Target:** Here displays the target selected in the corresponding rule.
- **Schedule:** Here displays the schedule selected in the corresponding rule.
- **Status:** Here displays the status of the rule, enabled or not.
- **Edit:** Here you can edit or delete an existing rule.
- **Add New:** Click the **Add New** button to add a new rule entry.
- **Enable Selected:** Click the **Enable Selected** button to enable the selected rules in the list.
- **Disable Selected:** Click the **Disable Selected** button to disable the selected rules in the list.
- **Delete Selected:** Click the **Delete Selected** button to delete the selected entries in the table.

### The methods to add a new rule:

1. Click the **Add New** button and the next screen will pop up as shown in Figure 4-80.
2. Give a name (e.g. Rule\_1) for the rule in the **Description** field.
3. Select a host from the **LAN Host** drop-down list or choose “**Add LAN Host**”.
4. Select a target from the **WAN Host** drop-down list or choose “**Add WAN Host**”.
5. Select a schedule from the **Schedule** drop-down list or choose “**Add Schedule**”.
6. In the **Action** field, select **Deny** or **Allow** to deny or allow your entry.
7. In the **Status** field, select **Enabled** or **Disabled** to enable or disable your entry.
8. In the **Direction** field, select **IN** or **OUT** from the drop-down list for the direction.
9. In the **Protocol** field, here are four options, All, TCP, UDP, and ICMP. Select one of them from the drop-down list for the target.
10. Click the **Save** button.

Figure 4-80

### 4.15.2 LAN Host

Choose menu “**Firewall**” → “**LAN Host**”, and then you can view and set a Host list in the screen as shown in Figure 4-81.

<input type="checkbox"/>	Description	Address Info	Edit
<input checked="" type="checkbox"/>	Host_1	192.168.1.88	<a href="#">Edit</a>

Figure 4-81

- **Description:** Here displays the description of the host and this description is unique.
- **Address Info:** Here displays the information about the host. It can be IP or MAC.
- **Edit:** To modify an existing entry.



To add a new entry, please follow the steps below.

1. Click the **Add New** button.
2. In the **Mode** field, select IP Address or MAC Address.
  - If you select IP Address, please follow the steps below:
    - 1) In **Description** field, create a unique description for the host (e.g. Host\_1).
    - 2) In **IP Address** field, enter the IP address.
  - If you select MAC Address, please follow the steps below:
    - 1) In **Description** field, create a unique description for the host (e.g. Host\_1).
    - 2) In **MAC Address** field, enter the MAC address.
3. Click the **Save** button to complete the settings.

Click the **Delete Selected** button to delete the selected entries in the table.

### 4.15.3 WAN Host

Choose menu “**Firewall**” → “**WAN Host**”, and then you can view and set a Host list in the screen as shown in Figure 4-82.

WAN HOST			
<input type="checkbox"/>	<b>Description</b>	<b>Details</b>	<b>Edit</b>
<input type="checkbox"/>	Host_1	202.114.71.2	<a href="#">Edit</a>
<b>Add New</b>		<b>Delete Selected</b>	

Figure 4-82

- **Description:** Here displays the description about the WAN and this description is unique.
- **Details:** The details can be IP address, port, or domain name.
- **Edit:** To modify an existing entry.

To add a new entry, please follow the steps below.

1. Click the **Add New** button.
2. In Mode field, select **IP Address**, **MAC Address** or **URL Address**.

If you select **IP Address**, the screen shown is Figure 4-83.

WAN HOST	
<b>Mode:</b>	IP Address <input type="button" value="v"/>
<b>Description:</b>	<input type="text"/>
<b>IP Address:</b>	<input type="text"/> - <input type="text"/>
<b>Port:</b>	<input type="text"/> - <input type="text"/>
<input type="button" value="Save"/> <input type="button" value="Back"/>	

Figure 4-83

- 1) In **Description** field, create a unique description for the host (e.g. Host\_1).

2) In **IP Address** field, enter the IP address.

If you select **MAC Address**, the screen shown is Figure 4-84.

The screenshot shows the 'WAN HOST' configuration page. At the top, there is a blue header with the text 'WAN HOST'. Below the header, the 'Mode' is set to 'MAC Address' in a dropdown menu. There are two text input fields: 'Description:' and 'MAC Address:'. At the bottom of the page, there are two buttons: 'Save' and 'Back'.

Figure 4-84

1) In **Description** field, create a unique description for the host (e.g. Host\_1).

2) In **MAC Address** field, enter the MAC address.

If you select **URL Address**, the screen shown is Figure 4-85.

The screenshot shows the 'WAN HOST' configuration page. At the top, there is a blue header with the text 'WAN HOST'. Below the header, the 'Mode' is set to 'URL Address' in a dropdown menu. There are two text input fields: 'Description:' and 'Add URL Address:'. To the right of the 'Add URL Address' field is an 'Add' button. Below these fields is a table with one row and one column. The table has a checkbox in the first column and the text 'Detail' in the second column. Below the table is a 'Delete' button with the text '(It won't take effect until you save it)'. At the bottom of the page, there are two buttons: 'Save' and 'Back'.

Figure 4-85

1) In **Description** field, create a unique description for the host (e.g. Host\_1).

2) Enter the URL address in the **Add URL Address** field, and then click the **Add** button. The URL address will be shown in the **Detail** table. If you click the **Delete** button, the existing URL address in the **Detail** table can be deleted.

3. Click the **Save** button to complete the settings.

#### 4.15.4 Schedule

Choose menu "**Firewall**" → "**Schedule**", and then you can view and set a Schedule list in the next screen as shown in Figure 4-86.

The screenshot shows the 'Task Schedule' page. At the top, there is a blue header with the text 'Task Schedule'. Below the header, there is a table with two columns: 'Description' and 'Edit'. The table has one row with the text 'Schedule\_1' in the 'Description' column and a blue link 'Edit' in the 'Edit' column. Below the table, there are two buttons: 'Add New' and 'Delete Selected'.

Figure 4-86

➤ **Description:** Here displays the description of the schedule and this description is unique.

➤ **Edit:** Here you can modify an existing schedule.

**To add a new schedule, follow the steps below:**

1. Click **Add New** button and the next screen will pop-up as shown in Figure 4-87.
2. In **Description** field, create a unique description for the schedule (e.g. Schedule\_1).
3. In **Apply To** field, select the day or days you need.
4. In time field, you can select all day-24 hours or you may enter the **Start Time** and **Stop Time** in the corresponding field.
5. Click **Save** to complete the settings.

Click the **Clear Schedule** button to clear your settings in the table.

Schedule can be set on this page.

**Description:**

**Apply To:**  **Start Time:**  **End Time:**

Time	0:00	1:00	2:00	3:00	4:00	5:00	6:00	7:00	8:00	9:00	10:00	11:00	12:00	1:00	2:00
Sun.															
Mon.															
Tues.															
Wed.															
Thur.															
Fri.															
Sat.															

Figure 4-87

Click the **Delete Selected** button to delete the selected entries in the table.

## 4.16 IPv6 Firewall

<b>IPv6 Firewall</b>
IPv6 Rule
IPv6 LAN Host
IPv6 WAN Host
IPv6 Schedule

There are four submenus under the IPv6 Firewall menu: **IPv6 Rule**, **IPv6 LAN Host**, **IPv6 WAN Host** and **IPv6 Schedule**. Click any of them, and you will be able to configure the corresponding function.

### 4.16.1 IPv6 Rule

Choose menu “IPv6 Firewall” → “IPv6 Rule”, and then you can view and set Access Control rules in the screen as shown in Figure 4-88.

Figure 4-88

- **Enable IPv6 Firewall:** Select the check box to enable the IPv6 Firewall function, so the Default Filtering Rules can take effect.
- **Description:** Here displays the description of the IPv6 rule and this name is unique.
- **IPv6 LAN Host:** Here displays the LAN host selected in the corresponding rule.
- **Target:** Here displays the target selected in the corresponding rule.
- **Schedule:** Here displays the schedule selected in the corresponding rule.
- **Status:** Here displays the status of the rule either enabled or disabled.
- **Edit:** Here you can edit or delete an existing rule.

#### To add a new IPv6 rule:

1. Click the **Add New** button, and you will see the screen as shown in Figure 4-89.

Figure 4-89

2. Give a name (e.g. Rule\_1) for the rule in the **Description** field.
3. Select a host from the **IPv6 LAN Host** drop-down list or choose “**Add IPv6 LAN Host**”.

4. Select a target from the **IPv6 WAN Host** drop-down list or choose “**Add IPv6 WAN Host**”.
5. Select a schedule from the **IPv6 Schedule** drop-down list or choose “**Add IPv6 Schedule**”.
6. In the **Action** field, select **Deny** or **Allow** to deny or allow your entry.
7. In the **Status** field, select **Enabled** or **Disabled** to enable or disable your entry.
8. In the **Direction** field, select **IN** or **OUT** from the drop-down list for the direction.
9. In the **Protocol** field, here are four options, All, TCP, UDP, and ICMPv6. Select one of them from the drop-down list for the target.
10. Click the **Save** button to save the settings.

Click the **Enable/ Disable Selected** button to make selected entries enabled or disabled.

Click the **Delete Selected** button to delete selected entries.

#### 4.16.2 IPv6 LAN Host

Choose menu “**IPv6 Firewall**” → “**IPv6 LAN Host**”, and then you can view and set a Host list in the screen as shown in Figure 4-90.

IPv6 LAN HOST			
<input type="checkbox"/>	Description	IPv6 Address Info	Edit
<input type="checkbox"/>	IPv6 LAN1	2000::/64 /888-999	<a href="#">Edit</a>
<input type="button" value="Add New"/>		<input type="button" value="Delete Selected"/>	

Figure 4-90

- **Description:** Here displays the description of the host and this description is unique.
- **IPv6 Address Info:** Here displays the information about the host.
- **Edit:** To modify an existing entry.

**To add a new entry, please follow the steps below.**

1. Click the **Add New** button, and you will see the screen as shown in Figure 4-91.

IPv6 LAN Host	
<b>Description:</b>	<input type="text" value="IPv6 LAN1"/>
<b>IPv6 Address:</b>	<input type="text" value="2000::"/>
<b>Prefix Length:</b>	<input type="text" value="64"/>
<b>Port:</b>	<input type="text" value="888"/> - <input type="text" value="999"/>
<input type="button" value="Save"/> <input type="button" value="Back"/>	

Figure 4-91

2. Create a unique name for the host (e.g. Host\_1) in the **Description** field.
3. Enter an IPv6 address in the **IPv6 Address** field.
4. Enter the prefix length of the IPv6 address in the **Prefix Length** field.
5. Click the **Save** button to save the settings.

Click the **Delete Selected** button to delete selected entries.

### 4.16.3 IPv6 WAN Host

Choose menu “IPv6 Firewall” → “IPv6 WAN Host”, and then you can view and set a Host list in the screen as shown in Figure 4-92.

IPv6 WAN Host			
<input type="checkbox"/>	<b>Description</b>	<b>Details</b>	<b>Edit</b>
<input type="checkbox"/>	IPv6 WAN1	3333::/64 /888-999	<a href="#">Edit</a>
<input type="button" value="Add New"/>		<input type="button" value="Delete Selected"/>	

Figure 4-92

- **Description:** Here displays the description about the WAN and this description is unique.
- **Details:** The details can be IPv6 address, prefix length or port.
- **Edit:** To modify an existing entry.

To add a new entry, please follow the steps below.

1. Click the **Add New** button, and you will see the screen as shown in Figure 4-93.

IPv6 WAN Host	
<b>Description:</b>	<input type="text" value="IPv6 WAN1"/>
<b>IPv6 Address:</b>	<input type="text" value="3333::"/>
<b>Prefix Length:</b>	<input type="text" value="64"/>
<b>Port:</b>	<input type="text" value="888"/> - <input type="text" value="999"/>
<input type="button" value="Save"/> <input type="button" value="Back"/>	

Figure 4-93

2. Create a unique description for the host (e.g. Host\_1) in the **Description** field.
3. Enter an IPv6 address in the **IPv6 Address** field.
4. Enter the prefix length of the IPv6 address in the **Prefix Length** field.
5. Click the **Save** button to save the settings.

Click the **Delete Selected** button to delete selected entries.

### 4.16.4 IPv6 Schedule

Choose menu “IPv6 Firewall” → “IPv6 Schedule”, and then you can view and set a Schedule list in the next screen as shown in Figure 4-94.

IPv6 Task Schedule			
<input type="checkbox"/>	<b>Description</b>	<b>Edit</b>	
<input type="checkbox"/>	IPv6 Sche1	<a href="#">Edit</a>	
<input type="button" value="Add New"/>		<input type="button" value="Delete Selected"/>	

Figure 4-94

- **Description:** Here displays the description of the schedule and this description is unique.
- **Edit:** Here you can modify an existing schedule.

**To add a new schedule, follow the steps below:**

1. Click **Add New** button and you will see the screen as shown in Figure 4-95.

Figure 4-95

2. Create a unique description for the schedule (e.g. Schedule\_1) in **Description** field.
3. Select the day or days you need in **Apply To** field.
4. In time field, you can select all day-24 hours or you may enter the **Start Time** and **Stop Time** in the corresponding field.
5. Click **Save** to save the settings.

Click the **Clear Schedule** button to clear your settings in the table.

Click the **Delete Selected** button to delete selected entries.

## 4.17 IPv6 Tunnel

IPv6 tunnel is a kind of transition mechanism to enable IPv6-only hosts to reach IPv4 services and to allow isolated IPv6 hosts and networks to reach each-other over IPv4-only infrastructure before IPv6 completely supplants IPv4. It is a temporary solution for networks that do not support native dual-stack, where both IPv6 and IPv4 run independently.

Choose menu "**IPv6 Tunnel**", and you will see the screen as shown in Figure 4-96.

Figure 4-96

- **Enable:** Check the box to enable IPv6 Tunnel function. It is disabled by default.
- **Mechanism:** Select a type for IPv6 tunnel from the drop-down list. DS-Lite, 6RD and 6to4 are supported.

### 1) DS-Lite

This type is used in the situation that your WAN connection is IPv6 while LAN connection is IPv4. Select DS-Lite, and you will see the screen as shown in Figure 4-97.

Figure 4-97

- **WAN Connection:** Select a WAN connection from the drop-down list. Only the connected WAN connections can be shown in the drop-down list.
- **Configuration Type:** Select a configuration type for this tunnel. Auto means to obtain the Remote IPv6 Address automatically while Manual means you set it manually.
- **Remote IPv6 Address:** Enter the IPv6 address of the remote node.

#### **Note:**

In this type, there should not have any IPv4 WAN connections. If there are IPv4 WAN connections, the page will prompt you to delete all the IPv4 WAN connections.

### 2) 6RD

This type is used in the situation that your WAN connection is IPv4 while LAN connection is IPv6. Select 6RD, and you will see the screen as shown in Figure 4-98.



<b>Enable</b>	<input checked="" type="checkbox"/>
<b>Mechanism:</b>	6RD <input type="button" value="v"/>
<b>WAN Connection:</b>	pppoe_8_35_0_d <input type="button" value="v"/>
<b>Configuration Type:</b>	<input type="radio"/> Auto <input checked="" type="radio"/> Manual
<b>IPv4 Mask Length:</b>	24
<b>6RD Prefix:</b>	2222::
<b>6RD Prefix Length:</b>	24
<b>Border Relay IPv4 Address:</b>	188.88.88.9

Figure 4-98

- **WAN Connection:** Select a WAN connection from the drop-down list. Only the connected WAN connections can be shown in the drop-down list.
- **Configuration Type:** Select a configuration type for this tunnel. Auto means to obtain the following parameters automatically while Manual means you set them manually. If Auto is selected, only Dynamic IP connection can be selected from the drop-down list.
- **IPv4 Mask Length:** The length of the selected WAN connection's IPv4 mask.
- **6RD Prefix:** The prefix of the 6RD tunnel.
- **6RD Prefix Length:** The length of the 6RD prefix.
- **Border Relay IPv4 Address:** The IPv4 address of the border relay router of 6RD tunnel.

 **Note:**

In this type, there should not have any IPv6 WAN connections. If there are IPv6 WAN connections, the page will prompt you to delete all the IPv6 WAN connections.

### 3) 6to4

This type is used in the situation that your WAN connection is IPv4 while LAN connection is IPv6. Select 6to4, and you will see the screen as shown in Figure 4-99.

<b>Enable</b>	<input checked="" type="checkbox"/>
<b>Mechanism:</b>	6to4 <input type="button" value="v"/>
<b>WAN Connection:</b>	pppoe_8_35_0_d <input type="button" value="v"/>

Figure 4-99

- **WAN Connection:** Select a WAN connection from the drop-down list. Only the connected WAN connections can be shown in the drop-down list.

 **Note:**

In this type, there should not have any IPv6 WAN connections. If there are IPv6 WAN connections, the page will prompt you to delete all the IPv6 WAN connections.

## 4.18 Bandwidth Control

Choose menu “**Bandwidth Control**”, and then you can configure the Upstream Bandwidth and Downstream Bandwidth in the next screen. The values you configure should be less than 1000000Kbps. For optimal control of the bandwidth, please select the right Line Type and ask your ISP for the total bandwidth of the egress and ingress.

Note: For optimal control of the bandwidth, please configure the right Line Type and bandwidth. If you are not sure about these information, please ask your ISP for help.

Enable Bandwidth Control

Line Type:  ADSL  Other

Total Upstream Bandwidth: \_\_\_\_\_ Kbps

Total Downstream Bandwidth: \_\_\_\_\_ Kbps

Bandwidth Control Rules

<input type="checkbox"/>	Description	Priority	Upstream Bandwidth		Downstream Bandwidth		Status	Edit
			Min	Max	Min	Max		
<input type="checkbox"/>								

Figure 4-100

- **Enable Bandwidth Control:** Check this box so that the Bandwidth Control settings can take effect.
- **Line Type:** Select the right type for you network connection. If you don't know how to choose, please ask your ISP for the information.
- **Total Upstream Bandwidth** - The upload speed through the WAN port.
- **Total Downstream Bandwidth** - The download speed through the WAN port.
- **Description:** This is the information about the rules such as address range.
- **Priority:** Priority of Bandwidth Control rules. '1' stands for the highest priority while '8' stands for the lowest priority. The total Upstream/ Downstream Bandwidth is first allocated to guarantee all the Min Rate of Bandwidth Control rules. If there is any bandwidth left, it is first allocated to the rule with the highest priority, then to the rule with the second highest priority, and so on.
- **Upstream bandwidth:** This field displays the max and mix upload bandwidth through the WAN port, the default is 0.
- **Downstream bandwidth:** This field displays the max and mix download bandwidth through the WAN port, the default is 0.
- **Status:** The status of this rule either Enabled or Disabled.
- **Edit:** Click **Edit** to modify the rule.

**To add/modify a Bandwidth Control rule, follow the steps below.**

1. Click **Add New** shown in Figure 4-100, you will see a new screen shown in Figure 4-101.
2. Enter the information as the screen shown below.

Figure 4-101

3. Click the **Save** button.

Click the **Enable/ Disable Selected** button to make selected entries enabled or disabled.

Click the **Delete Selected** button to delete selected entries.

## 4.19 IP&MAC Binding

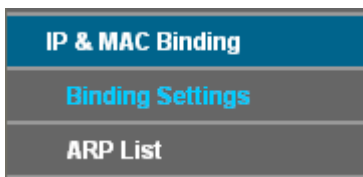

There are two submenus under the IP &MAC Binding menu: **Binding Settings** and **ARP List**. Click any of them, and you will be able to scan or configure the corresponding function. The detailed explanations for each submenu are provided below.

### 4.19.1 Binding Settings

This page displays the **IP & MAC Binding Setting** table; you can operate it in accord with your desire (shown in Figure 4-102).

	MAC Address	IP Address	Binding Status	Edit
<input type="checkbox"/>	40:61:86:FC:74:29	192.168.1.100	Bound	<a href="#">Edit</a>

Figure 4-102

- **MAC Address:** The MAC address of the controlled computer in the LAN.
- **IP Address:** The assigned IP address of the controlled computer in the LAN.
- **Bounding Status:** Check this option to enable ARP binding for a specific device.
- **Edit:** To modify or delete an existing entry.

When you want to add or modify an IP & MAC Binding entry, you can click the **Add New** button or **Edit** button, and then you will go to the next page. This page is used for adding or modifying an IP & MAC Binding entry (shown in Figure 4-103.)

Figure 4-103

**To add IP & MAC Binding entries, follow the steps below.**

1. Click the **Add New** button as shown in Figure 4-102.
2. Enter the MAC Address and IP Address.
3. Select the Bind checkbox.
4. Click the **Save** button to save it.

**To modify or delete an existing entry, follow the steps below.**

1. Find the desired entry in the table.
2. Click **Edit** as desired on the **Edit** column.

Click the **Enable/ Disable Selected** button to make selected entries enabled or disabled.

Click the **Delete Selected** button to delete selected entries.

#### 4.19.2 ARP List

To manage the computer, you could observe the computers in the LAN by checking the relationship of MAC address and IP address on the ARP list, and you could also configure the items on the ARP list. This page displays the ARP List; it shows all the existing IP & MAC Binding entries (shown in Figure 4-104).

ARP List			
<input type="checkbox"/>	MAC Address	IP Address	Status
<input type="checkbox"/>	40:61:86:E5:B2:DC	192.168.1.100	Loaded
<input type="button" value="Load Selected"/>		<input type="button" value="Delete Selected"/>	
<input type="button" value="Refresh"/>			

Figure 4-104

- **MAC Address:** The MAC address of the controlled computer in the LAN.
- **IP Address:** The assigned IP address of the controlled computer in the LAN.
- **Status:** Indicates whether or not the MAC and IP addresses are bound.
- **Load:** Load the item to the IP & MAC Binding list.

Click the **Load Selected** button to load selected items to the IP & MAC Binding list.

Click the **Refresh** button to refresh all items.

## 4.20 Dynamic DNS

Choose menu “**Dynamic DNS**”, and you can configure the Dynamic DNS function.

The modem router offers the **DDNS** (Dynamic Domain Name System) feature, which allows the hosting of a website, FTP server, or e-mail server with a fixed domain name (named by yourself) and a dynamic IP address, and then your friends can connect to your server by entering your domain name no matter what your IP address is. Before using this feature, you need to sign up for DDNS service providers such as [www.dyndns.org](http://www.dyndns.org). The Dynamic DNS client service provider will give you a password or key.



**DDNS Settings**

Parameters of dynDns can be set on this page.

**Service Provider:**  [Go to register...](#)

**Domain Name:**

**User Name:**

**Password:**

**Enable DDNS**

**Connection Status:** Disconnected

Figure 4-105

- **Service Provider:** This field displays the service provider of DDNS.
- **Domain Name:** Enter the Domain name you received from dynamic DNS service provider.
- **Username & Password:** Type the “User Name” and “Password” for your DDNS account.
- **Enable DDNS:** Activate the DDNS function or not.
- **Login/ Logout:** Login to or logout of the DDNS service.

## 4.21 Diagnostic

Choose “**Diagnostic**”, you can view the test results for the connectivity of the physical layer and protocol layer for both LAN and WAN sides in the screen. Select the desired type and click the start button.

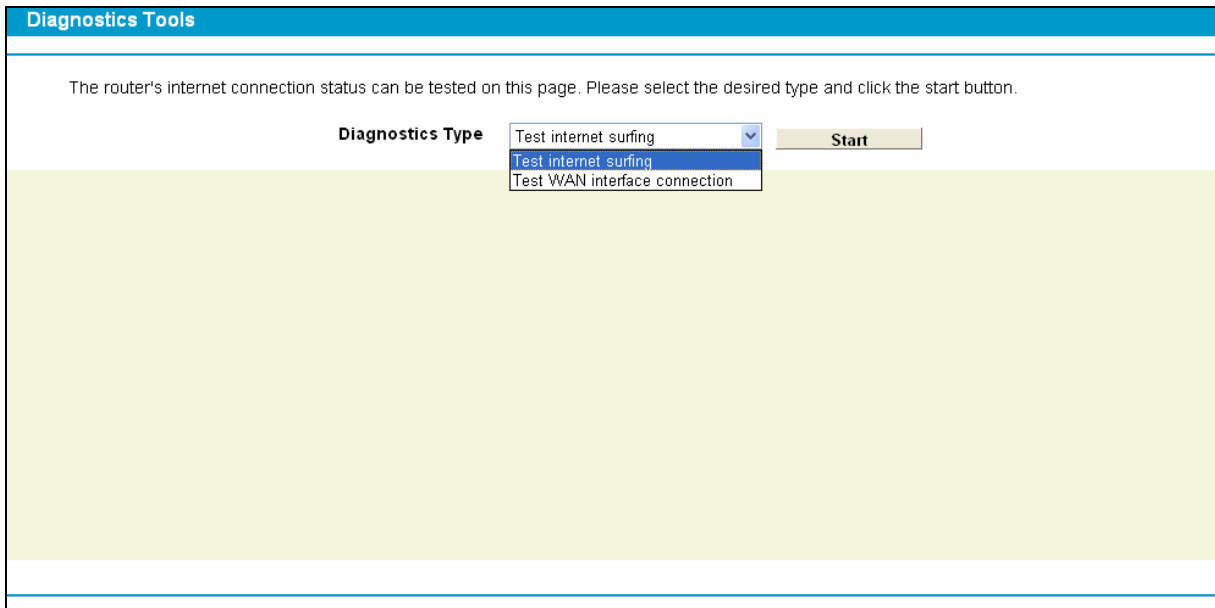

Figure 4-106

## 4.22 System Tools



Choose menu “**System Tools**”, and you can see the submenus under the main menu: **System Log**, **Time Settings**, **Manage Control**, **CWMP Settings**, **SNMP Settings**, **Backup & Restore**, **Factory Defaults**, **Firmware Upgrade**, **Reboot** and **Statistics**. Click any of them, and you will be able to configure the corresponding function. The detailed explanations for each submenu are provided below.

### 4.22.1 System Log

Choose menu “**System Tools**” → “**System Log**”, and then you can view the logs of the modem router.

Figure 4-107

- **Log Type:** By selecting the log type, only logs of this type will be shown.
- **Log Level:** By selecting the log level, only logs of this level will be shown.
- **Refresh:** Refresh the page to show the latest log list.
- **Clear Log:** All the logs will be deleted from the modem router permanently, not just from the page.
- **Save Log:** Click to save all the logs in a txt file.
- **Log Settings:** Click to set the logs in the screen (shown in Figure 4-108).

Figure 4-108

- **Save Locally:** If **Save Locally** is selected, events will be recorded in the local memory.
- **Minimum Level:** Select the Minimum level in the drop-down list, for the Minimum Level, all logged events above or equal to the selected level will be displayed.
- **Save Remotely:** If **Save Remotely** is selected, events will be sent to the specified IP address and UDP port of the remote system log server.

Click the **Save** button to save your settings.

#### 4.22.2 Time Settings

Choose menu “**System Tools**” → “**Time Settings**”, and then you can configure the time on the following screen.

Figure 4-109

- **Time Zone:** Select your local time zone from this pull down list.
- **Date:** Enter your local date in MM/DD/YY into the right blanks.
- **Time:** Enter your local time in HH/MM/SS into the right blanks.
- **NTP Server 1 / NTP Server 2:** Enter the address or domain of the **NTP Server 1** or **NTP Server 2**, and then the modem router will get the time from the NTP Server preferentially. In addition, the modem router built-in some common NTP Servers, so it can get time automatically once it connects the Internet.

#### To set time manually:

1. Select your local time zone.
2. Enter the **Date** in Year/Month/Day format.
3. Enter the **Time** in Hour/Minute/Second format.
4. Click **Save**.

#### To set time automatically:

1. Select your local time zone.
2. Enter the address or domain of the **NTP Server 1** or **NTP Server 2**.
3. Click the **Get GMT** button to get system time from Internet if you have connected to the Internet.

### 4.22.3 Manage Control

Choose “**System Tools**” → “**Manage Control**”, you can see the screen (shown in Figure 4-110)

Manage Control		
<b>Current User Status</b>		
<b>User Type:</b>	Admin	
<b>Username:</b>	admin	
<b>Host IP Address:</b>	192.168.1.100	
<b>Host MAC Address:</b>	6C:62:6D:F7:32:09	
<b>Account Management</b>		
The username and password must not exceed 15 characters in length!		
<b>Old Password:</b>	<input type="text"/>	
<b>New User Name:</b>	<input type="text"/>	
<b>New Password:</b>	<input type="text"/>	
<b>Confirm password:</b>	<input type="text"/>	
<b>Service Configuration</b>		
	<b>HTTP Service</b>	<b>Available Host (IP/MAC)</b>
<b>Local Management</b>	Port <input type="text" value="80"/>	<input type="text"/>
<b>Remote Management</b>	Enable <input type="checkbox"/> Port <input type="text" value="80"/>	<input type="text"/>
<b>ICMP(ping):</b> <input type="checkbox"/> Remote <input checked="" type="checkbox"/> Local		
<input type="button" value="Save"/>		

Figure 4-110

- **Current User Status:** This box displays the information about **User Type**, **User Name**, **Host IP Address** and **Host MAC Address**.



- **Account Management:** Here you can set the account user information about **Old Password, New User Name, New Password and Confirm Password.**
- **Service Configuration:** Here you can modify the port of the modem router's Web-Management page and limit the hosts which can login this modem router's Web-Management page.
- **ICMP(ping):** If you select **Remote**, PCs in public network can ping WAN address of the modem router. If you select **Local**, PCs in private network can ping LAN address of the modem router.

#### 4.22.4 CWMP Settings

Choose "**System Tools**" → "**CWMP Settings**", you can configure the CWMP function in the screen.

The modem router offers CWMP feature. The function supports TR-069 protocol which collects information, diagnoses the devices and configures the devices automatically via ACS (Auto-Configuration Server).

Figure 4-111

- **CWMP:** Select enable the CWMP function.
- **Inform:** Enable or disable the function. If enabled, the information will be informed to ACS server periodically.
- **Inform Interval:** Enter the interval time here.
- **ACS URL:** Enter the website of ACS which is provided by your ISP.
- **ACS User Name/Password:** Enter the User Name and password to login the ACS server.
- **Interface used by TR-069 client:** Select the interface used by TR-069 client.
- **Display SOAP messages on serial console:** Enable or disable this function.
- **Connection Request User Name/Password:** Enter the User Name and Password that provided the ACS server to login the modem router.

- **Connection Request Path:** Enter the path that connects to the ACS server.
- **Connection Request Port:** Enter the port that connects to the ACS server.
- **Connection Request URL:** Enter the URL that connects to the ACS server.

#### 4.22.5 SNMP Settings

Choose “**System Tools**”→“**SNMP Settings**”, you can see the SNMP-Configuration screen as shown below.

**SNMP** (Simple Network Management Protocol) has been widely applied in the computer networks currently, which is used for ensuring the transmission of the management information between any two nodes. In this way, network administrators can easily search and modify the information on any node on the network. Meanwhile, they can locate faults promptly and implement the fault diagnosis, capacity planning and report generating.

Figure 4-112

An **SNMP Agent** is an application running on the modem router that performs the operational role of receiving and processing SNMP messages, sending responses to the SNMP manager, and sending traps when an event occurs. So a router contains SNMP "agent" software can be monitored and/or controlled by SNMP Manager using SNMP messages.

#### 4.22.6 Backup & Restore

Choose menu “**System Tools**” → “**Backup & Restore**”, and then you can save the current configuration of the modem router as a backup file and restore the configuration via a backup file as shown in Figure 4-113.

Figure 4-113

- Click the **Backup** button to save all configuration settings as a backup file in your local computer.
- To upgrade the modem router 's configuration, follow these instructions.
  - Click the **Browse** button to find the configuration file which you want to restore.
  - Click the **Restore** button to update the configuration with the file whose path is the one you have input or selected in the blank.

 **Note:**

The current configuration will be covered with the uploading configuration file. Wrong process will lead the device unmanaged. The restoring process lasts for 20 seconds and the modem router will restart automatically then. Keep the power of the modem router on during the process, in case of any damage.

#### 4.22.7 Factory Defaults

Choose menu “**System Tools** → **Factory Defaults**”, and then and you can restore the configurations of the modem router to factory defaults on the following screen

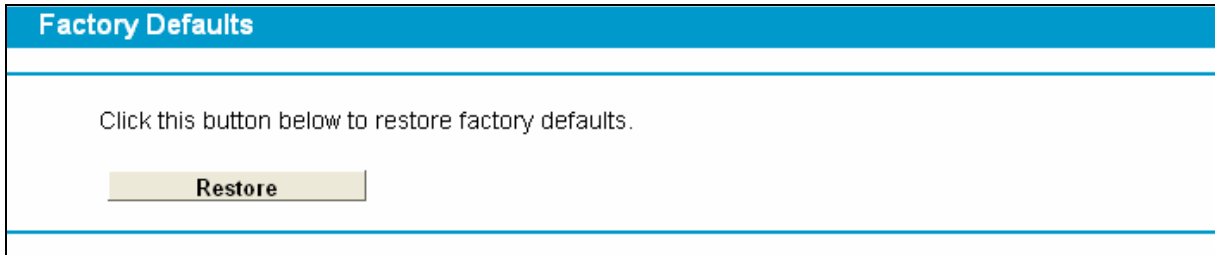

Figure 4-114

Click the **Restore** button to reset all configuration settings to their default values.

- The default **User Name**: admin
- The default **Password**: admin
- The default **Subnet Mask**: 255.255.255.0

 **Note:**

All changed settings will be lost when defaults are restored.

#### 4.22.8 Firmware Upgrade

Choose menu “**System Tools** → **Firmware Upgrade**”, and then you can update the latest version of firmware for the modem router on the following screen.

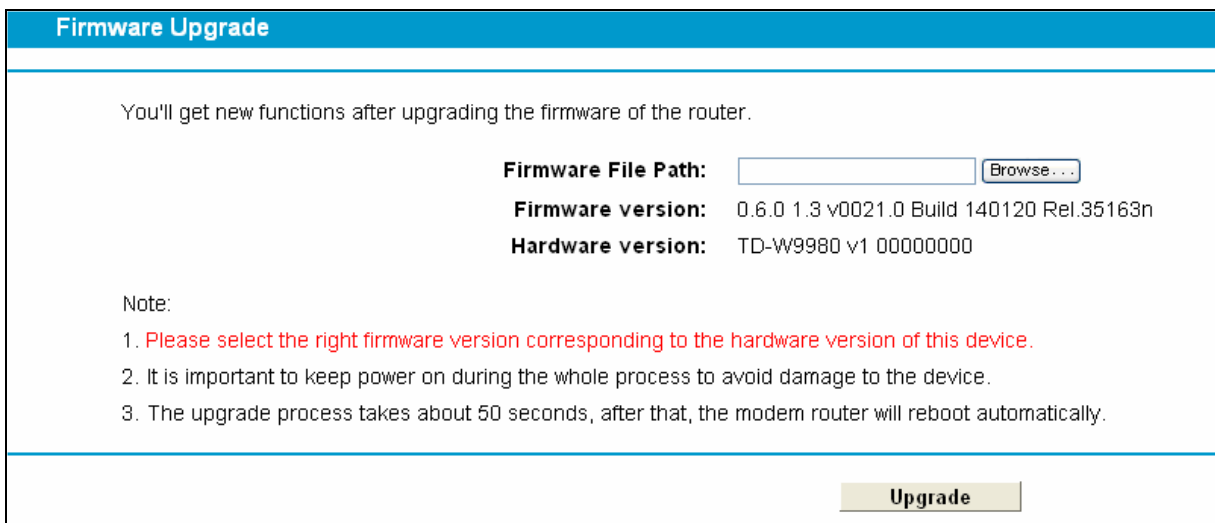

Figure 4-115

- **Firmware Version:** Displays the current firmware version.
- **Hardware Version:** Displays the current hardware version. The hardware version of the upgrade file must accord with the modem router's current hardware version.

**To upgrade the modem router's firmware, follow these instructions below:**

- 1) Download a most recent firmware upgrade file from our website ([www.tp-link.com](http://www.tp-link.com)).
- 2) Enter or select the path name where you save the downloaded file on the computer into the **File Name** blank.
- 3) Click the **Upgrade** button.
- 4) The modem router will reboot while the upgrading has been finished.

 **Note:**

- 1) New firmware versions are posted at <http://www.tp-link.com> and can be downloaded for free. There is no need to upgrade the firmware unless the new firmware has a new feature you want to use. However, when experiencing problems caused by the modem router rather than the configuration, you can try to upgrade the firmware.
- 2) When you upgrade the modem router's firmware, you may lose its current configurations, so before upgrading the firmware please write down some of your customized settings to avoid losing important settings.
- 3) Do not turn off the modem router or press the Reset button while the firmware is being upgraded. Loss of power during the upgrade could damage the modem router.
- 4) The firmware version must correspond to the hardware.
- 5) The upgrade process takes a few moments and the modem router restarts automatically when the upgrade is complete.

#### 4.22.9 Reboot

Choose menu "**System Tools**" → "**Reboot**", and then you can click the **Reboot** button to reboot the modem router via the next screen.

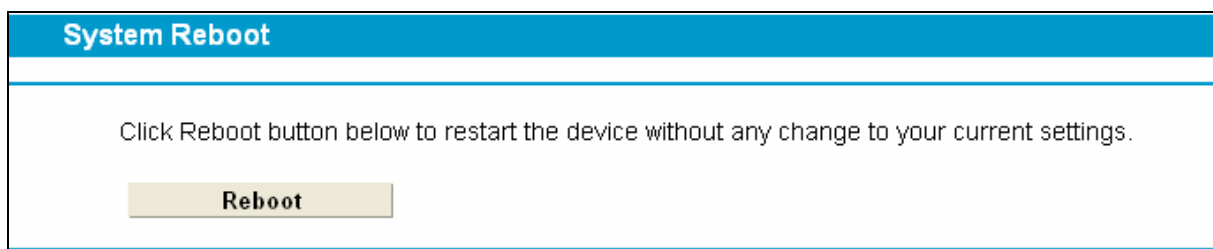

Figure 4-116

Some settings of the modem router will take effect only after rebooting, which include

- Change the LAN IP Address (system will reboot automatically).
- Change the DHCP Settings.
- Change the Wireless configurations.
- Change the Web Management Port.
- Upgrade the firmware of the modem router (system will reboot automatically).

- Restore the modem router's settings to factory defaults (system will reboot automatically).
- Update the configuration with the file (system will reboot automatically).

#### 4.22.10 Statistics

Choose menu “**System Tools**” → “**Statistics**”, and then you can view the statistics of the Modem router, including total traffic and current traffic of the last Packets Statistic Interval.

Figure 4-117

- **Statistics Status:** Enable or Disable. The default value is disabled. To enable it, click the **Enable**. If it is disabled, the function of DoS protection in Security settings will be disabled.
- **Statistics Interval (5-60):** The default value is 10. Select a value between 5 and 60 seconds in the drop-down list. The Packets Statistic interval indicates the time section of the packets statistic.

Click **Reset All** to reset the values of all the entries to zero.

Click **Delete All** to delete all entries in the table.

Click the **Refresh** button to refresh immediately.

Statistics Table:

<b>IP/MAC Address</b>	The IP and MAC address are displayed with related statistics.	
<b>Total</b>	<b>Packets</b>	The total number of packets received and transmitted by the modem router.
	<b>Bytes</b>	The total number of bytes received and transmitted by the modem router.
<b>Current</b>	<b>Packets</b>	The total number of packets received and transmitted in the last Packets Statistic interval seconds.
	<b>Bytes</b>	The total number of bytes received and transmitted in the last Packets Statistic interval seconds.
	<b>ICMP Tx</b>	The number of the ICMP packets transmitted to WAN per second at the specified Packets Statistics interval. It is shown like “current transmitting rate / Max transmitting rate”.

	<b>UDP Tx</b>	The number of UDP packets transmitted to the WAN per second at the specified Packets Statistics interval. It is shown like "current transmitting rate / Max transmitting rate".
	<b>SYN Tx</b>	The number of TCP SYN packets transmitted to the WAN per second at the specified Packets Statistics interval. It is shown like "current transmitting rate / Max transmitting rate".
<b>Operation</b>	<b>Reset</b>	Reset the value of the entry to zero.
	<b>Delete</b>	Delete the existing entry in the table.

## 4.23 Logout

Choose "Logout", and you will back to the login screen as shown in Figure 4-118.

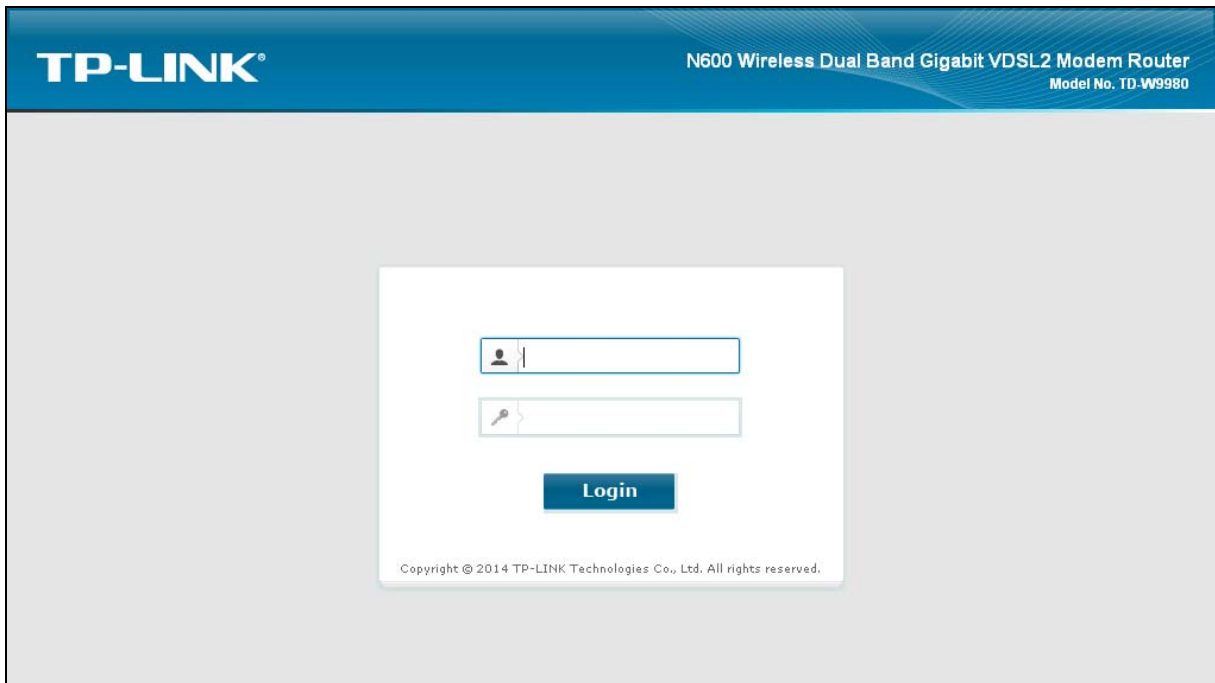









Figure 4-118

## Appendix A: Specifications

General	
Standards and Protocols	ANSI T1.413, ITU G.992.1, ITU G.992.3, ITU G.992.5, ITU G.993.2 IEEE802.11p, IEEE802.11e, IEEE802.11b, IEEE802.11g, IEEE802.11n, IEEE802.3, IEEE802.3u, TCP/IP, PPPoA, PPPoE, SNTP, HTTP, DHCP, ICMP, NAT
Safety & Emission	FCC, CE
Ports	Four 10/100/1000M Auto-Negotiation RJ45 ports (Auto MDI/MDIX) One RJ11 port Two USB 2.0 ports
LEDs	 Power,  DSL,  Internet,  Wireless 2.4GHz,  Wireless 5GHz,  WPS,  1,2,3,4(LAN),  (USB on the back panel)
Network Medium	10Base-T: UTP category 3, 4, 5 cable 100Base-TX: UTP category-5, 5e cable 1000Base-TX: UTP category-5, 5e cable Max line length: 6.5Km
Data Rates	Downstream: Up to 100Mbps Upstream: Up to 100Mbps
System Requirement	Windows 8/7/Vista/XP or Mac OS or Linux-based operating system Microsoft Internet Explorer, Firefox, Chrome or Safari browser for web-based configuration
Physical and Environment	
Working Temperature	0°C ~ 40°C
Working Humidity	10% ~ 90% RH (non-condensing)
Storage Temperature	-40°C ~ 70°C
Storage Humidity	5% ~ 90% RH (non-condensing)

## Appendix B: Troubleshooting

### T1. How do I restore my modem router's configuration to its factory default settings?

With the modem router powered on, press and hold the **RESET** button on the rear panel for 8 to 10 seconds before releasing it.

 **Note:**

Once the modem router is reset, the current configuration settings will be lost and you will need to re-configure the router.

### T2. What can I do if I don't know or forget my password?

- 1) Restore the modem router's configuration to its factory default settings. If you don't know how to do that, please refer to **T1**.
- 2) Use the default user name and password: **admin, admin**.
- 3) Try to configure your modem router once again by following the instructions in [3.2 Quick Installation Guide](#).

### T3. What can I do if I cannot access the web-based configuration page?

- 1) Configure your computer's IP Address.

#### For Mac OS X

- Click the **Apple** icon on the upper left corner of the screen.
- Go to "**System Preferences -> Network**".
- Select **Airport** on the left menu bar, and then click **Advanced** for wireless configuration; or select **Ethernet** for wired configuration.
- In the **Con-figure IPv4** box under **TCP/IP**, select **Using DHCP**.
- Click **Apply** to save the settings.

#### For Windows 7

- Click "**Start -> Control Panel -> Network and Internet -> View network status -> Change adapter settings**".
- Right-click **Wireless Network Connection** (or **Local Area Connection**), and then click **Properties**.
- Select **Internet Protocol Version 4 (TCP/IPv4)**, and then click **Properties**.
- Select **Obtain an IP address automatically** and **Obtain DNS server address automatically**. Then click **OK**.



#### For Windows XP

- Click "**Start -> Control Panel -> Network and Internet Connections -> Network Connections**".
- Right-click **Wireless Network Connection** (or **Local Area Connection**), and then click **Properties**.
- Select **Internet Protocol (TCP/IP)**, and then click **Properties**.



- Select **Obtain an IP address automatically** and **Obtain DNS server address automatically**. Then click **OK**.

### For Windows 8

- Move your mouse to the lower right corner and you will see **Search** icon  in the Popups. Go to " -> **Apps**". Type **Control Panel** in the search box and press **Enter**, then you will go to **Control Panel**.
- Click "**View network status and tasks > Change adapter settings**".
- Right-click "**Ethernet**" and then select **Properties**.
- Double-click **Internet Protocol Version 4 (TCP/IPv4)**. Select **Obtain an IP address automatically**, choose **Obtain DNS server address automatically** and then click **OK**.

2) Configure your IE browser

Open your IE browser, click **Tools** tab and you will see the following screen.

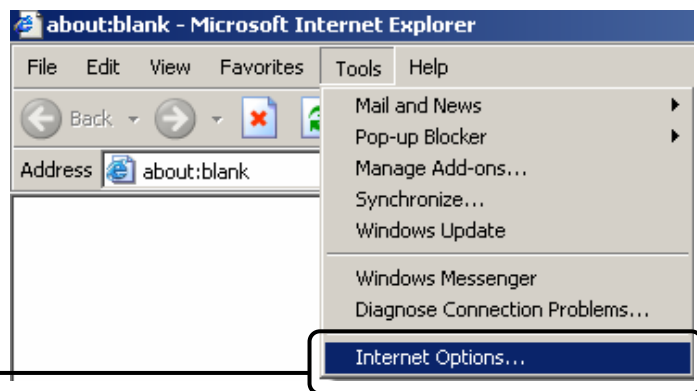

Click **Internet Options**

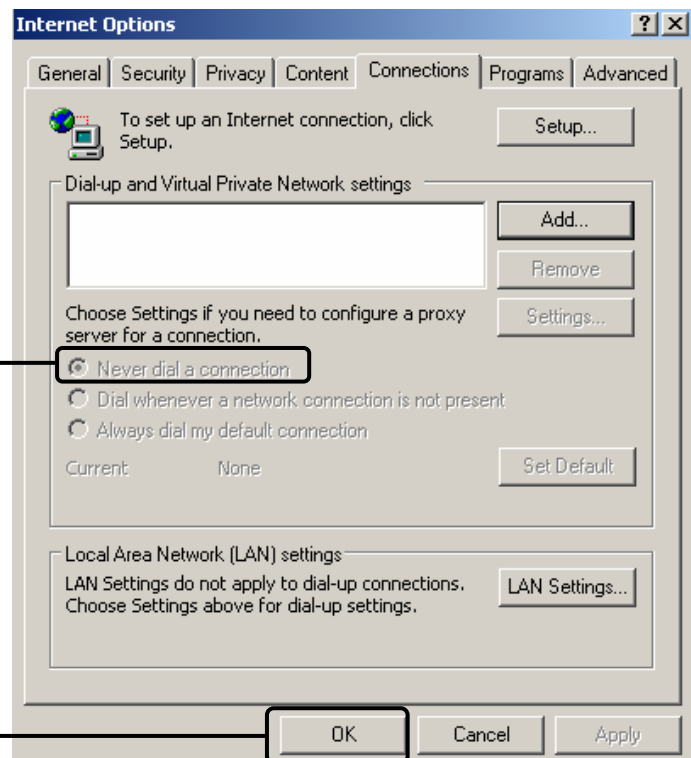

Select **Never dial a connection**

Click **OK**

Now, try to log on to the Web-based management page again after the above settings have been configured. If you still cannot access the configuration page, please restore your modem router's factory default settings and reconfigure your modem router following the instructions in [3.2 Quick Installation Guide](#). Please feel free to contact our Technical Support if the problem still exists.

#### **T4. What can I do if I cannot access the Internet?**

- 1) Check to see if all the connectors are connected well, including the telephone line, Ethernet cables and power adapter.
- 2) Check to see if you can log on to the Web-Management page of the modem router. If you can, try the following steps. If you cannot, please set your computer referring to **T3** then try to see if you can access the Internet. If the problem persists, please go to the next step.
- 3) Consult your ISP and make sure all the VPI/VCI, Connection Type, account username and password are correct. If there are any mistakes, please correct the settings and try again.
- 4) If you still cannot access the Internet, please restore your modem router to its factory default settings and reconfigure your modem router by following the instructions in [3.2 Quick Installation Guide](#).
- 5) Please contact our Technical Support if the problem still exists.

**Note:**

For more details about Troubleshooting and Technical Support contact information, please log on to our Technical Support Website: <http://www.tp-link.com/en/support>

# Appendix C: Technical Support

## Technical Support

- For more troubleshooting help, go to:  
**<http://www.tp-link.com/en/support/faq>**
- To download the latest Firmware, Driver, Utility and User Guide, go to:  
**<http://www.tp-link.com/en/support/download>**
- For all other technical support, please contact us by using the following details:

### Global

Tel: +86 755 2650 4400

Fee: Depending on rate of different carriers, IDD.

E-mail: [support@tp-link.com](mailto:support@tp-link.com)

Service time: 24hrs, 7 days a week

### USA/Canada

Toll Free: +1 866 225 8139

E-mail: [support.usa@tp-link.com](mailto:support.usa@tp-link.com)(USA)  
[support.ca@tp-link.com](mailto:support.ca@tp-link.com)(Canada)

Service time: 24hrs, 7 days a week

### Turkey

Tel: 0850 7244 488 (Turkish Service)

Fee: Depending on rate of different carriers.

E-mail: [support.tr@tp-link.com](mailto:support.tr@tp-link.com)

Service time: 09:00 to 21:00, 7 days a week

### Ukraine

Tel: 0800 505 508

Fee: Free for Landline; Mobile: Depending on rate of different carriers

E-mail: [support.ua@tp-link.com](mailto:support.ua@tp-link.com)

Service time: Monday to Friday, 10:00 to 22:00

### Brazil

Toll Free: 0800 608 9799 (Portuguese Service)

E-mail: [suporte.br@tp-link.com](mailto:suporte.br@tp-link.com)

Service time: Monday to Friday, 09:00 to 20:00;  
Saturday, 09:00 to 15:00

### Indonesia

Tel: (+62) 021 6386 1936

Fee: Depending on rate of different carriers.

E-mail: [support.id@tp-link.com](mailto:support.id@tp-link.com)

Service time: Sunday to Friday, 09:00 to 12:00,  
13:00 to 18:00 \*Except public holidays

### Australia/New Zealand

Tel: NZ 0800 87 5465 (Toll Free)

AU 1300 87 5465 (Depending on 1300 policy.)

E-mail: [support.au@tp-link.com](mailto:support.au@tp-link.com) (Australia)  
[support.nz@tp-link.com](mailto:support.nz@tp-link.com) (New Zealand)

Service time: 24hrs, 7 days a week

### Germany/Austria

Tel: +49 1805 875 465 (German Service)

+49 1805 TPLINK

+43 820 820 360

Fee: Landline from Germany: 0.14EUR/min.

Landline from Austria: 0.20EUR/min.

E-mail: [support.de@tp-link.com](mailto:support.de@tp-link.com)

Service time: Monday to Friday, 09:00 to 12:30  
and 13:30 to 18:00. GMT+1 or GMT+2 (DST in Germany)

\*Except bank holidays in Hesse

### Singapore

Tel: +65 6284 0493

Fee: Depending on rate of different carriers.

E-mail: [support.sg@tp-link.com](mailto:support.sg@tp-link.com)

Service time: 24hrs, 7 days a week

### UK

Tel: +44 (0) 845 147 0017

Fee: Landline: 1p-10.5p/min, depending on the time of day. Mobile: 15p-40p/min, depending on your mobile network.

E-mail: [support.uk@tp-link.com](mailto:support.uk@tp-link.com)

Service time: 24hrs, 7 days a week

### Italy

Tel: +39 023 051 9020

Fee: Depending on rate of different carriers.

E-mail: [support.it@tp-link.com](mailto:support.it@tp-link.com)

Service time: Monday to Friday, 09:00 to 13:00;  
14:00 to 18:00

### Malaysia

Toll Free: 1300 88 875 465

Email: [support.my@tp-link.com](mailto:support.my@tp-link.com)

Service time: 24hrs, 7 days a week

### Poland

Tel: +48 (0) 801 080 618

+48 223 606 363 (if calls from mobile phone)

Fee: Depending on rate of different carriers.

E-mail: [support.pl@tp-link.com](mailto:support.pl@tp-link.com)

Service time: Monday to Friday, 09:00 to 17:00.  
GMT+1 or GMT+2 (DST)

### France

Tel: 0820 800 860 (French service)

Fee: 0.118 EUR/min from France

Email: [support.fr@tp-link.com](mailto:support.fr@tp-link.com)

Service time: Monday to Friday, 09:00 to 18:00  
\*Except French Bank holidays

### Switzerland

Tel: +41 (0) 848 800 998 (German Service)

Fee: 4-8 Rp/min, depending on rate of different time.

E-mail: [support.ch@tp-link.com](mailto:support.ch@tp-link.com)

Service time: Monday to Friday, 09:00 to 12:30 and  
13:30 to 18:00. GMT+1 or GMT+2 (DST)

### Russian Federation

Tel: 8 (499) 754 5560 (Moscow NO.)

8 (800) 250 5560 (Toll-free within RF)

E-mail: [support.ru@tp-link.com](mailto:support.ru@tp-link.com)

Service time: From 09:00 to 21:00 (Moscow time)  
\*Except weekends and holidays in RF

## Free Manuals Download Website

<http://myh66.com>

<http://usermanuals.us>

<http://www.somanuals.com>

<http://www.4manuals.cc>

<http://www.manual-lib.com>

<http://www.404manual.com>

<http://www.luxmanual.com>

<http://aubethermostatmanual.com>

Golf course search by state

<http://golfingnear.com>

Email search by domain

<http://emailbydomain.com>

Auto manuals search

<http://auto.somanuals.com>

TV manuals search

<http://tv.somanuals.com>