

# TOA NEW 900 SERIES POWER AMPLIFIER

P906A  
P912A

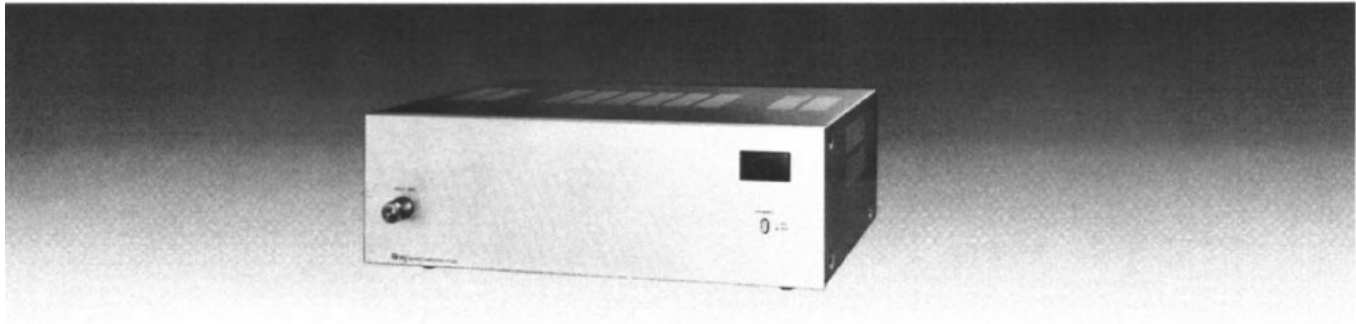

## Features

- 1 Wide frequency response; 20 — 20,000 Hz,  $\pm 1$ dB
- 2 Low distortion and noise level
- 3 Excellent output regulation
- 4 A full range of plug-in modules
- 5 Self-protecting circuitry design
- 6 Varied output impedances; 4 and 8 ohms, 25 and 70 volts
- 7 Input level switch (selectable 1,000mV/100mV)
- 8 Portable or rack-mounting type

## General Descriptions

The TOA P-906A and P-912A Power Amplifiers deliver up to 60 watts and 120 watts of power respectively at less than 0.5% total harmonic distortion (THD) from 20 to 20,000 Hz (transformerless 4-ohm output). The P-906A and P-912A have a high-impedance direct input and an input port (edge connector) to accept one module accessory. Module selection is determined by application among the TOA plug-in modules:

The H-01 series, H-02 series and H-03 series Microphone Preamplifiers, E-01 Mag. Phono Preamplifier, the X-01 series Auxilliary Preamplifiers for high-level sources, the B-01 series Bridging Transformers for bridging high-impedance lines, the L-01 series Line Matching Transformers for matching 600-ohm lines, 1-01 Paging Input for combining with the TOA Intercom System EXES-1000, EXES-5000 and EX-16, and the S-01, S-02 and S-03 Tone signal generators for generating attention-getting signals and 1 kHz sine wave for testing within the total system.

The P-906A and P-912A have a low-cut switch for a cutoff frequency of 60 Hz, and an input-level switch for input sensitivity of 1V (0dBv) or 100mV ( $-20$ dBv). Output terminals provide connections for 4-ohm and 8-ohm speakers, plus 25-volt and 70-volt speaker distribution outlets.

With plug-in modules, the TOA P-906A and P-912A Power Amplifiers may be used as a pre/power amplifier.

The P-906A and P-912A can be rack mounted by using the MB-931 Rack-mounting Bracket accessory. The PF-911 Perforated Panel (1.73 inches, 1 rack unit) accessory provides suitable ventilation, finished in color to match the P-906A and P-912A.

# TOA NEW 900 SERIES

## Front Panel Controls and Features



Item	Name	Function/Description
1	<b>POWER ON-OFF SWITCH</b>	Applies line power. Two-position pushbutton switch for on-off modes.
2	<b>METER</b>	Indicates the output level of the amplifier. At rated output, it shows 0 VU (at continuous sine-wave signal input). When power is turned on, meter illuminates.
3	<b>INPUT VOLUME CONTROL</b>	Adjusts gain of INPUT.

## Rear Panel Controls and Features

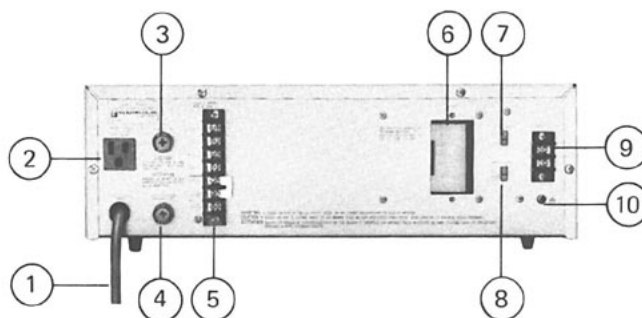

Item	Name	Function/Description	
1	<b>AC POWER SUPPLY CORD</b>	Connects to power source.	
2	<b>AC OUTLET (Unswitched)</b>	Provides AC power for auxiliary equipment with power consumption of up to 500W.	
3	<b>AC FUSE</b>	Protects amplifier from excessive current drain. Replace only with same type fuse. Refer to qualified service personnel if fuse blows repeatedly.	
4	<b>OUTPUT FUSE</b>		
		P-906A	P-912A
	AC FUSE	250V 3A	250V 5A
	OUTPUT FUSE	250V 6A	250V 10A
5	<b>OUTPUT TERMINALS</b>	Connect to speakers.	
6	<b>MODULE INPUT PORT</b>	Accepts PLUG-IN MODULES which are optionally available. Module selection is determined by application.	
7	<b>LOW-CUT SWITCH</b>	Cuts off unnecessary low frequency.	
8	<b>INPUT-LEVEL SWITCH</b>	Selects input sensitivity. Place in "1V (0dBv)" position when normally used as a power amplifier. Note: The position of INPUT-LEVEL SWITCH should be changed according to modules used or equipment connected to DIRECT INPUT TERMINAL.	
9	<b>DIRECT INPUT TERMINAL</b>	Connects directly to external equipment without using modules. Unbalanced 10k ohms.	
10	<b>EARTH TERMINAL</b>	Normally connects to a record player's ground.	

# Input Connections

●Two types of input terminals are provided on the rear for input connections.

(1) 2P terminal (marked HOT, E)

It is provided for direct input (unbalanced, 10k ohms) without using plug-in module. This terminal is directly connected with a potentiometer inside.

(2) Plug-in module input

Select the desired module according to application.

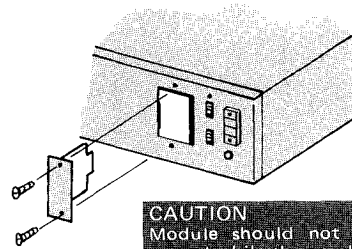

**CAUTION**  
Module should not be inserted or removed while the amplifier is turned on.

\* **DIRECT INPUT TERMINAL** and **MODULE INPUT** are not usable simultaneously.

●Plug the module into INPUT PORT, sliding it between the guide rails, and secure with two screws.

●When INPUT PORT is not occupied, cover the PORT with the blank panel, and secure it with screws.

●Be sure that INPUT-LEVEL SWITCH is in the proper position for the module used or the equipment connected to DIRECT INPUT TERMINAL.

●When the P-906A or P-912A is used in combination with a mixer preamplifier or serves as an incremental power amplifier, normally place INPUT LEVEL SWITCH in "1V (0 dBv)" position,

## Plug-in Modules and Input Level SW Setting

Plug-in Modules	Model No,	Input Level SW Setting	
		1V (0dBv)	100mV (-20dBv)
Balanced low impedance microphone preamp. module (with presettable low-cut filter, high-cut filter and gain controls)	H-01	—	○
Balanced low impedance microphone preamp. module (with presettable low-cut filter, high-cut filter and gain controls, and remote control facilities)	H-21	—	○
Balanced low impedance microphone preamp. module (with presettable low-cut filter and gain controls)	H-02	—	○
Balanced low impedance microphone preamp. module (with presettable low-cut filter and gain controls, and remote control facilities)	H-22	—	○
Unbalanced high impedance microphone preamp. module (with presettable low-cut filter and gain controls)	H-03	—	○
Equalized mag. phono preamp. module (with presettable gain control)	E-01	—	○
Unbalanced high impedance auxiliary preamp. module (with presettable gain control)	X-01	—	○
Unbalanced high impedance auxiliary preamp. module (with presettable gain control and remote control facilities)	X-21	—	○
Balanced 10kΩ bridging transformer module	B-01	○	○
Balanced 600Ω line matching transformer module	L-01	○	○
Balanced paging input module (with presettable gain control)	I-01	—	○
Signal tone generator module (with presettable output level control)	S-01 S-02 S-03	—	○
1 kHz sine wave			
Yelp and buzzer One-tone chime and continuous one-tone chime			

\* See PLUG-IN MODULES for details.

# TOA NEW 900 SERIES

## Output Connections P-906A, P-912A

The speaker outputs of the amplifier are 4Ω, 8Ω, 25V and 70V. Connect speakers to one of these outputs. Class 2 wiring may be used.

Since these outputs consist of 8Ω, 25V and 70V via the output transformer (matching transformer) and direct output of 4Ω, the connecting method differs in each case. See the following diagrams.

Note: Impedances indicated below imply total speaker system (load) impedance.

- When connecting speakers to any one of the outputs of 8 Ω, 25V or 70V (BALANCED TRANSFORMER OUTPUT);

(P-906A)

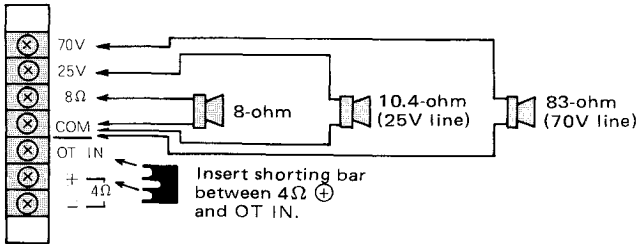

(P-912A)

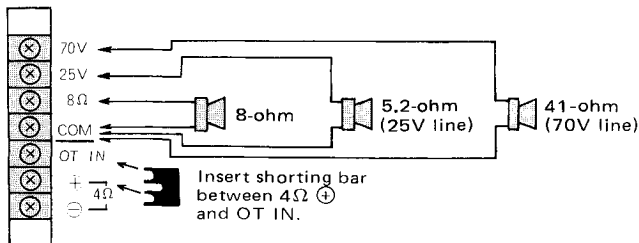

### Note:

In this case, the LOW-CUT SWITCH should be in "CUT" position. This amplifier is characteristically flat even in the low frequency range. Therefore, in TRANS OUTPUT, the acoustic effect and frequency-response characteristics may be altered. In TRANS OUTPUT, cut off unnecessary low frequency to obtain the best acoustic condition.

Place the **LOW-CUT SWITCH** in "CUT" position

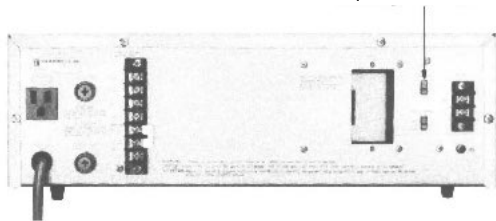

- When connecting speakers to the 4Ω output. (UNBALANCED DIRECT OUTPUT);

(P-906A, P-912A)

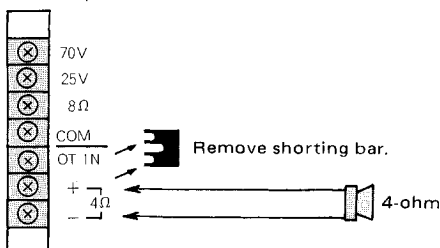

## Installation

- Do not block cover ventilation holes.
- The amplifier should not be placed in areas;
  1. with poor ventilation.
  2. exposed to direct sunlight.
  3. with high ambient temperature or adjacent to heat-generating equipment.
  4. with high humidity or dusty levels.
  5. susceptible to vibration.

### CAUTION:

Do not remove the case or you may encounter an electric shock.

### Note:

When the temperature of heat sink exceeds 105°C, the protection circuit is activated and the output is disconnected from the circuit. The signal automatically begins to be output as the temperature goes down. In such a case, confirm whether or not unit is overloaded or operated on an excessive output.

## Operation

When all connections are completed, turn power switch on. Then, the meter is illuminated. Approx. 5 seconds after switching power on, the amplifier comes into operation.

### ADJUSTMENT OF VOLUME CONTROL

Adjust the input volume control to obtain appropriate output level. In normal use of BGM playing or announcement, the deflection of the meter is recommended to be within the range as indicated in the drawing. Tone quality will be considerably deteriorated if the pointer indicates around 0 VU.

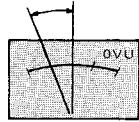

In normal use of BGM playing or announcement.

The pointer of meter indicates 0 VU if continuous signals like sine waves are applied to the input of the amplifier.

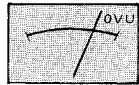

Continuous signals

When the power amplifier is used in combination with a mixer pre-amplifier, adjust the total gain at the mixer preamplifier with the gain setting of the power amplifier at maximum.

### • Output Fuse

Each amplifier has an output fuse to protect the amplifier from short-circuiting at the output or overloading. Check the fuse when speakers connected do not sound even if the meter deflects normally. If the fuse blew, replace with the same type fuse after confirming the following points.

- (1) Speaker cables are not short-circuited or the load does not exceed the rating specified.
- (2) Wiring is correctly done at the output terminal board.

## Rack Mounting

To mount the amplifier in a standard 19-inch equipment rack, use the MB-931 Rack-mounting Bracket accessory.

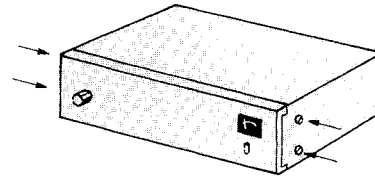

Remove 4 screws securing case.

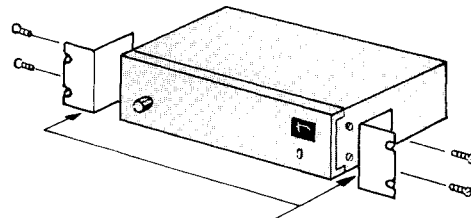

MB-931 (Silver) (OPTION)

Fix the MB-931 with attached 4 screws. The length of the screws should not exceed 12mm (1/2 inches).

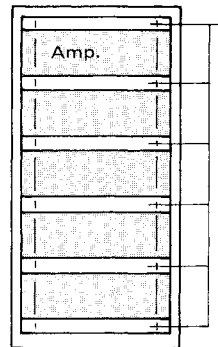

Perforated Panel PF-911 (OPTION) (Silver)

If two or more amplifiers are mounted in an equipment rack, space should be provided between the units for ventilation. The PF-911 Perforated Panel is recommended for this purpose.

## Servicing

### • Unpacking

Upon receipt of the amplifier shipment, please inspect for any damage incurred in transit. If damage is found, please notify your local TOA representative and the transportation company immediately.

State date, nature of damage, whether any damage was noticed on the shipping container, prior to unpacking. Please give waybill number of shipping order.

### • Failure

Should amplifier fail, contact your nearest TOA authorized contractor or service center.

Block Diagram P-906A, P-912A

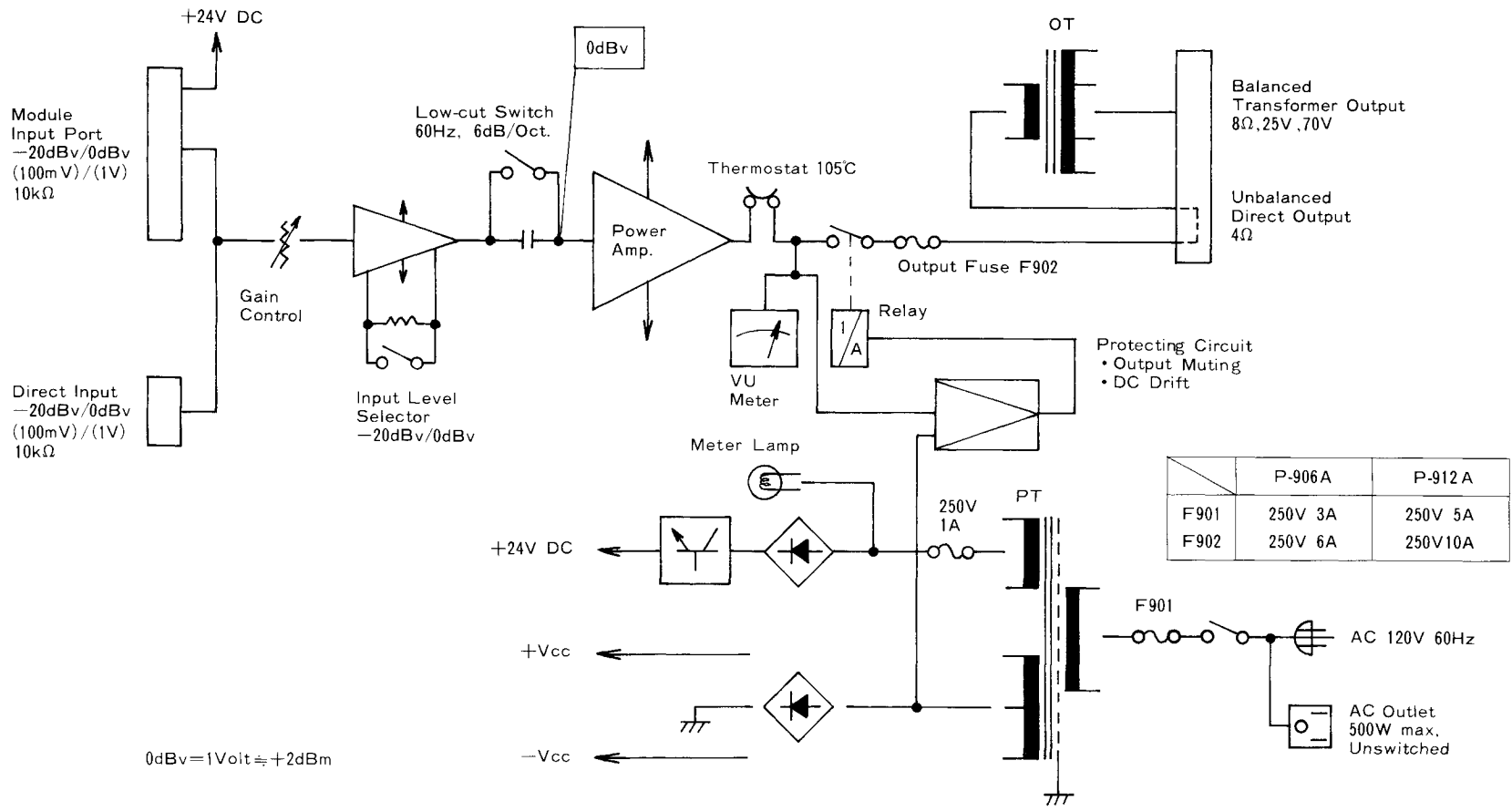

P-906A, P-912A BLOCK DIAGRAM

## Specifications

	P-906A	P-912A
<b>Type</b>	Power amplifier	
<b>Output Power</b>	60 watts RMS	120 watts RMS
<b>Power Band Width</b>	(D) 20—20,000 Hz 0.5% THD (T) 50—20,000 Hz 0.5% THD	
<b>Frequency Response</b>	(D) 20— 20,000 Hz, ±1 dB (T) 20— 15,000 Hz, ±1 dB (T) 20—20,000Hz, +1dB -3db	
<b>Total Harmonic Distortion</b>	0.01% at 1 kHz, rated output	
<b>Inputs</b>	One Input Port : Port accepts any input module except T-01, which cannot be used. One Direct Input Note : Use of direct input prohibits use of modular input port.	
<b>Input Sensitivity/Impedance</b>	Input Port : 100 mV or 1,000 mV (Switchable)/10k ohms Direct Input : 100 mV or 1,000 mV (Switchable)/10k ohms	
<b>Outputs (D) - Direct (T) - Transformer</b>	Main (T) : 8 ohms, 25 & 70 volts, balanced Main (D) : 4 ohms, unbalanced	
<b>Output Regulation (1 kHz)</b>	(D) Less than 0.5 dB, no load to full load	(T) Less than 1.0 dB, no load to full load
<b>Signal to Noise Ratio (Band Pass 20 — 20,000 Hz)</b>	Input level switch in 0 dBv (1,000 mV) position : 108 dB Input level switch in -20 dBv (100 mV) position : 90 dB	
<b>Controls</b>	1 Input gain control 1 Input level switch 1 Power ON/OFF switch 1 Low-cut switch (60 Hz, 6 dB/octave)	
<b>Indicator</b>	1 Illuminated VU meter	
<b>Protection</b>	Self-protection, with 2 AC fuses (1 inside) and 1 output fuse	
<b>Connectors</b>	Inputs . . . . . Card-edge connector and screw-terminal strip Outputs . . . . . Screw-terminal strip AC outlet . . . . . 3-pin grounding type AC power cord/plug . . . . . SJT, 3-prong type	
<b>Power Consumption</b>	AC 120 volts, 60 Hz, 100 watts	AC 120 volts, 60 Hz, 180 watts
<b>Temperature Range</b>	-10°C to +60°C (12°F to 140°F)	
<b>Dimensions in mm (inches) (high) x (wide) x (deep)</b>	145 (5.71") x 420 (16.54") x 315 (12.40") Rack-mounting space size "3U" (5.21")	
<b>Weight (without input modules)</b>	10.4 kg (22.9 lbs.)	14.2kg (31.2 lbs.)
<b>Color</b>	Silver	
<b>Other Features</b>	Output disconnected for approx. 5 sec after switching power on.	

\* Specifications are subject to change without notice.

# TOA NEW 900 SERIES

## Plug-in Modules and Accessories

(OPTION)



The TOA PLUG-IN MODULES are suitable for TOA 900 SERIES MIXER POWER AMPLIFIERS A-901A, A-903A, A-906A, and A-912A MIXER PREAMPLIFIER M-900A, and POWER AMPLIFIERS P-906A, P-912A and P-924. Owing to wide selection of MODULES, the desired applications will be obtained. The various types of connectors can also meet the needs of equipment to be connected. MICROPHONE PREAMPLIFIER H-01 series, H-21 and H-31 incorporates controls for high-cut, low-cut and gain, H-02 series, H-22, H-32 and H-03 series controls for low-cut and gain. A gain control is built in MAG. PHONO PREAMPLIFIERS E-01 and E-11 series, AUXILIARY PREAMPLIFIERS X-01 and X-11 series and X-21, PAGING INPUT I-01 and LINE OUTPUT T-01 series. T-01 series is an output module with transformer, serving as a line output for recording, etc..









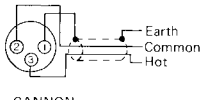
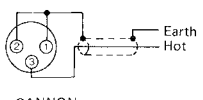

PAGING INPUT I-01 is specially designed to associate with TOA INTERCOM SYSTEMS. It accepts paging signals from the intercom station.

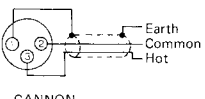
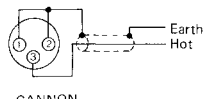
A group of special signal generating modules is also available for catching-attention before announcement and testing within the total system. ALL PLUG-IN MODULES have handles on their front for easy insertion and removal.

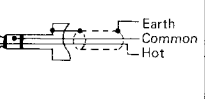
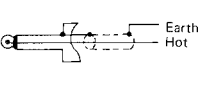
### Features:

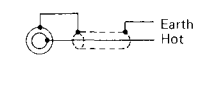
1. Wide dynamic range
2. Low noise and distortion
3. Wide frequency response
4. Built-in remote volume control circuit (available for models having 20's in its model number such as H-21)
5. Built-in muting circuit to mute incoming signal when MUTE TERMINAL is grounded, (available for modules having 10's in its model number such as X-11)
6. Built-in muting circuit to deliver output signal when MUTE TERMINAL is grounded, (available for modules having 30's in its model number such as H-31)
7. Built-in signal activated muting function (L-41)
8. Presettable gain control (except for B-01, B-11, L-01 and L-11)
9. Microphone modules furnished with tone controls (H-01, H-02, H-21, H-22, H-31, H-32 and H-03)

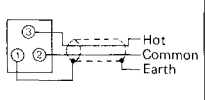
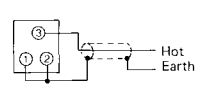
(INPUT CONNECTIONS, T-01 OUTPUT CONNECTION)

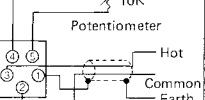
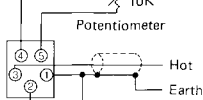
MODEL Connection	PLUG-CONNECTIONS	
	Balanced Connection	Unbalanced Connection
	H-01 series H-21 H-02 series H-22 B-01 series H-31 B-11 series H-32 L-01 series L-11 T-01 series L-41	H-03 series E-01 series E-11 series X-01 series X-11 series X-21
 CANNON XLR-3-13 (Female) type	 CANNON XLR-3-12 (Male) type	 CANNON XLR-3-12 (Male) type
 CANNON XLR-3-14 (Male) type	 CANNON XLR-3-11 (Female) type	 CANNON XLR-3-11 (Female) type
 Phone Jack (P)	 Phone Plug (Double Pole)	 Phone Plug (Single Pole)
 RCA Phono Jack (R)		 RCA Phono Jack
 3P Screw Terminal (S)	 Hot Common Earth	 Hot Earth
 5P Screw Terminal (S)	 10K Potentiometer Hot Common Earth	 10K Potentiometer Hot Earth



## Plug-in Modules

Applications		Module Types	Specifications								Connector								
			Source Impedance	Input Sensitivity for Rated Output (100 mV)	Gain	Max. Before Clip into 10k-ohm load at less than 0.5% THD (1kHz) [Output Voltage: S-01, S-02, S-03]	Frequency Response $\pm 1$ dB	Noise Level [equivalent input noise or S/N]	Signal Muting Level	Remote volume control range [Use 10k ohms potentiometer]	Controls [pre-settable]	Weight (max.)	XLR-3-13 (F) Type	XLR-3-14 (M) Type	Phone Jack (P)	RCA Phono Jack (R)	3P Screw Terminal(S)	5P Screw Terminal(S)	
Microphone Preamplifier	Low Z MIC with Low & High filters	H-01 series	Balanced 200 ohms	nominal 1.0 mV adjustable 0.25~25 mV	nominal 40 dB adjustable 52~32 dB	6.3 V (+16 dBv)	25~20,000 Hz	-126 dBm 200ohms terminated	60 dB	0~-60 dB	1-Low cut 1-High cut 1-Gain	105 gr (3.71 oz)	H-01F	H-01M	H-01P	—	H-01S	—	
	Low Z MIC with Low & High filters and remote volume control facilities	H-21										100 gr (3.53 oz)	—	—	—	—	—	H-21S	—
	Low Z MIC with Low & High filters and MUTE	H-31										105 gr (3.70 oz)	—	—	—	—	—	H-31S	—
	Low Z MIC with Low-cut filter	H-02 series										100 gr (3.53 oz)	H-02F	H-02M	H-02P	—	H-02S	—	
	Low Z MIC with Low-cut filter and remote volume control facilities	H-22										95 gr (3.35 oz)	—	—	—	—	—	H-22S	—
	Low Z MIC with Low-cut filter and MUTE	H-32										105 gr (3.70 oz)	—	—	—	—	H-32S	—	
High Z MIC with Low-cut filter	H-03 series	Unbalanced 50k ohms	nominal 3.2 mV adjustable 0.8~8.0 mV	nominal 30 dB adjustable 42~22 dB	6.3 V (+16 dBv)	20~20,000 Hz	S/N 70dB	—	—	1-Low cut 1-Gain	60 gr (2.12 oz)	—	—	H-03P	H-03R	—	—		
Mag. Phono Preamplifier	—	E-01 series	Unbalanced 50k ohms	nominal 3.2 mV adjustable 2.0~5.0 mV	nominal 34 dB adjustable 34~26 dB	6.3 V (+16 dBv)	RIAA Equalized	S/N 70 dB	60 dB	—	1-Gain	50 gr (1.76 oz)	—	—	—	E-01R	E-01S		
	with MUTE	E-11 series										55 gr (1.94 oz)	—	—	—	E-11R	E-11S		
Auxiliary Preamplifier	—	X-01 series	Unbalanced 220k ohms	nominal 100 mV adjustable 100~3,200 mV	nominal 0 dB adjustable 0~-30 dB	6.3 V (+16 dBv)	20~20,000 Hz	S/N 90 dB	60 dB	0~-60 dB	1-Gain	70 gr (2.47 oz)	X-01F	—	X-01P	—	X-01S	—	
	with MUTE	X-11 series										75 gr (2.65 oz)	—	X-11P	X-11R	X-11S	—		
	with remote volume control facilities	X-21										65 gr (2.29 oz)	—	—	—	—	X-21S	—	
Bridging transformer	—	B-01 series	Balanced 10k ohms	125 mV	-1 dB	—	20~20,000 Hz	—	60 dB	—	—	90 gr (3.17 oz)	B-01F	—	B-01P	—	B-01S	—	
	with MUTE	B-11 series										95 gr (3.35 oz)	—	B-11P	—	B-11S	—		
Line Matching Transformer	—	L-01 series	Balanced 600 ohms	125 mV	-2 dB	—	20~20,000 Hz	—	60 dB	—	—	90 gr (3.17 oz)	L-01F	—	L-01P	—	L-01S	—	
	with MUTE	L-11										95 gr (3.35 oz)	—	—	—	L-11S	—		
	with Signal Activating Mute	L-41										125mV [Min. 15 mV to activate] mute function	1-Sensitivity	95 gr (3.35 oz)	—	—	—	L-41S	—
Paging Input	—	I-01	Balanced 600 ohms	nominal 3.2 V adjustable 3.2~10 V	nominal -30 dB adjustable -30~-40 dB	—	500~20,000 Hz Low-cut 250 Hz	—	—	—	1-Mute 1-Gain	100 gr (3.53 oz)	—	—	—	—	I-01S	—	
Line Output	—	T-01 series	[Output Balanced 600 ohms]	—	nominal 20 dB (1.0 V output) adjustable 20~4 dB (1.0 V~158 mV)	6.3 V (+16 dBv) 4.7 V (+13.4 dBv) into 600-ohm load	30~20,000 Hz	S/N 80 dB	—	—	1-Gain	100 gr (3.53 oz)	—	T-01M	T-01P	—	T-01S	—	
Tone Signal Generator	1 kHz Sine Wave	S-01	—	—	—	0.5 V (-6dBv) 0.5% THD	—	S/N 80 dB	—	—	1-Output	55 gr (1.94 oz)	—	—	—	—	S-01S	—	
	Buzzer/Yelp	S-02	—	—	—	1 V peak to peak	—	S/N 80 dB	—	—	1-Output	60 gr (2.12 oz)	—	—	—	—	S-02S	—	
	One Tone/Continuous Chime	S-03	—	—	—	1 V peak to peak	—	S/N 80 dB	—	—	1-Output	70 gr (2.47 oz)	—	—	—	—	S-03S	—	

\* 0 dBv= 1 volt = +2 dBm. \* Specifications are subject to change without notice.

### • FRONT PANEL CONTROLS AND FEATURES

Modules with built-in controls are provided in the following five types.

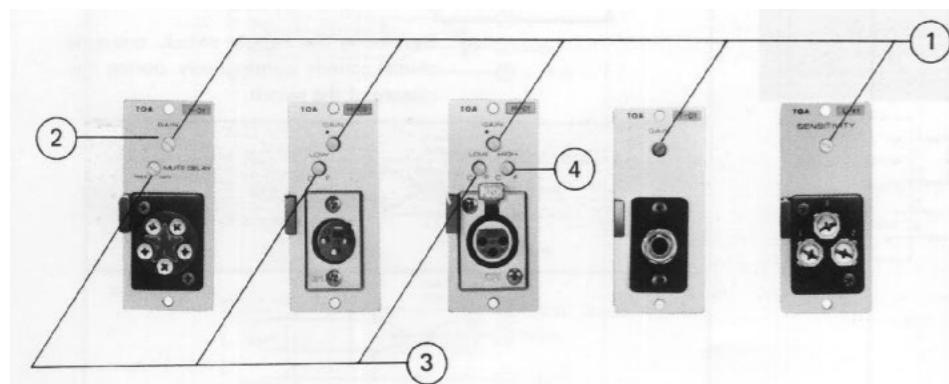

#### ① GAIN CONTROL

This adjusts gain. Turn clockwise (CW) to increase and counterclockwise (CCW) to reduce gain.

Set the gain as low as possible, thereby, noise can be reduced, and the maximum permissible input level is raised.

#### SENSITIVITY CONTROL (L-41S)

This adjusts sensitivity for muting other modules having MUTE function. Turn CW to raise and CCW to lower sensitivity. Setting position should depend on the equipment connected with L-41S.

#### ② NOMINAL POSITION MARK

⑤ The left figure shows nominal setting of controls.

#### ③ LOW-CUT FILTER CONTROL 330Hz, 6dB/oct (max. attenuation)

This provides flat characteristics at full CW position and attenuation in low frequency by turning CCW. Adjust it to obtain proper tone quality. With low-cut, tone becomes clear.

#### MUTE DELAY CONTROL (I-01S)

This adjusts MUTE delay time which is the duration from signal input to its output. Turn CW to shorten and CCW to lengthen the time.

#### ④ HIGH-CUT FILTER CONTROL 4.2kHz, 6dB/oct (max. attenuation)

This provides flat characteristics at full CW position and attenuation in high frequency by turning CCW. Adjust it to obtain proper tone quality. With high-cut, tone becomes soft.

### • SPECIFICATIONS IN COMMON

Load impedance : 10k-ohms  
Mounting : Card-edge connector  
Dimensions in mm (inches) : 78(3.07)x35(1.38)x88(3.46) (H) x (W) x (D)

#### CAUTION:

\* Modules model E-11, X-11, B-11, L-11, L-41, H-31, H-32, and T-01 should be used exclusively with model A-903A, A-906A, A-912A and M-900A.

# TOA NEW 900 SERIES

## Block Diagrams (Plug-in Modules)

<p><b>H-01 Series</b></p>	<p><b>B-01 Series</b></p>
<p><b>H-21S</b></p>	<p><b>B-11 Series</b></p>
<p><b>H-31S</b></p>	<p><b>L-01 Series</b></p>
<p><b>H-02 Series</b></p>	<p><b>L-11S</b></p>
<p><b>H-22S</b></p>	<p><b>L-41S</b></p>
<p><b>H-32S</b></p>	<p><b>T-01 Series</b></p>
<p><b>H-03 Series</b></p>	<p><b>S-01S</b></p>
<p><b>E-01 Series</b></p>	<p><b>S-02S</b></p>
<p><b>E-11 Series</b></p>	<p><b>S-03S</b></p>
<p><b>X-01 Series</b></p>	<p><b>I-01S</b></p>
<p><b>X-11 Series</b></p>	
<p><b>X-21S</b></p>	

## Operation and Connections (Plug-in Modules)

### •E-11, X-11, L-11, B-11 Series, H-31 and H-32 (with mute)

#### Connections

(M-900A, A-903A, A-906A, A-912A)

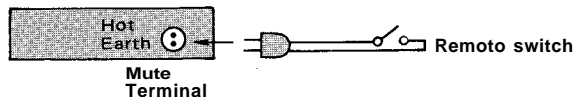

#### Operation

When the switch is closed,

- the signal fed to E-11, X-11, L-11 and B-11 are attenuated by approx. 60dB. Accordingly a microphone can have a priority at a time of announcement.
- the signal fed to H-31 and H-32 are delivered to the amplifier. (While the switch is opened, the signals are attenuated.)

### •L-41 (with signal activated muting facilities)

When this module accepts the input signal, the mute terminal is grounded automatically without connection of the remote switch to the MUTE TERMINAL. It causes the other modules with mute function, like X-11, to be muted.

Accordingly the signal fed to the L-41 can have a priority.

### •H-21, H-22 and X-21 (Remote volume control facilities)

#### Connections

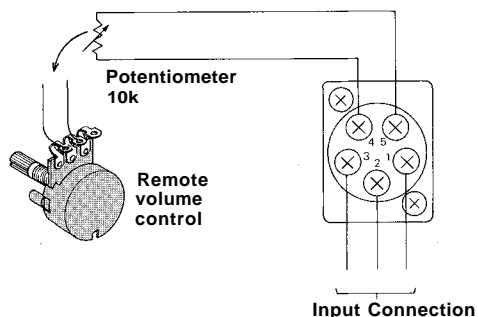

#### Operation

Preset the gain control of module and the input volume control of the corresponding input so that an appropriate sound level may be obtained through the remote volume control.

#### CAUTION

Use the potentiometer of 10K ohms.  
Make wiring lest the interference from external noise should occur.

### •T-01 SERIES (BALANCED 600-ohm LINE OUTPUT MODULES)

This series of modules, of rated output level 1 volt, is used for transmitting mixing signals of amplifiers to external equipment and as a REC out.

It is provided with a presettable gain control.

T-01 Series should be used exclusively for TOA 900 series, A-903A, A-906A, A-912A and M-900A. Use it only in Input Port #5 or #6 of the above models. It will not operate when connected into other PORTS.

Approx. 5 seconds after power has been supplied to these modules, the output signal is transmitted.

### •S-01 (1,000Hz SINE WAVE)

#### Connections

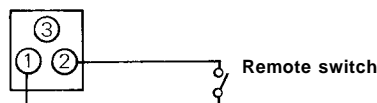

It is operated by closing the remote switch.

### •S-02 (YELP AND BUZZER)

#### Connections

##### Yelp signal

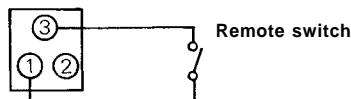

##### Buzzer signal

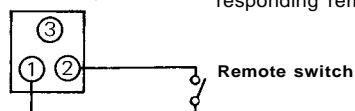

Each signal is generated by closing corresponding remote switch.

### •S-03 (ONE-TONE CHIME AND CONTINUOUS ONE-TONE CHIME)

#### CONNECTIONS

##### One-tone chime

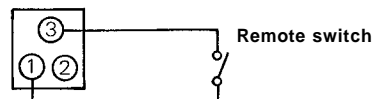

By closing the remote switch, chime sounds once.

##### Continuous one-tone chime

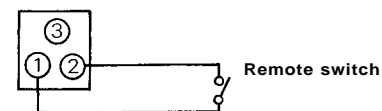

By closing the remote switch, one-tone chime sounds continuously during the closure of the switch.

Schematic P-906A

TOA NEW 900 SERIES

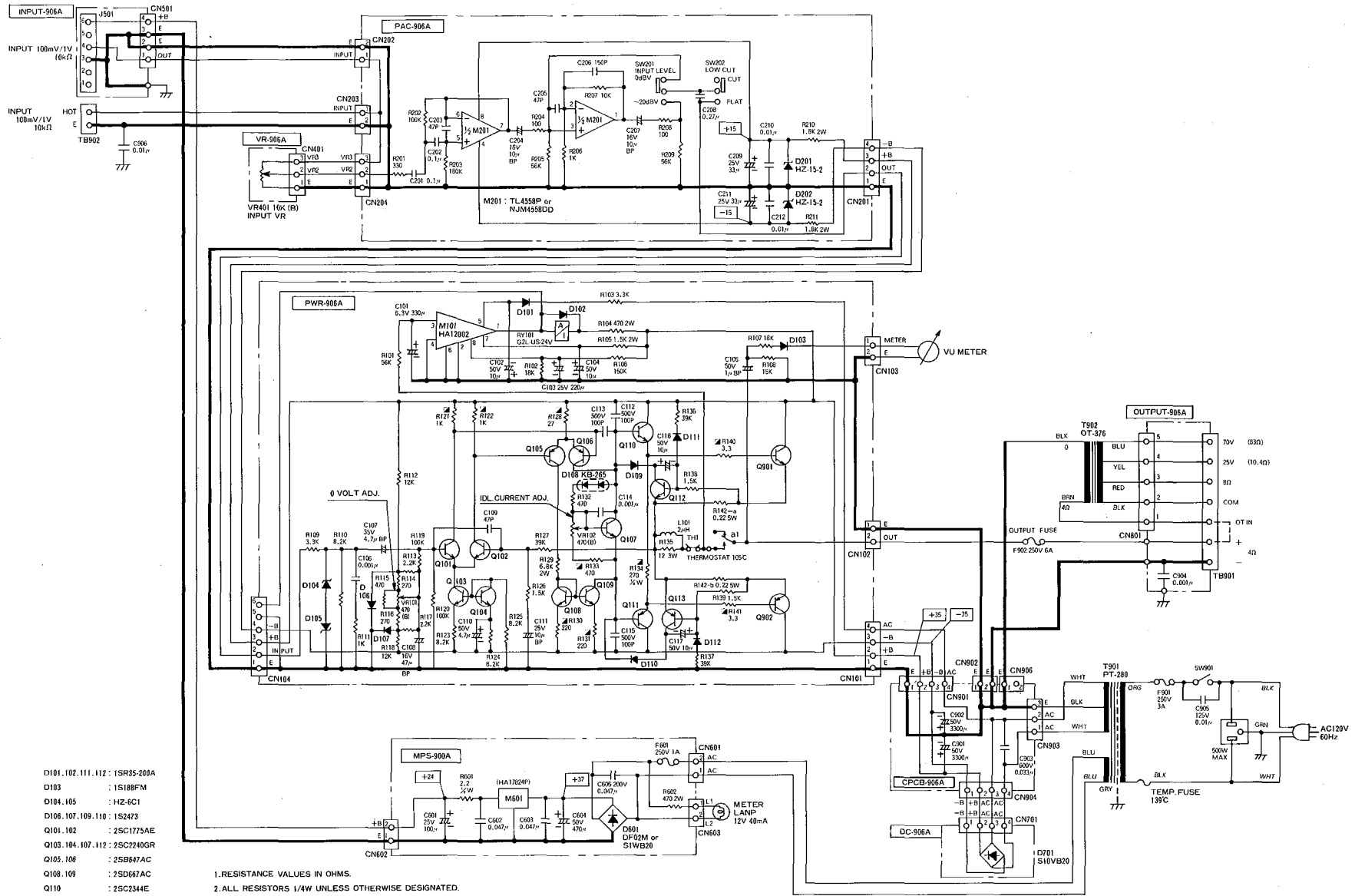

- D101, 102, 111, 112 : 1SR35-200A
- D103 : 1S188FM
- D104, 105 : HZ-6C1
- D106, 107, 109, 110 : 1S2473
- Q101, 102 : 2SC1775AE
- Q103, 104, 107, 112 : 2SC2240GR
- Q105, 106 : 2SB647AC
- Q108, 109 : 2SD647AC
- Q110 : 2SC2344E
- Q111 : 2SA1011E
- Q113 : 2SA970GR
- Q901 : 2SC3281
- Q902 : 2SA1302

1. RESISTANCE VALUES IN OHMS.
2. ALL RESISTORS 1/4W UNLESS OTHERWISE DESIGNATED.
3. CAPACITANCE VALUES IN FARADS UNLESS OTHERWISE DESIGNATED.
4. VOLTAGES ARE MEASURED TO CHASSIS GROUND WITH NO SIGNAL.
5. ALL CAPACITORS 50V UNLESS OTHERWISE DESIGNATED.
6. NONFLAMMABLE RESISTOR.

# Schematic P-912A

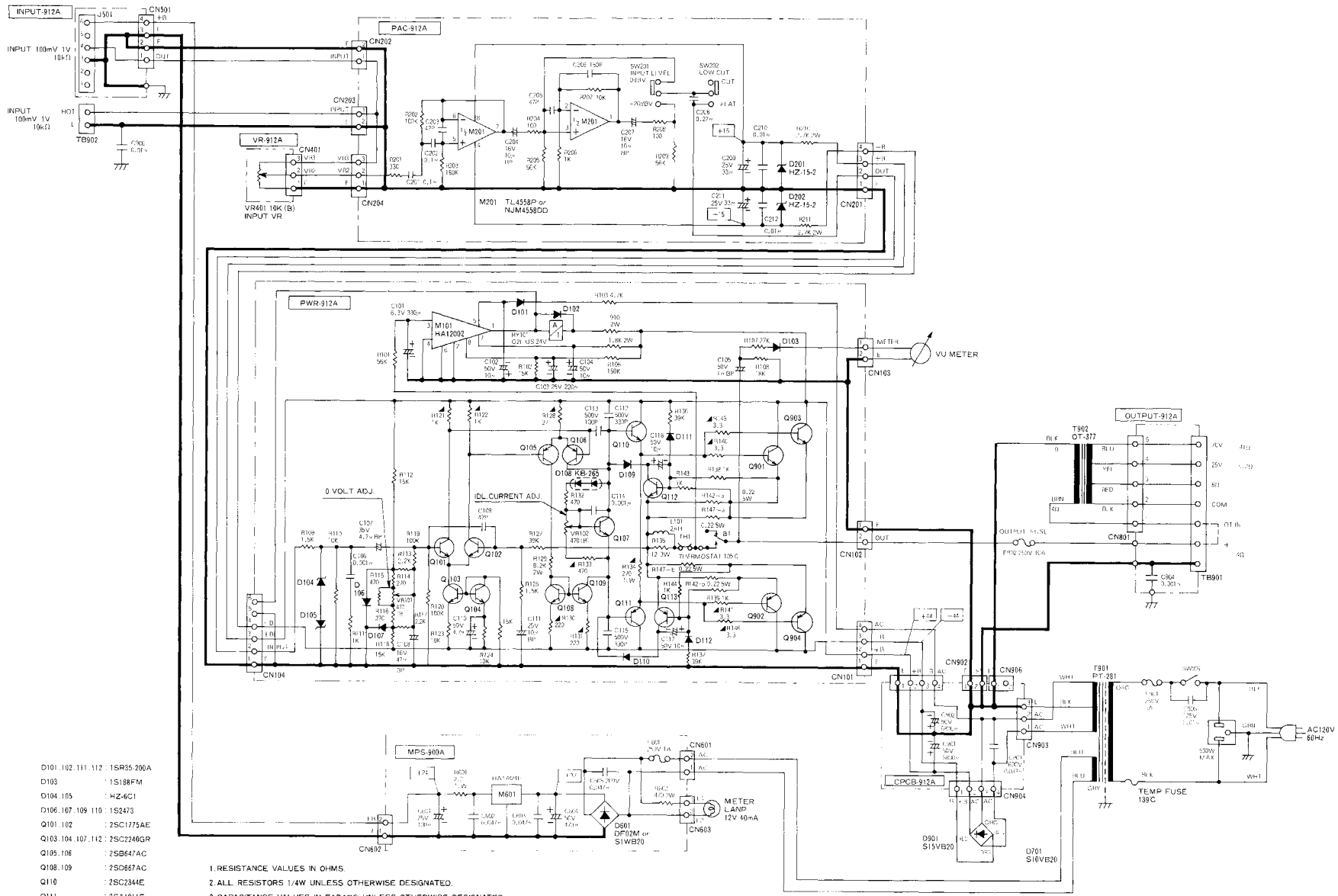

- D101, 102, 111, 112 : 1SR35-200A
- D103 : 1S189FM
- D104, 105 : HZ-4C1
- D106, 107, 109, 110 : 1S2473
- Q101, 102 : 2SC1775AE
- Q103, 104, 107, 112 : 2SC2240GR
- Q105, 106 : 2SB647AC
- Q108, 109 : 2SC0667AC
- Q110 : 2SC2344E
- Q111 : 2SA1011E
- Q113 : 2SA970GR
- Q991 : 2SC3281
- Q902 : 2SA1302

1. RESISTANCE VALUES IN OHMS.
2. ALL RESISTORS 1/4W UNLESS OTHERWISE DESIGNATED.
3. CAPACITANCE VALUES IN FARADS UNLESS OTHERWISE DESIGNATED.
4. VOLTAGES ARE MEASURED TO CHASSIS GROUND WITH NO SIGNAL.
5. ALL CAPACITORS 50V UNLESS OTHERWISE DESIGNATED.
6. ▲ NONFLAMMABLE RESISTOR

## Free Manuals Download Website

<http://myh66.com>

<http://usermanuals.us>

<http://www.somanuals.com>

<http://www.4manuals.cc>

<http://www.manual-lib.com>

<http://www.404manual.com>

<http://www.luxmanual.com>

<http://aubethermostatmanual.com>

Golf course search by state

<http://golfingnear.com>

Email search by domain

<http://emailbydomain.com>

Auto manuals search

<http://auto.somanuals.com>

TV manuals search

<http://tv.somanuals.com>