

Installation Guide

Gigabit Smart Switch

TL-SG2216/TL-SG2424/TL-SG2424P/TL-SG2452

COPYRIGHT & TRADEMARKS

Specifications are subject to change without notice. **TP-LINK®** is a registered trademark of TP-LINK TECHNOLOGIES CO., LTD. Other brands and product names are trademarks of their respective holders.

No part of the specifications may be reproduced in any form or by any means or used to make any derivative such as translation, transformation, or adaptation without permission from TP-LINK TECHNOLOGIES CO., LTD. Copyright © 2013 TP-LINK TECHNOLOGIES CO., LTD. All rights reserved.

<http://www.tp-link.com>

FCC STATEMENT



This equipment has been tested and found to comply with the limits for a Class A digital device, pursuant to part 15 of the FCC Rules. These limits are designed to provide reasonable protection against harmful interference when the equipment is operated in a commercial environment. This equipment generates, uses, and can radiate radio frequency energy and, if not installed and used in accordance with the instruction manual, may cause harmful interference to radio communications. Operation of this equipment in a residential area is likely to cause harmful interference in which case the user will be required to correct the interference at his own expense.

This device complies with part 15 of the FCC Rules. Operation is subject to the following two conditions:

- 1) This device may not cause harmful interference.
- 2) This device must accept any interference received, including interference that may cause undesired operation.

Any changes or modifications not expressly approved by the party responsible for compliance could void the user's authority to operate the equipment.

CE Mark Warning



This is a Class A product. In a domestic environment, this product may cause radio interference, in which case the user may be required to take adequate measures.

Related Document

The User Guide and CLI Reference Guide (CLI Reference Guide is not available for TL-SG2452) of the product are provided on the resource CD. To obtain the latest product information, please visit the official website: <http://www.tp-link.com>

About this Installation Guide

This Installation Guide describes the hardware characteristics, installation methods and the points that should be attended to during installation. This Installation Guide is structured as follows:

Chapter 1 Introduction. This chapter describes the external components of the Switch.

Chapter 2 Installation. This chapter illustrates how to install the Switch.

Chapter 3 Lightning Protection. This chapter illustrates how to prevent lightning damage.

Chapter 4 Connection. This chapter illustrates how to do the physical connection of the Switch.

Chapter 5 Configuration. This chapter instructs you to configure the Switch via Web Interface and CLI commands.

Appendix A Troubleshooting.

Appendix B Hardware Specifications.

Appendix C Technical Support.

Audience

This Installation Guide is for:



Network Engineer

Network Administrator

Conventions

Due to the similarity in structure of the Gigabit Smart Switch series, in this Installation Guide we take TL-SG2216 as an example to illustrate Chapter 2 Installation, Chapter 3 Lightning Protection, Chapter 4 Connection and Chapter 5 Configuration.

This Guide uses the specific formats to highlight special messages. The following table lists the notice icons that are used throughout this guide.

	Remind to be careful. A caution indicates a potential which may result in device damage.
	Remind to take notice. The note contains the helpful information for a better use of the product.

Contents

Chapter 1	Introduction	01
1.1	Product Overview	01
1.2	Appearance	01
Chapter 2	Installation	07
2.1	Package Contents	07
2.2	Safety Precautions	07
2.3	Installation Tools	09
2.4	Product Installation	10
Chapter 3	Lightning Protection	12
3.1	Cabling Reasonably	12
3.2	Connect to Ground	14
3.3	Equipotential Bonding	15
3.4	Use Lightning Arrester	16
Chapter 4	Connection	18
4.1	Ethernet Port	18
4.2	SFP Port	18
4.3	Verify Installation	19
4.4	Power On	19
4.5	Initialization	19
Chapter 5	Configuration	20
5.1	Configure the Switch via GUI	20
5.2	Configure the Switch Using CLI	21
Appendix A	Troubleshooting	23
Appendix B	Hardware Specifications	24
Appendix C	Technical Support	25

Chapter 1 Introduction

1.1 Product Overview

TP-LINK Gigabit Smart Switch, designed for workgroups and departments, provides wire-speed performance and abundant layer 2 management features. It provides a variety of service features and multiple powerful functions with high security.

The EIA-standardized framework and smart configuration capacity can provide flexible solutions for a variable scale of networks. QoS and IGMP snooping/filtering optimize voice and video application. Link aggregation increases aggregated bandwidth, optimizing the transport of business critical data. SNMP, RMON, WEB/Telnet Log-in bring abundant management policies (TL-SG2452 doesn't support the Telnet function). TP-LINK Gigabit Smart Switch integrates multiple functions with excellent performance, and is friendly to manage, which can fully meet the need of the users demanding higher networking performance.

TL-SG2424P Smart PoE Switch is also a Power Sourcing Equipment (PSE*). All the Auto-Negotiation RJ45 ports on the switch support Power over Ethernet (PoE*) function, which can automatically detect and supply power with those powered devices (PDs*) complying with IEEE 802.3af and IEEE 802.3at.

*PSE: a device (switch or hub for instance) that will provide power in a PoE setup.

*PoE: This technology describes a system to transmit electrical power, along with data, to remote devices over standard twisted-pair cable in an Ethernet.

*PD: a device powered by a PSE and thus consumes energy. Examples include powering IP telephones, wireless LAN access points, network cameras, network hubs, embedded computers etc.

1.2 Appearance

■ Front Panel

The front panel of TL-SG2216 is shown as the following figure.

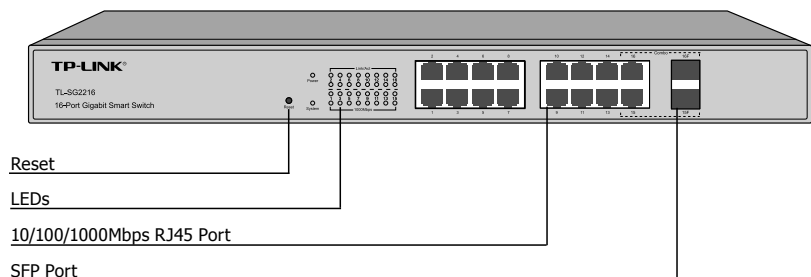

Figure 1-1 Front Panel of TL-SG2216

The front panel of TL-SG2424 is shown as the following figure.

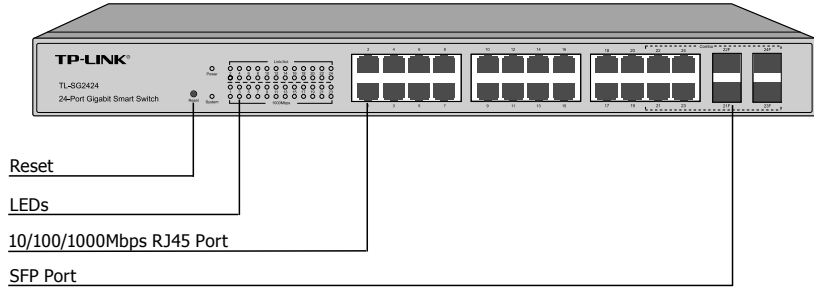

Figure 1-2 Front Panel of TL-SG2424

Reset

Press this button for five seconds or above to reset the software setting back to factory default settings.

LEDs

LED	Status	Indication
Power	On	The Switch is powered on
	Off	The Switch is powered off or power supply is abnormal
System	On	The Switch is working abnormally
	Flashing	The Switch is working normally
	Off	The Switch is working abnormally
Link/Act	On	There is a device linked to the corresponding port but no activity
	Flashing	The corresponding port is transmitting or receiving data
	Off	There is no device linked to the corresponding port
1000Mbps	On	A 1000Mbps device is connected to the corresponding port
	Off	A 10/100Mbps device or no device is connected to the corresponding port

10/100/1000Mbps RJ45 Port

Designed to connect to the device with a bandwidth of 10Mbps, 100Mbps or 1000Mbps. Each has a corresponding Link/Act LED and a 1000Mbps LED.

SFP Port

Designed to install the SFP module. TL-SG2216/TL-SG2424 Switch features 2/4 SFP transceiver slots that are shared with the associated RJ45 ports. The associated two ports are referred as a "Combo" port, which means they cannot be used simultaneously, otherwise only SFP port works.

The front panel of TL-SG2424P is shown as the following figure.

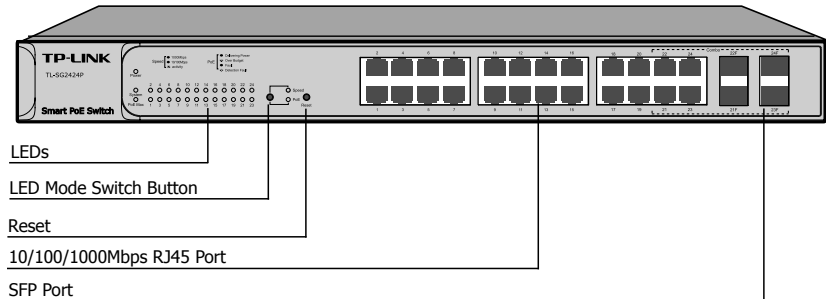

Figure 1-3 Front Panel of TL-SG2424P

LEDs

TL-SG2424P has an LED mode switch button which is for switching the LED status indication. When the Speed LED is on, the port LED is indicating the data transmission rate. When the PoE LED is on, the port LED is indicating the power supply status. By default the Speed LED is on. Pressing the mode switch button, the Speed LED will turn off and the PoE LED will light up. Then the PoE LED will turn off after being on for 60 seconds and the Speed LED will light up again.

When the Speed LED is on, the port LED is indicating the data transmission rate.

LED	Status	Indication	
Power	On	The Switch is powered on	
	Off	The Switch is powered off or power supply is abnormal	
	Flashing	Power supply is abnormal	
System	Flashing	The Switch works properly	
	On/Off	The Switch works improperly	
10/100/ 1000Mbps	Green	On	A 1000Mbps device is connected to the corresponding port, but no activity
		Flashing	Data is being transmitted or received
	Yellow	On	A 10/100Mbps device is connected to the corresponding port, but no activity
		Flashing	Data is being transmitted or received
	Off	No device is connected to the corresponding port	

When the PoE LED is on, the port LED is indicating the power supply status.

LED	Status	Indication
Power	On	The Switch is powered on
	Off	The Switch is powered off or power supply is abnormal
	Flashing	Power supply is abnormal
System	Flashing	The Switch works properly
	On/Off	The Switch works improperly

LED	Status	Indication	
PoE Max	On	The remaining PoE power $\leq 7W$	
	Flashing	The remaining PoE power keeps $\leq 7W$ after this LED is on for 2 minutes	
	Off	The remaining PoE power $\geq 7W$	
10/100/1000Mbps	Green	On	The port is supplying power normally
		Flashing	The supply power exceeds the corresponding port's maximum power
	Yellow	On	Overload or short circuit is detected
		Flashing	Power-on self-test has failed
	Off	No PoE power supply is provided on the port	

LED Mode Switch Button

Press this button to switch the LED status indication between Speed and PoE.

Reset

Press this button for five seconds or above to reset the software setting back to factory default settings.

10/100/1000Mbps RJ45 Port

Designed to connect to the device with a bandwidth of 10Mbps, 100Mbps or 1000Mbps. Each has a corresponding 1000Mbps LED.

SFP Port

Designed to install the SFP module. TL-SG2424P Switch features 4 SFP transceiver slots that are shared with the associated RJ45 ports. The associated two ports are referred as a "Combo" port, which means they cannot be used simultaneously, otherwise only SFP port works.

The front panel of TL-SG2452 is shown as the following figure.

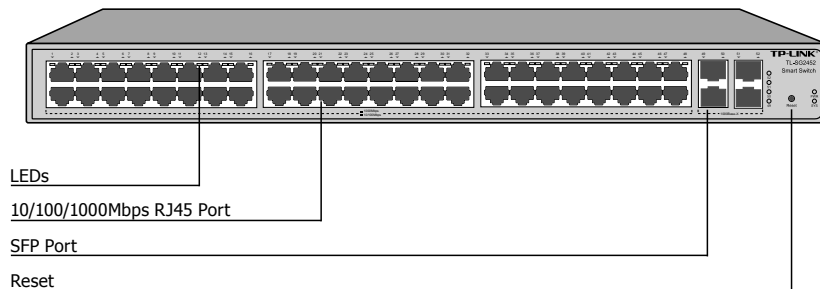

Figure 1-4 Front Panel of TL-SG2452

LEDs

LED	Status	Indication
PWR	On	The Switch is powered on
	Off	The Switch is powered off or power supply is abnormal
	Flashing	Power supply is abnormal
SYS	Flashing	The Switch works properly
	On/Off	The Switch works improperly

LED	Status	Indication	
10/100/ 1000Mbps	Green	On	A 1000Mbps device is connected to the corresponding port, but no activity
		Flashing	Data is being transmitted or received
	Yellow	On	A 10/100Mbps device is connected to the corresponding port, but no activity
		Flashing	Data is being transmitted or received
	Off	No device is connected to the corresponding port	

10/100/1000Mbps RJ45 Port

Designed to connect to the device with a bandwidth of 10Mbps, 100Mbps or 1000Mbps. Each has a corresponding 1000Mbps LED.

SFP Port

Designed to install the SFP module. TL-SG2452 features 4 individual SFP ports.

Reset

Press this button for five seconds or above to reset the software setting back to factory default settings.

Port Feature

Model	10/100/1000Mbps RJ45 Port	SFP Port
TL-SG2216	16	2
TL-SG2424	24	4
TL-SG2424P	24	4
TL-SG2452	48	4



Note: For TL-SG2216/TL-SG2424/TL-SG2424P, when using the SFP port with a 100M module or a gigabit module, you need to log on to the GUI (Graphical User Interface) of the Switch and configure its corresponding Speed and Duplex mode on **Switching**→**Port**→**Port Config** page. For 100M module, please select 100MFD while select 1000MFD for gigabit module. By default, the Speed and Duplex mode of SFP port is 1000MFD. TL-SG2452 supports 1000M SFP module connection only.

Rear Panel

The rear panel of TL-SG2216 is shown as the following figure.

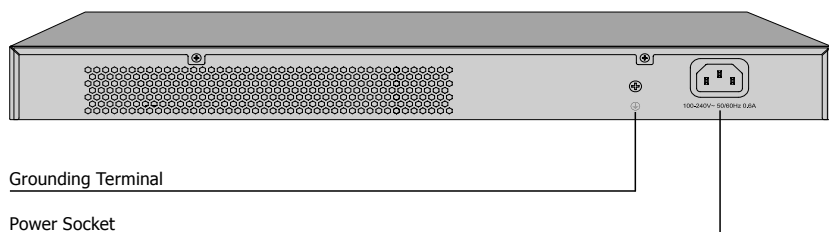

Figure 1-5 Rear Panel of TL-SG2216

The rear panel of TL-SG2424 is shown as the following figure.

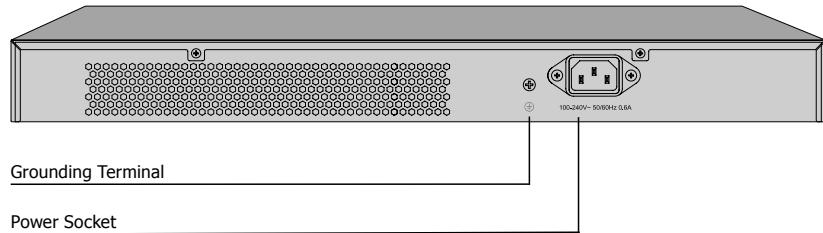

Figure 1-6 Rear Panel of TL-SG2424

The rear panel of TL-SG2424P is shown as the following figure.

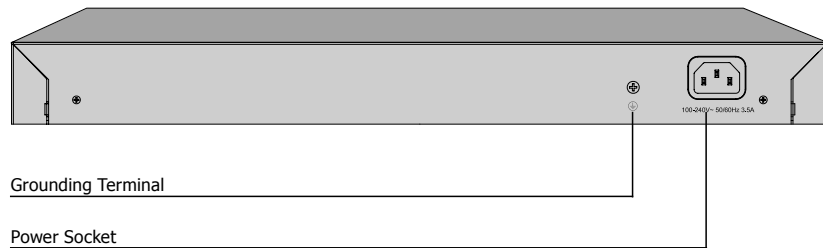

Figure 1-7 Rear Panel of TL-SG2424P

The rear panel of TL-SG2452 is shown as the following figure.

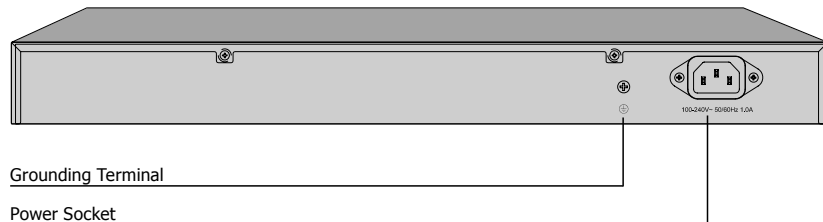

Figure 1-8 Rear Panel of TL-SG2452

Grounding Terminal

The Switch already comes with lightning protection mechanism. You can also ground the Switch through the PE (Protecting Earth) cable of AC cord or with Ground Cable. For detailed information, please refer to **Chapter 3 Lightning Protection**.

Power Socket

Connect the female connector of the power cord here, and the male connector to the AC (Alternating Current) power outlet. Please make sure the voltage of the power supply meets the requirement of the input voltage.



Caution: Please use the provided power cord.

Chapter 2 Installation

2.1 Package Contents

Make sure that the package contains the following items. If any of the listed items is damaged or missing, please contact your distributor.

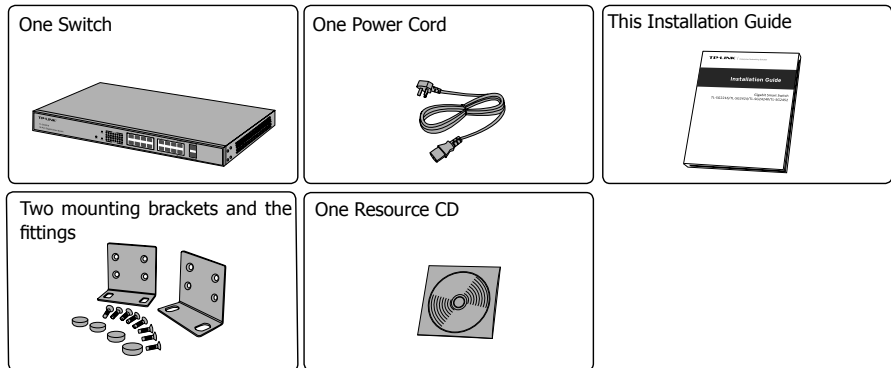

2.2 Safety Precautions

To avoid any device damage and bodily injury caused by improper use, please observe the following rules.

■ Safety Precautions

- Keep the power off during the installation.
- Wear an ESD-preventive wrist strap, and make sure that the wrist strap has a good skin contact and is well grounded.
- Use only the power cord provided with the Switch.
- Make sure that the supply voltage matches the specifications indicated on the rear panel of the Switch.
- Ensure the vent hole is well ventilated and unblocked.
- Do not open or remove the cover of the Switch.
- Before cleaning the device, cut off the power supply. Do not clean it by the waterish cloth, and never use any other liquid cleaning method.

■ Site Requirements

Temperature/Humidity



Please keep a proper temperature and humidity in the equipment room. Too high/low humidity may lead to bad insulation, electricity leakage, mechanical property changes and corrosions. Too high temperature may accelerate aging of the insulation materials and can thus significantly shorten the service life of the device. For normal temperature and humidity of the device, please check the following table.

Environment	Temperature	Humidity
Operating	0°C ~ 40°C	10% ~ 90%RH Non-condensing
Storage	-40°C ~ 70°C	5% ~ 90%RH Non-condensing

Clearness



The dust accumulated on the Switch can be absorbed by static electricity and result in poor contact of metal contact points. Some measures have been taken for the device to prevent static electricity, but too strong static electricity can cause deadly damage to the electronic elements on the internal circuit board. To avoid the effect of static electricity on the operation of the Switch, please attach much importance to the following items:

- Dust the device regularly, and keep the indoor air clean.
- Keep the device well grounded and ensure static electricity has been transferred.

Electromagnetic Interference

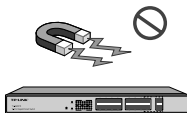

Electronic elements including capacitance and inductance on the device can be affected by external interferences, such as conducted emission by capacitance coupling, inductance coupling, and impedance coupling. To decrease the interferences, please make sure to take the following measures:

- Use the power supply that can effectively filter interference from the power grid.
- Keep the device far from high-frequency, strong-current devices, such as radio transmitting station.
- Use electromagnetic shielding when necessary.

Lightning Protection



Extremely high voltage currents can be produced instantly when lightning occurs and the air in the electric discharge path can be instantly heated up to 20,000°C. As this instant current is strong enough to damage electronic devices, more effective lightning protection measures should be taken.

- Ensure the rack and device are well earthed.
- Make sure the power socket has a good contact with the ground.
- Keep a reasonable cabling system and avoid induced lightning.
- Use the signal SPD (Surge Protective Device) when wiring outdoor.



Note: For detailed lightning protection measures, please refer to **Chapter 3 Lightning Protection**.

Installation Site

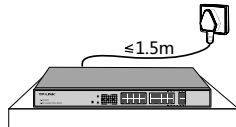

When installing the device on a rack or a flat workbench, please note the following items:

- The rack or workbench is flat and stable, and sturdy enough to support the weight of 5.5kg at least.
- The rack or workbench has a good ventilation system. The equipment room is well ventilated.
- The rack is well grounded. Keep the power socket less than 1.5 meters away from the device.

2.3 Installation Tools

- Phillips screwdriver
- ESD-preventive wrist wrap
- Cables



Note: These tools are not provided with our product. If needed, please self purchase them.

2.4 Product Installation

■ Desktop Installation

To install the device on the desktop, please follow the steps:

1. Set the device on a flat surface strong enough to support the entire weight of the device with all fittings.
2. Remove the adhesive backing papers from the rubber feet.
3. Turnover the device and attach the supplied rubber feet to the recessed areas on the bottom at each corner of the device.

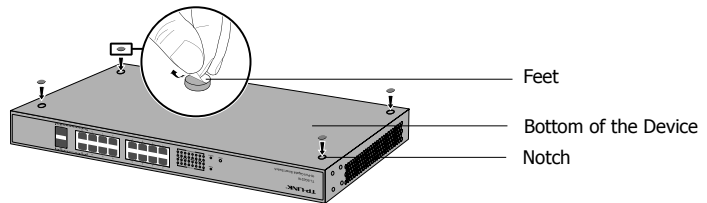

Figure 2-1 Desktop Installation

■ Rack Installation

To install the device in an EIA standard-sized, 19-inch rack, follow the instructions described below:

1. Check the grounding and stability of the rack.
2. Secure the supplied rack-mounting brackets to each side of the device with supplied screws, as illustrated in the following figure.

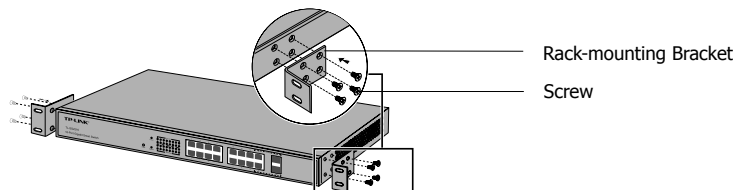

Figure 2-2 Bracket Installation

3. After the brackets are attached to the device, use suitable screws (not provided) to secure the brackets to the rack, as illustrated in the following figure.

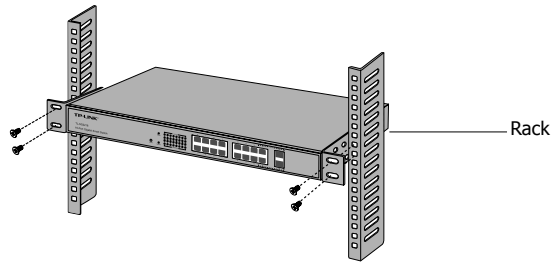

Figure 2-3 Rack Installation

**Caution:**

- Please set 5~10cm gaps around the device for air circulation.
- Please avoid any heavy thing placed on the device.
- Please mount devices in sequence from the bottom to top of the rack and ensure a certain clearance between devices for the purpose of heat dissipation.

Chapter 3 Lightning Protection

3.1 Cabling Reasonably

In the actual network environment, you may need cable outdoors and indoors, and the requirements for cabling outdoors and indoors are different. A reasonable cabling system can decrease the damage of induced lightning to devices.



Note: It's not recommended using Ethernet cables outdoors. When cabling outdoors, please use a signal lightning arrester.

■ Requirements for Cabling Outdoors

- Aerial cabling without safeguard is not allowed.

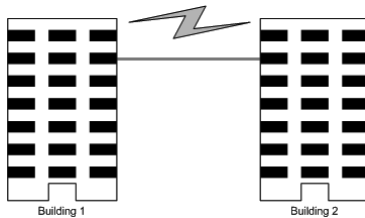

- It's not allowed cabling down the building to connect network devices in different floors.

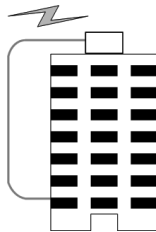

- Outdoor cables should be buried and paved to the indoor through basement. A piece of steel wire should be paved underground along the pipe and connected to the lightning protection terminal of the building for shielding. Before connecting the cable to the device, install a signal lightning arrester on the corresponding port.
- When an aerial cable is set up, the cable should be through a metal pipe (15m long at least) before coming into the building. The two ends of this metal pipe should be grounded. Before connecting the cable to the device, install a signal lightning arrester on the corresponding port.
- It's not necessary to pave STP cables through pipes. The shielded layer of STP cable should be well grounded. Before connecting the cable to the device, install a signal lightning arrester on the corresponding port.

■ Requirements for Cabling Indoors

When cabling indoors, keep a certain distance away from the devices that may cause high-frequency interferences, such as down-conductor cable, powerline, power transformer and electromotor.

- The main cable should be paved in the metal raceway of the access shaft. When cabling, keep the loop area formed by the cable itself as small as possible.
- Requirements for the distance between Ethernet cable and other pipelines are shown in the table.

Other Pipelines	Ethernet Cable	
	Min Parallel Net Length L (mm)	Min Parallel-overlapping Net Height H (mm)
Down-conductor	1000	300
PE	50	20
Service pipe	150	20
Compressed air pipe	150	20
Thermal pipe (not wrapped)	500	500
Thermal pipe (wrapped)	300	300
Gas pipe	300	20

The two diagrams below demonstrate parallel net length and parallel-overlapping net height.

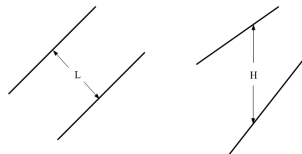

Note: The above minimum net length/height is required when metal raceway is not used. If any requirements cannot be met, you can add a steel tube or metal raceway for shielding.

- Requirements for the distance between Ethernet cable and high-power electric devices are in following tables.

Cable	Pave Way	Min Parallel Length (mm)
<2kVA powerline	Parallel cabling	130
	One is in the grounded metal raceway or metal pipe	70
	The both are in the grounded metal raceway or metal pipe	10

Cable	Pave Way	Min Parallel Length (mm)
2~5kVA powerline	Parallel cabling	300
	One is in the grounded metal raceway or metal pipe	150
	The both are in the grounded metal raceway or metal pipe	80
>5kVA powerline	Parallel cabling	600
	One is in the grounded metal raceway or metal pipe	300
	The both are in the grounded metal raceway or metal pipe	150

Device	Min Distance (m)
Switch case	1.00
Transformer room	2.00
Elevator tower	2.00
Air-conditioner room	2.00

3.2 Connect to Ground

Connecting the device to ground is to quickly release the lightning over-voltage and over-current of the device, which is also a necessary measure to protect the body from electric shock.

In different environments, the device may be grounded differently. The following will instruct you to connect the device to the ground in two ways, connecting to the grounding bar or connecting to the ground via the power cord. Please connect the device to ground in the optimum way according to your specific operation environment.

■ Connecting to the Grounding Bar

If the device is installed in the Equipment Room, where a grounding bar is available, you are recommended to connect the device to the grounding bar as shown in the following figure.

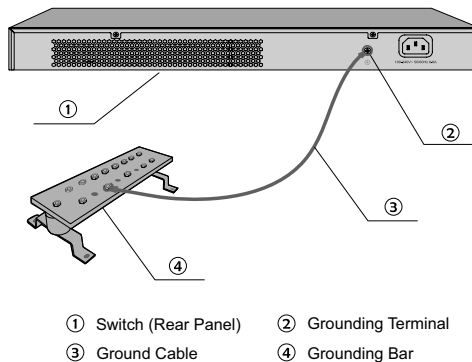

Figure 3-1 Connecting to the Grounding Bar



Note: The grounding bar and the ground cable are not provided with our product. If needed, please self purchase them.

■ Connecting to the Ground via the Power Supply

If the device is installed in the normal environment, the device can be grounded via the PE (Protecting Earth) cable of the AC power supply as shown in the following figure.

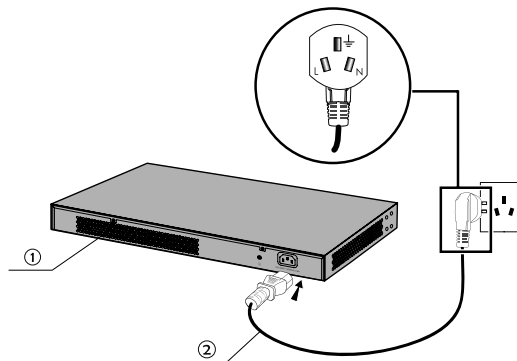

① Switch (Rear Panel) ② AC Power Cord (with PE cable)

Figure 3-2 Connecting to the Ground



Note:

- The figure is to illustrate the application and principle. The power plug you get from the package and the socket in your situation will comply with the regulation in your country, so they may differ from the figure above.
- If you intend to connect the device to the ground via the PE (Protecting Earth) cable of AC power cord, please make sure the PE (Protecting Earth) cable in the electrical outlet is well grounded in advance.

3.3 Equipotential Bonding

Equipotential Bonding is the practice of intentionally electrically connecting all earthed systems to the same grounding grid or connecting the grounding grids of all the earthed systems together through the ground or overground metal so as to create an earthed equipotential zone. When lightning occurs, the high voltage produced by lightning current in all systems will meanwhile exist in their ground cables, and thus all ground cables have the same electrical potential and basically eliminate the electric strikes between the systems.

The figure below illustrates how to practice equipotential bonding in a network.

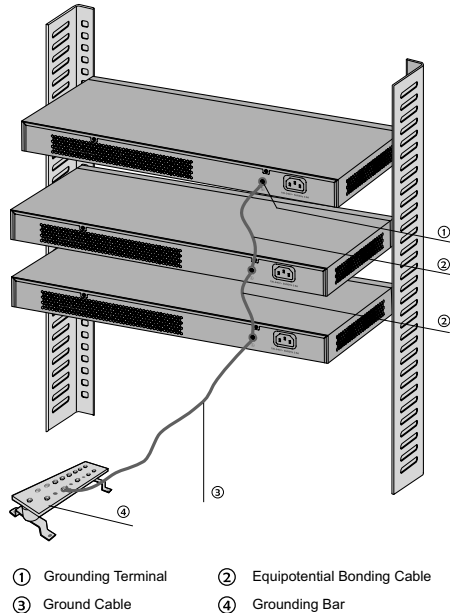

Figure 3-3 Equipotential Bonding

When equipotential bonding, please note that the cable should be copper wrapped Kelly with its area being 6mm^2 at least. The shorter cable the better, and use a grounding bar to establish an equipotential bonding point.



Note: The equipotential bonding cable and ground cable are not provided with our product. If needed, please self purchase it.

3.4 Use Lightning Arrester

Power lightning arrester and signal lightning arrester are used for lightning protection.

Power lightning arrester is used for limiting the voltage surge due to a lightning. If an outdoor AC power cord should be directly connected to the device, please use a power lightning arrester.



Note: Power lightning arrester is not provided with our product. If needed, please self purchase it.

Signal lightning arrester is used to protect RJ45 ports of the device from lightning. When cabling outdoors, please install a signal lightning arrester before connecting the cable to the device.

When purchasing or using a signal lightning arrester, please observe the following rules:

- The port rate of the signal lightning arrester should match the rate of the desired port on the device. If it is not matched, this signal lightning arrester will not work. Purchase a standard lightning arrester.
- Install signal lightning arrester near the protected device and connect it to the ground via a shorter ground cable.

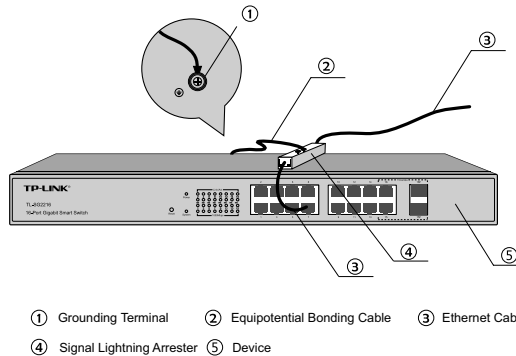

Figure 3-4 Lighting Arrester Connection



Note: Signal lightning arrester is not provided with our product. If needed, please self purchase it.

Chapter 4 Connection

4.1 Ethernet Port

Connect a Ethernet port of the Switch to the computer by RJ45 cable as the following figure shown.

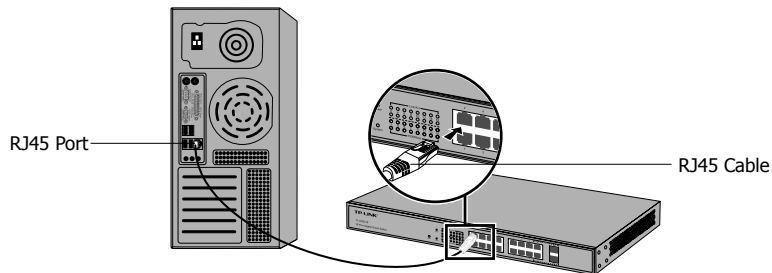

Figure 4-1 Connecting the RJ45 Port

4.2 SFP Port

Connect the SFP port to a SFP module. If an SFP transceiver (purchased separately) is installed in a slot and has a valid link on the port, the associated RJ45 port will be disabled and cannot be used.

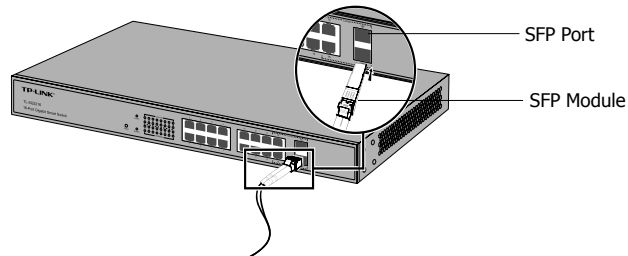

Figure 4-2 Inserting the SFP Module



Note: When using the SFP port with a 100Mbps module or a gigabit module, you need to log on to the GUI (Graphical User Interface) of the Switch and configure its corresponding Speed and Duplex mode on **Switching**→**Port**→**Port Config** page. For 100Mbps module, please select 100MFD while select 1000MFD for gigabit module. By default, the Speed and Duplex mode of SFP port is 1000MFD. TL-SG2452 features 4 individual SFP ports which support 1000M SFP module connection only.

4.3 Verify Installation

After completing the installation, please verify the following items:

- There are 5~10cm of clearance around the sides of the device for ventilation and the air flow is adequate.
- The voltage of the power supply meets the requirement of the input voltage of the device.
- The power socket, device and rack are well grounded.
- The device is correctly connected to other network devices.

4.4 Power On

Plug in the negative connector of the provided power cord into the power socket of the device, and the positive connector into a power outlet as the following figure shown.

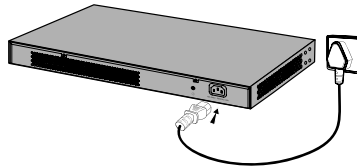

Figure 4-3 Connecting to Power Supply



Note: The figure is to illustrate the application and principle. The power plug you get from the package and the socket in your situation will comply with the regulation in your country, so they may differ from the figure above.

4.5 Initialization

After the device is powered on, it begins the Power-On Self-Test. A series of tests run automatically to ensure the device functions properly. During this time, its LED indicators will respond as follows:

- The Power/PWR LED indicator will light on all the time.
- After keeping off for several seconds, the LED indicators of all the ports will flash momentarily and then turn off again after the initialization.
- The System/SYS LED indicator will flash, which represents a successful initialization.

Chapter 5 Configuration

5.1 Configure the Switch via GUI

1. To access the GUI of the Switch, open a web browser and type the default management address `http://192.168.0.1` in the address field of the browser, then press the Enter key.

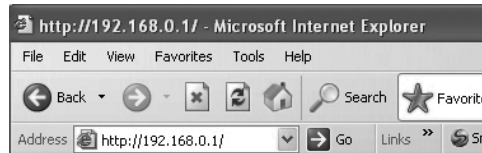

Figure 5-1 Web Browser



Note: To log on to the GUI of the Switch, the IP address of your PC should be set in the same subnet addresses of the Switch. The IP address is 192.168.0.x ("x" is any number from 2 to 254), Subnet Mask is 255.255.255.0. For the detailed instructions as to how to do this, please refer to Appendix B in the User Guide on the Resource CD.

2. Enter admin for the default User Name and Password, both in lower case letters. Then click the Login button or press the Enter key.

A screenshot of the TP-LINK login page. The page has a dark header with the "TP-LINK" logo. Below the header, there are two input fields: "User Name:" with the text "admin" entered, and "Password:" with five dots representing a masked password. At the bottom of the form, there are two buttons: "Login" and "Clear".

Figure 5-2 Login

3. After a successful login, the main page will appear as the following figure, and you can configure the function by clicking the setup menu on the left side of the screen.

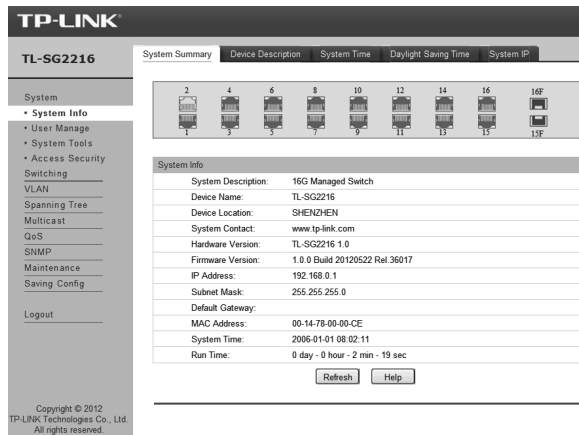

Figure 5-3 Main Page of the Switch

5.2 Configure the Switch Using CLI

You can log on to the Switch and access the CLI by Logging on to the Switch remotely by a Telnet connection through an Ethernet port. To log on to the switch by a Telnet connection, please take the following steps:

1. Make sure the switch and the PC are in the same LAN.
2. Click Start→Run to open the Run window.



Figure 5-4 Open the Run window

3. Type cmd in the prompt Run window as Figure 5-5 and click OK.

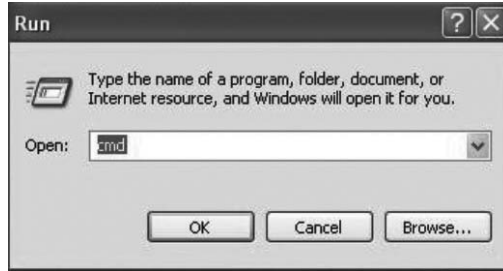

Figure 5-5 Run Window

4. Type telnet 192.168.0.1 in the command prompt shown as Figure 5-6, and press the Enter button.

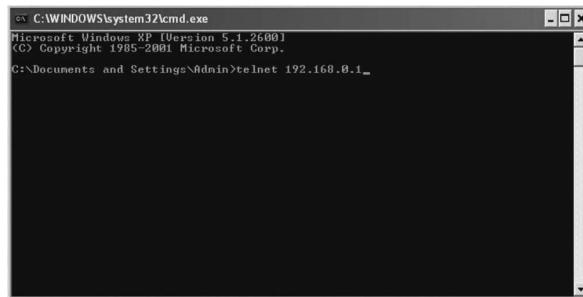

Figure 5-6 Connecting to the Switch



Note: TL-SG2452 is unaccessible through Telnet Connection so that no configuration can be made by using CLI.

Appendix A Troubleshooting

Q1. What could I do if I forgot the username and password of the Switch?

Press the Reset button for at least 5 seconds to reset the system. The system will be reset to the factory default settings, and the default login user name and password are both admin.

Q2. Why does the Power LED work abnormally?

The Power LED should be lit up when the power system works normally. If the Power LED worked abnormally, please take the following steps:

1. Make sure that the power cable is connected properly, and the power contact is normal.
2. Make sure the voltage of the power supply meets the requirement of the input voltage of the Switch.

Q3. What could I do if I could not access the web-based configuration page?

You are recommended to check the following items:

1. Check every port LED on the Switch and make sure the cable is installed properly.
2. Try another port on the Switch and make sure the cable meets the requirement and works normally.
3. Turn off the power. After a while, turn on the power again.
4. Make sure the IP address of your PC is set within the subnet of the Switch.
5. If you still cannot access the configuration page, please restore the Switch to its factory defaults. Then the IP address should be set as 192.168.0.x ("x" is any number from 2 to 254) and Subnet Mask as 255.255.255.0.

Appendix B Hardware Specifications

Item	Content
Standards	IEEE 802.3 10Base-T Ethernet
	IEEE 802.3u 100Base-TX/100Base-FX
	IEEE 802.3ab 1000Base-T
	IEEE 802.3z 1000Base-X
	IEEE 802.3x Flow Control
	IEEE 802.3af (for TL-SG2424P only)
	IEEE 802.3at (for TL-SG2424P only)
Transmission Medium	10Base-T: UTP/STP of Cat. 3 or above (maximum 100m)
	100Base-TX: 2-pair UTP/STP of Cat. 5 or above (maximum 100m)
	100Base-FX: MMF or SMF SFP Module (Optional)
	1000Base-T: 4-pair UTP/STP of Cat. 5, Cat. 5e and Cat. 6 or above (maximum 100m)
	1000Base-X: MMF or SMF SFP Module (Optional)
LEDs	TL-SG2216/TL-SG2424: Power, System, 1000Mbps, Link/Act TL-SG2424P: Power, System, Speed, Port Status LED, PoE, PoE Max TL-SG2452: PWR,SYS,10/100/1000Mbps
Operating Temperature	0°C~40°C
Storage Temperature	-40°C~70°C
Operating Humidity	10%~90%RH Non-condensing
Storage Humidity	5%~90%RH Non-condensing

Appendix C Technical Support

- For more troubleshooting help, please go to: www.tp-link.com/support/faq
- To download the latest Firmware, Driver, Utility and User Guide, go to: www.tp-link.com/en/support/download
- For all other technical support, please contact us by using the following details:

Global	Tel: +86 755 2650 4400 E-mail: support@tp-link.com Service time: 24hrs, 7 days a week
Singapore	Tel: +65 6284 0493 E-mail: support.sg@tp-link.com Service time: 24hrs, 7 days a week
UK	Tel: +44 (0) 845 147 0017 E-mail: support.uk@tp-link.com Service time: 24hrs, 7 days a week
USA/Canada	Toll Free: +1 866 225 8139 E-mail: support.usa@tp-link.com Service time: 24hrs, 7 days a week
Australia & New Zealand	Tel: AU 1300 87 5465 NZ 0800 87 5465 E-mail: support.au@tp-link.com (Australia) support.nz@tp-link.com (New Zealand) Service time: 24hrs, 7 days a week
Malaysia	Tel: 1300 88 875 465 (1300 88TP-LINK) Email: support.my@tp-link.com Service time: 24hrs, 7 days a week
Turkey	Tel: 444 1925 (Turkish Service) E-mail: support.tr@tp-link.com Service time: 09:00 to 21:00 , 7 days a week
Italy	Tel: +39 023 051 9020 E-mail: support.it@tp-link.com Service time: Monday to Friday, 09:00 to 13:00 and 14:00 to 18:00
France	Tel: +33 (0) 820 800 860 (French service) Email: support.fr@tp-link.com Fee: 0.118 EUR/min from France Service time: Monday to Friday, 09:00 to 18:00 *Except French Bank holidays
Indonesia	Tel: (+62) 021 6386 1936 E-mail: support.id@tp-link.com Service time: 09:00 to 18:00 (From Monday to Friday , except public holidays)

Germany/Austria	Tel: +49 1805 875 465 (German Service) +49 1805 TPLINK +43 820 820 360 E-mail: support.de@tp-link.com Fee: 0.14 EUR/min from the German fixed phone network and up to 0.42 EUR/min from mobile phone Service time: Monday to Friday, 09:00 to 12:30 and 13:30 to 17:30. GMT+ 1 or GMT+ 2 (Daylight Saving Time in Germany) *Except bank holidays in Hesse
Switzerland	Tel: +41 (0) 848 800 998 (German Service) E-mail: support.ch@tp-link.com Fee: 4-8 Rp/min, depending on rate of different time Service time: Monday to Friday, 09:00 to 12:30 and 13:30 to 17:30. GMT+ 1 or GMT+ 2 (Daylight Saving Time)
Russian Federation	Tel: 8 (499) 754 5560 8 (800) 250 5560 (toll-free call from any RF region) E-mail: support.ru@tp-link.com Service time: From 10:00 to 18:00 (Moscow time) *Except weekends and holidays in Russian Federation
Ukraine	Tel: 0800 505 508 E-mail: support.ua@tp-link.com Service time: Monday to Friday 10:00 to 22:00
Brazil	Toll Free: 0800 608 9799 (Portuguese Service) E-mail: suporte.br@tp-link.com Service time: Monday to Friday, 09:00 to 20:00; Saturday, 09:00 to 15:00
Poland	Tel: +48 (0) 801 080 618 +48 227 217 563 (if calls from mobile phone) E-mail: support.pl@tp-link.com Service time: Monday to Friday 09:00 to 17:00. GMT+1 or GMT+2 (Daylight Saving Time)

TP-LINK®
The Reliable Choice

Website: <http://www.tp-link.com> E-mail: support@tp-link.com

7106504146 Rev: 1.1.0

Free Manuals Download Website

<http://myh66.com>

<http://usermanuals.us>

<http://www.somanuals.com>

<http://www.4manuals.cc>

<http://www.manual-lib.com>

<http://www.404manual.com>

<http://www.luxmanual.com>

<http://aubethermostatmanual.com>

Golf course search by state

<http://golfingnear.com>

Email search by domain

<http://emailbydomain.com>

Auto manuals search

<http://auto.somanuals.com>

TV manuals search

<http://tv.somanuals.com>