

TP-LINK®

User Guide

TL-WA5110G

54Mbps High Power Wireless Access Point



Rev: 2.0.0
1910010339

COPYRIGHT & TRADEMARKS

Specifications are subject to change without notice. **TP-LINK**[®] is a registered trademark of TP-LINK TECHNOLOGIES CO., LTD. Other brands and product names are trademarks or registered trademarks of their respective holders.

No part of the specifications may be reproduced in any form or by any means or used to make any derivative such as translation, transformation, or adaptation without permission from TP-LINK TECHNOLOGIES CO., LTD. Copyright © 2010 TP-LINK TECHNOLOGIES CO., LTD.

All rights reserved.

<http://www.tp-link.com>

FCC STATEMENT



This equipment has been tested and found to comply with the limits for a Class B digital device, pursuant to part 15 of the FCC Rules. These limits are designed to provide reasonable protection against harmful interference in a residential installation. This equipment generates, uses and can radiate radio frequency energy and, if not installed and used in accordance with the instructions, may cause harmful interference to radio communications. However, there is no guarantee that interference will not occur in a particular installation. If this equipment does cause harmful interference to radio or television reception, which can be determined by turning the equipment off and on, the user is encouraged to try to correct the interference by one or more of the following measures:

- Reorient or relocate the receiving antenna.
- Increase the separation between the equipment and receiver.
- Connect the equipment into an outlet on a circuit different from that to which the receiver is connected.
- Consult the dealer or an experienced radio/ TV technician for help.

This device complies with part 15 of the FCC Rules. Operation is subject to the following two conditions:

- 1) This device may not cause harmful interference.
- 2) This device must accept any interference received, including interference that may cause undesired operation.

Any changes or modifications not expressly approved by the party responsible for compliance could void the user's authority to operate the equipment.

Note: The manufacturer is not responsible for any radio or tv interference caused by unauthorized modifications to this equipment. Such modifications could void the user's authority to operate the equipment.

FCC RF Radiation Exposure Statement

This equipment complies with FCC RF radiation exposure limits set forth for an uncontrolled environment. This device and its antenna must not be co-located or operating in conjunction with any other antenna or transmitter.

"To comply with FCC RF exposure compliance requirements, this grant is applicable to only Mobile Configurations. The antennas used for this transmitter must be installed to provide a separation distance of at least 20 cm from all persons and must not be co-located or operating in conjunction with any other antenna or transmitter."

CE Mark Warning



This is a class B product. In a domestic environment, this product may cause radio interference, in which case the user may be required to take adequate measures.

National Restrictions

2400.0-2483.5 MHz

Country	Restriction	Reason/remark
Bulgaria		General authorization required for outdoor use and public service
France	Outdoor use limited to 10 mW e.i.r.p. within the band 2454-2483.5 MHz	Military Radiolocation use. Refarming of the 2.4 GHz band has been ongoing in recent years to allow current relaxed regulation. Full implementation planned 2012
Italy		If used outside of own premises, general authorization is required
Luxembourg	None	General authorization required for network and service supply(not for spectrum)
Norway	Implemented	This subsection does not apply for the geographical area within a radius of 20 km from the centre of Ny-Ålesund
Russian Federation		Only for indoor applications

Note: It's not used outdoors in France.

DECLARATION OF CONFORMITY

For the following equipment:

Product Description: **54Mbps High Power Wireless Access Point**

Model No.: **TL-WA5110G**

Trademark: **TP-LINK**

We declare under our own responsibility that the above products satisfy all the technical regulations applicable to the product within the scope of Council Directives:

Directives 1999/5/EC

The above product is in conformity with the following standards or other normative documents

ETSI EN 300 328 V1.7.1: 2006

ETSI EN 301 489-1 V1.8.1:2008& ETSI EN 301 489-17 V1.3.2:2008

EN 61000-3-2:2006

EN 61000-3-3:1995+A1:2001+A2:2005

EN60950-1:2006

Recommendation 1999/519/EC

EN62311:2008

Directives 2004/108/EC

The above product is in conformity with the following standards or other normative documents

EN 55022:2006 +A1:2007

EN 55024:1998+A1:2001+A2:2003

EN 61000-3-2:2006

EN 61000-3-3:1995+A1:2001+A2:2005

Directives 2006/95/EC

The above product is in conformity with the following standards or other normative documents

EN60950-1:2006

Person is responsible for marking this declaration:



Yang Hongliang

Product Manager of International Business

TP-LINK TECHNOLOGIES CO., LTD.

South Building, No.5 Keyuan Road, Central Zone, Science & Technology Park, Nanshan,

Shenzhen, P. R. China

CONTENTS

Package Contents	1
Chapter 1 Product Overview	2
1.1 Overview of the Product	2
1.2 Features	2
1.3 Conventions	3
Chapter 2 Hardware Installation	4
2.1 The Front Panel	4
2.2 The Rear Panel	4
2.3 System Requirements	5
2.4 Environment Requirements	5
2.5 Connecting the Device	5
Chapter 3 Quick Installation Guide	7
3.1 Configure the PC	7
3.2 Quick Setup	10
Chapter 4 AP Client Router & AP Router Operation Mode	15
4.1 Login	15
4.2 Status	15
4.3 Quick Setup	17
4.4 Operation Mode	17
4.5 Network	17
4.5.1 LAN	18
4.5.2 WAN	18
4.5.3 MAC Clone	23
4.6 Wireless	23
4.6.1 Basic Settings	24
4.6.2 Wireless Mode	25
4.6.3 Security Settings	27
4.6.4 MAC Filtering	30
4.6.5 Wireless Statistics	32
4.6.6 Distance Setting	32
4.6.7 Antenna Alignment	33
4.6.8 Throughput Monitor	34
4.7 DHCP	34
4.7.1 DHCP Settings	35
4.7.2 DHCP Clients List	36
4.7.3 Address Reservation	36

4.8	Wireless settings	38
4.9	Forwarding	38
4.9.1	Virtual Servers	39
4.9.2	Port Triggering	40
4.9.3	DMZ	42
4.9.4	UPnP	43
4.10	Security	43
4.10.1	Firewall	44
4.10.2	IP Address Filtering	45
4.10.3	Domain Filtering	46
4.10.4	MAC Address Filtering	48
4.10.5	Remote Management	49
4.10.6	Advanced Security	50
4.11	Static Routing	52
4.12	IP & MAC Binding	53
4.12.1	Binding Setting	53
4.12.2	ARP List	55
4.13	Dynamic DNS	56
4.13.1	Dyndns.org DDNS	56
4.13.2	Oray.net DDNS	56
4.13.3	Comexe.cn DDNS	57
4.14	System Tools	58
4.14.1	Time	59
4.14.2	Firmware	60
4.14.3	Factory Defaults	61
4.14.4	Backup & Restore	61
4.14.5	Ping Watch Dog	62
4.14.6	Speed Test	62
4.14.7	Reboot	63
4.14.8	Password	64
4.14.9	Syslog	64
4.14.10	Statistics	65
Chapter 5	AP Operation Mode	67
5.1	Login	67
5.2	Status	67
5.3	Quick Setup	68
5.4	Operation Mode	69
5.5	Network	69

5.6	Wireless	70
5.6.1	Basic Settings.....	70
5.6.2	Wireless Mode.....	72
5.6.3	Security Settings	77
5.6.4	MAC Filtering.....	80
5.6.5	Wireless Statistics	82
5.6.6	Distance Setting	83
5.6.7	Antenna Alignment.....	83
5.6.8	Throughput Monitor	84
5.7	DHCP.....	84
5.7.1	DHCP Settings	85
5.7.2	DHCP Clients List.....	86
5.7.3	Address Reservation	86
5.8	Wireless settings.....	88
5.9	System Tools	88
5.9.1	Firmware.....	89
5.9.2	Factory Defaults	90
5.9.3	Backup & Restore	90
5.9.4	Ping Watch Dog	91
5.9.5	Speed Test	91
5.9.6	Reboot.....	92
5.9.7	Password.....	93
5.9.8	Syslog.....	93
Appendix A: FAQ		95
Appendix B: Specifications.....		99
Appendix C: Glossary.....		100

Package Contents

The following items should be found in your package:

- One TL-WA5110G 54Mbps High Power Wireless Access Point
- One power Adapter for TL-WA5110G 54Mbps High Power Wireless Access Point
- One Power Injector
- Mounting Kits
- Quick Installation Guide
- One Resource CD for TL-WA5110G 54Mbps High Power Wireless Access Point, including:
 - This User Guide
 - Other helpful information

 **Note:**

Make sure that the package contains the above items. If any of the listed items are damaged or missing, please contact your distributor.

Chapter 1 Product Overview

Thank you for choosing **TL-WA5110G 54Mbps High Power Wireless Access Point**.

1.1 Overview of the Product

The TL-WA5110G 54Mbps High Power Wireless Access Point is dedicated to Small Office/Home Office (SOHO) wireless network solutions. The TL-WA5110G 54Mbps High Power Wireless Access Point will allow you to connect your network with other wireless devices wirelessly, sharing Internet Access, files and fun, easily and securely. The high power design guarantees the great signal penetrability and excellent signal strength and thus will help you to build a more stable link or cover more area whether indoors or outdoors.

The TL-WA5110G 54Mbps High Power Wireless Access Point provides 3 operation modes for multi-user to access the Internet: AP client router, AP router and AP. In AP client router mode, it works as a WISP CPE and can access the Internet wirelessly via your WISP. In AP router mode, it can access the Internet via an ADSL/Cable Modem, while sharing data wirelessly. In AP mode it can work in various modes, such as Access Point/Client/WDS Bridge/Repeater.

With the most attentive wireless security, the TL-WA5110G 54Mbps High Power Wireless Access Point provides multiple protection measures. It can be set to turn off wireless network name (SSID) broadcast so that only stations that have the SSID can be connected. The AP provides wireless LAN 64/128/152-bit WEP encryption security, and WPA/WPA2 and WPA-PSK/WPA2-PSK authentication, as well as TKIP/AES encryption security. It also supports VPN pass-through for sensitive data secure transmission.

The TL-WA5110G 54Mbps High Power Wireless Access Point complies with the IEEE 802.11g and IEEE 802.11b standards so that the data transmission rate is up to 54Mbps. The wireless transmission range can extend up to tens of kilometers.

The TL-WA5110G 54Mbps High Power Wireless Access Point is easy-to-manage. Quick Setup is supported and friendly help messages are provided for every step. So you can configure it quickly and share the Internet more quickly and easily.

1.2 Features

- Complies with IEEE 802.11g, IEEE 802.11b, IEEE 802.3, IEEE 802.3u standards.
- Wireless Data transfer rates up to 54Mbps.
- Supports AP Client Router, AP Router and AP operation mode.
- High output transmit power and receive sensitivity optimized.
- Supports Client Router Mode for WISP CPE.
- Supports passive power over Ethernet.
- Supports Wireless Distribution System (WDS).
- ACK timeout adjustment for long range transmission, up to 50km.
- Supports Antenna Alignment.
- Provides throughput monitor indicating the current wireless throughput.
- Supports Layer 2 User Isolation.
- Supports Ping Watch Dog.
- Supports link speed test.

- Supports Remote Management.
- Output transmit power adjustable.
- Supports PPPoE, Dynamic IP, Static IP Internet Access.
- Built-in NAT and DHCP server supporting static IP address distributing.
- Supports UPnP, Dynamic DNS, Static Routing, VPN Pass-through.
- Supports Virtual Server, Special Application and DMZ host.
- Built-in firewall supporting IP address filtering, Domain Name filtering, and MAC address filtering.
- Provides WLAN ACL (Access Control List).
- Supports configuration backup/restore and firmware upgrade.
- Supports Web management.

1.3 Conventions

The AP or TL-WA5110G, or device mentioned in this User Guide stands for TL-WA5110G 54Mbps High Power Wireless Access Point without any explanations.

Parameters provided in the pictures are just references for setting up the product, which may differ from the actual situation.

You can set the parameters according to your demand.

Chapter 2 Hardware Installation

2.1 The Front Panel

The front panel of the TL-WA5110G consists of several LED indicators, which is designed to indicate connections. View from left to right. Table 2-1 describes the LEDs on the front panel of the router.

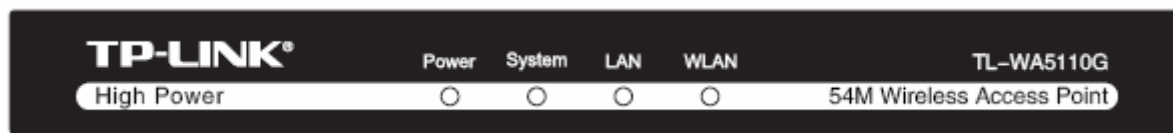

Figure 2-1 Front Panel sketch

LED Explanation:

Name	Status	Indication
Power	Off	No Power
	On	Power on
System	Off	The AP has a hardware error
	On	The AP is initialising
	Flashing	The AP is working properly
LAN	Off	There is no device linked to the corresponding port
	On	There is a device linked to the corresponding port but no activity
	Flashing	There is an active device linked to the corresponding port
WLAN	Off	The Wireless Radio function is disabled
	Flashing	The Wireless Radio function is enabled

Table 2-1

2.2 The Rear Panel

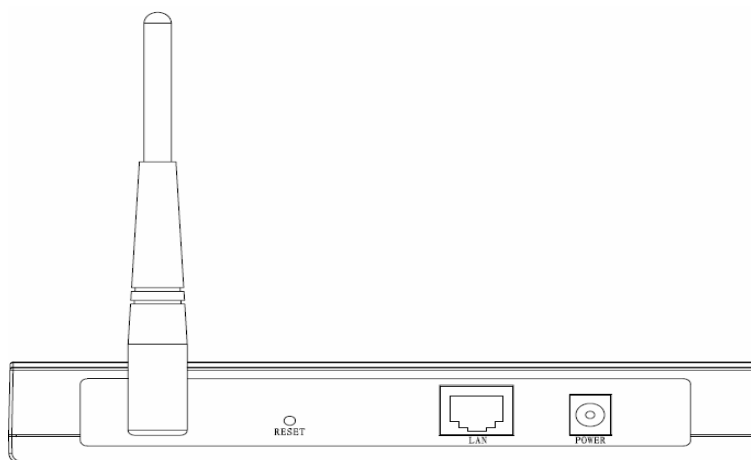

Figure 2-2 Rear Panel sketch

- Wireless antenna
- Factory Default Reset button

There are two ways to reset the AP's factory defaults:

- Use the **Factory Defaults** function on **System Tools** -> **Factory Defaults** page in the AP's Web-based Utility.
- Use the Factory Default RESET button: Press and hold the default **RESET** button for 5 seconds, and then the AP will reboot after the System LED flashes 5 times.

 **Note:**

Ensure the AP is powered on before it restarts completely.

- One LAN 10/100Mbps RJ45 port for connecting the AP to hub or switch.
- AC power socket: only use the power adapter supplied with the TL-WA5110G 54Mbps High Power Wireless Access Point, use of a different adapter may result in product damage.

2.3 System Requirements

- Each PC in the LAN needs a working Ethernet Adapter and an Ethernet cable with RJ45 connectors
- TCP/IP protocol must be installed on each PC
- Web browser, such as Microsoft Internet Explorer 5.0 or later, Netscape Navigator 6.0 or later
- If the device is configured to AP client router mode, you also need Wireless Internet Access Service (WISP)
- If the device is configured to AP router mode, you also need Broadband Internet Access Service (DSL/Cable/Ethernet)
- One DSL/Cable Modem that has an RJ45 connector (you do not need it if you connect the router to the Ethernet)

2.4 Environment Requirements

- Do not place in direct sunlight or near a heater or heating vent
- Do not cluttered or crowded. There should be at least 2 inches (5 cm) of clear space on all sides of the router
- Well ventilated (especially if it is in a closet)
- Operating temperature: 0°C~40°C (32°F~104°F)
- Operating Humidity: 10%~90% RH, Non-condensing

2.5 Connecting the Device

Figure 2-3 is an example of an infrastructure network incorporating the TL-WA5110G. An Infrastructure network contains an access point or a wireless router. To establish an infrastructure network in AP mode, please take the following steps:

1. You will need broadband Internet access (a Cable or DSL-subscriber line into your home or office). Consult with your Cable or DSL provider for proper installation of the modem.
2. Connect the Cable or DSL modem to a Router. Quickly install the router.
3. Locate an optimum location for the AP. The best place is usually near the center of the area in which your PC(s) will wirelessly connect. The place must accord with the [Installation Environment Requirements](#).
4. Adjust the direction of the antenna. Normally, upright is a good direction.

5. Connect the Ethernet Broadband Router to the TL-WA5110G AP. Power on the AP.
6. If you are connecting a desktop PC or laptop to your network, install the TP-LINK Wireless Adapter on the PC.

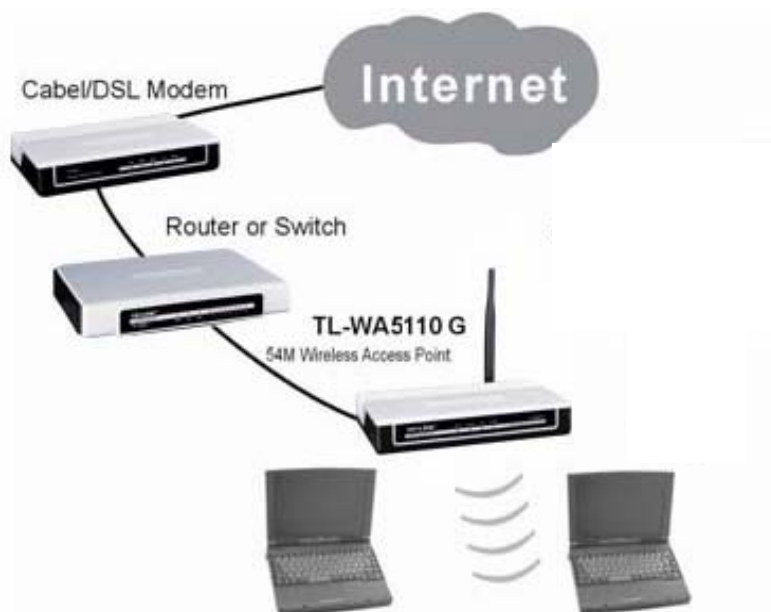

Figure 2-3

To establish an infrastructure network in AP Client Router mode as Figure 2-4, please take the following steps:

1. Make sure you are provided with wireless Internet service by your WISP (Wireless Internet Service Provider).
2. Locate an optimum location for the AP. Try to place your AP in an appropriate position where it can well receive the signal from WISP.
3. Connect the AP to the desktop PC.
4. Adjust the direction of the antenna. Normally, upright is a good direction.
5. Power on the AP and then you can configure the AP on the web-based page on your computer.



Figure 2-4

Chapter 3 Quick Installation Guide

This Chapter will guide you to configure the AP to function in your network and gain access to the internet through your ISP immediately after successful configuration. More detailed description of the AP's web-based utility and functions can be found in "Chapter 4 Configuring the AP"

3.1 Configure the PC

This section will guide you to configure your PC to communicate with the AP. The wireless adapter-equipped computers in your network must be in the same IP Address range without overlap with each other. Manually configure the **IP address** as 192.168.1.* (* is any integer between 1 to 253), and the **Subnet mask** as 255.255.255.0 for your PC by following the instructions below.

Connect the local PCs to the LAN ports on the AP and configure the IP address manually for your PCs.

1. Click **Start** (in the lower left corner of the screen), right-click **My Network Connections** and choose **Properties**.

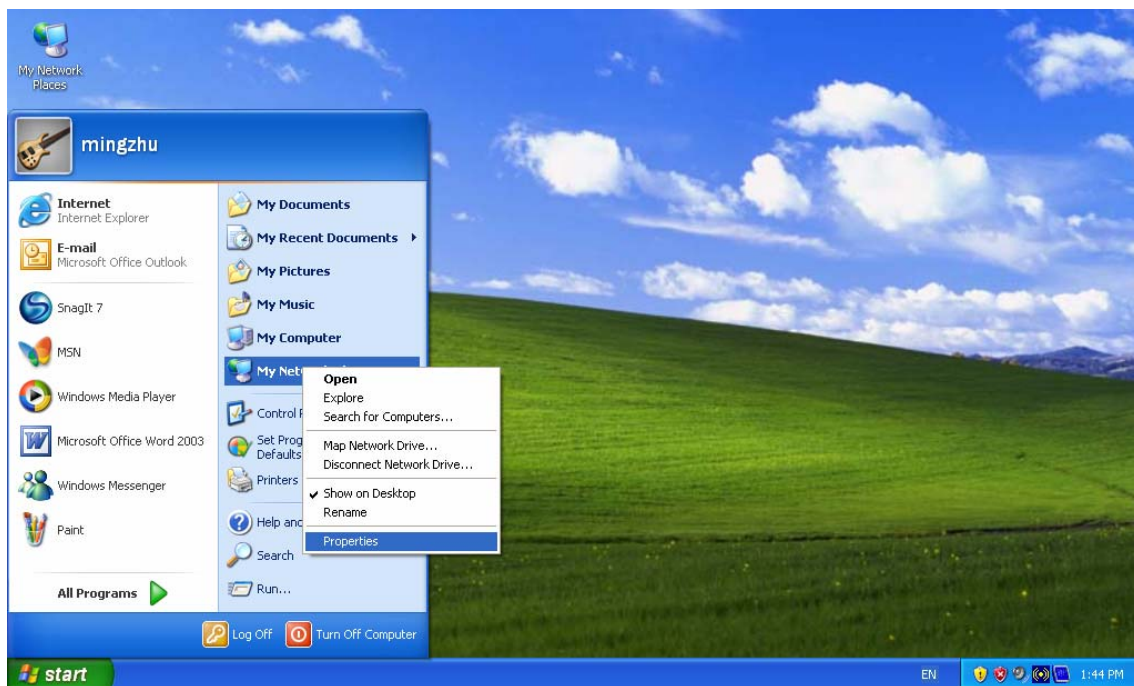

Figure 3-1

2. On the **My Network Connections** window shown as Figure 3-2 below, right-click **LAN (Local Area Connection)** and choose **Properties**.

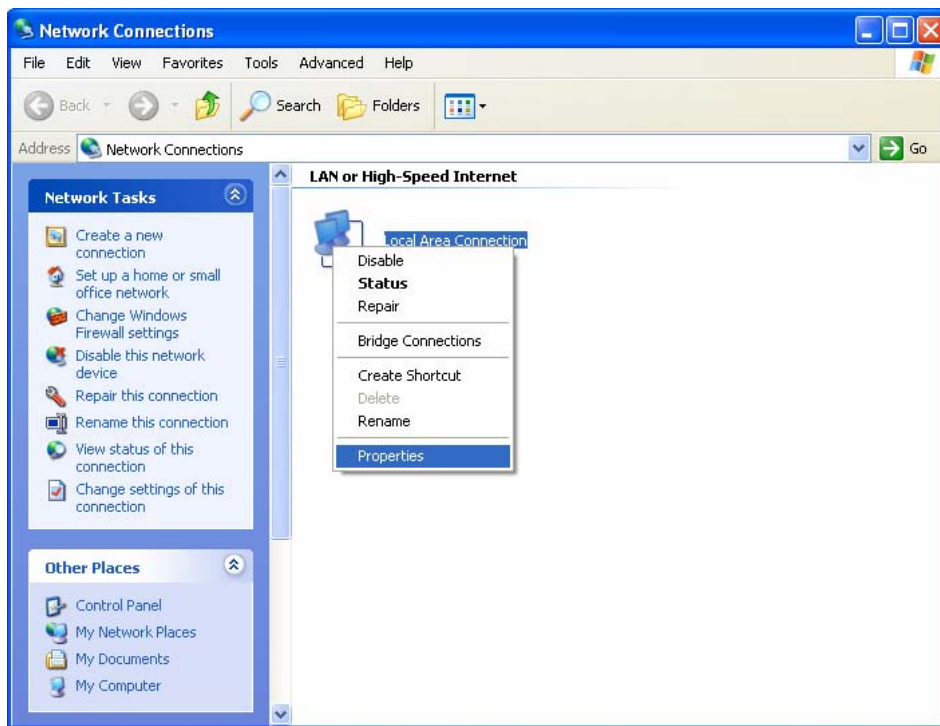

Figure 3-2

3. In the **General** tab of **Internet Protocol (TCP/IP) Properties** window, highlight **Internet Protocol (TCP/IP)** and click **Properties**.

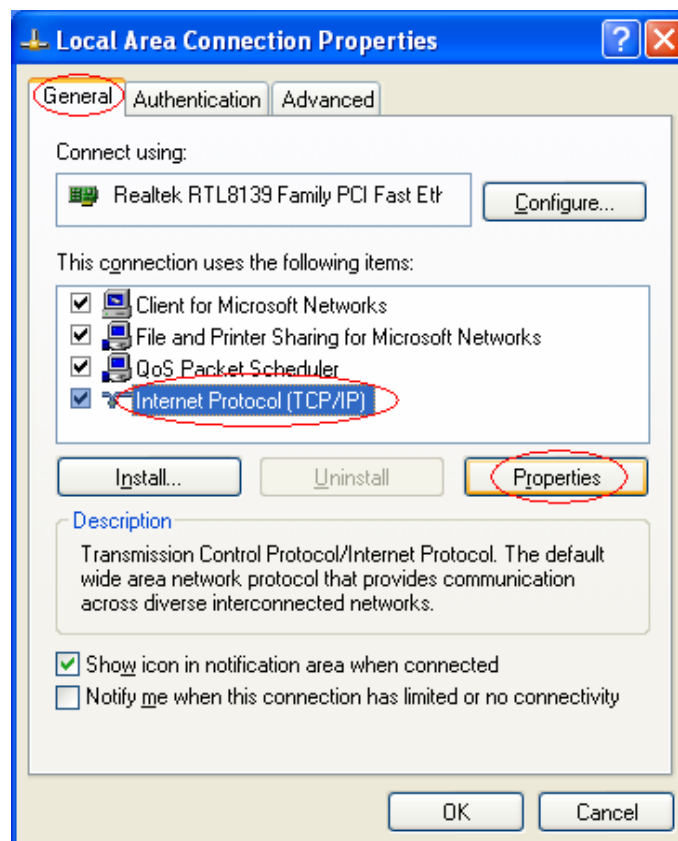

Figure 3-3

4. Configure the IP address manually.
 - 1) Select **Use the following IP address**.
 - 2) Enter 192.168.1.* (* is any integer between 1 to 253) into the **IP address** field, and

255.255.255.0 into the **Subnet mask** field.

- 3) Click **OK** to keep your settings.

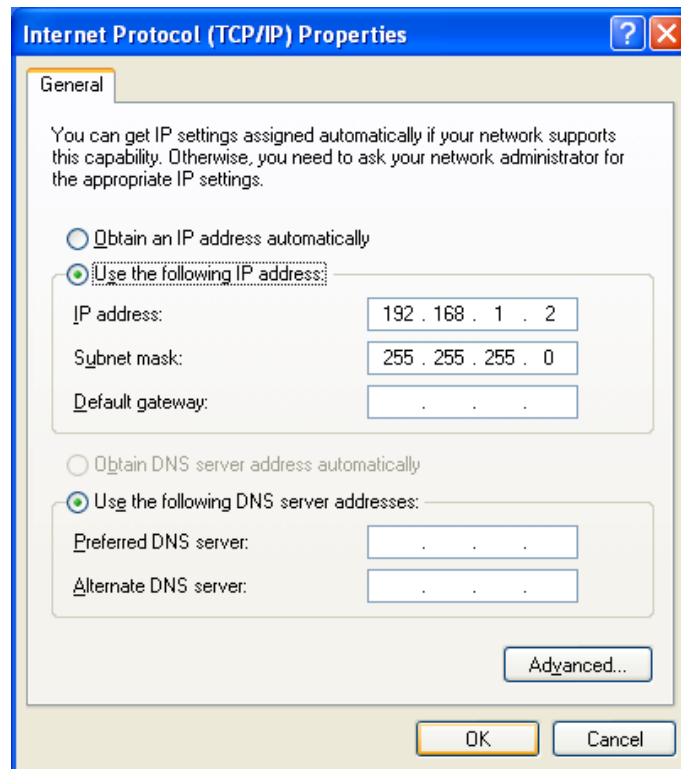

Figure 3-4

5. Verify the network connection between your PC and the AP via the *Ping* command. The following example is in Windows XP Operating System.

- 1) Click **Start > Run** tab. Enter **cmd** in the field and click **OK**.
- 2) Type *ping 192.168.1.254* on the screen that displays and then press **Enter**.

If the result displayed is similar to that shown in Figure 3-5 below, the connection between your PC and the AP has been successfully established.

```
Pinging 192.168.1.254 with 32 bytes of data:
Reply from 192.168.1.254: bytes=32 time=1ms TTL=64
Reply from 192.168.1.254: bytes=32 time<1ms TTL=64
Reply from 192.168.1.254: bytes=32 time<1ms TTL=64
Reply from 192.168.1.254: bytes=32 time<1ms TTL=64

Ping statistics for 192.168.1.254:
    Packets: Sent = 4, Received = 4, Lost = 0 (0% loss),
    Approximate round trip times in milli-seconds:
        Minimum = 0ms, Maximum = 1ms, Average = 0ms
```

Figure 3-5

If the result displayed is similar to that shown in Figure 3-6 below, it means that your PC has not connected to the AP.

```
Pinging 192.168.1.254 with 32 bytes of data: :
Request timed out.
Request timed out.
Request timed out.
Request timed out.
```

Figure 3-6

Please check following these steps:

- a) Check to see if your PC and the AP are right connected. The LED of LAN port which you link to on the device and the LED on your PC's adapter should be lit up.
- b) Make sure the TCP/IP for your PC is right configured. If the AP's IP address is 192.168.1.254, your PC's IP address must be within the range of 192.168.1.1 ~ 192.168.1.253.

Please check the connection following these steps:

1. Is the connection between your PC and the AP correct?

 **Note:**

The LED of LAN port you link to on the AP and LEDs on your PC's adapter should be lit.

2. Is the TCP/IP configuration for your PC correct?

 **Note:**

If the AP's IP address is 192.168.1.254, your PC's IP address must be within the range of 192.168.1.1 ~ 192.168.1.253.

3.2 Quick Setup

The following instructions will guide you through a few easy steps to configure your AP and connect to Internet. With a Web-based (Internet Explorer or Netscape® Navigator) utility, it is easy to configure and manage the TL-WA5110G 54Mbps High Power Wireless Access Point. The Web-based utility can be used on any Windows, Macintosh or UNIX OS with a Web browser.

Open your web browser and enter the IP address of the AP (192.168.1.254) and a login screen will display (shown in Figure 3-7).

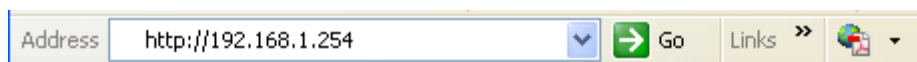

Figure 3-7 Login the router

Enter **admin** for Username and Password (both in lower case letters) on the following login screen. Click **OK** or press **Enter** of your keyboard, and the management page will display.

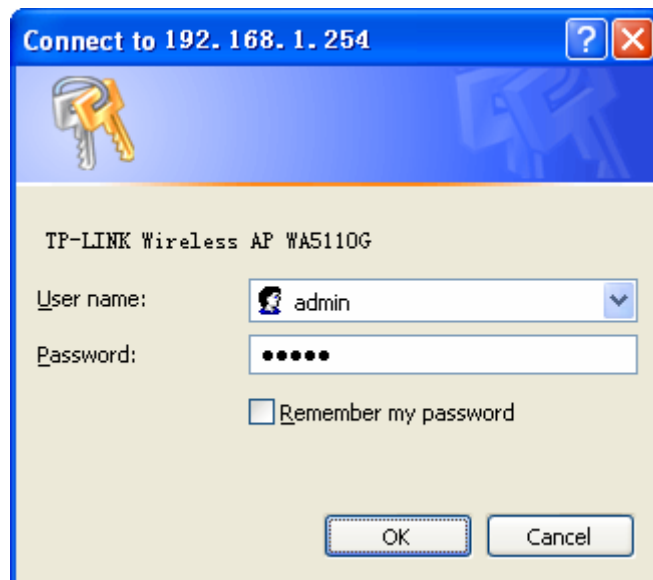

Figure 3-8 Login Windows

Note:

If the above screen does not pop-up, it means that your Web-browser has been set to a proxy. Go to **Tools menu>Internet Options>Connections>LAN Settings**, in the screen that appears, cancel the **Using Proxy** checkbox, and click **OK** to finish it.

If the User Name and Password are correct, you can configure the AP using the Web browser. Please click the **Quick Setup** link on the left of the main menu and the Quick Setup screen will appear.

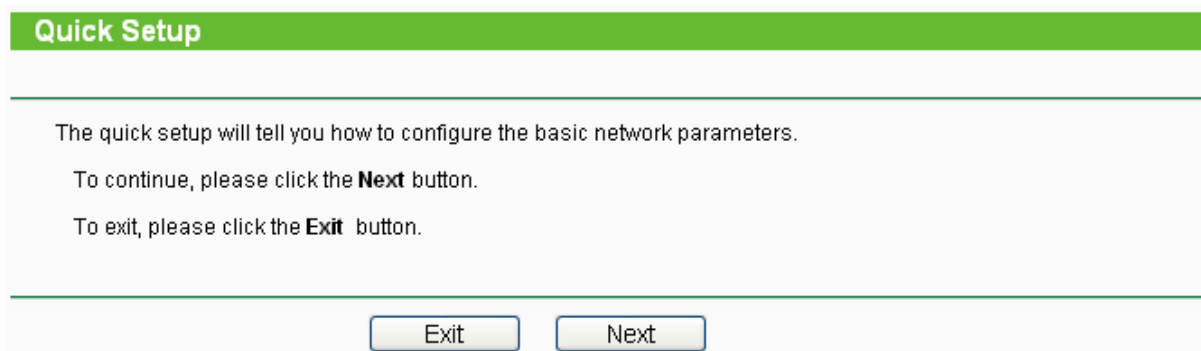

Figure 3-9 Quick Setup

Click **Next**, and then **Choose Operation mode** page will appear, shown in Figure 3-10:

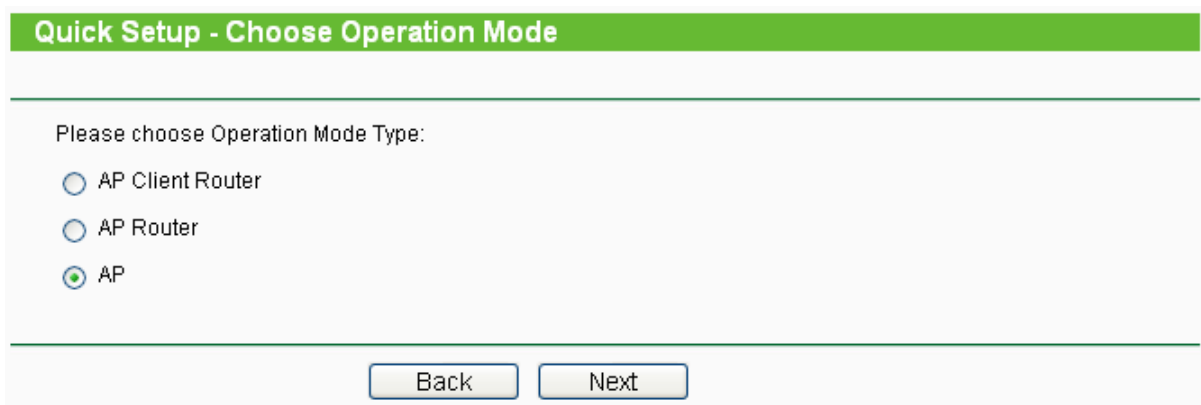

Figure 3-10 Choose Operation mode

 **Note:**

The AP supports three mode operation modes for multi-user to access the Internet: AP Client Router, AP Router and AP. In AP Client Router mode, it can access the Internet wirelessly by your WISP's support. In AP Router mode, it can access the Internet via ADSL/Cable Modem. In AP mode, it can access a wireless network by using WIFI. You can configure your device quickly by the following steps in different modes.

A. When you choose **AP Client Router** or **AP Router** mode, take the following steps:

1. click **Next** in Figure 3-10, and then **Choose WAN Connection Type** page will appear, shown in Figure 3-11:

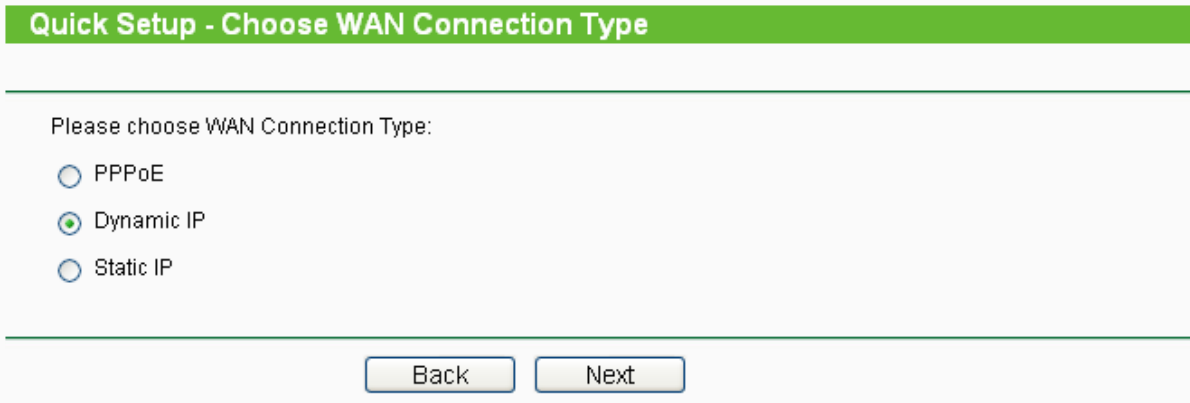

Quick Setup - Choose WAN Connection Type

Please choose WAN Connection Type:

PPPoE

Dynamic IP

Static IP

Figure 3-11 Choose WAN Connection Type

The AP in AP Client Router and AP Router mode supports three popular ways to connect to the Internet. Please select one compatible with your ISP.

2. Click **Next** in Figure 3-11 to enter the necessary network parameters.

- a) If you choose "**PPPoE**", you will see this page shown in Figure 3-12:

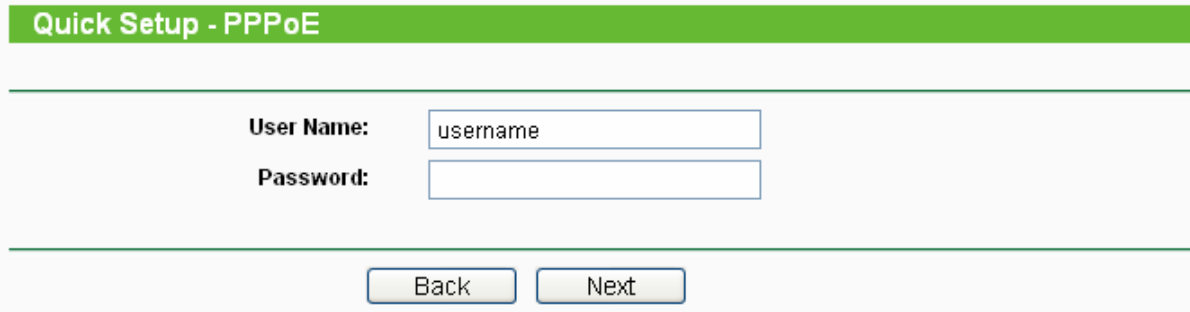

Quick Setup - PPPoE

User Name:

Password:

Figure 3-12 Quick Setup - PPPoE

- **Account Name** and **Password** - Enter the **Account Name** and **Password** provided by your ISP. These fields are case sensitive. If you have difficulty with this process, please contact your ISP.
- b) If you choose "**Dynamic IP**", the router will automatically receive the IP parameters from your ISP without needing to enter any parameters.
- c) If you Choose "**Static IP**", the Static IP settings page will appear, shown in Figure 3-13:

Figure 3-13 Quick Setup - Static IP

Note:

The IP parameters should have been provided by your ISP.

- **IP Address** - This is the WAN IP address as seen by external users on the Internet (including your ISP). Enter the IP address into the field.
 - **Subnet Mask** - The Subnet Mask is used for the WAN IP address, it is usually 255.255.255.0.
 - **Default Gateway** - Enter the gateway IP address into the box if required.
 - **Primary DNS** - Enter the DNS Server IP address into the boxes if required.
 - **Secondary DNS** - If your ISP provides another DNS server, enter it into this field.
3. After you complete the above, click **Next**, the Wireless settings page will appear below.

Figure 3-14 Quick Setup - Wireless settings

On this page, you can configure the following wireless parameters:

Note:

The **Quick Setup - Wireless** page differs in different modes. If you choose the AP Router mode, you will see the Wireless page as below.

Figure 3-15 Quick Setup - Wireless settings

- **SSID** - Enter a value of up to 32 characters. The same SSID must be assigned to all wireless devices on your network. The default SSID is TP-LINK_XXXXXX This value is case-sensitive. For example, *TEST* is NOT the same as *test*.
- **Region** - Specifies the region where the wireless function of the AP can be used. Select your region from the drop-down list. The default is United States. If your country or region is not listed, please contact your local government agency for assistance.

Note:

Restricted by local law regulations, version for North America does not have region selection option. The wireless basic settings for this version are shown below.

- **Channel** - The current channel in use. This field determines which operating frequency will be used.
- **Mode** - Indicates the current mode **54Mbps (802.11g)**, **11Mbps (802.11b)**. If you select **54Mbps (802.11g)**, it is compatible with **11Mbps (802.11b)**.

These settings are only for basic wireless parameters, for advanced settings, please refer to [Section 4.6: "Wireless"](#).

- B.** When you choose **AP mode** on **Quick Setup - Choose Operation Mode** page (shown as Figure 3-10), you will directly go to the Wireless page as Figure 3-15 above.

Click the **Next** button. You will then see the Finish page:

Figure 3-16 Quick Setup - Finish

After finishing all configurations of basic network parameters, please click **Finish** button to exit this **Quick Setup** and wait your device to reboot automatically. The changes of settings will take effect after rebooting.

Chapter 4 AP Client Router & AP Router Operation Mode

This Chapter describes how to configure some advanced settings for your Access Point through the web-based management page. In the following explanations, we will take the device in AP Client Router operation mode for example.

4.1 Login

After your successful login, you can configure and manage the Access Point. There are fourteen main menus on the left of the Web-based management page. Submenus will be available after you click one of the main menus. The thirteen main menus are: **Status**, **Quick Setup**, **Operation Mode**, **Network**, **Wireless**, **DHCP**, **Wireless Settings**, **Forwarding**, **Security**, **Static Routing**, **IP & MAC Binding**, **Dynamic DNS** and **System Tools**. On the right of the Web-based management page, there are the detailed explanations and instructions for the corresponding page. To apply any settings you have altered on the page, please click **Save**.

The detailed explanations for each Web page key's function are listed below.

4.2 Status

Selecting **Status** will enable you to view the AP's current status and configuration, all of which is read-only.

Status

Firmware Version: 4.4.2 Build 100408 Rel.54957n
Hardware Version: WA5110G v1 0815311C

LAN

MAC Address: 00-0A-EB-88-34-6E
IP Address: 192.168.1.254
Subnet Mask: 255.255.255.0

Wireless

Wireless Radio: Enable
Signal:
SSID: TP-LINK_88346E
Channel: 11
Mode: 11Mbps (802.11b)
MAC Address: 00-0A-EB-88-34-6F

WAN

MAC Address: 00-0A-EB-88-34-6F
IP Address: 0.0.0.0 Dynamic IP
Subnet Mask: 0.0.0.0
Default Gateway: 0.0.0.0 **Obtaining network parameters...**
DNS Server: 0.0.0.0 , 0.0.0.0

Traffic Statistics

	Received	Sent
Bytes:	0	0
Packets:	0	0

System Up Time: 0 day(s) 00:04:31

Figure 4-1 Status

1. LAN

This field displays the current settings or information for the LAN, including the **MAC address**, **IP address** and **Subnet Mask**.

2. Wireless

This field displays basic information or status for wireless function, including **Wireless Radio**,

SSID, Channel, Mode, and Wireless MAC address.

3. WAN

These parameters apply to the WAN port of the router, including **MAC address, IP address, Subnet Mask, Default Gateway** and **DNS server**. If PPPoE is chosen as the WAN connection type, the **Disconnect** button will be shown here while you are accessing the Internet. You can also cut the connection by clicking the button. If you have not connected to the Internet, just click **Connect** to establish the connection.

4. Traffic Statistics

This field displays the router's traffic statistics.

5. System Up Time

The total up time of the router since it was powered on or reset.

4.3 Quick Setup

Please refer to Section [3.2: "Quick Setup"](#).

4.4 Operation Mode

Selecting **Operation Mode** will allow you to choose the operation mode for the AP. The AP supports three operation mode types, **AP Client Router, AP Router** and **AP**. Please select the one you want as shown in Figure 4-2. Click **Save** to save your choice.

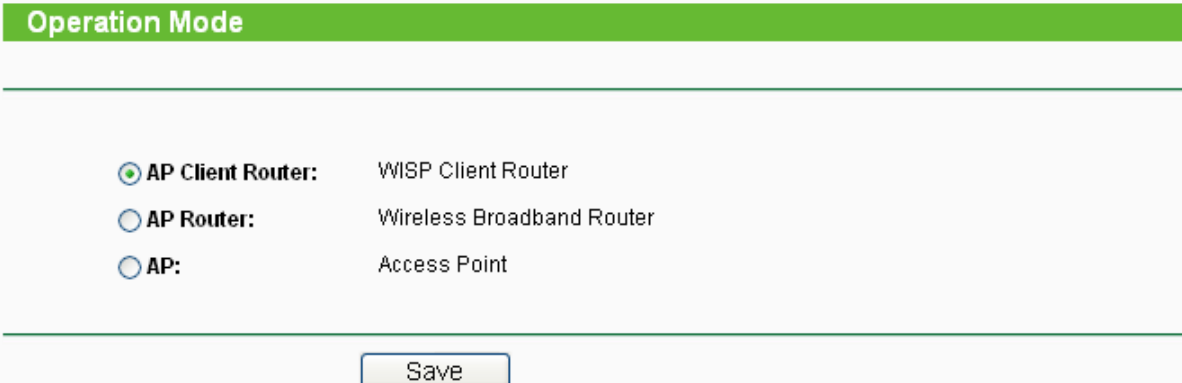

Operation Mode	
<input checked="" type="radio"/> AP Client Router:	WISP Client Router
<input type="radio"/> AP Router:	Wireless Broadband Router
<input type="radio"/> AP:	Access Point

Figure 4-2 Operation Mode

- **AP Client Router** - In this mode, the device enables multi-user to share the Internet from WISP. All LAN ports share the same IP from WISP through Wireless port. While connecting to WISP, the Wireless port works as a WAN port in AP Client mode. The Ethernet port acts as a LAN port.
- **AP Router** - In this mode, the device enables multi-user to share the Internet via ADSL/Cable Modem. The wireless port share the same IP to ISP through Ethernet WAN port. The Wireless port acts same as a LAN port while in AP mode.
- **AP** - In this mode, the device allows wireless communication devices to access a wireless network by using WIFI. The Ethernet port and the wireless port both work as LAN ports.

4.5 Network

The **Network** option allows you to customize your local network manually by changing the default settings of the AP.

There are three submenus under the Network menu (shown in Figure 4-3): **LAN, WAN** and **MAC**

Clone. Click any of them, and you will be able to configure the corresponding function. The detailed explanations for each submenu are provided below.

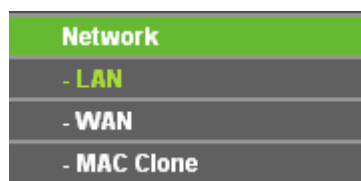

Figure 4-3 the Network menu

4.5.1 LAN

Selecting **Network > LAN** will enable you to configure the IP parameters of LAN port on this page.

A screenshot of the LAN configuration page. The page has a green header with the word "LAN" in white. Below the header, there are three rows of configuration fields. The first row is "MAC Address:" with the value "00-0A-EB-90-00-08". The second row is "IP Address:" with a text box containing "192.168.1.254". The third row is "Subnet Mask:" with a text box containing "255.255.255.0". At the bottom of the page, there is a "Save" button.

Figure 4-4 LAN

- **MAC Address** - The physical address of the router, as seen from the LAN. The value can't be changed.
- **IP Address** - Enter the IP address of your router in dotted-decimal notation (factory default: 192.168.1.254).
- **Subnet Mask** - An address code that determines the size of the network. Normally use 255.255.255.0 as the subnet mask.

Note:

- 1) If you change the IP Address of LAN, you must use the new IP Address to login the Router.
- 2) If the new LAN IP Address you set is not in the same subnet, the IP Address pool of the DHCP server will not take effect until they are re-configured.
- 3) If the new LAN IP Address you set is not in the same subnet, the Virtual Server and DMZ Host will change accordingly at the same time.

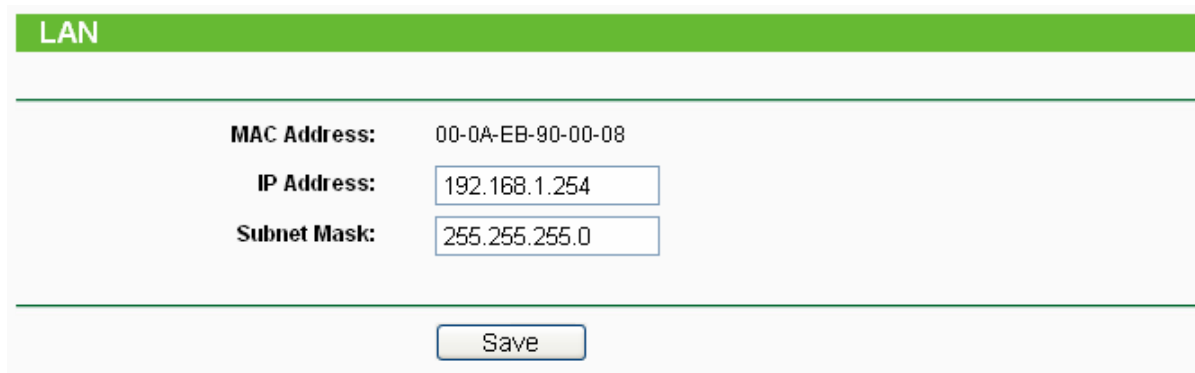
4.5.2 WAN

Selecting **Network > WAN** will enable you to configure the IP parameters of WAN port on this page.

First, please choose the WAN Connection Type (Dynamic IP/Static IP/PPPoE) for the Internet. The default type is **Dynamic IP**. If you aren't given any login parameters (fixed IP Address, logging ID, etc), please select **Dynamic IP**. If you are given a fixed IP (static IP), please select **Static IP**. If you are given a user name and a password, please select the type of your ISP provided (PPPoE). If you are not sure which connection type you use currently, please contact your ISP to obtain the correct information.

1. If you choose **Dynamic IP**, the router will automatically get IP parameters from your ISP. You can see the page as shown in Figure 4-5.

WAN Connection Type: Dynamic IP ▼

Host Name:

IP Address: 0.0.0.0

Subnet Mask: 0.0.0.0

Default Gateway: 0.0.0.0

Obtaining network parameters...

MTU Size (in bytes): (The default is 1500. Do not change it unless necessary.)

Use These DNS Servers

Primary DNS:

Secondary DNS: (Optional)

Get IP with Unicast DHCP (It is usually not required.)

Figure 4-5 WAN – Dynamic IP

This page displays the WAN IP parameters assigned dynamically by your ISP, including IP address, Subnet Mask, Default Gateway, etc. Click **Renew** to renew the IP parameters from your ISP. Click **Release** to release the IP parameters.

- **MTU Size** - The normal MTU (Maximum Transmission Unit) value for most Ethernet networks is 1500 Bytes. For some ISPs you need to reduce the MTU. But this is rarely required, and should not be done unless you are sure it is necessary for your ISP connection.

If your ISP gives you one or two DNS addresses, select **Use These DNS Servers** and enter the primary and secondary addresses into the correct fields. Otherwise, the DNS servers will be assigned dynamically from your ISP.

Note:

If you get address and find error when you go to a Web site, it is likely that your DNS servers are set up improperly. You should contact your ISP to get DNS server addresses.

- **Get IP with Unicast DHCP** - A few ISPs' DHCP servers do not support the broadcast applications. If you cannot get the IP Address normally, you can choose this option. (This is rarely required.)
2. If you choose **Static IP**, you should have fixed IP Parameters specified by your ISP. The Static IP settings page will appear as shown in Figure 4-6.

WAN Connection Type:	Static IP	
IP Address:	0.0.0.0	
Subnet Mask:	0.0.0.0	
Default Gateway:	0.0.0.0	(Optional)
MTU Size (in bytes):	1500	(The default is 1500. Do not change it unless necessary.)
Primary DNS:	0.0.0.0	(Optional)
Secondary DNS:	0.0.0.0	(Optional)

Figure 4-6 WAN - Static IP

You should type the following parameters into the spaces provided:

- **IP Address** - Enter the IP address in dotted-decimal notation provided by your ISP.
 - **Subnet Mask** - Enter the subnet Mask in dotted-decimal notation provided by your ISP, usually is 255.255.255.0.
 - **Default Gateway** - (Optional) Enter the gateway IP address in dotted-decimal notation provided by your ISP.
 - **MTU Size** - The normal MTU (Maximum Transmission Unit) value for most Ethernet networks is 1500 Bytes. For some ISPs you may need to modify the MTU. But this is rarely required, and should not be done unless you are sure it is necessary for your ISP connection.
 - **Primary DNS** - (Optional) Enter the DNS address in dotted-decimal notation provided by your ISP.
 - **Secondary DNS** - (Optional) Type another DNS address in dotted-decimal notation provided by your ISP if provided.
3. If you choose **PPPoE**, you should enter the following parameters as shown in Figure 4-7.

WAN

WAN Connection Type: PPPoE ▼

User Name: username

Password: *****

WAN Connection Mode:

Connect on Demand
 Max Idle Time: 15 minutes (0 means remaining active all the time.)

Connect Automatically

Time-based Connecting
 Period of Time: from 0 : 0 (HH:MM) to 23 : 59 (HH:MM)

Connect Manually
 Max Idle Time: 15 minutes (0 means remaining active all the time.)

Connect
Disconnect
Disconnected

Save
Advanced

Figure 4-7 WAN - PPPoE

- **User Name/Password** - Enter the User Name and Password provided by your ISP. These fields are case-sensitive.
- **Connect on Demand** - You can configure the router to disconnect your Internet connection after a specified period of inactivity (**Max Idle Time**). If your Internet connection has been terminated due to inactivity, **Connect on Demand** enables the router to automatically re-establish your connection as soon as you attempt to access the Internet again. If you wish to activate **Connect on Demand**, click the radio button. If you want your Internet connection to remain active at all times, enter 0 in the **Max Idle Time** field. Otherwise, enter the number of minutes you want to have elapsed before your Internet connection terminates.

Caution: Sometimes the connection cannot be disconnected although you specify a time to Max Idle Time, since some applications is visiting the Internet continually in the background.

- **Connect Automatically** - Connect automatically after the router is disconnected. To use this option, click the radio button.
- **Time-based Connecting** - You can configure the router to make it connect or disconnect based on time. Enter the start time in HH:MM format for connecting and end time in HH:MM format for disconnecting in the **Period of Time** fields.

Note:

Only when you have configured the system time on **System Tools -> Time** page, will the **Time-based Connecting** function can take effect.

- **Connect Manually** - You can configure the router to make it connect or disconnect manually. After a specified period of inactivity (**Max Idle Time**), the router will disconnect from the Internet connection, and you will not be able to re-establish your connection automatically as soon as you attempt to access the Internet again. To use this option, click the radio button. If you want your Internet connection to remain active at all times, enter "0" in the **Max Idle Time**

field. Otherwise, enter the number time in minutes that you wish to have the Internet connecting last unless a new link is requested.

Caution: Sometimes the connection cannot be disconnected although you specify a time to Max Idle Time, since some applications are visiting the Internet continually in the background.

Click the **Connect** button to connect immediately, Click the **Disconnect** button to disconnect immediately.

Click the **Advanced Settings** button to set up the advanced option, the page shown in Figure 4-8 will then appear.

MTU Size (in bytes): (The default is 1480, do not change unless necessary.)

Service Name:

AC Name:

Use IP address specified by ISP

ISP Specified IP Address:

Detect Online Interval: Seconds (0 ~ 120 seconds, the default is 0, 0 means not detecting.)

Use the following DNS Servers

Primary DNS:

Secondary DNS: (Optional)

Figure 4-8 PPPoE Advanced Settings

- **Packet MTU** - The default MTU size is 1480 bytes, which value is usually fine. For some ISPs, you need modify the MTU. This should not be done unless you are sure it is necessary for your ISP.
- **Service Name/AC Name** - The service name and AC (Access Concentrator) name, these should not be configured unless you are sure it is necessary for your ISP.
- **ISP Specified IP Address** - If you know that your ISP does not automatically transmit your IP address to the router during login, click “**Use the IP Address specified by ISP**” check box and enter the IP Address in dotted-decimal notation, which your ISP provided.
- **Detect Online Interval** - The default value is 0, you can input the value between 0 and 120. The router will detect Access Concentrator online at every interval between seconds. If the value is 0, it means, do not detect.
- **DNS IP address** - If you know that your ISP does not automatically transmit DNS addresses to the router during login, click “**Use the following DNS servers**” checkbox and enter the IP address in dotted-decimal notation of your ISP’s primary DNS server. If a secondary DNS server address is available, enter it as well.

Click the **Save** button to save your settings.

4.5.3 MAC Clone

MAC Clone allows you to clone the MAC address of the managing PC's adapter to the WAN port. This is because some ISPs require that you register the MAC address of your adapter. Usually, you do not need to change anything here.

Selecting **Network > MAC Clone** will enable you to configure the MAC address of the WAN port on this page as shown in Figure 4-9.

MAC Clone	
WAN MAC Address:	<input type="text" value="00-0A-EB-88-34-6F"/> <input type="button" value="Restore Factory MAC"/>
Your PC's MAC Address:	<input type="text" value="00-19-66-CB-45-66"/> <input type="button" value="Clone MAC Address To"/>
<input type="button" value="Save"/>	

Figure 4-9 MAC Address Clone

Some ISPs require that you register the MAC Address of your adapter, which is connected to your cable/DSL Modem or Ethernet during installation. Changes are rarely needed here.

- **WAN MAC Address** - This field displays the current MAC address of the WAN port, which is used for the WAN port. If your ISP requires that you register the MAC address, please enter the correct MAC address into this field. The format for the MAC Address is XX-XX-XX-XX-XX-XX (X is any hexadecimal digit).
- **Your PC's MAC Address** - This field displays the MAC address of the PC that is managing the router. If the MAC address is required, you can click the **Clone MAC Address To** button and this MAC address will fill in the **WAN MAC Address** field.

Click **Restore Factory MAC** to restore the MAC address of WAN port to the factory default value.

Click **Save** to save your settings.

Note:

- 1) Only the PC on your LAN can use the **Clone MAC Address To** feature.
- 2) If you click **Save**, the Router will prompt you to reboot.

4.6 Wireless

The **Wireless** option, improving functionality and performance for wireless network, can help you to make the AP an ideal solution for your wireless network.

Here you can create a wireless local area network just through a few settings. Basic Settings is used for the configuration of some basic parameters of the AP. Wireless Mode allows you to select the mode that AP works on. Security Settings provides three different security types to secure your data and thus provide greater security for your wireless network. MAC filtering allows you to control the access of wireless stations to the AP. Wireless Statistics shows you the statistics of current connected Wireless stations. Distance Setting is used to adjust the wireless range in outdoor conditions. Antenna Alignment shows how remote AP's signal strength changes while changing the antenna's direction. Throughput Monitor helps to watch wireless throughput information. Wireless statistics enables you to get detailed information about the current connected wireless stations.

There are eight submenus under the Wireless menu (shown in Figure 4-10): **Basic Settings**,

Wireless Mode, Security Settings, MAC Filtering, Wireless Statistics, Distance Setting, Antenna Alignment and Throughput Monitor. Click any of them, and you will be able to configure the corresponding function. The detailed explanations for each submenu are provided below.

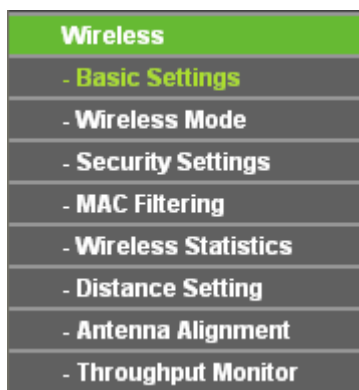

Figure 4-10 Wireless menu

4.6.1 Basic Settings

Selecting **Wireless > Basic Settings** will enable you to configure the basic settings for your wireless network on the screen below (Figure 4-11).

 The "Wireless Settings" page features a green header. Below it, there are several configuration fields:

- SSID:** A text input field containing "TP-LINK_88346E".
- Region:** A dropdown menu showing "United States".
- Warning:** A text block stating "Ensure you select a correct country to conform local law. Incorrect settings may cause interference."
- Channel:** A dropdown menu showing "Automatic".
- Power:** A dropdown menu showing "26dBm Max" and a checked checkbox labeled "Enable High Power Mode".
- Mode:** A dropdown menu showing "54Mbps (802.11g)".

 At the bottom of the form is a "Save" button.

Figure 4-11 Wireless Settings in AP Client Router mode

- **SSID** - Enter a string of up to 32 characters. The same Name (SSID) must be assigned to all wireless devices in your network. The default SSID is set to be TP-LINK_XXXXXX (XXXXXX indicates the last unique six characters of each device's MAC address), which can ensure your wireless network security. But it is strongly recommended that you change your networks name (SSID) to a different value. This value is case-sensitive. For example, *TEST* is NOT the same as *test*.
- **Region** - Select your region from the pull-down list. This field specifies the region where the wireless function of the device can be used. It may be illegal to use the wireless function of the device in a region other than one of those specified in this field. If your country or region is not listed, please contact your local government agency for assistance.

 **Note:**

- 1) The default region is United States. When you select your local region from the pull-down list, the dialog shown in Figure below appears. Click **OK**.
- 2) Restricted by local law regulations, version for North America does not have region selection option.

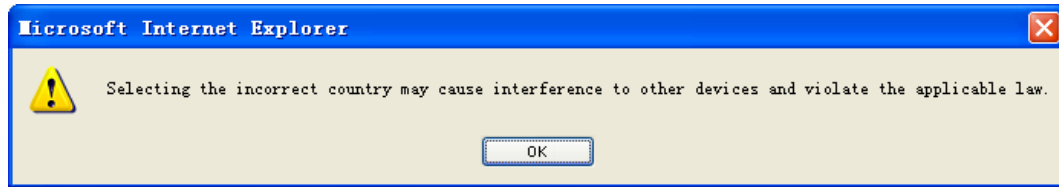

Note Dialog

- **Channel** - Determines the operating frequency to be used. It is not necessary to change the wireless channel unless you notice interference problems with another nearby access point.
- **Power** - The transmit power of the access point. The checkbox determines whether transmit power uses high power or not. Checking the **Enable High Power Mode** option will help improving the wireless performance, but may cause interference to other devices and violate the applicable law in some areas. It's not recommended that you enable high power mode in areas that applicable law will be violated.
- **Mode** - Select the desired wireless mode. The options are:
 - **54Mbps (802.11g)** - Both 802.11g and 802.11b wireless stations can connect to the router.
 - **11Mbps (802.11b)** - Only 802.11b wireless stations can connect to the router.
- **Region** - Specifies the region where the wireless function of the AP can be used. Select your region from the drop-down list. If your country or region is not listed, please contact your local government agency for assistance.

Be sure to click the **Save** button to save your settings on this page.

 **Note:**

The device will reboot automatically after you click the **Save** button.

4.6.2 Wireless Mode

Selecting **Wireless > Wireless Mode** will enable you to configure the wireless mode for your device on the page as shown in Figure 4-12.

Wireless Mode Settings

Access Point

Enable SSID Broadcast

Client

SSID:

MAC of AP:

Repeater

MAC of AP:

Universal Repeater

MAC of AP:

Bridge (Point to Point)

With AP Mode

MAC of AP:

Bridge (Point to Multi-Point)

With AP Mode

MAC of AP1:

MAC of AP2:

MAC of AP3:

MAC of AP4:

MAC of AP5:

MAC of AP6:

Survey

Save

Note: The current security method may be invalid after changing the wireless mode.

Figure 4-12 Wireless Mode

Note:

In AP Client Router, there is only Client mode available shown as Figure 4-12 while in AP Router there is only Access Point mode available.

- **Access Point** - Access Point mode allows wireless stations including AP clients to access the router.

- **Enable SSID Broadcast** - If you select the **Enable SSID Broadcast** checkbox, the Wireless AP will broadcast its name (SSID) on the air.
- **Client** - In **Client** mode, AP will act as a wireless station to enable wired host(s) to access wireless AP.
- **SSID** - Enter the SSID of AP that you want to access. If you select the radio before **SSID**, the AP client will connect to AP according SSID.
 - **MAC of AP** - Enter the MAC address of AP that you want to access. If you select the radio before **MAC of AP**, the AP client will connect to AP according MAC address.

 **Note:**

To apply any settings you have altered on the page, please click the **Save** button, and wait the AP reboot automatically.

Click **Survey** will show the site list of scanning result shown as Figure 4-13 and you can choose one to connect to.

AP List						
AP Count: 5						
ID	BSSID	SSID	Signal	Channel	Security	Choose
1	00-24-17-84-A1-05	Thomson9AFD48	5 dB	11	OFF	Connect
2	94-0C-6D-2F-52-7C	TP-LINK_2F527C	26 dB	2	OFF	Connect
3	00-1D-0F-01-06-18	TP-LINK_010618	7 dB	4	OFF	Connect
4	00-19-E0-94-51-F4	TP-LINK	10 dB	1	ON	Connect
5	00-27-19-C4-B9-84		26 dB	4	ON	Connect

Figure 4-13 AP List

- **BSSID** - The BSSID of the AP, usually also the MAC address of the AP.
- **SSID** - The SSID of the AP.
- **Signal** - The signal received from the AP.
- **Channel** - The channel the AP works in.
- **Security** - The AP communicates in privacy.
- **Choose** - Choose one AP from list to connect to.

If you click the **Connect**, the values you selected will be filled in the **SSID** and **MAC of AP** fields on Figure 4-12.

 **Note:**

If you want to configure other wireless mode settings, you can change your AP to AP operation mode on **Operation Mode** page as shown in Figure 4-2.

4.6.3 Security Settings

Selecting **Wireless > Security Settings** will enable you to configure the security of the wireless network for your device on the page as shown in Figure 4-14.

Disable Security

WEP

Type: Automatic

WEP Key Format: Hexadecimal

Key Selected	WEP Key	Key Type
Key 1: <input type="radio"/>	<input type="text"/>	Disabled
Key 2: <input type="radio"/>	<input type="text"/>	Disabled
Key 3: <input type="radio"/>	<input type="text"/>	Disabled
Key 4: <input type="radio"/>	<input type="text"/>	Disabled

WPA/WPA2

Version: Automatic

Encryption: Automatic

Radius Server IP:

Radius Port: 1812 (1-65535, 0 stands for default port 1812)

Radius Password:

Group Key Update Period: 86400 (in second, minimum is 30, 0 means no update)

WPA-PSK/WPA2-PSK

Version: Automatic

Encryption: Automatic

PSK Passphrase:
(The Passphrase is between 8 and 63 characters long)

Group Key Update Period: 86400 (in second, minimum is 30, 0 means no update, only be valid in AP mode.)

Note: Some security mode can not be selected since it can not be supported by the current wireless mode.

Figure 4-14 Wireless Security

- **Disable Security** - The wireless security function can be enabled or disabled. If disabled, the wireless stations will be able to connect the device without encryption. It is recommended strongly that you choose one of following options to enable security.
- **WEP** - Select 802.11 WEP security.
 - **Type** - You can select one of following types,
 - 1) **Automatic** - Select **Shared Key** or **Open System** authentication type automatically based on the wireless station's capability and request.
 - 2) **Shared Key** - Select 802.11 Shared Key authentication.
 - 3) **Open System** - Select 802.11 Open System authentication.
 - **WEP Key Format** - You can select **ASCII** or **Hexadecimal** format. ASCII format stands for any combination of keyboard characters in the specified length. Hexadecimal format

stands for any combination of hexadecimal digits (0-9, a-f, A-F) in the specified length.

- **WEP Key** - Select which of the four keys will be used and enter the matching WEP key information for your network in the selected key radio button. These values must be identical on all wireless stations in your network.
- **Key Type** - You can select the WEP key length (**64-bit**, or **128-bit**, or **152-bit**.) for encryption. "Disabled" means this WEP key entry is invalid.
 - 1) For **64-bit** encryption - You can enter 10 hexadecimal digits (any combination of 0-9, a-f, A-F, zero key is not permitted) or 5 ASCII characters.
 - 2) For **128-bit** encryption - You can enter 26 hexadecimal digits (any combination of 0-9, a-f, A-F, zero key is not permitted) or 13 ASCII characters.
 - 3) For **152-bit** encryption - You can enter 32 hexadecimal digits (any combination of 0-9, a-f, A-F, zero key is not permitted) or 16 ASCII characters.

 **Note:**

If you do not set the key, the wireless security function is still disabled even if you have selected Shared Key as Authentication Type.

- **WPA/WPA2** - Select WPA/WPA2 based on Radius Server.
 - **Version** - You can select one of following versions,
 - 1) **Automatic** - Select **WPA** or **WPA2** automatically based on the wireless station's capability and request.
 - 2) **WPA** - Wi-Fi Protected Access.
 - 3) **WPA2** - WPA version 2.
 - **Encryption** - You can select either **Automatic**, or **TKIP** or **AES**.
 - **Radius Server IP** - Enter the IP address of the Radius Server.
 - **Radius Port** - Enter the port that radius service used.
 - **Radius Password** - Enter the password for the Radius Server.
 - **Group Key Update Period** - Specify the group key update interval in seconds. The value can be either 0 or at least 30. Enter 0 to disable the update.
- **WPA-PSK/ WPA2-PSK** - Select WPA based on pre-shared passphrase.
 - **Version** - You can select one of following versions,
 - 1) **Automatic** - Select **WPA-PSK** or **WPA2-PSK** automatically based on the wireless station's capability and request.
 - 2) **WPA-PSK** - Pre-shared key of WPA.
 - 3) **WPA2-PSK** - Pre-shared key of WPA2.
 - **Encryption** - When you select **WPA-PSK** or **WPA2-PSK** for **Authentication Type** you can select either **Automatic**, or **TKIP** or **AES** as **Encryption**.
 - **PSK Passphrase** - You can enter a passphrase between 8 and 63 characters long.
 - **Group Key Update Period** - Specify the group key update interval in seconds. The value can be either 0 or at least 30. Enter 0 to disable the update.

Be sure to click the **Save** button to save your settings on this page.

Note:

The device will reboot automatically after you click the **Save** button.

4.6.4 MAC Filtering

Selecting **Wireless > MAC Filtering** will allow you to set up some filtering rules to control wireless stations accessing the device, which depend on the station's MAC address on the following screen as shown Figure 4-15.

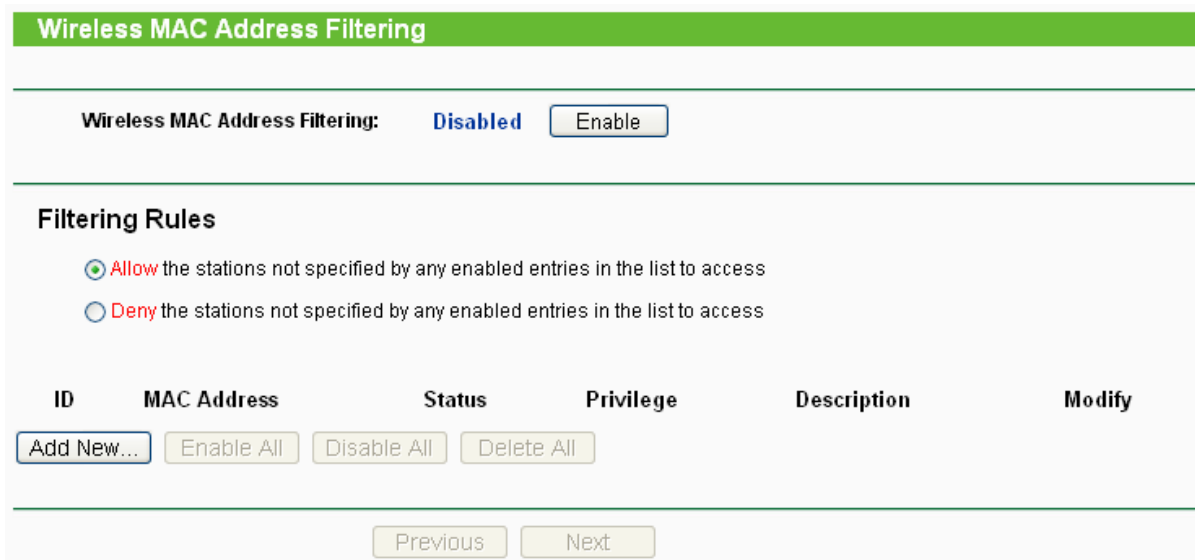

Figure 4-15 Wireless MAC address Filtering

The Wireless MAC Address Filtering feature allows you to control wireless stations accessing the AP, which depend on the station's MAC addresses.

- **MAC Address** - The wireless station's MAC address that you want to access.
- **Status** - The status of this entry either **Enabled** or **Disabled**.
- **Privilege** - Select the privileges for this entry. You may select one of the following **Allow / Deny**.
- **Description** - A simple description of the wireless station.

To set up an entry, follow these instructions:

First, you must decide whether the unspecified wireless stations can access the router or not. If you desire that the unspecified wireless stations can access the router, please select the radio button **Allow the stations not specified by any enabled entries in the list to access**, otherwise, select the radio button **Deny the stations not specified by any enabled entries in the list to access**.

To Add a Wireless MAC Address filtering entry, click the **Add New...** button. The "**Add or Modify Wireless MAC Address Filtering entry**" page will appear, shown in Figure 4-16.

Add or Modify Wireless MAC Address Filtering entry

MAC Address:	<input type="text"/>
Description:	<input type="text"/>
Privilege:	<input type="text" value="allow"/>
Status:	<input type="text" value="Enabled"/>

Figure 4-16 Add or Modify Wireless MAC Address Filtering entry

To add or modify a MAC Address Filtering entry, follow these instructions:

1. Enter the appropriate MAC Address into the **MAC Address** field. The format of the MAC Address is XX-XX-XX-XX-XX-XX (X is any hexadecimal digit). For example: 00-0A-EB-B0-00-0B.
2. Enter a simple description of the wireless station in the **Description** field. For example: Wireless station A.
3. **Privilege** - Select the privileges for this entry, one of **Allow** / **Deny**.
4. **Status** - Select **Enabled** or **Disabled** for this entry on the **Status** pull-down list.
5. Click the **Save** button to save this entry.

To add additional entries, repeat steps 1-5.

To modify or delete an existing entry:

1. Click the **Modify** in the entry you want to modify. If you want to delete the entry, click the **Delete**.
2. Modify the information.
3. Click the **Save** button.

Click the **Enable All** button to make all entries enabled.

Click the **Disabled All** button to make all entries disabled.

Click the **Delete All** button to delete all entries.

Click the **Next** button to go to the next page and click the **Previous** button to return to the previous page.

For example: If you desire that the wireless station A with MAC address 00-0A-EB-00-07-BE be able to access the router. The wireless station B with MAC address 00-0A-EB-00-07-5F not be able to access the router, while all other wireless stations cannot access the router, you should configure the **Wireless MAC Address Filtering** list by following these steps:

1. Click the **Enable** button to enable this function.
2. Select the radio button: **Deny the stations not specified by any enabled entries in the list to access for Filtering Rules**.
3. Delete all or disable all entries if there are any entries already.
4. Click the **Add New...** button and enter the MAC address 00-0A-EB-00-07-BE in the **MAC Address** field, enter wireless station A in the **Description** field, select **Allow** in the **Privilege** pull-down list and select **Enabled** in the **Status** pull-down list. Click the **Save** and the **Return** button.

- Click the **Add New...** button and enter the MAC address 00-0A-EB-00-07-5F in the **MAC Address** field, enter wireless station B in the **Description** field, select **Deny** in the **Privilege** pull-down list and select **Enabled** in the **Status** pull-down list. Click the **Save** and the **Return** button.

The filtering rules that configured should be similar to the following list:

ID	MAC Address	Status	Privilege	Description	Modify
1	00-0A-EB-00-07-BE	Enabled	allow	Wireless Station B	Modify Delete
2	00-0A-EB-00-07-5F	Enabled	deny	Wireless Station B	Modify Delete

Note:

- If you select the radio button **Allow the stations not specified by any enabled entries in the list to access** for **Filtering Rules**, the wireless station B will still not be able to access the router, however, other wireless stations that are not in the list will be able to access the router.
- If you enable the function and select the **Deny the stations not specified by any enabled entries in the list to access** for **Filtering Rules**, and there are not any enable entries in the list, thus, no wireless stations can access the router.

4.6.5 Wireless Statistics

Selecting **Wireless > Wireless Statistics** will allow you to see the wireless transmission information in the following screen shown in Figure 4-17.

Wireless Statistics				
Current Connected Wireless Stations numbers:		1	<input type="button" value="Refresh"/>	
ID	MAC Address	Current Status	Received Packets	Sent Packets
1	00-0A-EB-90-00-09	AP-DOWN	0	32088
		<input type="button" value="Previous"/>	<input type="button" value="Next"/>	

Figure 4-17 The router attached wireless stations

- **MAC Address** - The connected wireless station's MAC address
- **Current Status** - The connected wireless station's running status, one of STA-AUTH / STA-ASSOC / AP-UP / WPA / WPA-PSK /WPA2/WPA2-PSK
- **Received Packets** - Packets received by the station
- **Sent Packets** - Packets sent by the station

You cannot change any of the values on this page. To update this page and to show the current connected wireless stations, click on the **Refresh** button.

If the numbers of connected wireless stations go beyond one page, click the **Next** button to go to the next page and click the **Previous** button to return the previous page.

Note:

This page will be refreshed automatically every 5 seconds.

4.6.6 Distance Setting

Selecting **Wireless > Distance Setting** will allow you to adjust the wireless range in outdoor

conditions as shown in Figure 4-18. This is a critical feature required for stabilizing outdoor links. Enter the distance of your wireless link and the software will optimize the frame ACK timeout value automatically.

Distance Setting

Adjust option: Automatic

Distance: (0-52.6km)

Note: Specify the distance value in kilometers, accurate to the first decimal place. If the distance is set too short or too long, it will result in poor connection and throughput performance, it is best to set the value at 110% of the real distance. If the AP is being used in an indoor setting, please select the indoor option.

Save

Figure 4-18 Distance Setting

- **Adjust option** - Keep the default setting if the AP is used for outdoor environment. Or you can change the distance manually.
- **Distance:** Specify the distance value in kilometers, accurate to the first decimal place. If the distance is set too short or too long, it will result poor connection and throughput performance, it is best to set the value at 110% of the real distance. If the AP is being used in an indoor setting, please use the indoor option.

Click **Save** to keep your settings.

4.6.7 Antenna Alignment

Selecting **Wireless > Antenna Alignment** will allow you to view how remote AP's signal strength changes while changing the antenna's direction.

Antenna Alignment

Remote RSSI: 16 dB

Signal Percent: 53%

RSSI RANGE: 30

Figure 4-19 Antenna Alignment

- **Remote AP RSSI** - Remote AP's signal strength value.
- **Signal percent** - The ratio of RSSI to RSSI RANGE in percentage.
- **RSSI RANGE** - You can drag the slider bar to set or input the RSSI RANGE value. The slider bar allows the range of the meter to be either increased or reduced. If the range is reduced, the color change will be more sensitive to signal fluctuations. The slider bar actually changes an offset of the maximum indicator value scale.

Note:

It only works after you have established connection to remote AP under client mode.

4.6.8 Throughput Monitor

Selecting **Wireless > Throughput Monitor** will help to watch wireless throughput information in the following screen shown in Figure 4-20.

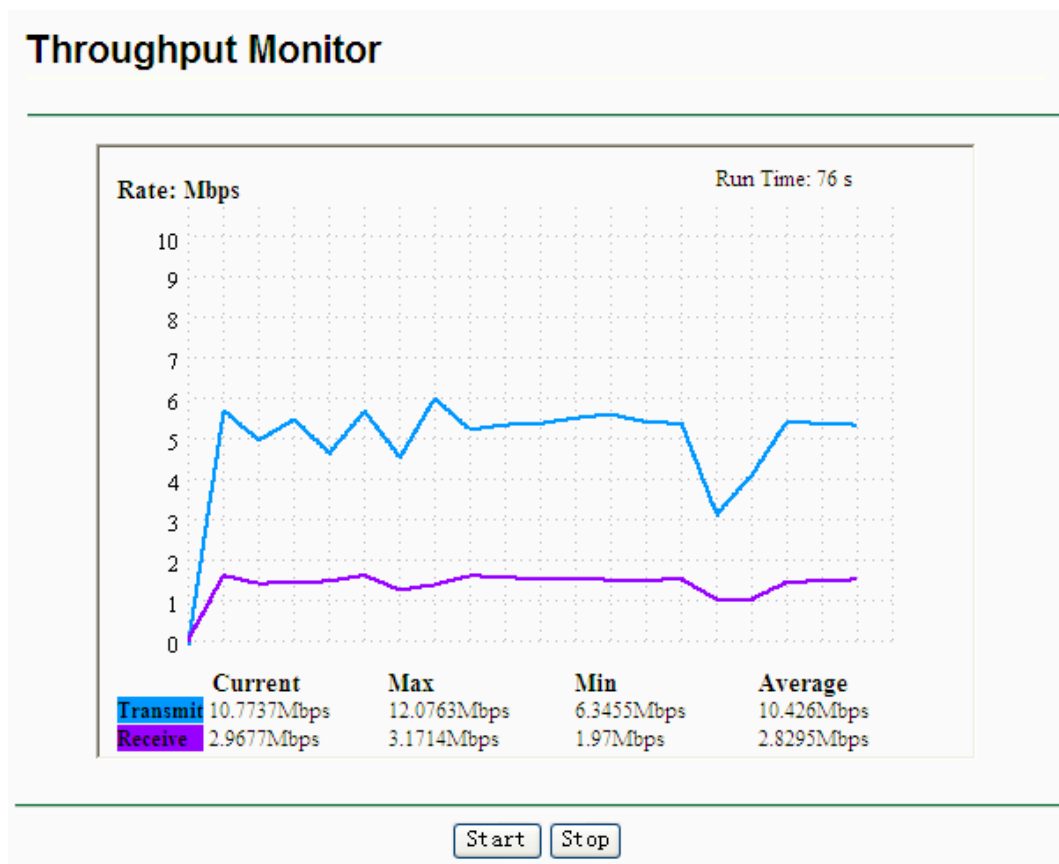

Figure 4-20 Wireless Throughput

- **Rate** - The Throughput unit.
- **Run Time** - How long this function is running.
- **Transmit**- Wireless transmit rate information.
- **Receive**- Wireless receive rate information.

Click the **Start** button to start wireless throughput monitor.

Click the **Stop** button to stop wireless throughput monitor.

4.7 DHCP

DHCP stands for Dynamic Host Configuration Protocol. The DHCP Server will automatically assign dynamic IP addresses to the computers on the network. This protocol simplifies network management and allows new wireless devices to receive IP addresses automatically without the need to manually assign new IP addresses.

There are three submenus under the DHCP menu (shown as Figure 4-21): **DHCP Settings**, **DHCP Clients List** and **Address Reservation**. Clicking any of them will enable you to configure the corresponding function. The detailed explanations for each submenu are provided below.

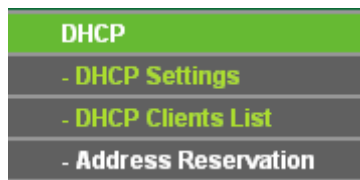

Figure 4-21 The DHCP menu

4.7.1 DHCP Settings

Selecting **DHCP > DHCP Settings** will enable you to set up the AP as a DHCP (Dynamic Host Configuration Protocol) server, which provides the TCP/IP configuration for all the PCs that are connected to the system on the LAN. The DHCP Server can be configured on the page (shown as Figure 4-22).

 A screenshot of the 'DHCP Settings' configuration page. The page has a green header with the text 'DHCP Settings'. Below the header, there are several configuration fields:

- DHCP Server:** Two radio buttons, 'Disable' and 'Enable'. The 'Enable' button is selected.
- Start IP Address:** A text input field containing '192.168.1.100'.
- End IP Address:** A text input field containing '192.168.1.199'.
- Address Lease Time:** A text input field containing '120' followed by the text 'minutes (1~2880 minutes, the default value is 120)'.
- Default Gateway:** A text input field containing '0.0.0.0' followed by '(optional)'.
- Default Domain:** An empty text input field followed by '(optional)'.
- Primary DNS:** A text input field containing '0.0.0.0' followed by '(optional)'.
- Secondary DNS:** A text input field containing '0.0.0.0' followed by '(optional)'.

 At the bottom of the form, there is a 'Save' button.

Figure 4-22 DHCP Settings

- **DHCP Server** - Selecting the radio button before **Disable/Enable** will disable/enable the DHCP server on your AP. The default setting is **Enable**. If you disable the Server, you must have another DHCP server within your network or else you must manually configure the computer.
- **Start IP Address** - This field specifies the first address in the IP Address pool. 192.168.1.100 is the default start IP address.
- **End IP Address** - This field specifies the last address in the IP Address pool. 192.168.1.199 is the default end IP address.
- **Address Lease Time** - Enter the amount of time for the PC to connect to the AP with its current assigned dynamic IP address. The time is measured in minutes. After the time is up, the PC will be automatically assigned a new dynamic IP address. The range of the time is 1 ~ 2880 minutes. The default value is 120 minutes.
- **Default Gateway (optional)** - Enter the IP address of the gateway for your LAN. The factory default setting is 0.0.0.0.
- **Default Domain (optional)** - Enter the domain name of your DHCP server. You can leave the field blank.

- **Primary DNS (optional)** - Enter the DNS IP address provided by your ISP. Consult your ISP if you don't know the DNS value. The factory default setting is 0.0.0.0.
- **Secondary DNS (optional)** - Enter the IP address of another DNS server if your ISP provides two DNS servers. The factory default setting is 0.0.0.0.

Click **Save** to save the changes.

 **Note:**

To use the DHCP server function of the device, you should configure all computers in the LAN as "Obtain an IP Address automatically" mode. This function will not take effect until the device reboots.

4.7.2 DHCP Clients List

Selecting **DHCP > DHCP Clients List** will enable you to view the Client Name, MAC Address, Assigned IP and Lease Time for each DHCP Client attached to the device (Figure 4-23).

DHCP Clients List				
ID	Client Name	MAC Address	Assigned IP	Lease Time
1	microsoft	00-19-66-CB-45-66	192.168.1.100	01:56:59

Figure 4-23 DHCP Clients List

- **ID** - Here displays the index of the DHCP client.
- **Client Name** - Here displays the name of the DHCP client.
- **MAC Address** - Here displays the MAC address of the DHCP client.
- **Assigned IP** - Here displays the IP address that the AP has allocated to the DHCP client.
- **Lease Time** - Here displays the time of the DHCP client leased. Before the time is up, DHCP client will request to renew the lease automatically.

You cannot change any of the values on this page. To update this page and to show the current attached devices, click on the **Refresh** button.

4.7.3 Address Reservation

Selecting **DHCP > Address Reservation** will enable you to specify a reserved IP address for a PC on the LAN, so the PC will always obtain the same IP address each time when it accesses the AP. Reserved IP addresses should be assigned to servers that require permanent IP settings. The screen below is used for address reservation (shown in Figure 4-24).

Address Reservation				
ID	MAC Address	Reserved IP Address	Status	Modify
<input type="button" value="Add New..."/> <input type="button" value="Enable All"/> <input type="button" value="Disable All"/> <input type="button" value="Delete All"/>				
<input type="button" value="Previous"/> <input type="button" value="Next"/>				

Figure 4-24 Address Reservation

- **MAC Address** - Here displays the MAC address of the PC for which you want to reserve an IP address.
- **Reserved IP Address** - Here displays the IP address that the AP is reserved.
- **Status** - Here shows whether the entry is enabled or not
- **Modify** - To modify or delete an existing entry.

To Reserve IP addresses:

1. Click the **Add New** button in the page of **Address Reservation**, the following page (Figure 4-25) will display.
2. Enter the MAC address (the format for the MAC Address is XX-XX-XX-XX-XX-XX) and IP address in dotted-decimal notation of the computer you want to add.
3. Click the **Save** button after finish configuring.

Add or Modify an Address Reservation Entry	
MAC Address:	<input type="text" value="00-0A-EB-00-07-5F"/>
Reserved IP Address:	<input type="text" value="192.168.1.23"/>
Status:	<input type="text" value="Enabled"/> ▼
<input type="button" value="Save"/> <input type="button" value="Back"/>	

Figure 4-25 Add or Modify an Address Reservation Entry

To modify A Reserved IP address:

1. Select the reserved address entry to your needs and click **Modify**. If you wish to delete the entry, click **Delete**.
2. Click **Save** to keep your changes.

To delete all Reserved IP addresses:

1. Click **Clear All**.

Click **Next** to go to the next page and Click **Previous** to return the previous page.

Note:

The changes won't take effect until the device reboots.

4.8 Wireless settings

Selecting **Wireless Settings** will allow you to do some advanced settings for the device in the following screen as shown in Figure 4-26.

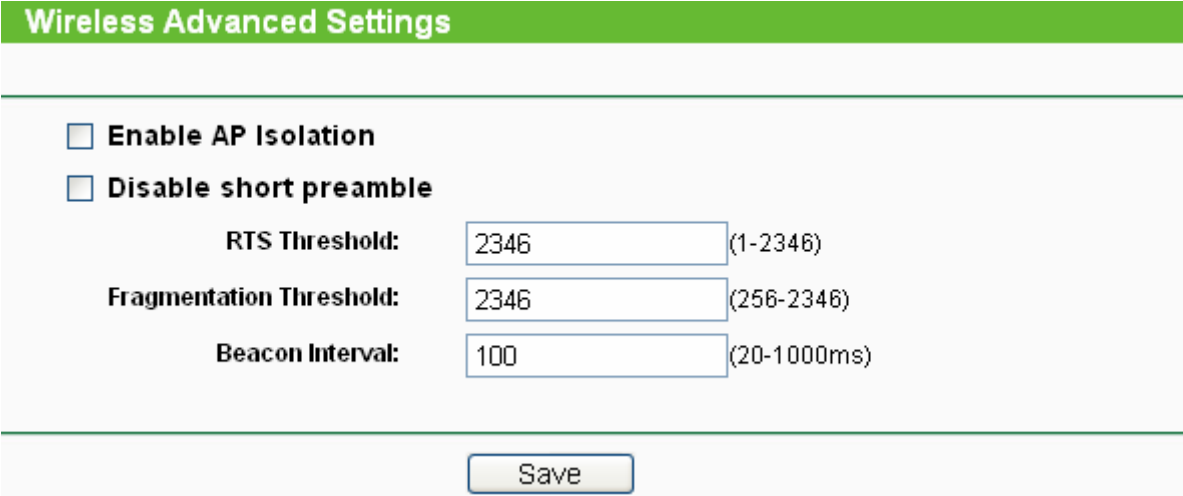

Wireless Advanced Settings

Enable AP Isolation

Disable short preamble

RTS Threshold: (1-2346)

Fragmentation Threshold: (256-2346)

Beacon Interval: (20-1000ms)

Figure 4-26 Wireless settings

- **Enable AP Isolation** - Isolate all connected wireless stations so that wireless stations can not access each other through WLAN. This option is available only for AP mode.
- **Disable short preamble** - Disable short preamble and use long preamble only. It is recommended that you do not change these settings.
- **RTS Threshold** - RTS/CTS Threshold, the packet size that is used to determine if RTS/CTS should be sent.
- **Fragmentation Threshold** - The maximum packet size used for fragmentation.
- **Beacon Interval** - The interval time between two successive beacons.

4.9 Forwarding

There are four submenus under the Forwarding menu (shown in Figure 4-27): **Virtual Servers**, **Port Triggering**, **DMZ** and **UPnP**. Click any of them, and you will be able to configure the corresponding function. The detailed explanations for each submenu are provided below.

Virtual servers can be used for setting up public services on your LAN, such as DNS, Email and FTP. A virtual server is defined as a service port, and all requests from the Internet to this service port will be redirected to the computer specified by the server IP. Any PC that was used for a virtual server must have a static or reserved IP Address because its IP Address may change when using the DHCP function. Port Triggering is used for some applications that cannot work with a pure NAT router, like Internet games, video conferencing, Internet calling and so on, which require multiple connections. The DMZ host feature allows one local host to be exposed to the Internet for a special-purpose service such as Internet gaming or videoconferencing. DMZ host forwards all the ports at the same time. Any PC whose port is being forwarded must have its DHCP client function disabled and should have a new static IP Address assigned to it because its IP Address may change when using the DHCP function. The Universal Plug and Play (UPnP) feature allows the devices, such as Internet computers, to access the local host resources or devices as needed. UPnP devices can be automatically discovered by the UPnP service application on the LAN.

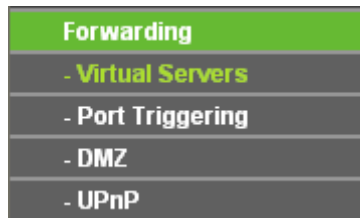

Figure 4-27 The Forwarding menu

4.9.1 Virtual Servers

Selecting **Forwarding > Virtual Servers** will allow you to set up virtual servers on the page as shown in Figure 4-28.

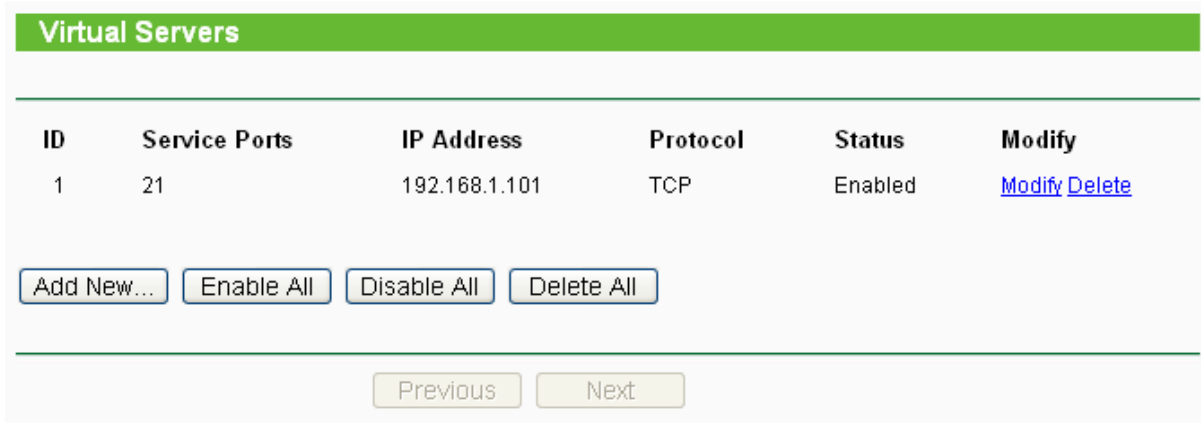

Figure 4-28 Virtual Servers

- **Service Port** - The numbers of External Ports. You can type a service port or a range of service ports (the format is XXX – YYY, XXX is the start port, YYY is the end port).
- **IP Address** - The IP Address of the PC providing the service application.
- **Protocol** - The protocol used for this application, either **TCP**, **UDP**, or **All** (all protocols supported by the router).
- **Status** - The status of this entry is either **Enabled** or **Disabled**.
- **Modify** - To modify or delete an existing entry.

To setup a virtual server entry, please take the following steps:

1. Click the **Add New...** in virtual servers page. (pop-up Figure 4-29)
2. Select the service you want to use from the Common Service Port list. If the **Common Service Port** list does not have the service that you want to use, type the number of the service port or service port range in the **Service Port** box.
3. Type the IP Address of the computer in the **Server IP Address** box.
4. Select the protocol used for this application.
5. Select the **Enable** option to enable the virtual server.
6. Click the **Save** button.

Add or Modify a Virtual Server Entry

Service Port: (XX-XX or XX)

IP Address:

Protocol: ▼

Status: ▼

Common Service Port: ▼

Figure 4-29 Add or Modify a Virtual Server Entry

- **Common Service Port** - Some common services already exist in the pull-down list.

 **Note:**

It is possible that you have a computer or server that has more than one type of available service. If so, select another service, and enter the same IP Address for that computer or server.

To modify or delete an existing entry:

1. Click the **Modify** in the entry you want to modify. If you want to delete the entry, click the **Delete**.
2. Modify the information.
3. Click the **Save** button.

Click the **Enable All** button to make all entries enabled

Click the **Disabled All** button to make all entries disabled.

Click the **Delete All** button to delete all entries.

Click the **Next** button to go to the next page and Click the **Previous** button to return the previous page.

 **Note:**

If you set the virtual server of service port as 80, you must set the Web management port on **System Tools → Remote Management** page to be any value except 80 such as 8080. Or else there will be a conflict to disable the virtual server.

4.9.2 Port Triggering

Selecting **Forwarding > Port Triggering** will enable you to set up Port Triggering entries on the page as shown in Figure 4-30.

Port Triggering

ID	Trigger Port	Trigger Protocol	Incoming Ports	Incoming Protocol	Status	Modify
1	554	ALL	6970-6999	ALL	Enabled	Modify Delete

Figure 4-30 Port Triggering

Once configured, operation is as follows:

1. A local host makes an outgoing connection to an external host using a destination port number defined in the **Trigger Port** field.
 2. The router records this connection, opens the incoming port or ports associated with this entry in the Port Triggering table, and associates them with the local host.
 3. When necessary the external host will be able to connect to the local host using one of the ports defined in the **Incoming Ports** field.
- **Trigger Port** - The port for outgoing traffic. An outgoing connection using this port will "Trigger" this rule.
 - **Trigger Protocol** - The protocol used for Trigger Ports, **TCP**, **UDP**, or **All** (all protocols supported by the router).
 - **Incoming Ports Range** - The port or port range used by the remote system when it responds to the outgoing request. A response using one of these ports will be forwarded to the PC that triggered this rule. You can input at most 5 groups of ports (or port section). Every group of ports must be set apart with ",". For example, 2000-2038, 2050-2051, 2085, 3010-3030.
 - **Incoming Protocol** - The protocol used for Incoming Ports Range, **TCP**, **UDP**, or **ALL** (all protocols supported by the router).
 - **Status** - The status of this entry is either **Enabled** or **Disabled**.

To add a new rule, please take the following steps:

1. Click the **Add New...** in Port Triggering page. (pop-up Figure 4-31)
2. Select a common application from the **Common Applications** drop-list then the port parameters will be automatically filled in the corresponding field. If the **Common Applications** list does not have the application you want, type the port parameters manually.
3. Select the protocol used for **Trigger Port** and **Incoming Ports** from the corresponding pull-down list.
4. Select the **Enable** option in the **Status** pull-down list..
5. Click the **Save** button to save the new rule.

Add or Modify a Port Triggering Entry

Trigger Port:	<input type="text" value="554"/>
Trigger Protocol:	<input style="border: none; background-color: #e0e0e0; padding: 2px 5px; font-size: small; font-weight: normal; cursor: pointer; border-bottom: 1px solid #ccc;" type="text" value="ALL"/>
Incoming Ports:	<input type="text" value="6970-6999"/>
Incoming Protocol:	<input style="border: none; background-color: #e0e0e0; padding: 2px 5px; font-size: small; font-weight: normal; cursor: pointer; border-bottom: 1px solid #ccc;" type="text" value="ALL"/>
Status:	<input style="border: none; background-color: #e0e0e0; padding: 2px 5px; font-size: small; font-weight: normal; cursor: pointer; border-bottom: 1px solid #ccc;" type="text" value="Enabled"/>
Common Applications:	<input style="border: none; background-color: #e0e0e0; padding: 2px 5px; font-size: small; font-weight: normal; cursor: pointer; border-bottom: 1px solid #ccc;" type="text" value="Quick Time 4"/>

Figure 4-31 Add or Modify a Triggering Entry

To modify or delete an existing entry, please take the following steps:

1. Click the **Modify** in the entry you want to modify. If you want to delete the entry, click the **Delete**.
2. Modify the information.
3. Click the **Save** button.

Click **Enable All** to make all entries enabled.
 Click **Disabled All** to make all entries disabled.
 Click **Delete All** to delete all entries

Note:

- 1) When the trigger connection is released, the corresponding opening ports will be closed.
- 2) Each rule can only be used by one host on the LAN at a time. The trigger connection of other hosts on the LAN will be refused.
- 3) Incoming Port Range enabled cannot overlap each other at the same time.

4.9.3 DMZ

Selecting **Forwarding > DMZ** will allow you to set up an DMZ host on the page as shown in Figure 4-32.

DMZ

Current DMZ Status:	<input type="radio"/> Enable <input checked="" type="radio"/> Disable
DMZ Host IP Address:	<input type="text" value="0.0.0.0"/>

Figure 4-32 DMZ

To assign a computer or server to be a DMZ server:

1. Click the **Enable** radio button

2. Enter the IP address of a local PC that is desired to be set as the DMZ host in the **DMZ Host IP Address** field.
3. Click the **Save** button.

 **Note:**

After you set the DMZ host, the firewall related to the host will not work.

4.9.4 UPnP

Selecting **Forwarding > UPnP** will enable you to configure the UPnP function on the page as shown in Figure 4-33:

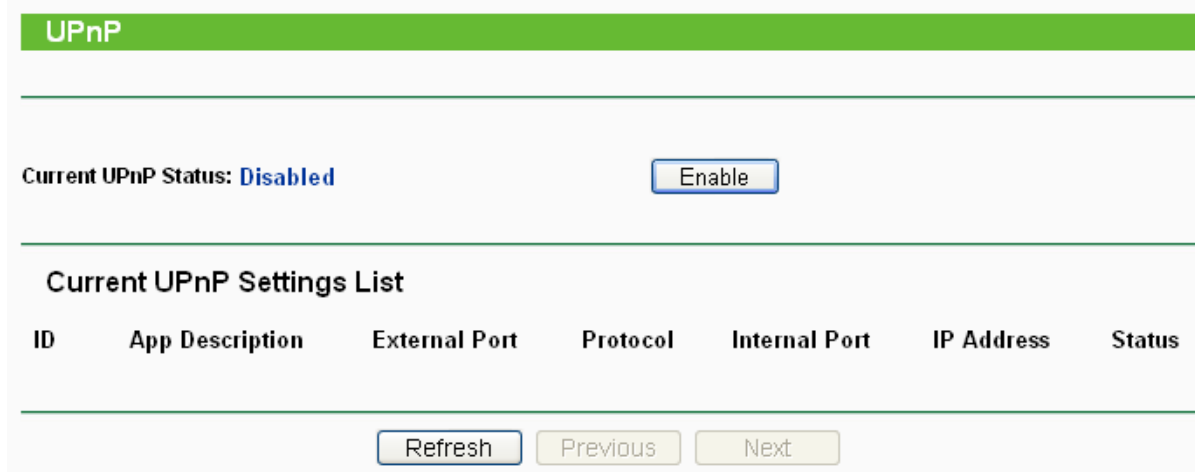

Figure 4-33 UPnP Settings

- **Current UPnP Status** - UPnP can be enabled or disabled by clicking the **Enable** or **Disable** button. As enabling UPnP may present a risk to security, this feature is disabled by default.
- **Current UPnP Settings List** - This table displays the current UPnP information.
 - **App Description** – The description provided by the application in the UPnP request
 - **External Port** - External port, which the router opened for the application.
 - **Protocol** - Shows which type of protocol is opened.
 - **Internal Port** - Internal port, which the router opened for local host.
 - **IP Address** - The IP address of the local host which initiates the UPnP request.
 - **Status** - Either Enabled or Disabled, “Enabled” means that port is still active. Otherwise, the port is inactive.

Click **Enable** to enable UPnP.

Click **Disable** to disable UPnP

Click **Refresh** to update the Current UPnP Settings List.

4.10 Security

Security option is used for secure your network. IP address Filtering allows you to control the Internet Access of specific users on your LAN based on their IP addresses. Domain Filtering allows you to control the access to certain websites on the Internet by specifying their domains or key words. Like the IP Address Filtering, MAC Address Filtering allows you to control access to the Internet of users on your local network based on their MAC Address. Advanced Security helps to protect the router from some attacks. Remote Management allows you to manage your Router

from a remote location via the Internet.

There are six submenus under the Security menu (shown in Figure 4-34): **Firewall**, **IP Address Filtering**, **Domain Filtering**, **MAC Address Filtering**, **Remote Management** and **Advanced Security**. Click any of them, and you will be able to configure the corresponding function. The detailed explanations for each submenu are provided below.

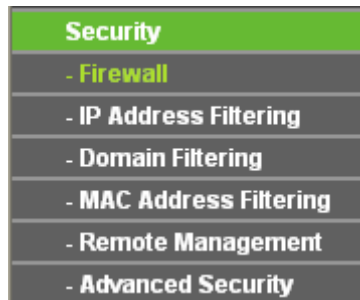

Figure 4-34 The Security menu

4.10.1 Firewall

Selecting **Security > Firewall** will allow you to turn on or off the general firewall switch as shown in Figure 4-35. The default setting for the switch is off. Turning the general firewall switch to off will disable IP Filtering, Domain Filtering and MAC Filtering even if their individual settings are enabled.

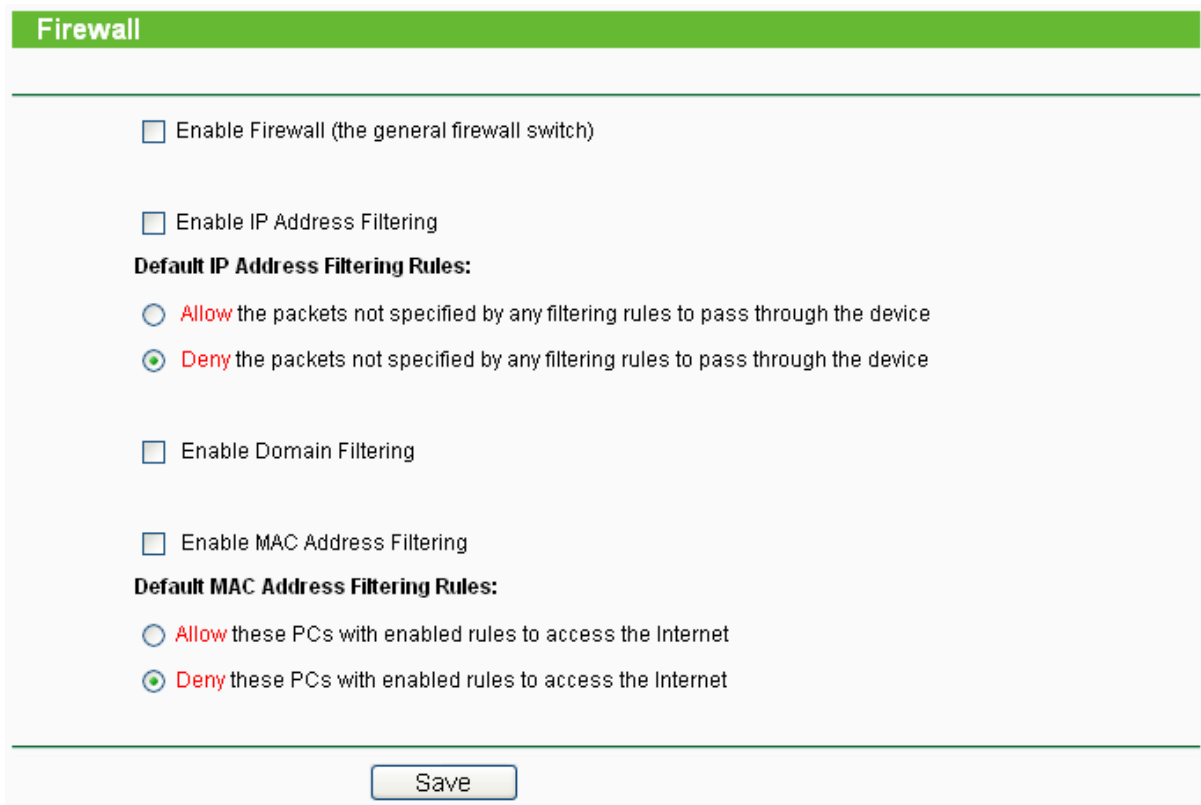

Figure 4-35 Firewall Settings

- **Enable Firewall** - Check this box to enable Firewall.
- **Enable IP Address Filtering** - Check this box to enable IP Address Filtering. There are two default filtering rules for IP Address Filtering: Allow or Deny the packets specified to pass through the router.
- **Enable Domain Filtering** - Check this box to enable Domain Filtering.

- **Enable MAC Filtering** - Check this box to enable MAC Address Filtering. There are two default filtering rules for MAC Address Filtering: Allow or Deny the packets specified to pass through the router.

4.10.2 IP Address Filtering

Selecting **Security > IP Address Filtering** will allow you to configure the IP address filtering entry on the page as shown in Figure 4-36.

Figure 4-36 IP address Filtering

To disable the IP Address Filtering feature, keep the default setting. To set up an IP Address Filtering entry, you should first **Enable** Firewall and **Enable** IP Address Filtering on the Firewall page as shown in Figure 4-35, and then click the **Add New...** button in Figure 4-36. The page "**Add or Modify an IP Address Filtering entry**" will appear shown in Figure 4-37.

Figure 4-37 Add or Modify an IP Address Filtering Entry

To create or modify an IP Address Filtering entry, please follow these instructions:

1. **Effective Time** - Enter a range of time in HHMM format, which points to the range time for the entry to take effect. For example, 0803 - 1705, the entry will take effect from 08:03 to 17:05.

2. **LAN IP Address** - Enter a LAN IP Address or a range of LAN IP addresses in the field, in dotted-decimal notation format. For example, 192.168.1.20 - 192.168.1.30. Keep the field blank, which means all LAN IP Addresses have been put into the field.
3. **LAN Port** - Enter a LAN Port or a range of LAN ports in the field. For example, 1030 - 2000. Keep the field blank, which means all LAN ports have been put into the field.
4. **WAN IP Address** - Enter a WAN IP Address or a range of WAN IP Addresses in the field, in dotted-decimal notation format. For example, 61.145.238.6 - 61.145.238.47. Keep the field blank, which means all WAN IP Addresses have been put into the field.
5. **WAN Port** - Enter a WAN Port or a range of WAN Ports in the field. For example, 25 - 110. Keep the field blank, which means all WAN Ports have been put into the field.
6. **Protocol** - Select which protocol is to be used, either **TCP**, **UDP**, or **All** (all protocols supported by the router).
7. **Action** - Select either **Allow** or **Deny** through the router.
8. **Status** - Select **Enabled** or **Disabled** for this entry from the **Status** pull-down list.

Click the **Save** button to save this entry.

To add another entry, repeat steps 1-9.

When finished, click the **Back** button.

To modify or delete an existing entry:

1. Click the **Modify** in the entry you want to modify. If you want to delete the entry, click the **Delete**.
2. Modify the information.
3. Click the **Save** button.

Click the **Enable All** button to make all entries enabled.

Click the **Disabled All** button to make all entries disabled.

Click the **Delete All** button to delete all entries.

You can change the entry's order as desired. Fore entries are before hind entries. Enter the ID number in the first box you want to move and another ID number in second box you want to move to, and then click the **Move** button to change the entry's order.

Click the **Next** button to the next page and click the **Previous** button to return to the previous page.

For example: If you desire to block E-mail received and sent by the IP Address 192.168.1.7 on your local network, and to make the PC with IP Address 192.168.1.8 unable to visit the website of IP Address 202.96.134.12, while other PC(s) have no limit you should specify the following IP address filtering list:

ID	Effective time	LAN IP Address	LAN Port	WAN IP Address	WAN Port	Protocol	Action	Status	Modify
1	0000-2400	192.168.1.7	-	-	25	ALL	Deny	Enabled	Modify Delete
2	0000-2400	192.168.1.7	-	-	110	ALL	Deny	Enabled	Modify Delete
3	0000-2400	192.168.1.8	-	202.96.134.12	-	ALL	Deny	Enabled	Modify Delete

4.10.3 Domain Filtering

Selecting **Security > Domain Filtering** will allows you to configure the domain filtering entry as shown in Figure 4-38.

Domain Filtering

Firewall Settings (You can change them on Firewall page)

Enable Firewall: **Disabled**

Enable Domain Filtering: **Disabled**

ID	Effective time	Domain Name	Status	Modify
----	----------------	-------------	--------	--------

Figure 4-38 Domain Filtering

Before adding a Domain Filtering entry, you must ensure that **Enable Firewall** and **Enable Domain Filtering** have been selected on the **Firewall** page as shown in Figure 4-35. To Add a Domain filtering entry, click the **Add New...** button in Figure 4-38. The page "**Add or Modify a Domain Filtering entry**" will appear, shown in Figure 4-39.

Add or Modify an Domain Filtering Entry

Effective Time: -

Domain Name:

Status: ▼

Figure 4-39 Add or Modify a Domain Filtering entry

To add or modify a Domain Filtering entry, follow these instructions:

1. **Effective Time** - Enter a range of time in HHMM format specifying the time for the entry to take effect. For example, if you enter: 0803 - 1705, than the entry will take effect from 08:03 to 17:05.
2. **Domain Name** - Type the domain or key word as desired in the field. A blank in the domain field means all websites on the Internet. For example: www.xxyy.com.cn, .net.
3. **Status** - Select **Enabled** or **Disabled** for this entry on the **Status** pull-down list.
4. Click the **Save** button to save this entry.

To modify or delete an existing entry:

1. Click the **Modify** in the entry you want to modify. If you want to delete the entry, click the **Delete button**.
2. Modify the information.
3. Click the **Save** button.

Click the **Enabled All** button to make all entries enabled.

Click the **Disabled All** button to make all entries disabled.

Click the **Delete All** button to delete all entries

Click the **Next** button to go to the next page and the **Previous** button to return to the previous page.

For example, if you want to block the PC(s) on your LAN to access websites www.xxyy.com.cn, www.aabbcc.com and websites with .net in the end on the Internet while no limit for other websites, you should specify the following Domain filtering list.

ID	Effective time	Domain Name	Status	Modify
1	0000-2400	www.xxyy.com.cn	Enabled	Modify Delete
2	0000-2400	www.aabbcc.com	Enabled	Modify Delete
3	0000-2400	.net	Enabled	Modify Delete

4.10.4 MAC Address Filtering

Selecting **Security > Domain Filtering** will allows to configure the MAC address filtering entry on the page as shown in Figure 4-40.

MAC Address Filtering

Firewall Settings (You can change them on Firewall page)

Enable Firewall: **Disabled**

Enable MAC Address Filtering: **Disabled**

Default Filtering Rules: **Deny** these PCs with the enabled rules to access the Internet.

ID	MAC Address	Description	Status	Modify
----	-------------	-------------	--------	--------

[Add New...](#) [Enable All](#) [Disable All](#) [Delete All](#)

[Previous](#) [Next](#)

Figure 4-40 MAC address Filtering

Before setting up MAC Filtering entries, you must ensure that **Enable** Firewall and **Enable** MAC Filtering have been selected on the Firewall page as shown in Figure 4-35. To Add a MAC Address filtering entry, clicking the **Add New...** button in Figure 4-40. The page "**Add or Modify a MAC Address Filtering entry**" will appear, shown in Figure 4-41:

Add or Modify a MAC Address Filtering Entry

MAC Address:

Description:

Status: Enabled ▼

Save
Back

Figure 4-41 Add or Modify a MAC Address Filtering entry

To add or modify a MAC Address Filtering entry, follow these instructions:

1. Enter the appropriate MAC Address into the **MAC Address** field. The format of the MAC Address is XX-XX-XX-XX-XX-XX (X is any hexadecimal digit). For example: 00-0E-AE-B0-00-0B.
2. Type the description of the PC in the **Description** field. Fox example: John's PC.
3. **Status** - Select **Enabled** or **Disabled** for this entry on the **Status** pull-down list.
4. Click the **Save** button to save this entry.

To add additional entries, repeat steps 1-4.

When finished, click the **Return** button to return to the **MAC Address Filtering** page.

To modify or delete an existing entry:

1. Click the **Modify** in the entry you want to modify. If you want to delete the entry, click the **Delete**.
2. Modify the information.
3. Click the **Save** button.

Click the **Enable All** button to make all entries enabled.

Click the **Disabled All** button to make all entries disabled.

Click the **Delete All** button to delete all entries

Click the **Next** button to go to the next page and click the **Previous** button to return to the previous page.

Fox example: If you want to block the PC with MAC addresses 00-0A-EB-00-07-BE and 00-0A-EB-00-07-5F to access the Internet, first, enable the **Firewall** and **MAC Address Filtering** on the **Firewall** page, then, you should specify the Default MAC Address Filtering Rule "**Deny these PC(s) with effective rules to access the Internet**" on the Firewall page and the following MAC address filtering list on this page:

ID	MAC Address	Description	Status	Modify
1	00-0A-EB-00-07-BE	John's PC	Enabled	Modify Delete
2	00-0A-EB-00-07-5F	Alice's PC	Enabled	Modify Delete

4.10.5 Remote Management

Selecting **Security > Remote Management** will allow you to configure the Remote Management function in the screen as shown in Figure 4-42. This feature allows you to manage your Router

from a remote location via the Internet.

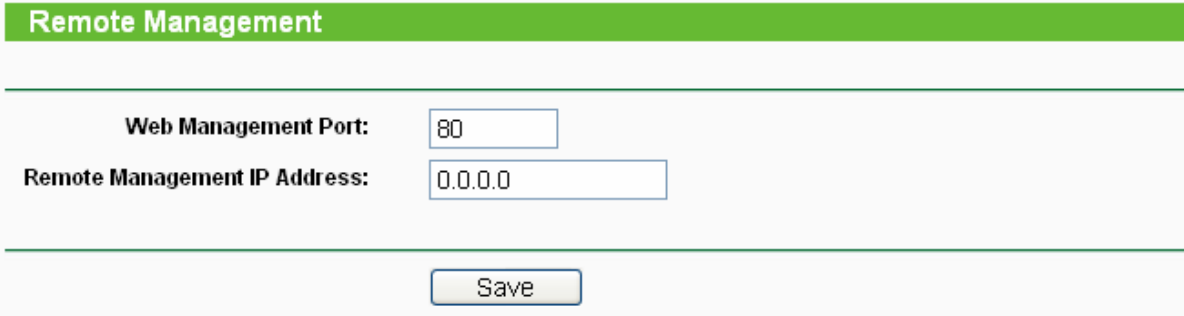

The screenshot shows a configuration interface for 'Remote Management'. It features a green header bar with the text 'Remote Management'. Below this, there are two rows of configuration options. The first row is 'Web Management Port' with a text input field containing the number '80'. The second row is 'Remote Management IP Address' with a text input field containing '0.0.0.0'. At the bottom center of the form is a 'Save' button.

Figure 4-42 Remote Management

- **Web Management Port** - Web browser access normally uses the standard HTTP service port 80. This Router's default remote management web port number is 80. For greater security, you can change the remote management web port to a custom port by entering that number in the box provided. Choose a number between 1 and 65534 but do not use the number of any common service port.
- **Remote Management IP Address** - This is the current address you will use when accessing your Router from the Internet. This function is disabled when the IP address is set to the default value of 0.0.0.0. To enable this function change 0.0.0.0 to a valid IP address. If set to 255.255.255.255, then all the hosts can access the Router from internet.

 **Note:**

- 1) To access the Router, you should type your Router's WAN IP address into your browser's address (in IE) or Location (in Navigator) box, followed by a colon and the custom port number. For example, if your Router's WAN address is 202.96.12.8, and the port number used is 8080, please enter `http://202.96.12.8:8080` in your browser. Later, you may be asked for the Router's password. After successfully entering the username and password, you will be able to access the Router's web-based utility.
- 2) Be sure to change the Router's default password to a very secure password.

4.10.6 Advanced Security

Selecting **Security > Advanced Security** will enable you to protect the router from being attacked by TCP-SYN Flood, UDP Flood and ICMP-Flood from LAN as shown in Figure 4-43.

Advanced Security

Packets Statistics Interval (5 ~ 60): Seconds

DoS Protection: Disable Enable

Enable ICMP-FLOOD Attack Filtering

ICMP-FLOOD Packets Threshold (5 ~ 3600): Packets/s

Enable UDP-FLOOD Filtering

UDP-FLOOD Packets Threshold (5 ~ 3600): Packets/s

Enable TCP-SYN-FLOOD Attack Filtering

TCP-SYN-FLOOD Packets Threshold (5 ~ 3600): Packets/s

Ignore Ping Packet From WAN Port

Forbid Ping Packet From LAN Port

Figure 4-43 Advanced Security settings

- **Packets Statistic interval (5 ~ 60)** - The default value is 10. Select a value between 5 and 60 seconds from the pull-down list. The **Packets Statistic interval** value indicates the time section of the packets statistic. The result of the statistic used for analysis by **SYN Flood**, **UDP Flood** and **ICMP-Flood**.
- **DoS protection - Enable or Disable** the DoS protection function. Only when it is enabled, will the flood filters be effective.
- **Enable ICMP-FLOOD Attack Filtering - Enable or Disable** the **ICMP-FLOOD** Attack Filtering.
- **ICMP-FLOOD Packets threshold: (5 ~ 3600)** - The default value is 50. Enter a value between 5 ~ 3600 packets. When the current **ICMP-FLOOD** Packets number is beyond the set value, the router will start up the blocking function immediately.
- **Enable UDP-FLOOD Filtering - Enable or Disable** the **UDP-FLOOD** Filtering.
- **UDP-FLOOD Packets threshold: (5 ~ 3600)** - The default value is 50. Enter a value between 5 ~ 3600 packets. When the current **UDP-FLOOD** Packets numbers is beyond the set value, the router will start up the blocking function immediately.
- **Enable TCP-SYN-FLOOD Attack Filtering - Enable or Disable** the **TCP-SYN- FLOOD** Attack Filtering.
- **TCP-SYN-FLOOD Packets threshold: (5 ~ 3600)** - The default value is 50. Enter a value between 5 ~ 3600 packets. When the current **TCP-SYN-FLOOD** Packets numbers is beyond the set value, the router will start up the blocking function immediately.
- **Ignore Ping Packet from WAN Port - Enable or Disable** ignore ping packet from WAN port. The default is disabled. If enabled, the ping packet from the Internet cannot access the

router.

- **Forbid Ping Packet from LAN Port** - Enable or Disable forbidding Ping Packet to access the router from the LAN port. The default value is disabled. If enabled, the ping packet from the LAN port cannot access the router. (Defends against some viruses)

Click the **Save** button to save the settings.

Click the **Blocked DoS Host Table** button to display the DoS host table by blocking.

4.11 Static Routing

A static route is a pre-determined path that network information must travel to reach a specific host or network. To add or delete a route, work in the area under the Static Routing page as shown in Figure 4-44.

ID	Destination IP Address	Subnet Mask	Default Gateway	Status	Modify
----	------------------------	-------------	-----------------	--------	--------

Buttons: Add New..., Enable All, Disable All, Delete All

Buttons: Previous, Next

Figure 4-44 Static Routing

To add static routing entries:

1. Click the **Add New** button. (pop up Figure 4-45)
2. Enter the following parameters.
 - **Destination IP Address** - The **Destination IP Address** is the address of the network or host that you want to assign to a static route.
 - **Subnet Mask** - The **Subnet Mask** determines which portion of an IP Address is the network portion, and which portion is the host portion.
 - **Default Gateway** - This is the IP Address of the gateway device that allows for contact between the router and the network or host.
3. Select **Enabled** or **Disabled** for this entry from the **Status** pull-down list.
4. Click the **Save** button to save the changes.

Add or Modify a Static Route Entry

Destination IP Address:

Subnet Mask:

Default Gateway:

Status:

Figure 4-45 Add or Modify a Static Route Entry

To modify or delete an existing entry:

1. Click the **Modify** in the entry you want to modify. If you want to delete the entry, click the **Delete**.
2. Modify the information.
3. Click the **Save** button.

Click the **Enable All** button to make all entries enabled.

Click the **Disabled All** button to make all entries disabled.

Click the **Delete All** button to delete all entries.

4.12 IP & MAC Binding

ARP Binding is useful for controlling access of specific computers in the LAN. This page displays the **IP & MAC Binding Setting** table; you can operate it in accord with your desire.

There are two submenus under the IP & MAC Binding menu (shown in Figure 4-46): **Binding Setting** and **ARP List**. Click any of them, and you will be able to configure the corresponding function. The detailed explanations for each submenu are provided below.

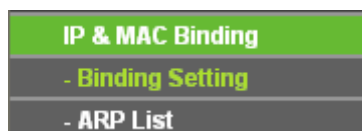

Figure 4-46 the IP & MAC Binding menu

4.12.1 Binding Setting

Selecting **IP & MAC Binding > Binding Setting** will allow you to configure the binding entries, as shown in Figure 4-47.

Binding Settings

ARP Binding: Disable Enable

ID	MAC Address	IP Address	Bind	Modify
1	00-0A-EB-00-07-BE	192.168.1.101	<input checked="" type="checkbox"/>	Modify Delete

Page 1

Figure 4-47 Binding Setting

- **MAC Address** - The MAC address of the controlled computer in the LAN.
- **IP Address** - The assigned IP address of the controlled computer in the LAN.
- **Bind** - Check this option to enable ARP binding for a specific device.
- **Modify** - To modify or delete an existing entry.

When you want to add or modify an IP & MAC Binding entry, you can click the **Add New** button or **Modify** button, and then you will go to the next page. This page is used for adding or modifying an IP & MAC Binding entry (shown in Figure 4-48).

IP & MAC Binding Settings

Bind:

MAC Address:

IP Address:

Figure 4-48 IP & MAC Binding Setting (Add & Modify)

To add IP & MAC Binding entries, follow the steps below.

1. Click the **Add New...** button as shown in Figure 4-62.
2. Enter the MAC Address and IP Address.
3. Select the Bind checkbox.
4. Click the **Save** button to save it.

To modify or delete an existing entry, follow the steps below.

1. Find the desired entry in the table.
2. Click **Modify** or **Delete** as desired on the **Modify** column.

To find an existing entry, follow the steps below.

1. Click the **Find** button as shown in Figure 4-62.
2. Enter the MAC Address or IP Address.
3. Click the **Find** button in the page as shown in Figure 4-49.

Find IP & MAC Binding Entry

MAC Address:

IP Address:

ID	MAC Address	IP Address	Bind Link
1	00-0A-EB-00-07-BE	192.168.1.101	<input checked="" type="checkbox"/> To page

Figure 4-49 Find IP & MAC Binding Entry

Click the **Enable All** button to make all entries enabled.

Click the **Delete All** button to delete all entries.

4.12.2 ARP List

Selecting **IP & MAC Binding > ARP List** will enable you to observe the computers in the LAN by checking the relationship of MAC address and IP address on the ARP list, and you could configure the items on the ARP list also. This page displays the ARP List; it shows all the existing IP & MAC Binding entries (shown in Figure 4-50).

ARP List

ID	MAC Address	IP Address	Status	Configure
1	00-19-66-CB-45-66	192.168.1.93	Unbound	Load Delete
2	00-0A-EB-00-07-BE	192.168.1.101	Bound	Load Delete

Figure 4-50 ARP List

- **MAC Address** - The MAC address of the controlled computer in the LAN.
- **IP Address** - The assigned IP address of the controlled computer in the LAN.
- **Status** - Indicates whether or not the MAC and IP addresses are bound.
- **Configure** - Load or delete an item.
 - **Load** - Load the item to the IP & MAC Binding list.
 - **Delete** - Delete the item.

Click the **Bind All** button to bind all the current items, available after enable.

Click the **Load All** button to load all items to the IP & MAC Binding list.

Click the **Refresh** button to refresh all items.

Note:

An item could not be loaded to the IP & MAC Binding list if the IP address of the item has been loaded before. Error warning will prompt as well. Likewise, "Load All" only loads the items without interference to the IP & MAC Binding list.

4.13 Dynamic DNS

The router offers a Dynamic Domain Name System (**DDNS**) feature. DDNS lets you assign a fixed host and domain name to a dynamic Internet IP Address. It is useful when you are hosting your own website, FTP server, or other server behind the router. Before using this feature, you need to sign up for DDNS service providers such as www.dyndns.org, www.oray.net or www.comexe.cn. The Dynamic DNS client service provider will give you a password or key.

4.13.1 Dyndns.org DDNS

If your selected dynamic DNS **Service Provider** is www.dyndns.org, the page will appear as shown in Figure 4-51.

The screenshot shows the DDNS configuration interface. At the top, a green bar contains the text 'DDNS'. Below this, the 'Service Provider' is set to 'Dyndns (www.dyndns.org)' with a dropdown arrow and a 'Go to register...' link. The 'User Name', 'Password', and 'Domain Name' fields are empty text boxes. There is an unchecked checkbox for 'Enable DDNS'. The 'Connection Status' is 'DDNS not launching!', with 'Login' and 'Logout' buttons. A 'Save' button is at the bottom.

Figure 4-51 Dyndns.org DDNS Settings

To set up for DDNS, follow these instructions:

1. Enter the **User Name** for your DDNS account.
 2. Enter the **Password** for your DDNS account.
 3. Enter the **Domain Name** you received from dynamic DNS service provider
 4. Click the **Login** button to log in to the DDNS service.
- **Connection Status** - The status of the DDNS service connection is displayed here.

Click **Logout** to log out the DDNS service.

4.13.2 Oray.net DDNS

If your selected dynamic DNS **Service Provider** is www.oray.net, the page will appear as shown in Figure 4-52.

DDNS

Service Provider: PeanutHull (www.oray.net)

User Name:

Password:

Enable DDNS

Connection Status: DDNS not launching!

Service Type: ---

Domain Name: ---

Figure 4-52 Oray.net DDNS Settings

To set up for DDNS, follow these instructions:

1. Enter the **User Name** for your DDNS account.
 2. Enter the **Password** for your DDNS account.
 3. Click the **Login** button to log in to the DDNS service.
- **Connection Status** - The status of the DDNS service connection is displayed here.
 - **Domain Name** - The domain names are displayed here.

Click **Logout** to log out the DDNS service.

4.13.3 Comexe.cn DDNS

If your selected dynamic DNS **Service Provider** is www.comexe.cn, the page will appear as shown in Figure 4-53.

DDNS

Service Provider: Comexe (www.comexe.cn) [Go to register...](#)

Domain Name:

Domain Name:

Domain Name:

Domain Name:

Domain Name:

User Name:

Password:

Enable DDNS

Connection Status: DDNS not launching!

Figure 4-53 Comexe.cn DDNS Settings

To set up for DDNS, follow these instructions:

1. Enter the **domain names** your dynamic DNS service provider gave.
 2. Enter the **User Name** for your DDNS account.
 3. Enter the **Password** for your DDNS account.
 4. Click the **Login** button to log in to the DDNS service.
- **Connection Status** -The status of the DDNS service connection is displayed here.
- Click **Logout** to log out the DDNS service.

4.14 System Tools

System Tools option helps you to optimize the configuration of your device. You can upgrade the AP to the latest version of firmware as well as backup or restore the AP's configuration files. Ping Watch Dog can help to continuously monitor a particular connection to a remote host. Speed Test helps to test the connection speed to and from any reachable IP address on current network, especially when we are building wireless network between devices which are far away from each other. It's suggested that you change the default password to a more secure one because it controls access to the device's web-based management page. Besides, you can find out what happened to the system in System Log.

There are ten submenus under the **System Tools** menu (shown as Figure 4-54): **Time**, **Firmware**, **Factory Defaults**, **Backup & Restore**, **Ping Watch Dog**, **Speed Test**, **Reboot**, **Password**, **Syslog** and **Statistics**. Clicking any of them will enable you to configure the corresponding function. The detailed explanations for each submenu are provided below.

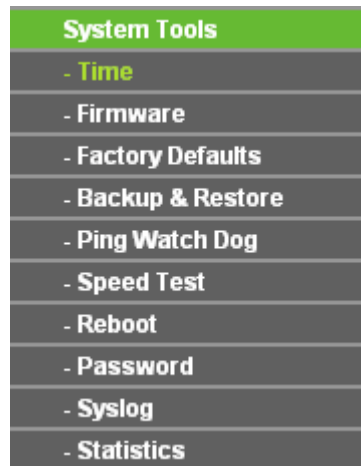

Figure 4-54 The System Tools menu

4.14.1 Time

Selecting **System Tools > Time** will allow you to set time manually or get GMT from the Internet for the router on the page as shown in Figure 4-55.

Figure 4-55 Time settings

- **Time Zone** - Select your local time zone from this drop-down list.
- **Date** - Enter your local date in MM/DD/YY into the right blanks.
- **Time** - Enter your local time in HH/MM/SS into the right blanks.

To configure Time settings, please follow these steps below:

1. Select your local time zone.
2. Enter date and time in the right blanks
3. Click **Save**.

Click the **Get GMT** button to get GMT time from the Internet if you have connected to the Internet.

If you're using Daylight saving time, please follow the steps below.

1. Select **Using Daylight Saving Time**.
2. Enter daylight saving begin time and end time in the right blanks.

 **Note:**

- 1) This setting will be used for some time-based functions such as firewall. You must specify your time zone once you log in to the router successfully, if not, the time limited on these functions will not take effect.
- 2) The time will be lost if the router is turned off.

The router will obtain GMT automatically from the Internet When it connects to Internet.

4.14.2 Firmware

Selecting **System Tools > Firmware** allows you to upgrade the latest version of firmware for the device on the screen shown in Figure 4-56.

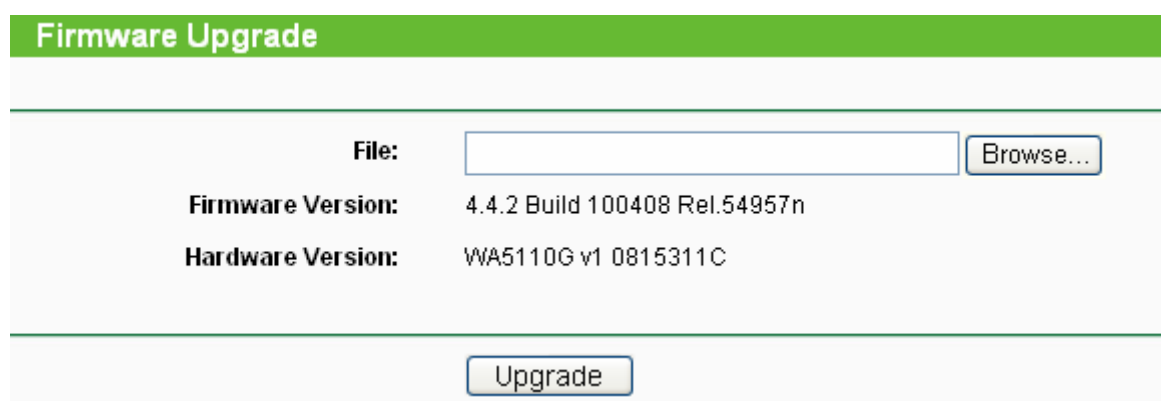

File:	<input type="text"/>	<input type="button" value="Browse..."/>
Firmware Version:	4.4.2 Build 100408 Rel.54957n	
Hardware Version:	WA5110G v1 0815311C	
<input type="button" value="Upgrade"/>		

Figure 4-56 Firmware Upgrade

New firmware versions are posted at <http://www.tp-link.com> and can be downloaded for free. There is no need to upgrade the firmware unless the new firmware has a new feature you want to use. However, when experiencing problems caused by the AP itself, you can try to upgrade the firmware.

 **Note:**

Before upgrading the AP's firmware, you should write down some of your customized settings to avoid losing important configuration settings of AP.

To upgrade the AP's firmware, please take the following steps:

1. Download a more recent firmware upgrade file from the TP-LINK website (<http://www.tp-link.com>).
 2. Click **Browse** to view the folders and select the downloaded file.
 3. Click **Upgrade**.
- **Firmware Version** - Displays the current firmware version.
 - **Hardware Version** - Displays the current hardware version. The upgrade file must accord with the current hardware version.

 **Note:**

Do not turn off the AP or press the **Reset** button while the firmware is being upgraded. The AP will reboot after the Upgrading has been finished.

4.14.3 Factory Defaults

Selecting **System Tools > Factory Default** allows you to restore the factory default settings for the device on the screen shown in Figure 4-57).

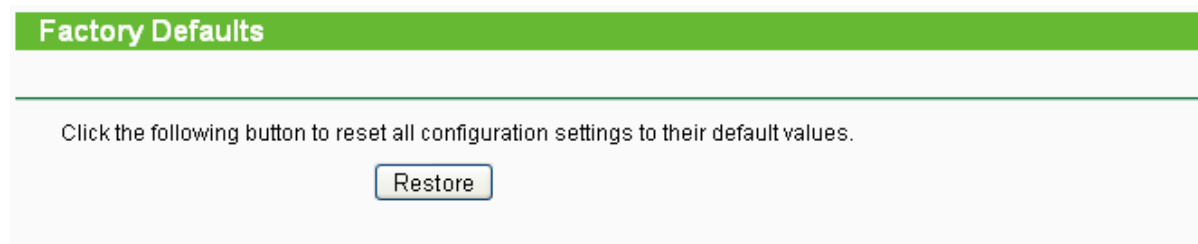

Figure 4-57 Restore Factory Default

Click **Restore** to reset all configuration settings to their default values.

- The default **User Name**: admin
- The default **Password**: admin
- The default **IP Address**: 192.168.1.254
- The default **Subnet Mask**: 255.255.255.0

Note:

All settings you have saved will be lost when the default settings are restored.

4.14.4 Backup & Restore

Selecting **System Tools > Backup & Restore** allows you to save all configuration settings to your local computer as a file or restore the device's configuration on the screen shown in Figure 4-58.

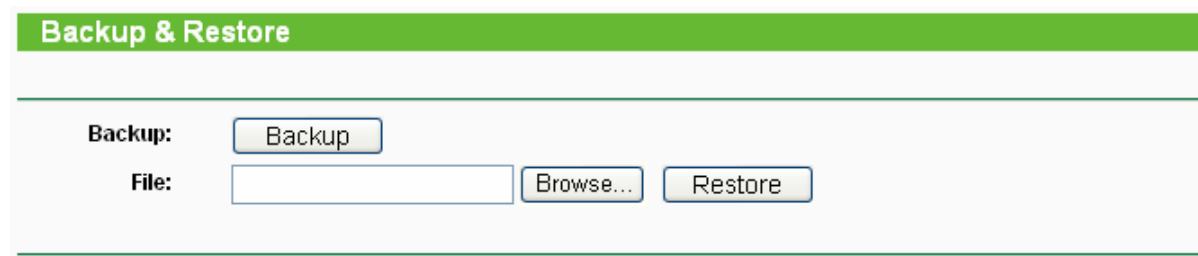

Figure 4-58 Save or Restore the Configuration

Click **Backup** to save a backup configuration file to your local computer.

To restore the AP's configuration, please take the following steps:

- Click **Browse** to find the location of configuration file which you want to restore.
- Click **Restore** to update the configuration with the file whose path is the one you have input or selected in the blank.

Note:

- 1) The current configuration will be covered by the uploading configuration file.
- 2) Wrong process will lead the device unmanaged.
- 3) The restoring process will last for 20 seconds and the AP will restart automatically. Do not power off the device during the process to avoid any damage.

4.14.5 Ping Watch Dog

Selecting **System Tools > Ping Watch Dog** allows you to continuously monitor the particular connection between the device to a remote host. It makes this device continuously ping a user defined IP address (it can be the internet gateway for example). If it is unable to ping under the user defined constraints, this device will automatically reboot.

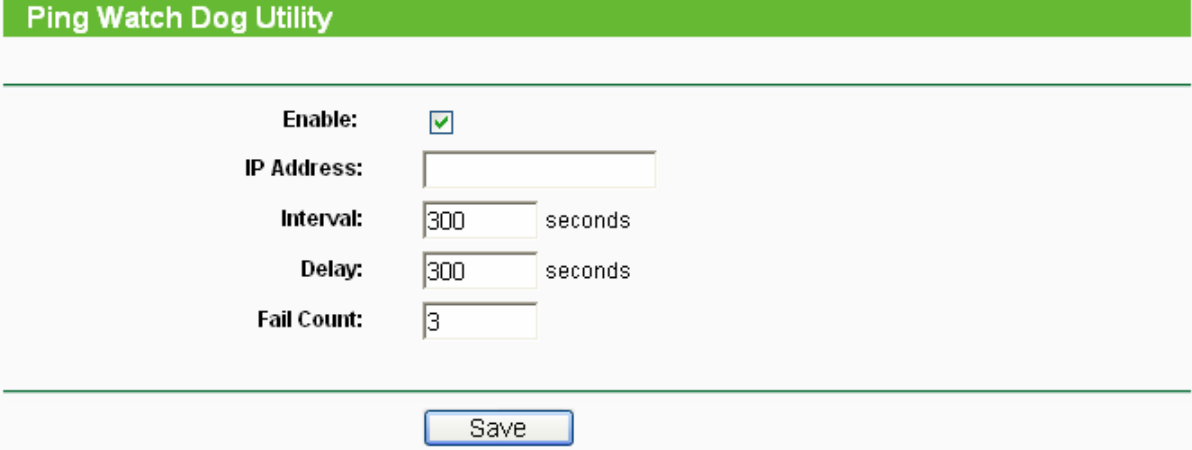

Ping Watch Dog Utility

Enable:

IP Address:

Interval: seconds

Delay: seconds

Fail Count:

Figure 4-59 Ping Watch Dog Utility

- **Enable** - Turn on/off Ping Watch Dog.
- **IP Address** - The IP address of the target host where the Ping Watch Dog Utility is sending ping packets.
- **Interval** - Time interval between two ping packets which are sent out continuously.
- **Delay** - Time delay before first ping packet is sent out when the device is restarted.
- **Fail Count** - Upper limit of the ping packet the device can drop continuously. If this value is overrun, the device will restart automatically.

Be sure to click the **Submit** button to make your settings in operation.

4.14.6 Speed Test

Selecting **System > Speed Test** allows you to test the connection speed to and from any reachable IP address on current network on the page as shown in Figure 4-60. The speed test is especially used when you are building wireless network between devices which are far away from each other. It should be used for the preliminary throughput estimation between two network devices. The estimation is rough. You can input the remote device's administrator Username and Password under **Advance options** to get a precise estimation if the remote device is **TL-WA5110G** too.

Simple Network Speed Test Utility

Destination IP:	<input type="text"/>
User:	<input type="text"/>
Password:	<input type="text"/>
Advanced options:	<input checked="" type="checkbox"/>
Direction:	transmit <input type="button" value="v"/>
Duration:	<input type="text" value="10"/> seconds
Data amount:	<input type="text"/> bytes

Test Results	
Tx:	N/A
Rx:	N/A

Figure 4-60 Speed Test

- **Destination IP** - The Remote device's IP address.
- **User** - Administrator password of the remote device. It should be filled correctly if you want to get a precise estimation. Otherwise, keep it clean.
- **Advanced options** - This is a switch to show advanced test options which are used only for precise estimation.

 **Note:**

If either User or Password is incorrect, we will take a basic test instead. In other words, none of the advance options you set will take effect.

- **Direction** - There are 3 options available for the traffic direction while estimating the throughput.
 - **transmit** - Estimate the outgoing throughput (TX).
 - **receive** - Estimate the ingoing throughput (RX).
 - **both** - Estimate the incoming (RX) first and then the outgoing (TX) afterwards.
- **Duration** - The value you specify here indicate how much time the test should last.
- **Data amount** - The maximal data amount to be sent out during the whole test.

 **Note:**

If both Duration and Data amount are specified, the test will stop after any of them is met.

Be sure to click the **Run Test** button to start a new test after you filled enough information. You can also stop a running test by click Stop Test button at any time.

4.14.7 Reboot

Selecting **System Tools > Reboot** allows you to reboot the device on the screen shown in Figure 4-61.

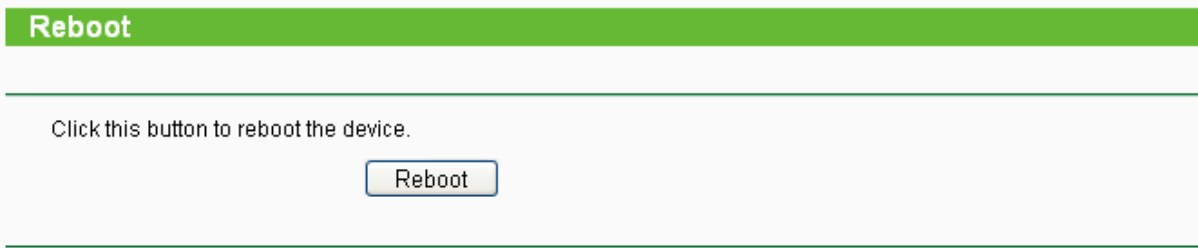

Figure 4-61 Reboot the AP

Click **Reboot** to reboot the AP.

Some settings of the AP will take effect only after rebooting, which include:

- Change LAN IP Address. (System will reboot automatically)
- Upgrade the firmware of the AP (system will reboot automatically).
- Restore the AP's settings to factory default (system will reboot automatically).
- DHCP service function.
- Static address assignment of DHCP server.

4.14.8 Password

Selecting **System Tools > Password** allows you to change the factory default user name and password of the device on the screen shown in Figure 4-62.

Figure 4-62 Password

It is strongly recommended that you change the factory default user name and password of the AP to more secure ones because they control access to the AP's web-based utility. All users who try to access the AP's web-based utility or Quick Setup will be prompted for the AP's user name and password.

 **Note:**

The new user name and password must not exceed 14 characters in length and must not include any space. Enter the new Password twice to confirm it.

Click **Save** when finished.

Click **Clear All** to clear all.

4.14.9 Syslog

Selecting **System Tools > System Log** allows you to query the Logs of the device on the screen

shown in Figure 4-63.

Index	Log Content
1	1963:System: Logs were cleared.

Time = 2006-01-01 8:32:43 1963s
H-Ver = WA5110G v1 0815311C : S-Ver = 4.4.2 Build 100408 Rel.54957n
L = 192.168.1.254 : M = 255.255.255.0
W1 = DHCP : W = 0.0.0.0 : M = 0.0.0.0 : G = 0.0.0.0
Free=5029, Busy=1, Bind=0, Inv=0/0, Bc=0/0, Dns=0, cl=96, fc=0/0, sq=0/0

Refresh Clear All

Figure 4-63 System Log

The AP can keep logs of all traffic. You can query the logs to find out what happened to the AP.

Click **Refresh** to refresh the logs.

Click **Clear All** to clear all the logs.

4.14.10 Statistics

The Statistics page (shown in Figure 4-64) displays the network traffic of each PC on the LAN, including total traffic and traffic of the last **Packets Statistic interval** seconds.

Current Statistics Status: **Disabled**

Packets Statistics Interval(5-60): 10 Seconds
 Auto-refresh

Sorted Rules: Sorted by IP Address

IP Address/ MAC Address	Total		Current			Modify
	Packets	Bytes	Packets	Bytes	ICMP Tx	
The current list is empty.						

Previous Next Page 1

Figure 4-64 Statistics

- **Current Statistics Status** - Enabled or Disabled. The default value is disabled. To enable, click the **Enable** button. If disabled, the function of DoS protection in Security settings will be ineffective.
- **Packets Statistics Interval** - The default value is 10. Select a value between 5 and 60

seconds from the pull-down list. The Packets Statistic interval indicates the time section of the packets statistic.

- **Sorted Rules** - Here displays sort as desired

Statistics Table:

IP Address		The IP Address displayed with statistics
Total	Packets	The total amount of packets received and transmitted by the router.
	Bytes	The total amount of bytes received and transmitted by the router.
Current	Packets	The total amount of packets received and transmitted in the last Packets Statistic interval seconds.
	Bytes	The total amount of bytes received and transmitted in the last Packets Statistic interval seconds.
	ICMP Tx	The total amount of the ICMP packets transmitted to WAN in the last Packets Statistic interval seconds.
	UDP Tx	The total amount of the UDP packets transmitted to WAN in the last Packets Statistic interval seconds.
	TCP SYN Tx	The total amount of the TCP SYN packets transmitted to WAN in the last Packets Statistic interval seconds.

Click the **Save** button to save the **Packets Statistic interval** value.

Click the **Auto-refresh** checkbox to refresh automatically.

Click the **Refresh** button to refresh immediately.

Chapter 5 AP Operation Mode

This Chapter describes how to configure some advanced settings for your Access Point through the web-based management page in AP operation mode.

5.1 Login

After your successful login, you can configure and manage the Access Point. There are eight main menus on the left of the Web-based management page. Submenus will be available after you click one of the main menus. The eight main menus are: **Status**, **Quick Setup**, **Operation Mode**, **Network**, **Wireless**, **DHCP**, **Wireless Settings** and **System Tools**. On the right of the Web-based management page, there are the detailed explanations and instructions for the corresponding page. To apply any settings you have altered on the page, please click **Save**.

The detailed explanations for each Web page key's function are listed below.

5.2 Status

Selecting **Status** will enable you to view the AP's current status and configuration, all of which is read-only

Status

Firmware Version: 4.4.2 Build 100408 Rel.54957n
Hardware Version: WA5110G v1 0815311C

Wired

MAC Address: 00-0A-EB-88-34-6E
IP Address: 192.168.1.254
Subnet Mask: 255.255.255.0

Wireless

Operating Mode: Client
Signal:
SSID: TP-LINK_88346E
Channel: 8
Mode: 11Mbps (802.11b)
MAC Address: 00-0A-EB-88-34-6E

Traffic Statistics

	Received	Sent
Bytes:	0	0
Packets:	0	0

System Up Time: 0 day(s) 01:05:25 Refresh

Figure 5-1

- **Wired** - This field displays the current settings or information for the Network, including the **MAC address**, **IP address** and **Subnet Mask**.
- **Wireless** - This field displays basic information or status for wireless function, including **Operating Mode**, **Signal**, **SSID**, **Channel**, **Mode** and **MAC Address**.
- **Traffic Statistics** - This field displays the AP's traffic statistics.
- **System Up Time** - The time of the AP running from it's powered on or reset.

5.3 Quick Setup

Please refer to Section [3.2: "Quick Setup"](#).

5.4 Operation Mode

The AP supports three operation modes, **AP Client Router**, **AP Router** and **AP**. Please select one you want. Click **Save** to save your choice.

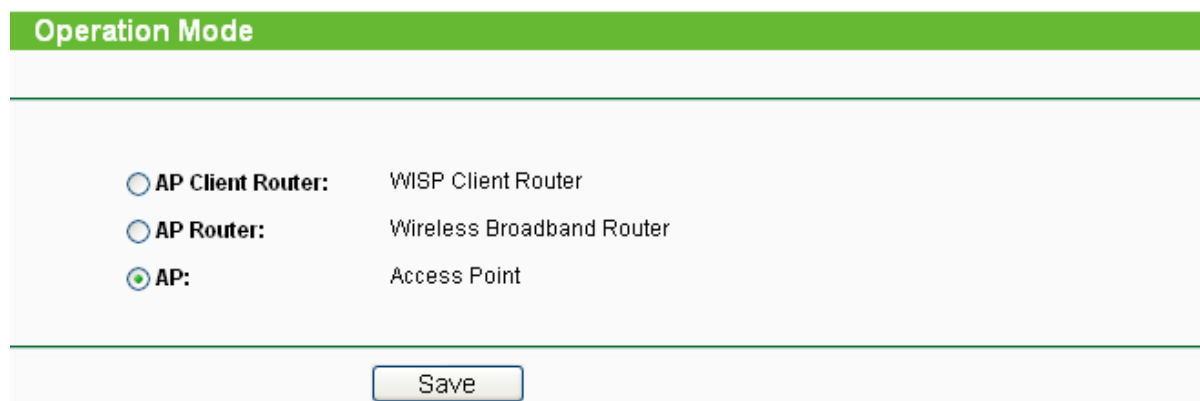

<input type="radio"/> AP Client Router:	WISP Client Router
<input type="radio"/> AP Router:	Wireless Broadband Router
<input checked="" type="radio"/> AP:	Access Point

Figure 5-2 Operation Mode

- **AP Client Router:** In this mode, the device enables multiusers to share Internet from WISP. The LAN port devices share the same IP from WISP through Wireless port. While connecting to WISP, the Wireless port works as a WAN port at AP Client Router mode. The Ethernet port acts as a LAN port.
- **AP Router:** In this mode, the device enables multiusers to share Internet via ADSL/Cable Modem. The wireless port share the same IP to ISP through Ethernet WAN port. The Wireless port acts the same as a LAN port while at AP Router mode.
- **AP:** In this mode, the device allows wireless communication devices to connect to a wireless network by using WIFI. The Ethernet port and the wireless port both work as LAN ports.

5.5 Network

The **Network** option allows you to customize your local network manually by changing the default settings of the AP.

Selecting **Network** will enable you to configure the IP parameters of Network on this page.

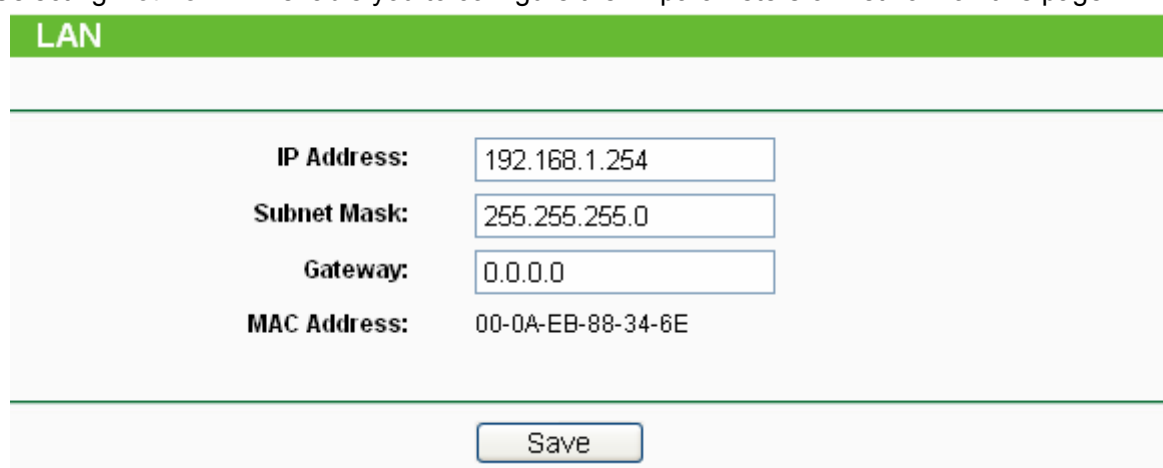

IP Address:	<input type="text" value="192.168.1.254"/>
Subnet Mask:	<input type="text" value="255.255.255.0"/>
Gateway:	<input type="text" value="0.0.0.0"/>
MAC Address:	00-0A-EB-88-34-6E

Figure 5-3 Network

- **IP Address** - Enter the IP address of your AP in dotted-decimal notation (factory default: 192.168.1.254).
- **Subnet Mask** - An address code that determines the size of the network. Normally use 255.255.255.0 as the subnet mask.

- **Gateway** - The gateway should be in the same subnet as your IP address.
- **MAC Address** - the physical address of the AP, as seen from the LAN. This value can't be changed.

 **Note:**

- 1) If you change the IP Address, you must use the new IP Address to log in the AP.
- 2) If the new LAN IP Address you set is not in the same subnet, the IP Address pool in the DHCP sever will not take effect unless they are re-configured.
- 3) The device will reboot automatically after clicking **Save**.

5.6 Wireless

The **Wireless** option, improving functionality and performance for wireless network, can help you make the AP an ideal solution for your wireless network.

Here you can create a wireless local area network just through a few settings. Basic Settings is used for the configuration of some basic parameters of the AP. Wireless Mode allows you to select the mode that AP works on. Security Settings provides three different security types to secure your data and thus provide greater security for your wireless network. MAC filtering allows you to control the access of wireless stations to the AP. Wireless Statistics shows you the statistics of current connected Wireless stations. Distance Setting is used to adjust the wireless range in outdoor conditions. Antenna Alignment shows how remote AP's signal strength changes while changes the antenna's direction. Throughput Monitor helps to watch wireless throughput information Wireless statistics enables you to get detailed information about the current connected wireless stations.

There are eight submenus under the Wireless menu (shown in Figure 5-4): **Basic Settings**, **Wireless Mode**, **Security Settings**, **MAC Filtering**, **Wireless Statistics**, **Distance Setting**, **Antenna Alignment** and **Throughput Monitor**. Click any of them, and you will be able to configure the corresponding function. The detailed explanations for each submenu are provided below.

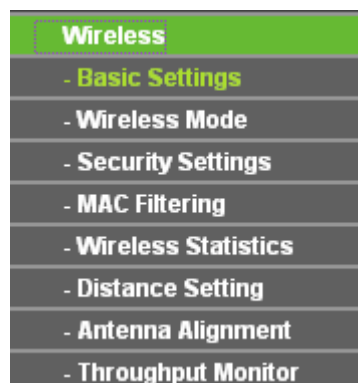

Figure 5-4 Wireless menu

5.6.1 Basic Settings

Selecting **Wireless > Basic Settings** will enable you to configure the basic settings for your wireless network on the screen below (Figure 5-5).

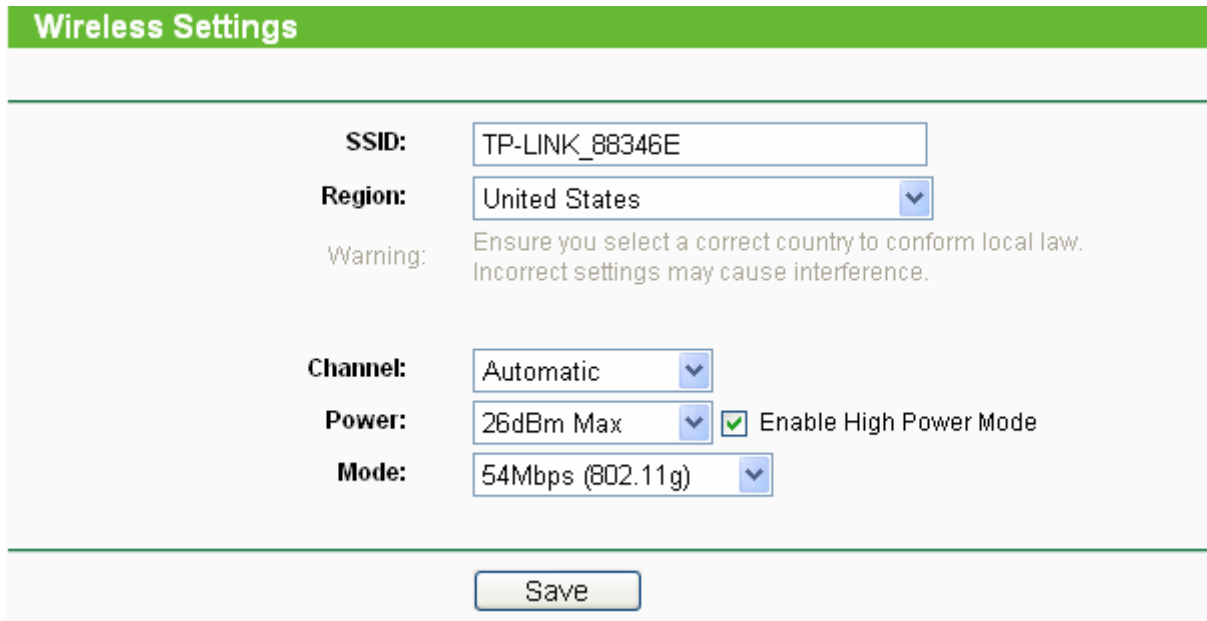
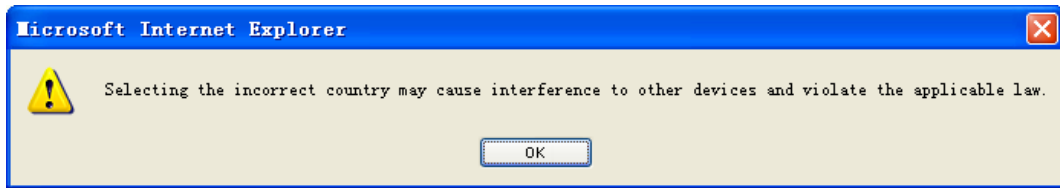

Figure 5-5 Wireless Settings in AP mode

- **SSID** (Set Service Identifier) - Identifies your wireless network name. Create a name up to 32 characters and make sure all wireless points in the wireless network with the same SSID. The default SSID is TP-LINK_XXXXXX (XXXXXX indicates the last unique six characters of each device's MAC address). This value is case-sensitive. For example, *TEST* is NOT the same as *test*.
- **Region** - Select your region from the pull-down list. This field specifies the region where the wireless function of the device can be used. It may be illegal to use the wireless function of the device in a region other than one of those specified in this field. If your country or region is not listed, please contact your local government agency for assistance.

Note:

- 3) The default region is United States. When you select your local region from the pull-down list, the dialog shown in Figure below appears. Click **OK**.
- 4) Restricted by local law regulations, version for North America does not have region selection option.



Note Dialog

- **Channel** - Determines the operating frequency to be used. It is not necessary to change the wireless channel unless you notice interference problems with another nearby access point.
- **Power** - The transmit power of the access point. The checkbox determines whether transmit power uses high power or not. Checking the **Enable High Power Mode** option will help improving the wireless performance, but may cause interference to other devices and violate the applicable law in some areas. It's not recommended that you enable high power mode in areas that applicable law will be violated.
- **Mode** - Select the desired wireless mode. The options are:
 - **54Mbps (802.11g)** - Both 802.11g and 802.11b wireless stations can connect to the

router.

- **11Mbps (802.11b)** - Only 802.11b wireless stations can connect to the router.

Be sure to click the **Save** button to save your settings on this page.

 **Note:**

The device will reboot automatically after you click the **Save** button.

5.6.2 Wireless Mode

Selecting **Wireless > Wireless Mode** will enable you to configure the wireless mode for your device as shown in Figure 5-6.

Wireless Mode Settings

Access Point

Enable SSID Broadcast

Client

Enable WDS

SSID:

MAC of AP:

Repeater

MAC of AP:

Universal Repeater

MAC of AP:

Bridge (Point to Point)

With AP Mode

MAC of AP:

Bridge (Point to Multi-Point)

With AP Mode

MAC of AP1:

MAC of AP2:

MAC of AP3:

MAC of AP4:

MAC of AP5:

MAC of AP6:

Note: The current security method may be invalid after changing the wireless mode.

Figure 5-6 Wireless Mode

 **Note:**

AP provides five operational modes: Access Point, Client, Repeater, Bridge (point to point), and Bridge (point to Multi-point).

- **Access Point** - Access Point mode allows wireless stations including AP clients to access the router.
 - **Enable SSID Broadcast** - If you select the **Enable SSID Broadcast** checkbox, the Wireless AP will broadcast its name (SSID) on the air.
- **Client** - In **Client** mode, AP will act as a wireless station to enable wired host(s) to access wireless AP.
 - **Enable WDS** - The AP client can connect to AP with WDS enabled or disabled. If WDS is enabled, all traffic from wired networks will be forwarded in the format of WDS frames consist of four address fields. If WDS is disabled, three address frames are used. If your AP supports WDS well, please select the option.
 - **SSID** - Enter the SSID of AP that you want to access. If you select the radio before **SSID**, the AP client will connect to AP according SSID.
 - **MAC of AP** - Enter the MAC address of AP that you want to access. If you select the radio before **MAC of AP**, the AP client will connect to AP according MAC address.
- **Repeater** - The **Repeater** mode is the AP with its own BSS and with WDS enabled that relays data to a root AP, to which it is associated. The wireless repeater relays signal between its stations and the root AP for greater wireless range. Please input the MAC address of root AP in the field of **MAC of AP**.
- **Universal Repeater** - The **Universal Repeater** mode is the AP with its own BSS and with WDS disabled that relays data to a root AP, to which it is associated. The wireless repeater relays signal between its stations and the root AP for greater wireless range. Please input the MAC address of root AP in the field of **MAC of AP**.

Note:

If the available AP can't support with WDS, you may select Client mode without WDS or Universal Repeater mode to associate with the AP.

Here is an example of how to configure wireless repeater. Please do the following:

1. Configure the Operating Mode of the TL-WA5110G 54Mbps High Power Wireless Access Point.
 - Configure AP1 on LAN Segment 1 in Access Point mode.
 - Configure AP2 in Repeater mode with the MAC address of its root AP (AP1).
 - Configure AP3 in Repeater mode with the MAC address of its root AP (AP2).

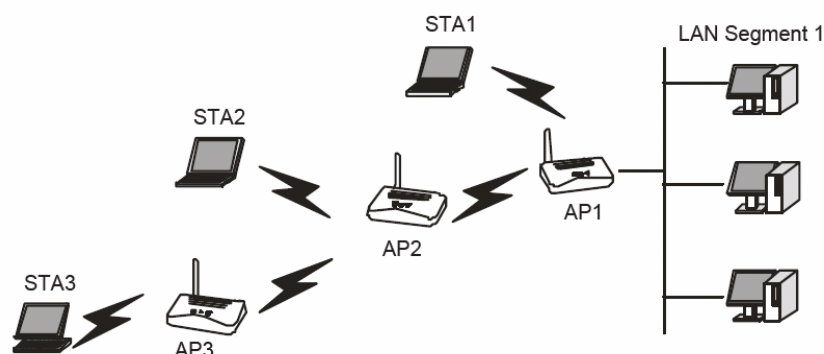

Figure 5-7 Wireless repeating

2. Verify the wireless security parameters for all access points, if any.

3. Verify connectivity across the LANs. A computer on any LAN segment should be able to connect to the Internet or share files and printers with any other PCs or servers connected to any of the three WLAN segments.

Note:

You can extend this repeating by adding up to 2 additional TL-WA5110G 54Mbps High Power Wireless Access Points configured in repeater mode. However, since Repeater configurations communicate in half-duplex mode, the bandwidth decreases as you add Repeaters to the network. Also, you can extend the range of the wireless network with wireless antenna accessories.

- **Bridge (Point to Point)** - This mode bridges the AP and another AP also in bridge mode to connect two wired LANs. Please input the MAC address of the other AP in the field of **MAC of AP**. AP function can startup also.
 - **With AP mode:** If you select this option, you AP will also support AP mode when it is in Bridge (Point to Point) mode.

Here is an example of how to configure Point-to-Point Bridge. Please do the following:

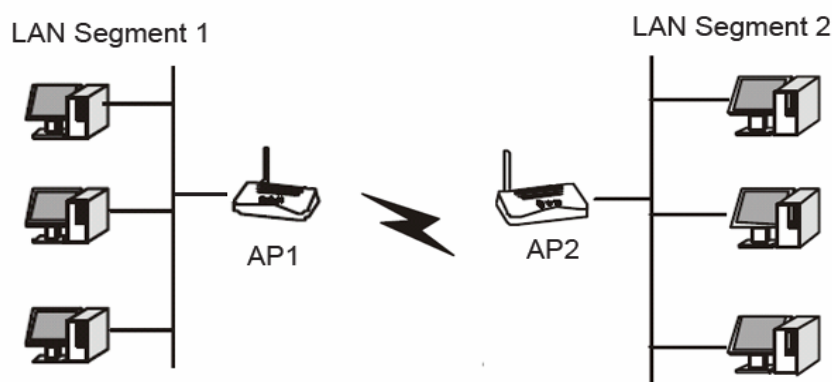

Figure 5-8 Point to Point Bridge

1. Configure the TL-WA5110G (AP1) on LAN Segment 1 in Point-to-Point Bridge mode.
2. Configure the TL-WA5110G (AP2) on LAN Segment 2 in Point-to-Point Bridge mode. AP1 must have AP2's MAC address in its MAC Address field and AP2 must have AP1's MAC address in its MAC Address field.
3. Configure and verify the following parameters for both access points:
 - Both use the same Channel and security settings if security is in use.

Verify connectivity across the LAN 1 and LAN 2. A computer on either LAN segment should be able to connect to the Internet or share files and printers of any other PCs or servers connected to LAN Segment 1 or LAN Segment 2.

- **Bridge (Point to Multi-Point)** - This mode bridges the AP and up to 6 APs also in bridge mode to connect two or more wired LANs. Please input the MAC address of other APs in the field of **MAC of AP1** to **MAC of AP6**. AP function can startup also.
 - **With AP mode:** If you select this option, you AP will also support AP mode when it is in Bridge (Point to Multi-Point) mode.

Here is an example of how to configure multi-point bridging. Please do the following:

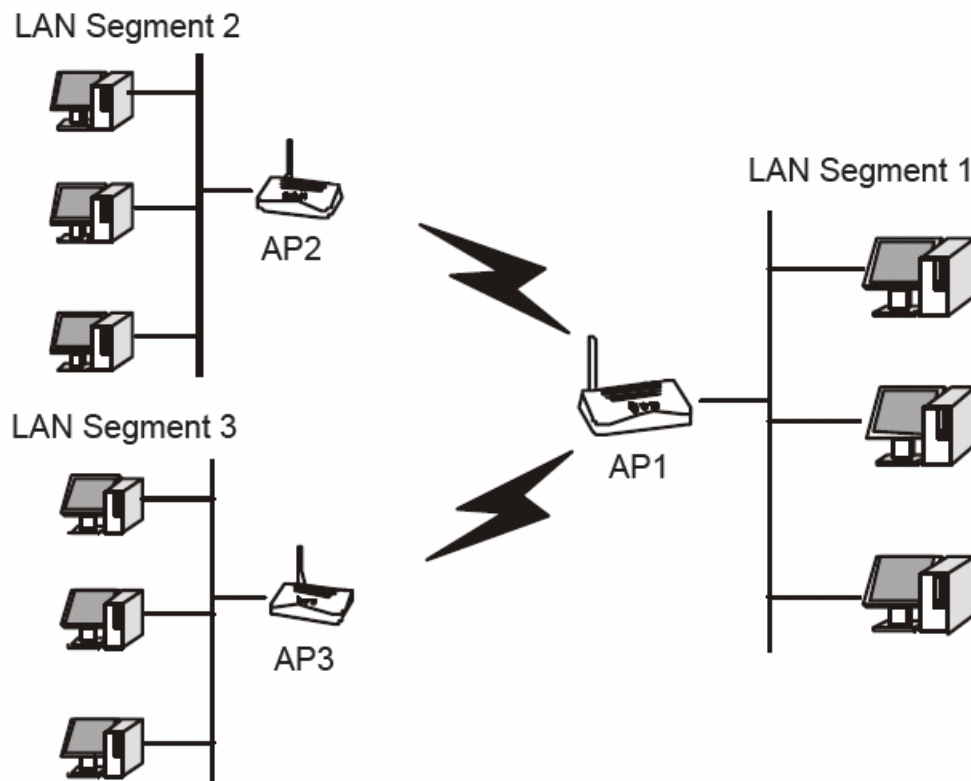

Figure 5-9 Point to Multi-point Bridge

1. Configure the Operating Mode of the TL-WA5110G 54Mbps High Power Wireless Access Points.
 - Because it is in the central location, configure TL-WA5110G (AP1) on LAN Segment 1 in Point-to-Multi-Point Bridge mode. The MAC addresses of AP2 and AP3 are required in AP1.
 - Configure TL-WA5110G (AP2) on LAN Segment 2 in Point-to-Point Bridge mode with the MAC Address of AP1.
 - Configure the TL-WA5110G (AP3) on LAN 3 in Point-to-Point Bridge mode with the MAC Address of AP1.
2. Verify the following parameters for all access points.
 - All TL-WA5110G Access Points use the same Channel, and security settings if any.
 - All Point-to-Point APs must have AP1's MAC address in its AP MAC address field, and AP1 must have all All Point-to-Point APs' MAC addresses.
3. Verify connectivity across the LANs.
 - A computer on any LAN segment should be able to connect to the Internet or share files and printers with any other PCs or servers connected to any of the three LAN segments.

Wireless stations will not be able to connect to the TL-WA5110G 54Mbps High Power Wireless Access Points in the illustration above. If you require wireless stations to access any LAN segment, you can add TL-WA5110G 54Mbps High Power Wireless Access Points configured in Wireless Access Point mode to any LAN segment.

Note:

- 1) You can extend this multi-point bridging by adding additional TL-WA5110Gs configured in Point-to-Point mode for each additional LAN segment. Furthermore, you can extend the

range of the wireless network with wireless antenna accessories.

- 2) To apply any settings you have altered on the page, please click the **Save** button, and wait the AP reboot automatically.

Click **Survey** will show the site list of scanning result shown as Figure 5-10.

AP List						
ID	BSSID	SSID	Signal	Channel	Security	Choose
1	00-24-17-84-A1-05	Thomson9AFD48	5 dB	11	OFF	Connect
2	94-0C-6D-2F-52-7C	TP-LINK_2F527C	26 dB	2	OFF	Connect
3	00-1D-0F-01-06-18	TP-LINK_010618	7 dB	4	OFF	Connect
4	00-19-E0-94-51-F4	TP-LINK	10 dB	1	ON	Connect
5	00-27-19-C4-B9-84		26 dB	4	ON	Connect

Figure 5-10 AP List

- **BSSID** -The BSSID of the AP, usually also the MAC address of the AP.
- **SSID** -The SSID of the AP.
- **Signal** -The signal received from the AP.
- **Channel** -The channel the AP works in.
- **Security** -The AP communicates in privacy.
- **Choose** - Click to connect to the corresponding AP.

5.6.3 Security Settings

Selecting **Wireless > Security Settings** will enable you to configure the security of the wireless network for your device as shown in Figure 5-11.

Disable Security

WEP

Type: Automatic

WEP Key Format: Hexadecimal

Key Selected	WEP Key	Key Type
Key 1: <input checked="" type="radio"/>		Disabled
Key 2: <input type="radio"/>		Disabled
Key 3: <input type="radio"/>		Disabled
Key 4: <input type="radio"/>		Disabled

WPA/WPA2

Version: Automatic

Encryption: Automatic

Radius Server IP:

Radius Port: 1812 (1-65535, 0 stands for default port 1812)

Radius Password:

Group Key Update Period: 86400 (in second, minimum is 30, 0 means no update)

WPA-PSK/WPA2-PSK

Version: Automatic

Encryption: Automatic

PSK Passphrase:

(The Passphrase is between 8 and 63 characters long)

Group Key Update Period: 86400 (in second, minimum is 30, 0 means no update, only be valid in AP mode.)

Note: Some security mode can not be selected since it can not be supported by the current wireless mode.

Figure 5-11 Wireless Security

- **Disable Security** - The wireless security function can be enabled or disabled. If disabled, the wireless stations will be able to connect the device without encryption. It is recommended strongly that you choose one of following options to enable security.
- **WEP** - Select 802.11 WEP security.
 - **Type** - You can select one of following types,
 - 1) **Automatic** - Select **Shared Key** or **Open System** authentication type automatically based on the wireless station's capability and request.
 - 2) **Shared Key** - Select 802.11 Shared Key authentication.
 - 3) **Open System** - Select 802.11 Open System authentication.

- **WEP Key Format** - You can select **ASCII** or **Hexadecimal** format. ASCII format stands for any combination of keyboard characters in the specified length. Hexadecimal format stands for any combination of hexadecimal digits (0-9, a-f, A-F) in the specified length.
- **WEP Key** - Select which of the four keys will be used and enter the matching WEP key information for your network in the selected key radio button. These values must be identical on all wireless stations in your network.
- **Key Type** - You can select the WEP key length (**64-bit**, or **128-bit**, or **152-bit**.) for encryption. "Disabled" means this WEP key entry is invalid.
 - 1) For **64-bit** encryption - You can enter 10 hexadecimal digits (any combination of 0-9, a-f, A-F, zero key is not permitted) or 5 ASCII characters.
 - 2) For **128-bit** encryption - You can enter 26 hexadecimal digits (any combination of 0-9, a-f, A-F, zero key is not permitted) or 13 ASCII characters.
 - 3) For **152-bit** encryption - You can enter 32 hexadecimal digits (any combination of 0-9, a-f, A-F, zero key is not permitted) or 16 ASCII characters.

 **Note:**

If you do not set the key, the wireless security function is still disabled even if you have selected Shared Key as Authentication Type.

- **WPA/WPA2** - Select WPA/WPA2 based on Radius Server.
 - **Version** - You can select one of following versions,
 - 1) **Automatic** - Select **WPA** or **WPA2** automatically based on the wireless station's capability and request.
 - 2) **WPA** - Wi-Fi Protected Access.
 - 3) **WPA2** - WPA version 2.
 - **Encryption** - You can select either **Automatic**, or **TKIP** or **AES**.
 - **Radius Server IP** - Enter the IP address of the Radius Server.
 - **Radius Port** - Enter the port that radius service used.
 - **Radius Password** - Enter the password for the Radius Server.
 - **Group Key Update Period** - Specify the group key update interval in seconds. The value can be either 0 or at least 30. Enter 0 to disable the update.
- **WPA-PSK/ WPA2-PSK** - Select WPA based on pre-shared passphrase.
 - **Version** - You can select one of following versions,
 - 1) **Automatic** - Select **WPA-PSK** or **WPA2-PSK** automatically based on the wireless station's capability and request.
 - 2) **WPA-PSK** - Pre-shared key of WPA.
 - 3) **WPA2-PSK** - Pre-shared key of WPA2.
 - **Encryption** - When you select **WPA-PSK** or **WPA2-PSK** for **Authentication Type** you can select either **Automatic**, or **TKIP** or **AES** as **Encryption**.
 - **PSK Passphrase** - You can enter a passphrase between 8 and 63 characters long.
 - **Group Key Update Period** - Specify the group key update interval in seconds. The value can be either 0 or at least 30. Enter 0 to disable the update.

Be sure to click the **Save** button to save your settings on this page.

 **Note:**

The device will reboot automatically after you click the **Save** button.

5.6.4 MAC Filtering

Selecting **Wireless > MAC Filtering** will allow you to set up some filtering rules to control wireless stations accessing the device, which depend on the station's MAC address on the following screen as shown Figure 5-12.

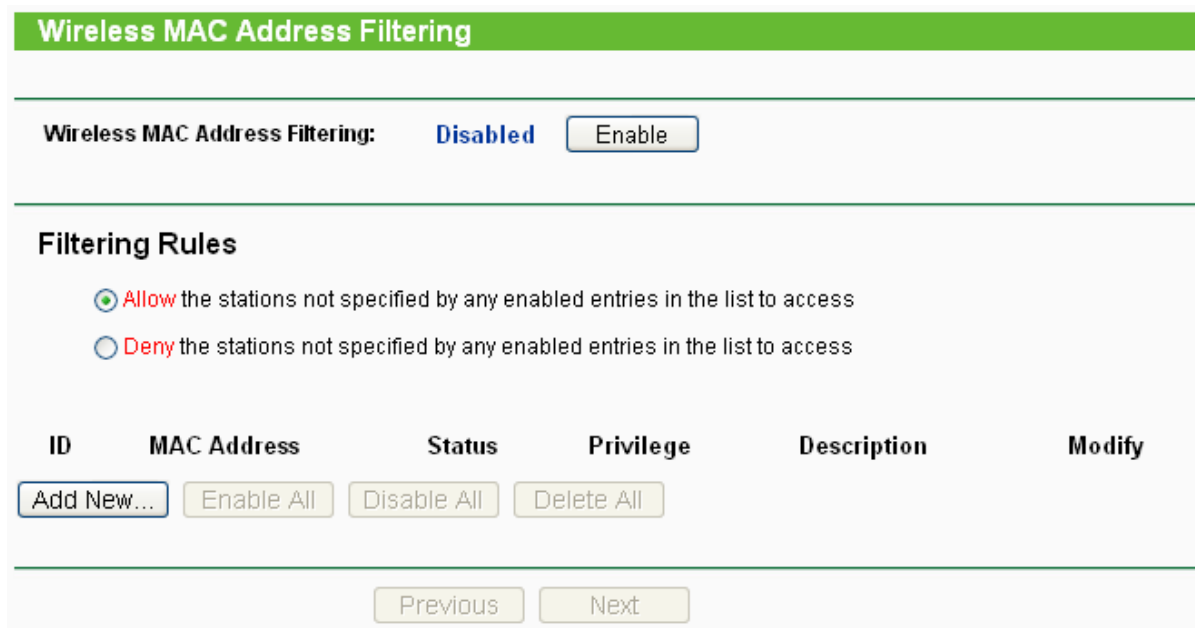

Wireless MAC Address Filtering

Wireless MAC Address Filtering: **Disabled**

Filtering Rules

Allow the stations not specified by any enabled entries in the list to access

Deny the stations not specified by any enabled entries in the list to access

ID	MAC Address	Status	Privilege	Description	Modify
<input type="button" value="Add New..."/>	<input type="button" value="Enable All"/>	<input type="button" value="Disable All"/>	<input type="button" value="Delete All"/>		

Figure 5-12 Wireless MAC address Filtering

The Wireless MAC Address Filtering feature allows you to control wireless stations accessing the router, which depend on the station's MAC addresses.

- **MAC Address** - The wireless station's MAC address that you want to access.
- **Status** - The status of this entry either **Enabled** or **Disabled**.
- **Privilege** - Select the privileges for this entry. You may select one of the following **Allow / Deny**.
- **Description** - A simple description of the wireless station.

 **Note:**

This function will not take effect if the wireless mode shown in Figure 5-6 is set to Client even though there are filtering entries.

To set up an entry, follow these instructions:

First, you must decide whether the unspecified wireless stations can access the router or not. If you desire that the unspecified wireless stations can access the router, please select the radio button **Allow the stations not specified by any enabled entries in the list to access**, otherwise, select the radio button **Deny the stations not specified by any enabled entries in the list to access**.

To Add a Wireless MAC Address filtering entry, click the **Add New...** button. The "**Add or Modify Wireless MAC Address Filtering entry**" page will appear, shown in Figure 5-13:

Add or Modify Wireless MAC Address Filtering entry

MAC Address:	<input type="text"/>
Description:	<input type="text"/>
Privilege:	<input type="text" value="allow"/>
Status:	<input type="text" value="Enabled"/>

Figure 5-13 Add or Modify Wireless MAC Address Filtering entry

To add or modify a MAC Address Filtering entry, follow these instructions:

1. Enter the appropriate MAC Address into the **MAC Address** field. The format of the MAC Address is XX-XX-XX-XX-XX-XX (X is any hexadecimal digit). For example: 00-0A-EB-B0-00-0B.
2. Enter a simple description of the wireless station in the **Description** field. For example: Wireless station A.
3. **Privilege** - Select the privileges for this entry, one of **Allow** / **Deny**.
4. **Status** - Select **Enabled** or **Disabled** for this entry on the **Status** pull-down list.
5. Click the **Save** button to save this entry.

To add additional entries, repeat steps 1-5.

To modify or delete an existing entry:

1. Click the **Modify** in the entry you want to modify. If you want to delete the entry, click the **Delete**.
2. Modify the information.
3. Click the **Save** button.

Click the **Enable All** button to make all entries enabled

Click the **Disabled All** button to make all entries disabled.

Click the **Delete All** button to delete all entries

Click the **Next** button to go to the next page and click the **Previous** button to return to the previous page.

For example: If you desire that the wireless station A with MAC address 00-0A-EB-00-07-BE be able to access the router. The wireless station B with MAC address 00-0A-EB-00-07-5F not be able to access the router, while all other wireless stations cannot access the router, you should configure the **Wireless MAC Address Filtering** list by following these steps:

1. Click the **Enable** button to enable this function.
2. Select the radio button: **Deny the stations not specified by any enabled entries in the list to access for Filtering Rules**.
3. Delete all or disable all entries if there are any entries already.
4. Click the **Add New...** button and enter the MAC address 00-0A-EB-00-07-BE in the **MAC Address** field, enter wireless station A in the **Description** field, select **Allow** in the **Privilege** pull-down list and select **Enabled** in the **Status** pull-down list. Click the **Save** and the **Return**

button.

5. Click the **Add New...** button and enter the MAC address 00-0A-EB-00-07-5F in the **MAC Address** field, enter wireless station B in the **Description** field, select **Deny** in the **Privilege** pull-down list and select **Enabled** in the **Status** pull-down list. Click the **Save** and the **Return** button..

The filtering rules that configured should be similar to the following list:

ID	MAC Address	Status	Privilege	Description	Modify
1	00-0A-EB-00-07-BE	Enabled	allow	Wireless Station A	Modify Delete
2	00-0A-EB-00-07-5F	Enabled	allow	Wireless Station B	Modify Delete

 **Note:**

- 1) If you select the radio button **Allow the stations not specified by any enabled entries in the list to access** for **Filtering Rules**, the wireless station B will still not be able to access the router, however, other wireless stations that are not in the list will be able to access the router.
- 2) If you enable the function and select the **Deny the stations not specified by any enabled entries in the list to access** for **Filtering Rules** and there are not any enable entries in the list, thus, no wireless stations can access the router.

5.6.5 Wireless Statistics

Selecting **Wireless > Wireless Statistics** will allow you to see the wireless transmission information in the following screen shown in Figure 5-14.

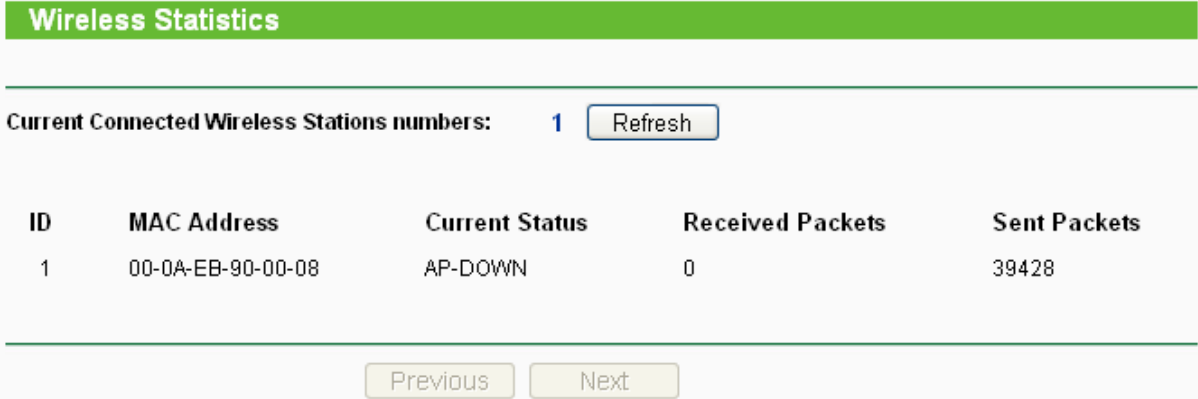

ID	MAC Address	Current Status	Received Packets	Sent Packets
1	00-0A-EB-90-00-08	AP-DOWN	0	39428

Figure 5-14 The router attached wireless stations

- **MAC Address** - The connected wireless station's MAC address
- **Current Status** - The connected wireless station's running status, one of STA-AUTH / STA-ASSOC / AP-UP / WPA / WPA-PSK /WPA2/WPA2-PSK/None
- **Received Packets** - Packets received by the station
- **Sent Packets** - Packets sent by the station

You cannot change any of the values on this page. To update this page and to show the current connected wireless stations, click on the **Refresh** button.

If the numbers of connected wireless stations go beyond one page, click the **Next** button to go to the next page and click the **Previous** button to return the previous page.

Note:

This page will be refreshed automatically every 5 seconds.

5.6.6 Distance Setting

Selecting **Wireless > Distance Setting** will allow you to adjust the wireless range in outdoor conditions as shown in Figure 5-15. This is a critical feature required for stabilizing outdoor links. Enter the distance of your wireless link and the software will optimize the frame ACK timeout value automatically.

Distance Setting

Adjust option: Automatic

Distance: (0-52.6km)

Note: Specify the distance value in kilometers, accurate to the first decimal place. If the distance is set too short or too long, it will result in poor connection and throughput performance, it is best to set the value at 110% of the real distance. If the AP is being used in an indoor setting, please select the indoor option.

Save

Figure 5-15 Distance Setting

- **Adjust option** - Keep the default setting if the AP is used for indoor environment. Or you can change the distance.
- **Distance:** Specify the distance value in kilometers, accurate to the first decimal place. If the distance is set too short or too long, it will result poor connection and throughput performance, it is best to set the value at 110% of the real distance. If the AP is being used in an indoor setting, please use the default setting.

Click **Save** to keep your settings.

5.6.7 Antenna Alignment

Selecting **Wireless > Antenna Alignment** will allow you to view how remote AP's signal strength changes while changing the antenna's direction.

Antenna Alignment

Remote RSSI: 14 dB

Signal Percent: 47%

RSSI RANGE: 30

Figure 5-16 Antenna Alignment

- **Remote AP RSSI** - Remote AP's signal strength value.
- **Signal Percent** - The ratio of RSSI to RSSI RANGE in percentage.

- **RSSI RANGE** - You can drag the slider bar to set or input the RSSI RANGE value. The slider bar allows the range of the meter to be either increased or reduced. If the range is reduced, the color change will be more sensitive to signal fluctuations. The slider bar actually changes an offset of the maximum indicator value scale.

 **Note:**

It only works after you have established connection to remote AP under client mode

5.6.8 Throughput Monitor

Selecting **Wireless > Throughput Monitor** will help to watch wireless throughput information in the following screen shown in Figure 5-17.

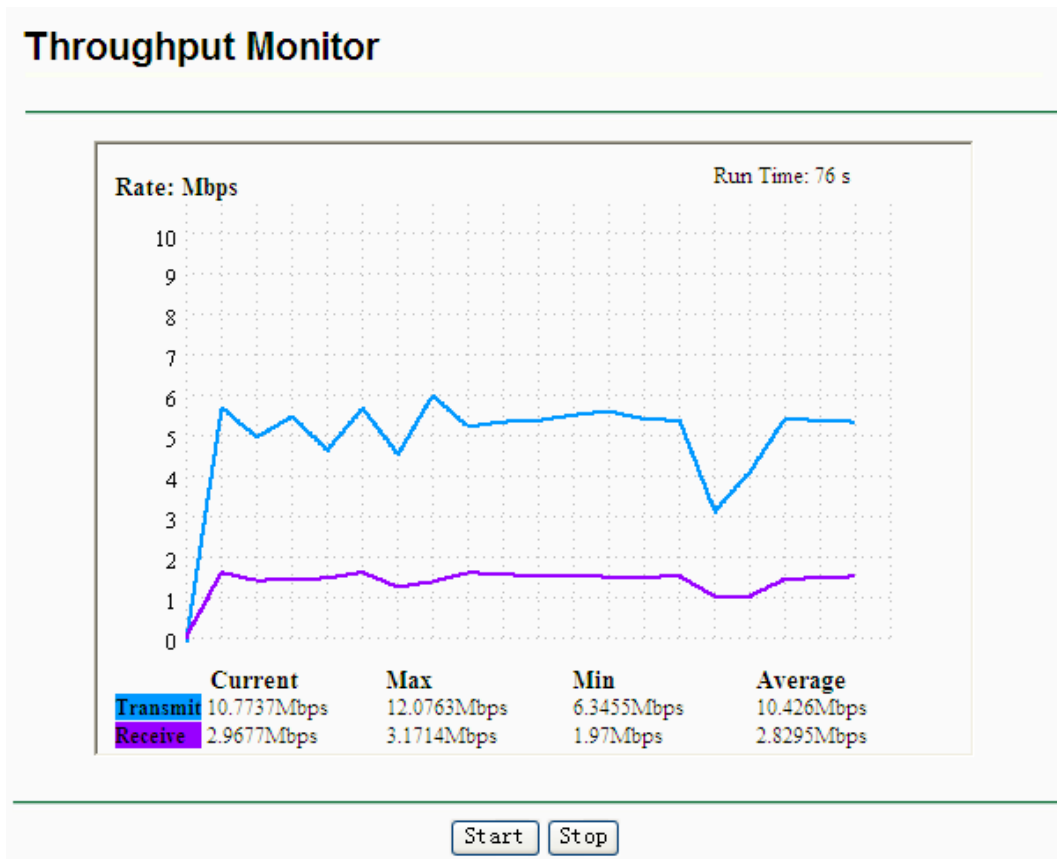

Figure 5-17 Wireless Throughput

- **Rate** - The Throughput unit.
- **Run Time** - How long this function is running.
- **Transmit** - Wireless transmit rate information.
- **Receive** - Wireless receive rate information.

Click the **Start** button to start wireless throughput monitor.

Click the **Stop** button to stop wireless throughput monitor.

5.7 DHCP

DHCP stands for Dynamic Host Configuration Protocol. The DHCP Server will automatically assign dynamic IP addresses to the computers on the network. This protocol simplifies network management and allows new wireless devices to receive IP addresses automatically without the need to manually assign new IP addresses.

There are three submenus under the DHCP menu (shown as Figure 5-18): **DHCP Settings**, **DHCP Clients List** and **Address Reservation**. Clicking any of them will enable you to configure the corresponding function. The detailed explanations for each submenu are provided below.

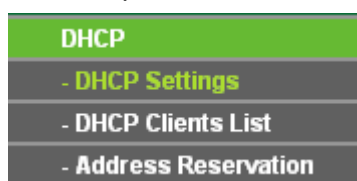

Figure 5-18 The DHCP menu

5.7.1 DHCP Settings

Selecting **DHCP > DHCP Settings** will enable you to set up the AP as a DHCP (Dynamic Host Configuration Protocol) server, which provides the TCP/IP configuration for all the PCs that are connected to the system on the LAN. The DHCP Server can be configured on the page (shown as Figure 5-19).

A screenshot of a web configuration page titled 'DHCP Settings'. The page has a green header bar with the title. Below the header, there are several configuration fields. The first field is 'DHCP Server:' with two radio buttons: 'Disable' (selected) and 'Enable'. The second field is 'Start IP Address:' with a text box containing '192.168.1.100'. The third field is 'End IP Address:' with a text box containing '192.168.1.199'. The fourth field is 'Address Lease Time:' with a text box containing '120' and a label 'minutes (1~2880 minutes, the default value is 120)'. The fifth field is 'Default Gateway:' with a text box containing '0.0.0.0' and a label '(optional)'. The sixth field is 'Default Domain:' with a text box and a label '(optional)'. The seventh field is 'Primary DNS:' with a text box containing '0.0.0.0' and a label '(optional)'. The eighth field is 'Secondary DNS:' with a text box containing '0.0.0.0' and a label '(optional)'. At the bottom of the page is a 'Save' button.

Figure 5-19 DHCP Settings

- **DHCP Server** - Selecting the radio button before **Disable/Enable** will disable/enable the DHCP server on your AP. The default setting is **Disable**. If you disable the Server, you must have another DHCP server within your network or else you must manually configure the computer.
- **Start IP Address** - This field specifies the first address in the IP Address pool. 192.168.1.100 is the default start IP address.
- **End IP Address** - This field specifies the last address in the IP Address pool. 192.168.1.199 is the default end IP address.
- **Address Lease Time** - Enter the amount of time for the PC to connect to the AP with its current assigned dynamic IP address. The time is measured in minutes. After the time is up, the PC will be automatically assigned a new dynamic IP address. The range of the time is 1 ~ 2880 minutes. The default value is 120 minutes.
- **Default Gateway (optional)** - Enter the IP address of the gateway for your LAN. The factory default setting is 0.0.0.0.
- **Default Domain (optional)** - Enter the domain name of the your DHCP server. You can

leave the field blank.

- **Primary DNS (optional)** - Enter the DNS IP address provided by your ISP. Consult your ISP if you don't know the DNS value. The factory default setting is 0.0.0.0.
- **Secondary DNS (optional)** - Enter the IP address of another DNS server if your ISP provides two DNS servers. The factory default setting is 0.0.0.0.

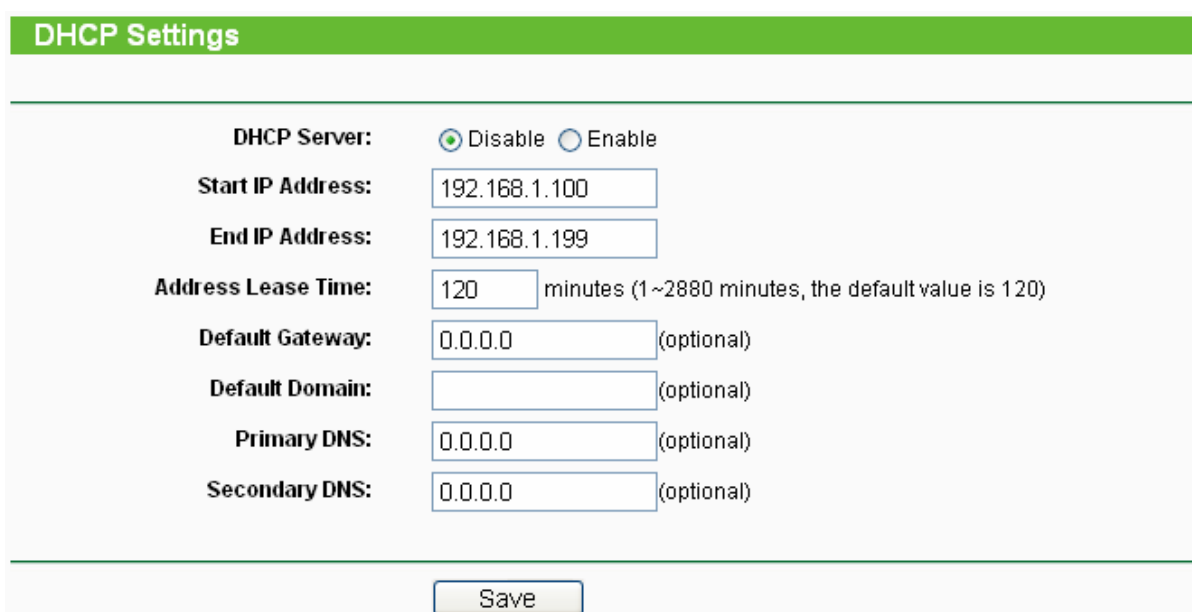
Click **Save** to save the changes.

 **Note:**

- 1) When the device is working on Dynamic IP mode, the DHCP Server function will be disabled.
- 2) To use the DHCP server function of the device, you should configure all computers in the LAN as "Obtain an IP Address automatically" mode. This function will not take effect until the device reboots.

5.7.2 DHCP Clients List

Selecting **DHCP > DHCP Clients List** will enable you to view the Client Name, MAC Address, Assigned IP and Lease Time for each DHCP Client attached to the device (Figure 5-20).

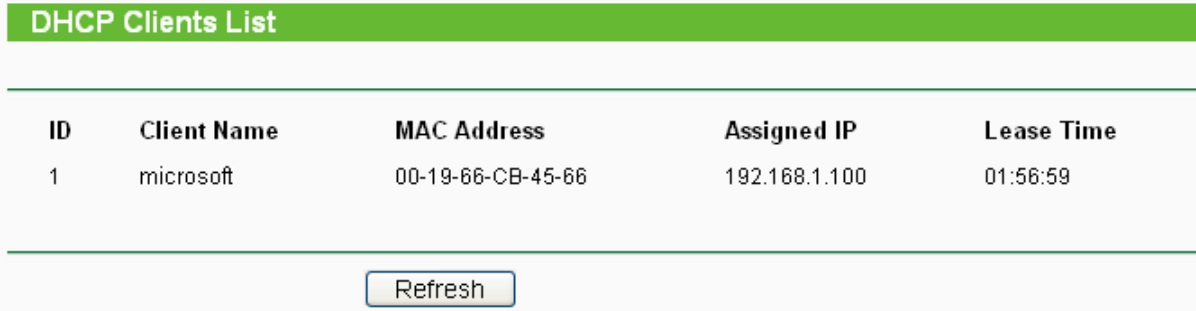

ID	Client Name	MAC Address	Assigned IP	Lease Time
1	microsoft	00-19-66-CB-45-66	192.168.1.100	01:56:59

Figure 5-20 DHCP Clients List

- **ID** - Here displays the index of the DHCP client.
- **Client Name** - Here displays the name of the DHCP client.
- **MAC Address** - Here displays the MAC address of the DHCP client.
- **Assigned IP** - Here displays the IP address that the AP has allocated to the DHCP client.
- **Lease Time** - Here displays the time of the DHCP client leased. Before the time is up, DHCP client will request to renew the lease automatically.

You cannot change any of the values on this page. To update this page and to show the current attached devices, click on the **Refresh** button.

5.7.3 Address Reservation

Selecting **DHCP > Address Reservation** will enable you to specify a reserved IP address for a PC on the LAN, so the PC will always obtain the same IP address each time when it accesses the AP. Reserved IP addresses should be assigned to servers that require permanent IP settings. The screen below is used for address reservation (shown in Figure 5-21).

Address Reservation				
ID	MAC Address	Reserved IP Address	Status	Modify
<input type="button" value="Add New..."/> <input type="button" value="Enable All"/> <input type="button" value="Disable All"/> <input type="button" value="Delete All"/>				
<input type="button" value="Previous"/> <input type="button" value="Next"/>				

Figure 5-21 Address Reservation

- **MAC Address** - Here displays the MAC address of the PC for which you want to reserve an IP address.
- **Reserved IP Address** - Here displays the IP address that the AP is reserved.
- **Status** - Here shows whether the entry is enabled or not
- **Modify** - To modify or delete an existing entry.

To Reserve IP addresses:

1. Click the **Add New** button in the page of **Address Reservation**, the following page (Figure 5-22) will display.
2. Enter the MAC address (the format for the MAC Address is XX-XX-XX-XX-XX-XX) and IP address in dotted-decimal notation of the computer you want to add.
3. Click the **Save** button after finish configuring.

Add or Modify an Address Reservation Entry	
MAC Address:	<input type="text" value="00-0A-EB-00-07-5F"/>
Reserved IP Address:	<input type="text" value="192.168.1.23"/>
Status:	<input type="text" value="Enabled"/> ▼
<input type="button" value="Save"/> <input type="button" value="Back"/>	

Figure 5-22 Add or Modify an Address Reservation Entry

To modify A Reserved IP address:

1. Select the reserved address entry to your needs and click **Modify**. If you wish to delete the entry, click **Delete**.
2. Click **Save** to keep your changes.

To delete all Reserved IP addresses:

1. Click **Clear All**.

Click **Next** to go to the next page and Click **Previous** to return the previous page.

Note:

The changes won't take effect until the device reboots.

5.8 Wireless settings

Selecting **Wireless Settings** will allow you to do some advanced settings for the device in the following screen shown in Figure 5-23.

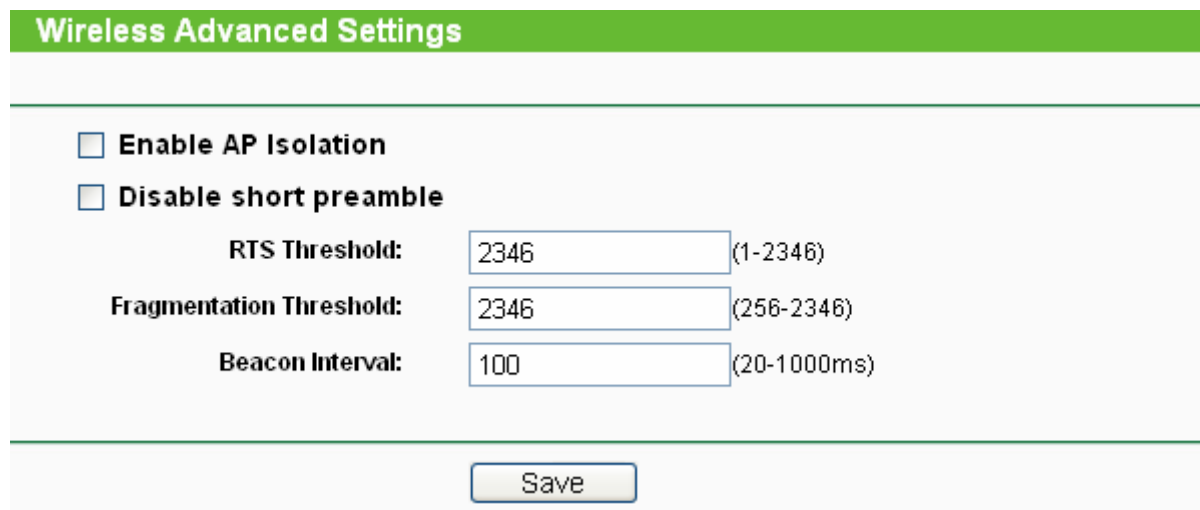

Wireless Advanced Settings

Enable AP Isolation

Disable short preamble

RTS Threshold: (1-2346)

Fragmentation Threshold: (256-2346)

Beacon Interval: (20-1000ms)

Figure 5-23 Wireless settings

- **Enable AP Isolation** - Isolate all connected wireless stations so that wireless stations can not access each other through WLAN. This option is available only for AP mode.
- **Disable short preamble** - Disable short preamble and use long preamble only. 802.11b mode supports only long preamble and this parameter will be ignored. It is recommended that you do not change these settings.
- **RTS Threshold** - RTS/CTS Threshold, the packet size that is used to determine if RTS/CTS should be sent.
- **Fragmentation Threshold** - The maximum packet size used for fragmentation.
- **Beacon Interval** - The interval time between two successive beacons.

5.9 System Tools

System Tools option helps you to optimize the configuration of your device. You can upgrade the AP to the latest version of firmware as well as backup or restore the AP's configuration files. Ping Watch Dog can help to continuously monitor a particular connection to a remote host. Speed Test helps to test the connection speed to and from any reachable IP address on current network, especially when we are building wireless network between devices which are far away from each other. It's suggested that you change the default password to a more secure one because it controls access to the device's web-based management page. Besides, you can find out what happened to the system in System Log.

There are eight submenus under the **System Tools** menu (shown as Figure 5-24): **Firmware**, **Factory Defaults**, **Backup & Restore**, **Ping Watch Dog**, **Speed Test**, **Reboot**, **Password** and **Syslog**. Clicking any of them will enable you to configure the corresponding function. The detailed explanations for each submenu are provided below.



Figure 5-24 The System Tools menu

5.9.1 Firmware

Selecting **System Tools** > **Firmware** allows you to upgrade the latest version of firmware for the device on the screen shown in Figure 5-25.

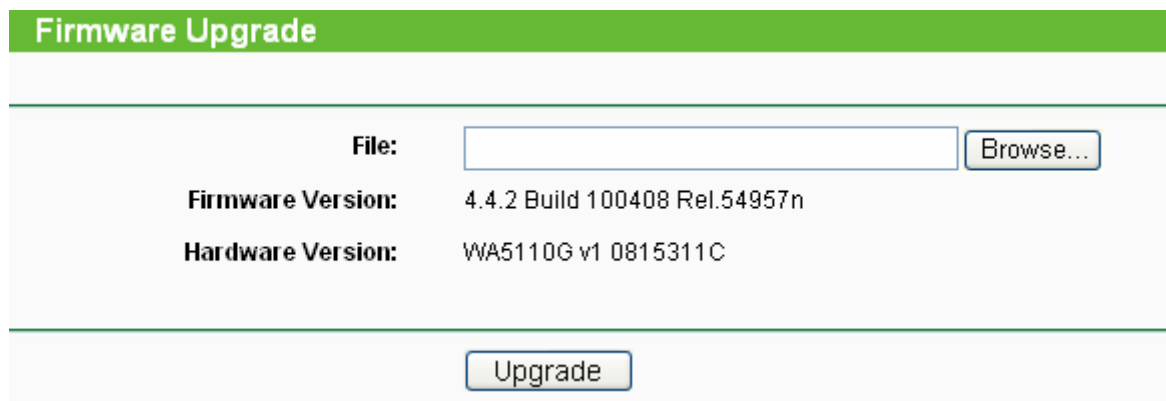

Figure 5-25 Firmware Upgrade

New firmware versions are posted at <http://www.tp-link.com> and can be downloaded for free. There is no need to upgrade the firmware unless the new firmware has a new feature you want to use. However, when experiencing problems caused by the AP itself, you can try to upgrade the firmware.

 **Note:**

Before upgrading the AP's firmware, you should write down some of your customized settings to avoid losing important configuration settings of AP.

To upgrade the AP's firmware, please take the following steps:

1. Download a more recent firmware upgrade file from the TP-LINK website (<http://www.tp-link.com>).
 2. Click **Browse...** to view the folders and select the downloaded file.
 3. Click **Upgrade**.
- **Firmware Version** - Displays the current firmware version.
 - **Hardware Version** - Displays the current hardware version. The upgrade file must accord with the current hardware version.

 **Note:**

Do not turn off the AP or press the Reset button while the firmware is being upgraded. The AP will reboot after the Upgrading has been finished.

5.9.2 Factory Defaults

Selecting **System Tools > Factory Default** allows you to restore the factory default settings for the device on the screen shown in Figure 5-26.

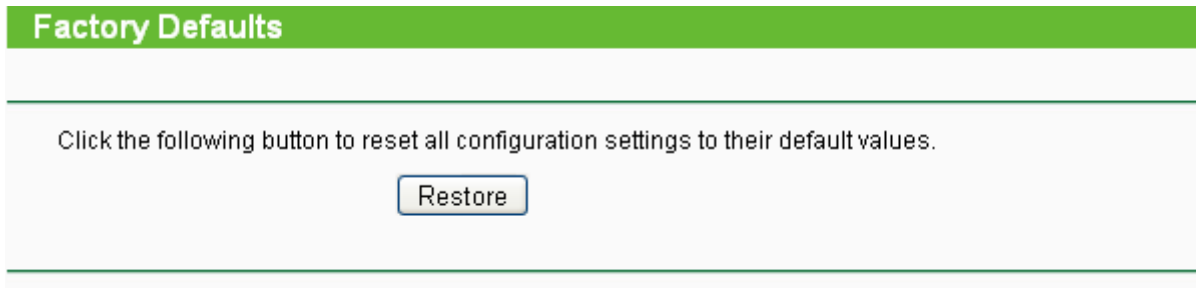

Figure 5-26 Restore Factory Default

Click **Restore** to reset all configuration settings to their default values.

- The default **User Name**: admin
- The default **Password**: admin
- The default **IP Address**: 192.168.1.254
- The default **Subnet Mask**: 255.255.255.0

Note:

All settings you have saved will be lost when the default settings are restored.

5.9.3 Backup & Restore

Selecting **System Tools > Backup & Restore** allows you to save all configuration settings to your local computer as a file or restore the device's configuration on the screen shown in Figure 5-27.

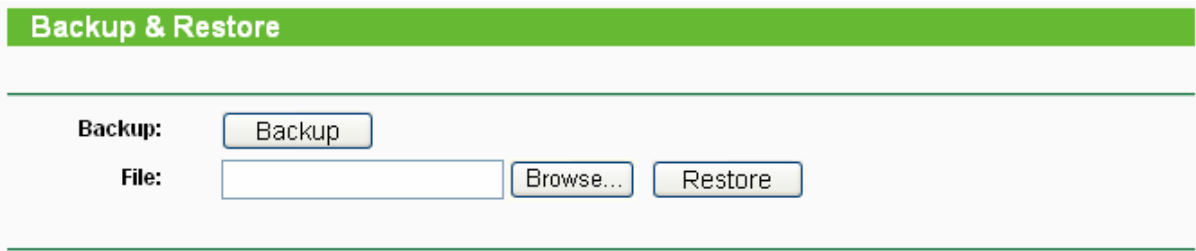

Figure 5-27 Save or Restore the Configuration

Click **Backup** to save a backup configuration file to your local computer.

To restore the AP's configuration, please take the following steps:

- Click **Browse** to find the location of configuration file which you want to restore.
- Click **Restore** to update the configuration with the file whose path is the one you have input or selected in the blank.

Note:

- 1) The current configuration will be covered by the uploading configuration file.
- 2) Wrong process will lead the device unmanaged.
- 3) The restoring process will last for 20 seconds and the AP will restart automatically. Do not power off the device during the process to avoid any damage.

5.9.4 Ping Watch Dog

Selecting **System Tools > Ping Watch Dog** allows you to continuously monitor the particular connection between the device to a remote host. It makes this device continuously ping a user defined IP address (it can be the internet gateway for example). If it is unable to ping under the user defined constraints, this device will automatically reboot.

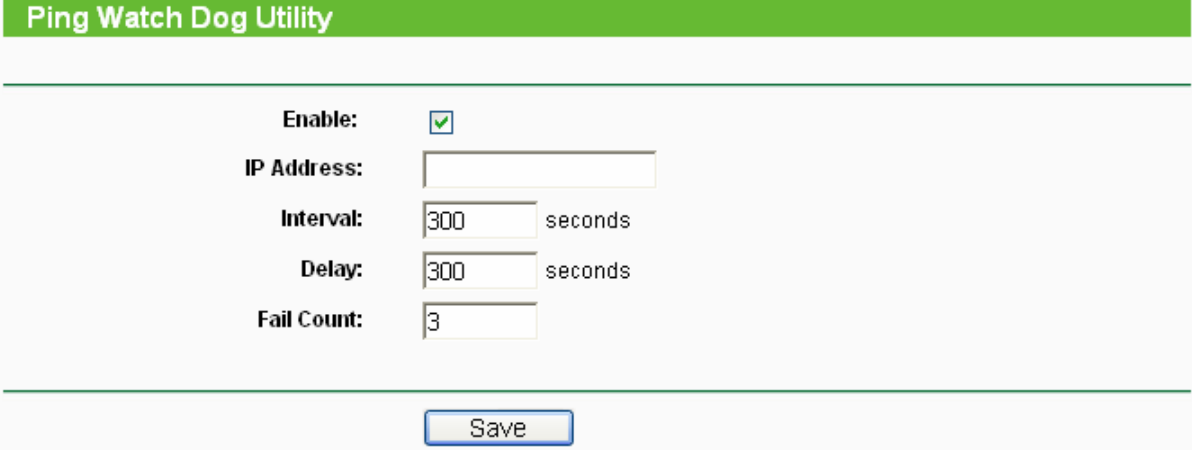

Ping Watch Dog Utility

Enable:

IP Address:

Interval: seconds

Delay: seconds

Fail Count:

Figure 5-28 Ping Watch Dog Utility

- **Enable** - Turn on/off Ping Watch Dog.
- **IP Address** - The IP address of the target host where the Ping Watch Dog Utility is sending ping packets.
- **Interval** - Time interval between two ping packets which are sent out continuously.
- **Delay** - Time delay before first ping packet is sent out when the device is restarted.
- **Fail Count** - Upper limit of the ping packet the device can drop continuously. If this value is overrun, the device will restart automatically.

Be sure to click the **Submit** button to make your settings in operation.

5.9.5 Speed Test

Selecting **System > Speed Test** allows you to test the connection speed to and from any reachable IP address on current network on the page as shown in Figure 5-29. The speed test is especially used when you are building wireless network between devices which are far away from each other. It should be used for the preliminary throughput estimation between two network devices. The estimation is rough. You can input the remote device's administrator Username and Password under **Advance options** to get a precise estimation if the remote device is **TL-WA5110G** too.

Simple Network Speed Test Utility

Destination IP:	<input type="text"/>
User:	<input type="text"/>
Password:	<input type="text"/>
Advanced options:	<input checked="" type="checkbox"/>
Direction:	transmit <input type="button" value="v"/>
Duration:	<input type="text" value="10"/> seconds
Data amount:	<input type="text"/> bytes

Test Results	
Tx:	N/A
Rx:	N/A

Figure 5-29 Speed Test

- **Destination IP** - The Remote device's IP address.
- **User** - Administrator password of the remote device. It should be filled correctly if you want to get a precise estimation. Otherwise, keep it clean.
- **Advanced options** - This is a switch to show advanced test options which are used only for precise estimation.

 **Note:**

If either User or Password is incorrect, we will take a basic test instead. In other words, none of the advance options you set will take effect.

- **Direction** - There are 3 options available for the traffic direction while estimating the throughput.
 - **transmit** - Estimate the outgoing throughput (TX).
 - **receive** - Estimate the ingoing throughput (RX).
 - **both** - Estimate the incoming (RX) first and then the outgoing (TX) afterwards.
- **Duration** - The value you specify here indicate how much time the test should last.
- **Data amount** - The maximal data amount to be sent out during the whole test.

 **Note:**

If both Duration and Data amount are specified, the test will stop after any of them is met.

Be sure to click the **Run Test** button to start a new test after you filled enough information. You can also stop a running test by click Stop Test button at any time.

5.9.6 Reboot

Selecting **System Tools > Reboot** allows you to reboot the device on the screen shown in Figure 5-30.

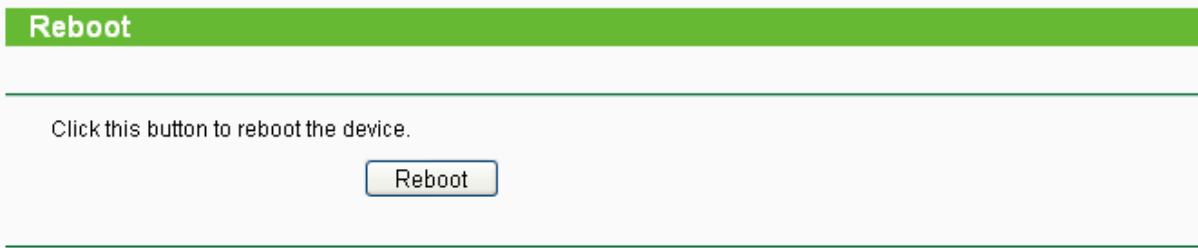

Figure 5-30 Reboot the AP

Click **Reboot** to reboot the AP.

Some settings of the AP will take effect only after rebooting, which include:

- Change LAN IP Address. (System will reboot automatically)
- Upgrade the firmware of the AP (system will reboot automatically).
- Restore the AP's settings to factory default (system will reboot automatically).
- DHCP service function.
- Static address assignment of DHCP server.

5.9.7 Password

Selecting **System Tools > Password** allows you to change the factory default user name and password of the device on the screen shown in Figure 5-31.

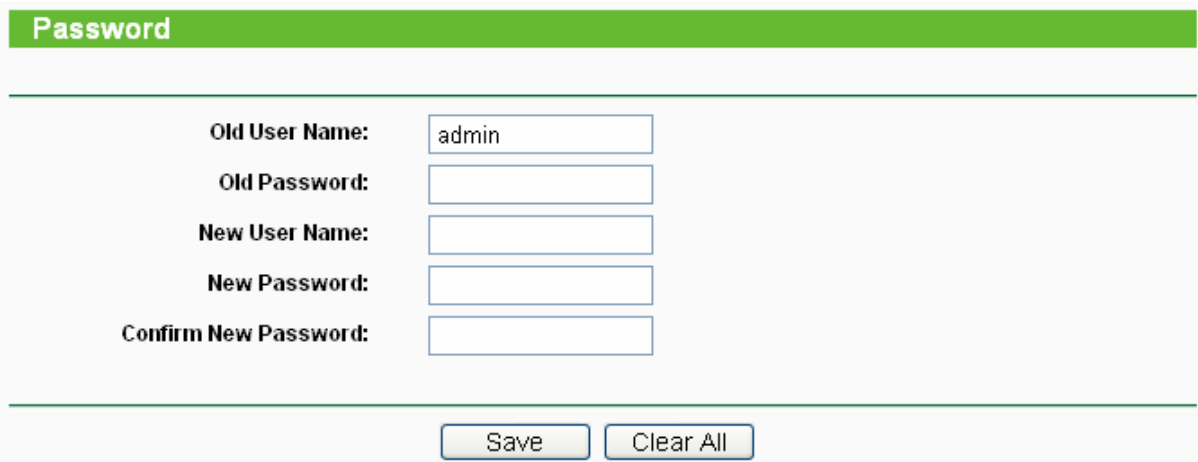

Figure 5-31 Password

It is strongly recommended that you change the factory default user name and password of the AP to more secure ones because they control access to the AP's web-based utility. All users who try to access the AP's web-based utility or Quick Setup will be prompted for the AP's user name and password.

 **Note:**

The new user name and password must not exceed 14 characters in length and must not include any space. Enter the new Password twice to confirm it.

Click **Save** when finished.

Click **Clear All** to clear all.

5.9.8 Syslog

Selecting **System Tools > System Log** allows you to query the Logs of the device on the screen

shown in Figure 4-63.

Index	Log Content
1	0000:System: The device initialization succeeded.

H-Ver = WA5110G v1 0815311C : S-Ver = 4.4.2 Build 100408 Rel.54957n
L = 192.168.1.254 : M = 255.255.255.0

Refresh Clear All

Figure 5-32 System Log

The AP can keep logs of all traffic. You can query the logs to find out what happened to the AP.

Click **Refresh** to refresh the logs.

Click **Clear All** to clear all the logs.

Appendix A: FAQ

1. How do I configure the router to access the Internet by ADSL users?

- 1) First, configure the ADSL Modem configured in RFC1483 bridge model.
- 2) Connect the Ethernet cable from your ADSL Modem to the WAN port on the router. The telephone cord plugs into the Line port of the ADSL Modem.
- 3) Login to the router, click the "Network" menu on the left of your browser, and click "WAN" submenu. On the WAN page, select "PPPoE" for WAN Connection Type. Type user name in the "User Name" field and password in the "Password" field, finish by clicking "Connect".

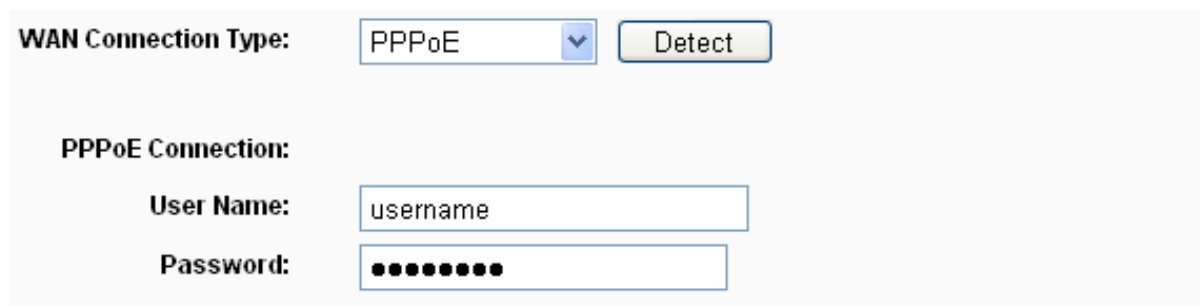

WAN Connection Type:

PPPoE Connection:

User Name:

Password:

Figure A-1 PPPoE Connection Type

- 4) If your ADSL lease is in "pay-according-time" mode, select "Connect on Demand" or "Connect Manually" for the Internet connection mode. Type an appropriate number for "Max Idle Time" to avoid wasting paid time. Otherwise, you can select "Auto-connecting" for the Internet connection mode.

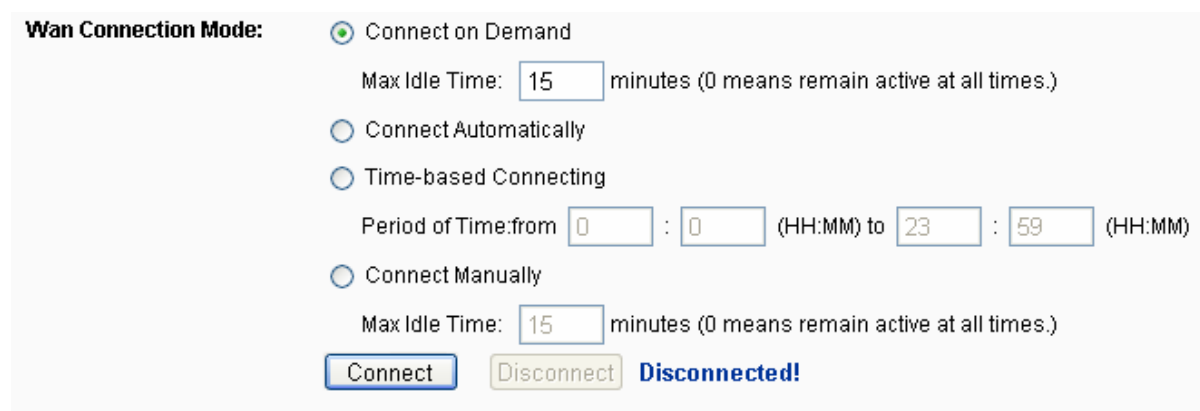

Wan Connection Mode:

Connect on Demand
Max Idle Time: minutes (0 means remain active at all times.)

Connect Automatically

Time-based Connecting
Period of Time: from : (HH:MM) to : (HH:MM)

Connect Manually
Max Idle Time: minutes (0 means remain active at all times.)

Disconnected!

Figure A-2 PPPoE Connection Mode

Note:

- 1) Sometimes the connection cannot be disconnected although you specify a time to Max Idle Time, since some applications is visiting the Internet continually in the background.
- 2) If you are a Cable user, please configure the router following the above steps.

2. How do I configure the router to access the Internet by Ethernet users?

- 1) Login to the router, click the "Network" menu on the left of your browser, and click "WAN" submenu. On the WAN page, select "Dynamic IP" for "WAN Connection Type", finish by clicking "Save".
- 2) Some ISPs require that you register the MAC Address of your adapter, which is connected to your cable/DSL Modem during installation. If your ISP requires MAC register, login to the

router and click the "Network" menu link on the left of your browser, and then click "MAC Clone" submenu link. On the "MAC Clone" page, if your PC's MAC address is proper MAC address, click the "Clone MAC Address" button and your PC's MAC address will fill in the "WAN MAC Address" field. Or else, type the MAC Address into the "WAN MAC Address" field. The format for the MAC Address is XX-XX-XX-XX-XX-XX. Then click the "Save" button. It will take effect after rebooting.

Figure A-3 MAC Clone

3. I want to use Netmeeting, what do I need to do?

- 1) If you start Netmeeting as a sponsor, you don't need to do anything with the router.
- 2) If you start as a response, you need to configure Virtual Server or DMZ Host.
- 3) How to configure Virtual Server: Login to the router, click the "Forwarding" menu on the left of your browser, and click "Virtual Servers" submenu. On the "Virtual Server" page, click **Add New**, then on the "Add or Modify a Virtual Server" page, enter "1720" into the blank behind the "Service Port", and your IP address behind the IP Address, assuming 192.168.1.169 for an example, remember to "Enable" and "Save".

Figure A-4 Virtual Servers

Figure A-5 Add or Modify a Virtual server Entry

Note:

Your opposite side should call your WAN IP, which is displayed on the “Status” page.

- 4) How to enable DMZ Host: Login to the router, click the “Forwarding” menu on the left of your browser, and click "DMZ" submenu. On the "DMZ" page, click “Enable” radio and type your IP address into the “DMZ Host IP Address” field, using 192.168.1.169 as an example, remember to click the **Save** button.

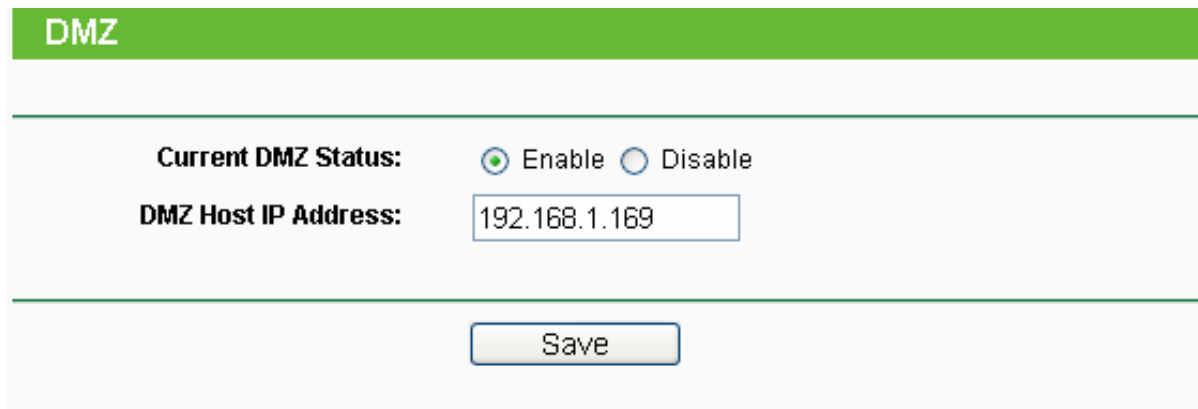

Figure A-6 DMZ

4. I want to build a Web Server on the LAN, what should I do?

- 1) Because the Web Server port 80 will interfere with the Web management port 80 on the router, you must change the Web management port number to avoid interference.
- 2) To change the Web management port number: Login to the router, click the “Security” menu on the left of your browser, and click "Remote Management" submenu. On the "Remote Management" page, type a port number except 80, such as 88, into the "Web Management Port" field. Click “Save” and reboot the router.

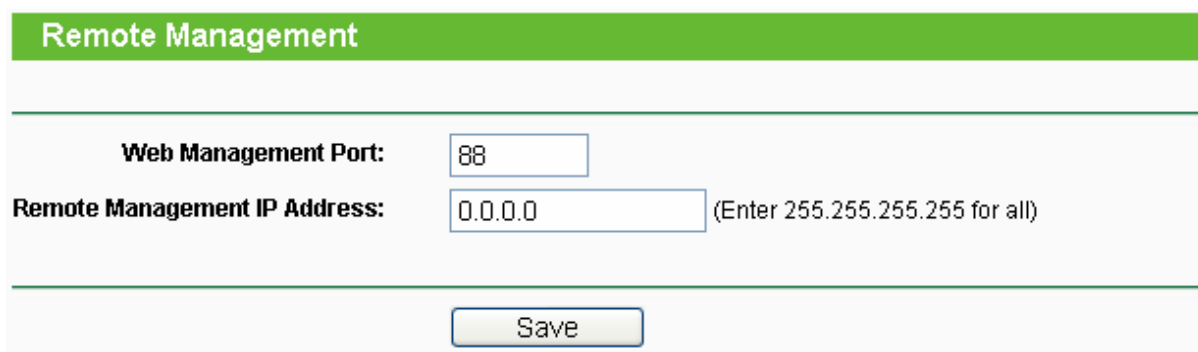

Figure A-7 Remote Management

Note:

If the above configuration takes effect, to configure to the router by typing <http://192.168.1.254:88/> (the router’s LAN IP address: Web Management Port) in the address field of the Web browser.

- 3) Login to the router, click the “Forwarding” menu on the left of your browser, and click the "Virtual Servers" submenu. On the "Virtual Server" page, click **Add New**, then on the “Add or Modify a Virtual Server” page, enter “80” into the blank behind the “Service Port”, and your IP address behind the IP Address, assuming 192.168.1.188 for an example, remember to “Enable” and “Save”.

Virtual Servers					
ID	Service Ports	IP Address	Protocol	Status	Modify
<input type="button" value="Add New..."/> <input type="button" value="Enable All"/> <input type="button" value="Disable All"/> <input type="button" value="Delete All"/>					
<input type="button" value="Previous"/> <input type="button" value="Next"/>					

Figure A-8 Virtual Servers

Add or Modify a Virtual Server Entry	
Service Port:	<input type="text" value="80"/> (XX-XX or XX)
IP Address:	<input type="text" value="192.168.1.188"/>
Protocol:	<input type="text" value="ALL"/> ▼
Status:	<input type="text" value="Enabled"/> ▼
Common Service Port:	<input type="text" value="--Select One--"/> ▼
<input type="button" value="Save"/> <input type="button" value="Back"/>	

A-9 Add or Modify a Virtual server Entry

5. The wireless stations cannot connect to the router.

- 1) Make sure the "Wireless Router Radio" is enabled.
- 2) Make sure that the wireless stations' SSID accord with the router's SSID.
- 3) Make sure the wireless stations have the right KEY for encryption when the router is encrypted.
- 4) If the wireless connection is ready, but you can't access the router, check the IP Address of your wireless stations.

Appendix B: Specifications

General	
Standards and Protocols	IEEE 802.3, 802.3u, 802.11b and 802.11g, TCP/IP, DHCP
Safety & Emission	FCC、CE
Ports	One 10/100M Auto-Negotiation LAN RJ45 port, supporting passive PoE
Cabling Type	10BASE-T: UTP category 3, 4, 5 cable (maximum 100m) EIA/TIA-568 100Ω STP (maximum 100m) 100BASE-TX: UTP category 5, 5e cable (maximum 100m) EIA/TIA-568 100Ω STP (maximum 100m)
Wireless	
Wireless Data Rates	54/48/36/24/18/12/9/6Mbps or 11/5.5/3/2/1Mbps
Wireless Encryptions	64/128/152-bit WEP, WPA/WPA2, WPA-PSK/WPA2-PSK
Physical and Environment	
Working Temperature	-10°C~40°C
Working Humidity	10% ~ 90% RH, Non-condensing
Storage Temperature	-40°C~70°C(-40°F~158°F)
Storage Humidity	5% ~ 90% RH, Non-condensing

Appendix C: Glossary

- **2x to 3x eXtended Range™ WLAN Transmission Technology** - The WLAN device with 2x to 3x eXtended Range™ WLAN transmission technology make its sensitivity up to 105 dB, which gives users the ability to have robust, longer-range wireless connections. With this range-enhancing technology, a 2x to 3x eXtended Range™ based client and access point can maintain a connection at as much as three times the transmission distance of traditional 802.11b and 802.11g products, for a coverage area that is up to nine times greater. A traditional 802.11b and 802.11g product transmission distance is about 300m, a 2x to 3x eXtended Range™ based client and access point can maintain a connection transmission distance may be up to 830m.
- **802.11b** - The 802.11b standard specifies a wireless networking at 11 Mbps using direct-sequence spread-spectrum (DSSS) technology and operating in the unlicensed radio spectrum at 2.4GHz, and WEP encryption for security. 802.11b networks are also referred to as Wi-Fi networks.
- **802.11g** - specification for wireless networking at 54 Mbps using direct-sequence spread-spectrum (DSSS) technology, using OFDM modulation and operating in the unlicensed radio spectrum at 2.4GHz, and backward compatibility with IEEE 802.11b devices, and WEP encryption for security.
- **DDNS (Dynamic Domain Name System)** - The capability of assigning a fixed host and domain name to a dynamic Internet IP Address.
- **DHCP (Dynamic Host Configuration Protocol)** - A protocol that automatically configure the TCP/IP parameters for the all the PC(s) that are connected to a DHCP server.
- **DMZ (Demilitarized Zone)** - A Demilitarized Zone allows one local host to be exposed to the Internet for a special-purpose service such as Internet gaming or videoconferencing.
- **DNS (Domain Name System)** – An Internet Service that translates the names of websites into IP addresses.
- **Domain Name** - A descriptive name for an address or group of addresses on the Internet.
- **DoS (Denial of Service)** - A hacker attack designed to prevent your computer or network from operating or communicating.
- **DSL (Digital Subscriber Line)** - A technology that allows data to be sent or received over existing traditional phone lines.
- **ISP (Internet Service Provider)** - A company that provides access to the Internet.
- **MTU (Maximum Transmission Unit)** - The size in bytes of the largest packet that can be transmitted.
- **NAT (Network Address Translation)** - NAT technology translates IP addresses of a local area network to a different IP address for the Internet.
- **PPPoE (Point to Point Protocol over Ethernet)** - PPPoE is a protocol for connecting remote hosts to the Internet over an always-on connection by simulating a dial-up connection.
- **SSID - A Service Set Identification** is a thirty-two character (maximum) alphanumeric key identifying a wireless local area network. For the wireless devices in a network to communicate with each other, all devices must be configured with the same SSID. This is typically the configuration parameter for a wireless PC card. It corresponds to the ESSID in the wireless Access Point and to the wireless network name.
- **WEP (Wired Equivalent Privacy)** - A data privacy mechanism based on a 64-bit or 128-bit or

152-bit shared key algorithm, as described in the IEEE 802.11 standard.

- **Wi-Fi** - is a trademark of the Wi-Fi Alliance, founded in 1999 as Wireless Internet Compatibility Alliance (WICA), comprising more than 300 companies, whose products are certified by the Wi-Fi Alliance, based on the IEEE 802.11 standards (also called Wireless LAN (WLAN) and Wi-Fi). This certification warrants interoperability between different wireless devices.
- **WISP - Wireless Internet Service Providers (WISPs)** are Internet service providers with networks built around wireless networking. The technology used ranges from commonplace Wi-Fi mesh networking or proprietary equipment designed to operate over open 900MHz, 2.4GHz, 4.9, 5.2, 5.4, and 5.8GHz bands or licensed frequencies in the UHF or MMDS bands.
- **WLAN (Wireless Local Area Network)** - A group of computers and associated devices communicate with each other wirelessly, which network serving users are limited in a local area.

Free Manuals Download Website

<http://myh66.com>

<http://usermanuals.us>

<http://www.somanuals.com>

<http://www.4manuals.cc>

<http://www.manual-lib.com>

<http://www.404manual.com>

<http://www.luxmanual.com>

<http://aubethermostatmanual.com>

Golf course search by state

<http://golfingnear.com>

Email search by domain

<http://emailbydomain.com>

Auto manuals search

<http://auto.somanuals.com>

TV manuals search

<http://tv.somanuals.com>