

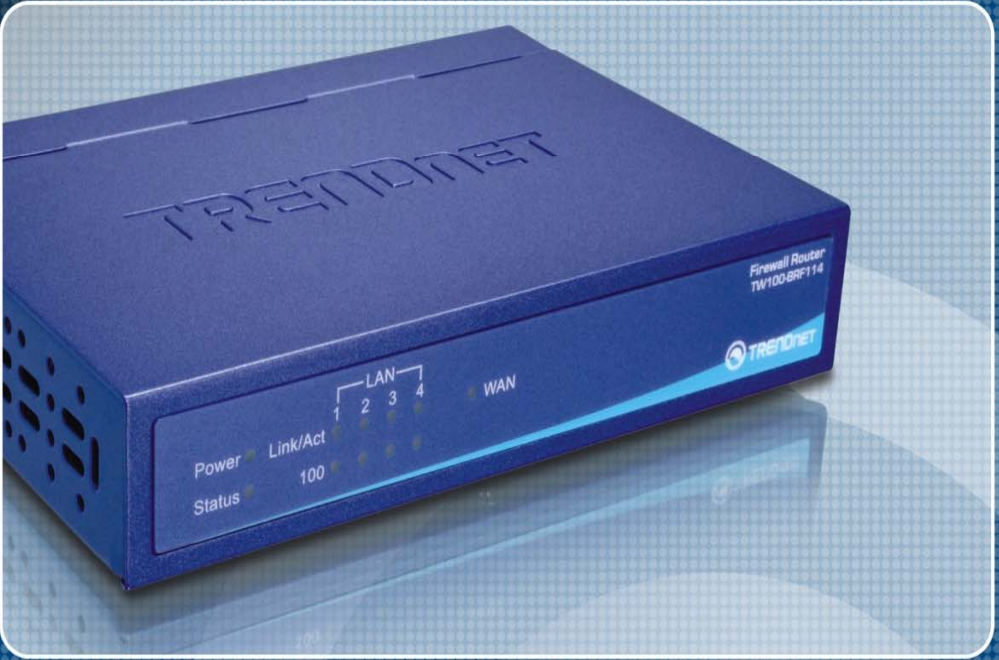

TRENDNET®



User's Guide

TW100-BRF114

Table of Contents

CHAPTER 1 INTRODUCTION	1
TW100-BRF114 Features	1
Package Contents	3
Physical Details	4
CHAPTER 2 INSTALLATION.....	6
Requirements.....	6
Procedure	6
CHAPTER 3 SETUP	8
Overview	8
Configuration Program	9
Setup Wizard	11
LAN Screen.....	14
Password Screen.....	16
CHAPTER 4 PC CONFIGURATION	17
Overview	17
Windows Clients.....	17
Macintosh Clients.....	32
Linux Clients.....	32
Other Unix Systems.....	32
CHAPTER 5 OPERATION AND STATUS	33
Operation	33
Status Screen.....	33
Connection Status - PPPoE	34
Connection Status - PPTP	37
Connection Status - Telstra Big Pond.....	38
Connection Details - SingTel RAS	39
Connection Details - Fixed/Dynamic IP Address	40
CHAPTER 6 INTERNET FEATURES	42
Overview	42
Advanced Internet Screen	42
Dynamic DNS (Domain Name Server)	47
MAC Address	49
Virtual Servers.....	50
CHAPTER 7 OTHER FEATURES AND SETTINGS	54
Overview	54
Access Control	55
Remote Management	61
PC Database.....	62
Upgrade Firmware.....	66
Options	67
Security.....	68
Logs.....	70
Routing.....	72

APPENDIX A TROUBLESHOOTING	76
Overview	76
General Problems.....	76
Internet Access.....	77
APPENDIX B SPECIFICATIONS.....	78
TW100-BRF114.....	78
Regulatory Approvals.....	78

P/N: 9560ML0037

Copyright © 2003. All Rights Reserved.

Document Version: 1.0

All trademarks and trade names are the properties of their respective owners.

Chapter 1

Introduction

1

This Chapter provides an overview of the TW100-BRF114's features and capabilities.

Congratulations on the purchase of your new TW100-BRF114. The TW100-BRF114 is a multi-function device providing the following services:

- **Shared Broadband Internet Access** for all LAN users.
- **4-Port Switching Hub** for 10BaseT or 100BaseT connections.

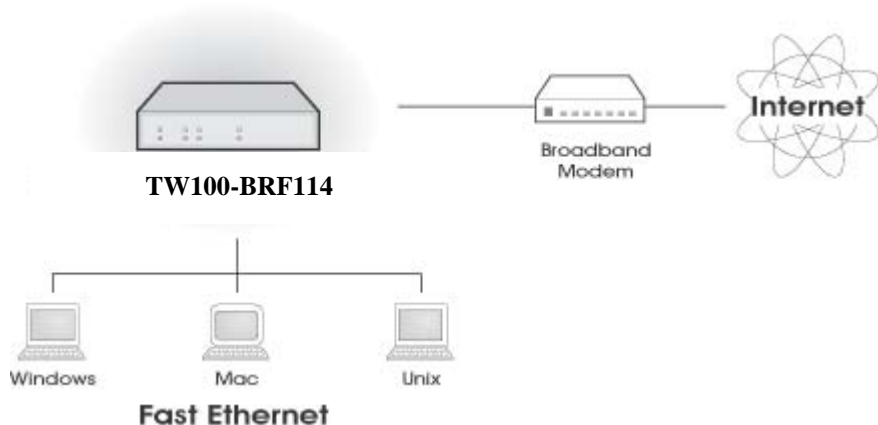

Figure 1: TW100-BRF114

TW100-BRF114 Features

The TW100-BRF114 incorporates many advanced features, carefully designed to provide sophisticated functions while being easy to use.

Internet Access Features

- **Shared Internet Access.** All users on the LAN or WLAN can access the Internet through the TW100-BRF114, using only a single external IP Address. The local (invalid) IP Addresses are hidden from external sources. This process is called NAT (Network Address Translation).
- **DSL & Cable Modem Support.** The TW100-BRF114 has a 10/100BaseT Ethernet port for connecting a DSL or Cable Modem. All popular DSL and Cable Modems are supported. SingTel RAS and Big Pond (Australia) login support is also included.
- **PPPoE, PPTP, SingTel RAS and Telstra Big Pond Support.** The Internet (WAN port) connection supports PPPoE (PPP over Ethernet), PPTP (Peer-to-Peer Tunneling Protocol), SingTel RAS and Telstra Big Pond (Australia), as well as "Direct Connection" type services.
- **Fixed or Dynamic IP Address.** On the Internet (WAN port) connection, the TW100-BRF114 supports both Dynamic IP Address (IP Address is allocated on connection) and Fixed IP Address.

Advanced Internet Functions

- **Communication Applications.** Support for Internet communication applications, such as interactive Games, Telephony, and Conferencing applications, which are often difficult to use when behind a Firewall, is included.
- **Special Internet Applications.** Applications which use non-standard connections or port numbers are normally blocked by the Firewall. The ability to define and allow such applications is provided, to enable such applications to be used normally.
- **Virtual Servers.** This feature allows Internet users to access Internet servers on your LAN. The required setup is quick and easy.
- **DMZ.** One (1) PC on your local LAN can be configured to allow unrestricted 2-way communication with Servers or individual users on the Internet. This provides the ability to run programs which are incompatible with Firewalls.
- **URL Filter.** Use the URL Filter to block access to undesirable Web sites by LAN users.
- **Internet Access Log.** See which Internet connections have been made.
- **VPN Pass through Support.** PCs with VPN (Virtual Private Networking) software using PPTP, L2TP and IPSec are transparently supported - no configuration is required.

LAN Features

- **4-Port Switching Hub.** The TW100-BRF114 incorporates a 4-port 10/100BaseT switching hub, making it easy to create or extend your LAN.
- **DHCP Server Support.** Dynamic Host Configuration Protocol provides a dynamic IP address to PCs and other devices upon request. The TW100-BRF114 can act as a **DHCP Server** for devices on your local LAN and WLAN.
- **Multi Segment LAN Support.** LANs containing one or more segments are supported, via the TW100-BRF114 's RIP (Routing Information Protocol) support and built-in static routing table.

Configuration & Management

- **Easy Setup.** Use your WEB browser from anywhere on the LAN or WLAN for configuration.
- **Remote Management.** The TW100-BRF114 can be managed from any PC on your LAN. And, if the Internet connection exists, it can also (optionally) be configured via the Internet.
- **UPnP Support.** UPnP (Universal Plug and Play) allows automatic discovery and configuration of the TW100-BRF114. UPnP is by supported by Windows ME, XP, or later.

Security Features

- **Password - protected Configuration.** Optional password protection is provided to prevent unauthorized users from modifying the configuration data and settings.
- **NAT Protection.** An intrinsic side effect of NAT (Network Address Translation) technology is that by allowing all LAN users to share a single IP address, the location and even the existence of each PC is hidden. From the external viewpoint, there is no network, only a single device - the TW100-BRF114.
- **Stateful Inspection Firewall.** All incoming data packets are monitored and all incoming server requests are filtered, thus protecting your network from malicious attacks from external sources.

- ***Protection against DoS attacks.*** DoS (Denial of Service) attacks can flood your Internet connection with invalid packets and connection requests, using so much bandwidth and so many resources that Internet access becomes unavailable. The TW100-BRF114 incorporates protection against DoS attacks.

Package Contents

The following items should be included:

- The TW100-BRF114 Unit
- Quick Installation Guide
- CD-ROM containing the on-line manual.
- Power Adapter

If any of the above items are damaged or missing, please contact your local dealer immediately.

Physical Details

Front-mounted LEDs

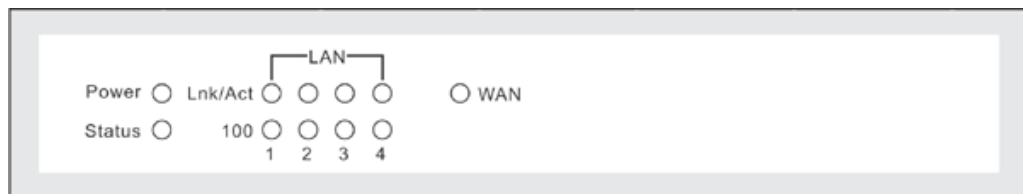

Figure 2: Front Panel

Power (Green)	<p>On - Power on.</p> <p>Off - No power.</p>
Status (Red)	<p>On - Error condition.</p> <p>Off - Normal operation.</p> <p>Blinking - This LED blinks during start up.</p>
LAN	<p>For each port, there are 2 LEDs</p> <ul style="list-style-type: none"> • Link/Act (Green) <ul style="list-style-type: none"> • On - Corresponding LAN (hub) port is active. • Off - No active connection on the corresponding LAN (hub) port. • Flashing - Data is being transmitted or received via the corresponding LAN (hub) port. • 100 (Yellow) <ul style="list-style-type: none"> • On - Corresponding LAN (hub) port is using 100BaseT. • Off - Corresponding LAN (hub) port connection is using 10BaseT, or no active connection.
WAN (Green)	<p>On - Connection to the modem attached to the WAN (Internet) port is established.</p> <p>Flashing - Data is being transmitted or received via the WAN port.</p>

Rear Panel

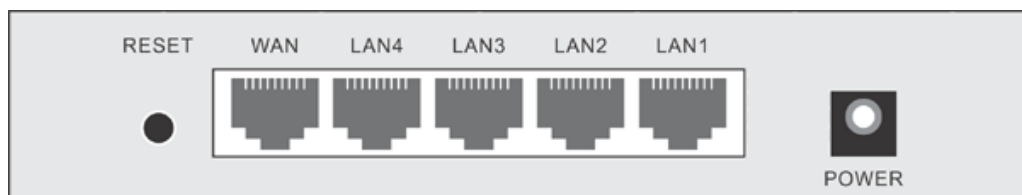

Figure 3: Rear Panel

Reset Button

This button has two (2) functions:

- **Reboot.** When pressed and released, the TW100-BRF114 will reboot (restart).
- **Clear All Data.** This button can also be used to clear ALL data and restore ALL settings to the factory default values.

To Clear All Data and restore the factory default values:

1. Power Off.
2. Hold the Reset Button down while you Power On.
3. Keep holding the Reset Button down for five (5) seconds, until the Red Status LED has flashed TWICE.
4. Release the Reset Button. The TW100-BRF114 is now using the factory default values.

WAN port (10/100BaseT)

Connect the DSL or Cable Modem here. If your modem came with a cable, use the supplied cable. Otherwise, use a standard LAN cable.

10/100BaseT LAN connections

Use standard LAN cables (RJ45 connectors) to connect your PCs to these ports.

Note:

Any LAN port on the TW100-BRF114 will automatically function as an "Uplink" port when required. Just connect any port to a normal port on the other hub, using a standard LAN cable.

Power port

Connect the supplied power adapter here.

Chapter 2

Installation

2

This Chapter covers the physical installation of the TW100-BRF114.

Requirements

- Network cables. Use standard 10/100BaseT network (UTP) cables with RJ45 connectors.
- TCP/IP protocol must be installed on all PCs.
- For Internet Access, an Internet Access account with an ISP, and either of a DSL or Cable modem (for WAN port usage)

Procedure

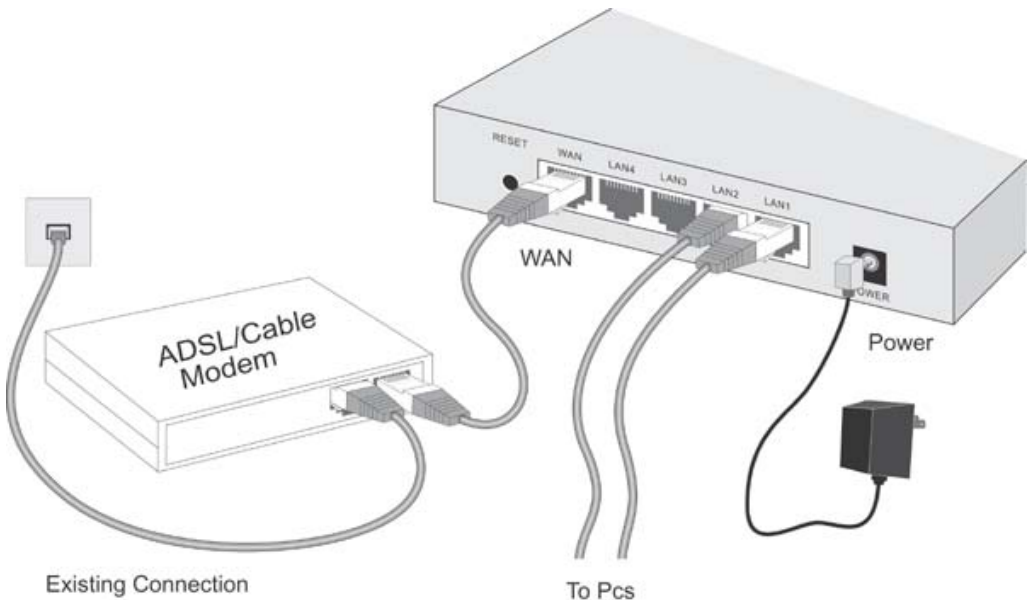

Figure 4: Installation Diagram

1. Choose an Installation Site

Select a suitable place on the network to install the TW100-BRF114.
Ensure the TW100-BRF114 and the DSL/Cable modem are powered OFF.

2. Connect LAN Cables

- Use standard LAN cables to connect PCs to the Switching Hub ports on the TW100-BRF114. Both 10BaseT and 100BaseT connections can be used simultaneously.
- If required, you can connect any LAN port to another Hub. Any LAN port on the TW100-BRF114 will automatically function as an "Uplink" port when required. Just connect any LAN port to a normal port on the other hub, using a standard LAN cable.

3. Connect WAN Cable

Connect the DSL or Cable modem to the WAN port on the TW100-BRF114. Use the cable supplied with your DSL/Cable modem. If no cable was supplied, use a standard cable.

4. Power Up

- Power on the Cable or DSL modem.
- Connect the supplied power adapter to the TW100-BRF114 and power up. Use only the power adapter provided. Using a different one may cause hardware damage

5. Check the LEDs

- The *Power* LED should be ON.
- The *Status* LED should flash, then turn Off. If it stays on, there is a hardware error.
- For each LAN (PC) connection, the LAN *Link/Act* LED should be ON (provided the PC is also ON.)
- The *WAN* LED should be ON.

For more information, refer to Front-mounted LEDs in Chapter 1.

Chapter 3

Setup

3

This Chapter provides Setup details of the TW100-BRF114.

Overview

This chapter describes the setup procedure for:

- Internet Access
- LAN configuration

PCs on your local LAN may also require configuration. For details, see *Chapter 4 - PC Configuration*.

Other configuration may also be required, depending on which features and functions of the TW100-BRF114 you wish to use. Use the table below to locate detailed instructions for the required functions.

To Do this:	Refer to:
Configure PCs on your LAN.	Chapter 4: PC Configuration
Check TW100-BRF114 operation and Status.	Chapter 5: Operation and Status
Use any of the following Internet features: <ul style="list-style-type: none">• Advanced Setup• Dynamic DNS• MAC Address• Virtual Servers	Chapter 6: Internet Features
Configure or use any of the following: <ul style="list-style-type: none">• Access Control• Remote Management• PC Database• Upgrade Firmware• Options• Security• Logs• Routing	Chapter 7: Other Features and Settings



Where use of a certain feature requires that PCs or other LAN devices be configured, this is also explained in the relevant chapter.

Configuration Program

The TW100-BRF114 contains an HTTP server. This enables you to connect to it, and configure it, using your Web Browser. **Your Browser must support JavaScript.** The configuration program has been tested on the following browsers:

- Netscape V4.08 or later
- Internet Explorer V4 or later

Preparation

Before attempting to configure the TW100-BRF114, please ensure that:

- Your PC can establish a physical connection to the TW100-BRF114. The PC and the TW100-BRF114 must be directly connected (using the Hub ports on the TW100-BRF114) or on the same LAN segment.
- The TW100-BRF114 must be installed and powered ON.
- If the TW100-BRF114 's default IP Address (192.168.0.1) is already used by another device, the other device must be turned OFF until the TW100-BRF114 is allocated a new IP Address during configuration.

Using UPnP

If your Windows system supports UPnP, an icon for the TW100-BRF114 will appear in the system tray, notifying you that a new network device has been found, and offering to create a new desktop shortcut to the newly-discovered device.

- Unless you intend to change the IP Address of the TW100-BRF114, you can accept the desktop shortcut.
- Whether you accept the desktop shortcut or not, you can always find UPnP devices in *My Network Places* (previously called *Network Neighborhood*).
- Double - click the icon for the TW100-BRF114 (either on the Desktop, or in *My Network Places*) to start the configuration. Refer to the following section *Setup Wizard* for details of the initial configuration process.

Using your Web Browser

To establish a connection from your PC to the TW100-BRF114:

1. After installing the TW100-BRF114 in your LAN, start your PC. If your PC is already running, restart it.
2. Start your WEB browser.
3. In the *Address* box, enter "HTTP://" and the IP Address of the TW100-BRF114, as in this example, which uses the TW100-BRF114 's default IP Address:

HTTP://192.168.0.1

If you can't connect

If the TW100-BRF114 does not respond, check the following:

- The TW100-BRF114 is properly installed, LAN connection is OK, and it is powered ON. You can test the connection by using the "Ping" command:
 - Open the MS-DOS window or command prompt window.
 - Enter the command:

```
ping 192.168.0.1
```

If no response is received, either the connection is not working, or your PC's IP address is not compatible with the TW100-BRF114 's IP Address. (See next item.)
- If your PC is using a fixed IP Address, its IP Address must be within the range 192.168.0.2 to 192.168.0.254 to be compatible with the TW100-BRF114 's default IP Address of 192.168.0.1. Also, the *Network Mask* must be set to 255.255.255.0. See *Chapter 4 - PC Configuration* for details on checking your PC's TCP/IP settings.
- Ensure that your PC and the TW100-BRF114 are on the same network segment. (If you don't have a router, this must be the case.)

Setup Wizard

The first time you connect to the TW100-BRF114, the Setup Wizard will run automatically. (The Setup Wizard will also run if the TW100-BRF114's default settings are restored.)

1. Step through the Wizard until finished.
 - You need to know the type of Internet connection service used by your ISP. Check the data supplied by your ISP.
 - The common connection types are explained in the tables below.
2. On the final screen of the Wizard, run the test and check that an Internet connection can be established.
3. If the connection test fails:
 - Check your data, the Cable/DSL modem, and all connections.
 - Check that you have entered all data correctly.
 - If using a Cable modem, your ISP may have recorded the MAC (physical) address of your PC. Run the Wizard, and on the *Cable Modem* screen, use the "Clone MAC address" button to copy the MAC address from your PC to the TW100-BRF114.

Common Connection Types

Cable Modems

Type	Details	ISP Data required
Dynamic IP Address	Your IP Address is allocated automatically, when you connect to your ISP.	Usually, none. However, some ISPs may require you to use a particular Hostname, Domain name, or MAC (physical) address.
Static (Fixed) IP Address	Your ISP allocates a permanent IP Address to you.	IP Address allocated to you, mask and gateway (if provided), and DNS address. Some ISPs may also require you to use a particular Hostname, Domain name, or MAC (physical) address.

DSL Modems

Type	Details	ISP Data required
Dynamic IP Address	Your IP Address is allocated automatically, when you connect to your ISP.	None.
Static (Fixed) IP Address	Your ISP allocates a permanent IP Address to you.	IP Address allocated to you, mask and gateway (if provided), and DNS address.
PPPoE	You connect to the ISP only when required. The IP address is usually allocated automatically.	User name and password.

PPTP	<p>Mainly used in Europe.</p> <p>You connect to the ISP only when required. The IP address is usually allocated automatically, but may be Static (Fixed).</p>	<ul style="list-style-type: none"> • PPTP Server IP Address. • User name and password. • IP Address allocated to you, if Static (Fixed).
------	---	---

Other Modems (e.g. Broadband Wireless)

Type	Details	ISP Data required
Dynamic IP Address	Your IP Address is allocated automatically, when you connect to you ISP.	<p>Usually, none.</p> <p>However, some ISP's may require you to use a particular Hostname, Domain name, or MAC (physical) address.</p>
Static (Fixed) IP Address	Your ISP allocates a permanent IP Address to you.	IP Address allocated to you, mask and gateway (if provided), and DNS address.

Big Pond Cable (Australia)

For this connection method, the following data is required:

- User Name
- Password
- Big Pond Server IP address

SingTel RAS

For this connection method, the following data is required:

- User Name
- Password
- RAS Plan

Home Screen

After finishing or exiting the Setup Wizard, you will see the *Home* screen. When you connect in future, you will see this screen when you connect. An example screen is shown below.

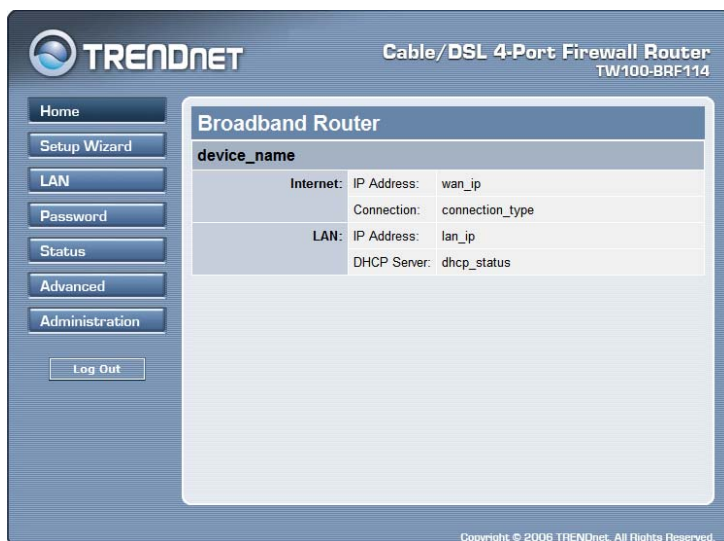

Figure 5: Home Screen

Navigation & Data Input

- Use the menu bar on the top of the screen, and the "Back" button on your Browser, for navigation.
- Changing to another screen without clicking "Save" does NOT save any changes you may have made. You must "Save" before changing screens or your data will be ignored.



Note!

On each screen, clicking the "Help" button will display help for that screen.

From any help screen, you can access the list of all help files (help index).

LAN Screen

Use the *LAN* link on the main menu to reach the *LAN* screen. An example screen is shown below.

Figure 6: LAN Screen

Data - LAN Screen

TCP/IP	
IP Address	IP address for the TW100-BRF114, as seen from the local LAN. Use the default value unless the address is already in use or your LAN is using a different IP address range. In the latter case, enter an unused IP Address from within the range used by your LAN.
Subnet Mask	The default value 255.255.255.0 is standard for small (class "C") networks. For other networks, use the Subnet Mask for the LAN segment to which the TW100-BRF114 is attached (the same value as the PCs on that LAN segment).
DHCP Server	<ul style="list-style-type: none"> • If Enabled, the TW100-BRF114 will allocate IP Addresses to PCs (DHCP clients) on your LAN when they start up. The default (and recommended) value is Enabled. • If you are already using a DHCP Server, this setting must be Disabled, and the existing DHCP server must be re-configured to treat the TW100-BRF114 as the default Gateway. See the following section for further details. • The Start IP Address and Finish IP Address fields set the values used by the DHCP server when allocating IP Addresses to DHCP clients. This range also determines the number of DHCP clients supported. <p>See the following section for further details on using DHCP.</p>
Buttons	
Save	Save the data on screen.
Cancel	The "Cancel" button will discard any data you have entered and reload the file from the TW100-BRF114.

DHCP

What DHCP Does

A DHCP (Dynamic Host Configuration Protocol) **Server** allocates a valid IP address to a DHCP **Client** (PC or device) upon request.

- The client request is made when the client device starts up (boots).
- The DHCP Server provides the *Gateway* and *DNS* addresses to the client, as well as allocating an IP Address.
- The TW100-BRF114 can act as a **DHCP server**.
- Windows 95/98/ME2000/XP and other non-Server versions of Windows will act as a DHCP **client**. This is the default Windows setting for the TCP/IP network protocol. However, Windows uses the term *Obtain an IP Address automatically* instead of "DHCP Client".
- You must NOT have two (2) or more DHCP Servers on the same LAN segment. (If your LAN does not have other Routers, this means there must only be one (1) DHCP Server on your LAN.)

Using the TW100-BRF114 's DHCP Server

This is the default setting. The DHCP Server settings are on the **LAN** screen. On this screen, you can:

- Enable or Disable the TW100-BRF114 's *DHCP Server* function.
- Set the range of IP Addresses allocated to PCs by the DHCP Server function.



Note

You can assign Fixed IP Addresses to some devices while using DHCP, provided that the Fixed IP Addresses are NOT within the range used by the DHCP Server.

Using another DHCP Server

You can only use one (1) DHCP Server per LAN segment. If you wish to use another DHCP Server, rather than the TW100-BRF114 's, the following procedure is required.

1. Disable the DHCP Server feature in the TW100-BRF114. This setting is on the LAN screen.
2. Configure the DHCP Server to provide the TW100-BRF114 's IP Address as the *Default Gateway*.

To Configure your PCs to use DHCP

This is the default setting for TCP/IP under Windows 95/98/ME/NT4.0/2000/XP.

See *Chapter 4 - Client Configuration* for the procedure to check these settings.

Password Screen

The password screen allows you to assign a password to the Firewall Router.



Figure 7: Password Screen

Once you have assigned a password to the Firewall Router (on the *Password* screen above) you will be prompted for the password when you connect, as shown below. (If no password has been set, this dialog will not appear.)

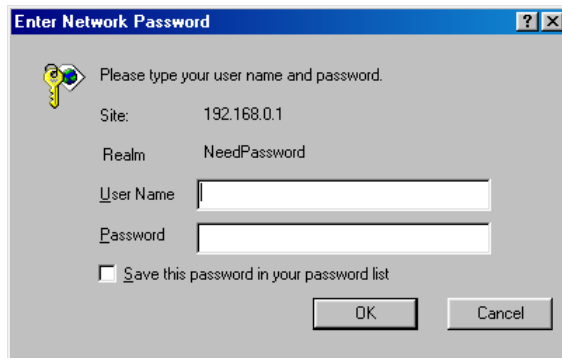

Figure 8: Password Dialog

- Leave the "User Name" blank.
- Enter the password for the Firewall Router, as set on the *Password* screen above.

Chapter 4

4

PC Configuration

This Chapter details the PC Configuration required on the local ("Internal") LAN.

Overview

For each PC, the following may need to be configured:

- TCP/IP network settings
- Internet Access configuration

Windows Clients

This section describes how to configure Windows clients for Internet access via the TW100-BRF114.

The first step is to check the PC's TCP/IP settings.

The TW100-BRF114 uses the TCP/IP network protocol for all functions, so it is essential that the TCP/IP protocol be installed and configured on each PC.

TCP/IP Settings - Overview

If using the default TW100-BRF114 settings, and the default Windows TCP/IP settings, no changes need to be made.

- By default, the TW100-BRF114 will act as a DHCP Server, automatically providing a suitable IP Address (and related information) to each PC when the PC boots.
- For all non-Server versions of Windows, the default TCP/IP setting is to act as a DHCP client.

If using a Fixed (specified) IP address, the following changes are required:

- The *Gateway* must be set to the IP address of the TW100-BRF114
- The *DNS* should be set to the address provided by your ISP.



If your LAN has a Router, the LAN Administrator must re-configure the Router itself. Refer to *Chapter 8 - Other Features and Operations* for details.

Checking TCP/IP Settings - Windows 9x/ME:

3. Select *Control Panel - Network*. You should see a screen like the following:

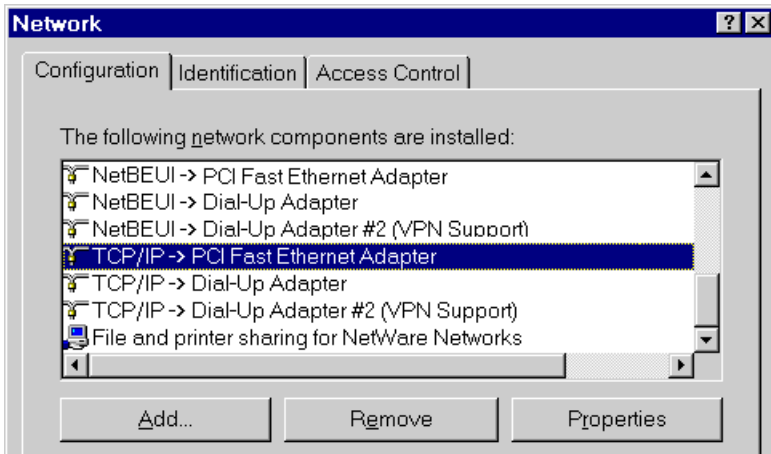

Figure 9: Network Configuration

4. Select the *TCP/IP* protocol for your network card.
5. Click on the *Properties* button. You should then see a screen like the following.

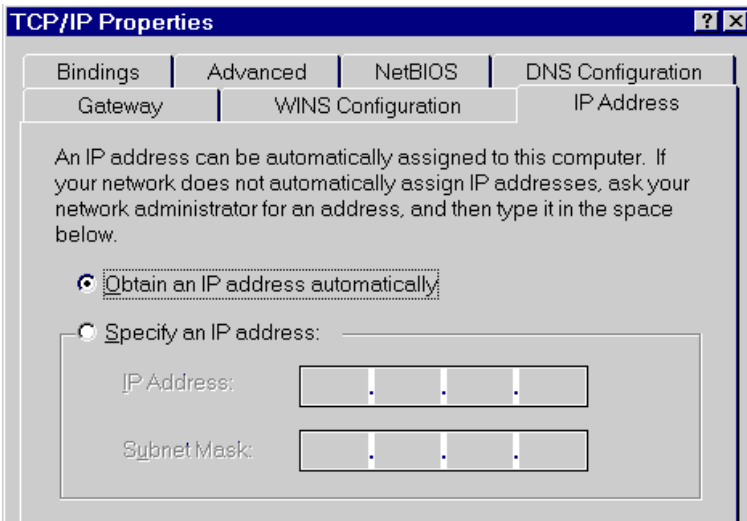

Figure 10: IP Address (Win 95)

Ensure your TCP/IP settings are correct, as follows:

Using DHCP

To use DHCP, select the radio button *Obtain an IP Address automatically*. This is the default Windows setting. **Using this is recommended.** By default, the TW100-BRF114 will act as a DHCP Server.

Restart your PC to ensure it obtains an IP Address from the TW100-BRF114.

Using "Specify an IP Address"

If your PC is already configured, check with your network administrator before making the following changes:

- On the *Gateway* tab, enter the TW100-BRF114 's IP address in the *New Gateway* field and click *Add*, as shown below. Your LAN administrator can advise you of the IP Address they assigned to the TW100-BRF114.

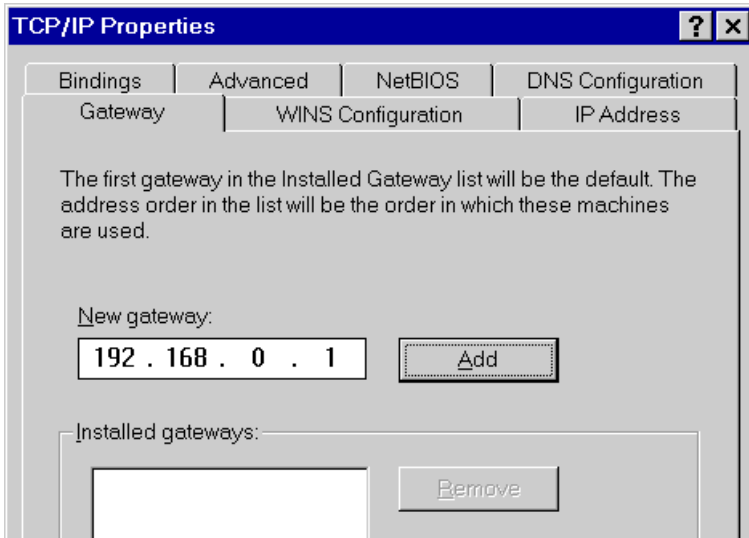

Figure 11: Gateway Tab (Win 95/98/ME)

- On the *DNS Configuration* tab, ensure *Enable DNS* is selected. If the *DNS Server Search Order* list is empty, enter the DNS address provided by your ISP in the fields beside the *Add* button, then click *Add*.

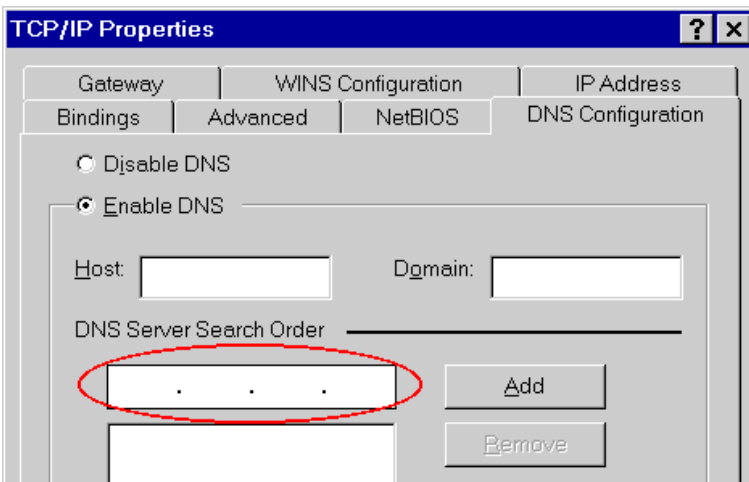

Figure 12: DNS Tab (Win 95/98/ME)

Checking TCP/IP Settings - Windows NT4.0

1. Select *Control Panel - Network*, and, on the *Protocols* tab, select the TCP/IP protocol, as shown below.

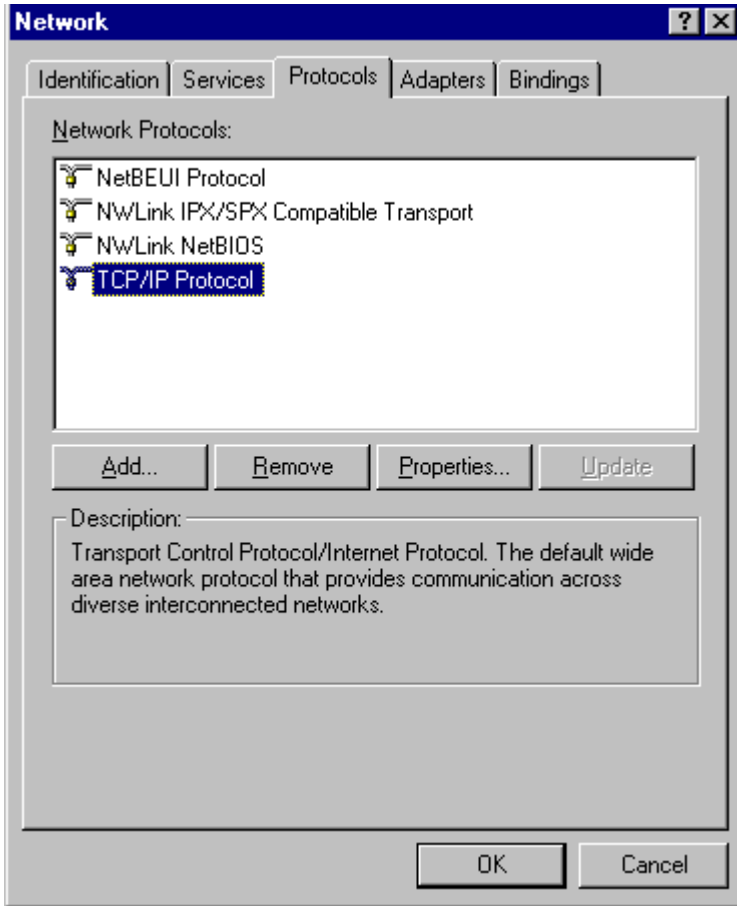

Figure 13: Windows NT4.0 - TCP/IP

2. Click the *Properties* button to see a screen like the one below.

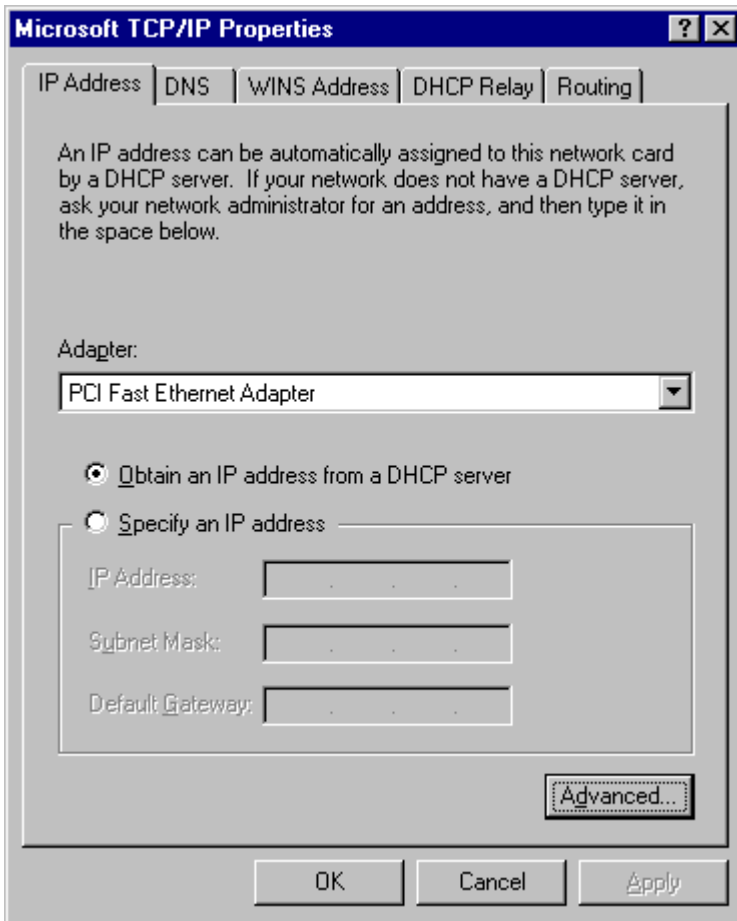

Figure 14: Windows NT4.0 - IP Address

3. Select the network card for your LAN.
4. Select the appropriate radio button - *Obtain an IP address from a DHCP Server* or *Specify an IP Address*, as explained below.

Obtain an IP address from a DHCP Server

This is the default Windows setting. **Using this is recommended.** By default, the TW100-BRF114 will act as a DHCP Server.

Restart your PC to ensure it obtains an IP Address from the TW100-BRF114.

Specify an IP Address

If your PC is already configured, check with your network administrator before making the following changes.

1. The *Default Gateway* must be set to the IP address of the TW100-BRF114. To set this:
 - Click the *Advanced* button on the screen above.
 - On the following screen, click the *Add* button in the *Gateways* panel, and enter the TW100-BRF114 's IP address, as shown in Figure 15 below.
 - If necessary, use the *Up* button to make the TW100-BRF114 the first entry in the *Gateways* list.

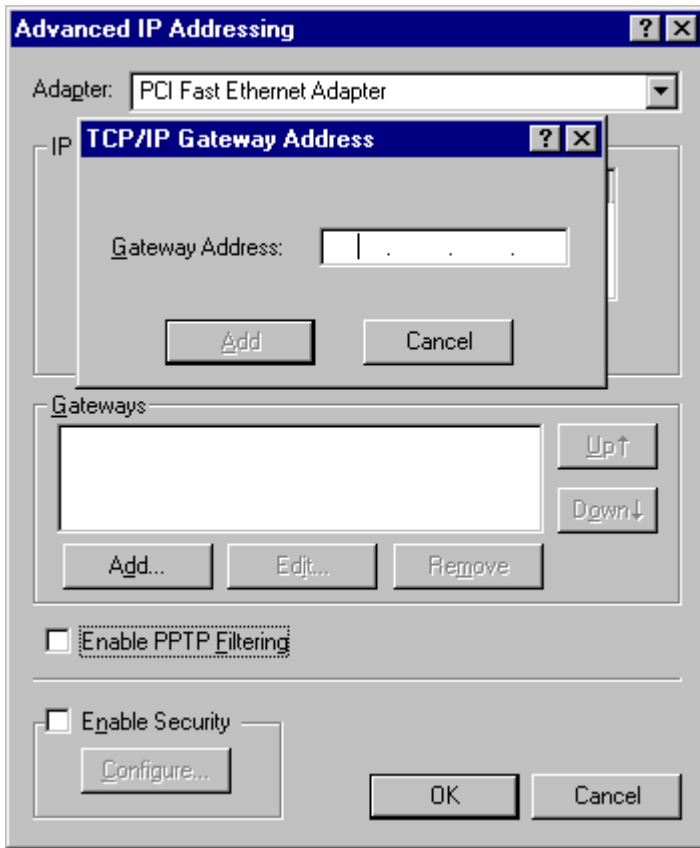

Figure 15 - Windows NT4.0 - Add Gateway

2. The DNS should be set to the address provided by your ISP, as follows:
 - Click the DNS tab.
 - On the DNS screen, shown below, click the *Add* button (under *DNS Service Search Order*), and enter the DNS provided by your ISP.

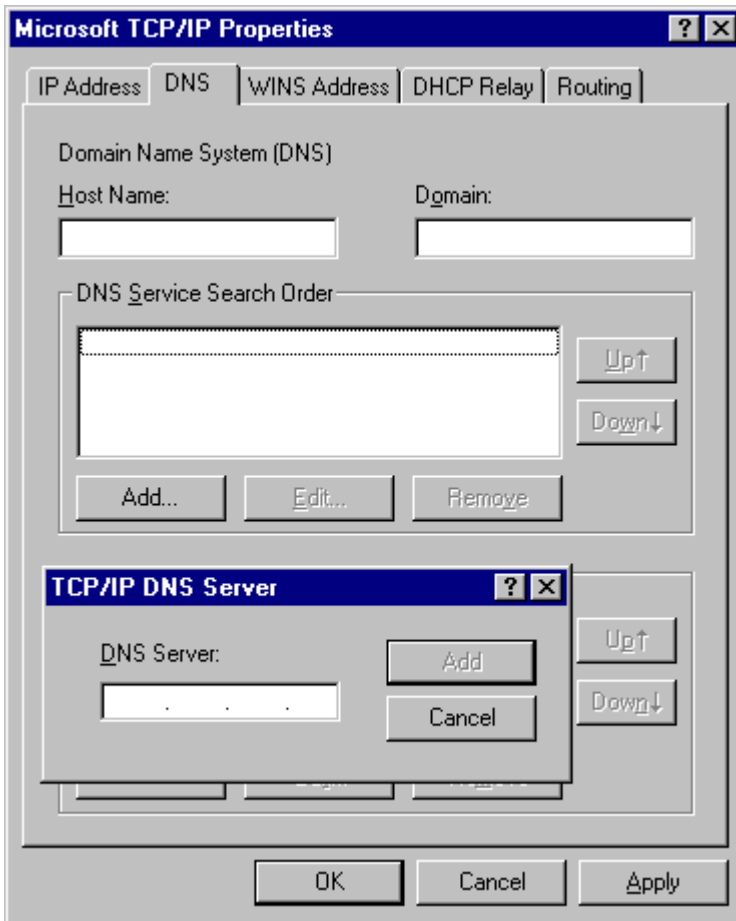

Figure 16: Windows NT4.0 - DNS

Checking TCP/IP Settings - Windows 2000:

1. Select *Control Panel - Network and Dial-up Connection*.
2. Right - click the *Local Area Connection* icon and select *Properties*. You should see a screen like the following:

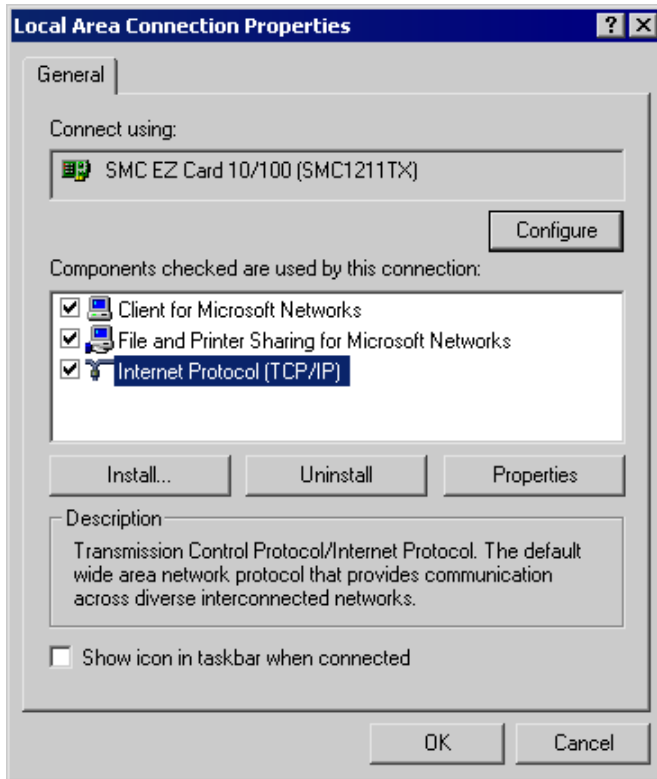

Figure 17: Network Configuration (Win 2000)

3. Select the *TCP/IP* protocol for your network card.
4. Click on the *Properties* button. You should then see a screen like the following.

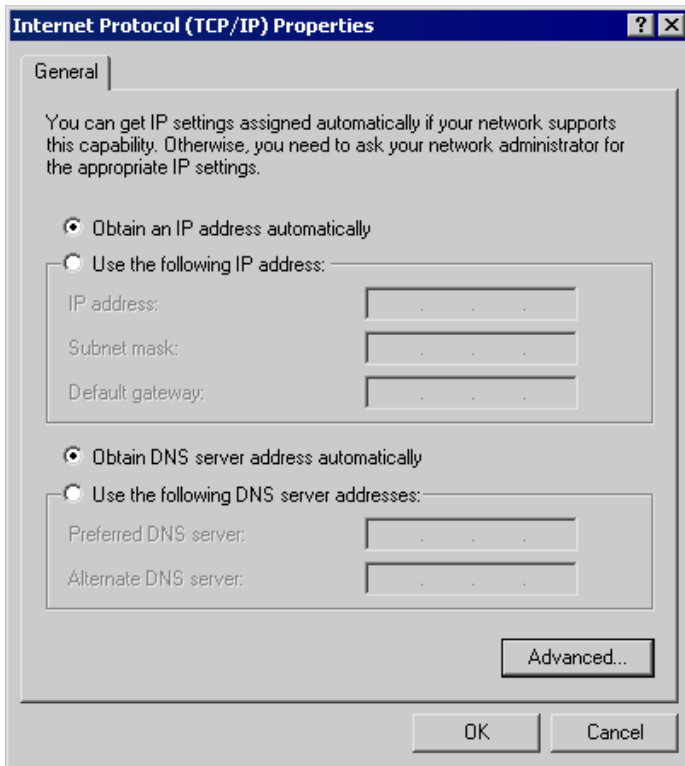

Figure 18: TCP/IP Properties (Win 2000)

5. Ensure your TCP/IP settings are correct, as described below.

Using DHCP

To use DHCP, select the radio button *Obtain an IP Address automatically*. This is the default Windows setting. **Using this is recommended.** By default, the TW100-BRF114 will act as a DHCP Server.

Restart your PC to ensure it obtains an IP Address from the TW100-BRF114.

Using a fixed IP Address ("Use the following IP Address")

If your PC is already configured, check with your network administrator before making the following changes.

- Enter the TW100-BRF114 's IP address in the *Default gateway* field and click *OK*. (Your LAN administrator can advise you of the IP Address they assigned to the TW100-BRF114.)
- If the *DNS Server* fields are empty, select *Use the following DNS server addresses*, and enter the DNS address or addresses provided by your ISP, then click *OK*.

Checking TCP/IP Settings - Windows XP

1. Select *Control Panel - Network Connection*.
2. Right click the *Local Area Connection* and choose *Properties*. You should see a screen like the following:

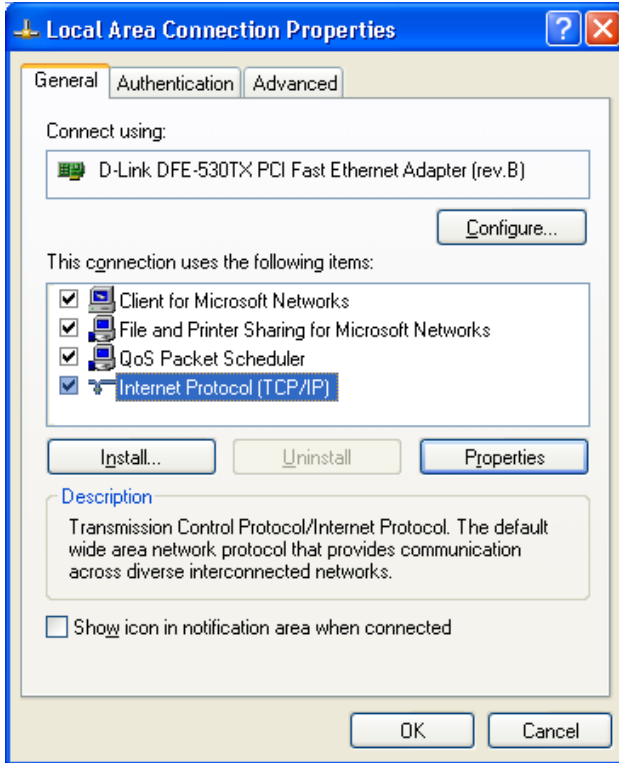

Figure 19: Network Configuration (Windows XP)

3. Select the *TCP/IP* protocol for your network card.
4. Click on the *Properties* button. You should then see a screen like the following.

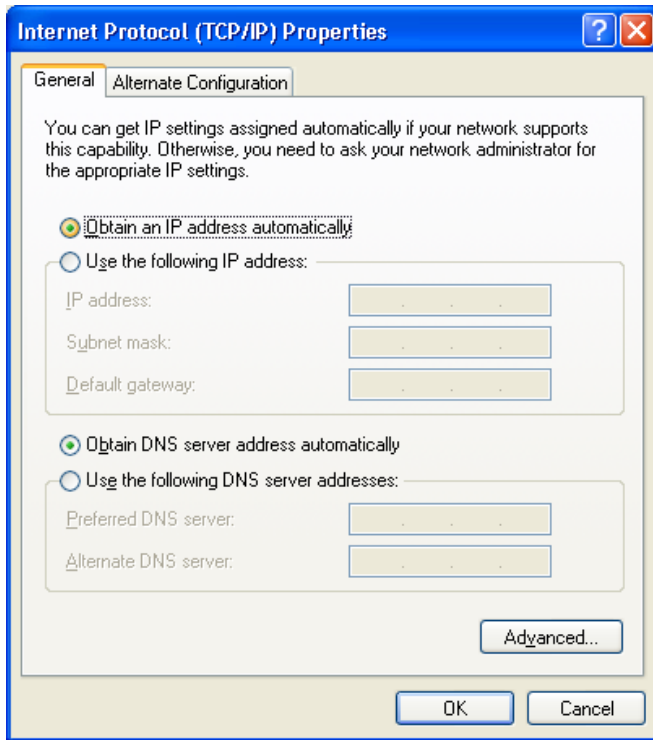

Figure 20: TCP/IP Properties (Windows XP)

5. Ensure your TCP/IP settings are correct.

Using DHCP

To use DHCP, select the radio button *Obtain an IP Address automatically*. This is the default Windows setting. **Using this is recommended.** By default, the TW100-BRF114 will act as a DHCP Server.

Restart your PC to ensure it obtains an IP Address from the TW100-BRF114.

Using a fixed IP Address ("Use the following IP Address")

If your PC is already configured, check with your network administrator before making the following changes.

- In the *Default gateway* field, enter the TW100-BRF114 's IP address and click *OK*. Your LAN administrator can advise you of the IP Address they assigned to the TW100-BRF114.
- If the *DNS Server* fields are empty, select *Use the following DNS server addresses*, and enter the DNS address or addresses provided by your ISP, then click *OK*.

Checking TCP/IP Settings - Windows Vista

1. From the Start menu, right-click Network, then click Properties. Now, the Network and Sharing Center displays.



2. Under Tasks located on the left-hand side of the window, click Manage network connections.



3. In Network Connections window displays, right click on the correct Local Area Connection, then click Properties.

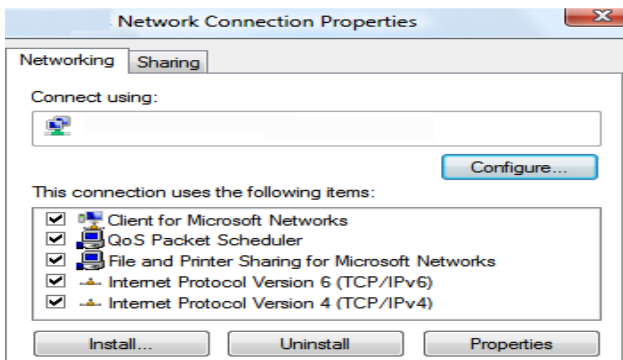

4. Pop-up window displays that states Windows needs your permission to continue. Click Continue to open the Local Area Connection Properties window

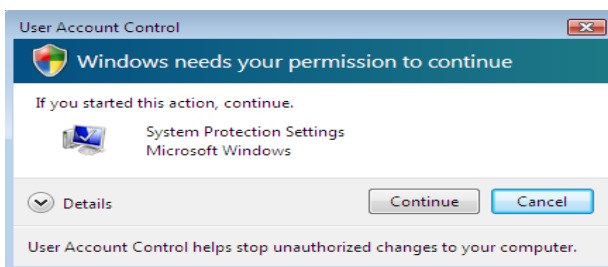

5. Select Internet Protocol Version 4 (TCP/IPv4), then click Properties. From the General tab, verify that Obtain an IP address automatically and Obtain DNS server address automatically are selected. Click the OK button.

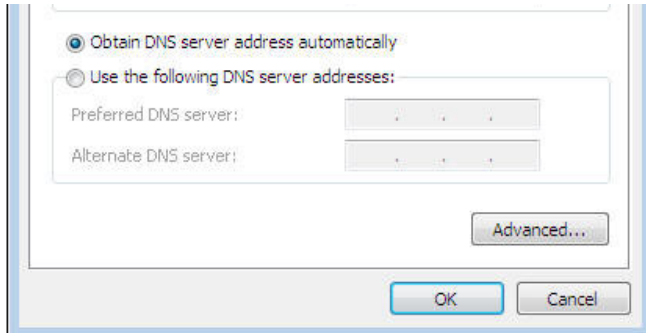

Internet Access

To configure your PCs to use the TW100-BRF114 for Internet access:

- Ensure that the DSL modem, Cable modem, or other permanent connection is functional.
- Use the following procedure to configure your Browser to access the Internet via the LAN, rather than by a Dial-up connection.

For Windows 9x/ME/2000

1. Select *Start Menu - Settings - Control Panel - Internet Options*.
2. Select the *Connection* tab, and click the *Setup* button.
3. Select "I want to set up my Internet connection manually, or I want to connect through a local area network (LAN)" and click *Next*.
4. Select "I connect through a local area network (LAN)" and click *Next*.
5. Ensure all of the boxes on the following Local area network Internet Configuration screen are **unchecked**.
6. Check the "No" option when prompted "Do you want to set up an Internet mail account now?".
7. Click *Finish* to close the Internet Connection Wizard.
Setup is now completed.

For Windows XP

1. Select *Start Menu - Control Panel - Network and Internet Connections*.
2. Select *Set up or change your Internet Connection*.
3. Select the *Connection* tab, and click the *Setup* button.
4. Cancel the pop-up "Location Information" screen.
5. Click *Next* on the "New Connection Wizard" screen.
6. Select "Connect to the Internet" and click *Next*.
7. Select "Set up my connection manually" and click *Next*.
8. Check "Connect using a broadband connection that is always on" and click *Next*.
9. Click *Finish* to close the New Connection Wizard.
Setup is now completed.

For Windows Vista

1. Select *Start Menu - Control Panel - Network and Internet Connections*
2. Select the *Network and Sharing Center* icon.
3. Select *Set up a Connection or Network*
4. A new window will pop up, choose the *Connection* option.
5. Select *Connect to the Internet*
6. Select the *Connection* from the list and click on next.

Accessing AOL

To access AOL (America On Line) through the TW100-BRF114, the *AOL for Windows* software must be configured to use TCP/IP network access, rather than a dial-up connection. The configuration process is as follows:

- Start the *AOL for Windows* communication software. Ensure that it is Version 2.5, 3.0 or later. This procedure will not work with earlier versions.
- Click the *Setup* button.

- Select *Create Location*, and change the location name from "New Locality" to "TW100-BRF114".
- Click *Edit Location*. Select *TCP/IP* for the *Network* field. (Leave the *Phone Number* blank.)
- Click *Save*, then *OK*.
Configuration is now complete.
- Before clicking "Sign On", always ensure that you are using the "TW100-BRF114 " location.

Macintosh Clients

From your Macintosh, you can access the Internet via the TW100-BRF114. The procedure is as follows.

1. Open the TCP/IP Control Panel.
2. Select *Ethernet* from the *Connect via* pop-up menu.
3. Select *Using DHCP Server* from the *Configure* pop-up menu. The DHCP Client ID field can be left blank.
4. Close the TCP/IP panel, saving your settings.

Note:

If using manually assigned IP addresses instead of DHCP, the required changes are:

- Set the *Router Address* field to the TW100-BRF114 's IP Address.
- Ensure your DNS settings are correct.

Linux Clients

To access the Internet via the TW100-BRF114, it is only necessary to set the TW100-BRF114 as the "Gateway".

Ensure you are logged in as "root" before attempting any changes.

Fixed IP Address

By default, most Unix installations use a fixed IP Address. If you wish to continue using a fixed IP Address, make the following changes to your configuration.

- Set your "Default Gateway" to the IP Address of the TW100-BRF114.
- Ensure your DNS (Name server) settings are correct.

To act as a DHCP Client (recommended)

The procedure below may vary according to your version of Linux and X -windows shell.

1. Start your X Windows client.
2. Select *Control Panel - Network*
3. Select the "Interface" entry for your Network card. Normally, this will be called "eth0".
4. Click the *Edit* button, set the "protocol" to "DHCP", and save this data.
5. To apply your changes
 - Use the "Deactivate" and "Activate" buttons, if available.
 - OR, restart your system.

Other Unix Systems

To access the Internet via the TW100-BRF114:

- Ensure the "Gateway" field for your network card is set to the IP Address of the TW100-BRF114.
- Ensure your DNS (Name Server) settings are correct.

Chapter 5

5

Operation and Status

This Chapter details the operation of the TW100-BRF114 and the status screens.

Operation

Once both the TW100-BRF114 and the PCs are configured, operation is automatic.

However, there are some situations where additional Internet configuration may be required:

- If using Internet-based *Communication Applications*, it may be necessary to specify which PC receives an incoming connection. Refer to *Chapter 6 - Internet Features* for further details.
- Applications which use non-standard connections or port numbers may be blocked by the TW100-BRF114 's built-in firewall. You can define such applications as *Special Applications* to allow them to function normally. Refer to *Chapter 6 - Internet Features* for further details.
- Some non-standard applications may require use of the *DMZ* feature. Refer to *Chapter 6 - Internet Features* for further details.

Status Screen

Use the *Status* link on the main menu to view this screen.

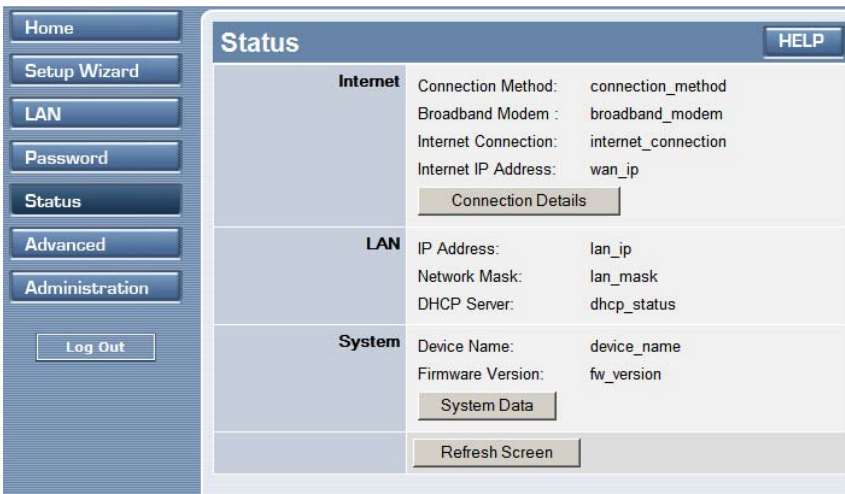

Figure 21: Status Screen

Data - Status Screen

Internet	
Connection Method	This indicates the current connection method, as set in the Setup

	Wizard.
Broadband Modem	This shows the connection status of the modem.
Internet Connection	<p>Current connection status:</p> <ul style="list-style-type: none"> • Active • Idle • Unknown • Failed <p>If there is an error, you can click the "Connection Details" button to find out more information.</p>
Internet IP Address	This IP Address is allocated by the ISP (Internet Service Provider).
"Connection Details" Button	Click this button to open a sub-window and view a detailed description of the current connection. Depending on the type of connection, a "log" may also be available.
LAN	
IP Address	The IP Address of the TW100-BRF114.
Network Mask	The Network Mask (Subnet Mask) for the IP Address above.
DHCP Server	<p>This shows the status of the DHCP Server function - either "Enabled" or "Disabled".</p> <p>For additional information about the PCs on your LAN, and the IP addresses allocated to them, use the <i>PC Database</i> option on the <i>Advanced</i> menu.</p>
System	
Device Name	This displays the current name of the TW100-BRF114.
Firmware Version	The current version of the firmware installed in the TW100-BRF114.
"System Data" Button	Clicking this button will open a Window which lists all system details and settings.
Buttons	
Connection Details	View the details of the current Internet connection. The sub-screen displayed will depend on the connection method used. See the following sections for details of each sub-screen.
System Data	Display all system information in a sub-window.
Restart Router	Restart (reboot) the Router. You will have to wait for the restart to be completed before continuing.
Refresh Screen	Update the data displayed on screen.

Connection Status - PPPoE

If using PPPoE (PPP over Ethernet), a screen like the following example will be displayed when the "Connection Details" button is clicked.

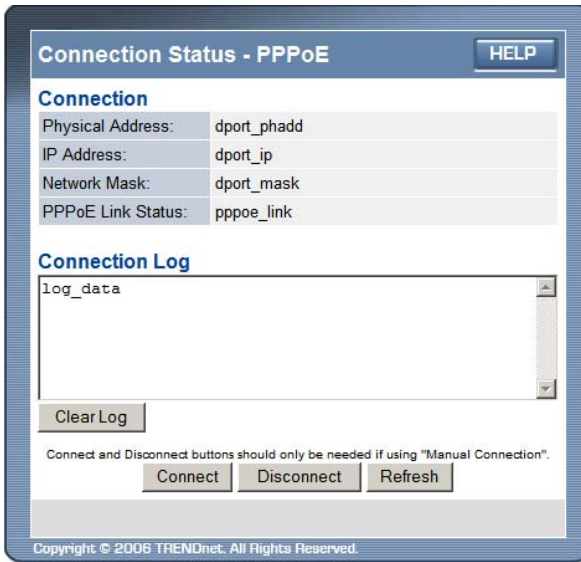

Figure 22: PPPoE Status Screen

Data - PPPoE Screen

Connection	
Physical Address	The hardware address of this device, as seen by remote devices on the Internet. (This is different to the hardware address seen by devices on the local LAN.)
IP Address	The IP Address of this device, as seen by Internet users. This address is allocated by your ISP (Internet Service Provider).
Network Mask	The Network Mask associated with the IP Address above.
PPPoE Link Status	<p>This indicates whether or not the connection is currently established.</p> <ul style="list-style-type: none"> • If the connection does not exist, the "Connect" button can be used to establish a connection. • If the connection currently exists, the "Disconnect" button can be used to break the connection.
Connection Log	
Connection Log	<ul style="list-style-type: none"> • The Connection Log shows status messages relating to the existing connection. • The most common messages are listed in the table below. • The "Clear Log" button will restart the Log, while the Refresh button will update the messages shown on screen.
Buttons	
Connect	If not connected, establish a connection to your ISP.
Disconnect	If connected to your ISP, hang up the connection.
Clear Log	Delete all data currently in the Log. This will make it easier to read new messages.
Refresh	Update the data on screen.

Connection Log Messages

Message	Description
Connect on Demand	Connection attempt has been triggered by the "Connect automatically, as required" setting.
Manual connection	Connection attempt started by the "Connect" button.
Reset physical connection	Preparing line for connection attempt.
Connecting to remote server	Attempting to connect to the ISP's server.
Remote Server located	ISP's Server has responded to connection attempt.
Start PPP	Attempting to login to ISP's Server and establish a PPP connection.
PPP up successfully	Able to login to ISP's Server and establish a PPP connection.
Idle time-out reached	The connection has been idle for the time period specified in the "Idle Time-out" field. The connection will now be terminated.
Disconnecting	The current connection is being terminated, due to either the "Idle Time-out" above, or "Disconnect" button being clicked.
Error: Remote Server not found	ISP's Server did not respond. This could be a Server problem, or a problem with the link to the Server.
Error: PPP Connection failed	Unable to establish a PPP connection with the ISP's Server. This could be a login problem (name or password) or a Server problem.
Error: Connection to Server lost	The existing connection has been lost. This could be caused by a power failure, a link failure, or Server failure.
Error: Invalid or unknown packet type	The data received from the ISP's Server could not be processed. This could be caused by data corruption (from a bad link), or the Server using a protocol which is not supported by this device.

Connection Status - PPTP

If using PPTP (Peer-to-Peer Tunneling Protocol), a screen like the following example will be displayed when the "Connection Details" button is clicked.

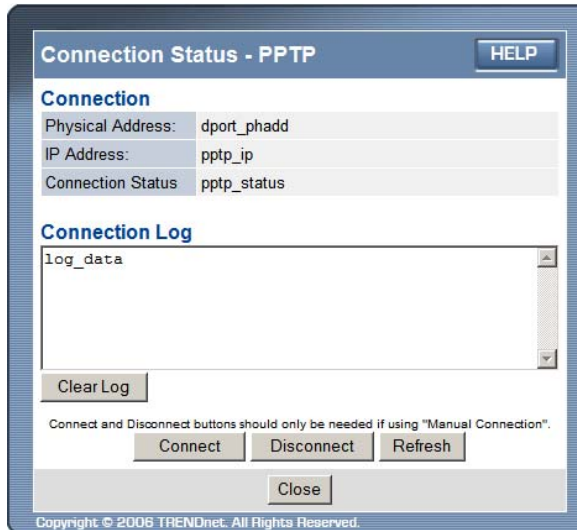

Figure 23: PPTP Status Screen

Data - PPTP Screen

Connection	
Physical Address	The hardware address of this device, as seen by remote devices on the Internet. (This is different to the hardware address seen by devices on the local LAN.)
IP Address	The IP Address of this device, as seen by Internet users. This address is allocated by your ISP (Internet Service Provider).
PPTP Status	This indicates whether or not the connection is currently established. <ul style="list-style-type: none"> • If the connection does not exist, the "Connect" button can be used to establish a connection. • If the connection currently exists, the "Disconnect" button can be used to break the connection.
Connection Log	
Connection Log	<ul style="list-style-type: none"> • The Connection Log shows status messages relating to the existing connection. • The "Clear Log" button will restart the Log, while the Refresh button will update the messages shown on screen.
Buttons	
Connect	If not connected, establish a connection to your ISP.
Disconnect	If connected to your ISP, hang up the connection.
Clear Log	Delete all data currently in the Log. This will make it easier to read new messages.
Refresh	Update the data on screen.

Connection Status - Telstra Big Pond

An example screen is shown below.

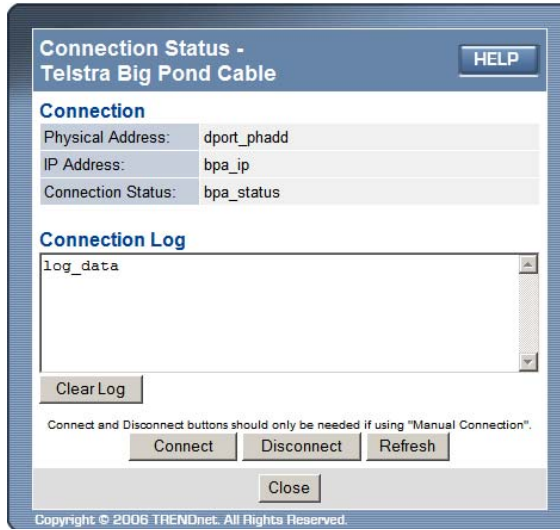

Figure 24: Telstra Big Pond Status Screen

Data - Telstra Big Pond Screen

Connection	
Physical Address	The hardware address of this device, as seen by remote devices. (This is different to the hardware address seen by devices on the local LAN.)
IP Address	The IP Address of this device, as seen by Internet users. This address is allocated by your ISP (Internet Service Provider).
Connection Status	<p>This indicates whether or not the connection is currently established.</p> <ul style="list-style-type: none"> • If the connection does not exist, the "Connect" button can be used to establish a connection. • If the connection currently exists, the "Disconnect" button can be used to break the connection. • Normally, it is not necessary to use the Connect and Disconnect buttons unless the setting "Connect automatically, as required" is disabled.
Connection Log	
Connection Log	<ul style="list-style-type: none"> • The Connection Log shows status messages relating to the existing connection. • The Clear Log button will restart the Log, while the Refresh button will update the messages shown on screen.
Buttons	
Connect	If not connected, establish a connection to Telstra Big Pond.

Disconnect	If connected to Telstra Big Pond, terminate the connection.
Clear Log	Delete all data currently in the Log. This will make it easier to read new messages.
Refresh	Update the data on screen.

Connection Details - SingTel RAS

If using the SingTel RAS access method, a screen like the following example will be displayed when the "Connection Details" button is clicked.

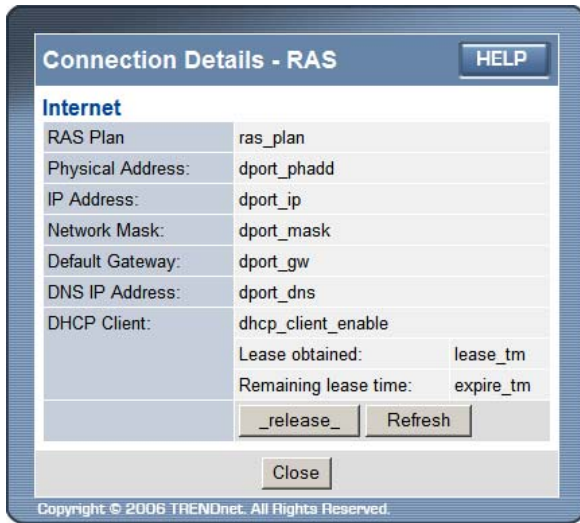

Figure 25: Connection Details - SingTel RAS

Data - SingTel RAS Screen

Internet	
RAS Plan	The RAS Plan which is currently used.
Physical Address	The hardware address of this device, as seen by remote devices on the Internet. (This is different to the hardware address seen by devices on the local LAN.)
IP Address	The IP Address of this device, as seen by Internet users. This address is allocated by your ISP (Internet Service Provider).
Network Mask	The Network Mask associated with the IP Address above.
Default Gateway	The IP Address of the remote Gateway or Router associated with the IP Address above.
DNS IP Address	The IP Address of the Domain Name Server which is currently used.
DHCP Client	<p>This will show "Enabled" or "Disabled", depending on whether or not this device is functioning as a DHCP client.</p> <p>If "Enabled" the "Remaining lease time" field indicates when the IP Address allocated by the DHCP Server will expire. The lease is automatically renewed on expiry; use the "Renew" button if you wish</p>

	to manually renew the lease immediately.
Buttons	
Release/Renew Button will display EITHER "Release" OR "Renew"	<p>This button is only useful if the IP address shown above is allocated automatically on connection. (Dynamic IP address). If you have a Fixed (Static) IP address, this button has no effect.</p> <ul style="list-style-type: none"> • If the ISP's DHCP Server has NOT allocated an IP Address for the TW100-BRF114, this button will say "Renew". Clicking the "Renew" button will attempt to re-establish the connection and obtain an IP Address from the ISP's DHCP Server. • If an IP Address has been allocated to the TW100-BRF114 (by the ISP's DHCP Server), this button will say "Release". Clicking the "Release" button will break the connection and release the IP Address.
Refresh	Update the data shown on screen.

Connection Details - Fixed/Dynamic IP Address

If your access method is "Direct" (no login), a screen like the following example will be displayed when the "Connection Details" button is clicked.

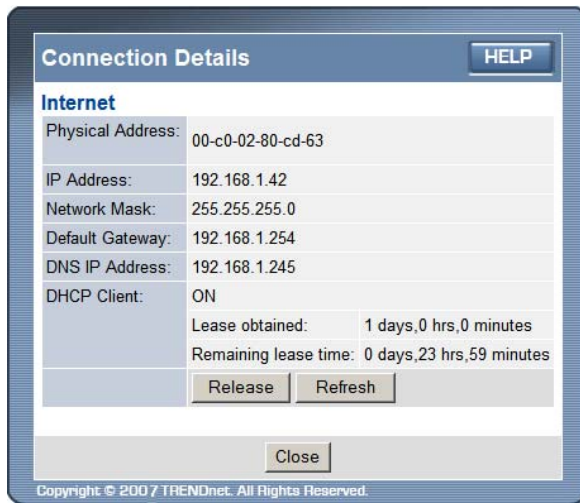

Figure 26: Connection Details - Fixed/Dynamic IP Address

Data - Fixed/Dynamic IP address Screen

Internet	
Physical Address	The hardware address of this device, as seen by remote devices on the Internet. (This is different to the hardware address seen by devices on the local LAN.)
IP Address	The IP Address of this device, as seen by Internet users. This address is allocated by your ISP (Internet Service Provider).
Network Mask	The Network Mask associated with the IP Address above.
Default Gateway	The IP Address of the remote Gateway or Router associated with the IP Address above.

DNS IP Address	The IP Address of the Domain Name Server which is currently used.
DHCP Client	<p>This will show "Enabled" or "Disabled", depending on whether or not this device is functioning as a DHCP client.</p> <p>If "Enabled" the "Remaining lease time" field indicates when the IP Address allocated by the DHCP Server will expire. The lease is automatically renewed on expiry; use the "Renew" button if you wish to manually renew the lease immediately.</p>
Buttons	
Release/Renew Button will display EITHER "Release" OR "Renew"	<p>This button is only useful if the IP address shown above is allocated automatically on connection. (Dynamic IP address). If you have a Fixed (Static) IP address, this button has no effect.</p> <ul style="list-style-type: none"> • If the ISP's DHCP Server has NOT allocated an IP Address for the TW100-BRF114, this button will say "Renew". Clicking the "Renew" button will attempt to re-establish the connection and obtain an IP Address from the ISP's DHCP Server. • If an IP Address has been allocated to the TW100-BRF114 (by the ISP's DHCP Server), this button will say "Release". Clicking the "Release" button will break the connection and release the IP Address.
Refresh	Update the data shown on screen.

Chapter 6

6

Internet Features

This Chapter explains when and how to use the TW100-BRF114's "Internet" Features.

Overview

The following advanced features are covered in this Chapter:

- Advanced Internet
- Dynamic DNS
- MAC Address
- Virtual Servers

Advanced Internet Screen

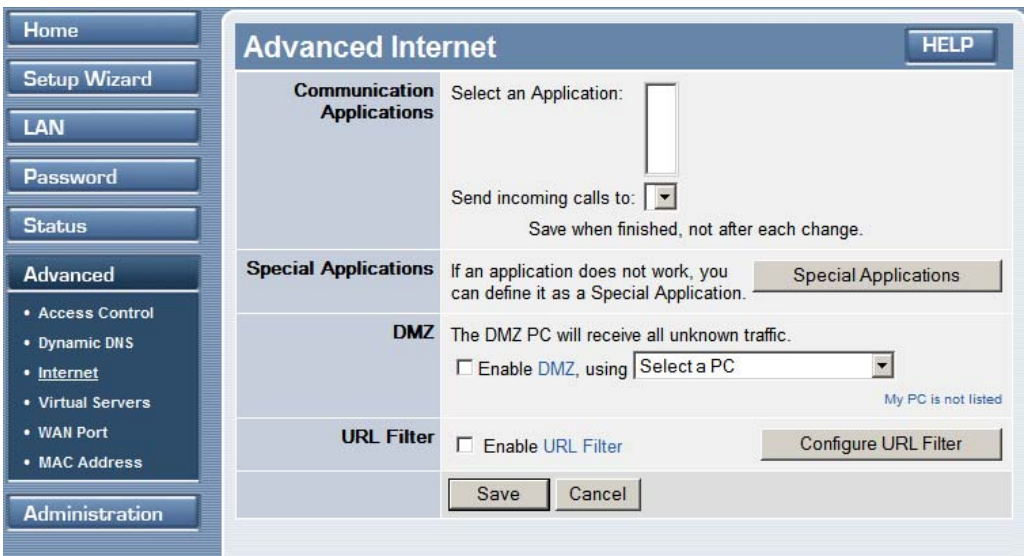

Figure 27: Internet Screen

This screen allows configuration of all advanced features relating to Internet access.

- Communication Applications
- Special Applications
- DMZ
- URL filter

Communication Applications

Most applications are supported transparently by the TW100-BRF114. But sometimes it is not clear which PC should receive an incoming connection. This problem could arise with the *Communication Applications* listed on this screen.

If this problem arises, you can use this screen to set which PC should receive an incoming connection, as described below.

Communication Applications	
Select an Application	This lists applications which may generate incoming connections, where the destination PC (on your local LAN) is unknown.
Send incoming calls to	<p>This lists the PCs on your LAN.</p> <ul style="list-style-type: none"> • If necessary, you can add PCs manually, using the "PC Database" option on the advanced menu. • For each application listed above, you can choose a destination PC. • There is no need to "Save" after each change; you can set the destination PC for each application, then click "Save".

Special Applications

If you use Internet applications which use non-standard connections or port numbers, you may find that they do not function correctly because they are blocked by the TW100-BRF114 's firewall. In this case, you can define the application as a "Special Application".

Special Applications Screen

This screen can be reached by clicking the *Special Applications* button on the *Advanced Internet* screen.

You can then define your Special Applications. You will need detailed information about the application; this is normally available from the supplier of the application.

Also, note that the terms "Incoming" and "Outgoing" on this screen refer to traffic from the client (PC) viewpoint.

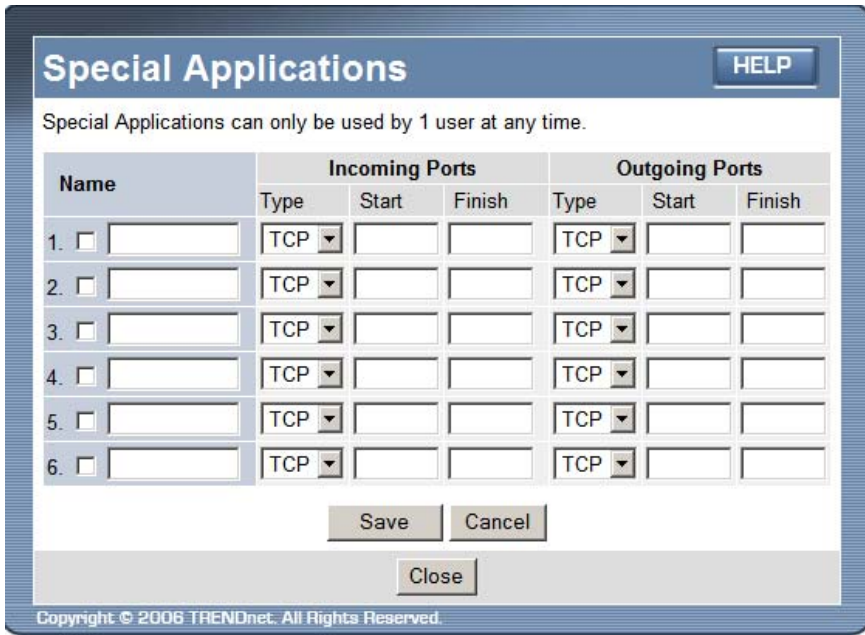

Figure 28: Special Applications Screen

Data - Special Applications Screen

Checkbox	Use this to Enable or Disable this Special Application as required.
Name	Enter a descriptive name to identify this Special Application.
Incoming Ports	<ul style="list-style-type: none"> • Type - Select the protocol (TCP or UDP) used when you receive data from the special application or service. (Note: Some applications use different protocols for outgoing and incoming data). • Start - Enter the beginning of the range of port numbers used by the application server, for data you receive. If the application uses a single port number, enter it in both the "Start" and "Finish" fields. • Finish - Enter the end of the range of port numbers used by the application server, for data you receive.
Outgoing Ports	<ul style="list-style-type: none"> • Type - Select the protocol (TCP or UDP) used when you send data to the remote system or service. • Start - Enter the beginning of the range of port numbers used by the application server, for data you send to it. If the application uses a single port number, enter it in both the "Start" and "Finish" fields. • Finish - Enter the end of the range of port numbers used by the application server, for data you send to it. If the application uses a single port number, enter it in both the "Start" and "Finish" fields.

Using a Special Application

- Configure the *Special Applications* screen as required.
- On your PC, use the application normally. Remember that only one (1) PC can use each Special application at any time. Also, when 1 PC is finished using a particular Special Application, there may need to be a "Time-out" before another PC can use the same Special Application. The "Time-out" period may be up to 3 minutes.



If an application still cannot function correctly, try using the "DMZ" feature.

DMZ

This feature, if enabled, allows one (1) computer on your LAN to be exposed to all users on the Internet, allowing unrestricted 2-way communication between the "DMZ PC" and other Internet users or Servers.

- This allows almost any application to be used on the "DMZ PC".
- The "DMZ PC" will receive all "Unknown" connections and data.
- If the DMZ feature is enabled, you must select the PC to be used as the "DMZ PC".
- The DMZ feature can be Enabled and Disabled on the *Advanced Internet* screen.



The "DMZ PC" is effectively outside the Firewall, making it more vulnerable to attacks. For this reason, you should only enable the DMZ feature when required.

URL Filter Screen

Click the "Configure URL Filter" button on the *Advanced Internet* screen to access the *URL Filter* screen. An example screen is shown below.

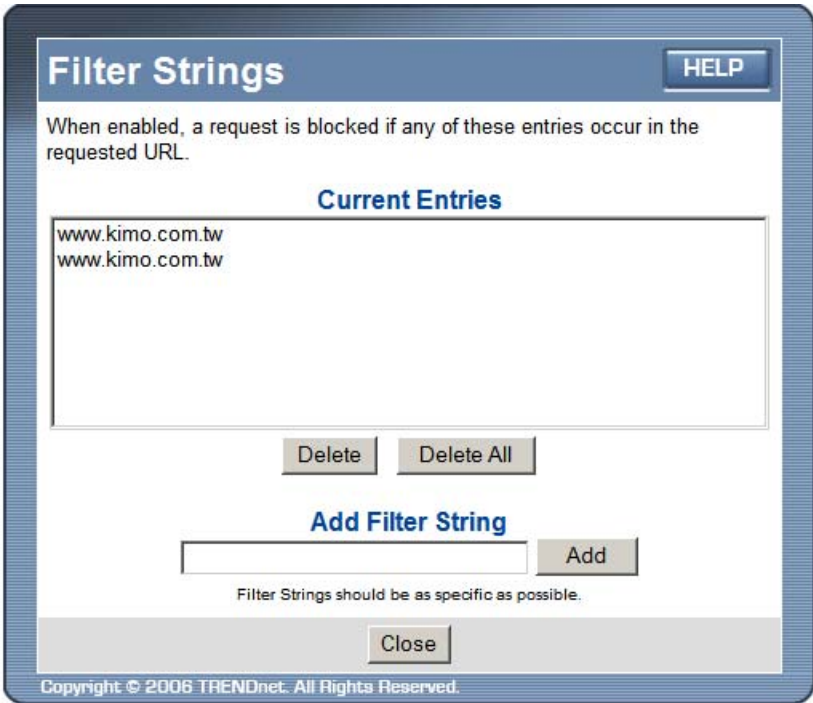

Figure 29: URL Filter Screen

Data - URL Filter Screen

Filter Strings	
Current Entries	This lists any existing entries. If you have not entered any values, this list will be empty.
Add Filter String	To add an entry to the list, enter it here, and click the "Add" button. An entry may be a Domain name (e.g. www.trash.com) or simply a string. (e.g. ads/) Any URL which contains ANY entry ANYWHERE in the URL will be blocked.
Buttons	
Delete/Delete All	Use these buttons to delete the selected entry or all entries, as required. Multiple entries can be selected by holding down the CTRL key while selecting. (On the Macintosh, hold the SHIFT key while selecting.)
Add	Use this to add the current Filter String to the site list.

Dynamic DNS (Domain Name Server)

This free service is very useful when combined with the *Virtual Server* feature. It allows Internet users to connect to your Virtual Servers using a URL, rather than an IP Address.

This also solves the problem of having a dynamic IP address. With a dynamic IP address, your IP address may change whenever you connect, which makes it difficult to connect to you.

The Service works as follows:

1. You must register for the service at <http://www.dyndns.org> (Registration is free). Your password will be E-mailed to you.
2. After registration, use the "Create New Host" option (at www.dyndns.org) to request your desired Domain name.
3. Enter your data from www.dyndns.org in the TW100-BRF114 's DDNS screen.
4. The TW100-BRF114 will then automatically ensure that your current IP Address is recorded at <http://www.dyndns.org>
5. From the Internet, users will be able to connect to your Virtual Servers (or DMZ PC) using your Domain name, as shown on this screen.

Dynamic DNS Screen

Select *Internet* on the main menu, then *Dynamic DNS*, to see a screen like the following:

Figure 30: DDNS Screen

Data - Dynamic DNS Screen

DDNS Service	
DDNS Service	<ul style="list-style-type: none"> • You must sign up first to create a new account before using the service. The service is free. • Click this link to connect to the www.dyndns.org Web site. • Your initial password will be E-mailed to you; you can change this later if you wish. • After registration, use the "Create New Host" link (on the www.dyndns.org Web site) to request a domain name.

DDNS Data	
User Name	Enter the "User name" specified at the www.dyndns.org Web site when you registered.
Password	Enter your current password for www.dyndns.org
Domain Name	<ul style="list-style-type: none">• Enter your domain name, as allocated at www.dyndns.org.• The name should consist only of letters and the hyphen (dash). Using any other characters may cause problems..
DDNS Status	<p>This message is returned by the DDNS Server at www.dyndns.org</p> <ul style="list-style-type: none">• Normally, this message should be "Update successful" (current IP address was updated on the www.dyndns.org server).• If the message is "No host", this indicates the host name entered was not allocated to you. You need to connect to www.dyndns.org and correct this problem.

MAC Address

The MAC (hardware) address is a low-level network identifier. It may be called "MAC Address", "Hardware Address", or "Physical Address". On a PC, this address is associated with the Network card or adapter. The address on the *MAC Address* screen is the address on the Internet (WAN port) interface, and has no effect on the LAN interface.

- If your ISP asks for the "Network Adapter Address", "Physical Address", "Hardware Address", or "MAC Address" for the PC the DSL/Cable modem is connected to, provide this value.
- If your ISP has already recorded a MAC address, you can change the address used by the Firewall Router to match the address recorded by your ISP.

MAC Address Screen

Select *MAC Address* from the *Advanced* menu to reach a screen like the example below.

Figure 31: MAC address Screen

Data - MAC address Screen

MAC (hardware) Address	The current MAC (hardware) address is displayed. If your ISP has recorded a Hardware Address, you can "spoof" that address by entering it in the address field. The hardware address consists of 12 characters, where each character is a digit (0..9) or a character between A and F.
Buttons	
Default	Inserts the default MAC address into the MAC address field. You must click "Save" to actually change the address used.
Copy from PC	Inserts the MAC address from your PC into the MAC address field. You must click "Save" to actually change the address used.
Save	Save your changes to the Firewall Router.
Cancel	Reverse any changes made since the last "Save".



If the MAC address is changed, the Firewall Router must restart.

Virtual Servers

This feature allows you to make Servers on your LAN accessible to Internet users. Normally, Internet users would not be able to access a server on your LAN because:

- Your Server does not have a valid external IP Address.
- Attempts to connect to devices on your LAN are blocked by the firewall in this device.

The "Virtual Server" feature solves these problems and allows Internet users to connect to your servers, as illustrated below.

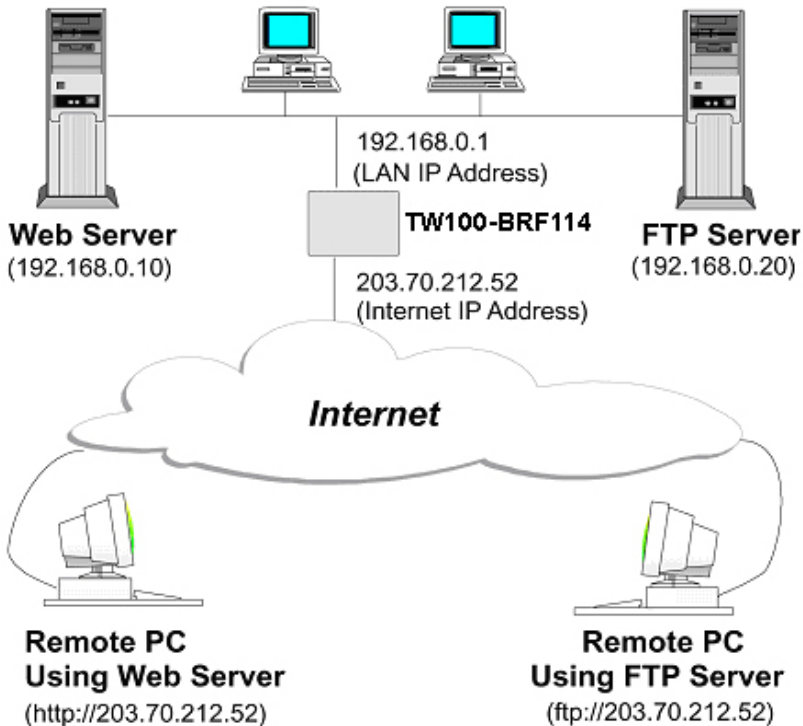

Figure 32: Virtual Servers

IP Address seen by Internet Users

Note that, in this illustration, both Internet users are connecting to the same IP Address, but using different protocols.

To Internet users, all virtual Servers on your LAN have the same IP Address. This IP Address is allocated by your ISP.

This address should be static, rather than dynamic, to make it easier for Internet users to connect to your Servers.

However, you can use the *DDNS (Dynamic DNS)* feature to allow users to connect to your Virtual Servers using a URL, instead of an IP Address.

Virtual Servers Screen

The *Virtual Servers* screen is reached by the *Virtual Servers* link on the *Internet* menu. An example screen is shown below.

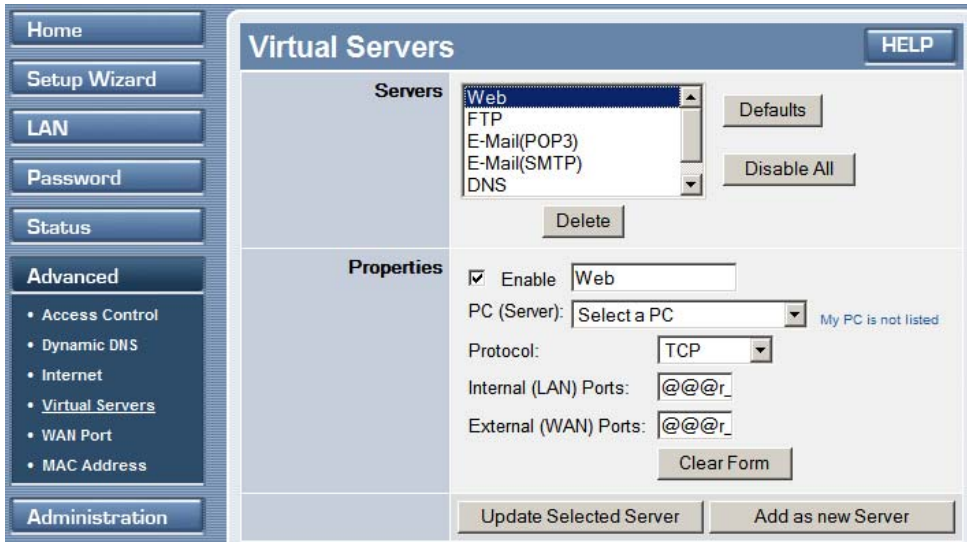

Figure 33: Virtual Servers Screen

This screen lists a number of pre-defined Servers, and allows you to define your own Servers. Details of the selected Server are shown in the "Properties" area.

Data - Virtual Servers Screen

Servers	
Servers	This lists a number of pre-defined Servers, plus any Servers you have defined. Details of the selected Server are shown in the "Properties" area.
Properties	
Enable	Use this to Enable or Disable support for this Server, as required. <ul style="list-style-type: none"> • If Enabled, any incoming connections will be forwarded to the selected PC. • If Disabled, any incoming connection attempts will be blocked.
PC (Server)	Select the PC for this Server. The PC must be running the appropriate Server software.
Protocol	Select the protocol (TCP or UDP) used by the Server.
Internal Port No.	Enter the port number which the Server software is configured to use.
External Port No.	The port number used by Internet users when connecting to the Server. This is normally the same as the Internal Port Number. If it is different, this device will perform a "mapping" or "translation" function, allowing the server to use one port address, while clients use a different port address.

Buttons	
Defaults	This will delete any Servers you have defined, and set the pre-defined Servers to use their default port numbers.
Disable All	This will cause the "Enable" setting of all Virtual Servers to be set OFF.
Add	Add a new entry to the Virtual Server list, using the data shown in the "Properties" area on screen. The entry selected in the list is ignored, and has no effect.
Update	Update the current Virtual Server entry, using the data shown in the "Properties" area on screen.
Delete	Delete the current Virtual Server entry. Note that the pre-defined Servers can not be deleted. Only Servers you have defined yourself can be deleted.
Clear Form	Clear all data from the "Properties" area, ready for input of a new Virtual Server entry.

**Note!**

For each entry, the PC must be running the appropriate Server software.

Defining your own Virtual Servers

If the type of Server you wish to use is not listed on the *Virtual Servers* screen, you can define and manage your own Servers:

Create a new Server:

1. Click "Clear Form"
2. Enter the required data, as described above.
3. Click "Add".
4. The new Server will now appear in the list.

Modify (Edit) a Server:

1. Select the desired Server from the list
2. Make any desired changes (for example, change the Enable/Disable setting).
3. Click "Update" to save changes to the selected Server.

Delete a Server:

1. Select the entry from the list.
2. Click "Delete".

Note: You can only delete Servers you have defined. Pre-defined Server cannot be deleted.

**Note!**

From the Internet, ALL Virtual Servers have the IP Address allocated by your ISP.

Connecting to the Virtual Servers

Once configured, anyone on the Internet can connect to your Virtual Servers. They must use the Internet IP Address (the IP Address allocated to you by your ISP).

e.g.

`http://203.70.212.52`

`ftp://203.70.212.52`

It is more convenient if you are using a Fixed IP Address from your ISP, rather than Dynamic. However, you can use the *Dynamic DNS* feature, described in the following section, to allow users to connect to your Virtual Servers using a URL, rather than an IP Address.

Chapter 7

Other Features and Settings



This Chapter explains the screens and settings available via the "Other" menu.

Overview

Normally, it is not necessary to use these screens, or change any settings. These screens and settings are provided to deal with non-standard situations, or to provide additional options for advanced users.

The screens available are:

- | | |
|--------------------------|---|
| Access Control | The Access Control feature allows administrators to restrict the level of Internet Access available to PCs on your LAN. With the default settings, everyone has unrestricted Internet access. |
| Remote Management | This feature allows you to manage the TW100-BRF114 via the Internet. |
| PC Database | This is the list of PCs shown when you select the "DMZ PC", "Virtual Server", or "Internet Application". This database is maintained automatically, but you can add and delete entries for PCs which use a Fixed (Static) IP Address. |
| Upgrade Firmware | The firmware (software) in the TW100-BRF114 can be upgraded using your Web Browser. |
| Options | Set options for UPnP, backup DNS, and MTU (Maximum Transmission Unit) |
| Security | Security options. For most situations, the default settings do not need to be changed. |
| Logs | Enable and view the logs, and E-mail logs if required. |
| Routing | Only required if your LAN has other Routers or Gateways. |

Access Control

This feature is accessed by the *Access Control* link on the Advanced menu.

Overview

The Access Control feature allows administrators to restrict the level of Internet Access available to PCs on your LAN. With the default settings, everyone has unrestricted Internet access.

To use this feature:

1. Set the desired restrictions on the "Default" group. All PCs are in the "Default" group unless explicitly moved to another group.
2. Set the desired restrictions on the other groups ("Group 1", "Group 2", "Group 3" and "Group 4") as needed.
3. Assign PC to the groups as required.



Restrictions are imposed by blocking "Services", or types of connections. All common Services are pre-defined. If required, you can also define your own Services.

Access Control Screen

To view this screen, select the *Access Control* link on the Advanced menu.

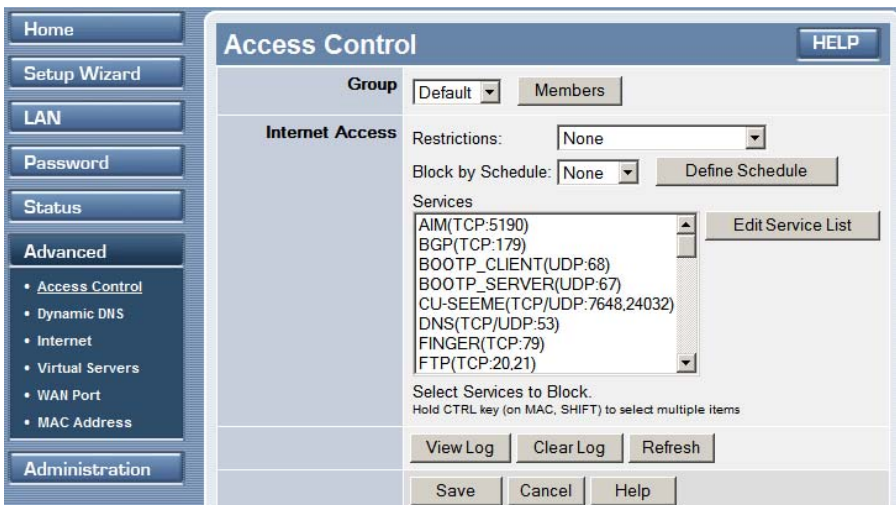

Figure 34: Access Control Screen

Data - Access Control Screen

Group	
Group	Select the desired Group. The screen will update to display the settings for the selected Group. Groups are named "Default", "Group 1", "Group 2", "Group 3" and "Group 4", and cannot be re-named.
"Members" Button	<p>Click this button to add or remove members from the current Group.</p> <ul style="list-style-type: none"> • If the current group is "Default", then members can not be added or deleted. This group contains PCs not allocated to any other group. • To remove PCs from the Default Group, assign them to another Group. • To assign PCs to the Default Group, delete them from the Group they are currently in. <p>See the following section for details of the <i>Group Members</i> screen.</p>
Internet Access	
Restrictions	<p>Select the desired options for the current group:</p> <ul style="list-style-type: none"> • None - Nothing is blocked. Use this to create the least restrictive group. • Block all Internet access - All traffic via the WAN port is blocked. Use this to create the most restrictive group. • Block selected Services - You can select which Services are to block. Use this to gain fine control over the Internet access for a group.
Block by Schedule	If Internet access is being blocked, you can choose to apply the blocking only during scheduled times. (If access is not blocked, no Scheduling is possible, and this setting has no effect.)
Define Schedule Button	Clicking this will open a sub-window where you can define or modify the Schedule.
Services	This lists all defined Services. Select the Services you wish to block. To select multiple services, hold the CTRL key while selecting. (On the Macintosh, hold the SHIFT key rather than CTRL.)
Edit Service List Button	If you wish to define additional Services, or manage the Service list, click this button to open the "Services" screen.
Buttons	
Members	<p>Click this button to add or remove members from the current Group.</p> <p>If the current group is "Default", then members can not be added or deleted. This group contains PCs not allocated to any other group.</p> <p>See the following section for details of the <i>Group Members</i> screen.</p>
Define Schedule	Click this to open a sub-window where you can define or modify the Schedule.

Edit Service List	If you wish to define additional Services, or manage the Service list, click this button to open the "Services" screen.
View Log	Click this to open a sub-window where you can view the "Access Control" log. This log shows attempted Internet accesses which have been blocked by the Access Control feature.
Clear Log	Click this to clear and restart the "Access Control" log, making new entries easier to read.

Group Members Screen

This screen is displayed when the *Members* button on the *Access Control* screen is clicked.



Figure 35: Group Members

Use this screen to add or remove members (PCs) from the current group.

- The "Del >>" button will remove the selected PC (in the *Members* list) from the current group.
- The "<< Add" button will add the selected PC (in the *Other PCs* list) to the current group.



**PCs not assigned to any group will be in the "Default" group.
PCs deleted from any other Group will be added to the "Default" group.**

Default Schedule Screen

This screen is displayed when the *Define Schedule* button on the *Access Control* screen is clicked.

- This schedule can be (optionally) applied to any Access Control Group.
- Blocking will be performed during the scheduled time (between the "Start" and "Finish" times.)
- Two (2) separate sessions or periods can be defined.
- Times must be entered using a 24 hr clock.
- If the time for a particular day is blank, no action will be performed.

Day	Session 1		Session 2	
	Start	Finish	Start	Finish
Monday	07 : 00	18 : 00	:	:
Tuesday	07 : 00	18 : 00	:	:
Wednesday	07 : 00	18 : 00	:	:
Thursday	07 : 00	18 : 00	:	:
Friday	07 : 00	18 : 00	:	:
Saturday	:	:	:	:
Sunday	:	:	:	:

Figure 36: Default Schedule Screen

Data - Default Schedule Screen

Day	Each day of the week can scheduled independently.
Session 1 Session 2	Two (2) separate sessions or periods can be defined. Session 2 can be left blank if not required.
Start Time	Enter the start using a 24 hr clock.
Finish Time	Enter the finish time using a 24 hr clock.

Services Screen

This screen is displayed when the *Edit Service List* button on the *Access Control* screen is clicked.



Figure 37: Access Control - Services

Data - Services Screen

Available Services	
Available Services	This lists all the available services.
"Delete" button	Use this to delete any Service you have added. Pre-defined Services can not be deleted.
Add New Service	
Name	Enter a descriptive name to identify this service.
Type	Select the protocol (TCP, UDP, ICMP) used to the remote system or service.
Start Port	For TCP and UDP Services, enter the beginning of the range of port numbers used by the service. If the service uses a single port number, enter it in both the "Start" and "Finish" fields.
Finish Port	For TCP and UDP Services, enter the end of the range of port numbers used by the service. If the service uses a single port number, enter it in both the "Start" and "Finish" fields.
ICMP Type	For ICMP Services, enter the type number of the required service.

Access Control Log

To check the operation of the Access Control feature, an *Access Control Log* is provided. Click the *View Log* button on the *Access Control* screen to view this log.

This log shows attempted Internet accesses which have been **blocked** by the *Access Control* function.

Data shown in this log is as follows:

Date/Time	Date and Time of the attempted access.
Name	If known, the name of the PC whose access was blocked. This name is taken from the <i>Network Clients</i> database
Source IP address	The IP Address of the PC or device whose access request was blocked
MAC address	The hardware or physical address of the PC or device whose access request was blocked
Destination	The destination URL or IP address

Remote Management

This feature allows you to manage the TW100-BRF114 via the Internet.

Figure 38: Remote Management Screen

Data - Remote Management Screen

Remote Management	
Enable Remote Management	Enable to allow Management via the Internet. If Disabled, this device will ignore management connection attempts from the Internet.
Port Number	Enter a port number between 1024 and 65535 (8080 is recommended). This port number must be specified when you connect (see below). Note: The default port number for HTTP (Web) connections is port 80, but using port 80 here will prevent the use of a Web "Virtual Server" on your LAN. (See <i>Advanced Internet - Virtual Servers</i>)
Current IP Address	You must use this IP Address to connect (see below). This IP Address is allocated by your ISP. But if using a Dynamic IP Address, this value can change each time you connect to your ISP. So it is better if your ISP allocates you a Fixed IP Address.

To connect from a remote PC via the Internet

1. Ensure your Internet connection is established, and start your Web Browser.
2. In the "Address" bar, enter "HTTP://" followed by the Internet IP Address of the TW100-BRF114. If the port number is not 80, the port number is also required. (After the IP Address, enter ":" followed by the port number.)
e.g.

HTTP://123.123.123.123:8080

This example assumes the WAN IP Address is 123.123.123.123, and the port number is 8080.

PC Database

The PC Database is used whenever you need to select a PC (e.g. for the "DMZ" PC). It eliminates the need to enter IP addresses. Also, you do not need to use fixed IP addresses on your LAN.

PC Database Screen

An example PC Database screen is shown below.

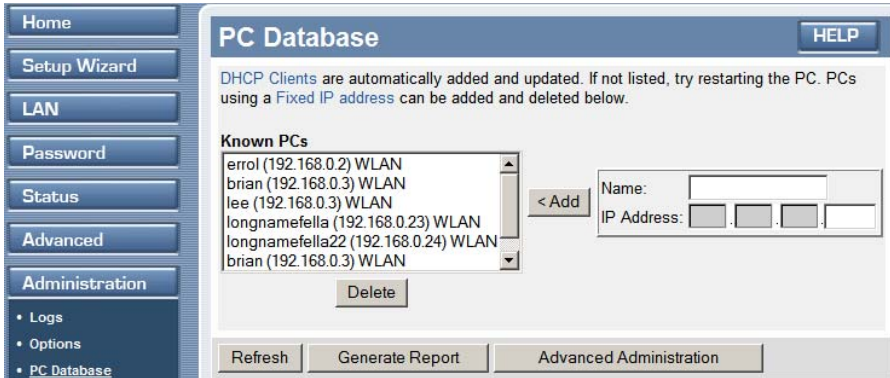

Figure 39: PC Database

- PCs which are "DHCP Clients" are automatically added to the database, and updated as required.
- By default, non-Server versions of Windows act as "DHCP Clients"; this setting is called "Obtain an IP Address automatically".
- The TW100-BRF114 uses the "Hardware Address" to identify each PC, not the name or IP address. The "Hardware Address" can only change if you change the PC's network card or adapter.
- This system means you do NOT need to use Fixed (static) IP addresses on your LAN. However, you can add PCs using Fixed (static) IP Addresses to the PC database if required.

Data - PC Database Screen

Known PCs	This lists all current entries. Data displayed is <i>name (IP Address) type</i> . The "type" indicates whether the PC is connected to the LAN.
Name	If adding a new PC to the list, enter its name here. It is best if this matches the PC's "hostname".
IP Address	Enter the IP Address of the PC. The PC will be sent a "ping" to determine its hardware address. If the PC is not available (not connected, or not powered On) you will not be able to add it.
Buttons	
Add	This will add the new PC to the list. The PC will be sent a "ping" to determine its hardware address. If the PC is not available (not connected, or not powered On) you will not be able to add it.

Delete	Delete the selected PC from the list. This should be done in 2 situations: <ul style="list-style-type: none">• The PC has been removed from your LAN.• The entry is incorrect.
Refresh	Update the data on screen.
Generate Report	Display a read-only list showing full details of all entries in the PC database.
Advanced Administration	View the <i>Advanced</i> version of the PC database screen. See below for details.

PC Database (Admin)

This screen is displayed if the "Advanced Administration" button on the *PC Database* is clicked. It provides more control than the standard *PC Database* screen.

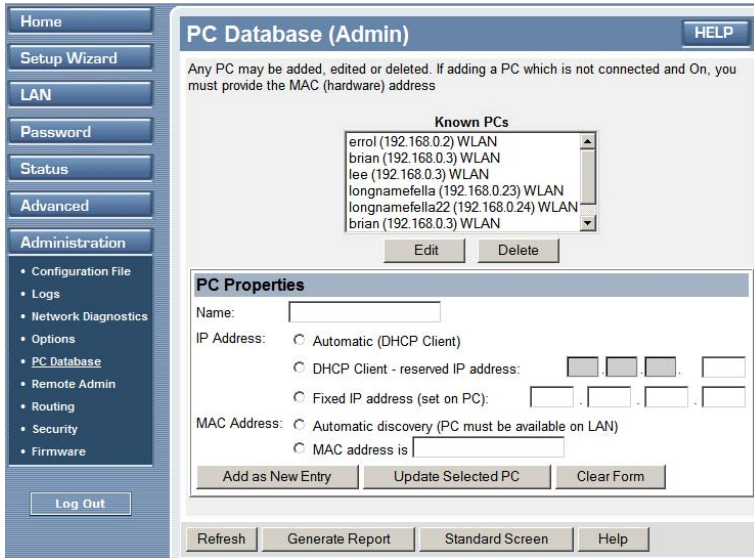

Figure 40: PC Database (Admin)

Data - PC Database (Admin) Screen

<p>Known PCs</p>	<p>This lists all current entries. Data displayed is <i>name (IP Address) type</i>. The "type" indicates whether the PC is connected to the LAN.</p>
<p>PC Properties</p>	
<p>Name</p>	<p>If adding a new PC to the list, enter its name here. It is best if this matches the PC's "hostname".</p>
<p>IP Address</p>	<p>Select the appropriate option:</p> <ul style="list-style-type: none"> • Automatic - The PC is set to be a DHCP client (Windows: "Obtain an IP address automatically"). The TW100-BRF114 will allocate an IP address to this PC when requested to do so. The IP address could change, but normally won't. • DCHP Client - Reserved IP Address - Select this if the PC is set to be a DCHP client, and you wish to guarantee that the TW100-BRF114 will always allocate the same IP Address to this PC. Enter the required IP address. Only the last field is required; the other fields must match the TW100-BRF114. • Fixed IP Address - Select this if the PC is using a Fixed (Static) IP address. Enter the IP address allocated to the PC. (The PC must be configured to use this IP address.)

MAC Address	<p>Select the appropriate option</p> <ul style="list-style-type: none"> • Automatic discovery - Select this to have the TW100-BRF114 contact the PC and find its MAC address. This is only possible if the PC is connected to the LAN and powered On. • MAC is - Enter the MAC address on the PC. The MAC address is also called the "Hardware Address", "Physical Address", or "Network Adapter Address". The TW100-BRF114 uses this to provide a unique identifier for each PC. Because of this, the MAC address can NOT be left blank.
Buttons	
Add as New Entry	<p>Add a new PC to the list, using the data in the "Properties" box. If "Automatic discovery" (for MAC address) is selected, the PC will be sent a "ping" to determine its hardware address. This will fail unless the PC is connected to the LAN, and powered on.</p>
Update Selected PC	<p>Update (modify) the selected PC, using the data in the "Properties" box.</p>
Clear Form	<p>Clear the "Properties" box, ready for entering data for a new PC.</p>
Refresh	<p>Update the data on screen.</p>
Generate Report	<p>Display a read-only list showing full details of all entries in the PC database.</p>
Standard Screen	<p>Click this to view the standard "PC Database" screen.</p>

Upgrade Firmware

The firmware (software) in the TW100-BRF114 can be upgraded using your Web Browser. You must first download the upgrade file, then select *Upgrade* on the Other menu. You will see a screen like the following.

Figure 41: Upgrade Firmware Screen

To perform the Firmware Upgrade:

1. Click the "Browse" button and navigate to the location of the upgrade file.
2. Select the upgrade file. It's name will appear in the *Upgrade File* field.
3. Click the "Start Upgrade" button to commence the firmware upgrade.



The TW100-BRF114 is unavailable during the upgrade process, and must restart when the upgrade is completed. Any connections to or through the TW100-BRF114 will be lost.

Options

This screen allows advanced users to enter or change a number of settings. For normal operation, there is no need to use this screen or change any settings.

Figure 42: Options Screen

Data - Options Screen

Backup DNS	
IP Address	Enter the IP Address of the DNS (Domain Name Servers) here. These DNS will be used only if the primary DNS is unavailable.
MTU	
MTU size	<p>MTU (Maximum Transmission Unit) value should only be changed if advised to do so by Technical Support.</p> <ul style="list-style-type: none"> Enter a value between 1 and 1500. This device will still auto-negotiate with the remote server, to set the MTU size. The smaller of the 2 values (auto-negotiated, or entered here) will be used. For direct connections (not PPPoE or PPTP), the MTU used is always 1500.

Security

This screen allows you to set Firewall and other security-related options.

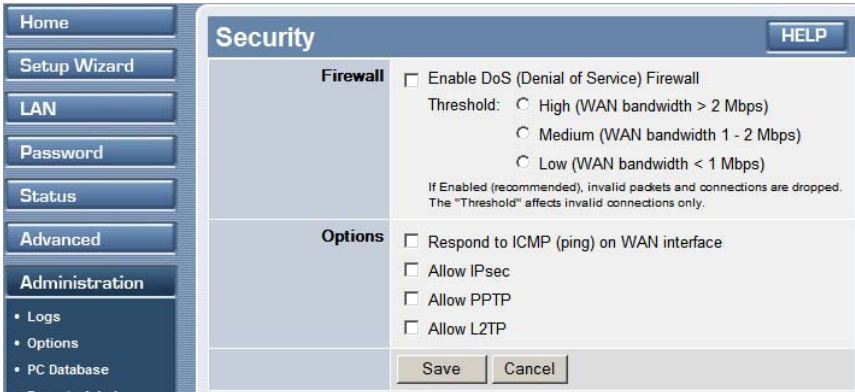

Figure 43: Security Screen

Data - Security Screen

Firewall	
Enable DoS Firewall	<p>If enabled, DoS (Denial of Service) attacks will be detected and blocked. The default is enabled. It is strongly recommended that this setting be left enabled.</p> <p>Note:</p> <ul style="list-style-type: none"> • A DoS attack does not attempt to steal data or damage your PCs, but overloads your Internet connection so you can not use it - the service is unavailable. • This device uses "Stateful Inspection" technology. This system can detect situations where individual TCP/IP packets are valid, but collectively they become a DoS attack.
Threshold	<p>This setting affects the number of "half-open" connections allowed.</p> <ul style="list-style-type: none"> • A "half-open" connection arises when a remote client contacts the Server with a connection request, but then does not reply to the Server's response. • While the optimum number of "half-open" connections allowed (the "Threshold") depends on many factors, the most important factor is the available bandwidth of your Internet connection. • Select the setting to match the bandwidth of your Internet connection.
Options	
Respond to ICMP	<p>The ICMP protocol is used by the "ping" and "traceroute" programs, and by network monitoring and diagnostic programs.</p> <ul style="list-style-type: none"> • If checked, the Firewall Router will repond to ICMP packets received from the Internet. • If not checked, ICMP packets from the Internet will be ignored. Disabling this option provides a slight increase in security.

Allow IPsec	<p>The IPsec protocol is used to establish a secure connection, and is widely used by VPN (Virtual Private Networking) programs.</p> <ul style="list-style-type: none">• If checked, IPsec connections are allowed.• If not checked, IPsec connections are blocked.
Allow PPTP	<p>PPTP (Point to Point Tunneling Protocol) is widely used by VPN (Virtual Private Networking) programs.</p> <ul style="list-style-type: none">• If checked, PPTP connections are allowed.• If not checked, PPTP connections are blocked.
Allow L2TP	<p>L2TP is a protocol developed by Cisco for VPNs (Virtual Private Networks).</p> <ul style="list-style-type: none">• If checked, L2TP connections are allowed.• If not checked, L2TP connections are blocked.

Logs

The Logs record various types of activity on the Firewall Router. This data is useful for troubleshooting, but enabling all logs will generate a large amount of data and adversely affect performance.

Since only a limited amount of log data can be stored in the Firewall Router, log data can also be E-mailed to your PC.

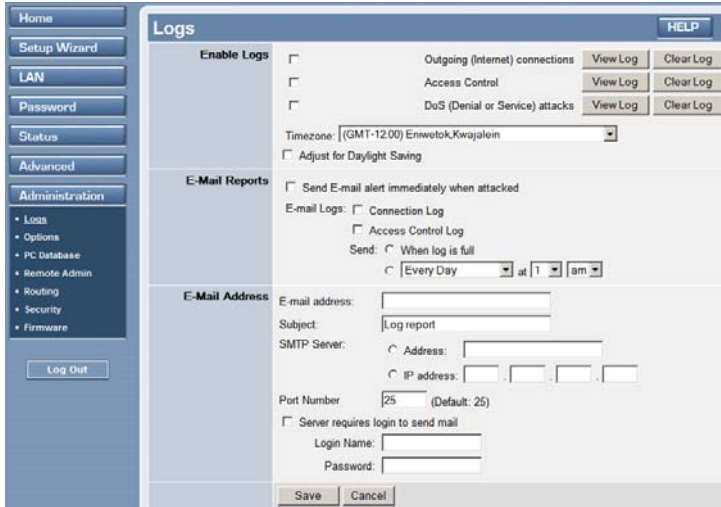

Figure 44: Logs Screen

Data - Logs Screen

Enable Logs	
Outgoing	If selected, Outgoing Internet connections are logged. Normally, the (Internet) "Destination" will be shown as an IP address. But if the "URL Filter" is enabled, the "Destination" will be shown as a URL.
Access Control	If enabled, the log will include attempted outgoing connections which have been blocked by the "Access Control" feature.
DoS Attacks	If enabled, this log will show details of DoS (Denial of Service) attacks which have been blocked by the built-in Firewall.
View Log Button	Use this to view each log, as required.
Clear Log Button	Use this to restart the required log. This makes it easier to read the latest entries.
Timezone	
Timezone	Select the correct Timezone for your location. This is required for the date/time shown on the logs to be correct.
Adjust for Daylight Saving	If your area uses Daylight Saving, you should Enable this as the beginning of the Daylight Saving period, and disable it when Daylight saving ends.

E-Mail Logs	
Send E-mail alert	If enabled, an E-mail will be sent immediately if a DoS (Denial of Service) attack is detected. If enabled, the E-mail address information must be provided.
E-mail Logs	You can choose to have the logs E-mailed to you, by enabling either or both checkboxes. If enabled, the Log will send to the specified E-mail address. The interval between E-mails is determined by the "Send" setting.
Send	<p>Select the desired option for sending the log by E-mail.</p> <ul style="list-style-type: none"> • When log is full - The time is not fixed. The log will be sent when the log is full, which will depend on the volume of traffic. • Every day, Every Monday ... - The log is sent on the interval specified. <ul style="list-style-type: none"> • If "Every day" is selected, the log is sent at the time specified. • If the day is specified, the log is sent once per week, on the specified day. • Select the time of day you wish the E-mail to be sent. • If the log is full before the time specified to send it, it will be sent regardless of the day and time specified.
E-Mail Address	
E-mail Address	Enter the E-mail address the Log is to be sent to. The E-mail will also show this address as the Sender's address.
Subject	Enter the text string to be shown in the "Subject" field for the E-mail.
SMTP Server	Enter the address or IP address of the SMTP (Simple Mail Transport Protocol) Server you use for outgoing E-mail.
Port No.	Enter the port number used to connect to the SMTP Server. The default value is 25.

Routing

Overview

- If you don't have other Routers or Gateways on your LAN, you can ignore the "Routing" page completely.
- If the TW100-BRF114 is only acting as a Gateway for the local LAN segment, ignore the "Routing" page even if your LAN has other Routers.
- If your LAN has a standard Router (e.g. Cisco) on your LAN, and the TW100-BRF114 is to act as a Gateway for all LAN segments, enable RIP (Routing Information Protocol) and ignore the Static Routing table.
- If your LAN has other Gateways and Routers, and you wish to control which LAN segments use each Gateway, do NOT enable RIP (Routing Information Protocol). Configure the Static Routing table instead. (You also need to configure the other Routers.)
- If using Windows 2000 Data center Server as a software Router, enable RIP on the TW100-BRF114, and ensure the following Windows 2000 settings are correct:
 - Open *Routing and Remote Access*
 - In the console tree, select *Routing and Remote Access, [server name], IP Routing, RIP*
 - In the "Details" pane, right-click the interface you want to configure for RIP version 2, and then click "Properties".
 - On the "General" tab, set *Outgoing packet protocol* to "RIP version 2 broadcast", and *Incoming packet protocol* to "RIP version 1 and 2".

Routing Screen

The routing table is accessed by the *Routing* link on the *Other* screen.

Using this Screen

Generally, you will use either RIP (Routing Information Protocol) OR the Static Routing Table, as explained above, although it is possible to use both methods simultaneously.

Static Routing Table

- If RIP is not used, an entry in the routing table is required for each LAN segment on your Network, other than the segment to which this device is attached.
- The other Routers must also be configured. See *Configuring Other Routers on your LAN* later in this chapter for further details and an example.

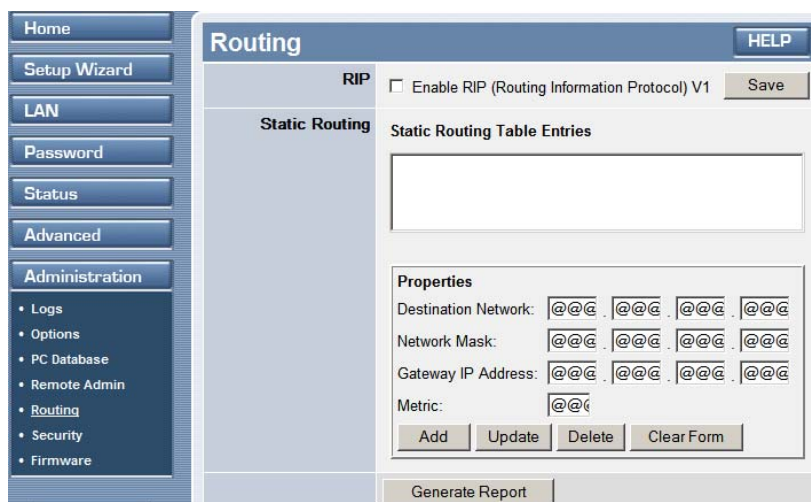

Figure 45: Routing Screen

Data - Routing Screen

RIP	
Enable RIP	<p>Check this to enable the RIP (Routing Information Protocol) feature of the TW100-BRF114.</p> <p>The TW100-BRF114 supports RIP 1 only.</p>
Static Routing	
Static Routing Table Entries	<p>This list shows all entries in the Routing Table.</p> <ul style="list-style-type: none"> The "Properties" area shows details of the selected item in the list. Change any the properties as required, then click the "Update" button to save the changes to the selected entry.
Properties	<ul style="list-style-type: none"> Destination Network - The network address of the remote LAN segment. For standard class "C" LANs, the network address is the first 3 fields of the Destination IP Address. The 4th (last) field can be left at 0. Network Mask - The Network Mask for the remote LAN segment. For class "C" networks, the default mask is 255.255.255.0 Gateway IP Address - The IP Address of the Gateway or Router which the TW100-BRF114 must use to communicate with the destination above. (NOT the router attached to the remote segment.) Metric - The number of "hops" (routers) to pass through to reach the remote LAN segment. The shortest path will be used. The default value is 1.
Buttons	
Save	Save the RIP setting. This has no effect on the Static Routing Table.
Add	Add a new entry to the Static Routing table, using the data shown in the "Properties" area on screen. The entry selected in the list is ignored, and has no effect.

Update	Update the current Static Routing Table entry, using the data shown in the "Properties" area on screen.
Delete	Delete the current Static Routing Table entry.
Clear Form	Clear all data from the "Properties" area, ready for input of a new entry for the Static Routing table.
Generate Report	Generate a read-only list of all entries in the Static Routing table.

Configuring Other Routers on your LAN

It is essential that all IP packets for devices not on the local LAN be passed to the TW100-BRF114, so that they can be forwarded to the external LAN, WAN, or Internet. To achieve this, the local LAN must be configured to use the TW100-BRF114 as the *Default Route* or *Default Gateway*.

Local Router

The local router is the Router installed on the same LAN segment as the TW100-BRF114. This router requires that the *Default Route* is the TW100-BRF114 itself. Typically, routers have a special entry for the *Default Route*. It should be configured as follows.

Destination IP Address	Normally 0.0.0.0, but check your router documentation.
Network Mask	Normally 0.0.0.0, but check your router documentation.
Gateway IP Address	The IP Address of the TW100-BRF114.
Metric	1

Other Routers on the Local LAN

Other routers on the local LAN must use the TW100-BRF114 's *Local Router* as the *Default Route*. The entries will be the same as the TW100-BRF114 's local router, with the exception of the *Gateway IP Address*.

- For a router with a direct connection to the TW100-BRF114 's local Router, the *Gateway IP Address* is the address of the TW100-BRF114 's local router.
- For routers which must forward packets to another router before reaching the TW100-BRF114 's local router, the *Gateway IP Address* is the address of the intermediate router.

Static Routing - Example

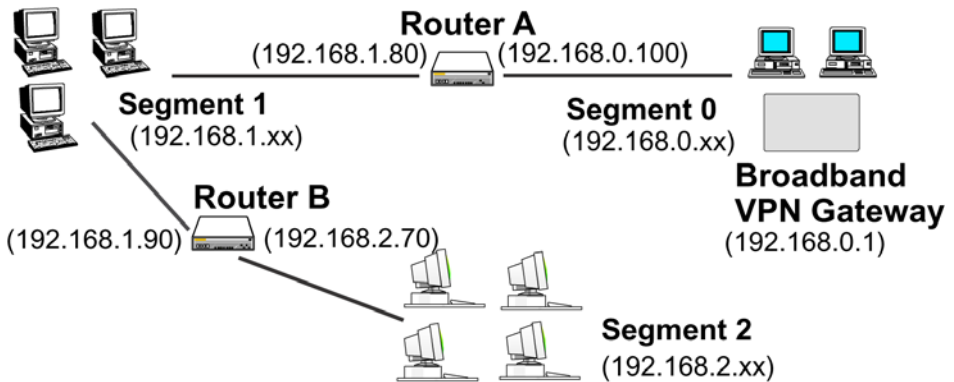

Figure 46: Routing Example

For the TW100-BRF114 's Routing Table

For the LAN shown above, with 2 routers and 3 LAN segments, the TW100-BRF114 requires 2 entries as follows.

Entry 1 (Segment 1)	
Destination IP Address	192.168.1.0
Network Mask	255.255.255.0 (Standard Class C)
Gateway IP Address	192.168.0.100 (TW100-BRF114 's local Router)
Metric	2
Entry 2 (Segment 2)	
Destination IP Address	192.168.2.0
Network Mask	255.255.255.0 (Standard Class C)
Gateway IP Address	192.168.0.100
Metric	3

For Router A's Default Route

Destination IP Address	0.0.0.0
Network Mask	0.0.0.0
Gateway IP Address	192.168.0.1 (TW100-BRF114 's IP Address)

For Router B's Default Route

Destination IP Address	0.0.0.0
Network Mask	0.0.0.0
Gateway IP Address	192.168.1.80 (TW100-BRF114 's local router)

Appendix A

Troubleshooting



This Appendix covers the most likely problems and their solutions.

Overview

This chapter covers some common problems that may be encountered while using the TW100-BRF114 and some possible solutions to them. If you follow the suggested steps and the TW100-BRF114 still does not function properly, contact your dealer for further advice.

General Problems

Problem 1: Can't connect to the TW100-BRF114 to configure it.

Solution 1: Check the following:

- The TW100-BRF114 is properly installed, LAN connections are OK, and it is powered ON.
- Ensure that your PC and the TW100-BRF114 are on the same network segment. (If you don't have a router, this must be the case.)
- If your PC is set to "Obtain an IP Address automatically" (DHCP client), restart it.
- If your PC uses a Fixed (Static) IP address, ensure that it is using an IP Address within the range 192.168.0.2 to 192.168.0.254 and thus compatible with the TW100-BRF114 's default IP Address of 192.168.0.1. Also, the Network Mask should be set to 255.255.255.0 to match the TW100-BRF114.

In Windows, you can check these settings by using *Control Panel-Network* to check the *Properties* for the TCP/IP protocol.

Internet Access

Problem 1: When I enter a URL or IP address I get a time out error.

Solution 1: A number of things could be causing this. Try the following troubleshooting steps.

- Check if other PCs work. If they do, ensure that your PCs IP settings are correct. If using a Fixed (Static) IP Address, check the Network Mask, Default gateway and DNS as well as the IP Address.
- If the PCs are configured correctly, but still not working, check the TW100-BRF114. Ensure that it is connected and ON. Connect to it and check its settings. (If you can't connect to it, check the LAN and power connections.)
- If the TW100-BRF114 is configured correctly, check your Internet connection (DSL/Cable modem etc) to see that it is working correctly.

Problem 2: Some applications do not run properly when using the TW100-BRF114.

Solution 2: The TW100-BRF114 processes the data passing through it, so it is not transparent.

Use the *Special Applications* feature to allow the use of Internet applications which do not function correctly.

If this does solve the problem you can use the *DMZ* function. This should work with almost every application, but:

- It is a security risk, since the firewall is disabled.
- Only one (1) PC can use this feature.

Appendix B

Specifications



TW100-BRF114

Model	TW100-BRF114
Dimensions	141mm(W) * 100mm(D) * 27mm(H)
Operating Temperature	0° C to 40° C
Storage Temperature	-10° C to 70° C
Network Protocol:	TCP/IP
Network Interface:	5 Ethernet: 4 * 10/100BaseT (RJ45) LAN connection 1 * 10/100BaseT (RJ45) for WAN
LEDs	11
Power Adapter	12V DC External

Regulatory Approvals

CE Standards

This product complies with the 99/5/EEC directives, including the following safety and EMC standards:

- EN301489-1/-17
- EN60950

CE Marking Warning

This is a Class B product. In a domestic environment this product may cause radio interference in which case the user may be required to take adequate measures.



TRENDNET®

TRENDnet Technical Support

US • Canada

Toll Free Telephone: 1(866) 845-3673

24/7 Tech Support



Europe (Germany • France • Italy • Spain • Switzerland • UK)

Toll Free Telephone: +00800 60 76 76 67

English/Espanol - 24/7

Francais/Deutsch - 11am-8pm, Monday - Friday MET

Worldwide

Telephone: +(31) (0) 20 504 05 35

English/Espanol - 24/7

Francais/Deutsch - 11am-8pm, Monday - Friday MET

Product Warranty Registration

Please take a moment to register your product online.

Go to TRENDnet's website at <http://www.trendnet.com/register>

TRENDNET®

20675 Manhattan Place
Torrance, CA 90501
USA

Free Manuals Download Website

<http://myh66.com>

<http://usermanuals.us>

<http://www.somanuals.com>

<http://www.4manuals.cc>

<http://www.manual-lib.com>

<http://www.404manual.com>

<http://www.luxmanual.com>

<http://aubethermostatmanual.com>

Golf course search by state

<http://golfingnear.com>

Email search by domain

<http://emailbydomain.com>

Auto manuals search

<http://auto.somanuals.com>

TV manuals search

<http://tv.somanuals.com>