

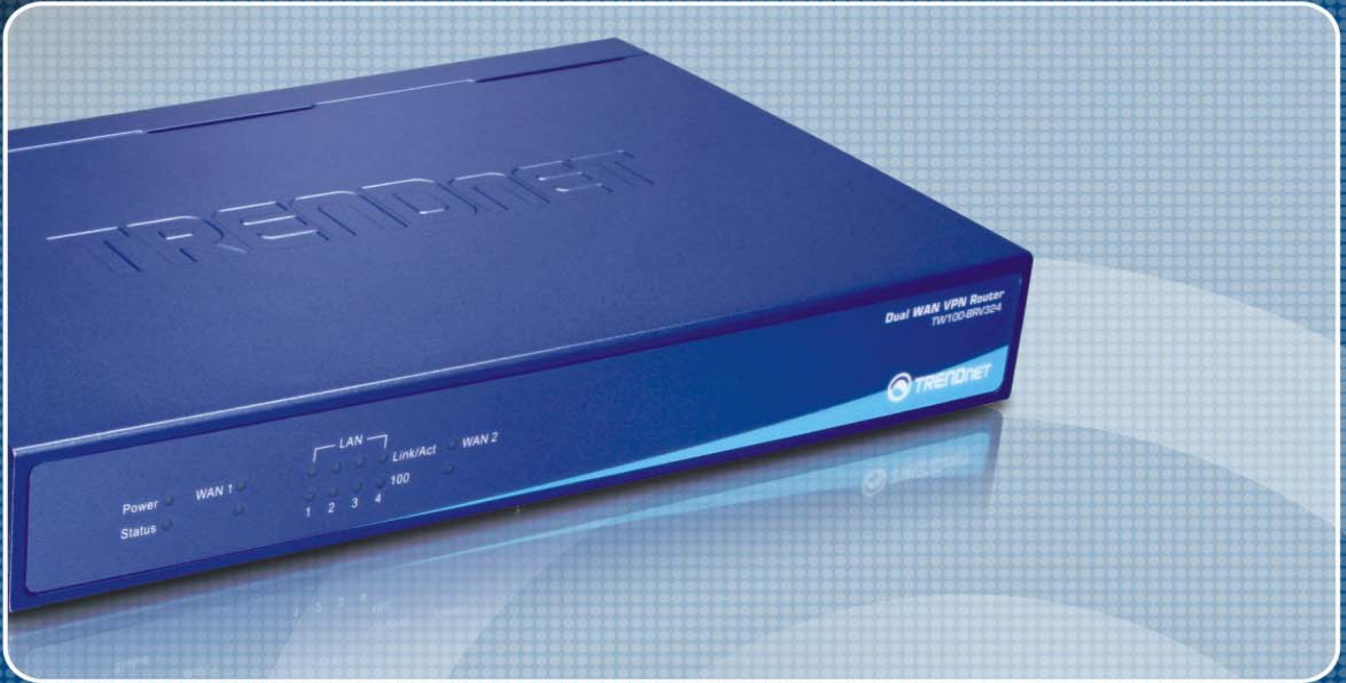

TRENDNET®



User's Guide

TW100-BRV324

Table of Contents

CHAPTER 1 INTRODUCTION	1
Broadband VPN Gateway Features	1
Package Contents	3
Physical Details	4
CHAPTER 2 INSTALLATION.....	6
Requirements.....	6
Procedure	6
CHAPTER 3 SETUP	8
Overview	8
Configuration Program	9
WAN Port Configuration	12
Port Options Screen	14
LAN Port Screen	16
Load/Backup Screen	18
CHAPTER 4 PC CONFIGURATION	20
Overview	20
Windows Clients.....	20
Macintosh Clients.....	33
Linux Clients.....	33
Other Unix Systems.....	33
CHAPTER 5 OPERATION AND STATUS.....	34
Operation	34
Status Screen.....	34
Port Status.....	37
Event Log	38
URL Log.....	39
System Log.....	40
CHAPTER 6 INTERNET FEATURES	41
Overview	41
Address List	42
PC Database.....	43
URL Filter.....	45
Dynamic DNS.....	47
Static Routing	49
QoS	54
CHAPTER 7 SECURITY CONFIGURATION.....	56
Overview	56
Rules	56
Schedules.....	60
Firewall -- Log	61
Services.....	63
Security.....	65
DMZ	67
E-Mail.....	68
CHAPTER 8 VPN (IPSEC).....	70
Overview	70
Common VPN Situations.....	72
VPN Configuration	74

VPN Examples	82
Certificates	100
CRL	104
VPN Status	105
Add Certificate	Error! Bookmark not defined.
Get Certificate ID	Error! Bookmark not defined.
CHAPTER 9 MICROSOFT VPN	106
Overview	106
Server Setup.....	106
User.....	107
Status Log Screen.....	109
Windows Client Setup.....	110
CHAPTER 10 OTHER FEATURES & SETTINGS	118
Overview	118
Diagnostics	119
Password Screen.....	121
Web Management	122
Firmware Upgrade	124
Backup/Restore.....	125
APPENDIX A TROUBLESHOOTING	127
Overview	127
General Problems.....	127
Internet Access.....	127
APPENDIX B SPECIFICATIONS.....	129
Broadband VPN Gateway	129
FCC Statement	129
CE Marking Warning.....	130

P/N: 956YH10001

Copyright © 2007. All Rights Reserved.

Document Version:1.0

All trademarks and trade names are the properties of their respective owners.

Chapter 1

Introduction

1

This Chapter provides an overview of the Broadband VPN Gateway's features and capabilities.

Congratulations on the purchase of your new Broadband VPN Gateway. The Broadband VPN Gateway is a multi-function device providing the following services:

- **Shared Broadband Internet Access** for all LAN users.
- **VPN Gateway** for IPSec VPN connections to remote PCs or sites.
- **4-Port Switching Hub** for 10BaseT or 100BaseT connections.

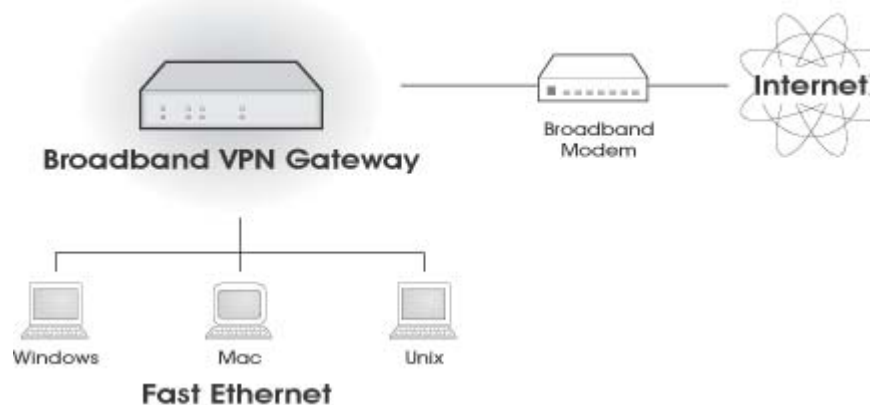

Figure 1: Broadband VPN Gateway

Broadband VPN Gateway Features

The Broadband VPN Gateway incorporates many advanced features, carefully designed to provide sophisticated functions while being easy to use.

Internet Access Features

- **Shared Internet Access.** All users on the LAN or WLAN can access the Internet through the Broadband VPN Gateway, using only a single external IP Address. The local (invalid) IP Addresses are hidden from external sources. This process is called NAT (Network Address Translation).
- **Dual WAN Support.** Dual 10/100 WAN ports let you have a second link to your ISP, providing failover protection. You can use both WAN ports simultaneously, and let the router balance the requirements between them for maximum bandwidth efficiency.
- **Fixed or Dynamic IP Address.** On the Internet (WAN port) connection, the Broadband VPN Gateway supports both Dynamic IP Address (IP Address is allocated on connection) and Fixed IP Address.

Advanced Internet Functions

- **Communication Applications.** Support for Internet communication applications, such as interactive Games, Telephony, and Conferencing applications, which are often difficult to use when behind a Firewall, is included.
- **Special Internet Applications.** Applications which use non-standard connections or port numbers are normally blocked by the Firewall. The ability to define and allow such applications is provided, to enable such applications to be used normally.

- **Virtual Servers.** This feature allows Internet users to access Internet servers on your LAN. The required setup is quick and easy.
- **Multi-DMZ.** For each WAN (Internet) IP address allocated to you, one (1) PC on your local LAN can be configured to allow unrestricted 2-way communication with Servers or individual users on the Internet. This provides the ability to run programs which are incompatible with Firewalls.
- **Address List.** Use address list to block access to undesirable Web sites by LAN users. Up to 40 addresses can be listed.
- **IM/P2P Control.** The IM/P2P control allows you to better manage your employees' network activities and prevent possible misuse of IM and P2P applications.
- **URL Filter.** Use the URL Filter to block access to undesirable Web sites by LAN users.
- **Internet Access Log.** See which Internet connections have been made.
- **VPN Pass through Support.** PCs with VPN (Virtual Private Networking) software using PPTP, L2TP and IPSec are transparently supported - no configuration is required.
- **QoS Support** Quality of Service can be used to handle packets so that more important connections receive priority over less important one.

LAN Features

- **4-Port Switching Hub.** The Broadband VPN Gateway incorporates a 4-port 10/100BaseT switching hub, making it easy to create or extend your LAN.
- **DHCP Server Support.** Dynamic Host Configuration Protocol provides a dynamic IP address to PCs and other devices upon request. The Broadband VPN Gateway can act as a **DHCP Server** for devices on your local LAN and WLAN.

Configuration & Management

- **Easy Setup.** Use your WEB browser from anywhere on the LAN or WLAN for configuration.
- **Remote Management.** The Broadband VPN Gateway can be managed from any PC on your LAN. And, if the Internet connection exists, it can also (optionally) be configured via the Internet.
- **UPnP Support.** UPnP (Universal Plug and Play) allows automatic discovery and configuration of the Broadband VPN Gateway. UPnP is supported by Windows ME, XP, or later.
- **Multi-Language Support.** Multi-Language Pack facilitates the process of creating multi-language applications. Add support for as many languages as you like.
- **Configuration File Backup & Restore.** You can backup (download) the Broadband VPN Gateway's configuration file to your PC, and restore (upload) a previously-saved configuration file to the Broadband VPN Gateway.

Security Features

- **Password - protected Configuration.** Optional password protection is provided to prevent unauthorized users from modifying the configuration data and settings.
- **NAT Protection.** An intrinsic side effect of NAT (Network Address Translation) technology is that by allowing all LAN users to share a single IP address, the location and even the existence of each PC is hidden. From the external viewpoint, there is no network, only a single device - the Broadband VPN Gateway.
- **NATT (NAT-Traversal).** NAT Traversal is a method to allow IPSec to work through NAT devices. It is encapsulating IPSec ESP packets into UDP packets for passing through routers or firewalls employing Network Address Translation (NAT).
- **Stateful Inspection Firewall.** All incoming data packets are monitored and all incoming server requests are filtered, thus protecting your network from malicious attacks from external sources.
- **IP/MAC Binding.** Users cannot change the IP address unless they have the permission of the IT manager.
- **Protection against DoS attacks.** DoS (Denial of Service) attacks can flood your Internet connection with invalid packets and connection requests, using so much bandwidth and so many resources that Internet access becomes unavailable. The Broadband VPN Gateway incorporates protection against DoS attacks.
- **Rule-based Policy Firewall.** To provide additional protection against malicious packets, you can define your own firewall rules. This can also be used to control the Internet services available to LAN users.

IPSec VPN Gateway Features

- **IPSec.** Support for IPSec standards, including IKE and certificates.
- **100 Tunnels.** Up to 100 VPN tunnels can be created.
- **High performance.** High performance encryption engine maintains high throughput even when using 3DES.
- **DPD Support** Dead Peer Detection is a method of detecting a dead Internet Key Exchange (IKE) peer. The method uses IPSec traffic patterns to minimize the number of messages required to confirm the liveness of a peer. DPD is used to reclaim the lost resources in case a peer is found dead.

Microsoft VPN Gateway Support

- **PPTP Server.** The Broadband VPN Gateway emulates a Microsoft PPTP VPN Server, allowing clients to use the Microsoft VPN client provided in Windows.
- **Windows Client Support.** Remote users can use the Microsoft VPN client (VPN Adapter) provided in recent versions of Windows.
- **Easy Setup.** For both the Administrator and remote users, the Microsoft VPN is much easier to configure than IPSec VPN.

Package Contents

The following items should be included:

- The Broadband VPN Gateway Unit
- Power Adapter
- Quick Installation Guide
- CD-ROM containing the on-line manual.

If any of the above items are damaged or missing, please contact your dealer immediately.

Physical Details

Front-mounted LEDs

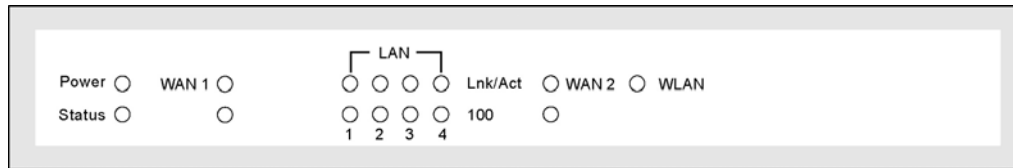

Figure 2: Front Panel

Power	<p>On - Power on.</p> <p>Off - No power.</p>
Status (Red)	<p>On - Error condition.</p> <p>Off - Normal operation.</p> <p>Blinking - This LED blinks during start up.</p>
WAN ports (10/100BaseT)	Connect the DSL or Cable Modem here. If your modem came with a cable, use the supplied cable. Otherwise, use a standard LAN cable.
LAN	<p>Each port has 2 LEDs</p> <ul style="list-style-type: none"> • Link/Act <ul style="list-style-type: none"> • On - Corresponding LAN (hub) port is active. • Off - No active connection on the corresponding LAN (hub) port. • Flashing - Data is being transmitted or received via the corresponding LAN (hub) port. • 100 <ul style="list-style-type: none"> • On - Corresponding LAN (hub) port is using 100BaseT. • Off - Corresponding LAN (hub) port connection is using 10BaseT, or no active connection.
WLAN LED	<p>On - Wireless enabled.</p> <p>Off - No Wireless connections currently exist.</p> <p>Flashing - Data is being transmitted or received via the Wireless access point. This includes "network traffic" as well as user data.</p>

Rear Panel

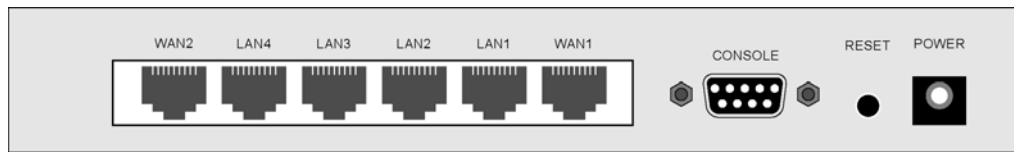

Figure 3: Rear Panel

**WAN port 1/2
(10/100BaseT)**

Connect the DSL or Cable Modem here. If your modem came with a cable, use the supplied cable. Otherwise, use a standard LAN cable.

**10/100BaseT
LAN connections**

Use standard LAN cables (RJ45 connectors) to connect your PCs to these ports.

Note:

Any LAN port on the Broadband VPN Gateway will automatically function as an "Uplink" port when required. Just connect any port to a normal port on the other hub, using a standard LAN cable.

Console Port

Use the supplied cable to connect the router to a terminal or PC.

Reset Button

This button has two (2) functions:

- **Reboot.** When pressed and released, the Broadband VPN Gateway will reboot (restart).
- **Clear All Data.** This button can also be used to clear ALL data and restore ALL settings to the factory default values.

To Clear All Data and restore the factory default values:

1. Power Off.
2. Hold the Reset Button down while you Power On.
3. Keep holding the Reset Button for a few seconds, until the RED LED has flashed TWICE.
4. Release the Reset Button. The Broadband VPN Gateway is now using the factory default values.

Power port

Connect the supplied power adapter here.

Chapter 2

Installation

2

This Chapter covers the physical installation of the Broadband VPN Gateway.

Requirements

- Network cables. Use standard 10/100BaseT network (UTP) cables with RJ45 connectors.
- TCP/IP protocol must be installed on all PCs.
- For Internet Access, an Internet Access account with an ISP, and a Broadband modem (usually, DSL or Cable modem).

Procedure

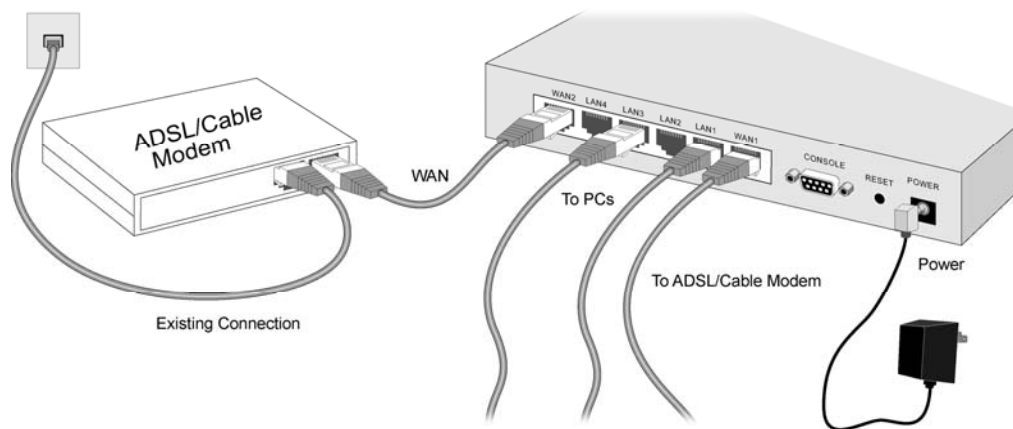

Figure 4: Installation Diagram

1. Choose an Installation Site

Select a suitable place on the network to install the Broadband VPN Gateway.
Ensure the Broadband VPN Gateway and the DSL/Cable modem are powered OFF.

2. Connect LAN Cables

- Use standard LAN cables to connect PCs to the Switching Hub ports on the Broadband VPN Gateway. Both 10BaseT and 100BaseT connections can be used simultaneously.
- If required, you can connect any LAN port to another Hub. Any LAN port on the Broadband VPN Gateway will automatically function as an "Uplink" port when required. Just connect any LAN port to a normal port on the other hub, using a standard LAN cable.

3. Connect WAN Cable

Connect the Broadband modem to the WAN port on the Broadband VPN Gateway. Use the cable supplied with your Broadband modem. If no cable was supplied, use a standard LAN cable.

4. Power Up

- Power on the Broadband modem.
- Connect the supplied power adapter to the Broadband VPN Gateway and power up.
Use only the power adapter provided. Using a different one may cause hardware damage.

5. Check the LEDs

- The *Power* LED should be ON.
- The *Status* LED should blink during start up, then turn Off. If it stays on, there is a hardware error.
- For each LAN (PC) connection, the LAN *Link/Act* LED should be ON (provided the PC is also ON.)
- The *WAN1* or *WAN2* LED should be ON.

For more information, refer to Front-mounted LEDs in Chapter 1.

Chapter 3

Setup



This Chapter provides Setup details of the Broadband VPN Gateway.

Overview

This chapter describes the setup procedure for:

- Internet Access
- LAN configuration

PCs on your local LAN may also require configuration. For details, see *Chapter 4 - PC Configuration*.

Other configuration may also be required, depending on which features and functions of the Broadband VPN Gateway you wish to use. Use the table below to locate detailed instructions for the required functions.

To Do this:	Refer to:
Configure PCs on your LAN.	Chapter 4: PC Configuration
Check Broadband VPN Gateway operation and Status.	Chapter 5: Operation and Status
Use any of the following Internet features: <ul style="list-style-type: none">• WAN Port• Advanced Setup• Dynamic DNS• Virtual Servers• Options	Chapter 6: Internet Features
Change any of the following Security-related settings: <ul style="list-style-type: none">• Admin Login• Access Control• Firewall Rules• Logs• E-mail• Security Options• Scheduling• Services	Chapter 7: Security Configuration
Use the IPSec VPN features: <ul style="list-style-type: none">• VPN Policies• Certificates• CRLs• VPN Status	Chapter 8: VPN (IPSec)

Use the Microsoft VPN feature: <ul style="list-style-type: none"> • PPTP Server in the Broadband VPN Gateway. • User and Client setup. • Checking VPN connection Status. 	Chapter 9: Microsoft VPN
Configure or use any of the following: <ul style="list-style-type: none"> • Configuration File backup and restore. • Network Diagnostic • PC Database • Remote Administration • Routing • Upgrade Firmware • UPnP 	Chapter 9: Other Features and Settings



Where use of a certain feature requires that PCs or other LAN devices be configured, this is also explained in the relevant chapter.

Configuration Program

The Broadband VPN Gateway contains an HTTP server. This enables you to connect to it, and configure it, using your Web Browser. **Your Browser must support JavaScript.** The configuration program has been tested on the following browsers:

- Netscape V4.08 or later
- Internet Explorer V4 or later

Preparation

Before attempting to configure the Broadband VPN Gateway, please ensure that:

- Your PC can establish a physical connection to the Broadband VPN Gateway. The PC and the Broadband VPN Gateway must be directly connected (using the Hub ports on the Broadband VPN Gateway) or on the same LAN segment.
- The Broadband VPN Gateway must be installed and powered ON.
- If the Broadband VPN Gateway 's default IP Address (192.168.0.1) is already used by another device, the other device must be turned OFF until the Broadband VPN Gateway is allocated a new IP Address during configuration.

Using UPnP

If your Windows system supports UPnP, an icon for the Broadband VPN Gateway will appear in the system tray, notifying you that a new network device has been found, and offering to create a new desktop shortcut to the newly-discovered device.

- Unless you intend to change the IP Address of the Broadband VPN Gateway, you can accept the desktop shortcut.
- Whether you accept the desktop shortcut or not, you can always find UPnP devices in *My Network Places* (previously called *Network Neighborhood*).
- Double - click the icon for the Broadband VPN Gateway (either on the Desktop, or in *My Network Places*) to start the configuration.

Using your Web Browser

To establish a connection from your PC to the Broadband VPN Gateway:

1. After installing the Broadband VPN Gateway in your LAN, start your PC. If your PC is already running, restart it.
2. Start your WEB browser.

3. In the *Address* box, enter "HTTP://" and the IP Address of the Broadband VPN Gateway, as in this example, which uses the Broadband VPN Gateway 's default IP Address:

HTTP://192.168.0.1

If you can't connect

If the Broadband VPN Gateway does not respond, check the following:

- The Broadband VPN Gateway is properly installed, LAN connection is OK, and it is powered ON. You can test the connection by using the "Ping" command:
 - Open the MS-DOS window or command prompt window.
 - Enter the command:
ping 192.168.0.1
If no response is received, either the connection is not working, or your PC's IP address is not compatible with the Broadband VPN Gateway 's IP Address. (See next item.)
- If your PC is using a fixed IP Address, its IP Address must be within the range 192.168.0.2 to 192.168.0.254 to be compatible with the Broadband VPN Gateway 's default IP Address of 192.168.0.1. Also, the *Network Mask* must be set to 255.255.255.0. See *Chapter 4 - PC Configuration* for details on checking your PC's TCP/IP settings.
- Ensure that your PC and the Broadband VPN Gateway are on the same network segment. (If you don't have a router, this must be the case.)

4. You will be prompted for a username and password, as shown below.

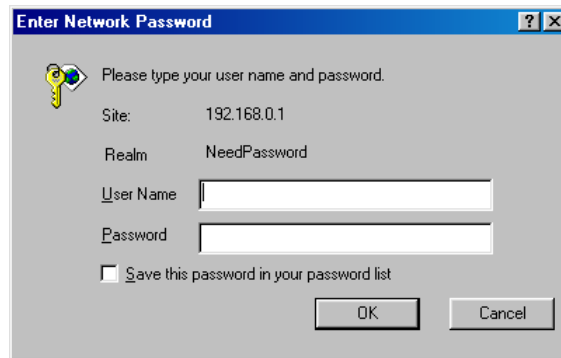

Figure 5: Password Dialog

- Enter admin for the *User Name*, and password for the *Password*.
- These are the default values. Both the name and password can (and should) be changed, using the *Admin Login* screen. Once you have changed either the name or the password, you must use the current values.

Home Screen

After logging, you will see the *Home* screen. When you connect in future, you will see this screen when you connect. An example screen is shown below.

The screenshot displays the 'General Status' page of a TRENDnet Dual WAN Broadband VPN Router (TW100-BRV324). The interface includes a left-hand navigation menu with buttons for Status Log, Setup, Advanced, Firewall, VPN (IPSec), VPN (PPTP), Administration, and Log Out. The main content area is divided into several sections:

- WAN1:** Connection Method: Dynamic IP; IP Address: 192.168.1.51; Subnet Mask: 255.255.255.0; Gateway: 192.168.1.254; DNS IP Address: 192.168.1.245; MAC Address: 00:c0:02:#b3:97; Connection Status: Connection:7, Throughput:less than1Kbps; Internet Connection: Disconnect.
- WAN2:** Connection Method: Dynamic IP; IP Address: ; Subnet Mask: ; Gateway: ; DNS IP Address: ; MAC Address: 00:c0:02:#b3:98; Connection Status: Connection:0, Throughput:less than1Kbps; Internet Connection: Connect.
- LAN:** Port Status: ON; IP Address: 192.168.0.1; Subnet Mask: 255.255.255.0; MAC Address: 00:c0:02:#b3:96; DHCP Server: Open; DHCP Clients: 50.
- Firewall:** Rule Number: 4 Entry; Advanced Rule Number: 0 Entry; System Rule Number: 4 Entry; Remote Access: N/A; E-mail Log: N/A; DMZ: N/A; Address List: N/A.
- Kernel:** FireWall Version: v1006; PC Bundle Rule: N/A; Load Balancing: Bandwidth, main port shares 50%, WAN 2 is disconnected, all connections redirected to WAN 1.; VPN Tunnel Number: N/A; DDNS Status: N/A.
- System:** Device Name: TW100-BRV324; Firmware Version: Version 1.0 Release 00; System Up Time: 2007-08-15 13:24:30; System Run Time: 0hour(s) 3minute(s) 18second(s); Session Loading: 7/40000; Language Version: Default.

At the bottom of the status area, there are buttons for Restart, Refresh, and Show Status. A copyright notice for TRENDnet is visible at the very bottom.

Figure 6: Home Screen

Navigation & Data Input

- Use the menu bar on the left of the screen, and the "Back" button on your Browser, for navigation.
- Changing to another screen without clicking "Save" does NOT save any changes you may have made. You must "Save" before changing screens or your data will be ignored.

WAN Port Configuration

The *WAN Port* option is on the *Setup* menu.

WAN Port			
	Connections	WAN 1	WAN 2
	Connection Type :	<input type="text" value="Dynamic IP"/>	<input type="text" value="Dynamic IP"/>
Static IP Settings	IP Address :	<input type="text"/>	<input type="text"/>
	Subnet Mask :	<input type="text"/>	<input type="text"/>
	Gateway :	<input type="text"/>	<input type="text"/>
PPPoE Dial-up	User Name :	<input type="text"/>	<input type="text"/>
	Password :	<input type="text"/>	<input type="text"/>
	Host Name (optional) :	<input type="text"/>	<input type="text"/>
DNS	DNS 1:	<input type="text"/>	<input type="text"/>
	DNS 2:	<input type="text"/>	<input type="text"/>
		<input type="button" value="Save"/> <input type="button" value="Cancel"/>	

Figure 7: WAN Port Screen

Data - WAN Port Screen

WAN Port Settings	
Connections	Normally, this can be left at "Automatic". If the device attached to the WAN Port has problems making a connection, you can select the setting required or preferred by the other device.
Connection Type	Select the login method used, and enter the required data. <ul style="list-style-type: none"> Static IP - Select this if your ISP has allocated you a fixed IP Address. If this option is selected, you must enter the data in the Static IP Settings section. Dynamic IP - This is the default, and the most common. Leave this selected if your ISP allocates an IP Address to the Wireless Router upon connection. PPPoE - This is the most common login method, widely used with DSL modems. Normally, your ISP will have provided some software to connect and login. This software is no longer required, and should not be used.
Static IP Settings	
IP Address	The IP Address allocated by the ISP.
Subnet Mask	This is also supplied by your ISP. It must be compatible with the IP Address above.

Gateway	The address of the router or gateway, as supplied by your ISP.
PPPoE Dial-up	
User Name	The User Name (or account name) provided by your ISP.
Password	Enter the password for the login name above.
Hostname	Normally, there is no need to change the default name, but if your ISP requests that you use a particular Hostname, enter it here.
DNS	
DNS 1	Enter the IP address of the DNS (Domain Name Server) you wish to use.
DNS 2	DNS 2 will be used if the DNS 1 is not available.
Buttons	
Save	Save your changes to the Wireless Router.
Cancel	Reverse any changes made since the last "Save".

Port Options Screen

Use the *Port Options* link on the Setup menu. An example screen is shown below.

Port Options			
	WAN Port	WAN 1	WAN 2
	Symmetric NAT:	<input checked="" type="checkbox"/> Enabled	<input checked="" type="checkbox"/> Enabled
	Compatible NAT: <small>(enable only when necessary)</small>	<input type="checkbox"/> Enabled	<input type="checkbox"/> Enabled
	Host Name:	<input type="text" value="TW100-BRV324"/>	<input type="text"/>
	Domain Name:	<input type="text"/>	<input type="text"/>
	MAC Address:	<input type="text" value="00:c0:02:ff:b3:97"/>	<input type="text" value="00:c0:02:ff:b3:98"/>
		<input type="button" value="Clone"/> <input type="button" value="Default"/>	<input type="button" value="Clone"/> <input type="button" value="Default"/>
	MTU Size:	<input type="text" value="1500"/> bytes	<input type="text" value="1500"/> bytes
PPPoE Connection	Automatic Dial-up :	<input checked="" type="checkbox"/> Enabled	<input checked="" type="checkbox"/> Enabled
	Disconnect After Idling	<input type="text" value="5"/> minute(s)	<input type="text" value="5"/> minute(s)
Bind Service	Services Works on Load Balancing	<input checked="" type="checkbox"/> IPSec Pass Through	<input type="checkbox"/> IPSec Pass Through
		<input checked="" type="checkbox"/> VPN (PPTP)	<input checked="" type="checkbox"/> VPN (PPTP)
	Network Card Speed :	<input type="text" value="Auto"/>	<input type="text" value="Auto"/>
		<input type="button" value="Save"/> <input type="button" value="Reset"/>	

Figure 8: Port Options Screen

Data - Port Options Screen

Port Options	
Symmetric NAT	If Enabled, all requests from the same internal IP address and port to a specific destination IP address and port are mapped to a unique external source IP address and port.
Compatible NAT	The default value is Disabled.
Hostname	Normally, there is no need to change the default name, but if your ISP requests that you use a particular Hostname, enter it here.
Domain Name	If your ISP provided a domain name, enter it here. Otherwise, this may be left blank.
MAC Address	Also called <i>Network Adapter Address</i> or <i>Physical Address</i> . This is a low-level identifier, as seen from the WAN port. Normally there is no need to change this, but some ISPs require a particular value, often that of the PC initially used for Internet access. You can use the <i>Clone</i> button to copy your PC's address into this field, the <i>Default</i> button to insert the default value, or enter a value directly.

MTU Size	<ul style="list-style-type: none"> • MTU (Maximum Transmission Unit) value should only be changed if advised to do so by Technical Support. • Enter a value between 1 and 1500. • This device will still auto-negotiate with the remote server, to set the MTU size. The smaller of the 2 values (auto-negotiated, or entered here) will be used.
PPPoE Connection	
Automatic Dial-up	An Internet connection is automatically made when required, and disconnected when idle for the time period specified by the "Disconnect after Idling".
Disconnect After Idling	This field has no effect unless using the Automatic Dial-up setting. If using this setting, enter the desired idle time-out period (in minutes). After the connection to your ISP has been idle for this time period, the connection will be terminated.
Bind Service	
IPSec Pass Through	IPSec protocol is used to establish a secure connection, and is widely used by VPN (Virtual Private Networking) programs.
VPN (PPTP)	PPTP (Point to Point Tunneling Protocol) is widely used by VPN (Virtual Private Networking) programs.
Network Card Speed	Select the desired option from the drop-down list.

LAN Port Screen

Use the *LAN Port* link on the main menu to reach the **LAN Port** screen. An example screen is shown below.

Figure 9: LAN Port Screen

Data - LAN Port Screen

LAN	
LAN IP Address	IP address for the Broadband VPN Gateway, as seen from the local LAN. Use the default value unless the address is already in use or your LAN is using a different IP address range. In the latter case, enter an unused IP Address from within the range used by your LAN.
Subnet Mask	The default value 255.255.255.0 is standard for small (class "C") networks. For other networks, use the Subnet Mask for the LAN segment to which the Broadband VPN Gateway is attached (the same value as the PCs on that LAN segment).
DHCP Server	<ul style="list-style-type: none"> If Enabled, the Broadband VPN Gateway will allocate IP Addresses to PCs (DHCP clients) on your LAN when they start up. The default (and recommended) value is Enabled. If you are already using a DHCP Server, this setting must be Disabled, and the existing DHCP server must be re-configured to treat the Broadband VPN Gateway as the default Gateway. See the following section for further details. The Start IP Address, Number of IP Address Pool, Client Side DNS and DHCP Lease Time fields set the values used by the DHCP server when allocating IP Addresses to DHCP clients. This range also determines the number of DHCP clients supported. See the following section for further details on using DHCP.
Buttons	
Save	Save the data on screen.
Cancel	The "Cancel" button will discard any data you have entered and reload the file from the Broadband VPN Gateway.

DHCP

What DHCP Does

A DHCP (Dynamic Host Configuration Protocol) **Server** allocates a valid IP address to a DHCP **Client** (PC or device) upon request.

- The client request is made when the client device starts up (boots).
- The DHCP Server provides the *Gateway* and *DNS* addresses to the client, as well as allocating an IP Address.
- The Broadband VPN Gateway can act as a **DHCP server**.
- Windows 95/98/ME and other non-Server versions of Windows will act as a DHCP **client**. This is the default Windows setting for the TCP/IP network protocol. However, Windows uses the term *Obtain an IP Address automatically* instead of "DHCP Client".
- You must NOT have two (2) or more DHCP Servers on the same LAN segment. (If your LAN does not have other Routers, this means there must only be one (1) DHCP Server on your LAN.)

Using the Broadband VPN Gateway 's DHCP Server

This is the default setting. The DHCP Server settings are on the *LAN* screen. On this screen, you can:

- Enable or Disable the Broadband VPN Gateway 's *DHCP Server* function.
- Set the range of IP Addresses allocated to PCs by the DHCP Server function.



You can assign Fixed IP Addresses to some devices while using DHCP, provided that the Fixed IP Addresses are NOT within the range used by the DHCP Server.

Using another DHCP Server

You can only use one (1) DHCP Server per LAN segment. If you wish to use another DHCP Server, rather than the Broadband VPN Gateway 's, the following procedure is required.

1. Disable the DHCP Server feature in the Broadband VPN Gateway. This setting is on the LAN screen.
2. Configure the DHCP Server to provide the Broadband VPN Gateway 's IP Address as the *Default Gateway*.

To Configure your PCs to use DHCP

This is the default setting for TCP/IP under Windows 95/98/ME.

See *Chapter 4 - Client Configuration* for the procedure to check these settings.

Load/Backup Screen

Use the *Load/Backup* link on the Setup menu. An example screen is shown below.

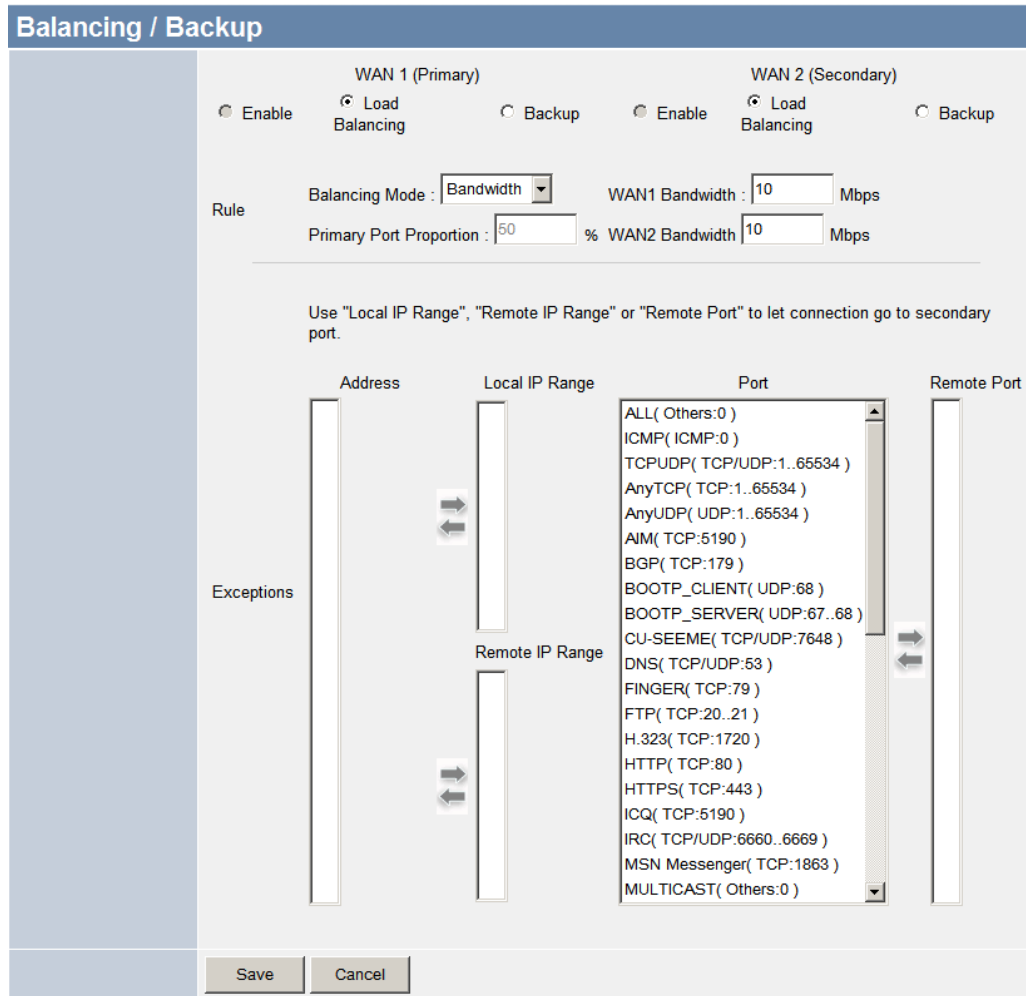

Figure 10: Load/Back Screen

Data - Load/Backup Screen

Administration	
WAN	<p>There are 3 modes:</p> <ol style="list-style-type: none"> 1. If <i>Enable</i> is selected for WAN 1, then choose <i>Backup</i> for WAN 2. 2. If <i>Load Balance</i> is selected for WAN 1, then choose <i>Load Balance</i> for WAN 2. 3. If <i>Backup</i> is selected for WAN 1, then choose <i>Enable</i> for WAN 2.
Auto	<p><i>Equilibrium Type</i> has 2 options:</p> <ul style="list-style-type: none"> • Determine by Bandwidth: If selected, enter the desired values of WAN1 and WAN2 Bandwidth. • Connection balanced automatically: Enter the percentage in the Primary Port Proportion field.
Exceptions	<p>Set up "Local IP Range", "Remote IP Range" or "Remote Port" to direct the connection through secondary port.</p>

Chapter 4

PC Configuration



This Chapter details the PC Configuration required on the local ("Internal") LAN.

Overview

For each PC, the following may need to be configured:

- TCP/IP network settings
- Internet Access configuration

Windows Clients

This section describes how to configure Windows clients for Internet access via the Broadband VPN Gateway.

The first step is to check the PC's TCP/IP settings.

The Broadband VPN Gateway uses the TCP/IP network protocol for all functions, so it is essential that the TCP/IP protocol be installed and configured on each PC.

TCP/IP Settings - Overview

If using the default Broadband VPN Gateway settings, and the default Windows TCP/IP settings, no changes need to be made.

- By default, the Broadband VPN Gateway will act as a DHCP Server, automatically providing a suitable IP Address (and related information) to each PC when the PC boots.
- For all non-Server versions of Windows, the default TCP/IP setting is to act as a DHCP client.

If using a Fixed (specified) IP address, the following changes are required:

- The *Gateway* must be set to the IP address of the Broadband VPN Gateway
- The *DNS* should be set to the address provided by your ISP.



If your LAN has a Router, the LAN Administrator must re-configure the Router itself. Refer to *Chapter 8 - Other Features and Operations* for details.

Checking TCP/IP Settings - Windows 9x/ME:

1. Select *Control Panel - Network*. You should see a screen like the following:

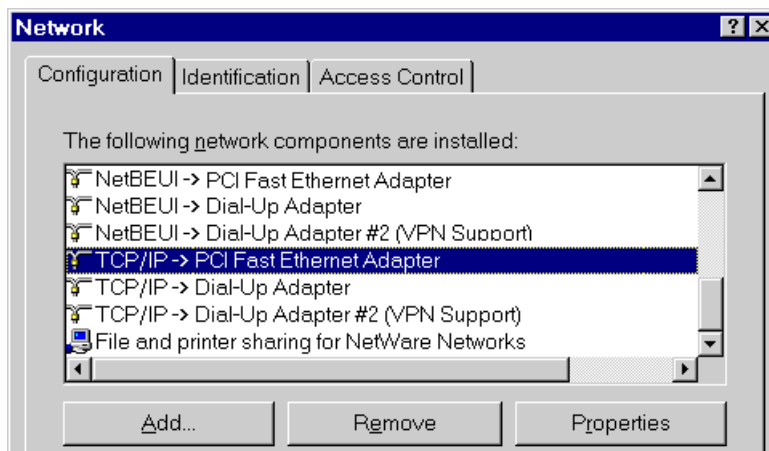

Figure 11: Network Configuration

2. Select the *TCP/IP* protocol for your network card.
3. Click on the *Properties* button. You should then see a screen like the following.

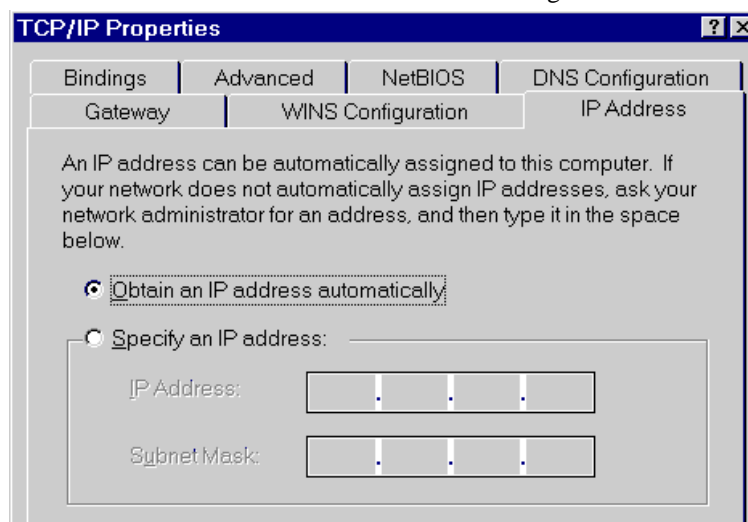

Figure 12: IP Address (Win 95)

Ensure your TCP/IP settings are correct, as follows:

Using DHCP

To use DHCP, select the radio button *Obtain an IP Address automatically*. This is the default Windows setting. **Using this is recommended.** By default, the Broadband VPN Gateway will act as a DHCP Server.

Restart your PC to ensure it obtains an IP Address from the Broadband VPN Gateway.

Using "Specify an IP Address"

If your PC is already configured, check with your network administrator before making the following changes:

- On the *Gateway* tab, enter the Broadband VPN Gateway's IP address in the *New Gateway* field and click *Add*, as shown below. Your LAN administrator can advise you of the IP Address they assigned to the Broadband VPN Gateway.

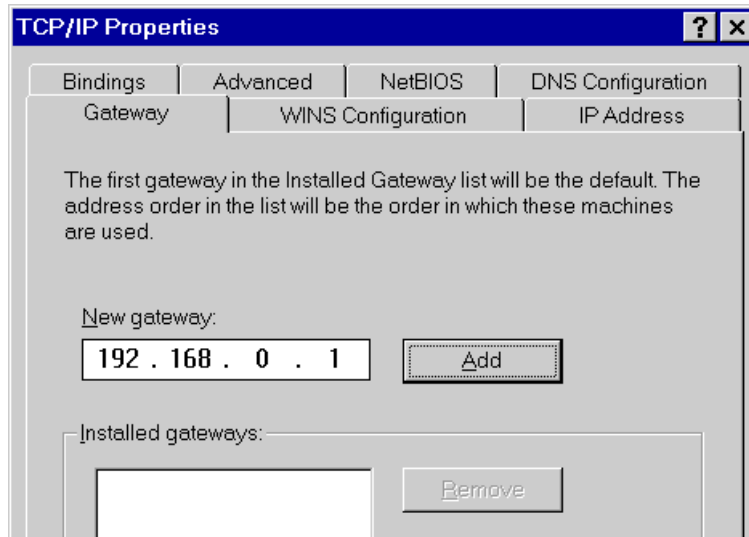

Figure 13: Gateway Tab (Win 95/98)

- On the *DNS Configuration* tab, ensure *Enable DNS* is selected. If the *DNS Server Search Order* list is empty, enter the DNS address provided by your ISP in the fields beside the *Add* button, then click *Add*.

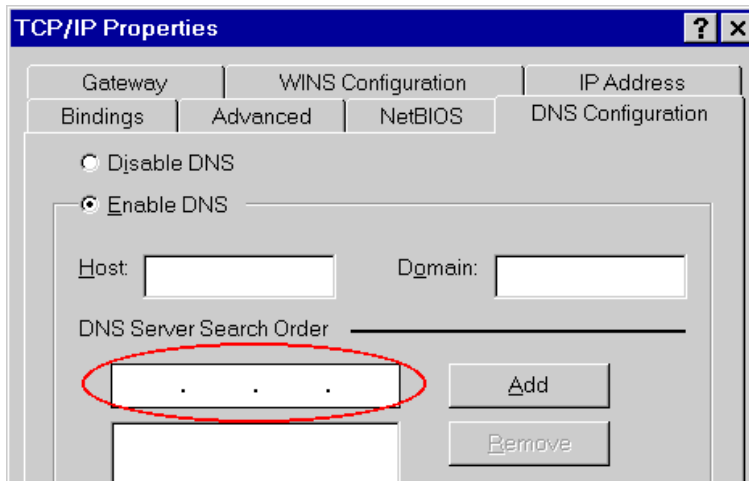

Figure 14: DNS Tab (Win 95/98)

Checking TCP/IP Settings - Windows NT4.0

1. Select *Control Panel - Network*, and, on the *Protocols* tab, select the TCP/IP protocol, as shown below.

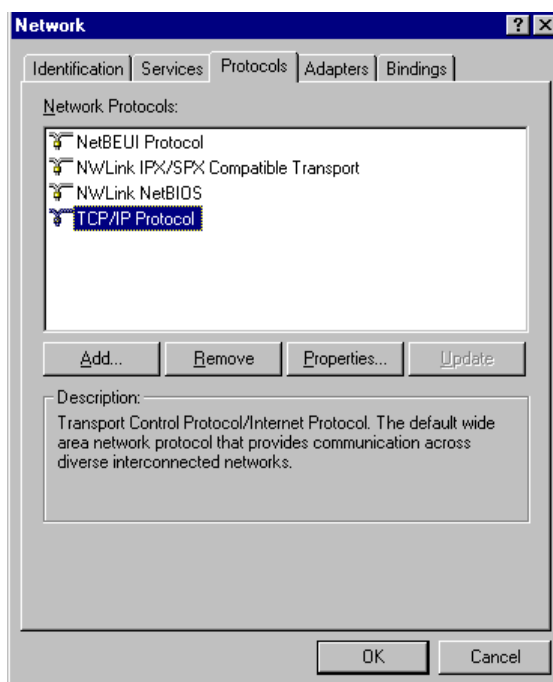

Figure 15: Windows NT4.0 - TCP/IP

2. Click the *Properties* button to see a screen like the one below.

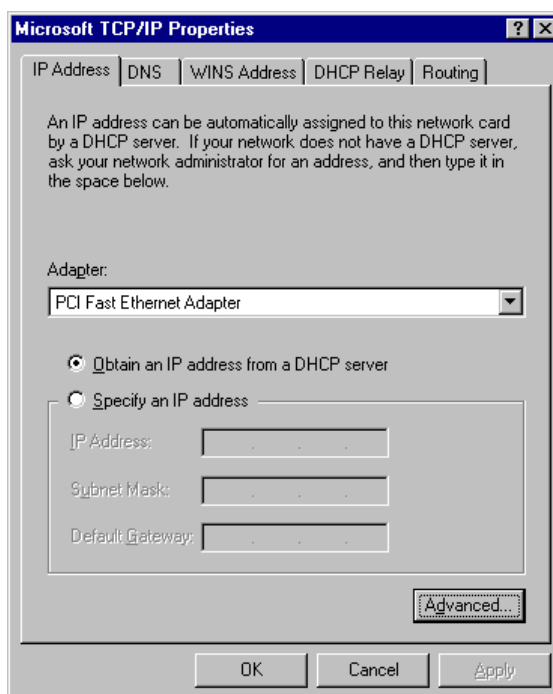

Figure 16: Windows NT4.0 - IP Address

3. Select the network card for your LAN.
4. Select the appropriate radio button - *Obtain an IP address from a DHCP Server* or *Specify an IP Address*, as explained below.

Obtain an IP address from a DHCP Server

This is the default Windows setting. **Using this is recommended.** By default, the Broadband VPN Gateway will act as a DHCP Server.

Restart your PC to ensure it obtains an IP Address from the Broadband VPN Gateway.

Specify an IP Address

If your PC is already configured, check with your network administrator before making the following changes.

1. The *Default Gateway* must be set to the IP address of the Broadband VPN Gateway. To set this:
 - Click the *Advanced* button on the screen above.
 - On the following screen, click the *Add* button in the *Gateways* panel, and enter the Broadband VPN Gateway 's IP address, as shown in Figure 17 below.
 - If necessary, use the *Up* button to make the Broadband VPN Gateway the first entry in the *Gateways* list.

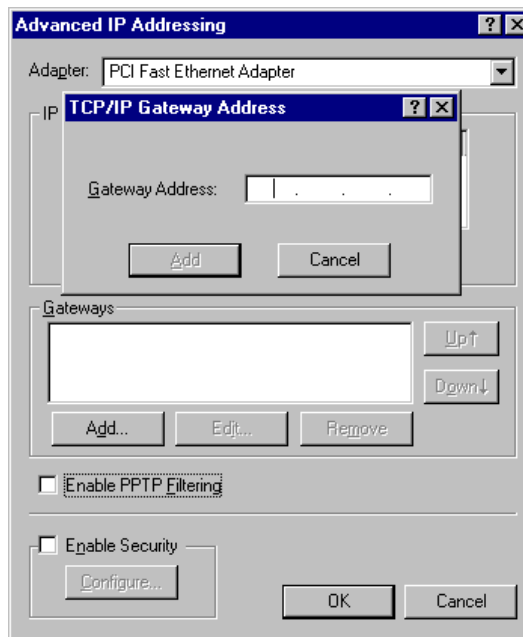

Figure 17 - Windows NT4.0 - Add Gateway

2. The DNS should be set to the address provided by your ISP, as follows:
 - Click the DNS tab.
 - On the DNS screen, shown below, click the *Add* button (under *DNS Service Search Order*), and enter the DNS provided by your ISP.

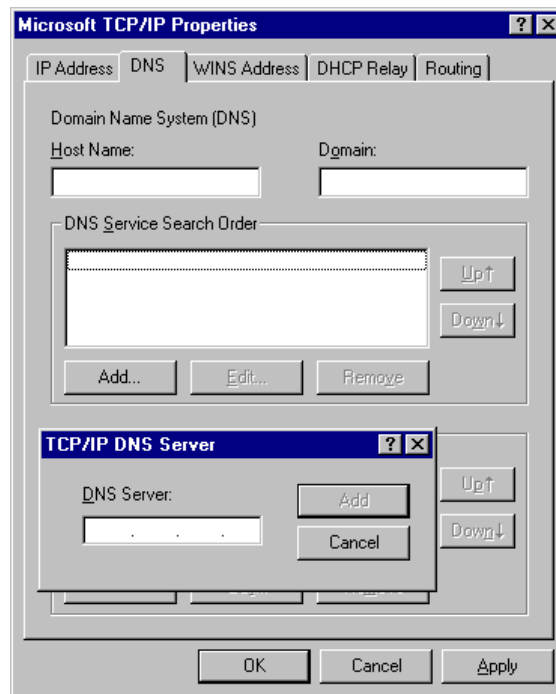

Figure 18: Windows NT4.0 - DNS

Checking TCP/IP Settings - Windows 2000:

1. Select *Control Panel - Network and Dial-up Connection*.
2. Right - click the *Local Area Connection* icon and select *Properties*. You should see a screen like the following:

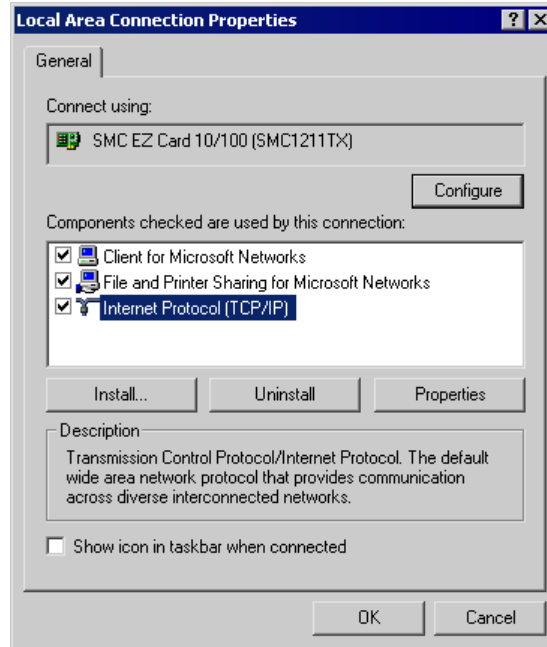

Figure 19: Network Configuration (Win 2000)

3. Select the *TCP/IP* protocol for your network card.
4. Click on the *Properties* button. You should then see a screen like the following.

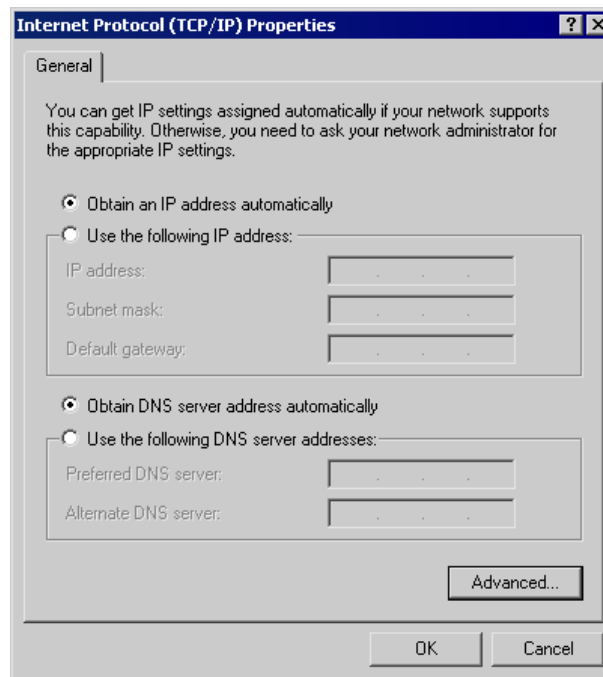

Figure 20: TCP/IP Properties (Win 2000)

5. Ensure your TCP/IP settings are correct, as described below.

Using DHCP

To use DHCP, select the radio button *Obtain an IP Address automatically*. This is the default Windows setting. **Using this is recommended.** By default, the Broadband VPN Gateway will act as a DHCP Server.

Restart your PC to ensure it obtains an IP Address from the Broadband VPN Gateway.

Using a fixed IP Address ("Use the following IP Address")

If your PC is already configured, check with your network administrator before making the following changes.

- Enter the Broadband VPN Gateway 's IP address in the *Default gateway* field and click *OK*. (Your LAN administrator can advise you of the IP Address they assigned to the Broadband VPN Gateway.)
- If the *DNS Server* fields are empty, select *Use the following DNS server addresses*, and enter the DNS address or addresses provided by your ISP, then click *OK*.

Checking TCP/IP Settings - Windows XP

1. Select *Control Panel - Network Connection*.
2. Right click the *Local Area Connection* and choose *Properties*. You should see a screen like the following:

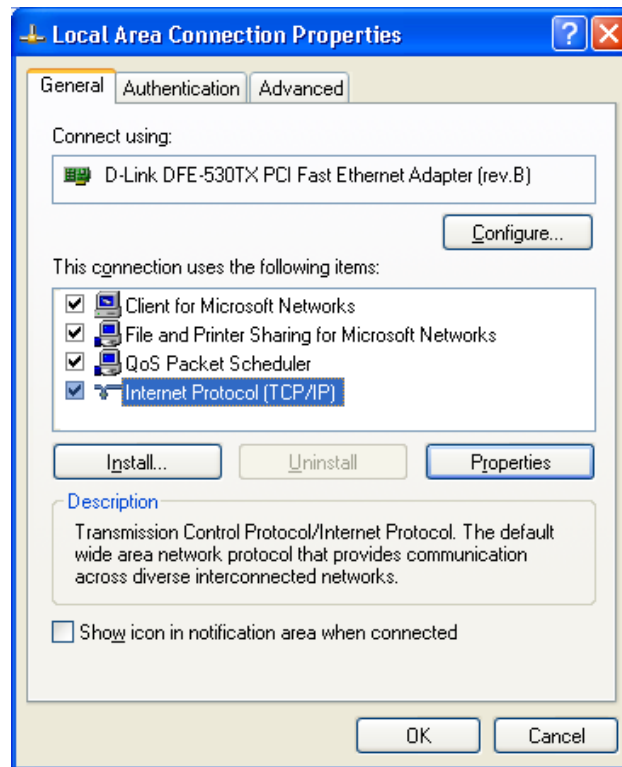

Figure 21: Network Configuration (Windows XP)

3. Select the *TCP/IP* protocol for your network card.
4. Click on the *Properties* button. You should then see a screen like the following.

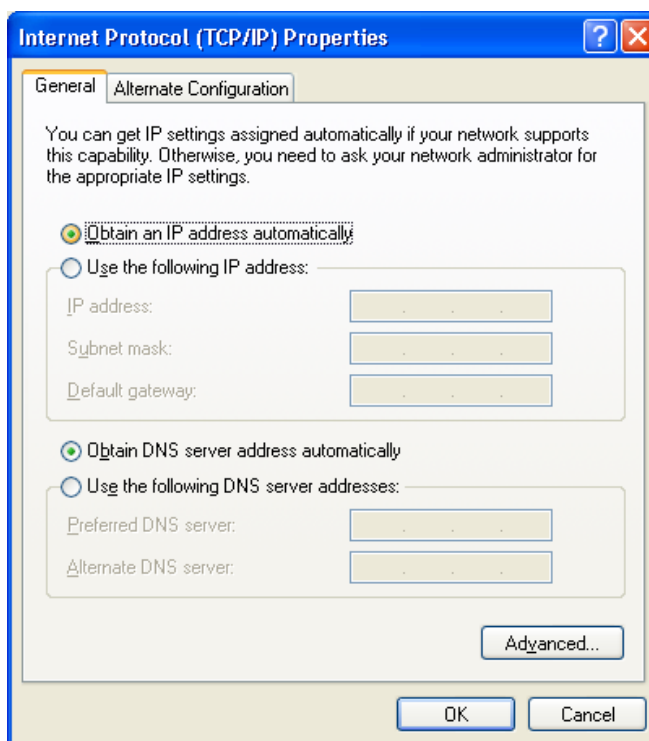

Figure 22: TCP/IP Properties (Windows XP)

5. Ensure your TCP/IP settings are correct.

Using DHCP

To use DHCP, select the radio button *Obtain an IP Address automatically*. This is the default Windows setting. **Using this is recommended.** By default, the Broadband VPN Gateway will act as a DHCP Server.

Restart your PC to ensure it obtains an IP Address from the Broadband VPN Gateway.

Using a fixed IP Address ("Use the following IP Address")

If your PC is already configured, check with your network administrator before making the following changes.

- In the *Default gateway* field, enter the Broadband VPN Gateway's IP address and click *OK*. Your LAN administrator can advise you of the IP Address they assigned to the Broadband VPN Gateway.
- If the *DNS Server* fields are empty, select *Use the following DNS server addresses*, and enter the DNS address or addresses provided by your ISP, then click *OK*.

Checking TCP/IP Settings - Windows Vista

1. From the Start menu, right-click Network, then click Properties. Now, the Network and Sharing Center displays.



2. Under Tasks located on the left-hand side of the window, click Manage network connections.



3. In Network Connections window displays, right click on the correct Local Area Connection, then click Properties.

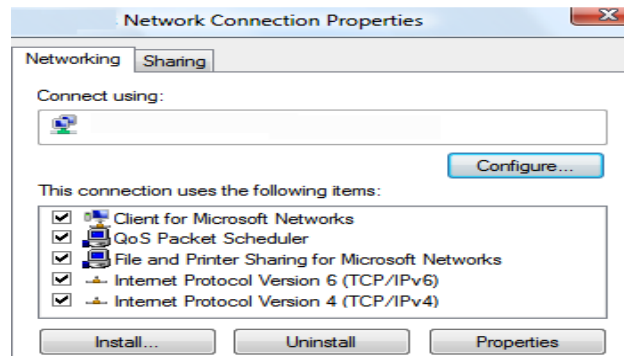

4. Pop-up window displays that states Windows needs your permission to continue. Click Continue to open the Local Area Connection Properties window

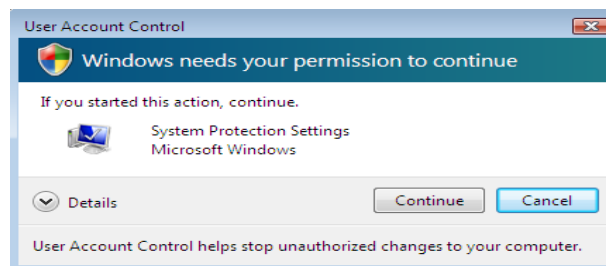

5. Select Internet Protocol Version 4 (TCP/IPv4), then click Properties. From the General tab, verify that Obtain an IP address automatically and Obtain DNS server address automatically are selected. Click the OK button.

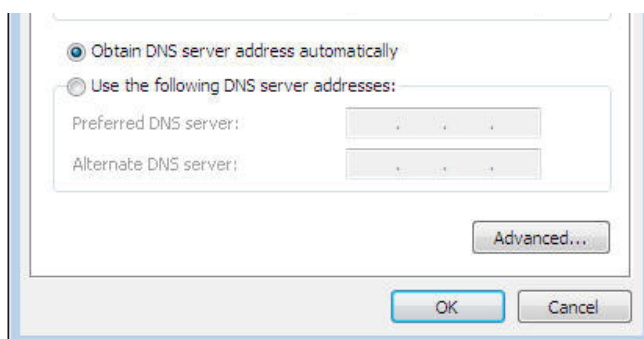

Internet Access

To configure your PCs to use the Broadband VPN Gateway for Internet access:

- Ensure that the DSL modem, Cable modem, or other permanent connection is functional.
- Use the following procedure to configure your Browser to access the Internet via the LAN, rather than by a Dial-up connection.

For Windows 9x/ME/2000

1. Select *Start Menu - Settings - Control Panel - Internet Options*.
2. Select the *Connection* tab, and click the *Setup* button.
3. Select "I want to set up my Internet connection manually, or I want to connect through a local area network (LAN)" and click *Next*.
4. Select "I connect through a local area network (LAN)" and click *Next*.
5. Ensure all of the boxes on the following Local area network Internet Configuration screen are **unchecked**.
6. Check the "No" option when prompted "Do you want to set up an Internet mail account now?".
7. Click *Finish* to close the Internet Connection Wizard.
Setup is now completed.

For Windows XP

1. Select *Start Menu - Control Panel - Network and Internet Connections*.
2. Select *Set up or change your Internet Connection*.
3. Select the *Connection* tab, and click the *Setup* button.
4. Cancel the pop-up "Location Information" screen.
5. Click *Next* on the "New Connection Wizard" screen.
6. Select "Connect to the Internet" and click *Next*.
7. Select "Set up my connection manually" and click *Next*.
8. Check "Connect using a broadband connection that is always on" and click *Next*.
9. Click *Finish* to close the New Connection Wizard.
Setup is now completed.

Accessing AOL

To access AOL (America On Line) through the Broadband VPN Gateway, the *AOL for Windows* software must be configured to use TCP/IP network access, rather than a dial-up connection. The configuration process is as follows:

- Start the *AOL for Windows* communication software. Ensure that it is Version 2.5, 3.0 or later. This procedure will not work with earlier versions.
- Click the *Setup* button.
- Select *Create Location*, and change the location name from "New Locality" to "Broadband VPN Gateway".
- Click *Edit Location*. Select *TCP/IP* for the *Network* field. (Leave the *Phone Number* blank.)
- Click *Save*, then *OK*.
Configuration is now complete.
- Before clicking "Sign On", always ensure that you are using the "Broadband VPN Gateway" location.

Macintosh Clients

From your Macintosh, you can access the Internet via the Broadband VPN Gateway. The procedure is as follows.

1. Open the TCP/IP Control Panel.
2. Select *Ethernet* from the *Connect via* pop-up menu.
3. Select *Using DHCP Server* from the *Configure* pop-up menu. The DHCP Client ID field can be left blank.
4. Close the TCP/IP panel, saving your settings.

Note:

If using manually assigned IP addresses instead of DHCP, the required changes are:

- Set the *Router Address* field to the Broadband VPN Gateway 's IP Address.
- Ensure your DNS settings are correct.

Linux Clients

To access the Internet via the Broadband VPN Gateway, it is only necessary to set the Broadband VPN Gateway as the "Gateway".

Ensure you are logged in as "root" before attempting any changes.

Fixed IP Address

By default, most Unix installations use a fixed IP Address. If you wish to continue using a fixed IP Address, make the following changes to your configuration.

- Set your "Default Gateway" to the IP Address of the Broadband VPN Gateway.
- Ensure your DNS (Name server) settings are correct.

To act as a DHCP Client (recommended)

The procedure below may vary according to your version of Linux and X -windows shell.

1. Start your X Windows client.
2. Select *Control Panel - Network*
3. Select the "Interface" entry for your Network card. Normally, this will be called "eth0".
4. Click the *Edit* button, set the "protocol" to "DHCP", and save this data.
5. To apply your changes
 - Use the "Deactivate" and "Activate" buttons, if available.
 - OR, restart your system.

Other Unix Systems

To access the Internet via the Broadband VPN Gateway:

- Ensure the "Gateway" field for your network card is set to the IP Address of the Broadband VPN Gateway.
- Ensure your DNS (Name Server) settings are correct.

Chapter 5

Operation and Status



This Chapter details the operation of the Broadband VPN Gateway and the status screens.

Operation

Once both the Broadband VPN Gateway and the PCs are configured, operation is automatic.

However, there are some situations where additional Internet configuration may be required:

- If using Internet-based **Communication Applications**, it may be necessary to specify which PC receives an incoming connection. Refer to *Chapter 6 - Internet Features* for further details.
- Applications which use non-standard connections or port numbers may be blocked by the Broadband VPN Gateway 's built-in firewall. You can define such applications as **Special Applications** to allow them to function normally. Refer to *Chapter 6 - Internet Features* for further details.
- Some non-standard applications may require use of the **DMZ** feature. Refer to *Chapter 6 - Internet Features* for further details.

Status Screen

Use the **Status** link on the main menu to view this screen.

General Status	
WAN1	<p>Connection Method : Dynamic IP</p> <p>IP Address : 192.168.1.51</p> <p>Subnet Mask : 255.255.255.0</p> <p>Gateway : 192.168.1.254</p> <p>DNS IP Address : 192.168.1.245</p> <p>MAC Address : 00:c0:02:ff:b3:97</p> <p>Connection Status : Connection:7, Throughput:less than1Kbps</p> <p>Internet Connection : <input type="button" value="Disconnect"/></p>
WAN2	<p>Connection Method : Dynamic IP</p> <p>IP Address :</p> <p>Subnet Mask :</p> <p>Gateway :</p> <p>DNS IP Address :</p> <p>MAC Address : 00:c0:02:ff:b3:98</p> <p>Connection Status : Connection:0, Throughput:less than1Kbps</p> <p>Internet Connection : <input type="button" value="Connect"/></p>
LAN	<p>Port Status : ON</p> <p>IP Address : 192.168.0.1</p> <p>Subnet Mask : 255.255.255.0</p> <p>MAC Address : 00:c0:02:ff:b3:96</p> <p>DHCP Server : Open</p> <p>DHCP Clients : 50</p>
Firewall	<p>Rule Number : 4 Entry</p> <p>Advanced Rule Number : 0 Entry</p> <p>System Rule Number : 4 Entry</p> <p>Remote Access : N/A</p> <p>E-mail Log : N/A</p> <p>DMZ : N/A</p> <p>Address List : N/A</p>
Kernel	<p>FireWall Version : v1006</p> <p>PC Bundle Rule : N/A</p> <p>Load Balancing : Bandwidth, main port shares 50% WAN 2 is disconnected, all connections redirected to WAN 1.</p> <p>VPN Tunnel Number : N/A</p> <p>DDNS Status : N/A</p>
System	<p>Device Name : TW100-BRV324</p> <p>Firmware Version : Version 1.0 Release 00</p> <p>System Up Time : 2007-08-15 13:24:30</p> <p>System Run Time : 0hour(s) 3minute(s) 24second(s)</p> <p>Session Loading : 7/40000</p> <p>Language Version : Default</p>
<p><input type="button" value="Restart"/> <input type="button" value="Refresh"/> <input type="button" value="Show Status"/></p>	

Figure 23: General Status Screen

Data - General Status Screen

WAN1/2	
Connection Method	This indicates the current connection method.
IP Address	This IP Address is allocated by the ISP (Internet Service Provider).
Subnet Mask	The Subnet Mask associated with the IP Address above.
Gateway	The IP Address of the remote Gateway or Router associated with the IP Address above.
DNS IP Address	The IP Address of the Domain Name Server which is currently used.
MAC Address	Also called Network Adapter Address or Physical Address. This is a low-level identifier, as seen from the WAN port.
Connection Status	It displays the current connection status.
Internet Connection	Click the button to connect or disconnect the internet connection.
LAN	
Port Status	This shows the status of the port.
IP Address	The IP Address of the Broadband VPN Gateway.
Subnet Mask	The Subnet Mask for the IP Address above.
MAC Address	Also called Network Adapter Address or Physical Address.
DHCP Server	This shows the status of the DHCP Server function. For additional information about the PCs on your LAN, and the IP addresses allocated to them, use the <i>PC Database</i> option on the <i>Advanced</i> menu.
DHCP Clients	This shows the number of DHCP clients supported.
Firewall	
Firewall	This shows the current settings of the firewall.
Kernel	
Kernel	This shows the current status of the kernel.
System	
Device Name	This displays the current name of the Broadband VPN Gateway.
Firmware Version	The current version of the firmware installed in the Broadband VPN Gateway.
System Up/Run Time	This shows the system running time.
Session Loading	This indicates the loading status of the session.
Language Version	This shows the language version of the Broadband VPN Gateway.
Buttons	
Restart	Restart (reboot) the Router. You will have to wait for the restart to be completed before continuing.
Refresh Screen	Update the data displayed on screen.

Show Status	Display the usage of the CPU and Memory in a sub-window.
--------------------	----------------------------------------------------------

Port Status

Click the "Port Status" button on the *Status Log* menu. An example screen is shown below.

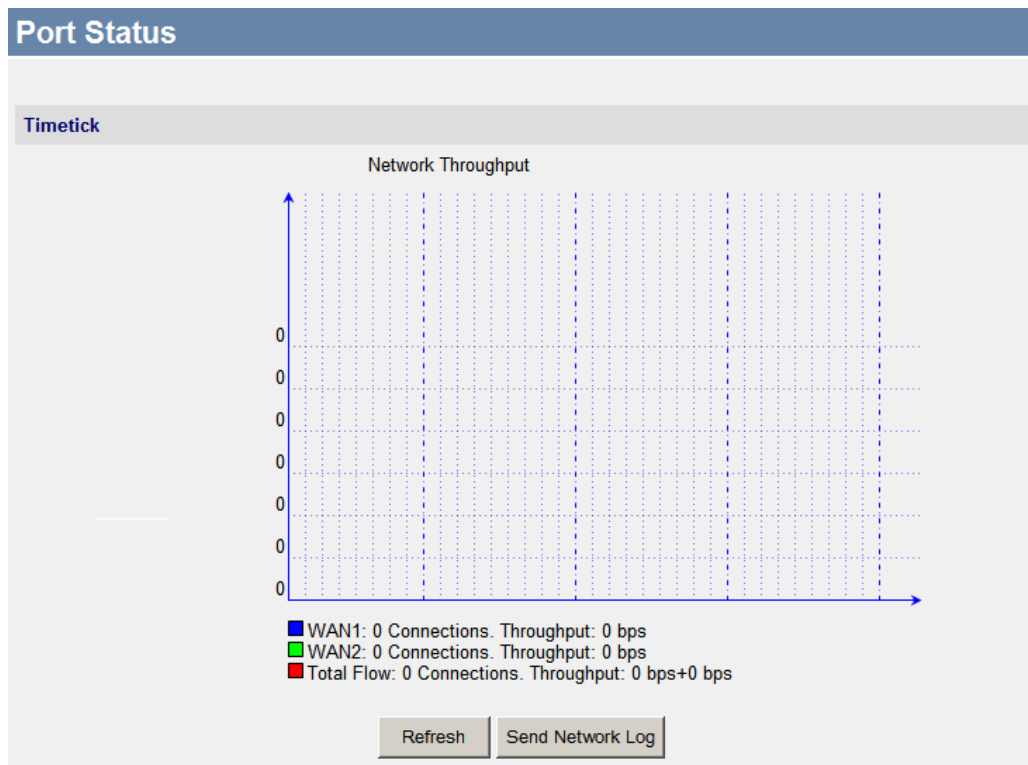

Figure 24: Port Status Screen

Data - Port Status Screen

Port Status	
Network Flow	The picture shows the current network flow.
Buttons	
Refresh	Update the data on screen.
Send Network Log	Click this button will send the log to the specified E-mail address.

Event Log

An example screen is shown below.

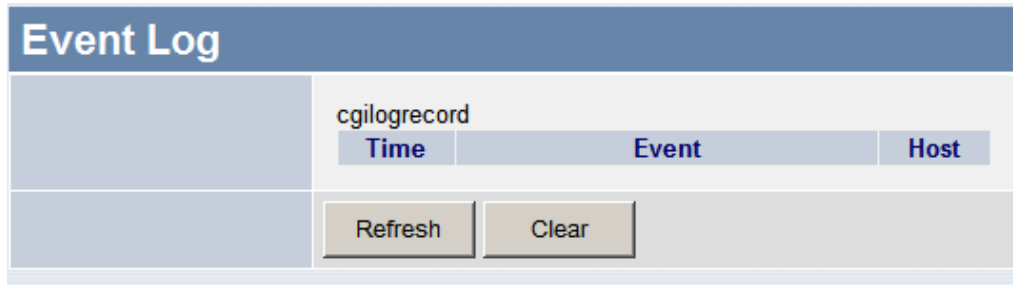

Figure 25: Event Log Screen

Data - Event Log Screen

Event Log	
Time	It displays the time when the event occurred.
Event	It describes the details of the event.
Host	It displays the IP Address of the server.
Buttons	
Refresh	Update the data shown on screen.
Clear	Delete all data currently in the Log.

URL Log

An example screen is shown below.

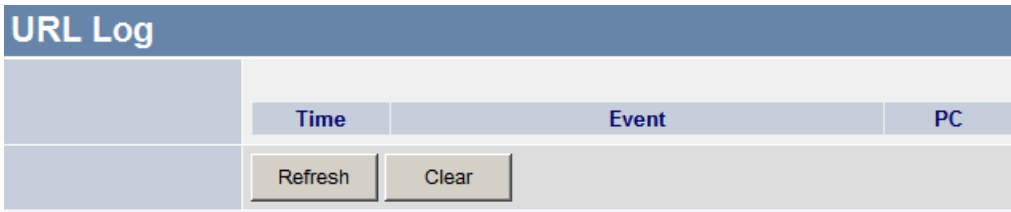

Figure 26: URL Log

Data - URL Log

Internet	
Time	It displays the time when the log occurred.
Event	It describes the address of the URL.
PC	It displays the IP Address of the PC.
Buttons	
Refresh	Update the data shown on screen.
Clear	Delete all data currently in the Log.

System Log

An example screen is shown below.

The screenshot shows a web interface titled "Syslog". It features a search section with two dropdown menus: "Search Type" set to "Any Module" and another set to "Any". There are "Search" and "Default Search" buttons. Below this is a table header with columns: "Time", "Event", and "Data Packet Description". The table content is currently empty. At the bottom of the interface, there are "Refresh" and "Clear" buttons, and a pagination section with "Last Page", "Next Page", "Jump to Page:" followed by an input field, and a "Jump" button.

Figure 27: System Log

Data - System Log Screen

System Log	
Search Type	Select the desired options of search type. Click the “Search” button to see the logs in the following log table.
Time	It displays the time when the system log occurred.
Event	It describes the details of the event.
Data Packet Description	It displays the type, source and destination address of the packet.

Chapter 6

Internet Features

6

This Chapter explains when and how to use the Broadband VPN Gateway's "Internet" Features.

Overview

The following advanced features are provided.

- Address List
- PC Database
- URL Filter
- Dynamic DNS
- Static Routing
- QoS

Address List

Click the "Address List" on the *Advanced* menu to access the screen. An example screen is shown below.

The screenshot shows the 'Address List' configuration interface. At the top, there's a header 'Address List'. Below it is a table with the ID 'addrlist_table' and two columns: 'Name' and 'IP Address Section'. Underneath the table, there's a checkbox labeled 'Select All/Cancel' and a 'Delete' button. A section below contains the instruction 'Select one item from the Address List, then click' followed by an 'Edit' button. This section includes input fields for 'Address List Name', and four 'Range' fields (Range 1 through Range 4). Each range field consists of a main input box, a sub-input box below it, and a hyphen to its right. At the bottom of the form, there are 'Add' and 'Modify' buttons.

Figure 28: Address List Screen

Data - Address List Screen

Address List	
Address List	This lists any existing entries. If you have not entered any values, this list will be empty.
Select All/Cancel	Use this to select/deselect all the entries in the list.
Delete Button	Use this button to delete the selected address list entry
Address List Name	The name of the address list.
Range 1~4	Enter the IP Address range. You can set up to 4 ranges for each address list.
Rule for ...	Select the desired option.

PC Database

The PC Database is used whenever you need to select a PC (e.g. for the "DMZ" PC). It eliminates the need to enter IP addresses. Also, you do not need to use fixed IP addresses on your LAN.

PC Database Screen

An example PC Database screen is shown below.

PC Database

To modify PC list, please select one item from the PC Database Table, then click "Edit/Delete" button.

pcdb_table

<input type="checkbox"/>	PC Name	MAC Address	IP Address	<input type="checkbox"/> Need to Certify
pcdb_table				

pclist_inf

Jump to Page:

Figure 29: PC Database

- PCs which are "DHCP Clients" are automatically added to the database, and updated as required.
- By default, non-Server versions of Windows act as "DHCP Clients"; this setting is called "Obtain an IP Address automatically".
- The Broadband VPN Gateway uses the "Hardware Address" to identify each PC, not the name or IP address. The "Hardware Address" can only change if you change the PC's network card or adapter.
- This system means you do NOT need to use Fixed (static) IP addresses on your LAN. However, you can add PCs using Fixed (static) IP Addresses to the PC database if required.

Data - PC Database Screen

PC List	This lists all current entries. Data displayed is <i>PC Name</i> , <i>MAC Address</i> , <i>IP Address</i> and <i>Certify</i> .
Buttons	
Edit	To Edit or modify an existing entry, select it and click the "Edit" button.
Delete	Delete the selected PC from the list. This should be done in 2 situations: <ul style="list-style-type: none">• The PC has been removed from your LAN.• The entry is incorrect.
Add	This will add the new PC to the list. The PC will be sent a "ping" to determine its hardware address. If the PC is not available (not connected, or not powered On) you will not be able to add it.
Refresh	Update the data on screen.

URL Filter

The URL Filter allows you to block access to undesirable Web site.

An example screen is shown below.

Number	Property	Name	Contents
1	White List		
2	White List		
3	White List		
4	Black List		

urfilter_table

URL Filter Rule List:

URL Filter Rule Name:

Add Key Words:

Figure 30: URL Filter Screen

Data - URL Filter Screen

Filter Strings	
Current Entries	This lists any existing entries. If you have not entered any values, this list will be empty.
URL Filter Rule List	Select the desired rule from the list.
URL Filter Rule Name	After the URL Filter Rule is selected, enter the desired name in this field. Click <i>Edit</i> button to modify the setting

Add Key Words	<p>To add an entry to the list, enter it here, and click the "Add" button. An entry may be a Domain name (e.g. www.trash.com) or simply a string. (e.g. ads/) Any URL which contains ANY entry ANYWHERE in the URL will be blocked.</p>
Buttons	
Delete Selected/Delete All	<p>Use these buttons to delete the selected entry or all entries, as required. Multiple entries can be selected by holding down the CTRL key while selecting. (On the Macintosh, hold the SHIFT key while selecting.)</p>
Add	<p>Use this to add the current Filter String to the site list.</p>
Modify Rule	<p>Click the "Modify Rule" button to edit an existing rule.</p>

Dynamic DNS

This free service is very useful when combined with the *Virtual Server* feature. It allows Internet users to connect to your Virtual Servers using a URL, rather than an IP Address.

This also solves the problem of having a dynamic IP address. With a dynamic IP address, your IP address may change whenever you connect, which makes it difficult to connect to you.

The Service works as follows:

1. You must register for the service at one of the listed DDNS Service providers.
2. After registration, follow the Service Provider's procedure to request a Domain Name, and have it allocated to you.
3. Enter your DDNS data on the Broadband VPN Gateway's DDNS screen (shown below).
4. The Broadband VPN Gateway will then automatically ensure that your current IP Address is recorded and updated at the DDNS server.
If the DDNS Service provides software to perform this "IP address update"; you should disable the "Update" function, or not use the software at all.
5. From the Internet, users will be able to connect to your Virtual Servers (or DMZ PC) using your Domain name, as shown on this screen.

Dynamic DNS Screen

Dynamic DNS	
WAN1	DDNS Service : <input type="text" value="None"/> <input type="button" value="Web Site"/> DDNS Status : User Name : <input type="text"/> Password : <input type="text"/> Domain Name : <input type="text"/>
WAN2	DDNS Service : <input type="text" value="None"/> <input type="button" value="Web Site"/> DDNS Status : User Name : <input type="text"/> Password : <input type="text"/> Domain Name : <input type="text"/>
<input type="button" value="Save"/> <input type="button" value="Cancel"/>	

Figure 31: Dynamic DNS Screen

Data - Dynamic DNS Screen

WAN1/2	
DDNS Service	Select the desired DDNS Service provider.
Web Site Button	Click this button to open a new window and connect to the Web site for the selected DDNS service provider.
DDNS Status	<ul style="list-style-type: none">• This message is returned by the DDNS Server• Normally, this message should be something like "Update successful" or "IP address updated".• If the message indicates some problem, you need to connect to the DDNS Service provider and correct this problem.
User Name	Enter your Username for the DDNS Service.
Password	Enter your current password for the DDNS Service.
Domain Name	Enter the domain name allocated to you by the DDNS Service. If you have more than one name, enter the name you wish to use.

Static Routing

Overview

- If you don't have other Routers or Gateways on your LAN, you can ignore the "Routing" page completely.
- If the Broadband VPN Gateway is only acting as a Gateway for the local LAN segment, ignore the "Routing" page even if your LAN has other Routers.
- If your LAN has a standard Router (e.g. Cisco) on your LAN, and the Broadband VPN Gateway is to act as a Gateway for all LAN segments, enable RIP (Routing Information Protocol) and ignore the Static Routing table.
- If your LAN has other Gateways and Routers, and you wish to control which LAN segments use each Gateway, do NOT enable RIP (Routing Information Protocol). Configure the Static Routing table instead. (You also need to configure the other Routers.)
- If using Windows 2000 Data center Server as a software Router, enable RIP on the Broadband VPN Gateway, and ensure the following Windows 2000 settings are correct:
 - Open *Routing and Remote Access*
 - In the console tree, select *Routing and Remote Access, [server name], IP Routing, RIP*
 - In the "Details" pane, right-click the interface you want to configure for RIP version 2, and then click "Properties".
 - On the "General" tab, set *Outgoing packet protocol* to "RIP version 2 broadcast", and *Incoming packet protocol* to "RIP version 1 and 2".

Static Routing Screen

Using this Screen

Generally, you will use either RIP (Routing Information Protocol) OR the Static Routing Table, as explained above, although it is possible to use both methods simultaneously.

Static Routing Table

- If RIP is not used, an entry in the routing table is required for each LAN segment on your Network, other than the segment to which this device is attached.
- The other Routers must also be configured.

Figure 32: Static Routing Screen

Data - Static Routing Screen

RIP	
RIP Version	Select the desired option from the drop-down list.
Static Routing	
Static Routing Table Entries	<p>This list shows all entries in the Routing Table.</p> <ul style="list-style-type: none"> The "Properties" area shows details of the selected item in the list. Change any the properties as required, then click the "Update Route" button to save the changes to the selected entry.
Properties	<ul style="list-style-type: none"> Destination Network - The network address of the remote LAN segment. For standard class "C" LANs, the network address is the first 3 fields of the Destination IP Address. The 4th (last) field can be left at 0. Subnet Mask - The Subnet Mask for the remote LAN segment. For class "C" networks, the default mask is 255.255.255.0 Gateway IP Address - The IP Address of the Gateway or Router which the Broadband VPN Gateway must use to communicate with the destination above. (NOT the router attached to the remote segment.) Port - Normally, this will be "LAN". If NAT is disabled, the "WAN" option can be used for Routers which are accessed via the WAN port. Metric - The number of "hops" (routers) to pass through to reach the remote LAN segment. The shortest path will be used. The default value is 1.

Buttons	
Save	Save the RIP setting. This has no effect on the Static Routing Table.
Add Route	Add a new entry to the Static Routing table, using the data shown in the "Properties" area on screen. The entry selected in the list is ignored, and has no effect.
Update Route	Update the current Static Routing Table entry, using the data shown in the "Properties" area on screen.
Delete Route	Delete the current Static Routing Table entry.
Clear	Clear all data from the "Properties" area, ready for input of a new entry for the Static Routing table.
Routing Table	Generate a read-only list of all entries in the Static Routing table.

Configuring Other Routers on your LAN

It is essential that all IP packets for devices not on the local LAN be passed to the Broadband VPN Gateway, so that they can be forwarded to the external LAN, WAN, or Internet. To achieve this, the local LAN must be configured to use the Broadband VPN Gateway as the *Default Route* or *Default Gateway*.

Local Router

The local router is the Router installed on the same LAN segment as the Broadband VPN Gateway. This router requires that the *Default Route* is the Broadband VPN Gateway itself. Typically, routers have a special entry for the *Default Route*. It should be configured as follows.

Destination IP Address	Normally 0.0.0.0, but check your router documentation.
Network Mask	Normally 0.0.0.0, but check your router documentation.
Gateway IP Address	The IP Address of the Broadband VPN Gateway.
Interface	LAN
Metric	2

Other Routers on the Local LAN

Other routers on the local LAN must use the Broadband VPN Gateway's *Local Router* as the *Default Route*. The entries will be the same as the Broadband VPN Gateway's local router, with the exception of the *Gateway IP Address*.

- For a router with a direct connection to the Broadband VPN Gateway's local Router, the *Gateway IP Address* is the address of the Broadband VPN Gateway's local router.
- For routers which must forward packets to another router before reaching the Broadband VPN Gateway's local router, the *Gateway IP Address* is the address of the intermediate router.

Static Routing - Example

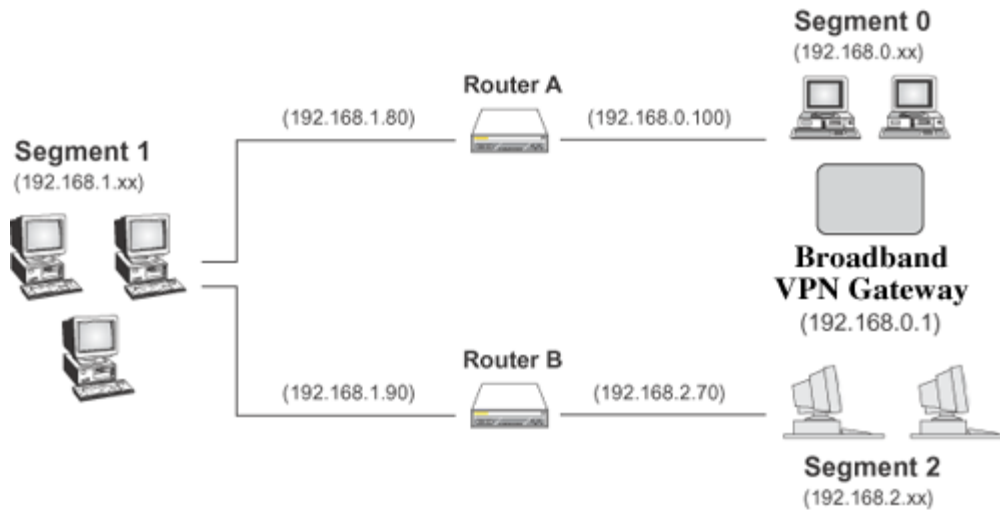

Figure 33: Routing Example

For the Broadband VPN Gateway 's Routing Table

For the LAN shown above, with 2 routers and 3 LAN segments, the Broadband VPN Gateway requires 2 entries as follows.

Entry 1 (Segment 1)	
Destination IP Address	192.168.1.0
Network Mask	255.255.255.0 (Standard Class C)
Gateway IP Address	192.168.0.100 (Broadband VPN Gateway 's local Router)
Interface	LAN
Metric	2
Entry 2 (Segment 2)	
Destination IP Address	192.168.2.0
Network Mask	255.255.255.0 (Standard Class C)
Gateway IP Address	192.168.0.100
Interface	LAN
Metric	3

For Router A's Default Route

Destination IP Address	0.0.0.0
Network Mask	0.0.0.0
Gateway IP Address	192.168.0.1 (Broadband VPN Gateway 's IP Address)
Interface	LAN

For Router B's Default Route

Destination IP Address	0.0.0.0
------------------------	---------

Network Mask	0.0.0.0
Gateway IP Address	192.168.1.80 (Broadband VPN Gateway 's local router)
Interface	LAN

QoS

Quality of Service (QoS) ensures better service to high-priority service.

QoS

Use QoS in This Way : Classic QoS

WAN Throughput (Kbps):

Interface	Limit IN	Limit OUT
WAN1	0	0
WAN2	0	0

Traffic Balance:

When Throughput over 0 %

Data limit per PC 0
(Kbps)

Exception None

Action blocked 0 minute(s)

Queue Setting:

QoS Queue	Priority	Reliability	Speed Limit
Priority Queue	6	High	No Limit
High-speed Queue 4	5	High	0 (Kbps)
High-speed Queue 3	4	High	0 (Kbps)
High-speed Queue 2	2	High	0 (Kbps)
High-speed Queue 1	1	High	0 (Kbps)
Default Queue	1	Low	0 (Kbps)

pay attention:those overlmit traffic will be redirect to AF1 queue when pc balance enabled

Save
Cancel

Figure 34: QoS Screen

Data - QoS Screen

QoS Setting	
QoS Method	Select the desired option. <ul style="list-style-type: none"> Disabled Based on data packet type

-
- QoS Queue: It displays the queue type.
 - Priority: Enter the priority value (1~20) of the policy.
 - Reliability: Select the desired option from the drop-down list.
 - Speed Limit: Enter the desired values for the inbound and outbound traffic limitation.
 - **Based on QoS rules set below**
 - Policy Name: It displays the name for the policy.
 - Throughput: It displays the information of the traffic.
 - Queue: Select the desired option.
 - Enable: Check this to enable this policy.
 - Qos Traffic Button: Click this button to access the sub-screen, and define the traffic for the selected policy.
-

Chapter 7

Security Configuration



This Chapter explains the settings available via the security configuration section of the "Security" menu.

Overview

The following advanced configurations are provided.

- Rules
- Schedules
- Log Setting
- Services
- Security
- DMZ
- E-Mail

Rules

For normal operation and LAN protection, it is not necessary to use this screen.

The Firewall will always block DoS (Denial of Service) attacks. A DoS attack does not attempt to steal data or damage your PCs, but overloads your Internet connection so you can not use it - the service is unavailable.

As well, you can use this screen to create Firewall rules to block or allow specific traffic. But incorrect configuration may cause serious problems.

This feature is for advanced administrators only!

Rules Screen

Click the *Rules* option on the Firewall menu to see a screen like the following example. This example contains two (2) rules for outgoing traffic.

Rules										
Outbound Rules										
#	Name	Enable	Service	Advanced	Action	Internal Address	External Address	WAN Port	Schedule	Log
1	N.A.	<input checked="" type="checkbox"/>	Any	- -	Forward	Any	Any	WAN1	- -	Match
2	N.A.	<input checked="" type="checkbox"/>	Any	- -	Forward	Any	Any	WAN2	- -	Match
Add Edit Move Delete										
Inbound Rules										
#	Name	Enable	Service	Advanced	Action	External Address	Internal Address	WAN Port	Schedule	Log
1	N.A.	<input checked="" type="checkbox"/>	Any	- -	Block	Any	Any	WAN1	- -	Match
2	N.A.	<input checked="" type="checkbox"/>	Any	- -	Block	Any	Any	WAN2	- -	Match
Add Edit Move Delete										
Save										

Figure 35: Rules Screen

Data - Rules Screen

Outbound/Inbound Connection	
View Rules for..	Select the desired option; the screen will update and list any current rules. If you have not defined any rules, the list will be empty.
Data	<p>For each rule, the following data is shown:</p> <ul style="list-style-type: none"> • Name - The name you assigned to the rule. • Source - The traffic covered by this rule, defined by the source IP address. If the IP address is followed by ... this indicates there is range of IP addresses, rather than a single address. • Destination - The traffic covered by this rule, defined by destination IP address. If the IP address is followed by ... this indicates there is range of IP addresses, rather than a single address. • Action - Action will be "Forward" or "Block"
Add	To add a new rule, click the "Add" button, and complete the resulting screen. See the following section for more details.
Edit	To Edit or modify an existing rule, select it and click the "Edit" button.
Move	<p>There are 2 ways to change the order of rules</p> <ul style="list-style-type: none"> • Use the up and down indicators on the right to move the selected rule. You must confirm your changes by clicking "OK". If you change your mind before clicking "OK", click "Cancel" to reverse your changes. • Click "Move" to directly specify a new location for the selected rule.
Delete	To delete an existing rule, select it and click the "Delete" button.

Define Firewall Rule (Inbound/Outbound)

Clicking the "Add" button in the *Firewall Rules* screen will display a screen like the example below.

Add / Edit Firewall(Inbound Connection)

Name:

Port:

Type:

Source IP Address: IP Type
 IP Address
 IP Address List

Destination IP Address: IP Type
 IP Address
 IP Address List

Service:

Advanced Rule:

Port Transfer To:

Select Schedule:

Action:

Log Setting:

Figure 36: Define Firewall Rule

Data - Define Firewall Rule Screen

Name	Enter a suitable name for this rule.
Port	Select the desired port as required.
Type	This determines the source and destination ports for traffic covered by this rule. Select the desired option.
Source IP	<p>These settings determine which traffic, based on their source IP address, is covered by this rule.</p> <p>Select the desired option:</p> <ul style="list-style-type: none"> Any - All traffic from the source port is covered by this rule. Single address - Enter the required IP address in the "Start IP address" field". You can ignore the "Subnet Mask" field. IP Address List - If this option is selected, choose the required option.

Dest IP	<p>These settings determine which traffic, based on their destination IP address, is covered by this rule.</p> <p>Select the desired option:</p> <ul style="list-style-type: none"> • Any - All traffic from the source port is covered by this rule. • Single address - Enter the required IP address in the "Start IP address" field". You can ignore the "Subnet Mask" field. • IP Address List - If this option is selected, choose the required option.
Services	Select the desired Service or Services. This determines which packets are covered by this rule, based on the protocol (TCP or UDP) and port number. If necessary, you can define a new Service on the "Services" screen, by defining the protocols and port numbers used by the Service.
Advanced Rule	Select the desired advanced rule .
Port Transfer To	Enter the required data.
Select Schedule	Select the desired option from the list.
Action	Select the desired action for packets covered by this rule:
Log Setting	This determines whether packets covered by this rule are logged. Select the desired option.

Schedules

- Blocking will be performed during the scheduled time (between the "Begin" and "End" times.)
- Two (2) separate sessions or periods can be defined.
- Times must be entered using a 24 hr clock.
- If the time for a particular day is blank, no action will be performed.

Schedules Screen

This screen is accessed by the *Schedules* link on the *Firewall* menu.

The screenshot shows a web interface titled "Schedule" with a table for "schedule_s_info". The table has columns for "#", "Schedule", "Mon.", "Tue.", "Wed.", "Thu.", "Fri.", "Sat.", "Sun.", "Time Interval 1 Begin", "Time Interval 1 End", "Time Interval 2 Begin", and "Time Interval 2 End". Below the table are four buttons: "Add", "Delete", "Edit", and "Cancel".

Figure 37: Schedules Screen

Data - Schedules Screen

Day	Each day of the week can be scheduled independently.
Time Interval 1 Time Interval 2	Two (2) separate sessions or periods can be defined. Session 2 can be left blank if not required.
Begin	Enter the start using a 24 hr clock.
End	Enter the finish time using a 24 hr clock.

Firewall -- Log

The Logs record various types of activity on the Broadband VPN Gateway. This data is useful for troubleshooting, but enabling all logs will generate a large amount of data and adversely affect performance.

Since only a limited amount of log data can be stored in the Broadband VPN Gateway, log data can also be E-mailed to your PC or sent to a Syslog Server.

Log Setting

Log	Log Contents : <input type="checkbox"/> Firewall <input checked="" type="checkbox"/> Operation <input type="checkbox"/> Kernel <input checked="" type="checkbox"/> Advanced Firewall <input checked="" type="checkbox"/> SPI Detection <input type="checkbox"/> URL Log - Speed : <input style="width: 50px;" type="text" value="45"/> minute(s) <input checked="" type="checkbox"/> Delete Redundant Log
Time Zone	Time Zone : <input style="width: 100%;" type="text" value="(GMT-08:00) Pacific Time(US, Canada); Tijuana"/> <input type="checkbox"/> Time Server Set by User First Server Name/IP Address : <input style="width: 150px;" type="text"/> Second Server Name/IP Address : <input style="width: 150px;" type="text"/> Current Time : sys_time
Syslog	<input type="checkbox"/> Enable Syslog Syslog Server : <input style="width: 100%;" type="text"/> Include : <input type="checkbox"/> Firewall Log <input type="checkbox"/> VPN Log
<input type="button" value="Save"/> <input type="button" value="Cancel"/>	

Figure 38: Log Screen

Data - Log Screen

Log	
Log Contents	Select the desired option(s), if needed.
Through-put/Connection Interval	Enter the desired time for the interval.
Delete Redundant Log	If enabled, it will delete the redundant log.
Time Zone	
Time Zone	Select the correct Time Zone for your location. This is required for the date/time shown on the logs to be correct.
Time Server...	Enable or disable the Time Server feature as required.
First Server Name/IP Address	Enter the address or name for the desired Time Server.

Second Server Name/IP Address	This is optional.
System Log	
Enable System Log	If enabled, log data will be sent to your system log Server.
System Log Server	Enter the IP address of your System Log Server.
Include	Select the logs you wish to be included in the data sent to the System Log Server.

Services

Services are used in defining traffic to be blocked or allowed by the *Firewall Rules* features. Many common Services are pre-defined, but you can also define your own services if required.

To view the Services screen, select the *Services* link on the Firewall menu.

Log Setting

Log	Log Contents : <input type="checkbox"/> Firewall <input checked="" type="checkbox"/> Operation <input type="checkbox"/> Kernel <input checked="" type="checkbox"/> Advanced Firewall <input checked="" type="checkbox"/> SPI Detection <input type="checkbox"/> URL Log - Speed : <input style="width: 50px;" type="text" value="45"/> minute(s) <input checked="" type="checkbox"/> Delete Redundant Log
Time Zone	Time Zone : <input style="width: 100%;" type="text" value="(GMT-08:00) Pacific Time(US, Canada); Tijuana"/> <input type="checkbox"/> Time Server Set by User First Server Name/IP Address : <input style="width: 150px;" type="text"/> Second Server Name/IP Address : <input style="width: 150px;" type="text"/> <p style="text-align: center;">Current Time : sys_time</p>
Syslog	<input type="checkbox"/> Enable Syslog Syslog Server : <input style="width: 100%;" type="text"/> Include : <input type="checkbox"/> Firewall Log <input type="checkbox"/> VPN Log
<input type="button" value="Save"/> <input type="button" value="Cancel"/>	

Figure 39: Services Screen

Data - Services Screen

Available Services	
Available Services	This lists all defined Services.
Delete Button	Use this to delete the selected Service from the list. Note that you can only delete Services you have added; the pre-defined services can not be deleted.
Add New Service	
Name	Enter a suitable name for this Service.
Type	Select the correct type for this Service.
Start Port	If the "Type" (above) is TCP, UDP, or TCP/UDP, enter the port number for this Service. If a port range is required, enter the beginning of the range here, and the end of the range in the "Finish Port" field.
End Port	If the "Type" (above) is TCP, UDP, or TCP/UDP, this field can be used to enter the end of range of port numbers. This can be left blank

	if not required.
--	------------------

Security

This screen allows you to set Firewall and other security-related options.

Security	
Firewall Options	<input type="checkbox"/> Echo ICMP on WAN Port <input checked="" type="checkbox"/> Allow VPN Passthrough (IPsec/PPTP/L2TP)
Firewall Engine Options	Maximum connections per PC : <input style="width: 80px;" type="text" value="0"/> Maximum applications per host : <input style="width: 80px;" type="text" value="0"/> (HTTP/HTTPS/DNS excluded) SYN rate limit to <input style="width: 40px;" type="text" value="0"/> /s Network Optimize 1. Connection may be released after idle for <input style="width: 40px;" type="text" value="0"/> minute(s) 2. <input type="checkbox"/> Use optimize method when the network loading is reaching its maximum capacity. TCP Timeout: <input style="width: 40px;" type="text" value="17"/> minute(s) UDP Timeout: <input style="width: 40px;" type="text" value="17"/> minute(s)
<input type="button" value="Save"/> <input type="button" value="Cancel"/>	

Figure 40: Security Screen

Data - Security Screen

Firewall	
Echo ICMP on LAN Port	The ICMP protocol is used by the "ping" and "trace route" programs, and by network monitoring and diagnostic programs. <ul style="list-style-type: none"> If checked, the Broadband VPN Gateway will respond to ICMP packets received from the Internet. If not checked, ICMP packets from the Internet will be ignored. Disabling this option provides a slight increase in security.
Allow VPN pass-through	If enabled, PCs on the LAN can use VPN software to connect to remote clients via the Internet connection. The protocols supported are: <ul style="list-style-type: none"> IPSec IPSec protocol is used to establish a secure connection, and is widely used by VPN (Virtual Private Networking) programs. PPTP PPTP (Point to Point Tunneling Protocol) is widely used by VPN (Virtual Private Networking) programs. L2TP L2TP is a protocol developed by Cisco for VPNs (Virtual Private Networks).
MAX 3D Engine Options	
Host number in the network	Select the desired number as required.
Network used in	Select the desired internet environment as required.

Maximum Connections per PC	Enter the maximum value for the connections of each PC.
Maximum Applications per host	Enter the maximum value for the applications of each host.
Set New Connection(s) not upto:	Set the value to control the speed of the internet.
Connection Priority	There are 2 options to set the priority: <ul style="list-style-type: none">• Connection may be released after idling for - The connection is automatically disconnected when idle for the time period specified in this field.• Use QoS when the network load is reaching its maximum level - If enabled, the router will check all connections in the network.
TCP/UDP Connection time out	It is recommended not to change the default value. It will be used when the network flow is very big.

DMZ

This feature, if enabled, allows the DMZ computer or computers on your LAN to be exposed to all users on the Internet.

- This allows almost any application to be used on the "DMZ PC".
- The "DMZ PC" will receive all "Unknown" connections and data.
- If the DMZ feature is enabled, you must select the PC to be used as the "DMZ PC".

Enable	WAN IP Address	LAN IP
1. <input type="checkbox"/>	192.168.1.51	<input type="text"/>
2. <input type="checkbox"/>		<input type="text"/>

Save Cancel

Figure 41: Multi-DMZ

To use this feature:

- **Enable** this DMZ.
- The **WAN IP address** field displays the IP address allocated to you by your ISP.
- Enter the **Corresponding IP** to be the DMZ PC for traffic sent to this IP address.

If you have multiple Internet IP addresses, you can assign one DMZ PC for each Internet IP address.

If you only have 1 WAN IP address, only "DMZ 1" can be used, and only one (1) PC can be the DMZ PC. The current WAN IP address is displayed. If this address is assigned upon connection, and no connection currently exists, then this address will be blank or 0.0.0.0.



The "DMZ PC" is effectively outside the Firewall, making it more vulnerable to attacks. For this reason, you should only enable the DMZ feature when required.

E-Mail

E-Mail

E-Mail Alert	<input type="checkbox"/> Send E-Mail alert immediately under attack <input type="checkbox"/> Send E-Mail alert when certain application reaches 90% of its limited capacity (except for HTTP/HTTPS/DNS) <input type="checkbox"/> Send E-Mail alert when a PC's connections reach 90% of its limitation
E-Mail Log	<input type="checkbox"/> Use E-Mail to send log Include : <input type="checkbox"/> VPN Log <input type="checkbox"/> Syslog <input type="checkbox"/> Network Analysis Send : <input checked="" type="radio"/> When the log is full <input type="radio"/> Every Sunday at 1 AM
	E-mail Address : <input type="text"/> Subject : <input type="text" value="Logs"/> SMTP Server : <input checked="" type="radio"/> Domain Name : <input type="text"/> <input type="radio"/> IP Address : <input type="text"/> User Name : <input type="text"/> Password : <input type="password"/> Port Number : <input type="text" value="25"/> (Exclude 25) <input type="checkbox"/> Respond to Ident
<input type="button" value="Save"/> <input type="button" value="Cancel"/>	

Figure 42: E-Mail Screen

Data - E-Mail Screen

E-Mail Alert	
Send E-Mail alert	If enabled, an E-Mail will be sent immediately if a DoS (Denial of Service) attack is detected. If enabled, the E-mail address information must be provided.
Send E-Mail alert...	If enabled, an E-Mail will be sent immediately if an application reaches 90% of its limited capacity.
Send E-Mail alert...	If enabled, an E-Mail will be sent immediately if the PC's connection reaches 90% of its limitation.
E-Mail Log	
Use E-Mail to send log	If enabled, logs will be logs to the specified E-mail address. You need to select the Logs to be E-mailed, and complete the E-mail address settings on this screen.
Include	Select the log items to be included in the E-mail.

Send	<p>Select the desired option for sending the log by E-mail.</p> <ul style="list-style-type: none"> • When the log is full - The time is not fixed. The log will be sent when the log is full, which will depend on the volume of traffic. • Every day, Every Monday... - The log is sent on the interval specified. <ul style="list-style-type: none"> • If "Every day" is selected, the log is sent at the time specified. • If the day is specified, the log is sent once per week, on the specified day. • Select the time of day you wish the E-mail to be sent. • If the log is full before the time specified to send it, it will be sent regardless.
E-mail Address	Enter the E-mail address the Log is to be sent to. The E-mail will also show this address as the Sender's address.
Subject	Enter the text string to be shown in the "Subject" field for the E-mail.
SMTP Server	Enter the domain name or IP address of the SMTP (Simple Mail Transport Protocol) Server you use for outgoing E-mail.
User Name	Enter the user name for the E-mail account.
Password	Enter the password for the E-mail account.
Port Number	Enter the port number used to connect to the SMTP Server. The default value is 25.
E-Mail Test Button	Click this button to send a test E-Mail to the above E-Mail address.

Chapter 8

VPN (IPSec)



This Chapter describes the VPN capabilities and configuration required for common situations.

Overview

This section describes the VPN (Virtual Private Network) support provided by your Broadband VPN Gateway.

A VPN (Virtual Private Network) provides a secure connection between 2 points, over an insecure network - typically the Internet. This secure connection is called a **VPN Tunnel**.

There are many standards and protocols for VPNs. The standard implemented in the Broadband VPN Gateway is **IPSec**.

IPSec

IPSec is a near-ubiquitous VPN security standard, designed for use with TCP/IP networks. It works at the packet level, and authenticates and encrypts all packets traveling over the VPN Tunnel. Thus, it does not matter what applications are used on your PC. Any application can use the VPN like any other network connection.

IPsec VPNs exchange information through logical connections called **SAs** (Security Associations). An SA is simply a definition of the protocols, algorithms and keys used between the two VPN devices (endpoints).

Each IPsec VPN has two SAs - one in each direction. If **IKE** (Internet Key Exchange) is used to generate and exchange keys, there are also SA's for the IKE connection as well as the IPsec connection.

There are two security modes possible with IPSec:

- **Transport Mode** - the payload (data) part of the packet is encapsulated through encryption but the IP header remains in the clear (unchanged).

The Broadband VPN Gateway does NOT support Transport Mode.

- **Tunnel Mode** - everything is encapsulated, including the original IP header, and a new IP header is generated. Only the new header in the clear (i.e. not protected). This system provides enhanced security.

The Broadband VPN Gateway always uses Tunnel Mode.

IKE

IKE (Internet Key Exchange) is an optional, but widely used, component of IPsec. IKE provides a method of negotiating and generating the keys and IDs required by IPsec. If using IKE, only a single key is required to be provided during configuration. Also, IKE supports using **Certificates** (provided by CAs - Certification Authorities) to authenticate the identify of the remote user or gateway.

If IKE is NOT used, then all keys and IDs (SPIs) must be entered manually, and Certificates can NOT be used. This is called a "Manual Key Exchange".

When using IKE, there are 2 phases to establishing the VPN tunnel:

- **Phase I** is the negotiation and establishment up of the IKE connection.
- **Phase II** is the negotiation and establishment up of the IPsec connection.

Because the IKE and IPsec connections are separate, they have different SAs (security associations).

Policies

VPN configuration settings are stored in **Policies**.

Note that different vendors use different terms. Generally, the terms "VPN Policy", "IPSec Policy", and "IPSec Proposal" have the same meaning. However, some vendors separate IKE Policies (Phase 1 parameters) from IPSec Policies (Phase 2 parameters).

For the Broadband VPN Gateway; each VPN policy contains both Phase 1 and Phase 2 parameters (if IKE is used). Each policy defines:

- The address of the remote VPN endpoint
- The traffic which is allowed to use the VPN connection.
- The parameters (settings) for the IPsec SA (Security Association)
- If IKE is used, the parameters (settings) for the IKE SA (Security Association)

Generally, you will need at least one (1) VPN Policy for each remote site for which you wish to establish VPN connections.

It is possible, and sometimes necessary, to have multiple Policies for the same remote site. However, you should only Enable one (1) policy at a time. If multiple policies for the same remote site are enabled, the policies are examined in the order in which they are listed, and the first matching policy will be used. While it is possible to change the order of the policies, it may not be easy to get the desired action from multiple policies.

VPN Configuration

The general rule is that each endpoint must have matching Policies, as follows:

VPN Endpoint address	Each VPN endpoint must be configured to initiate or accept connections to the remote VPN client or Gateway. Usually, this requires having a fixed Internet IP address. However, it is possible for a VPN Gateway to accept incoming connections from a remote client where the client's IP address is not known in advance.
Traffic Selector	This determines which outgoing traffic will cause a VPN connection to be established, and which incoming traffic will be accepted. Each endpoint must be configured to pass and accept the desired traffic from the remote endpoint. If connecting 2 LANs, this requires that: <ul style="list-style-type: none"> • Each endpoint must be aware of the IP addresses used on the other endpoint. • The 2 LANs MUST use different IP address ranges.
IKE parameters	If using IKE (recommended), the IKE parameters must match (except for the SA lifetime, which can be different).
IPsec parameters	The IPsec parameters at each endpoint must match.

Common VPN Situations

VPN Pass-through

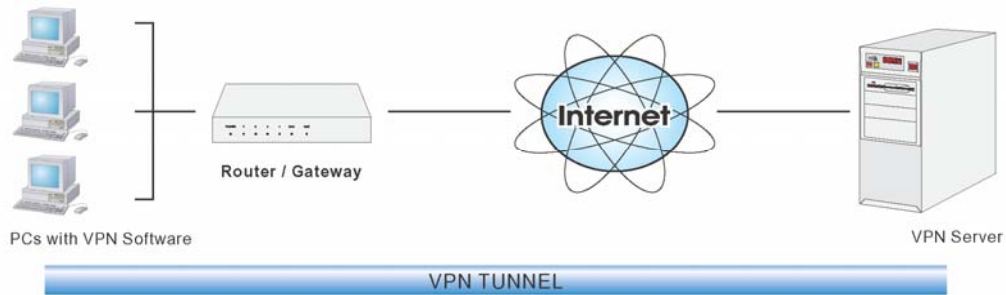

Figure 43: VPN Pass-through

Here, a PC on the LAN behind the Router/Gateway is using VPN software, but the Router/Gateway is NOT acting as a VPN endpoint. It is only allowing the VPN connection.

- The PC software can use any VPN protocol supported by the remote VPN.
- The remote VPN Server must support client PCs which are behind a NAT router, and so have an IP address which is not valid on the Internet.
- The Router/Gateway requires no VPN configuration, since it is not acting as a VPN endpoint.

Client PC to VPN Gateway

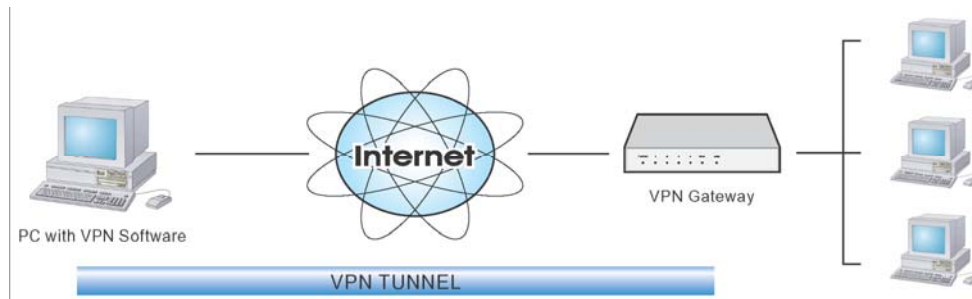

Figure 44: Client PC to VPN Server

In this situation, the PC must run appropriate VPN client software in order to connect, via the Internet, to the Broadband VPN Gateway. Once connected, the client PC has the same access to LAN resources as PCs on the local LAN (unless restricted by the network administrator).

- IPsec is not the only protocol which can be used in this situation, but the Broadband VPN Gateway supports IPsec ONLY.
- Windows 2000 and Windows XP include a suitable IPsec VPN client program. Configuration of this client program for use with the Broadband VPN Gateway is covered later in this document.

Connecting 2 LANs via VPN

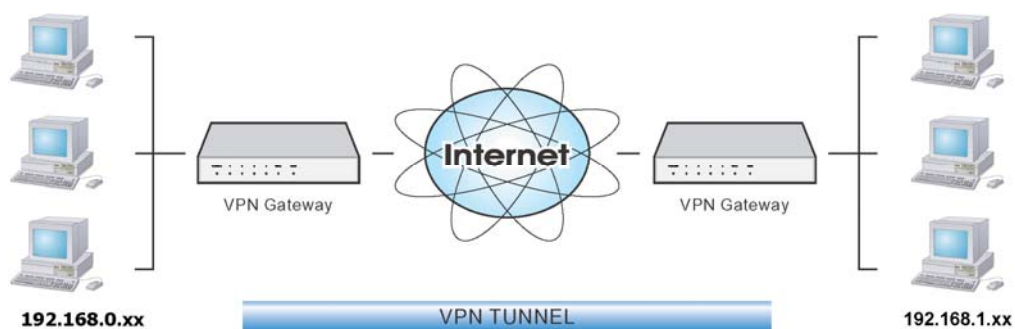

Figure 45: Connecting 2 VPN Gateways

This allows two (2) LANs to be connected. PCs on each endpoint gain secure access to the remote LAN.

- The 2 LANs MUST use different IP address ranges.
- The VPN Policies at each end determine when a VPN tunnel will be established, and what systems on the remote LAN can be accessed once the VPN connection is established.
- It is possible to have simultaneous VPN connections to many remote sites.

VPN Configuration

This section covers the configuration required on the Broadband VPN Gateway when using Manual Key Exchange (Manual Policies) or IKE (Automatic Policies).

Details of using Certificates are covered in a later section.

Policies Screen

To view this screen, select **Policies** from the VPN menu. This screen lists all existing VPN policies. If no policies exist, the list will be empty.

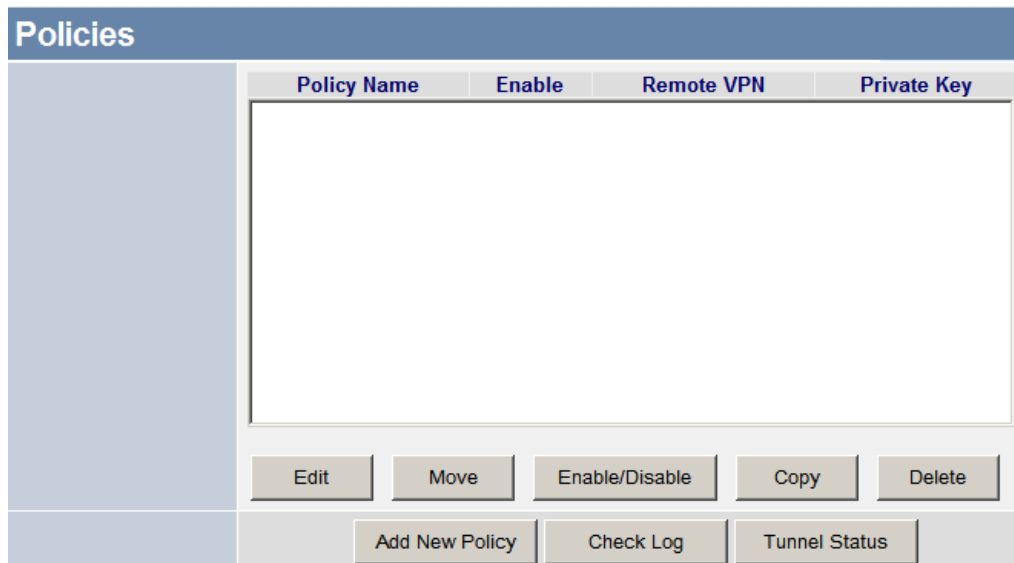

Figure 46: Policies Screen

Note that the order of policies is important if you have more than one policy for a particular site. In that case, the first matching policy (for the traffic under consideration) will be used.

Data - Policies Screen

VPN List	
Policy Name	The name of the policy. When creating a policy, you should select a suitable name.
Enable	This indicates whether or not the policy is currently enabled. Use the "Enable/Disable" button to toggle the state of the selected policy.
Remote VPN	The IP address of the remote VPN endpoint (Gateway or client).
Private Key	This will indicate "Manual" (manual key exchange) or "IKE" (Internet Key Exchange)
Operations	
Add New Policy	To add a new policy, click the "Add" button. See the following section for details.
Edit	To Edit or modify an existing policy, select it and click the "Edit" button.

Move	<p>The order in which policies are listed is only important if you have multiple policies for the same remote site. In that case, the first matching policy is used. There are 2 ways to change the order of policies:</p> <ul style="list-style-type: none"> • Use the up and down indicators on the right to move the selected row. You must confirm your changes by clicking "OK". If you change your mind before clicking "OK", click "Cancel" to reverse your changes. • Click "Move" to directly specify a new location for the selected policy.
Enable/Disable	Use this to toggle the On/Off state of the selected policy.
Copy	<p>If you wish to create a policy which is similar to an existing policy, select the policy and click the "Copy" button.</p> <p>Remember that the new policy must have a different name, and there can only be one active (enabled) policy for each remote VPN endpoint.</p>
Delete	To delete an existing policy, select it and click the "Delete" button.
Check Log	Clicking the "Check Log" button will open a new window and display the VPN log.

Adding a New Policy

To create a new VPN Policy, click the *Add New Policy* button on the ***Policies*** screen.

VPN Policy Definition

Name: Enable Policy
 Allow NetBIOS traffic

Remote VPN endpoint Dynamic IP
 Fixed IP:
 Domain Name:

Local IP addresses

Type: IP address: ~
Subnet Mask:

Remote IP addresses

Type: IP address: ~
Subnet Mask:

Authentication & Encryption

AH Authentication
 ESP Encryption Key Size: (AES only)
 ESP Authentication

Manual Key Exchange

IKE (Internet Key Exchange)

Direction:

Local Identity: IP address
 Name:

Remote Identity: IP address
 Name:

Authentication: RSA Signature (requires certificate)
 Pre-shared Key

Authentication Algorithm:

Encryption: Key Size: (AES only)

Exchange Mode:

IKE SA Life Time: (secs)

IKE Keep Alive Ping IP Address:

IPSec SA Life Time: (secs)

DH Group:
IKE PFS:
IPSec PFS:

Figure 47: VPN Wizard - Start Screen

General Settings	
Policy Name	Enter a suitable name. This name is not supplied to the remote VPN. It is used only to help you manage the policies.
Enable Policy	Enable or disable the policy as required. For each remote VPN, only 1 policy can be enabled at any time.
Allow NetBIOS Transmission	Select the desired option if you require NetBIOS traffic to be transferred through the VPN tunnel. NetBIOS is used by Microsoft (Windows) networking. This setting should not be enabled unless necessary, because it increases traffic volume.
Bundle WAN Port	Select the desired WAN port as required.
Remote VPN	<p>The Internet IP address of the remote VPN endpoint (Gateway or client).</p> <ul style="list-style-type: none"> • Dynamic IP. Select this if the Internet IP address is unknown. In this case, only incoming connections are possible. • Fixed IP. Select this if the remote endpoint has a fixed Internet IP address. If selected, enter the Internet IP address of the remote endpoint. • Domain Name. Select this if the remote endpoint has a Domain Name associated with it. If selected, enter the Domain Name of the remote endpoint.
Local IP Address	<ul style="list-style-type: none"> • Any - no additional data is required. Any IP address is acceptable. <ul style="list-style-type: none"> • For outgoing connections, this allows any PC on the LAN to use the VPN tunnel. • For incoming connections, this allows any PC using the remote endpoint to access any PC on your LAN. • Single address - enter an IP address in the "IP address" field. • Range address - enter the starting IP address in the "IP address" field, and the finish IP address in the "Finish IP address" field. • Subnet address - enter the desired IP address in the "IP address" field, and the network mask in the "Subnet Mask" field. <p>The remote VPN must have these IP addresses entered as it's "Remote" addresses.</p>
Remote IP Address	<ul style="list-style-type: none"> • Single address - enter an IP address in the "IP address" field. • Range address - enter the starting IP address in the "IP address" field, and the finish IP address in the "Finish IP address" field. • Subnet address - enter the desired IP address in the "IP address" field, and the network mask in the "Subnet Mask" field. <p>The remote VPN should have these IP addresses entered as it's "Local" addresses.</p>
Authentication and Encryption	
AH Authentication	AH (Authentication Header) specifies the authentication protocol for the VPN header, if used. (AH is often NOT used)

ESP Encryption	<p>ESP (Encapsulating Security Payload) provides security for the payload (data) sent through the VPN tunnel. Generally, you will want to enable both Encryption and Authentication.</p> <p>Authentication Algorithm</p> <ul style="list-style-type: none"> • The 3DES algorithm provides greater security than DES, but is slower. • If using AES, you must select the <i>Key Size</i>. If using DES or 3DES, this field is ignored.
ESP Authentication	<p>Generally, you should enable ESP Authentication. There is little difference between the available algorithms. Just ensure each endpoint use the same setting.</p>
Manual Key Encryption	
AH Authentication	<p>AH (Authentication Header) specifies the authentication protocol for the VPN header, if used. (AH is often NOT used)</p> <p>If AH is not enabled, the following settings can be ignored.</p> <p>Keys</p> <ul style="list-style-type: none"> • The "in" key here must match the "out" key on the remote VPN, and the "out" key here must match the "in" key on the remote VPN. • Keys can be in ASCII or Hex (0..9 A..F) • For MD5, the keys should be 32 hex/16 ASCII characters. • For SHA-1, the keys should be 40 hex/20 ASCII characters. <p>SPI</p> <ul style="list-style-type: none"> • Each SPI (Security Parameter Index) must be unique. • The "in" SPI here must match the "out" SPI on the remote VPN, and the "out" SPI here must match the "in" SPI on the remote VPN. • Each SPI should be at least 3 characters.
ESP Encryption	<p>ESP (Encapsulating Security Payload) provides security for the payload (data) sent through the VPN tunnel. Generally, you will want to enable both Encryption and Authentication.</p> <p>Key - In / Key - Out</p> <ul style="list-style-type: none"> • The "In" key here must match the "Out" key on the remote VPN, and the "Out" key here must match the "In" key on the remote VPN. • For DES, keys should be 8 ASCII characters (16 HEX chars). • For 3DES, keys should be 24 ASCII characters (48 HEX chars). • If using AES encryption, the key input size must match the <i>Key Size</i> selected above.

ESP Authentication	<p>Generally, you should enable ESP Authentication. There is little difference between the available algorithms. Just ensure each endpoint use the same setting.</p> <ul style="list-style-type: none"> • The "In" key here must match the "Out" key on the remote VPN, and the "Out" key here must match the "In" key on the remote VPN. • Keys can be in ASCII or Hex (0 ~ 9 and A ~ F) • For MD5, the keys should be 32 hex/16 ASCII characters. • For SHA-1, the keys should be 40 hex/20 ASCII characters.
ESP SPI	<p>This is required if either ESP Encryption or ESP Authentication is enabled.</p> <ul style="list-style-type: none"> • Each SPI (Security Parameter Index) must be unique. • The "in" SPI here must match the "out" SPI on the remote VPN, and the "out" SPI here must match the "in" SPI on the remote VPN. • Each SPI should be at least 3 characters.
IKE (Internet Key Exchange)	
Direction	<p>Select the desired option:</p> <ul style="list-style-type: none"> • Initiator - Only outgoing connections will be created. Incoming connection attempts will be rejected. • Responder - Only incoming connections will be accepted. Outgoing traffic which would otherwise result in a connection will be ignored. • Both Directions - Both incoming and outgoing connections are allowed.
Local ID Type	<p>This setting must match the "Remote ID Type" on the remote VPN. Select the desired option, and enter the required data in the "Local Identity Data" field.</p> <ul style="list-style-type: none"> • WAN IP Address - This is the most common method. If selected, no input is required. • Fully Qualified Domain Name - enter the Domain Name assigned to this device. • Fully Qualified User name - This name does not have to a valid Internet Domain Name. E-mail addresses are often used for this entry. • DER ANS.1 DN - This must be a DER ANS.1 Domain Name.
Remote ID Type	<p>This setting must match the "Local ID Type" on the remote VPN. Select the desired option, and enter the required data in the "Remote ID Data" field.</p> <ul style="list-style-type: none"> • Remote WAN IP - This is the most common method. If selected, no input is required. • Fully Qualified Domain Name - enter the Domain Name assigned to this device. • Fully Qualified User name - This name does not have to a valid Internet Domain Name. E-mail addresses are often used for this entry. • DER ANS.1 DN - This must be a DER ANS.1 Domain Name.

Authentication	<ul style="list-style-type: none"> • RSA Signature requires that both VPN endpoints have valid Certificates issued by a CA (Certification Authority). • For Pre-shared key, enter the same key value in both endpoints. The key should be at least 8 characters (maximum is 128 characters). Note that this key is used for the IKE SA only. The keys used for the IPsec SA are automatically generated.
Encryption	<p>Select the desired method, and ensure the remote VPN endpoint uses the same method.</p> <ul style="list-style-type: none"> • The 3DES algorithm provides greater security than DES, but is slower. • If using AES, you must select the <i>Authentication Algorithm</i>. If using DES or 3DES, this field is ignored.
Exchange Mode	<p>Select the desired option, and ensure the remote VPN endpoint uses the same mode.</p> <ul style="list-style-type: none"> • <i>Main Mode</i> provides identity protection for the hosts initiating the IPsec session, but takes slightly longer to complete. • <i>Aggressive Mode</i> provides no identity protection, but is quicker.
IKE SA Aggressive Mode	<p>This setting does not have to match the remote VPN endpoint; the shorter time will be used. Although measured in seconds, it is common to use time periods of several hours, such 28,800 seconds.</p>
DH Group	<p>Select the desired method, and ensure the remote VPN endpoint uses the same method. The smaller bit size is slightly faster.</p>
IKE PFS	<p>If enabled, PFS (Perfect Forward Security) enhances security by changing the IPsec key at regular intervals, and ensuring that each key has no relationship to the previous key. Thus, breaking 1 key will not assist in breaking the next key.</p> <p>This setting should match the remote endpoint.</p>
IPsec PFS	<p>Select the desired option from the drop-down list.</p>

VPN Examples

This section describes some examples of using the Broadband VPN Gateway in common VPN situations.

Example 1: Connecting 2 Broadband VPN Gateways

In this example, 2 LANs are connected via VPN.

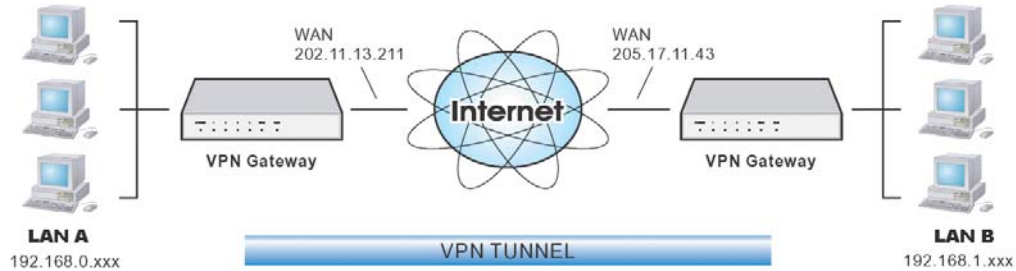

Figure 48: Connecting 2 Broadband VPN Gateways

Note

- The LANs MUST use different IP address ranges.
- Both endpoints have fixed WAN (Internet) IP addresses.

Configuration Settings

Setting	LAN A Gate-way	LAN B Gate-way	Notes
Name	Policy 1	Policy 1	Name does not affect operation. Select a meaningful name.
Remote Endpoint	205.17.11.43	202.11.13.211	Other endpoint's WAN (Internet) IP address.
Local IP addresses	Any	Any	Use a more restrictive definition if possible.
Remote IP addresses	192.168.1.1 to 192.168.1.254	192.168.0.1 to 192.168.0.254	Address range on other endpoint. Use a more restrictive definition if possible.
Key Exchange	IKE	IKE	Must match

IKE SA Parameters

IKE Direction	Both ways	Both ways	Does not have to match. Either endpoint can block 1 direction.
Local Identity	IP address	IP address	IP address is the most common ID method
Remote Identity	IP address	IP address	IP address is the most common ID method
IKE Authentication method	Pre-shared Key	Pre-shared Key	Certificates are not widely used.
Pre-shared Key	XXXXXXXXXX	XXXXXXXXXX	Must match

IKE Authentication algorithm	MD5	MD5	Must match
IKE Encryption	DES	DES	Must match
IKE Exchange mode	Main Mode	Main Mode	Must match
DH Group	Group 1 (768 bit)	Group 1 (768 bit)	Must match
IKE SA Life time	28800	28800	Does not have to match. Shorter period will be used.
IKE PFS	Disable	Disable	Must match
IPSec SA Parameters			
IPSec SA Life time	28800	28800	Does not have to match. Shorter period will be used.
IPSec PFS	Disabled	Disabled	Must match
AH authentication	Disabled	Disabled	AH is rarely used
ESP authentication	Enable/MD5	Enable/MD5	Must match
ESP encryption	Enable/DES	Enable/DES	Must match

Example 2: Windows 2000/XP Client to LAN

In this example, a Windows 2000/XP client connects to the Broadband VPN Gateway and gains access to the local LAN.

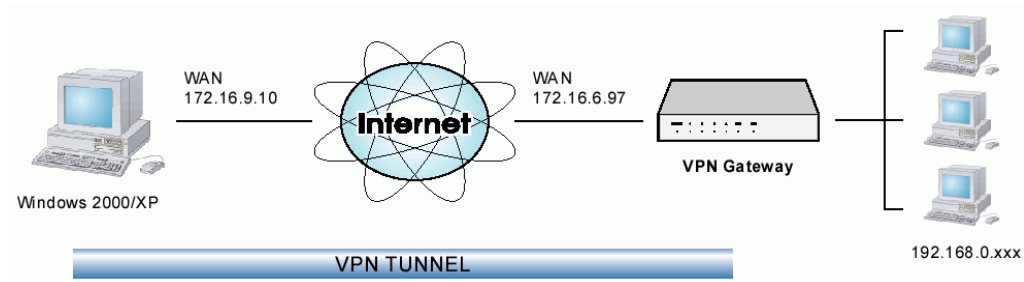

Figure 49: Windows 2000/XP Client to Broadband VPN Gateway



To use 3DES encryption on Windows 2000, you need Service Pack 3 or later installed.

Broadband VPN Gateway Configuration

Setting	Value	Notes
Name	Win Client	Name does not affect operation. Select a meaningful name.
Remote Endpoint	172.16.9.10	Other endpoint's WAN (Internet) IP address.
Local IP addresses	Subnet address: 192.168.0.0 255.255.255.0	Allows access to entire LAN. Use a more restrictive definition if possible.
Remote IP addresses	172.16.9.10	For a single client, this address is the same as the endpoint address.
Key Exchange	IKE	Must match client PC
IKE SA Parameters		
IKE Direction	Both ways	Using "Responder only" is not possible.
Local Identity	IP address	Required.
Remote Identity	IP address	Required
IKE Authentication method	Pre-shared Key	Certificates are not widely used.
Pre-shared Key	XXXXXXXXXX	Must match client PC
IKE Authentication algorithm	SHA-1	Must match client PC
IKE Encryption	3DES	Must match client PC
IKE Exchange mode	Main Mode	Windows 2000 only supports Main Mode.
DH Group	Group 1 (768 bit)	Must match client PC
IKE SA Life time	28800	Does not have to match client PC. Shorter

		period will be used.
IKE PFS	Disable	Must match client PC
IPSec SA Parameters		
IPSec SA Life time	28800	Do not have to match. Shorter period will be used.
IPSec PFS	Disable	Must match client PC
AH authentication	Disabled	AH is rarely used
ESP authentication	Enable/MD5	Must match client PC
ESP encryption	Enable/DES	Must match client PC

Windows Client Configuration

1. Select *Start - Programs - Administrative Tools - Local Security Policy*.
2. Right click *IP Security Policy on Local Machine* and select *Create IP Security Policy*

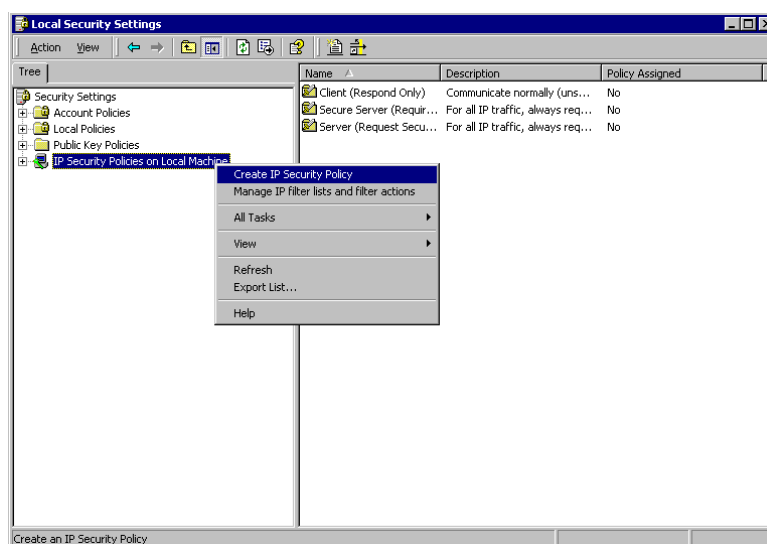

Figure 50: Windows 2000/XP - Local Security Settings

3. Click "Next", then enter a policy name, for example "DUT To Win2K", then click "Next".
4. Step through the Wizard:
 - Deselect *Activate the default response rule*. Click "Next",
 - Leave *Edit Properties* checked. Click "Finish".
5. The following "Properties - Rules" screen will be displayed.

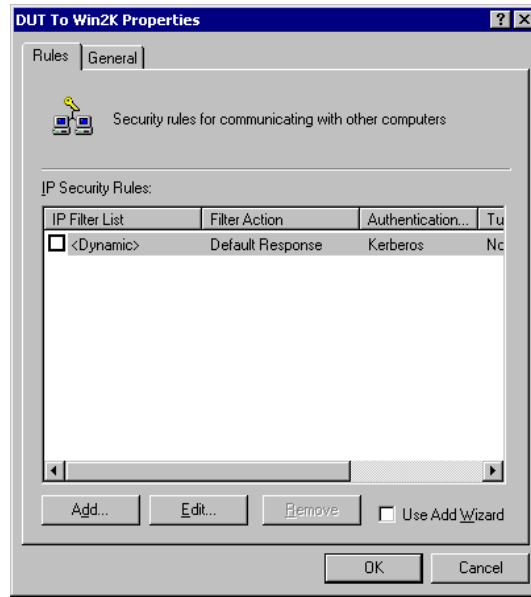

Figure 51: Windows 2000/XP - Policy Properties

- Note that no rules are in use. Two 2 rules are required - incoming and outgoing.
 - The outgoing rule will be added first.
6. Deselect the "Use Add Wizard" checkbox, then click "Add" to view the screen below.

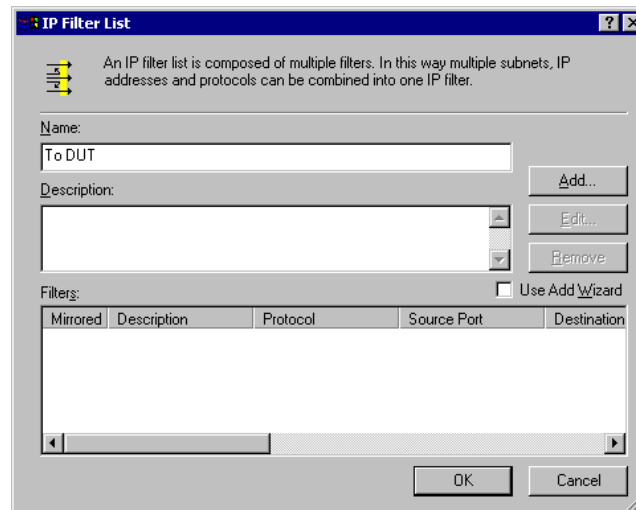

Figure 52: IP Filter List

7. Type "To DUT" for the name, then click "Add" to see a screen like the following.

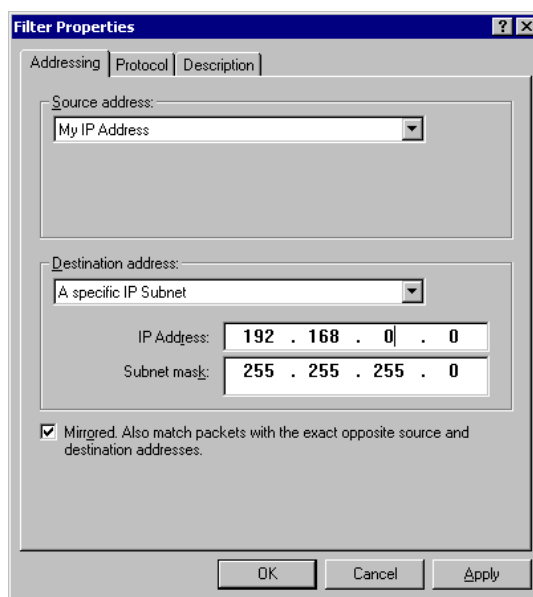

Figure 53: Filter Properties: Addressing

8. Enter the *Source IP address* and the *Destination IP address*.
 - Since this is the outgoing filter, the *Source IP address* is "My IP address" and the *Destination IP address* is the address range used on the remote LAN.
 - Ensure the *Mirrored* option is checked.
9. Click "OK" to save your settings and close this dialog.

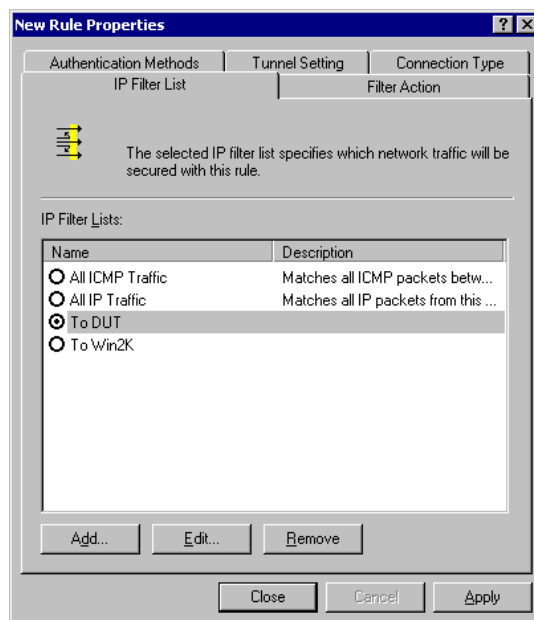

Figure 54: New Rule Properties: IP Filter List

10. On the resulting screen (above), ensure the "To DUT" filter is selected, then click the *Filter Action* tab to see a screen like the following

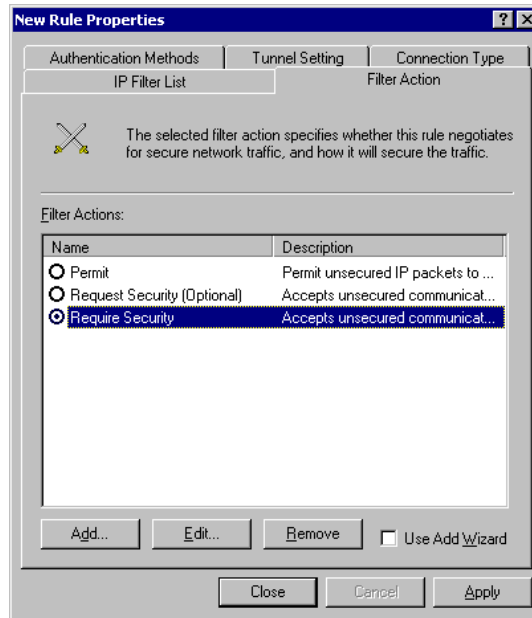

Figure 55: New Rule Properties: Filter Action

11. Select *Require Security*, then click the "Edit" button, to view the *Require Security Properties* screen.

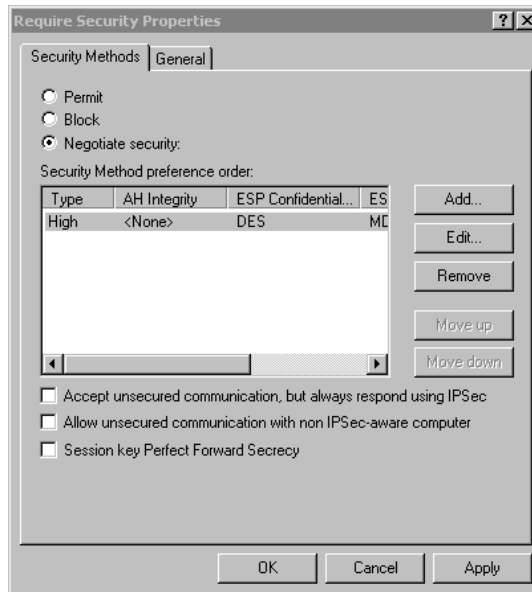

Figure 56: Require Security Properties

12. Select *Negotiate security* (this selects IKE), then click "Add".

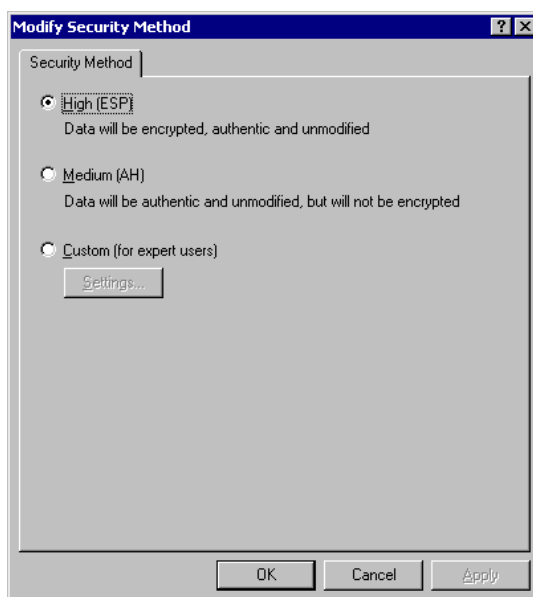

Figure 57: Modify Security Method

13. On the resulting screen (above), select *High [ESP]* then click "OK" to save your changes and return to the *Require Security Properties* screen.

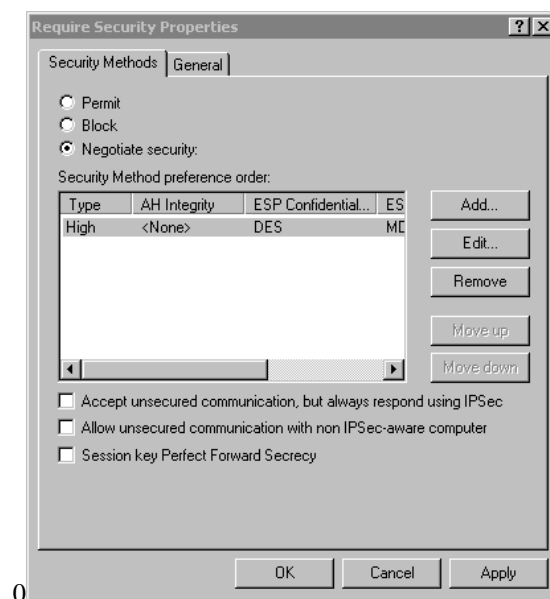

Figure 58: Require Security Properties

14. Ensure the following settings are correct, then click "OK" to return to the *Filter Action* tab of the *Edit Rule Properties* screen.

VPN Setting	Windows Setting
IKE enabled	Negotiate security
AH disabled	AH Integrity: <None>
ESP encryption: Enable/DES	ESP Confidentiality: DES
ESP authentication: Enable/MD5	ESP Integrity: MD5

15. Click the *Tunnel Setting* tab, then select *The tunnel endpoint is specified by this IP address*. Enter the WAN (Internet) IP address of the Broadband VPN Gateway, as shown below.

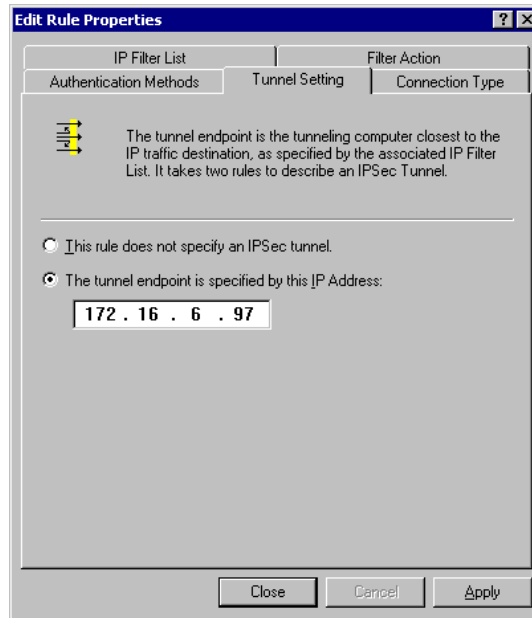

Figure 59: Tunnel Setting

16. Click the *Authentication Methods* tab, then click the "Edit" to see the screen like the example below.

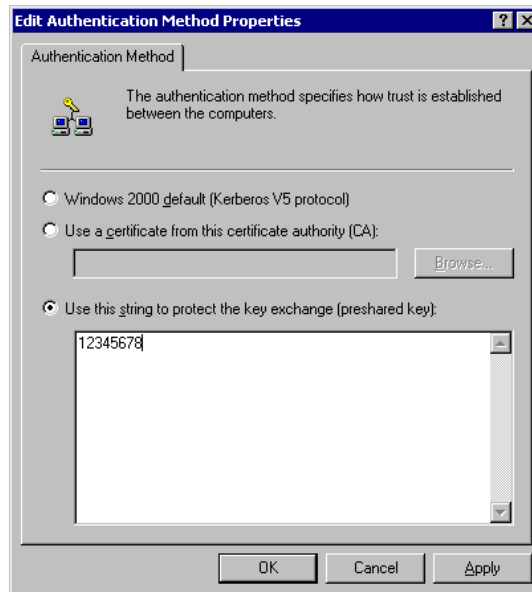

Figure 60: Authentication Method

17. Select *Use this string to protect the key exchange (preshared key)*, then enter your preshared key in the field provided.
18. Click "OK" to save your changes and return to the *Authentication Methods* tab of the *Edit Rule Properties* screen.
19. Click "Close" to return to the *DUT to Win2K properties* screen. The "To DUT" filter should now be listed, as shown below.

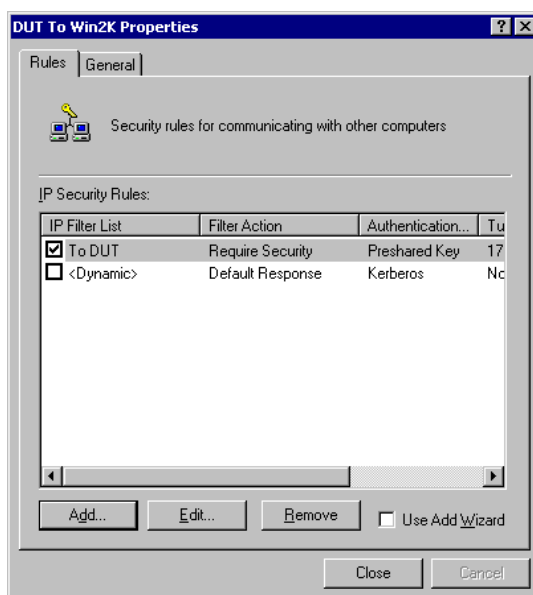

Figure 61: Windows 2000/XP Client to Broadband VPN Gateway

20. To add the second (incoming) rule, click "Add". For the name, enter "To Win2K", then click "Add".

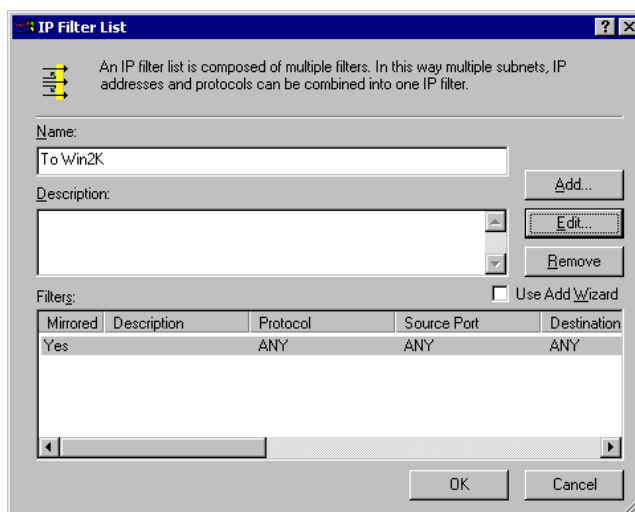

Figure 62: Windows 2000/XP Client to Broadband VPN Gateway

21. Enter the *Source IP address* and the *Destination IP address* as shown below.

- Since this is the incoming filter, the *Source IP address* is the address range used on the remote LAN and the *Destination IP address* is "My IP address".
- Ensure the *Mirrored* option is checked.

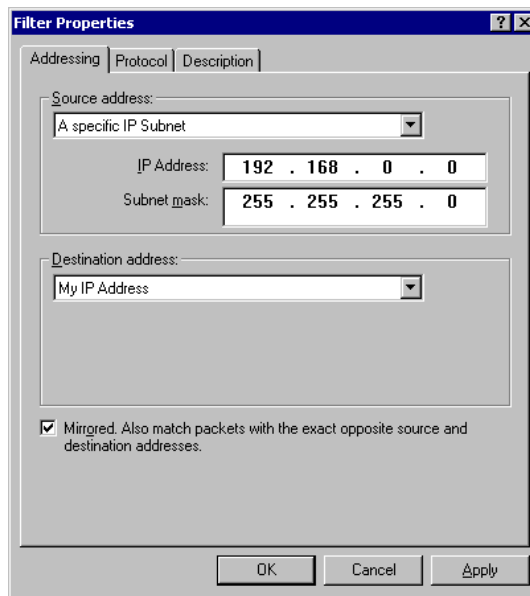

Figure 63: Filter Properties: Addressing

22. Click "OK" to save your changes, then "Close".

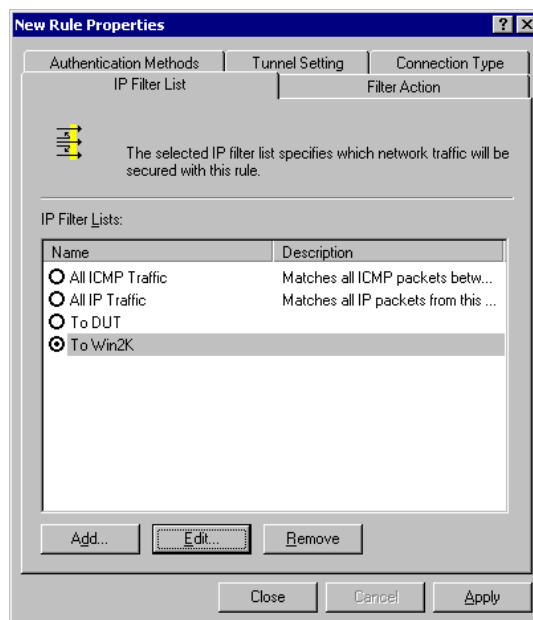

Figure 64: Filter List

23. Ensure the "To Win2K" filter is selected, then click the *Filter Action* tab.

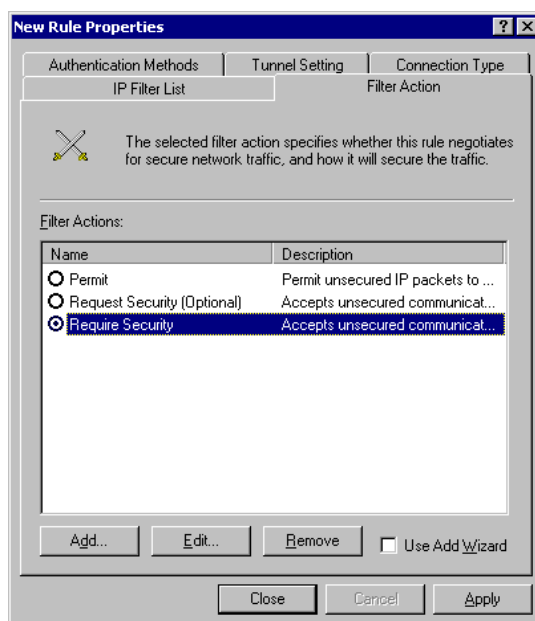

Figure 65: Filter Action

24. Select *Require Security*, then click "Edit". On the *Require Security Methods* screen below, select *Negotiate security*.

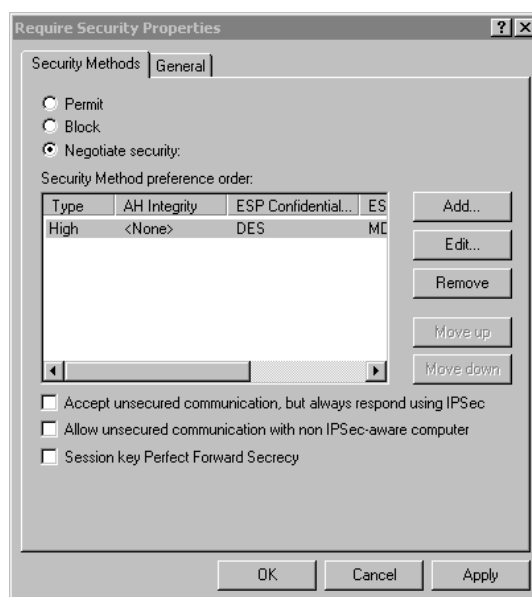

Figure 66: Security Methods

25. Click the "Add" button. On the resulting *Modify Security Method* screen below, select *High [ESP]*.

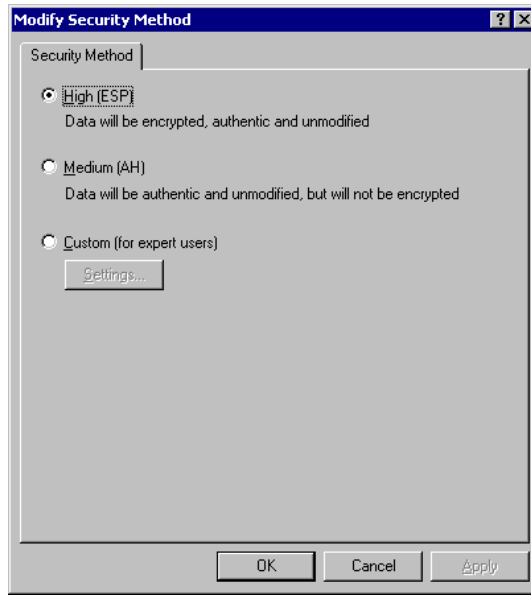

Figure 67: Modify Security Method

26. Click "OK" to save your changes, then click "OK" again to return to the Filter Action screen.
27. Select the *Tunnel Setting* tab, and enter the WAN (Internet) IP address of this PC (172.16.9.10 in this example).

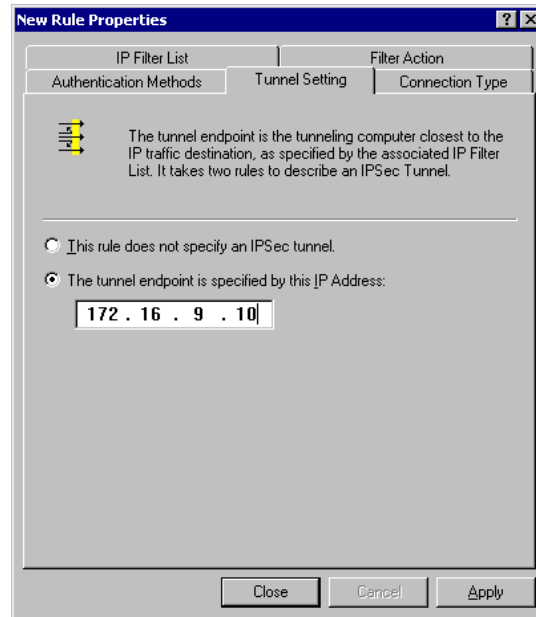

Figure 68: Tunnel Setting

28. Select the *Authentication Methods* tab, and click the "Edit" button to see the screen below.

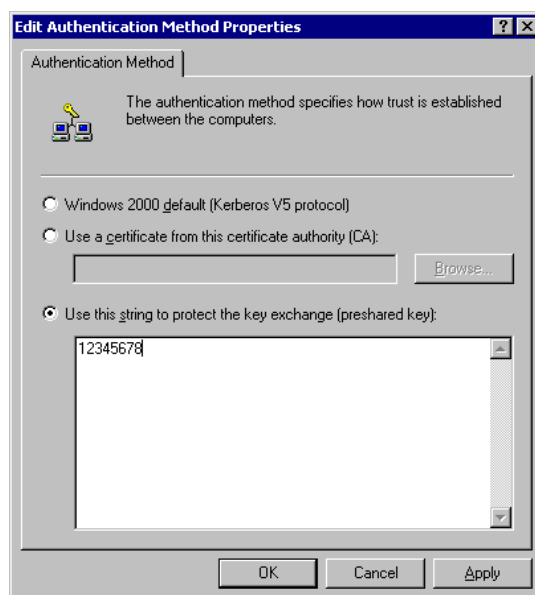

Figure 69: Authentication Method

29. Select *Use this string to protect the key exchange (preshared key)*, then enter your preshared key in the field provided.
30. Click "OK" to save your settings, then "Close" to return to the *DUT to Win2K Properties* screen. There should now be 2 IP Filers listed, as shown below.

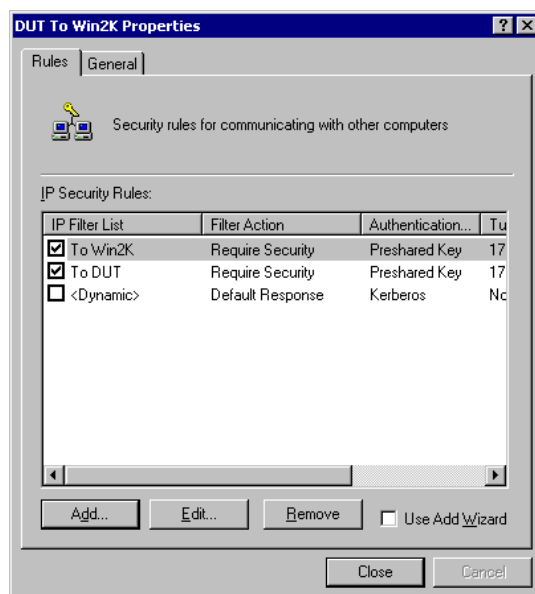

Figure 70: DUT to Win2K Properties

31. Select the *General* tab.

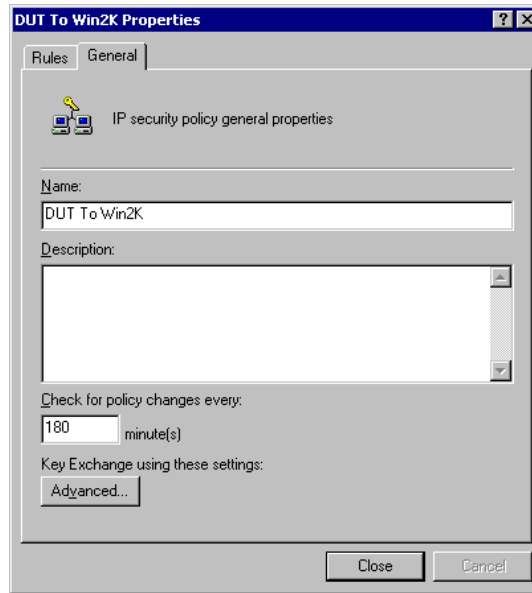

Figure 71: Properties - General Tab

32. Click the "Advanced" button to see the screen below.

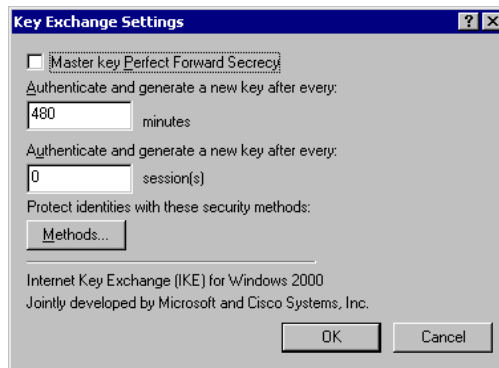

Figure 72: Key Exchange Settings

33. Click the "Methods" button to see the screen below.

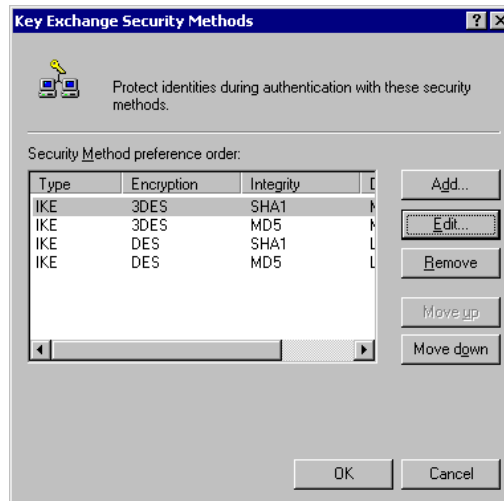

Figure 73: Key Exchange Security Methods

34. Select the first entry, and click the "Edit" button to see the following screen.

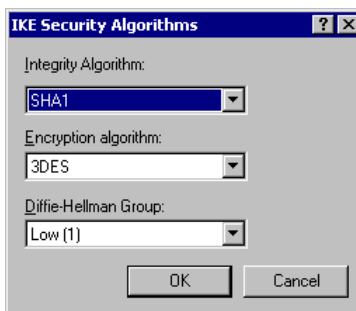

Figure 74: IKE Security Algorithms

35. Select "SHA1" for *Integrity Algorithm*, "3DES" for *Encryption algorithm*, and "Low(1)" for the *Diffie-Hellman Group*.

36. Click "OK" to save, then "OK" again, and then "Close" to return to the *Local Security Settings* screen.

37. Right click the *DUT to Win2K Policy* and select "Assign" to make your policy active.

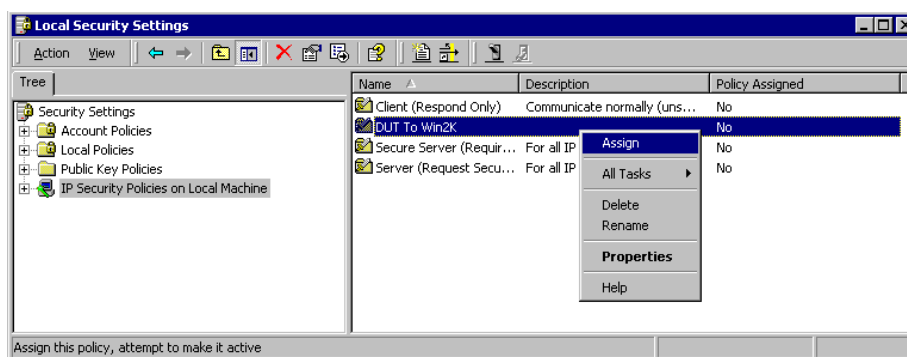

Figure 75: Windows 2000/XP Client to Broadband VPN Gateway

Configuration is now complete.

Example 3: Windows 2000 Server to VPN Gateway

In this example, a Windows 2000 Server connects to the Broadband VPN Gateway. Users on each LAN can then gain access to the remote LAN.

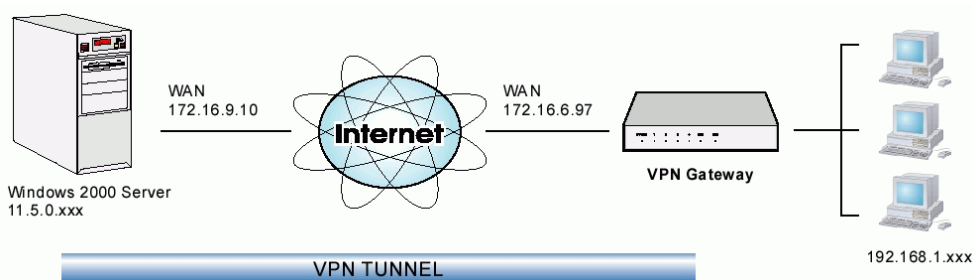

Figure 76: Broadband VPN Gateway to Windows 2000 Server

Broadband VPN Gateway Configuration

This is the same as for the client setup earlier, with the exception of the IP address range for the remote endpoint.

Setting	Single Client	Server/Gateway
---------	---------------	----------------

Remote IP addresses	172.16.9.10 For a single client, this is the same as the Gateway address	Subnet address: 11.5.0.0 255.255.0.0 Address range used on the remote LAN.
------------------------	--------------------------------------------------------------------------------	-------------------------------------------------------------------------------------

Windows 2000 Server Configuration

Configuration is the same as for *Example 2: Windows 2000/XP Client* to except for specifying the *Source* and *Destination* addresses for the "Filter Properties". Instead, for both IP Filters, the *Filter Properties- Addressing* should be completed as follows.

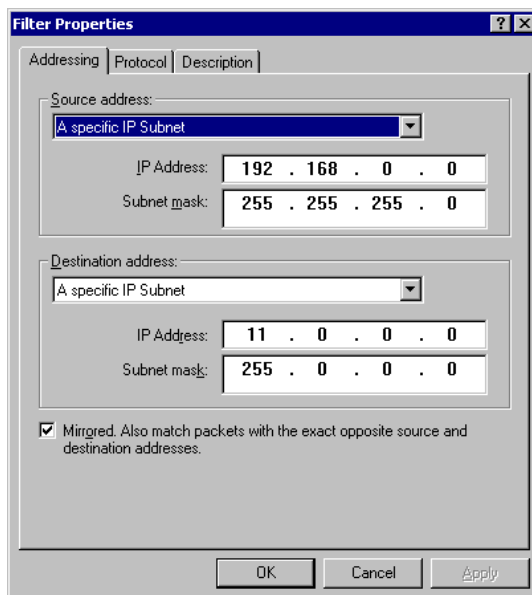

Figure 77: Windows 2000 Server - Addressing

- The *Source Address* should be set to "A specific IP Subnet", and the *IP address* and *Subnet mask* set to the address range used on the Broadband VPN Gateway's LAN.
- The *Destination Address* should be set to "A specific IP Subnet", and the *IP address* and *Subnet mask* set to the address range used on the Windows 2000 LAN.

Certificates

Certificates are used to authenticate users. Certificates are issued to you by various CAs (Certification Authorities). These Certificates are called "Self Certificates".

Each CA also issues a certificate to itself. This Certificate is required in order to validate communication with the CA. These certificates are called "Trusted Certificates."

The *Certificates* screen lists either the **Trusted Certificate** - the certificates of each CA itself - or **Self Certificate** - the certificates issued to you.

Trusted Certificates

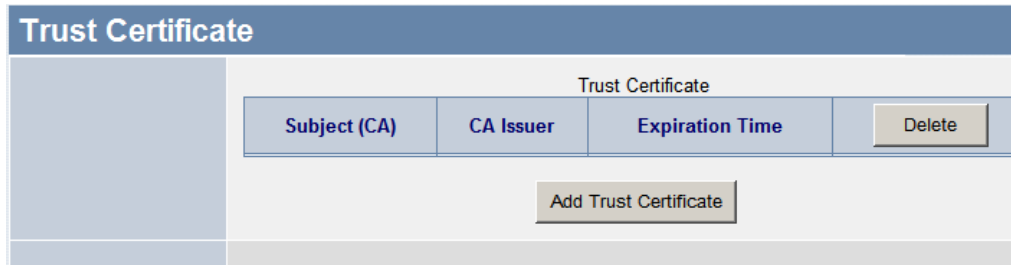

Figure 78: Trusted Certificate Screen

Data - Trusted Certificate Screen

Trusted Certificates	
Subject (CA)	The "Subject Name" is always the company or person to whom the Certificate is issued. For trusted certificates, this will be a CA.
CA Issuer	The CA (Certification Authority) which issued the Certificate.
Expiration Time	The date on which the Certificate expires. You should renew the Certificate before it expires.
Delete button	Use this button to delete a Trusted Certificate. Select the checkbox in the <i>Delete</i> column for any Certificates you wish to delete, then click the "Delete" button.
Add Trust Certificate button	Use this to add a new Trusted Certificate to the table. See below for details.

Requesting a Trusted Certificate

1. After obtaining a new Certificate from the CA, you need to upload it to the Broadband VPN Gateway.
2. On the "Certificates" screen, click the "Add Trusted Certificate" button to view the *Add Trusted Certificate* screen, shown below.

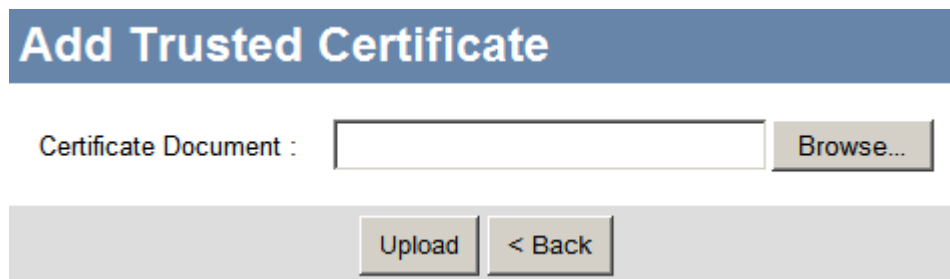

Figure 79: Add Trusted Certificate

3. Click the "Browse" button, and locate the certificate file on your PC
4. Select the file. The name will appear in the "Certificate File" field.
5. Click "Upload" to upload the certificate file to the Broadband VPN Gateway.
6. Click "Back" to return to the Trusted Certificate list. The new Certificate will appear in the list.

Private Certificate

Figure 80: Private Certificate Screen

Data - Private Certificate Screen

Private Certificate	
Name	The name you assigned to this Certificate. You should select a name which helps to identify this particular certificate.
Subject	The company or person to whom the Certificate is issued.
Issuer	The CA (Certification Authority) which issued the Certificate.
Expiration Time	The date on which the Certificate expires. You should renew the Certificate before it expires.
Delete button	Use this button to delete a Self Certificate. Select the checkbox in the <i>Delete</i> column for any Certificates you wish to delete, then click the "Delete" button.
Private Certificate Requests	
Request List	<p>Any current requests are listed. These requests are generated by using the <i>New Request</i> button described below.</p> <ul style="list-style-type: none"> • After you have received the Certificate file for a request, you must select the request in the list, and upload the certificate file. The request will then be deleted from this list, and the Certificate will appear in the <i>Private Certificates</i> table. • If for some reason you never obtain the Certificate, you can manually delete the request by using the <i>Delete</i> button.
Delete Button	Use this to delete the selected certificate request.

Upload Button	After you have received a Certificate, use this to upload the certificate to the Broadband VPN Router. You must select the correct certificate request, so the Broadband VPN Router can correctly match the request and the certificate.
New Request Button	Use this to generate a new request to be supplied to a CA (Certification Authority). See the following section for details.

Requesting a Private Certificate

The Broadband VPN Gateway must generate a request for the CA. This request must then be supplied to the CA. The procedure is as follows:

1. On the *Self Certificates* screen, click the *New Request* button to view the first screen of the *Private Certificate Request* procedure, shown below.

Figure 81: Private Certificate Request (1)

2. Complete this screen.

Name	Enter a name which helps to identify this particular certificate. This name is only for your reference, it is not visible to other people.
Subject	This is the name which other organizations will see as the Holder (owner) of this Certificate. This should be your registered business name or official company name. Generally, all Certificates should have the same value in the Subject field.
Hash Algorithm	Select the desired option.

Authentication Algorithm	Select the desired option. RSA is recommended.
Key Size	Select the desired option. Normally, 1024 bits provides adequate security.
IP address	Enter your public (Internet) IP address.
Domain Name	This is optional. If you have a domain name, enter it here.
E-mail	This is optional. If you have permanent E-mail address, enter it here.

- Click "Next" to continue to the following screen.

Apply for Private Certificate (2)

Certificate Detail

Subject Name : Test
Hash Algorithm : MD5
Authentication Algorithm : RSA
Key Size : 512

Data for CA

```
-----BEGIN CERTIFICATE REQUEST-----
MIH9MIGoAgECMA8xDTALBgNVBAMTBFRlc3QwXDANBgkqhkiG9w0BAQEFAANLADBI
AkEAr4LC5nUC7/8X1nAHBuwDyUAIPUZmukUjpHGb2sVRHEFFV07yWw2dMHgvOpcY
5UKi7G9BL9oOAAC0wAqexgsh/wIDAQABoDQwMgYJKoZIhvcNAQkOMSUwIzAhBgNV
HREEGjAYhwTAqAEzgRBzdXBwb3J0QHRYZW5kbmVOMAOGCSqGSIb3DQEBAUAA0EA
crW9vS8rtNjidMOgfoXRQmILCgobL3Jgcf3RdaCgx9SPxq5bpRLmbavoc53Hg7qut
e1RkiFw1m62USaUd02QDTQ==
-----END CERTIFICATE REQUEST-----
```

< Back Finish Cancel

Figure 82: Private Certificate Request (2)

- Check that the data displayed in the *Certificate Details* section is correct. This data is used to generate the Certificate request. If the data is not correct, click the "Back" button and correct the previous screen.
- If the data is correct, copy the text in the *Data for CA* panel (including "-----BEGIN CERTIFICATE REQUEST-----" and "-----END CERTIFICATE REQUEST-----") to a new document in a text editor such as Notepad, and save the file.
- Click *Finish* to return to the *Self Certificates* screen. Your request will be listed under *Self Certificate Requests*.
- Apply for a Certificate:
 - Connect to the CA's web site.
 - Start the Self Certificate request procedure.

- When prompted for the request data, supply the data you copied and saved in step 5 above.
 - Submit the CA's form.
 - If there are no problems, the Certificate will then be issued.
8. After obtaining a new Certificate, as described above, you need to upload it the Broadband VPN Gateway.
- Return to the **Private Certificates** screen.
 - In the *Self Certificate Requests* list, select the request matching this certificate.
 - Click the *Upload Certificate* button.
- You will see a screen like the one below.

Figure 83: Upload Private Certificate

9. Upload the Certificate:
- Click the *Browse* button, and locate the certificate file on your PC
 - Select the file. The name will appear in the *Certificate Document* field.
 - Click the *Upload* button to upload the certificate file to the Broadband VPN Gateway.
 - Click *Back* to return to the **Private Certificates** screen. The new Certificate will appear in the *Active Self Certificates* list.

CRL

CRLs are only necessary if using Certificates.

CRL (Certificate Revocation List) files show Certificates which have been revoked, and are no longer valid. Each CA issues their own CRLs.

It is VERY IMPORTANT to keep your CRLs up-to-date. You need to obtain the CRL for each CA regularly. The "Next Update" field in the CRL shows when the next update will be available.

To add a New CRL

1. Obtain the CRL file from your CA.
2. Select *CRL* from the VPN menu. You will see a screen like the example below.

Figure 84: Certificate Revocation Lists

3. Click the "Add New CRL" button. You will see a screen like the following:

Figure 85: Upload CRL

4. Upload the CRL file:
 - Click the "Browse" button, and locate the CRL file on your PC
 - Select the file. The name will appear in the "Upload File" field.
 - Click "Upload" to upload the CRL file to the Broadband VPN Gateway.
 - Click "Back" to return to the CRL list. The new CRL will appear in the list.
5. Use the "Delete" button to delete the previous (now outdated) CRL.

VPN Status

This screen lists all VPN SAs (Security Association) which exist at the current time.

- If no VPN tunnels exist at the current time, the table will be empty.
- To update the display, click the "Refresh" button.
- If using IKE, there is one SA for the IKE connection, and another SA for the IPSec connection.
- For each VPN SA the following data is displayed.

Figure 86: VPN Status Screen

Data - VPN Status Screen

VPN Status	
Policy Name	The name of the VPN Policy which triggered this VPN connection.
SPI	Each SA (Security Association) has a unique SPI. For manual keys, this SPI is specified by user input. If using IKE, the SPI is generated by the IKE negotiation process.
Type	Each SAs (Security Association) will be either IKE or IPSec.
VPN	The IP address of the remote VPN Endpoint.
Data Transmission	Measures the quantity of data which has been sent (Transmitted) via this SA.
Buttons	
Refresh	Update the data shown on screen.

Check Log

Open a new window and view the contents of the VPN log.

9

Chapter 9

Microsoft VPN

This Chapter explains the screens and settings available for the Microsoft VPN function.

Overview

Microsoft VPN uses the *Microsoft VPN Adapter* which is provided in recent versions of Windows. This feature can be used to provide remote access to your LAN by individual PCs. This method provides an alternative to using IPsec VPN, which is described in the previous chapter. Using Microsoft VPN provides easier setup than using IPsec VPN.

The following Microsoft VPN configuration screens are provided.

- VPN Adapter
- Users
- Status

Server Setup

The Broadband VPN Gateway incorporates a PPTP (Peer-to-Peer Tunneling Protocol) server which is compatible with the "VPN Adapter" provided with recent versions of Microsoft Windows. Remote Windows clients are able to connect to this Server. Once connected, they can access the LAN as if they connected locally.

The *Server* setup screen is accessed by selecting the *Server* option on the *VPN(PPTP)* menu.

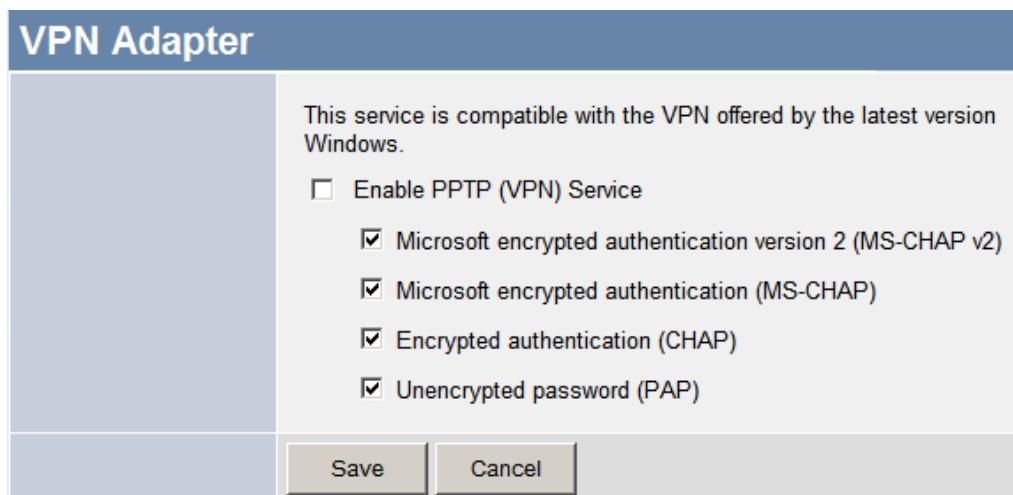

Figure 87: VPN Adapter Screen

Data - VPN Adapter Screen

PPTP Service	
Enable PPTP	Use this checkbox to enable or disable this feature as required. To allow connection by remote Windows clients, you must enable this feature, and enter the client details (on the <i>Clients</i> screen) to allow them to login to this Server.
Authentication Methods	Enable the desired authentication methods. The methods are listed with the most secure first, least secure last. If multiple methods are checked, the most secure will be tried first. If the remote client does not support this, then the other checked methods are tried in order. You must enable at least one method.

User

To login to the PPTP Server (above) using the Microsoft Windows VPN Adapter, remote users must be entered in the VPN client database.

The *User* setup screen is accessed by selecting the *User* option on the *VPN (PPTP)* menu.

Figure 88: User Screen

Data - User Screen

Existing Users	
User List	<p>All existing users are listed. If you have not added any users, this list will be empty.</p> <p>When a user is selected, their details are displayed in the <i>Properties</i> panel. You can then edit the user's information as required; click <i>Update Selected User</i> to save your changes. (If you select another user before saving your changes, your changes are lost.)</p>
Delete Button	Use this to delete the selected user if required.
Properties	
Allow connection	Use this to enable or disable access by this user, as required.
Login Name	Enter the login name. The remote user must provide this name when they connect. The name must not contain spaces, punctuation, or special characters.
Login Password	Enter the login password. The remote user must provide this password when they connect.
Confirm Password	Re-enter the password above.
Button	
Clear Form	Use this to prepare the form for a new entry. Any existing data will be cleared.
Add New User	Use this to save the data in the "Properties" area as a new entry. (If a user is selected in the "Existing User" list, the selection is ignored.)
User Update	<p>Use this to update the data for the user selected in the <i>Existing User</i> list. To change an existing user's data, follow this procedure.</p> <ol style="list-style-type: none"> 1. Select the desired user in the <i>Existing Users</i> list. Their information will be displayed in the <i>Properties</i> panel. 2. Change the data in the <i>Properties</i> panel as required. 3. Click the <i>User Update</i> button to save your changes.

Status Log Screen

The *Status Log* screen is accessed by selecting the *Status Log* option on the *VPN (PPTP)* menu.

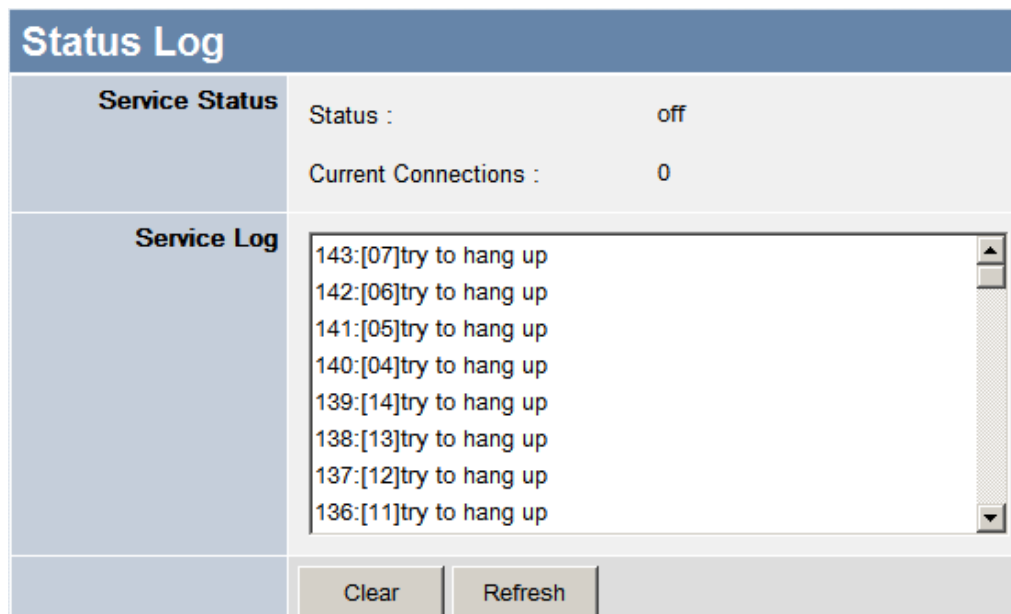

Figure 89: Status Log Screen

Data - Status Log Screen

Status Log	
Status	This indicates whether or not the PPTP (VPN) Server is enabled.
Current Connections	This indicates the number of remote clients currently logged into the PPTP (VPN) Server.
Service Log	
Service Log	This displays details of each connection or connection attempt. You can use the <i>Clear</i> button to re-start the log, making new messages easier to read.

Windows Client Setup

To connect to the PPTP (VPN) Server in the VPN Broadband Gateway:

- The Microsoft VPN feature in the VPN Broadband Gateway must be enabled and configured, as described in the previous section.
- Each user must have a login (username and password) on the VPN client database on the VPN Broadband Gateway.
- The remote client PC must be configured as described in the following sections.
- It is assumed that remote users have a Broadband (not dial-up) connection to the Internet.

Windows 98/ME

1. Click *Start - Settings - Dial-up Networking*
2. Select *Make New Connection*

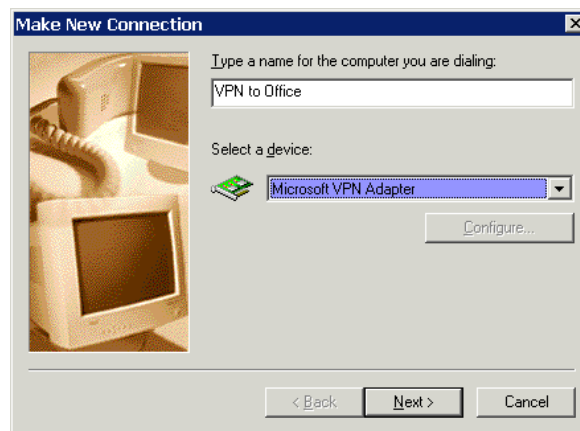

Figure 90: Windows ME VPN Adapter

3. Type a name for this connection, and ensure that "Microsoft VPN Adapter" is selected. Click "Next" to continue.

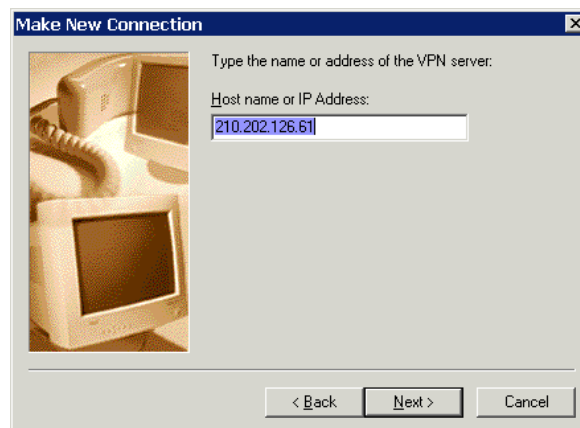
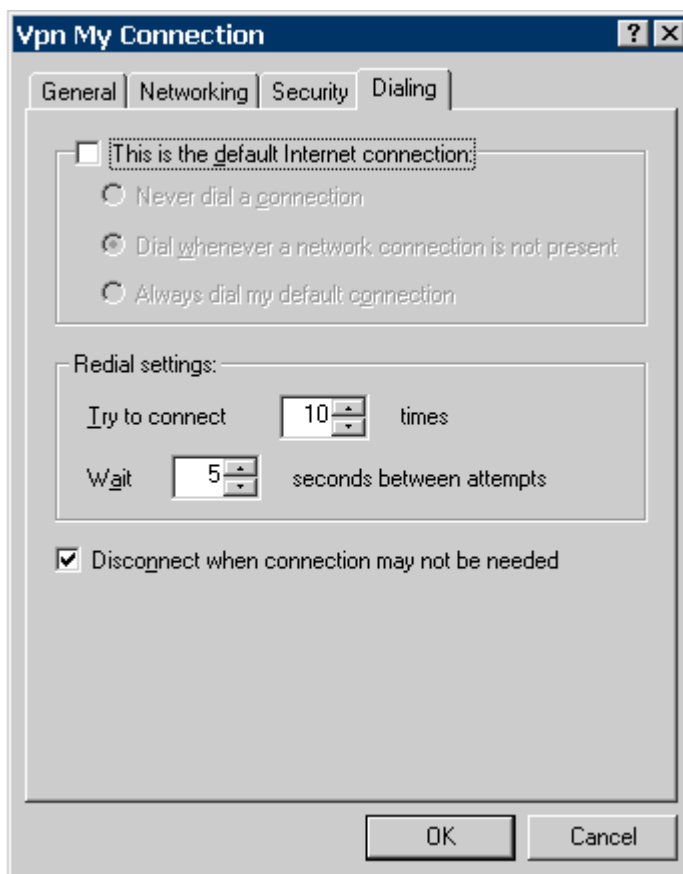

Figure 91: Windows ME VPN Remote Host

4. Enter the Internet IP address or domain name of this device. (If you don't have a fixed IP address, you can use a Dynamic DNS service to obtain a domain name.)
Click "Next" to continue.
5. Click "Finish" to exit the Wizard.
The new entry will now be listed in "Dial-up Networking".

If necessary, you can change the settings for this connection by right-clicking on it, and selecting **Properties**.

To force all outgoing traffic to be sent via VPN, enable the setting *This is the default Internet connection* on the *Dialing* tab. (Do NOT enable this setting if using Dial-up or PPPoE client software.)



Windows ME VPN Dialing Properties

To establish a connection:

1. Ensure you are connected to the Internet.
2. Select *Start - Settings - Dial-up Networking*
3. Double-click the new VPN entry in *Dial-up Networking*.
4. Enter your User name and Password, as recorded in the Client database on the Broadband VPN Gateway.
5. Click the "Connect" button.

Windows 2000

Ensure you have logged on with Administrator rights before attempting this procedure.

1. Open "Network Connections", and start the "New Connection" Wizard.

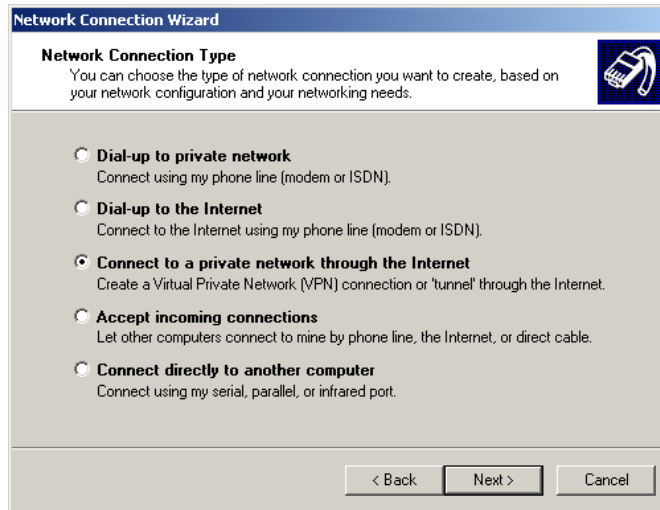

Figure 92: Windows 2000 Network Connection

2. Select the VPN option ("Connect to a private network through the Internet"), as shown above, and click *Next*.

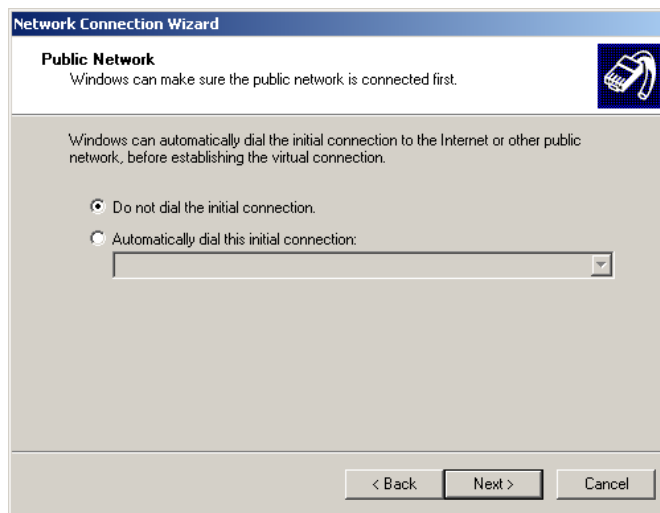

Figure 93: Windows 2000 Public Network

3. On the screen above:
 - Select "Do not dial the initial connection" if Internet access is via the LAN.
 - If using a PPPoE software client, select "Automatically dial this initial connection" and select the PPPoE connection.
 - Click *Next* to continue.

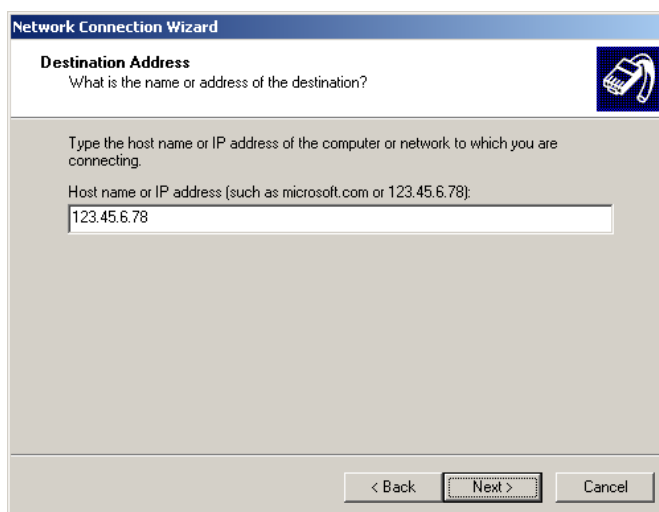

Figure 94: Windows 2000 VPN Host

4. On the screen above, enter the Domain Name or Internet IP address of the Broadband VPN Gateway you wish to connect to. Click *Next* to continue.



Figure 95: Windows 2000 Connection Availability

5. Choose whether to allow this connection for everyone, or only for yourself, as required. Click *Next* to continue.

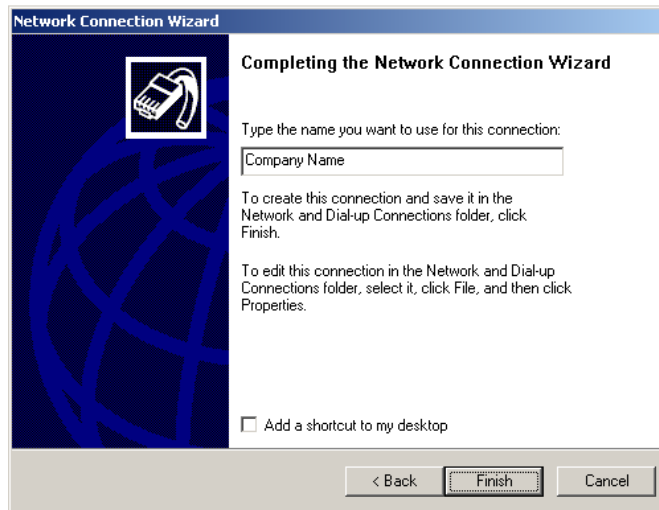

Figure 96: Windows 2000 Finish Wizard

6. Enter a suitable name, and click "Finish" to save and exit.

Setup is now complete.

To establish a connection:

1. Right-click the connection in "Network Connections", and select "Connect".
2. You will then be prompted for the username and password. Enter the username and password assigned to you, as recorded in the VPN client database on the Broadband VPN Gateway.
3. You can choose to have Windows remember the password if desired, so you do not have to enter it again.

Changing the connection settings

The PPTP (VPN) Server in the Broadband VPN Gateway is designed to work with the default Windows settings.

- If necessary, you can change the Windows settings by right-clicking the VPN connection in *Network Connections*, and selecting *Properties*.
- The *Properties* dialog has a *Networking* tab with a "Type of VPN" setting. If you have trouble connecting, you can change this setting from "Automatic" to "PPTP VPN".

Windows XP

Ensure you have logged on with Administrator rights before attempting this procedure.

1. Open *Network Connections* (Start-Settings-Network Connections), and start the New Connection Wizard.



Figure 97: Windows XP Network Connection Type

2. Select the option "Connect to the network at my workplace", as shown above, and click *Next*.

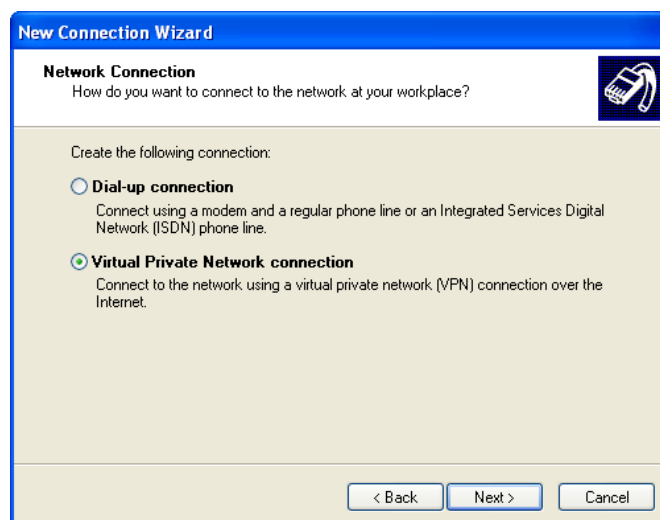

Figure 98: Windows XP Network Connection

3. On the next screen, shown above, select the "Virtual Private Network connection" option. Click *Next* to continue.

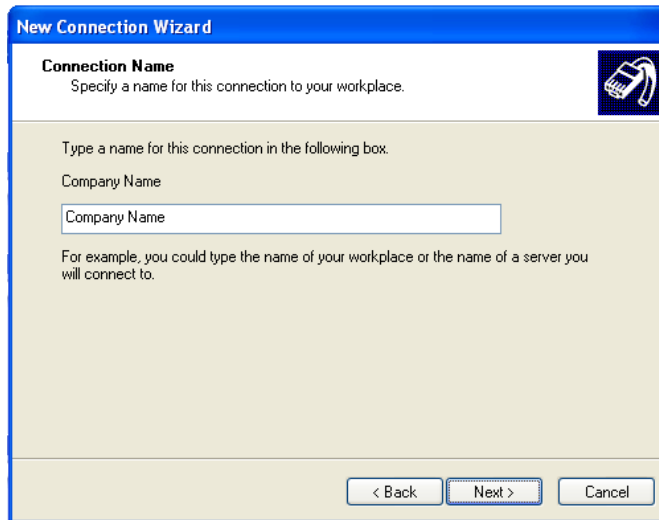

Figure 99: Windows XP Connection Name

4. Enter a suitable name for this connection.
Click *Next* to continue.

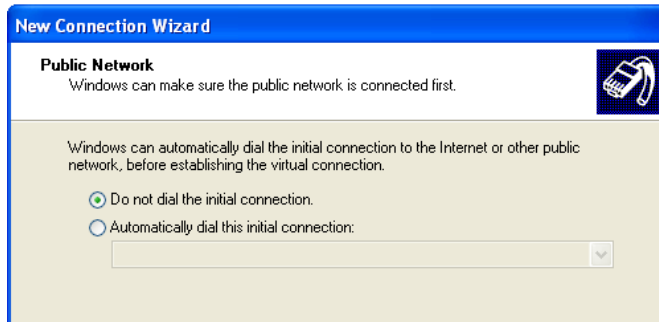

Figure 100: Windows XP Public Network

5. On the screen above, select "Do not dial the initial connection".
Click *Next* to continue.

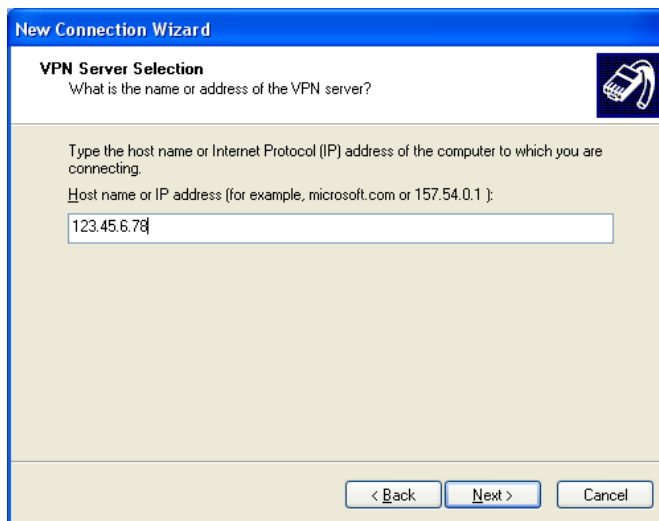

Figure 101: Windows XP VPN Server

6. On the screen above, enter the Domain Name or Internet IP address of the Broadband VPN Gateway you wish to connect to.
Click *Next* to continue.

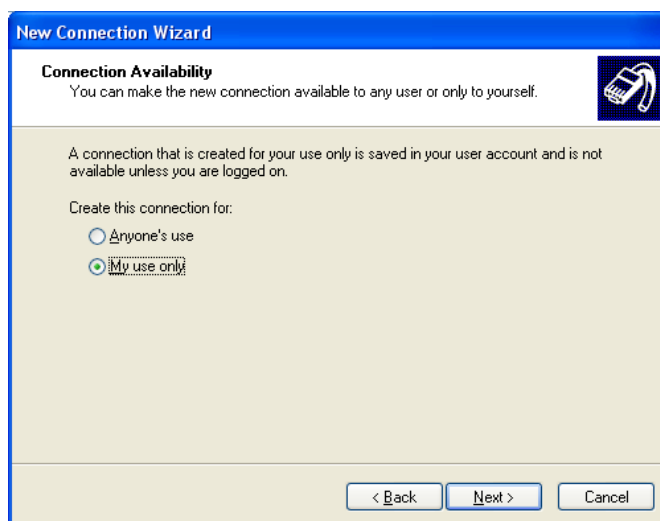

Figure 102: Windows XP Connection Availability

7. Choose whether to allow this connection for everyone, or only for yourself, as required. Click *Next* to continue.
8. On the final screen, click *Finish* to save and exit.

Setup is now complete.

To establish a connection:

1. Right-click the connection in "Network Connections", and select "Connect".
2. You will then be prompted for the username and password. Enter the username and password assigned to you, as recorded in the VPN client database on the Broadband VPN Gateway.
3. You can choose to have Windows remember the password if desired, so you do not have to enter it again.

Changing the connection settings

The PPTP (VPN) Server in the Broadband VPN Gateway is designed to work with the default Windows settings.

- If necessary, you can change the Windows settings by right-clicking the VPN connection in *Network Connections*, and selecting *Properties*.
- The *Properties* dialog has a *Networking* tab with a "Type of VPN" setting. If you have trouble connecting, you can change this setting from "Automatic" to "PPTP VPN".

Chapter 10

Other Features & Settings

10

This Chapter explains the screens and settings available via the "Other" menu.

Overview

Normally, it is not necessary to use these screens, or change any settings. These screens and settings are provided to deal with non-standard situations, or to provide additional options for advanced users.

The screens available are:

Diagnostics	Ping, DNS Lookup.
Password	Only required if your LAN has other Routers or Gateways.
Web Management	This feature allows you to manage the Broadband VPN Gateway via the Internet.
Firmware Upgrade	The firmware (software) in the Broadband VPN Gateway can be upgraded using your Web Browser.
Backup/Restore	Backup or restore the configuration file for the Broadband VPN Gateway. This file contains all the configuration data.

Diagnostics

This screen allows you to perform a "Ping" or a "DNS lookup". These activities can be useful in solving network problems.

An example *Diagnostics* screen is shown below.

The screenshot shows a window titled "Diagnostics" with a blue header. It is divided into two main sections: "Ping" and "DNS Lookup".

Ping Section: On the left, the word "Ping" is written in bold. To the right, there is a text input field labeled "Ping This IP Address:" followed by a "Ping" button. Below this is a large text area labeled "Ping Result" with scrollbars.

DNS Lookup Section: On the left, the words "DNS Lookup" are written in bold. To the right, there is a text input field labeled "Domain Name / URL:" followed by a "Search" button. Below this is another large text area labeled "DNS Search Result" with scrollbars.

At the bottom center of the window, there is a "Clear" button.

Figure 103: Diagnostics Screen

Data - Diagnostics Screen

Ping	
Ping This IP Address	Enter the IP address you wish to ping. The IP address can be on your LAN, or on the Internet. Note that if the address is on the Internet, and no connection currently exists, you could get a "Timeout" error. In that case, wait a few seconds and try again.
Ping Button	After entering the IP address, click this button to start the "Ping" procedure. The results will be displayed in the <i>Ping Result</i> pane.
DNS Lookup	
Domain Name/URL	Enter the Domain name or URL for which you want a DNS (Domain Name Server) lookup. Note that if the address is on the Internet, and no connection currently exists, you could get a "Timeout" error. In that case, wait a few seconds and try again.

Search Button	After entering the Domain name/URL, click this button to start the "DNS Search" procedure. The results will be displayed in the <i>DNS Search Result</i> pane.
----------------------	----------------------------------------------------------------------------------------------------------------------------------------------------------------

Password Screen

The password screen allows you to assign a password to the Wireless Router.

Account Management							
account_tbl_list							
User Name	User Rights			Latest Login		Edit	Delete
	Read	Write	View	Last Login Time	Last Login IP		
<input type="text"/>	<input type="checkbox"/>	<input type="checkbox"/>	<input type="checkbox"/>	<input type="text"/>	<input type="text"/>	<input type="checkbox"/>	<input type="checkbox"/>

Figure 104: Account Management Screen

Data - Account Management Screen

Password	
User Name	It displays the current existing user names.
User Rights	It describes the rights of the current user.
Latest Login	It displays the last login time and the IP Address.
Edit Button	Click this button to modify the user settings.
User Name	Enter the desired User Name.
New Password	Enter the new password here.
Confirm Password	Re-enter the new password here.
Read, Write, View	Check these functions as required.

Once you have assigned a password to the Wireless Router (on the *Password* screen above) you will be prompted for the password when you connect, as shown below. (If no password has been set, this dialog will not appear.)

Enter Network Password

Please type your user name and password.

Site: 192.168.0.1

Realm: NeedPassword

User Name:

Password:

Save this password in your password list

OK Cancel

Figure 105: Password Dialog

- Leave the "User Name" blank.
- Enter the password for the Wireless Router, as set on the *Password* screen above.

Web Management

Web Management allows you to connect to this interface via the Internet, using your Web browser.

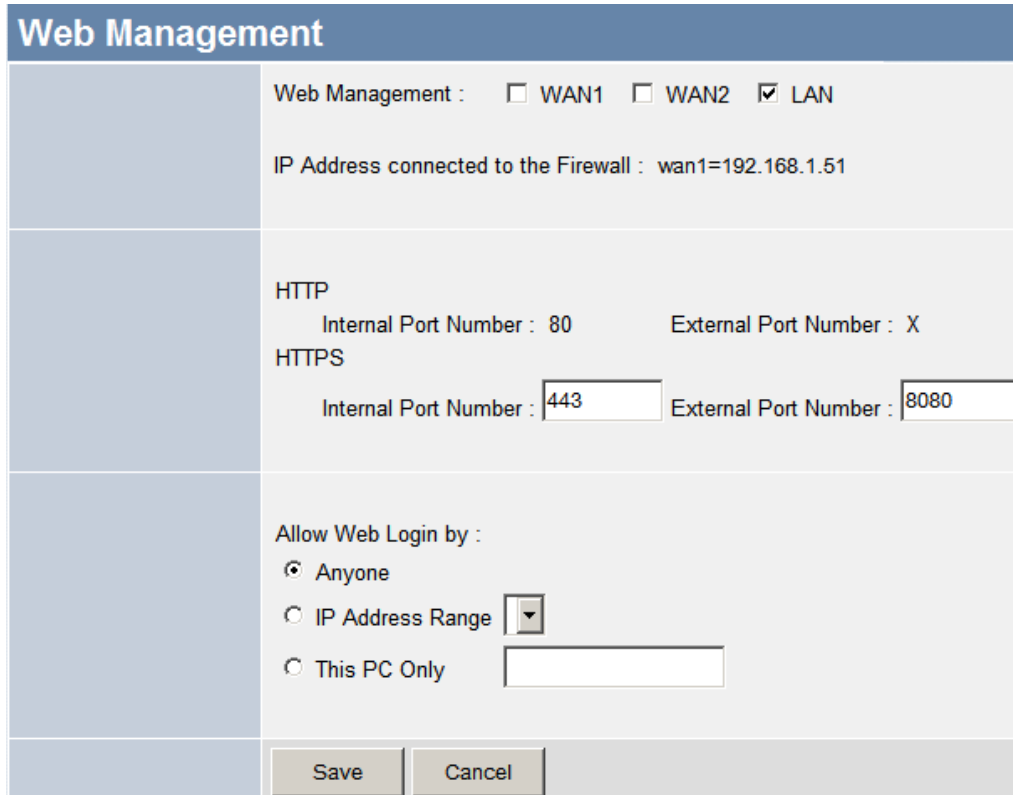

Figure 106: Web Management Screen

Data - Web Management Screen

Settings	
Web Management	<p>Select WAN1, WAN2 or LAN to allow administration/management via the Internet. (To connect, see above).</p> <p>If Disabled, this device will ignore management connection attempts from the Internet.</p>
IP Address	<p>To manage this device via the Internet, you need to know the IP Address of this device, as seen from the Internet. This IP Address is allocated by your ISP, and is shown here if you are currently connected to the Internet. But if using a Dynamic IP Address, this value can change each time you connect to your ISP. There are 2 solutions to this problem:</p> <ul style="list-style-type: none"> • Have your ISP allocate you a Fixed IP address. • Use the DDNS feature (Internet menu) so you can connect using a Domain Name, rather than an IP address.
Internal Port Number	<p>Enter a port number between 1024 and 65535. The default for HTTP connections is port 80, and for HTTPS port 443. Using either of these is NOT recommended.</p> <p>The port number must be specified in your Browser when you connect, as explained above.</p>

External Port Number	The default value is 8080.
Allow Web Login by	<p>This allows you to restrict remote access by IP address. Select the desired option.</p> <ul style="list-style-type: none"> • Anyone - Remote user's IP address is not checked. • IP Address Range - Only the PCs in the selected IP address range will be allowed. • This PC Only - Only the specified IP address is allowed. If selected, you must enter an IP address in the field provided.

To connect from a remote PC via the Internet

1. Ensure your Internet connection is established, and start your Web Browser.
2. In the "Address" bar, enter "HTTPS://" followed by the Internet IP Address of the Broadband VPN Gateway. If the port number is not 80, the port number is also required. (After the IP Address, enter ":" followed by the port number.)
e.g.

HTTPS://123.123.123.123:8080

This example assumes the WAN IP Address is 123.123.123.123, and the port number is 8080.

Firmware Upgrade

Use this screen to upgrade your Broadband VPN Gateway's firmware.

- You must download the required firmware file, and store it on your PC.
- During the upgrade process, all existing Internet connections will be terminated.
- The upgrade process must NOT be interrupted!

Figure 107: Upgrade Firmware Screen

Data - Firmware Upgrade Screen

Firmware Upgrade	
Current Software Version	It displays the current firmware version.
Firewall Password	Enter the current password assigned to the firewall. If no password has been assigned, leave this blank.
File	Click the "Browse" button and browse to the location on your PC where you stored the firmware upgrade file. Select this file.
Start to Upgrade	Click this button to start the Firmware upgrade. Note that any users accessing the Internet via the Broadband VPN Gateway will lose their connection. When the upgrade is finished, the Broadband VPN Gateway will restart, and this management connection will be unavailable during the restart.
Cancel	Cancel does NOT stop the Upgrade process if it has started. It only clears the input for the "Upgrade File" field.

To perform the Firmware Upgrade:

1. Click the "Browse" button and navigate to the location of the upgrade file.
2. Select the upgrade file. Its name will appear in the *File* field.
3. Click the "Start to Upgrade" button to commence the firmware upgrade.



The Broadband VPN Gateway is unavailable during the upgrade process, and must restart when the upgrade is completed. Any connections to or through the Broadband VPN Gateway will be lost.

Backup/Restore

This feature allows you to backup (download) the current settings from the Broadband VPN Gateway, and save them to a file on your PC.

You can restore a previously-downloaded configuration file to the Broadband VPN Gateway, by uploading it to the Broadband VPN Gateway.

This screen also allows you to set the Broadband VPN Gateway back to its factory default configuration. Any existing settings will be deleted.

An example *Backup/Restore* screen is shown below.

Figure 108: Backup/Restore File Screen

Data - Backup/Restore Screen

Backup	Use this to download a copy of the current configuration, and store the file on your PC. Click <i>Backup</i> to start the download.
Restore	This allows you to restore a previously-saved configuration file back to the Broadband VPN Gateway. Click <i>Browse</i> to select the configuration file, then click <i>Restore</i> to upload the configuration file. WARNING ! Uploading a configuration file will destroy (overwrite) ALL of the existing settings.
Convert Language	Click <i>Browse</i> to select the file, then click <i>Convert</i> to upload the file.

Default Configuration	Enable the <i>Restore the default language</i> if required. Clicking the <i>Factory Defaults</i> button will reset the Broadband VPN Gateway to its factory default settings. WARNING ! This will delete ALL of the existing settings.
------------------------------	---------------------------------------------------------------------------------------------------------------------------------------------------------------------------------------------------------------------------------------------------------



This Appendix covers the most likely problems and their solutions.

Overview

This chapter covers some common problems that may be encountered while using the Broadband VPN Gateway and some possible solutions to them. If you follow the suggested steps and the Broadband VPN Gateway still does not function properly, contact your dealer for further advice.

General Problems

Problem 1: Can't connect to the Broadband VPN Gateway to configure it.

Solution 1: Check the following:

- The Broadband VPN Gateway is properly installed, LAN connections are OK, and it is powered ON.
- Ensure that your PC and the Broadband VPN Gateway are on the same network segment. (If you don't have a router, this must be the case.)
- If your PC is set to "Obtain an IP Address automatically" (DHCP client), restart it.
- If your PC uses a Fixed (Static) IP address, ensure that it is using an IP Address within the range 192.168.0.2 to 192.168.0.254 and thus compatible with the Broadband VPN Gateway 's default IP Address of 192.168.0.1.

Also, the Network Mask should be set to 255.255.255.0 to match the Broadband VPN Gateway.

In Windows, you can check these settings by using *Control Panel-Network* to check the *Properties* for the TCP/IP protocol.

Internet Access

Problem 1: When I enter a URL or IP address I get a time out error.

Solution 1: A number of things could be causing this. Try the following troubleshooting steps.

- Check if other PCs work. If they do, ensure that your PCs IP settings are correct. If using a Fixed (Static) IP Address, check the Network Mask, Default gateway and DNS as well as the IP Address.
- If the PCs are configured correctly, but still not working, check the Broadband VPN Gateway. Ensure that it is connected and ON. Connect to it and check its settings. (If you can't connect to it, check the LAN and power connections.)
- If the Broadband VPN Gateway is configured correctly, check your Internet connection (DSL/Cable modem etc) to see that it is working correctly.

Problem 2: Some applications do not run properly when using the Broadband VPN Gateway.

Solution 2: The Broadband VPN Gateway processes the data passing through it, so it is not transparent.

Use the *Special Applications* feature to allow the use of Internet applications which do not function correctly.

If this does solve the problem you can use the *DMZ* function. This should work with almost every application, but:

- It is a security risk, since the firewall is disabled.
- Only one (1) PC can use this feature.

Appendix B

Specifications



Broadband VPN Gateway

Model	Broadband VPN Gateway
Dimensions	235mm(W) * 147mm(D) * 33mm(H)
Operating Temperature	0° C to 40° C
Storage Temperature	-10° C to 70° C
Network Protocol:	TCP/IP
Network Interface:	6 Ethernet: 4 * 10/100BaseT (RJ45) LAN connection 2 * 10/100BaseT (RJ45) for WAN
LEDs	15
Power Adapter	5 V DC External

FCC Statement

This equipment has been tested and found to comply with the limits for a Class B digital device, pursuant to Part 15 of the FCC Rules. These limits are designed to provide reasonable protection against harmful interference in a residential installation.

This equipment generates, uses and can radiate radio frequency energy and, if not installed and used in accordance with the instructions, may cause harmful interference to radio communications. However, there is no guarantee that interference will not occur in a particular installation. If this equipment does cause harmful interference to radio or television reception, which can be determined by turning the equipment off and on, the user is encouraged to try to correct the interference by one of the following measures:

- Reorient or relocate the receiving antenna.
- Increase the separation between the equipment and receiver.
- Connect the equipment into an outlet on a circuit different from that to which the receiver is connected.
- Consult the dealer or an experienced radio/TV technician for help.

To assure continued compliance, any changes or modifications not expressly approved by the party responsible for compliance could void the user's authority to operate this equipment. (Example - use only shielded interface cables when connecting to computer or peripheral devices).

FCC Radiation Exposure Statement

This equipment complies with FCC RF radiation exposure limits set forth for an uncontrolled environment. This equipment should be installed and operated with a minimum distance of 20 centimeters between the radiator and your body.

This device complies with Part 15 of the FCC Rules. Operation is subject to the following two conditions:

- (1) This device may not cause harmful interference, and
- (2) This device must accept any interference received, including interference that may cause undesired operation.

This transmitter must not be co-located or operating in conjunction with any other antenna or transmitter.

CE Marking Warning

CE Standards

This product complies with the 99/5/EEC directives, including the following safety and EMC standards:

- EN301489-1/-17
- EN60950

This is a Class B product. In a domestic environment this product may cause radio interference in which case the user may be required to take adequate measures.



TRENDnet[®]

TRENDnet Technical Support

US • Canada

Toll Free Telephone: 1(866) 845-3673

24/7 Tech Support



Europe (Germany • France • Italy • Spain • Switzerland • UK)

Toll Free Telephone: +00800 60 76 76 67

English/Espanol - 24/7

Francais/Deutsch - 11am-8pm, Monday - Friday MET

Worldwide

Telephone: +[31] [0] 20 504 05 35

English/Espanol - 24/7

Francais/Deutsch - 11am-8pm, Monday - Friday MET

Product Warranty Registration

Please take a moment to register your product online.

Go to TRENDnet's website at <http://www.trendnet.com/register>

TRENDnet[®]

20675 Manhattan Place
Torrance, CA 90501
USA

Free Manuals Download Website

<http://myh66.com>

<http://usermanuals.us>

<http://www.somanuals.com>

<http://www.4manuals.cc>

<http://www.manual-lib.com>

<http://www.404manual.com>

<http://www.luxmanual.com>

<http://aubethermostatmanual.com>

Golf course search by state

<http://golfingnear.com>

Email search by domain

<http://emailbydomain.com>

Auto manuals search

<http://auto.somanuals.com>

TV manuals search

<http://tv.somanuals.com>