



User's Guide

TV-IP252P
1.01

PREFACE

Thank you for purchasing the TV-IP252 SecurView PoE Dome Internet Camera, a standalone system that can be connected directly to an Ethernet or Fast Ethernet network.

The camera features the latest Motion JPEG and MPEG-4 image technology, advanced management functionality, and GPIO connectors (e.g. connecting to the door sensors or alarm bells), allowing you to record streaming video (Motion JPEG or MPEG-4), enable motion detection, and setup automated FTP/Email/ Network Storage service for security.

The audio function (connected external microphone and audio-out device like the active speaker) of the camera allows you to deliver/receive sound to/from the camera. In addition, the superior lens and hardware design enable the camera to capture high quality images even in the low-lux condition.

Compared to the conventional PC Camera, the camera features a built-in CPU and Web-based solutions that can provide a cost-effective solution to transmit the real-time high-quality video images and sounds synchronously for monitoring. The camera can be managed remotely, so that you can use a Web browser to access and control it from any desktop/notebook computer over the Intranet or Internet.

The simple and versatile installation allows you to integrate it into your network environment easily. With comprehensive applications supported, the camera is your best solution for demanding surveillance and remote monitoring applications.

This User Guide provides you with the instructions and illustrations on how to use your camera, which includes:

- Chapter 1 Introduction to Your Camera** describes the features of the camera. You will also know the components and functions of the camera.
- Chapter 2 Hardware Installation** helps you install the camera according to your application environment. You can use this camera at home, at work, any where you want.
- Chapter 3 Accessing the Camera** lets you start using your camera without any problems. The camera can be set up easily and work within your network environment instantly.
- Chapter 4 Configuring the Camera** guides you through the configuration of the camera using the Web browser on your PC.
- Chapter 5 Using SecurView™** shows you the detail instructions on operating SecurView™ software.
- Appendix** Provides the specification of the camera and some useful information for using your camera.

NOTE The illustrations and configuration values in this guide are for reference only. The actual settings depend on your practical application of the camera.

Contents

PREFACE	1
CHAPTER 1	5
INTRODUCTION TO YOUR CAMERA	5
1.1 CHECKING THE PACKAGE CONTENTS	5
1.2 GETTING TO KNOW YOUR CAMERA	6
1.3 FEATURES AND BENEFITS	9
1.4 SYSTEM REQUIREMENT	11
CHAPTER 2	12
HARDWARE INSTALLATION	12
2.1 APPLICATIONS OF THE CAMERA	12
2.2 INSTALLING THE CAMERA	13
CHAPTER 3	17
ACCESSING THE CAMERA.....	17
3.1 USING IPSETUP.....	17
3.2 ACCESSING TO THE CAMERA	22
3.3 CONFIGURING THE IP ADDRESS OF THE PC	26
CHAPTER 4.....	27
CONFIGURING THE CAMERA	27
4.1 USING THE WEB CONFIGURATION	27
4.2 USING SMART WIZARD.....	28
4.3 BASIC SETUP.....	31
4.4 NETWORK SETTINGS.....	35
4.5 SETTING UP VIDEO & AUDIO	41
4.6 EVENT SERVER CONFIGURATION	46
4.7 MOTION DETECT.....	51
4.8 EVENT CONFIG	52
4.9 TOOLS	58
4.10 INFORMATION	60
CHAPTER 5.....	62

USING SECURVIEW™	62
5.1 Installation	62
5.2 Using Installation	67
Item Features	68
To Add a Camera	72
To Remove a Camera	75
To Link to the Web Page of the Camera	76
To Record Video	77
To Configure the Recording Settings	82
To Playback the Recorded Video	84
To Set Up Motion Detection Options	85
Account	87
Other	87
Information	88
CHAPTER 6	89
APPENDIX	89
A.1 SPECIFICATION.....	89
A.2 GLOSSARY OF TERMS	91
LIMITED WARRANTY	101

CHAPTER 1

INTRODUCTION TO YOUR CAMERA

1.1 Checking the Package Contents

Check the items contained in the package carefully. You should have the following:

- TV-IP252P
- Power Adapter (12V DC, 1.5A)
- Mounting Kit
- Cat. 5 Ethernet Cable (1.8m / 6ft.)
- GPIO Adapter
- CD-ROM (Utility & User's Guide)
- Multi-Language Quick Installation Guide

NOTE If there is any item damaged or missing, please contact your local authorized dealer for replacement.

1.2 Getting to Know Your Camera

■ Physical Components



● Connectors

- ① **Power:** Connects the power adapter to supply power to the camera.
- ② **GPIO:** Connects the external device that features additional controlling function, such as motion detection, event triggering, alarm notification, and a variety of external control functions.

Before connecting the external device for GPIO function, you have to attach the provided external GPIO connectors to the device.

- 3 Mic In:** Connects an external microphone to receive the on-the-spot sound where the camera is installed. (Pink Connector)
- 4 Audio Out:** Connects an external audio device (such as the active speaker) to deliver sound via the camera. (Green Connector)
- 5 TV Out:** The BNC connector is used to connect the composite video input of external video device.
- 6 LAN:** Plugs the provided Ethernet cable to connect to your local area network (LAN). The LAN port of the camera supports the NWay protocol so that the camera can detect the network speed automatically.

Connecting Cables

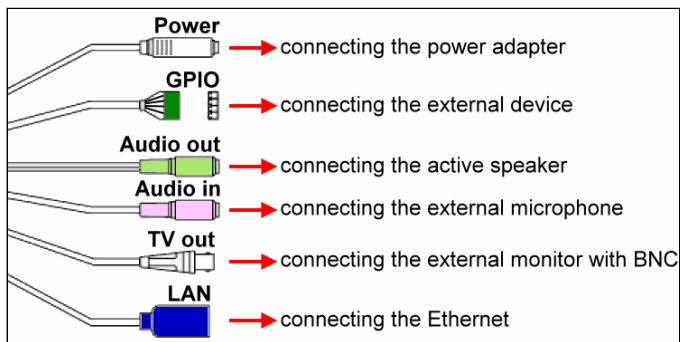

■ Inside Components

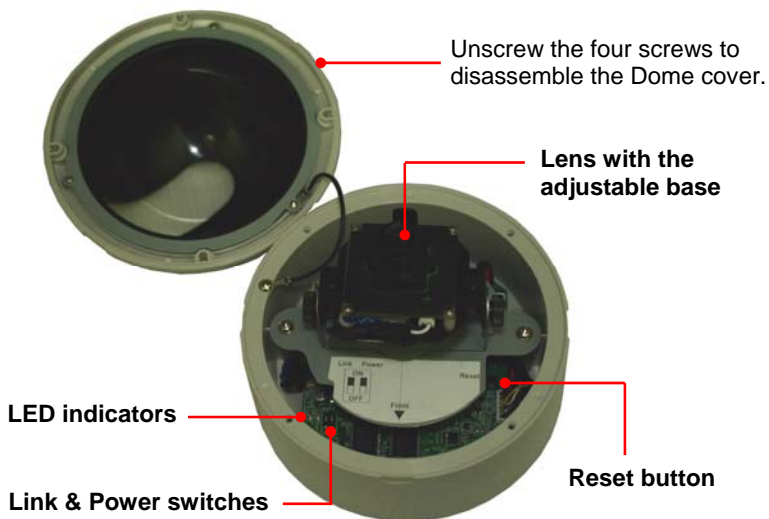

- **Reset button:** Press the button to restart the camera. Press and hold the button for five seconds, the camera will resume the factory default settings.

- **LED indicators**

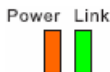

- **Power** indicates the camera is powered on with the steady amber light.
- **Link** indicates the camera's network connectivity with the flashing green light.

- **Link & Power switches:**

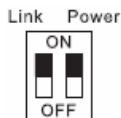

The two switches allow you to turn off the LED indicators manually.

1.3 Features and Benefits

- **MPEG4/MJPEG Dual-codec Supported**

The camera provides you with excellent images by the MPEG4/MJPEG dual-codec selectable technology, allowing you to adjust image size and quality, and bit rate according to the networking environment.

- **Flexible Audio Capability**

The camera allows you to connect the external microphone to receive on-the-spot audio via the Internet, allowing you to monitor the on-site voice. In addition, you can connect an external active speaker to the camera to speak through the camera (supporting mono audio only).

- **Supports RTSP**

The camera supports RTSP (Real Time Streaming Protocol), which is a technology that allows you to view streaming media via the network. You can view the real-time video with the Quick Time player or RealPlayer. To view the real-time streaming image on your computer, open the Web browser and enter the RTSP link:

[rtsp://\(IP address of the camera\)/mpeg4](rtsp://(IP address of the camera)/mpeg4).

- **Remote Control Supported**

By using a standard Web browser or the bundled Ultra View software application, the administrator can easily change the configuration of the camera via Intranet or Internet. In addition, the camera can be upgraded remotely when a new firmware is available. The users are also allowed to monitor the image and take snapshots via the network.

- **I/O Connectors Supported**

The I/O connectors (2-in/1-out) of the camera provide the physical interface to send and receive digital signals to a variety of external alarm devices. You can configure the settings and control the device from the **GPIO Trigger** setting of Web Configuration.

- **Multiple Platforms Supported**

The camera supports multiple network protocols, including TCP/IP, SMTP e-mail, HTTP, and other Internet related protocols. Therefore, you can use the camera in a mixed operating system environment, such as Windows 2000, Windows XP and Windows Vista.

- **Multiple Profiles Supported**

The camera supports multiple profiles simultaneously, so that you can separately set up different image settings (such as image quality and frame rate) for the three video types of the camera: MPEG4, MJPEG, and 3GPP.

- **Multiple Applications Supported**

Through the remote access technology, you can use the cameras to monitor various objects and places for your own purposes. For example, babies at home, patients in the hospital, offices and banks, and more. The camera can capture both still images and video clips, so that you can keep the archives and restore them at any time.

1.4 System Requirement

- **Networking**
 - **LAN:** 10Base-T Ethernet or 100Base-TX Fast Ethernet.

- **Accessing the Camera using SecurView™**
 - **Platform:** Microsoft® Windows® 2000/XP/Vista.

- **Accessing the Camera using Web Browser**
 - **Platform:** Microsoft® Windows® 2000/XP/Vista
 - **CPU:** Intel Pentium III 350MHz or above
 - **RAM:** 128MB
 - **Resolution:** 800x600 or above
 - **User Interface:** Microsoft® Internet Explorer 6.0 or above

- **Hardware Requirement**
 - **Resolution:** 1024x768 or above
 - **1 camera:** Intel Pentium III 800MHz;
512MB RAM
 - **2 ~ 4 cameras:** Intel Pentium 4 1.3GHz; 512MB RAM
 - **5 ~ 8 cameras:** Intel Pentium 4 2.4GHz; 1GB RAM
 - **9 ~ 16 cameras:** Intel Pentium 4 3.4GHz; 2GB RAM

NOTE If you connect multiple cameras within the network to monitor various places simultaneously, you are recommended to use a PC with higher performance.

CHAPTER 2

HARDWARE INSTALLATION

2.1 Applications of the Camera

The camera can be applied in multiple applications, including:

- Monitor local and remote places and objects via Internet or Intranet.
- Capture still images and video clips remotely.
- Upload images or send email messages with the still images attached.

The following diagram explains one of the typical applications for your cameras and provides a basic example for installing the cameras.

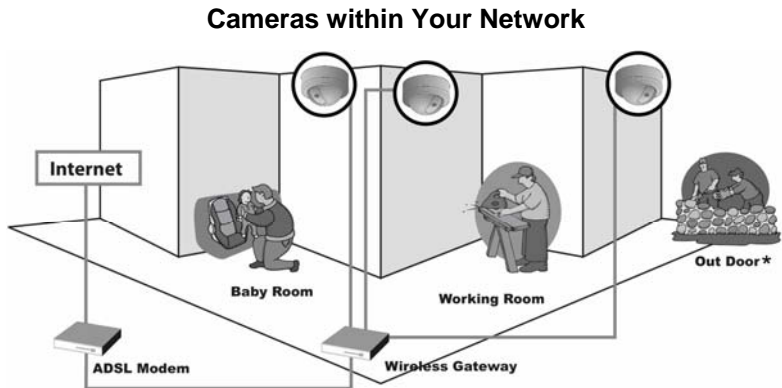

* Please enclose with waterproof housing when using in outdoor environment. The unit itself is not weatherproof.

2.2 Installing the Camera

■ Basic Installation (Surface)

The camera can be mounted to the ceiling surface directly by the following steps:

1. Remove the Dome cover by unscrewing four screws.

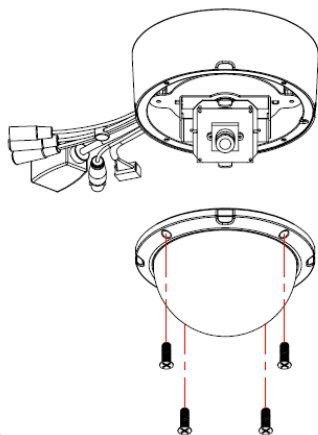

2. Drill three pilot holes into the ceiling and hammer the plastic anchors into the holes.

TIP You can easily and precisely drill the three pilot holes with the provided drill template. Put the drill template on the location where you want to install the camera, and then drill the pilot holes according to the marked screw position on the drill template.

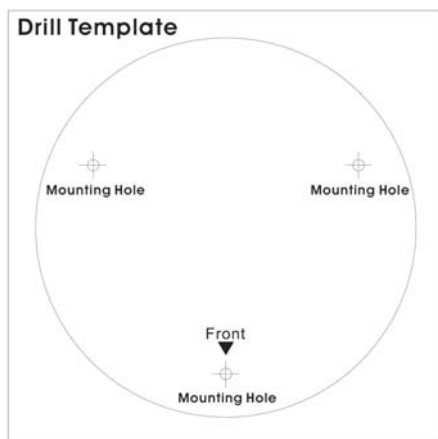

3. Install the camera to the ceiling with three screws.

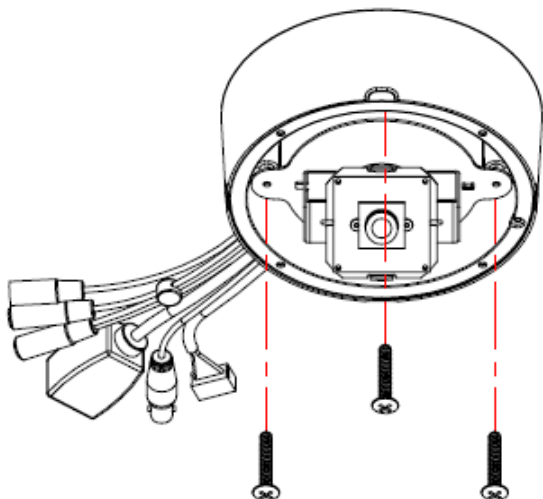

4. Make connections according to your needs (refer to the illustration of connecting cables on page 6).
5. Pan/tilt the camera lens to a proper position by using the adjustable base, and adjust the lens focus by turning the lens ring slowly in either clockwise or anti-clockwise direction.

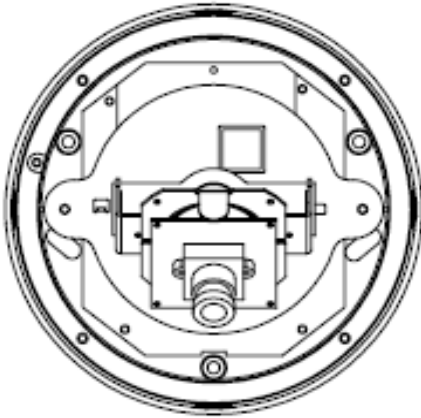

NOTE You can review the image quality from the Web browser when you complete the installation. If the image quality is poor, you have to disassemble the Dome cover to adjust the lens focus until the desired image appears clearly.

6. Replace the Dome cover and secure with four screws.

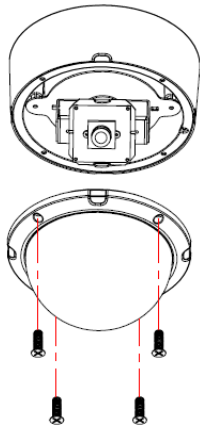

CHAPTER 3

ACCESSING THE CAMERA

3.1 Using IPSetup

The camera comes with a convenient utility, IPSetup, which is included in the Installation CD-ROM, allowing you to search the camera(s) on your network easily.

1. Insert the Installation CD-ROM into your computer's CD-ROM drive to initiate the Auto-Run program.



2. Click the **IPSetup** from the Auto-run menu screen. Then the IPSetup Wizard will appear. Click **Next** when the **Welcome to the IPSetup Wizard** appears.



3. Click **Browse** to choose the desired destination location. By default the destination location is C:\Program Files\TRENDnet\IPSetup. Then click **Next**.

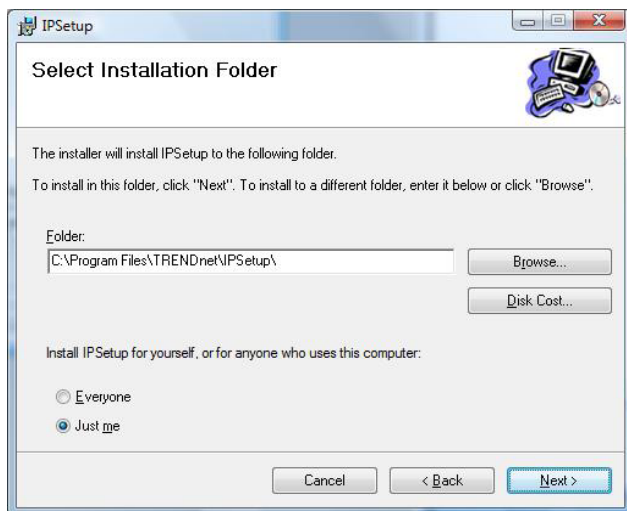

4. Click **Next** to confirm the IPSetup software to be installed to the computer.

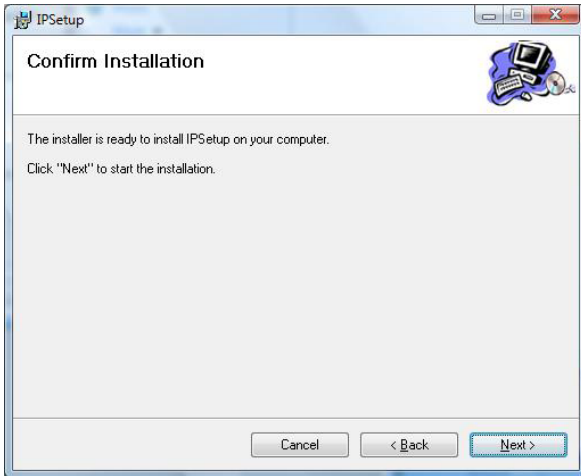

5. When the **Installation Complete** window appears, click **Close**.

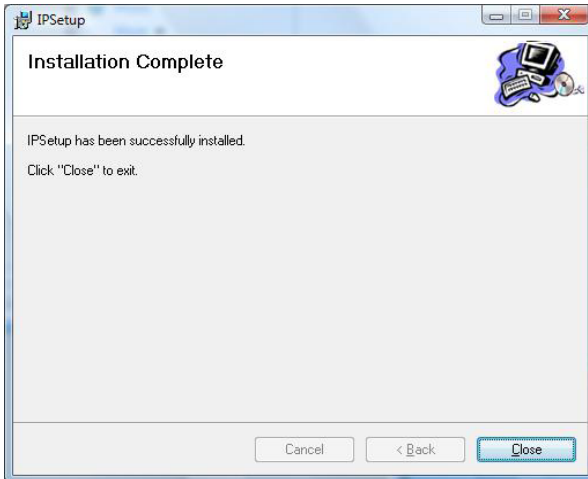

6. After installing the IPSetup Utility, the application is automatically installed to your computer, and creates a folder in **Start\Program\TRENDnet\IPSetup**.
7. Click **Start>Programs>TRENDnet>IPSetup**, and then click **IPSetup**.

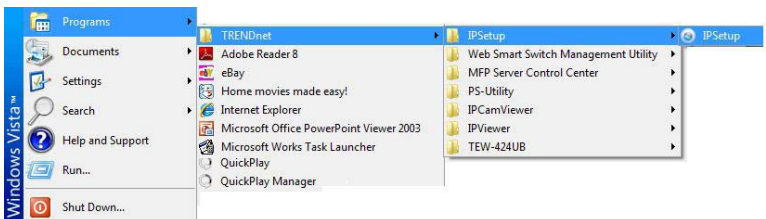

8. The IPSetup window will appear. It will search for SecurView camera(s) within the same network

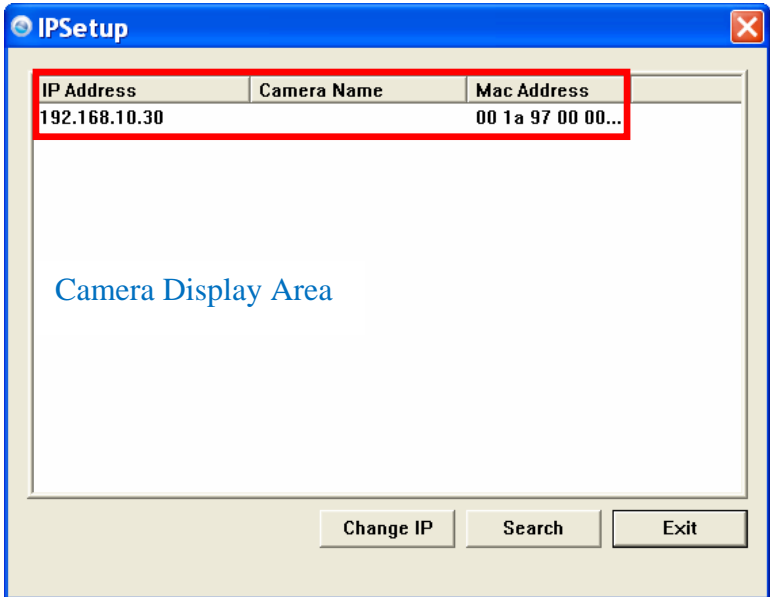

Camera Display Area: It shows the connected camera(s) within the same network.

Double click the IP Address, it will link to the Camera's Web Configuration page.

- **Change IP:** Click this button to bring up the following window. It allows you to change the IP Address. You can select either **Static IP** or click **DHCP**. Then, enter the Administrator ID & Password. By default the ID/Password is: **admin**. When complete, click **Change**.

Change IP Address

Static IP

IP Address: 192 . 168 . 10 . 30

Submask: 255 . 255 . 255 . 0

Default gateway: 192 . 168 . 10 . 1

DHCP

Administrator ID & Password

ID:

Password:

Change Exit

- **Search:** Click this button to search the connected SecurView camera(s) in the same network.
- **Exit:** Click this button to exit the program.

3.2 Accessing to the Camera

Whenever you want to access the camera:

1. Open the Web browser on your computer (example showed in the User's Guide is based on Internet Explorer).
2. Since the default configuration of the camera is DHCP mode enabled, you are recommended to launch IPSetup to search the IP address that is assigned to the camera by the DHCP server, and then click **Link** to access the camera via the Web browser. Otherwise type the default IP address (**192.168.10.30**) in the Address bar, and the press [Enter].

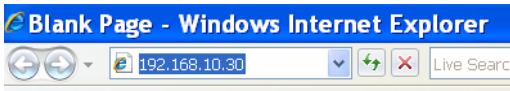

3. When the login window appears, enter the default **User name** (**admin**) and **Password** (**admin**). Then, click the **OK** button to access to the main screen of the camera's Web Configuration.

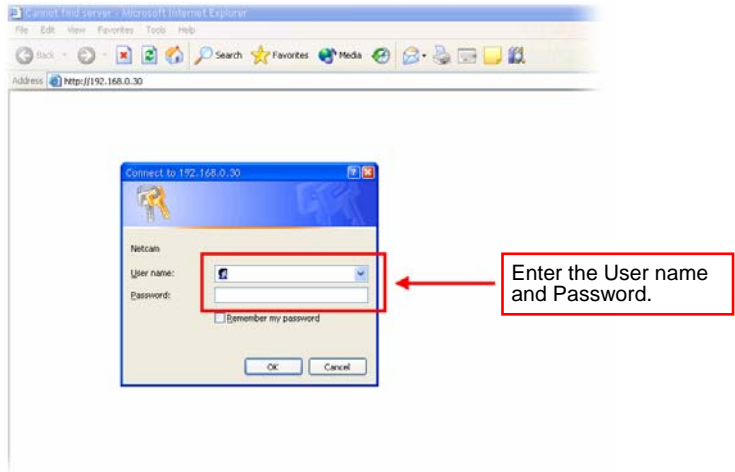

NOTE If you are initially accessing the camera, you will be asked to install a new plug-in for the camera. Permission request depends on the Internet security settings of your computer. Click **Yes** to proceed.

After you login into the Web Configuration of the camera, the Main screen will appear as below:

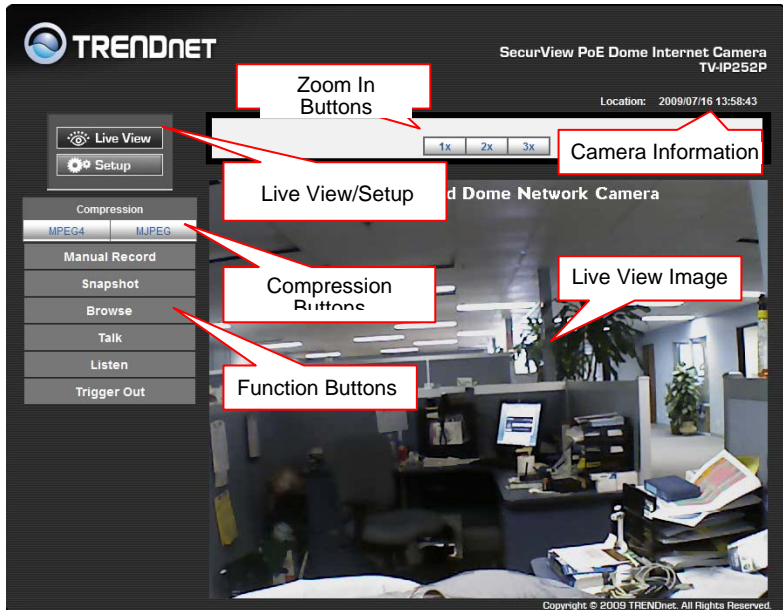

The Main page of the Web Configuration provides you with useful information and functions, including:

■ **Live View/Setup Switch:**

- Click the **Setup** button to configure the camera. For details, see Chapter 4.
- Click the **Live View** button to return to the Main screen to view the live view image.

■ **Compression Buttons:** Select to transmit and record the video using MPEG4 or MJPEG compression.

■ **Function Buttons:** Use these buttons to control the audio, video, and trigger functions.

- **Manual Record** allows you to record and save a video clip.

- **Snapshot** allows you to capture and save a still image.
 - **Browse** allows you to assign the destination folder to store the video clips and still images.
 - **Talk** allows you to speak out through the camera. Please note only one user is allowed to use this function at a time.
 - **Listen** allows you to receive the on-site sound and voice from the camera.
 - **Trigger Out** allows you to trigger on/off the GPIO output manually.
- **Live View Image:** Displays the real-time image of the connected camera.
 - **Zoom In Buttons:** Click the buttons to zoom in the live view image by 1x, 2x, and 3x.
 - **Camera Information:** Displays the camera's location and the current date & time. The information can be modified in the Web Configuration.

NOTE If your PC uses Microsoft Vista platform you may not be able to find these recorded files that are stored by **Snapshot** or **Manual Record**. If this is the case, you will need to disable the protected mode of Security in the IE Browser through the following steps:

1. Open the Internet Explorer browser.
2. Click **Tools > Internet Options**.
3. Click **Security**.
4. Disable the **Enable Protected Mode** option and then click **OK**.

3.3 Configuring the IP Address of the PC

If you have failed to access the camera, please check the IP address of your computer. When you connect the camera to your computer directly, proceed with configuration of the camera. You need to set up the IP addresses to be in the same segment for the two devices to communicate.

1. On your computer, click **Start > Control Panel** to open the Control Panel window.
2. Double-click **Network Connection** to open the Network Connection window.
3. Right-click **Local Area Connection** and then click **Properties** from the shortcut menu.
4. When the Local Area Connection Properties window appears, select the **General** tab.
5. Select **Internet Protocol [TCP/IP]** and then click **Properties** to bring up the Internet Protocol [TCP/IP] Properties window.
6. To configure a fixed IP address that is within the segment of the camera, select the **Use the following IP address** option. Then, enter an IP address into the empty field. The suggested IP address is **192.168.10.x** (x is 1~254 except 30), and the suggested Subnet mask is **255.255.255.0**.
7. When you are finished, click **OK**.

CHAPTER 4

CONFIGURING THE CAMERA

4.1 Using the Web Configuration

You can access and manage the camera through the Web browser and the provided software application SecurView™ (see chapter 5 in more detail). This chapter describes the Web Configuration, and guides you through the configuration of the camera by using the web browser.

To configure the camera, click **Setup** on the Main page of Web Configuration. The Web Configuration will start from the **Basic** page.

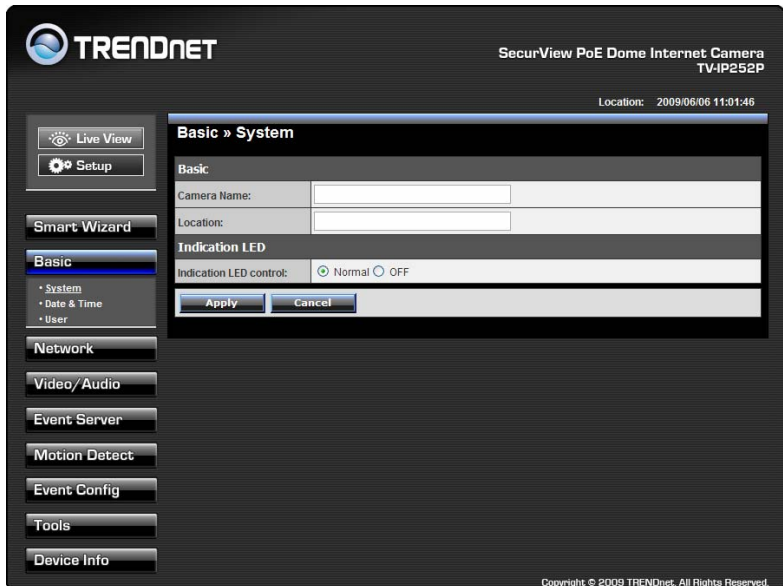

The Web Configuration contains the settings that are required for the camera in the left menu bar, including **Smart Wizard, Basic, Network, Video/Audio, Event Server, Motion detect, Event Config, Tools, USB, and Information.**

4.2 Using Smart Wizard

The camera's Smart Wizard lets you configure your camera quickly and easily. The wizard will guide you through the necessary settings with detailed instructions on each step.

To start the wizard, click **Smart Wizard** in the left menu bar.

Step 1. Camera Setting

TRENDNET SecurView PoE Dome Internet Camera TV-IP252P
Location: 2009/06/06 11:04:03

Welcome to the Smart Wizard.
This wizard will help you quickly set up the Network Camera to run on your network.

Camera Settings

Camera Name: Enter a descriptive name for the camera. For example, camera 1.

Location: Enter a descriptive name for the location used by the camera. For example, meeting room 1.

Admin Password/Confirm Password: Enter the administrator password twice to set and confirm the password to access the camera's Configuration Utility.

Camera Settings

Camera Name:	<input type="text"/>	Enter the name and location for the camera.
Location:	<input type="text"/>	
Admin Password:	<input type="password"/>	Enter the administrator password twice.
Confirm Password:	<input type="password"/>	

Next > Cancel

Copyright © 2009 TRENDnet. All Rights Reserved.

Step 2. IP Setting

Select the IP setting according to your network: **DHCP, Static IP, or PPPoE.**

TRENDNET SecurView PoE Dome Internet Camera TV-IP252P
Location: 2009/06/08 11:04:48

IP Settings

DHCP: Select this option when your network uses the DHCP server. When the camera starts up, it will be assigned an IP address from the DHCP server automatically.

Static IP: Select this option to assign the IP address for the camera directly. You can use IP Finder to obtain the related setting values.

Example:

- IP Address: For example, enter the default setting 192.168.10.30
- Subnet Mask: For example, enter the default setting 255.255.255.0
- Default Gateway: For example, enter the default setting 192.168.10.1
- Primary/Secondary DNS: Enter the DNS that are provided by your ISP.

IP Settings

DHCP
 Static IP

IP:

Subnet Mask:

Default Gateway:

Primary DNS:

Secondary DNS:

PPPoE

User Name:

Password:

< Prev Next > Cancel

Step 3. Email Settings

Enter the required information to be able to send email with image.

TRENDNET SecurView PoE Dome Internet Camera TV-IP252P
Location: 2009/06/08 11:05:32

Email Setting

SMTP Server Address: Enter the mail server address. For example, mymail.com.

Port Number: Enter the mail server port number.

Sender Email Address: Enter the email address of the user who will send the email. For example, John@mymail.com.

Authentication Mode: If the mail server needs to login, please select SMTP.

Sender User Name: Enter the user name to login the mail server.

Sender Password: Enter the password to login the mail server.

Email Setting

SMTP Server Address:

Port Number:

Sender Email Address:

Authentication Mode: None SMTP

Sender User Name:

Sender Password:

Receiver #1 Email Address:

Receiver #2 Email Address:

< Prev Next > Cancel

Step 4. Confirm Settings

SecurView PoE Dome Internet Camera
TV-IP252PLocation: 2009/06/06 11:07:37

Confirm Settings

Please confirm the configuration you have set up.
When you confirm the settings, click **Apply** to finish the wizard and reboot the camera. Otherwise, click **prev** to go back to the previous step(s) and change the settings; or click **Cancel** to end the wizard and discard the changes.

Please note that the camera's IP Address will be updated if you changed the IP setting. This may cause the camera to lose the image screen. If this happens, use the supplied IP Finder software application to locate the camera's IP Address. Then, connect to the camera to resume the image screen.

Confirm Settings

Camera Name:	
Location:	
IP Mode:	DHCP
IP Address:	192.168.10.30
Subnet Mask:	255.255.255.0
Default Gateway:	192.168.10.1
Primary DNS:	
Secondary DNS:	
SMTP Server Address:	smtp.live.com
Port Number:	25
Sender Email Address:	j-cooper@live.com
Authentication Mode:	SMTP
Sender User Name:	j-cooper@live.com
Receiver #1 Email Address:	j.vieyra@trendnet.com
Receiver #2 Email Address:	

< Prev Apply Cancel

The last step shows the configuration of your camera. When you confirm the settings, click **Apply** to finish the wizard and reboot the camera. Otherwise, click **Prev** to go back to the previous step(s) and change the settings; or click **Cancel** to end the wizard and discard the changes.

4.3 Basic Setup

The Basic menu contains three sub-menus that provide the **System settings** for the camera, such as the Camera Name, Location, **Date & Time**, and **User management**.

The screenshot shows the web interface for a TRENDNET SecurView PoE Dome Internet Camera (TV-IP252P). The interface includes a navigation sidebar on the left with options like Live View, Setup, Smart Wizard, Basic, Network, Video/Audio, Event Server, Motion Detect, Event Config, Tools, and Device Info. The main content area is titled "Basic » System" and contains the following configuration fields:

- Basic**
 - Camera Name: [Text Input Field]
 - Location: [Text Input Field]
- Indication LED**
 - Indication LED control: Normal OFF

At the bottom of the configuration area are "Apply" and "Cancel" buttons. The interface also shows the date and time as "Location: 2009/06/06 11:10:39" and a copyright notice "Copyright © 2009 TRENDnet. All Rights Reserved."

■ Basic >> System

This is a close-up view of the "Basic » System" configuration page. It displays the same fields as the previous screenshot:

- Basic**
 - Camera Name: [Text Input Field]
 - Location: [Text Input Field]
- Indication LED**
 - Indication LED control: Normal OFF

"Apply" and "Cancel" buttons are visible at the bottom.

- **Basic:** This item allows you to assign the camera name and location information.
 - **Camera Name:** Enter a descriptive name for the camera.
 - **Location:** Enter a descriptive name for the location where the camera is monitored.
- **Indication LED:** This item allows you to set the LED illumination as desired. There are two options: **Normal** and **OFF**.

■ Basic >> Date & Time

Basic » Date & Time

Date and Time

TimeZone: (GMT) Greenwich Mean Time : Dublin, Edinburgh, Lisbon, London ▼

Setting:

Synchronize with PC
 Synchronize with NTP Server

NTP Server Address:

Update Interval: 6 ▼ hours

Manual

Date: 2009/06/06 (YYYY/MM/DD)

Time: 11:13:06 (hh:mm:ss)

- **Date & Time:** Enter the correct date and time for the system.
 - **TimeZone:** Select the proper time zone for the region from the pull-down menu.

- **Synchronize with PC:** Select this option and the date & time settings of the camera will be synchronized with the connected computer.
- **Synchronize with NTP Server:** Select this option and the time will be synchronized with the NTP Server. You need to enter the IP address of the server and select the update interval in the following two boxes.
- **Manual:** Select this option to set the **Date** and **Time** manually.

■ Basic >> User

Basic » User	
User Accounts	
Administrator:	Password: <input type="text"/> Confirm Password: <input type="text"/> <input type="button" value="Modify"/>
General User:	User Name: <input type="text"/>
	Password: <input type="text"/> <input type="button" value="Add/Modify"/>
	UserList: <input type="button" value="v"/> <input type="button" value="Delete"/>
Guest:	User Name: <input type="text"/>
	Password: <input type="text"/> <input type="button" value="Add/Modify"/>
	UserList: <input type="button" value="v"/> <input type="button" value="Delete"/>

- **Administrator:** To prevent unauthorized access to the camera's Web Configuration, you are strongly recommended to change the default administrator

password. Type the administrator password twice to set and confirm the password.

● **General User**

- **User Name:** Enter the user's name you want to add to use the camera.

- **Password:** Enter the password for the new user.

When you are finished, click **Add/Modify** to add the new user to the camera. To modify the user's information, select the one you want to modify from **UserList** and click **Add/Modify**.

- **UserList:** Display the existing users of the camera. To delete a user, select the one you want to delete and click **Delete**.

● **Guest**

- **User Name:** Enter the guest's name you want to add to use the camera.

- **Password:** Enter the password for the new guest.

- **UserList:** Display the existing guests of the camera. To delete a user, select the one you want to delete and click **Delete**.

NOTE The "General User" is allowed to access the camera and control the Function buttons on the Main screen of the Web Configuration. The "Guest" can only view the live view image from the Main screen while accessing the camera. Only the "Administrator" is allowed to configure the camera through the Web Configuration. You can have up to 11 Accounts between the General and Guest Accounts.

4.4 Network Settings

The Network menu contains two sub-menus that provide the **Networking settings** for the camera, such as the IP Setting, DDNS Setting, and **IP Filter**.

The screenshot displays the web interface for the TrendNet SecurView PoE Dome Internet Camera TV-IP252P. The top navigation bar includes the TrendNet logo, the device name, and the location/time: "Location: 2009/06/06 11:20:52". On the left, a sidebar menu contains options like "Live View", "Setup", "Smart Wizard", "Basic", "Network" (selected), "Video/Audio", "Event Server", "Motion Detect", "Event Config", "Tools", and "Device Info". The main content area is titled "Network » Network" and is divided into several sections:

- IP Settings:** Includes radio buttons for "DHCP" (selected) and "Static IP". Under "Static IP", there are input fields for IP (192, 168, 10, 30), Subnet Mask (255, 255, 255, 0), Default Gateway (192, 168, 10, 1), Primary DNS, and Secondary DNS. There are also fields for "PPPoE" User Name and Password.
- DDNS Setting:** Includes a checkbox for "Enable", a dropdown menu for "Provider" (set to "members.dyndns.org"), and input fields for "Host Name", "User Name", and "Password".
- UPnP:** Includes a checkbox for "Enable".
- Bonjour:** Includes a checked checkbox for "Enable" and an input field for "Friendly Name".
- Ports Number:** Includes input fields for "HTTP Port" (80, default: 80) and "RTSP Port" (554, default: 554).

At the bottom of the main content area, there are "Apply" and "Cancel" buttons. The footer of the page contains the copyright notice: "Copyright © 2009 TRENDnet. All Rights Reserved."

■ Network >> Network

Network » Network	
Network	
IP Settings:	<p><input checked="" type="radio"/> DHCP</p> <p><input type="radio"/> Static IP</p> <p>IP: <input type="text" value="192"/> . <input type="text" value="168"/> . <input type="text" value="10"/> . <input type="text" value="30"/></p> <p>Subnet Mask: <input type="text" value="255"/> . <input type="text" value="255"/> . <input type="text" value="255"/> . <input type="text" value="0"/></p> <p>Default Gateway: <input type="text" value="192"/> . <input type="text" value="168"/> . <input type="text" value="10"/> . <input type="text" value="1"/></p> <p>Primary DNS: <input type="text"/> . <input type="text"/> . <input type="text"/> . <input type="text"/></p> <p>Secondary DNS: <input type="text"/> . <input type="text"/> . <input type="text"/> . <input type="text"/></p> <p><input type="radio"/> PPPoE</p> <p>User Name: <input type="text"/></p> <p>Password: <input type="text"/></p>
DDNS Setting:	<p><input type="checkbox"/> Enable</p> <p>Provider: <input type="text" value="members.dyndns.org"/> ▼</p> <p>Host Name: <input type="text"/></p> <p>User Name: <input type="text"/></p> <p>Password: <input type="text"/></p>
UPnP:	<p><input type="checkbox"/> Enable</p>
Bonjour:	<p><input checked="" type="checkbox"/> Enable</p> <p>Friendly Name: <input type="text"/></p>
Ports Number:	<p>HTTP Port: <input type="text" value="80"/> (default: 80)</p> <p>RTSP Port: <input type="text" value="554"/> (default: 554)</p>
<p><input type="button" value="Apply"/> <input type="button" value="Cancel"/></p>	

● **IP Setting:** This item allows you to select the IP address mode and set up the related configuration.

- **DHCP:** Select this option when your network uses the DHCP server. When the camera starts up, it will be

assigned an IP address from the DHCP server automatically.

- **Static IP:** Select this option to assign the IP address for the camera directly. You can use IPSetup to obtain the related setting values.

IP	Enter the IP address of the camera. The default setting is 192.168.10.30 .
Subnet Mask	Enter the Subnet Mask of the camera. The default setting is 255.255.255.0 .
Default Gateway	Enter the Default Gateway of the camera. The default setting is 192.168.10.1 .
Primary/Secondary DNS	DNS (Domain Name System) translates domain names into IP addresses. Enter the Primary DNS and Secondary DNS that are provided by ISP.

- **PPPoE:** Select this option when you use a direct connection via the ADSL modem. You should have a PPPoE account from your Internet service provider. Enter the **User Name** and **Password**. The camera will get an IP address from the ISP as starting up.

NOTE Once the camera receives an IP address from the ISP after starting up, it automatically sends a notification email to you. Therefore, when you select PPPoE as your connecting type, you have to set up the email or DDNS configuration in advance.

- **DDNS Setting:** With the Dynamic DNS feature, you can assign a fixed host and domain name to a dynamic Internet IP address. To set up the DDNS:

1. Select the **Enable** option to enable this feature.
2. Select the **Provider** from the pull-down list.

3. Enter the required information in the **Host Name**, **User Name**, and **Password** boxes.

NOTE You have to sign up for DDNS service with the service provider before configuring this feature.

- **UPnP:** The camera supports UPnP (Universal Plug and Play), which is a set of computer network protocols that enable the device-to-device interoperability. In addition, it supports port auto mapping function so that you can access the camera if it is behind an NAT router or firewall.

Select the **Enable** option to enable this feature.

- **Ports Number**

- **HTTP Port:** The default HTTP port is **80**.

- **RTSP Port:** Configure the transmission of streaming data within the network. The default RTSP (Real Time Streaming Protocol) port is **554**.

NOTE If the camera is behind a NAT router or firewall, the suggested ports to be used are from 1024 to 65535.

■ Network >> IP Filter

Network » IP Filter	
IP Filter	
Disable:	<input checked="" type="radio"/>
Accept:	<input type="radio"/>
	Start: <input type="text"/> . <input type="text"/> . <input type="text"/> . <input type="text"/>
	End: <input type="text"/> . <input type="text"/> . <input type="text"/> . <input type="text"/> <input type="button" value="Add"/>
Accept IP List:	<input type="button" value="v"/> <input type="button" value="Delete"/>
Deny:	<input type="radio"/>
	Start: <input type="text"/> . <input type="text"/> . <input type="text"/> . <input type="text"/>
	End: <input type="text"/> . <input type="text"/> . <input type="text"/> . <input type="text"/> <input type="button" value="Add"/>
Deny IP List:	<input type="button" value="v"/> <input type="button" value="Delete"/>
<input type="button" value="Apply"/> <input type="button" value="Cancel"/>	

The IP Filter setting allows the administrator to limit the users within a certain range of IP addresses to have access to the camera.

To disable this feature, select the **Disable** option; otherwise, select the **Accept** option to assign the range of IP addresses that are allowed to access the camera, or select the **Deny** option to assign the range of IP addresses that are blocked to access the camera.

- **Accept**

- **Start/End IP Address:** Assign a range of IP addresses that are allowed to access the camera by entering the **Start IP address** and **End IP address** options. When you are finished, click **Add** to save the range setting. You can repeat the action to assign multiple ranges for the camera.

For example, when you enter 192.168.10.50 in Start IP Address and 192.168.10.80 in End IP Address, the user whose IP address located within 192.168.10.50 ~ 192.168.10.80 will not be allowed to access the camera.

- **Accept IP List:** The list displays the range setting(s) of IP addresses that are allowed to access the camera. To clear the setting, select a range of IP addresses from the list and click **Delete**.

● Deny

- **Start/End IP Address:** Assign a range of IP addresses that are blocked to access the camera by entering the **Start IP address** and **End IP address** options. When you are finished, click **Add** to save the range setting. You can repeat the action to assign multiple ranges for the camera.

For example, when you enter 192.168.10.50 in Start IP Address and 192.168.10.80 in End IP Address, the user whose IP address located within 192.168.10.50 ~ 192.168.0.80 will not be allowed to access the camera.

- **Deny IP List:** The list displays the range setting(s) of IP addresses that are blocked to access the camera. To clear the setting, select a range of IP addresses from the list and click **Delete**.

4.5 Setting up Video & Audio

The Video & Audio menu contains four sub-menus that provide the video and audio settings for the camera.

The screenshot shows the web interface for a TrendNet SecurView PoE Dome Internet Camera (TV-IP252P). The interface includes a sidebar with navigation options: Live View, Setup, Smart Wizard, Basic, Network, Video/Audio (selected), Event Server, Motion Detect, Event Config, Tools, and Device Info. The main content area is titled "Video & Audio » Camera" and features a live video feed of an office interior. Below the feed is the "Image Setting" panel with the following controls:

Brightness:	<input type="text" value="22"/>	(0~100)
Saturation:	<input type="text" value="100"/>	(0~100)
Sharpness:	<input type="text" value="30"/>	(0~100) <input type="button" value="Default"/>
Mirror:	<input type="checkbox"/> Vertical <input type="checkbox"/> Horizontal	

At the bottom of the Image Setting panel are "Apply" and "Cancel" buttons. The interface also shows the TrendNet logo, the camera model name, and the location/time: "Location: 2009/06/06 11:29:14". A copyright notice at the bottom right reads "Copyright © 2009 TRENDNET. All Rights Reserved."

■ Video & Audio >> Camera

This is a close-up view of the "Image Setting" panel from the camera interface. It contains the following settings:

Brightness:	<input type="text" value="22"/>	(0~100)
Saturation:	<input type="text" value="100"/>	(0~100)
Sharpness:	<input type="text" value="30"/>	(0~100) <input type="button" value="Default"/>
Mirror:	<input type="checkbox"/> Vertical <input type="checkbox"/> Horizontal	

At the bottom of the panel are "Apply" and "Cancel" buttons.

● Image Setting

- **Brightness:** Adjust the brightness level from 0 ~ 100.
- **Saturation:** Adjust the colors level from 0 ~ 100.
- **Sharpness:** Adjust the sharpness level from 0 ~ 100.
Click **Default** to restore the default settings of the three options above.
- **Mirror:** Select **Vertical** to mirror the image vertically, or select **Horizontal** to mirror the image horizontally.

■ Video & Audio >> Video

Video & Audio » Video	
MPEG4	
Video Resolution:	VGA
Video Quality:	Highest
Frame Rate:	30 fps
MJPEG	
Video Resolution:	VGA
Video Quality:	High
Frame Rate:	30 fps
3GPP	
Setting:	<input checked="" type="radio"/> Disable <input type="radio"/> 3GPP Without Audio <input type="radio"/> 3GPP With Audio
<input type="button" value="Apply"/> <input type="button" value="Cancel"/>	

● MPEG4

- **Video Resolution:** Select the desired video resolution from the three formats: **VGA**, **QVGA**, and **QQVGA**. The higher setting (VGA) obtains better video quality while it uses more resource within your network.
- **Video Quality:** Select the desired image quality from five levels: **Lowest**, **Low**, **Medium**, **High**, and **Highest**.
- **Frame Rate:** Select **Auto** or a proper setting depending on your network status.

● **MJPEG**

- **Video Resolution:** Select the desired video resolution from the three formats: **VGA**, **QVGA**, and **QQVGA**. The higher setting (VGA) obtains better video quality while it uses more resource within your network.
- **Video Quality:** Select the desired image quality from five levels: **Lowest**, **Low**, **Medium**, **High**, and **Highest**.
- **Frame Rate:** Select **Auto** or a proper setting depending on your network status.

NOTE The camera supports both MPEG4 and MJPEG compression. MJPEG capture the images in JPEG format, which require higher bandwidth to view smooth video. The administrator can control the bandwidth of each connection well through the setting options above.

- **3GPP:** The camera supports 3GPP specification. To disable this feature, select the **Disable** option; otherwise,

select **3GPP Without Audio** or **3GPP With Audio** to transfer the video clips without or with audio.

If you use a mobile phone that supports 3GPP, you can also view the real-time streaming image captured by the camera on your phone (with the default player on the phone) by entering the RTSP link:

[rtsp://\(IP address of the camera\)/3gp](rtsp://(IP address of the camera)/3gp).

■ Video & Audio >> Audio

Video & Audio » Audio	
Camera Microphone In	
Enable	<input checked="" type="checkbox"/>
Camera Speaker Out	
Enable	<input checked="" type="checkbox"/>
Volume:	<input type="text" value="90"/>
<input type="button" value="Apply"/> <input type="button" value="Cancel"/>	

- **Camera Microphone In:** Select the **Enable** option to enable the camera's audio function, so that you can receive the on-site sound and voice from the camera.
- **Camera Speaker Out:** Select the **Enable** option to enable the camera's external speaker function, so that the connected speaker can play the sound and voice through the camera.

You can set the speaker's volume by entering the proper value in the **Volume** option. The default setting is **90**.

■ Video & Audio >> Text Overlay

Text Overlay » Text Overlay

Overlay Setting

Include Date & Time	<input type="checkbox"/>
Include Text	<input type="checkbox"/> Fixed Dome Network Camera
Enable Opaque	<input type="checkbox"/>

- **Overlay Setting:** This option allows you to set the overlay function of the camera, so that you can see the related information on the live view image.
 - **Includes Date & Time:** Select this option to display the date & time stamp on the live view image.
 - **Include Text:** Select this option and enter your heading text in the box to display the text information on the live view image.
 - **Enable Opaque:** Select this option to set a black background to the displayed date & time stamp.

4.6 Event Server Configuration

The Event Server menu contains three sub-menus that allow you to upload images to **FTP**, send **Emails** that include still images, and store the images to a **NAS system**.

When you complete the required settings for FTP, Email, or Network Storage, click **Test** to test the related configuration is correct or not. Once the camera connects to the server successfully, click **Apply**.

The screenshot displays the web interface for a Trendnet SecurView PoE Dome Internet Camera (TV-IP252P). The interface is in dark theme. At the top left is the Trendnet logo. At the top right, it shows the device name and IP address, and the current location and time: "Location: 2009/06/06 11:44:09".

The left sidebar contains a navigation menu with the following items: "Live View", "Setup", "Smart Wizard", "Basic", "Network", "Video/Audio", "Event Server" (highlighted), "FTP" (sub-item), "Email" (sub-item), "Network Storage" (sub-item), "Motion Detect", "Event Config", "Tools", and "Device Info".

The main content area is titled "Event Server Setting >> FTP". It contains the following configuration fields:

- Host Address: [Empty text box]
- Port Number: 21
- User Name: [Empty text box]
- Password: [Empty text box]
- Directory Path: [Empty text box]
- Passive Mode: Enable
- FTP Upload With: One Snapshot
- Pre-event 3 sec(s) Post-event 2 sec(s)

At the bottom of the configuration area are three buttons: "Test", "Apply", and "Cancel".

At the bottom right of the interface, it says "Copyright © 2009 TRENDnet. All Rights Reserved."

■ Event Server Setting >> FTP

Event Server Setting » FTP	
FTP	
Host Address:	<input type="text"/>
Port Number:	<input type="text" value="21"/>
User Name:	<input type="text"/>
Password:	<input type="text"/>
Directory Path:	<input type="text"/>
Passive Mode:	<input checked="" type="checkbox"/> Enable
FTP Upload With:	<input checked="" type="radio"/> One Snapshot
	<input type="radio"/> Pre-event <input type="text" value="3"/> sec(s) Post-event <input type="text" value="2"/> sec(s)
<input type="button" value="Test"/> <input type="button" value="Apply"/> <input type="button" value="Cancel"/>	

● FTP

- **Host Address:** Enter the IP address of the target FTP server.
- **Port Number:** Enter the port number used for the FTP server.
- **User Name:** Enter the user name to login into the FTP server.
- **Password:** Enter the password to login into the FTP server.
- **Directory Path:** Enter the destination folder for uploading the images. For example, **/Test/**.
- **Passive Mode:** Select the **Enable** option to enable passive mode.
- **FTP Upload With:** Set the format of the image that is to be uploaded to the FTP server. You can set the

format as **One Snapshot** or images containing **Pre-event** (0 ~ 3) seconds and **Post-event** (0 ~ 3) seconds.

■ Event Server Setting >> Email

Event Server Setting » Email	
Email	
SMTP Server Address:	<input type="text" value="smtp.live.com"/>
Port Number:	<input type="text" value="25"/> <input checked="" type="checkbox"/> This server requires an encrypted connection (SSL)
Sender Email Address:	<input type="text" value="j-cooper@live.com"/>
Authentication Mode:	<input type="radio"/> None <input checked="" type="radio"/> SMTP
Sender User Name:	<input type="text" value="j-cooper@live.com"/>
Sender Password:	<input type="password" value="*****"/>
Receiver #1 Email Address:	<input type="text" value="j.vieyra@trendnet.com"/>
Receiver #2 Email Address:	<input type="text"/>
Send Email With:	<input checked="" type="radio"/> One Snapshot <input type="radio"/> Pre-event <input type="text" value="3"/> sec(s) Post-event <input type="text" value="2"/> sec(s)
<input type="button" value="Test"/> <input type="button" value="Apply"/> <input type="button" value="Cancel"/>	

● Email

- **SMTP Server Address:** Enter the mail server address. For example, mymail.com.
- **Sender Email Address:** Enter the email address of the user who will send the email. For example, John@mymail.com.
- **Authentication Mode:** Select **None** to disable the authentication feature, or select **SMTP** and then enter

the **User Name** and **Password** according to the mail server configuration.

- **Sender User Name:** Enter the user name to login the mail server.
- **Sender Password:** Enter the password to login the mail server.
- **Receiver #1 Email Address:** Enter the first email address of the user who will receive the email.
- **Receiver #2 Email Address:** Enter the second email address of the user who will receive the email.
- **Send Email With:** Set the format of the image that is to be sent by the email. You can set the format as **One Snapshot** or images containing **Pre-event** (0 ~ 3) seconds and **Post-event** (0 ~ 3) seconds.

■ Event Server Setting >> Network Storage

Event Server Setting » Network Storage	
Network Storage	
Samba Server Address:	<input type="text"/>
Share:	<input type="text"/>
Path:	<input type="text"/>
User Name:	<input type="text"/> <input checked="" type="checkbox"/> Anonymous
Password:	<input type="text"/>
Split By:	<input checked="" type="radio"/> File Size <input type="text" value="100"/> (MB)
	<input type="radio"/> Recording Time <input type="text" value="30"/> (Minutes)
When Disk Full:	<input type="radio"/> Stop Recording
	<input checked="" type="radio"/> Recycle - Delete Oldest Folder
<input type="button" value="Test"/> <input type="button" value="Apply"/> <input type="button" value="Cancel"/>	

● Network Storage

- **Samba Server Address:** Enter the IP address of the Network Storage server.
- **Share:** Assign the folder on the Network Storage server to share the files to users.
- **Path:** Assign the path for uploading the files on the Network Storage server. For example, **/Test/**.
- **User Name:** Enter the user name to login into the Network Storage server.
- **Password:** Enter the password to login into the Network Storage server.
- **Split By:** When the file is too large to upload smoothly, use this option to split it by selecting **File Size** or **Recording Time**.
- **When Disk Full:** Select **Stop Recording** or **Recycle – Delete Oldest Folder** when the storage space on the Network Storage server is full.

NOTE If you have enabled **Recording to Storage** feature, after the camera boots up completely, it will mount to the storage server. If the storage server is not available at the time, the camera will remount every **5 minutes for an hour** (12 times) and then stop remounting.

4.7 Motion Detect

The Motion Detect menu contains the command and option that allow you to enable and set up the motion detection feature of the camera. The camera provides two detecting areas.

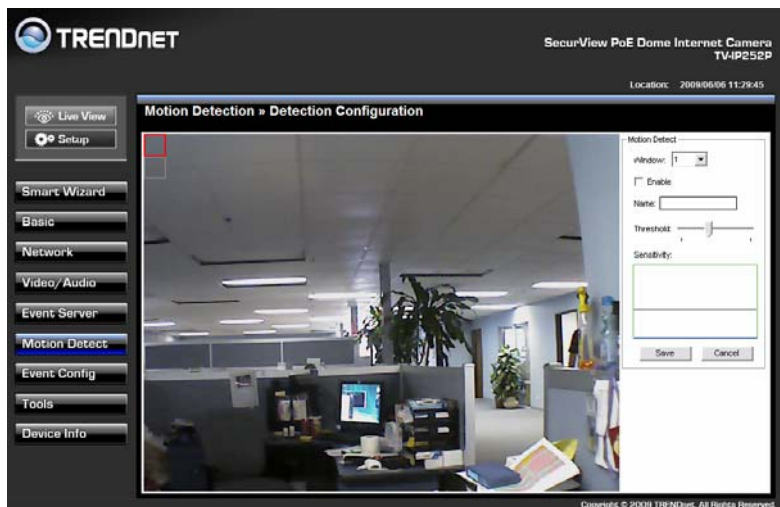

To enable the detecting area, select **Window 1** or **2** from the pull-down list, and then select **Enable**. When the detecting area is enabled, you can use the mouse to move the detecting area and change the area coverage.

- **Name:** Assign a name to the detecting area.
- **Threshold:** Move the slide bar to adjust the level for detecting motion to record video.

4.8 Event Config

The Event Config menu contains five sub-menus that provide the commands to configure event profiles.

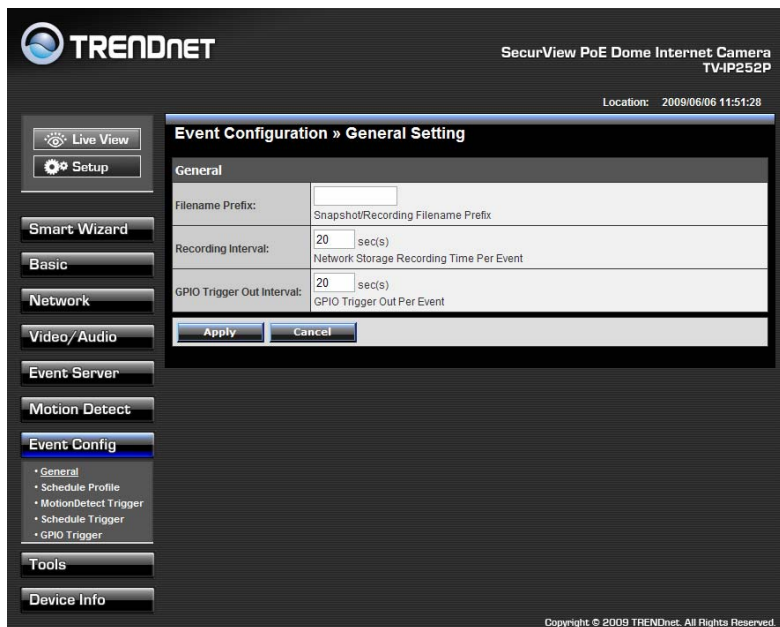

■ Event Configuration >> General Setting

● General

- **Snapshot/Recording Subfolder:** You can assign a given subfolder to each new captured file. Otherwise, leave this option blank to use the default setting.
- **Network Storage Recording Time Per Event:** Limit the recording time while you are using the Network Storage solution.

- **GPIO Trigger Out Retention Time Per Event:** Limit the retention time of the GPIO Trigger Out function.

■ Event Configuration >> Arrange Schedule Profile

Event Configuration >> Arrange Schedule Profile

Schedule Profile

Schedule

Add Delete

Profile Name: Schedule

Weekdays: Sun Mon Tue Wed Thu Fri Sat

Time List:

Add Copy this to all weekdays

Delete Delete this from all weekdays

Start Time: :

End Time: :

Save Cancel

- **Schedule Profile:** This sub-menu displays the scheduled profile(s). To customize the profile, click **Add** and then enter a descriptive name for the profile in the prompt dialog window.
- After entering the profile name, click **OK** and the profile is added to the Schedule Profiles list. To delete the profile, select the profile in the list and click **Delete**.

- **Profile Name:** Display the profile name that you select in the Schedule Profiles list.
- **Weekdays:** Select the weekday(s) that you want to separately assign in the schedule profile. The weekday that has been assigned will be displayed with green color.
- **Time List:** Display the time period that you have assigned within the selected weekday. To assign the same time period to every weekday, click **Add this to all weekdays**; click **Delete this from all weekdays** to remove the selected time period from every weekday. Click Delete to remove the selected time period.
- **Start/End Time:** Enter the start and end time and then click **Add** to assign a time period within in the selected weekday.

■ Event Configuration >> Motion Detect Trigger

Event Configuration » Motion Detect Trigger	
Motion Detect Trigger (*Please set the corresponding server setting first)	
Enable	<input type="checkbox"/>
Schedule Profile:	always ▾
Action:	<input type="checkbox"/> Trigger Out <input type="checkbox"/> Record to Network Storage <input type="checkbox"/> Send Email <input type="checkbox"/> FTP Upload
<input type="button" value="Apply"/> <input type="button" value="Cancel"/>	

- **Schedule Profile:** Select the **Enable** option to enable the trigger function of the camera, so that you can send

captured images within the detecting area to the FTP server, email receiver, Network Storage server, or the connected USB device. You have to configure corresponding settings, such as FTP server and email server, to enable this feature. Please note that you have to configure the related settings before enabling these features.

- **Schedule Profile:** Select a schedule profile from the pull-down list.
- **Action:** Select the destination that the captured images will be sent to: **Trigger Out**, **Record to Network Storage**, **Send Email**, and **FTP Upload**.

■ Event Configuration >> Schedule Trigger

Event Configuration > Schedule Trigger	
Email Schedule	
Enable	<input type="checkbox"/>
Schedule Profile:	always ▾
Interval:	20 sec(s)
FTP Schedule	
Enable	<input type="checkbox"/>
Schedule Profile:	always ▾
Interval:	30 sec(s)
Network Storage Schedule	
Enable	<input type="checkbox"/>
Schedule Profile:	always ▾
Interval:	30 sec(s)
<input type="button" value="Apply"/> <input type="button" value="Cancel"/>	

You can separately configure the schedule for trigger function of the camera by **Email**, **FTP**, or **Network Storage**. Select

the **Enable** option on each item, and then select a **Schedule Profile** from the pull-down list and set the **Interval** time.

NOTE If the setting value of the **Network Storage Recording Time Per Event** option in General Setting is longer than the **Interval** time in Network Storage Schedule, the recorded file will be a continuous video clip.

For example, if you set the **Network Storage Recording Time Per Event** as 10 seconds and the **Interval** as 5 seconds, recorded file becomes a non-stop video clip because the camera will record a 10-second video clip every 5 seconds.

■ Event Configuration >> GPIO Trigger

Event Configuration » GPIO Trigger	
GPIO Trigger	
Enable Trigger In 1	<input type="checkbox"/>
Schedule Profile:	always ▾
Action:	<input type="checkbox"/> Trigger Out <input type="checkbox"/> Record to Network Storage <input type="checkbox"/> Send Email <input type="checkbox"/> FTP Upload
Enable Trigger In 2	<input type="checkbox"/>
Schedule Profile:	always ▾
Action:	<input type="checkbox"/> Trigger Out <input type="checkbox"/> Record to Network Storage <input type="checkbox"/> Send Email <input type="checkbox"/> FTP Upload
<input type="button" value="Apply"/> <input type="button" value="Cancel"/>	

The GPIO trigger function of the camera allows you to set Trigger Out function or send captured images within the

detecting area to the Network Storage server, email receiver, or FTP server. You have to configure corresponding settings, such as FTP server and email server, to enable this feature.

- **Enable Trigger In 1/2:** Select the option to enable the GPIO trigger function of the camera. Then, complete the following options
 - **Schedule Profile:** Select a schedule profile (**Always**, or the profile you have set) from the pull-down list.
 - **Action:** Select the **Trigger Out** function or select the destination of the captured image (**Record to Network Storage, Send Email, or FTP Upload**).

4.9 Tools

The Tools menu provides the commands that allow you to restart or reset the camera. You can also backup and restore your configuration, and upgrade the firmware for the camera.

The screenshot displays the web interface for a Trendnet SecurView PoE Dome Internet Camera (TV-IP252P). The interface is dark-themed with a sidebar on the left containing navigation buttons: Live View, Setup, Smart Wizard, Basic, Network, Video/Audio, Event Server, Motion Detect, Event Config, Tools (highlighted), and Device Info. The main content area is titled 'System Tools » Tools' and contains three sections: 'Factory Reset' with a 'Reset' button; 'System Reboot' with a 'Reboot' button; and 'Configuration' with a 'Get the backup file' button, a text input field, a 'Browse...' button, and a 'Restore' button. Below this is the 'Update Firmware' section, showing the current version as '1.0.0 build:49', a 'Select the firmware:' text input field, a 'Browse...' button, and an 'Update' button. The top right corner shows the location and time: 'Location: 2009/06/06 11:56:22'. The bottom right corner has a copyright notice: 'Copyright © 2009 TRENDnet. All Rights Reserved.'

- **Factory Reset:** Click **Reset** to restore all factory default settings for the camera.
- **System Reboot:** Click **Reboot** to restart the camera just like turning the device off and on. The configuration of the camera will be retained after rebooting.
- **Configuration:** You can save your camera configuration as a backup file on your computer. Whenever you want to

resume the original settings, you can restore them by retrieving the backup file.

- **Backup:** Click **Get the backup file** to save the current configuration of the camera.
- **Restore:** Click **Browse** to locate the backup file and then click **Restore**.
- **Update Firmware:** You can upgrade the firmware for your camera once you obtained a latest version of firmware.
 - **Current Firmware Version:** This item displays the current firmware version.
 - **Select the firmware:** Click **Browse** to locate the backup file and then click **Update**.

WARNING: Firmware upgrade failure may permanently damage the unit and cause it to malfunction. Do not interrupt the firmware upgrade process by disconnecting it from the network or unplugging its power from the power outlet once the firmware upgrade process has begun. Never perform a firmware upgrade over wireless connections or via remote access connections.

4.10 Information

The Information menu displays the current configuration and events log of the camera.

The screenshot shows the web interface of a TRENDNET SecurView PoE Dome Internet Camera TV-IP252P. The page title is "System Information » Device Information". The left sidebar contains navigation options: Live View, Setup, Smart Wizard, Basic, Network, Video/Audio, Event Server, Motion Detect, Event Config, Tools, and Device Info (selected). Under Device Info, there are sub-links for Device Info and System Log. The main content area is divided into three sections: Basic, Video & Audio, and Network.

Basic	
Camera Name:	
Location:	
Firmware Version:	1.0.0 build: 49

Video & Audio	
MPEG4 Resolution:	VGA
MJPEG Resolution:	VGA
3GPP Enable:	Disable
Microphone In:	Enable
Speaker Out:	Enable

Network	
IP Mode:	DHCP
IP Address:	192.168.1.55
Subnet Mask:	255.255.255.0
Default Gateway:	192.168.1.254
MAC Address:	00:FF:17:00:01:06
Primary DNS Address:	192.168.1.249
Secondary DNS address:	
UPnP Enable:	Disable
HTTP Port:	80
RTSP Port:	554

Copyright © 2009 TRENDnet. All Rights Reserved.

■ Information >> Device Info

Display the Basic, Video & Audio, and Network settings of the camera.

■ Information >> System Log

The Logs table displays the events log recorded by the system.

System Information » Logs		Refresh
Time	Event	
Jun 6 11:28:15	NTP date/time setting fail	
Jun 6 11:28:12	Camera service start	

CHAPTER 5

SECURVIEW™ SOFTWARE

This chapter describes detailed instructions on operating SecurView™ software, a useful friendly application for ease of control and navigation requirement.

5.1 Installation

1. Insert the Installation CD-ROM into your computer's CD-ROM drive to initiate the Auto-Run program.
2. Click the **SecurView** From the Auto-Run menu screen

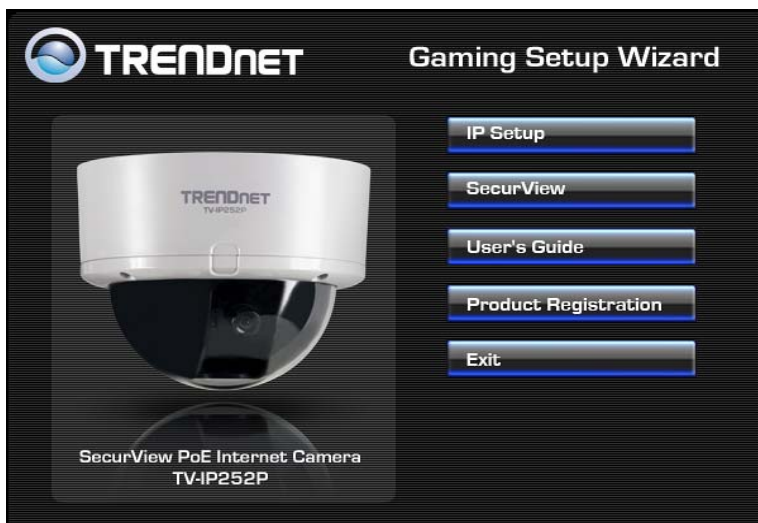

NOTE To use SecurView™, you must have Microsoft .NET Framework 2.0 installed in the computer. The setup wizard will detect it and, if the program is not installed yet, ask you to install it during the process of installing SecurView™.

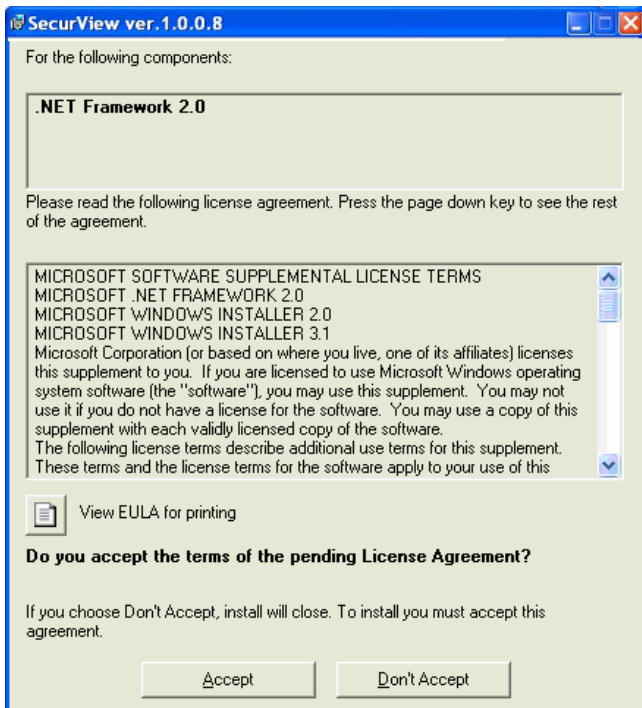

3. Then SecurView Setup Wizard will appear. Click **Next** when the **Welcome to the SecurView Setup Wizard** appears.

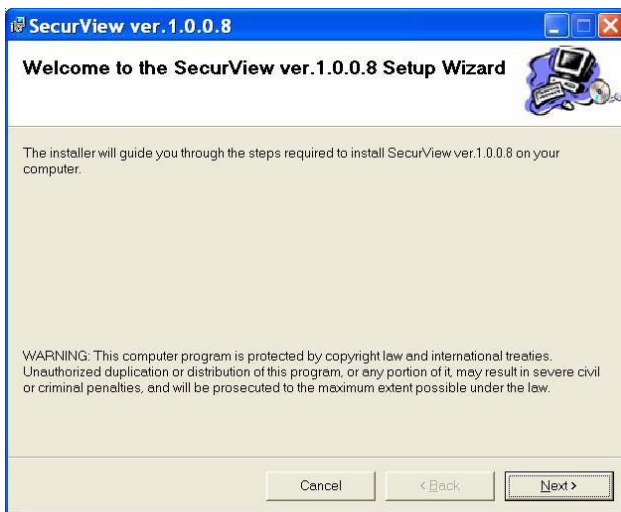

4. Click **Browse** to choose the desired destination location. By default, the destination location is C:\Program Files\TRENDnet\SecurView. Then click **Next**.

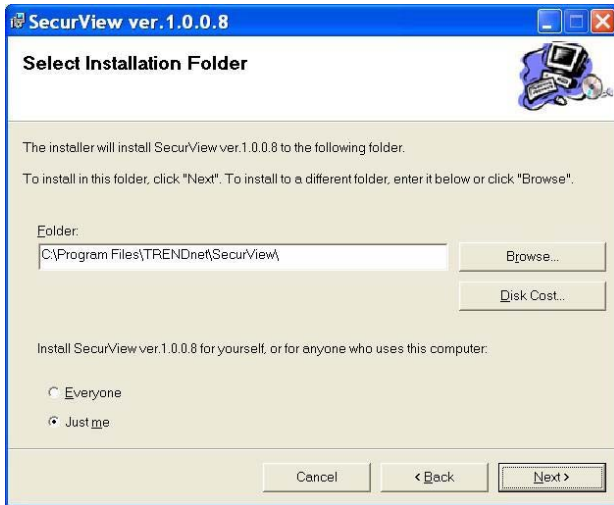

5. Click **Next** to confirm the SecurView software to be installed to the computer

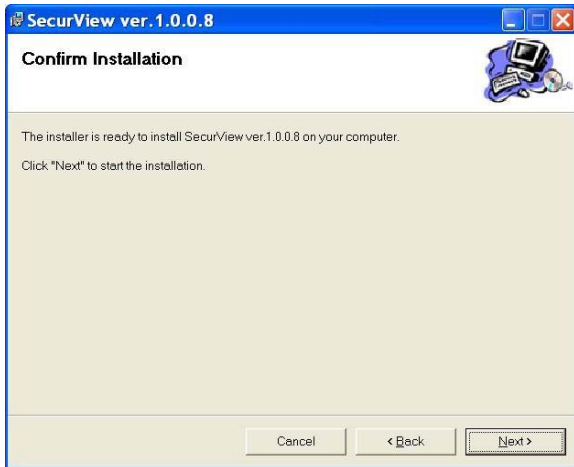

6. When the **Installation Complete** window appears, click **Close**.

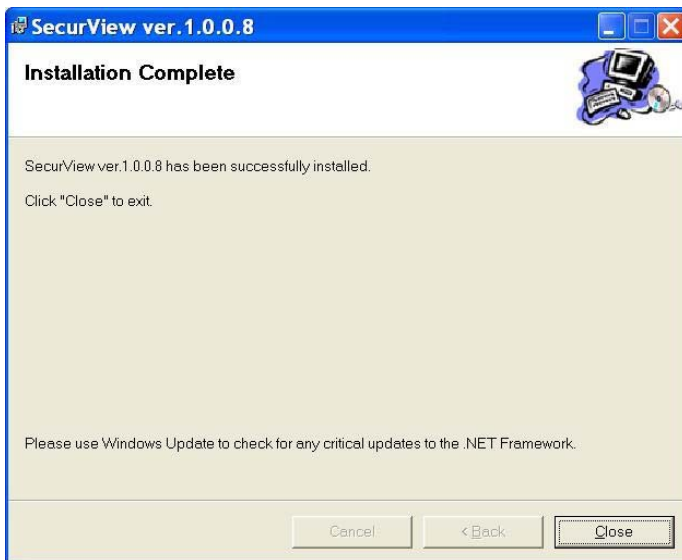

7. After installing the IPSetup utility, the application is automatically installed to your computer, and creates a folder in **Start\Program\TRENDnet\SecurView**.

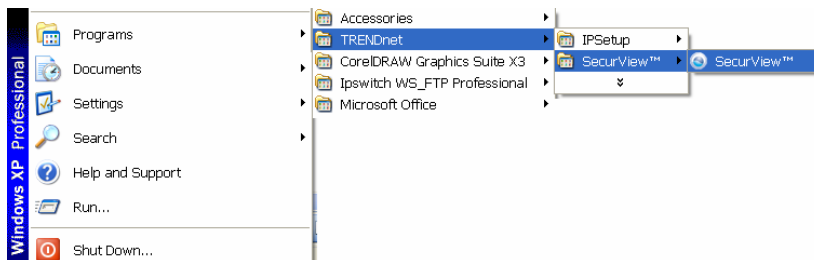

5.2 Using Installation

1. To launch the program, click **Start>Program>TRENDnet>SecurView**, and then click **SecurView™**. The main screen will appear as below.

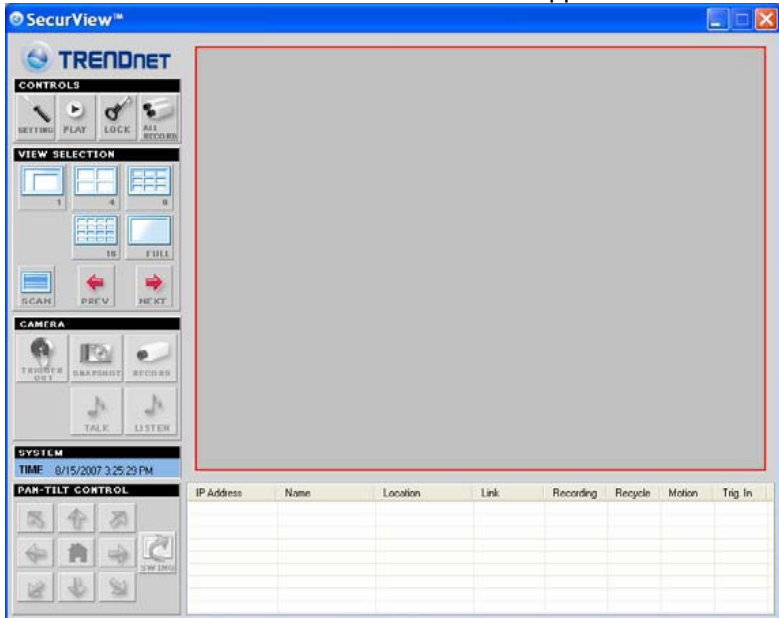

NOTE Please set the resolution to 1024 x 768 or above on your computer while using SecurView™; otherwise, the displayed main screen may be distorted.

Item Features

The following describes the function of each item on the main screen:

■ CONTROLS Panel



- **SETTING:** Click to enter the Setting screen of SecurView™.
- Click again to return to the main screen of SecurView™.
- **Play:** Click to play the recorded video file using the media player on the computer (for example, Windows Media Player by default).

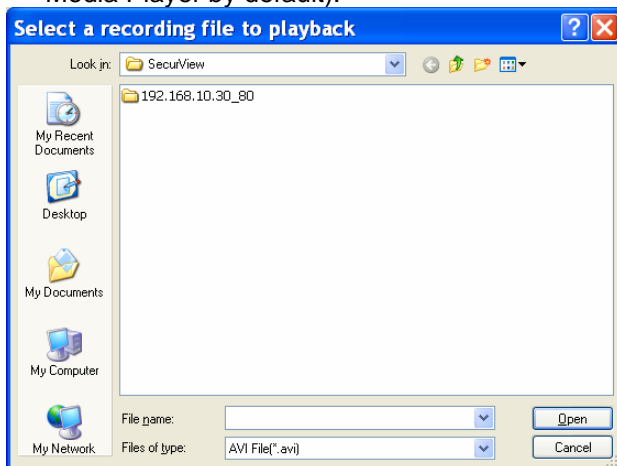

- **Lock:** Click to lock the camera controls. Click again to resume controls for the camera. If you have set ID and Password in **Setting>Account**, you will be asked to enter the required information to unlock.
- **ALL RECORD:** Click to start recording video clips using ALL connected cameras. To stop recording, please click Record button  to stop the individual camera. Please note: stop recording only stops the manual recording camera. For Schedule recording, please change the setting on configuration.

TIP By default, the ID and Password boxes are “blank.” Click **Setting>Account** to change the ID and Password of the lock/unlock function.

■ **VIEW SELECTION Panel**

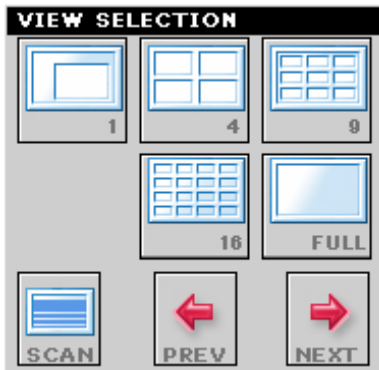

- **View mode buttons:** SecurView™ provides multiple view modes, including 1/4/9/16 windows and Full screen mode.

- **Scan:** When multiple cameras connected, click this button to display the video views between cameras. Click the Scan button again to stop scanning.
- **PREV:** When multiple cameras connected, click this button to switch the video view to the previous camera.
- **NEXT:** When multiple cameras connected, click this button to switch the video view to the next camera.

TIP To set the time interval of scanning, click **SETTING** > **Other** and then adjust the time from 1 to 10 seconds in the **Time interval of scan** option.

■ CAMERA Panel



- **TRIGGER OUT:** Click to turn on the trigger out connector of the camera. This button is available only when the connected camera supports the trigger out connector, which is used to control the external device connected to the camera, such as a light.
- **SNAPSHOT:** Click to capture a still image using the selected camera and save the file in the computer.

- **RECORD:** Click to start recording a video clip using the selected camera. Click again to stop recording and save the file in the computer.
- **TALK:** Click to speak out through the camera. Please note only one user is allowed to use this function at the same time.
- **LISTEN:** Click to receive the on-site sound and voice from the camera.

■ **SYSTEM Panel**

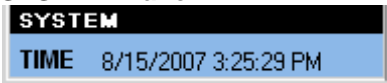

This panel displays the current date and time.

■ **Video View Window and Camera List**

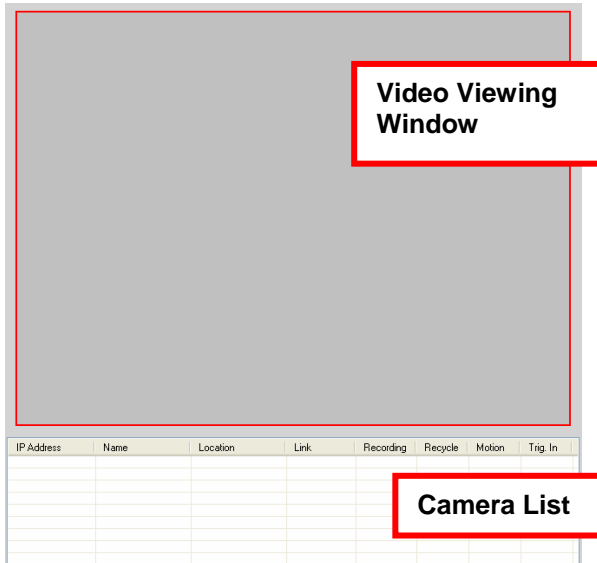

- **Video Viewing Window:** This window displays the video view of the selected camera, which can be divided into 4/9/16 windows according to your selection in VIEW SELECTION panel.
- **Camera List:** This list displays the information of the connected camera(s).

To add a camera

1. Click **SETTING** in the CONTROLS panel to display the Setting screen.
2. Click **Add New Camera**.

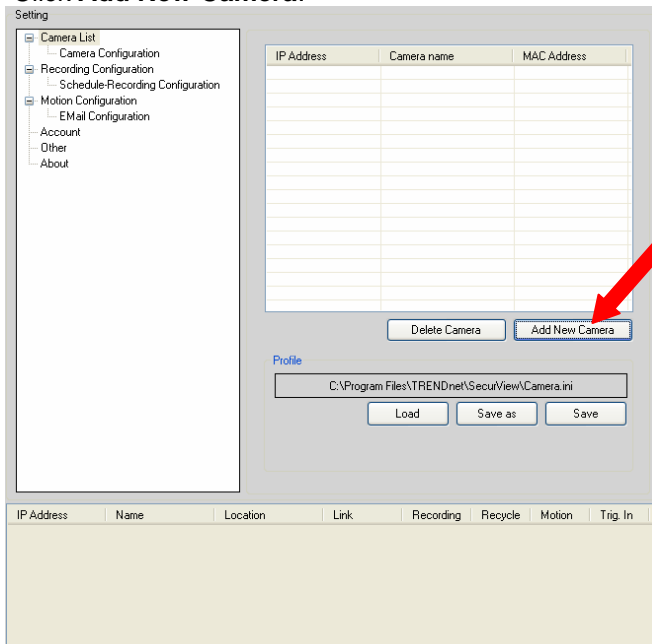

3. In the pop-up Add New Camera dialog window, you can:

- Select the **Search** tab if you are not sure of the camera's IP Address. Click **Search camera** to search for an available camera within the network. Once the camera is found and is shown in the list, select it and click **Add Camera**.

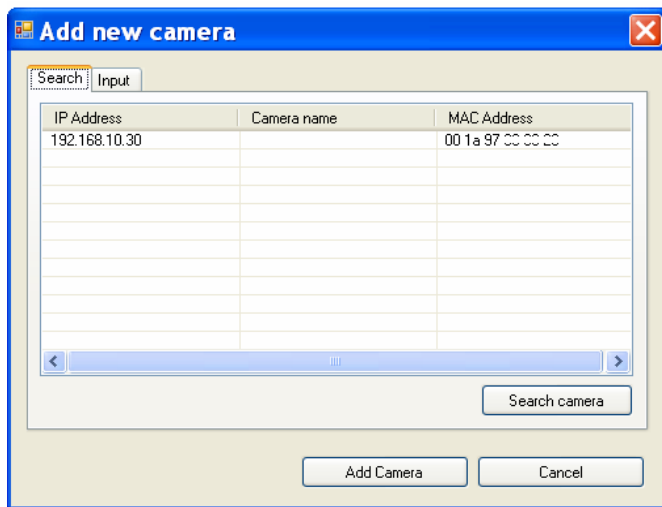

- Select the **Input** tab to add a camera by entering its IP Address directly. Enter the camera's IP Address (default: **192.168.10.30**) and Port (default: **80**), and then click **Add Camera**.

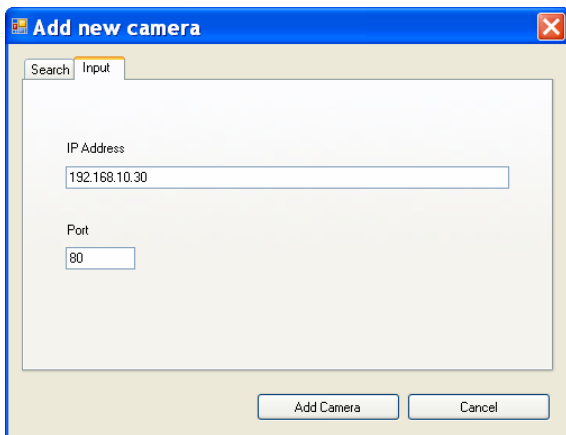

4. Enter the User name and Password for the camera, and then click OK. The connected camera will be displayed in the Camera's List.

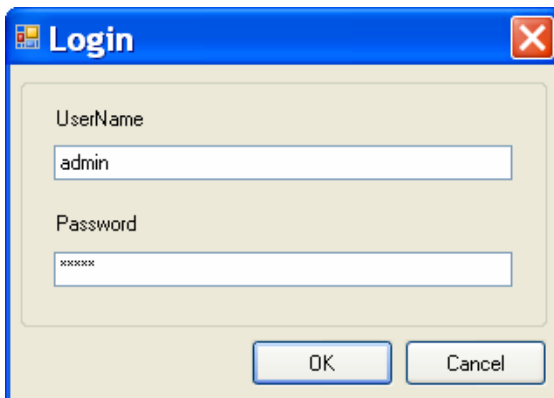

5. Click **SETTING** to return to the Video View Window. The video view of the selected camera will be displayed now.

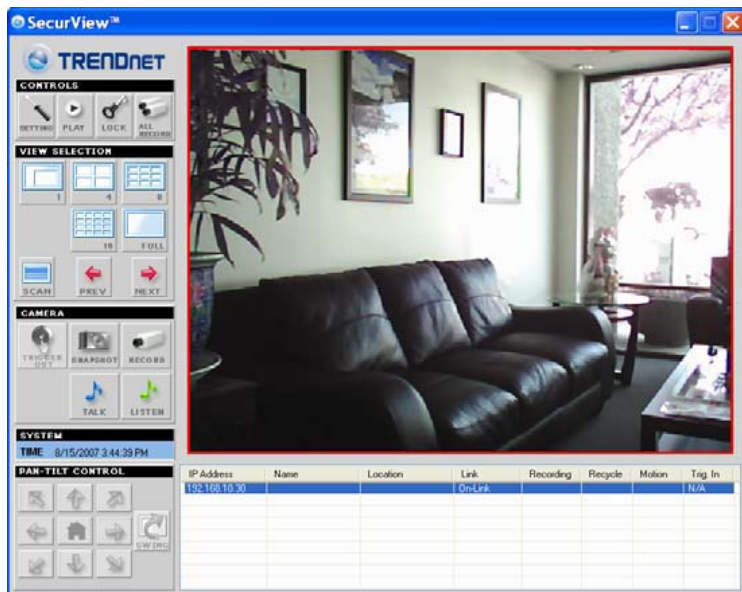

To remove a camera

1. Click **SETTING** in the CONTROLS panel to display the Setting screen.
2. Select a camera from the list and click **Delete Camera**.

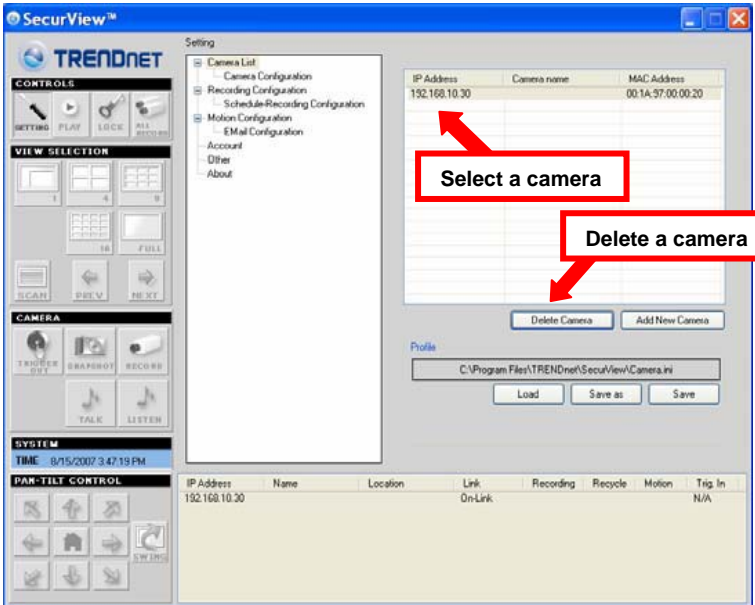

To link to the Web page of the camera

Click **SETTING>Camera List>Camera Configuration** and then **Link web page** to launch the Web browser that displays live view image and Web Configuration of the selected camera.



- **Trigger recording by motion detection**

When the motion detection function of the selected camera is enabled, you can configure the camera to start recording triggered by the motion detected. Click **SETTING>Motion Configuration**, and then select the **Recording** option to enable the selected camera to record by motion detection.

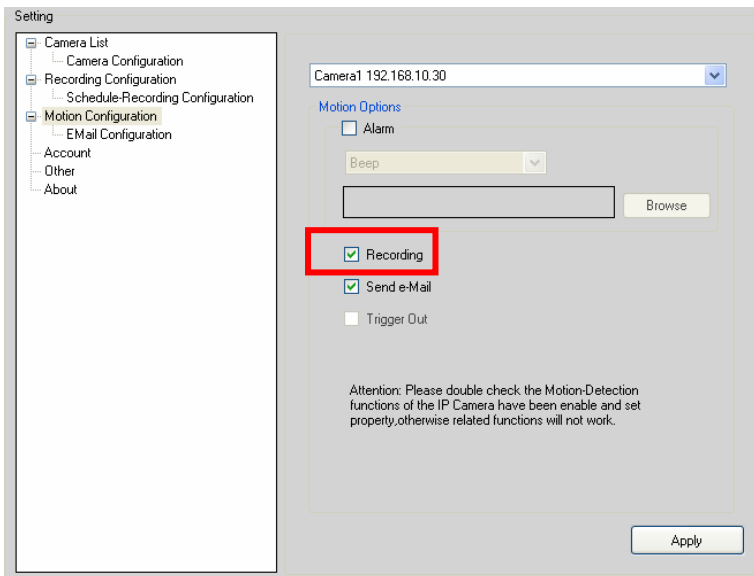

● Schedule Recording Configuration

This recording method will work after you have completed the required settings in the **Schedule Recording Configuration**. The recording schedule can be defined by **Dates** or **Days**.

- **Dates:** Select the camera from the pull-down list.

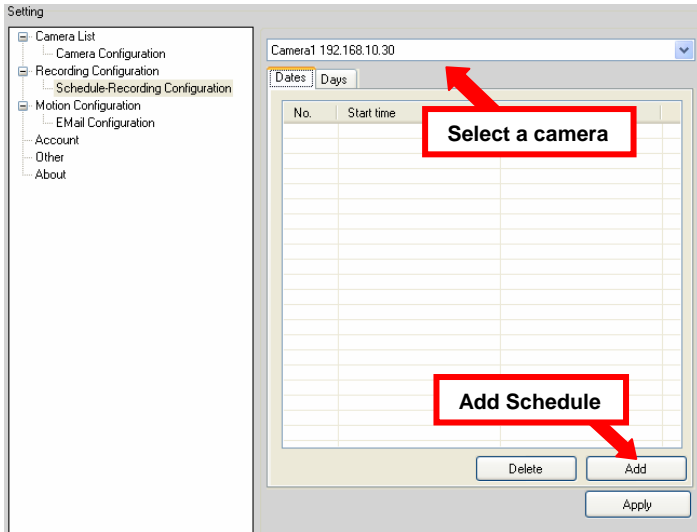

- Then, click **Add** to set the Start/Stop date and time and then click **OK** to add the recording schedule to the list.

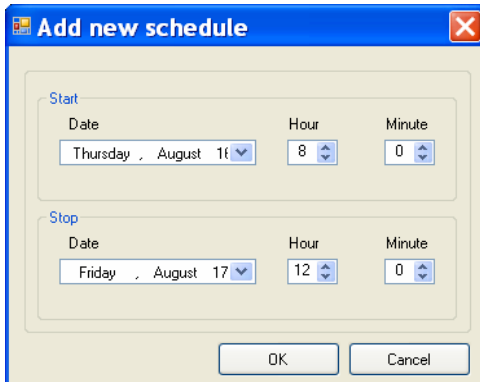

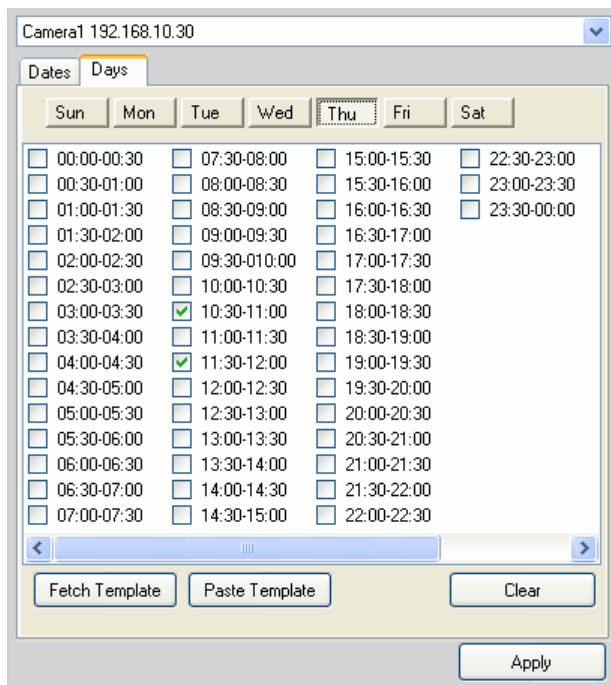

To configure the recording settings

To configure the recording settings, including the storage folder and storage options, click **SETTING>Recording Configuration**.

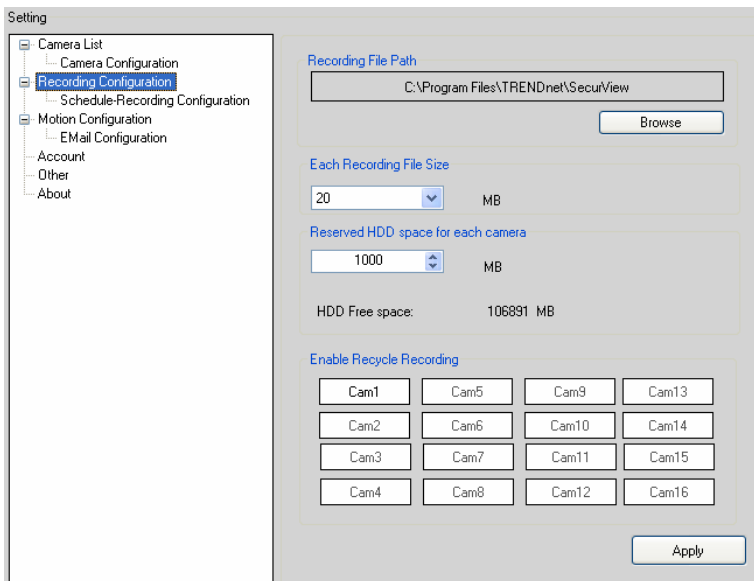

- **Recording File Path:** To change the destination folder to save the recorded video file, click Browse under the **Recording File Path** box to assign a new folder.
- **Each Recording File Size:** This option allows you to select from 20 to 100 MB so that the video will be recorded as another file automatically when the recording file reaches the specified size limit.
- **Reserved HDD space for each camera:** This option allows you to set to reserve the storage space on the hard disk drive for the recording of each camera. Before setting the reserve space on the hard disk drive, you can check the available storage space that is displayed in the **HDD Free space** field.

- **Enable Recycle Recording:** Click on the camera number to clear the files when the unreserved space of the hard disk drive is full.

To playback the recorded video

The recorded video clips are saved in your computer, and can be played using the media player on the computer, such as Windows Media Player.

To start playback, simply click the **PLAY** button on the CONTROLS panel, and the following dialog screen will appear, allowing you to select the file to playback.

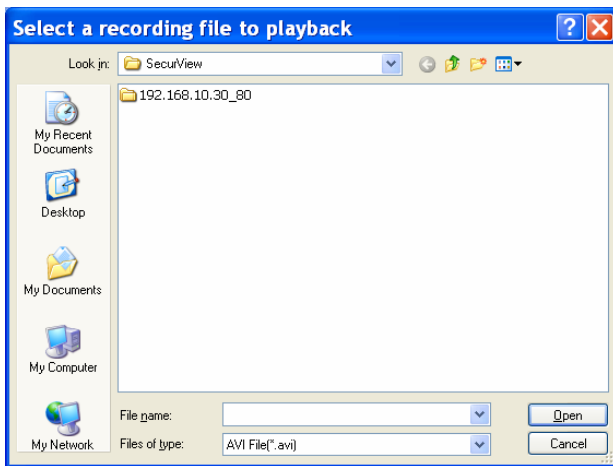

Select the recorded video file under the [camera] path and then click **Open** to launch the media player to playback.

NOTE If your player on the computer does not have a video codec to playback the recorded video, you can download

the video code from <http://www.xvid.org/downloads.15.0.html> to support.

To set up motion detection options

When the motion detection function of the selected camera is enabled, you can set the Motion Options by selecting **Alarm**, **Recording**, **Send e-Mail**, and **Trigger Out** under **SETTING> Motion Configuration**.

Camera1 192.168.10.30

Motion Options

Alarm

Beep

Browse

Recording

Send e-Mail

Trigger Out

Attention: Please double check the Motion-Detection functions of the IP Camera have been enable and set property,otherwise related functions will not work.

Apply

- **Alarm:** Select **Beep** or **Music** to alert you for the motion detected. When you select **Music**, you can customize the sound by clicking **Browse** and then selecting your favorite music (*.wav or *.mp3 file) in the computer.

- **Recording:** Select this option to enable the camera to record by motion detected.
- **Send Email:** Select this option so that the system will be able to send an email to the specified receiver. Once the option is selected, you have to complete the required information in **SETTING>Motion Configuration>Email Configuration**.

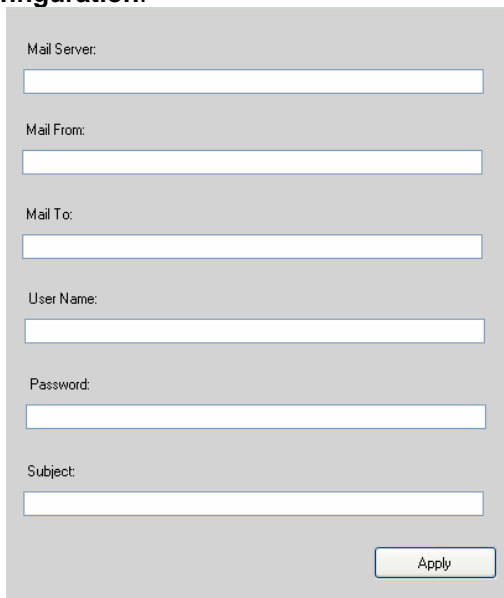

The screenshot shows a configuration window with a light gray background. It contains six text input fields, each with a label to its left: 'Mail Server:', 'Mail From:', 'Mail To:', 'User Name:', 'Password:', and 'Subject:'. Each label is followed by a white rectangular input box with a thin blue border. At the bottom right of the form is a button with the text 'Apply' inside it.

- **Mail Server:** Enter the mail server address. For example, [mymail.com](#).
- **Mail From:** Enter the email address of the user who will send the email. For example, [John@mymail.com](#).
- **Mail To:** Enter the email address of the user who will receive the email.
- **User Name:** Enter the user name to login the mail server.

- **Password:** Enter the password to login the mail server.
- **Subject:** Enter a subject for the notification email.
- **Trigger Out:** If the selected camera supports Trigger Out connector, select this option to enable the Trigger out function.

Account

Click **SETTING>Account** to setup the username & password to lock & unlock the main screen of the SecurView.

Other

Click **SETTING>Other** to setup the scanning time between cameras. The default setting is 2 seconds. You can set the interval time between 2 ~ 20 seconds.

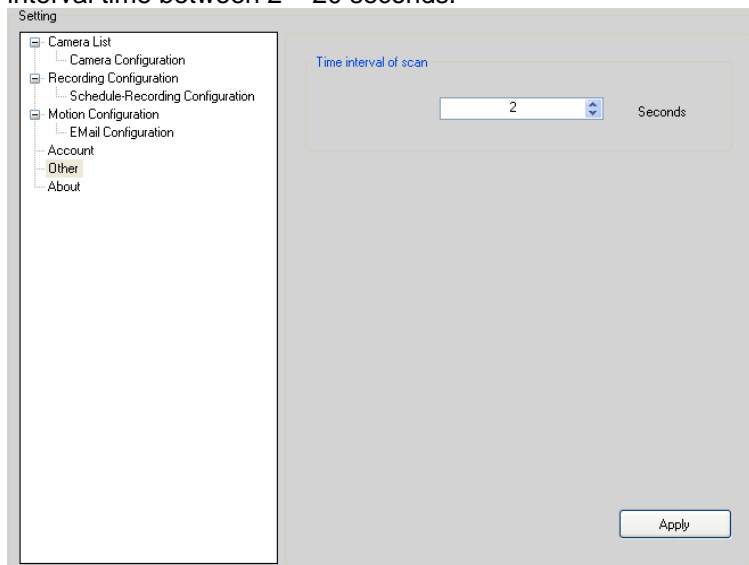

Information

Click **SETTING>About** to display the information of the software application.

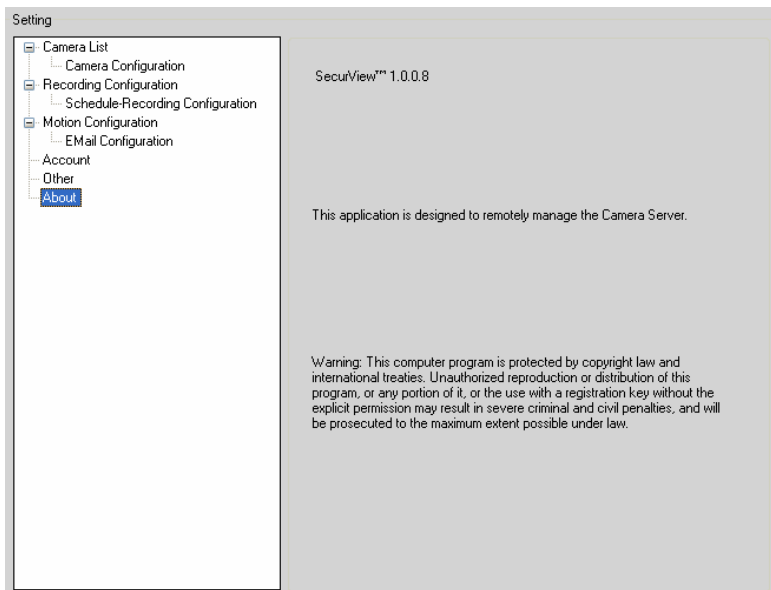

CHAPTER 6

APPENDIX

A.1 Specification

- **System Hardware**
 - **Processor** ARM9 base
 - **RAM** 32MB SDRAM
 - **ROM** 8MB NOR Flash
 - **Power** DC 12V

- **Image Sensor**
 - **Sensor** 1/4" Low Lux CMOS sensor;
minimum illumination @ 0.1 LUX
 - **Resolution** 640 x 480

- **Lens Assembly**
 - **Lens Type** Board Lens
 - **Aperture (F/No.)** 2.0
 - **Focus Length** 4.2 mm
 - **View Angle** (Diagonal) 60 degree

- **Video**
 - **Compression** MPEG4/MJPEG
 - **Exposure Control** Auto
 - **White Balance** Auto
 - **Gain control** Auto
 - **Video Resolution** VGA/QVGA/QQVGA; 30 fps max.

- **Communication**
 - **LAN** 10/100Mbps Fast Ethernet, auto-sensed;
Auto-MDIX

- **Protocol** TCP/IP, UDP, ICMP, DHCP, NTP, DNS, DDNS, SMTP, FTP, HTTP, Samba, PPPoE, UPnP, Bonjour, RTP, RTSP, RTCP

- **User Interface**
 - **LAN** One RJ-45 port
 - **Reset** One Reset button
 - **GPIO** 2 in / 1 out
 - **TV Out** BNC connector, 1 Vp-p, 75 Ohms
 - **Switches** One Power LED switch; one Link LED switch
 - **LEDs** One Power LED (amber); one Link LED (green)

- **Audio**
 - **Input** External microphone jack
 - **Output** Headphone output jack (Mono)
 - **Codec** PCM/AMR (AMR is for 3GPP only)

- **Software**
 - **OS Support** Windows 2000/XP/Vista
 - **Browser** Internet Explorer 6.0 or above
 - **Software** SecurView™ for playback/recording/configuration features

- **Operating Environment**
 - **Temperature** Operation: 0°C ~ 45°C
Storage: -15°C ~ 60°C
 - **Humidity** Operation: 20% ~ 85% non-condensing;
storage: 0% ~ 90% non-condensing

- **EMI**
FCC Class B, CE Class B

A.2 Glossary of Terms

NUMBERS

- 10BASE-T** 10BASE-T is Ethernet over UTP Category III, IV, or V unshielded twisted-pair media.
- 100BASE-TX** The two-pair twisted-media implementation of 100BASE-T is called 100BASE-TX.

A

- ADPCM** Adaptive Differential Pulse Code Modulation, a new technology improved from PCM, which encodes analog sounds to digital form.
- AMR** AMR (Adaptive Multi-Rate) is an audio data compression scheme optimized for speech coding, which is adopted as the standard speech codec by 3GPP.
- Applet** Applets are small Java programs that can be embedded in an HTML page. The rule at the moment is that an applet can only make an Internet connection to the computer from that the applet was sent.
- ASCII** American Standard Code For Information Interchange, it is the standard method for encoding characters as 8-bit sequences of binary numbers, allowing a maximum of 256 characters.
- ARP** Address Resolution Protocol. ARP is a protocol that resides at the TCP/IP Internet layer that delivers data on the same network by translating an IP address to a physical address.
- AVI** Audio Video Interleave, it is a Windows platform audio and video file type, a common format for small movies and videos.

B

BOOTP Bootstrap Protocol is an Internet protocol that can automatically configure a network device in a diskless workstation to give its own IP address.

C

Communication Communication has four components: sender, receiver, message, and medium. In networks, devices and application tasks and processes communicate messages to each other over media. They represent the sender and receivers. The data they send is the message. The cabling or transmission method they use is the medium.

Connection In networking, two devices establish a connection to communicate with each other.

D

DHCP Developed by Microsoft, DHCP (Dynamic Host Configuration Protocol) is a protocol for assigning dynamic IP addresses to devices on a network. With dynamic addressing, a device can have a different IP address every time it connects to the network. In some systems, the device's IP address can even change while it is still connected. It also supports a mix of static and dynamic IP addresses. This simplifies the task for network administrators because the software keeps track of IP addresses rather than requiring an administrator to manage the task. A new computer can be added to a network without the hassle of manually assigning it a unique IP address. DHCP allows the specification for the service provided by a router, gateway, or other network device that automatically assigns an IP address to any device that requests one.

DNS Domain Name System is an Internet service that translates domain names into IP addresses. Since domain names are alphabetic, they're easier to remember. The Internet however, is really based on IP addresses every time you use a domain name the

DNS will translate the name into the corresponding IP address. For example, the domain name *www.network_camera.com* might translate to *192.167.222.8*.

E

Enterprise network

An enterprise network consists of collections of networks connected to each other over a geographically dispersed area. The enterprise network serves the needs of a widely distributed company and operates the company's mission-critical applications.

Ethernet

The most popular LAN communication technology. There are a variety of types of Ethernet, including 10Mbps (traditional Ethernet), 100Mbps (Fast Ethernet), and 1,000Mbps (Gigabit Ethernet). Most Ethernet networks use Category 5 cabling to carry information, in the form of electrical signals, between devices. Ethernet is an implementation of CSMA/CD that operates in a bus or star topology.

F

Fast Ethernet

Fast Ethernet, also called 100BASE-T, operates at 10 or 100Mbps per second over UTP, STP, or fiber-optic media.

Firewall

Firewall is considered the first line of defense in protecting private information. For better security, data can be encrypted. A system designed to prevent unauthorized access to or from a private network. Firewalls are frequently used to prevent unauthorized Internet users from accessing private networks connected to the Internet, especially Intranets all messages entering or leaving the intranet pass through the firewall, which examines each message and blocks those that do not meet the specified security criteria.

G

Gateway

A gateway links computers that use different data

formats together.

Group

Groups consist of several user machines that have similar characteristics such as being in the same department.

H

HEX

Short for hexadecimal refers to the base-16 number system, which consists of 16 unique symbols: the numbers 0 to 9 and the letters A to F. For example, the decimal number 15 is represented as F in the hexadecimal numbering system. The hexadecimal system is useful because it can represent every byte (8 bits) as two consecutive hexadecimal digits. It is easier for humans to read hexadecimal numbers than binary numbers.

I

Intranet

This is a private network, inside an organization or company that uses the same software you will find on the public Internet. The only difference is that an Intranet is used for internal usage only.

Internet

The Internet is a globally linked system of computers that are logically connected based on the Internet Protocol (IP). The Internet provides different ways to access private and public information worldwide.

Internet address

To participate in Internet communications and on Internet Protocol-based networks, a node must have an Internet address that identifies it to the other nodes. All Internet addresses are IP addresses

IP

Internet Protocol is the standard that describes the layout of the basic unit of information on the Internet (the *packet*) and also details the numerical addressing format used to route the information. Your Internet service provider controls the IP address of any device it connects to the Internet. The IP addresses in your network must conform to IP addressing rules. In smaller LANs, most people will allow the DHCP

function of a router or gateway to assign the IP addresses on internal networks.

IP address

IP address is a 32-binary digit number that identifies each sender or receiver of information that is sent in packets across the Internet. For example 80.80.80.69 is an IP address. When you “call” that number, using any connection methods, you get connected to the computer that “owns” that IP address.

ISP

ISP (Internet Service Provider) is a company that maintains a network that is linked to the Internet by way of a dedicated communication line. An ISP offers the use of its dedicated communication lines to companies or individuals who can't afford the high monthly cost for a direct connection.

J

JAVA

Java is a programming language that is specially designed for writing programs that can be safely downloaded to your computer through the Internet without the fear of viruses. It is an object-oriented multi-thread programming best for creating applets and applications for the Internet, Intranet and other complex, distributed network.

L

LAN

Local Area Network a computer network that spans a relatively small area sharing common resources. Most LANs are confined to a single building or group of buildings.

M

MJPEG

MJPEG (Motion JPEG) composes a moving image by storing each frame of a moving picture sequence in JPEG compression, and then decompressing and displaying each frame at rapid speed to show the moving picture.

MPEG4

MPEG4 is designed to enable transmission and reception of high-quality audio and video over the Internet and next-generation mobile telephones.

N

NAT

Network Address Translator generally applied by a router that makes many different IP addresses on an internal network appear to the Internet as a single address. For routing messages properly within your network, each device requires a unique IP address. But the addresses may not be valid outside your network. NAT solves the problem. When devices within your network request information from the Internet, the requests are forwarded to the Internet under the router's IP address. NAT distributes the responses to the proper IP addresses within your network.

Network

A network consists of a collection of two or more devices, people, or components that communicate with each other over physical or virtual media. The most common types of network are:

LAN – (local area network): Computers are in close distance to one another. They are usually in the same office space, room, or building.

WAN – (wide area network): The computers are in different geographic locations and are connected by telephone lines or radio waves.

NWay Protocol

A network protocol that can automatically negotiate the highest possible transmission speed between two devices.

P

PCM

PCM (Pulse Code Modulation) is a technique for converting analog audio signals into digital form for transmission.

PING

Packet Internet Groper, a utility used to determine whether a specific IP address is accessible. It functions by sending a packet to the specified address and waits for a reply. It is primarily used to troubleshoot Internet connections.

PPPoE

Point-to-Point Protocol over Ethernet. PPPoE is a specification for connecting the users on an Ethernet to the Internet through a common broadband medium, such as DSL or cable modem. All the users over the Ethernet share a common connection.

Protocol

Communication on the network is governed by sets of rules called protocols. Protocols provide the guidelines devices use to communicate with each other, and thus they have different functions. Some protocols are responsible for formatting and presenting and presenting data that will be transferred from file server memory to the file server's net work adapter Others are responsible for filtering information between networks and forwarding data to its destination. Still other protocols dictate how data is transferred across the medium, and how servers respond to workstation requests and vice versa. Common network protocols responsible for the presentation and formatting of data for a network operating system are the Internetwork Packet Exchange (IPX) protocol or the Internet Protocol (IP). Protocols that dictate the format of data for transferors the medium include token-passing and Carrier Sense Multiple Access with Collision Detection (CSMA/CD), implemented as token-ring, ARCNET, FDDI, or Ethernet. The Router Information Protocol (RIP),a part of the Transmission Control Protocol/Internet Protocol (TCP/IP) suite, forwards packets from one network to another using the same network protocol.

R

- RJ-45** RJ-45 connector is used for Ethernet cable connections.
- Router** A router is the network software or hardware entity charged with routing packets between networks.
- RTP** RTP (Real-time Transport Protocol) is a data transfer protocol defined to deliver **live media** to the clients at the same time, which defines the transmission of video and audio files in real time for Internet applications.
- RTSP** RTSP (Real-time Streaming Protocol) is the standard used to transmit **stored media** to the client(s) at the same time, which provides client controls for random access to the content stream.

S

- Server** It is a simple computer that provides resources, such as files or other information.
- SIP** SIP (Session Initiated Protocol) is a standard protocol that delivers the real-time communication for Voice over IP (VoIP), which establishes sessions for features such as audio and video conferencing.
- SMTP** The Simple Mail Transfer Protocol is used for Internet mail.
- SNMP** Simple Network Management Protocol. SNMP was designed to provide a common foundation for managing network devices.
- Station** In LANs, a station consists of a device that can communicate data on the network. In FDDI, a station includes both physical nodes and addressable logical devices. Workstations, single-attach stations, dual-attach stations, and concentrators are FDDI stations.
- Subnet mask** In TCP/IP, the bits used to create the subnet are called the subnet mask.

T

(TCP/IP)

Transmission Control Protocol/Internet Protocol is a widely used transport protocol that connects diverse computers of various transmission methods. It was developed by the Department of Defense to connect different computer types and led to the development of the Internet.

Transceiver

A transceiver joins two network segments together. Transceivers can also be used to join a segment that uses one medium to a segment that uses a different medium. On a 10BASE-5 network, the transceiver connects the network adapter or other network device to the medium. Transceivers also can be used on 10BASE-2 or 10BASE-T networks to attach devices with AUI ports.

U

UDP

The User Datagram Protocol is a connectionless protocol that resides above IP in the TCP/IP suite

User Name

The USERNAME is the unique name assigned to each person who has access to the LAN.

Utility

It is a program that performs a specific task.

UTP

Unshielded twisted-pair. UTP is a form of cable used by all access methods. It consists of several pairs of wires enclosed in an unshielded sheath.

W

WAN

Wide-Area Network. A wide-area network consists of groups of interconnected computers that are separated by a wide distance and communicate with each other via common carrier telecommunication techniques.

WEP

WEP is widely used as the basic security protocol in Wi-Fi networks, which secures data transmissions using 64-bit or 128-bit encryption.

- Windows** Windows is a graphical user interface for workstations that use DOS.
- WPA** WPA (Wi-Fi Protected Access) is used to improve the security of Wi-Fi networks, replacing the current WEP standard. It uses its own encryption, Temporal Key Integrity Protocol (TKIP), to secure data during transmission.
- WPA2** Wi-Fi Protected Access 2, the latest security specification that provides greater data protection and network access control for Wi-Fi networks. WPA2 uses the government-grade AES encryption algorithm and IEEE 802.1X-based authentication, which are required to secure large corporate networks.

Limited Warranty

TRENDnet warrants its products against defects in material and workmanship, under normal use and service, for the following lengths of time from the date of purchase.

TV-IP252P – 3 Years Warranty

AC/DC Power Adapter, Cooling Fan, and Power Supply carry 1 year warranty.

If a product does not operate as warranted during the applicable warranty period, TRENDnet shall reserve the right, at its expense, to repair or replace the defective product or part and deliver an equivalent product or part to the customer. The repair/replacement unit's warranty continues from the original date of purchase. All products that are replaced become the property of TRENDnet. Replacement products may be new or reconditioned. TRENDnet does not issue refunds or credit. Please contact the point-of-purchase for their return policies.

TRENDnet shall not be responsible for any software, firmware, information, or memory data of customer contained in, stored on, or integrated with any products returned to TRENDnet pursuant to any warranty.

There are no user serviceable parts inside the product. Do not remove or attempt to service the product by any unauthorized service center. This warranty is voided if (i) the product has been modified or repaired by any unauthorized service center, (ii) the product was subject to accident, abuse, or improper use (iii) the

product was subject to conditions more severe than those specified in the manual.

Warranty service may be obtained by contacting TRENDnet within the applicable warranty period and providing a copy of the dated proof of the purchase. Upon proper submission of required documentation a Return Material Authorization (RMA) number will be issued. An RMA number is required in order to initiate warranty service support for all TRENDnet products. Products that are sent to TRENDnet for RMA service must have the RMA number marked on the outside of return packages and sent to TRENDnet prepaid, insured and packaged appropriately for safe shipment. Customers shipping from outside of the USA and Canada are responsible for return shipping fees. Customers shipping from outside of the USA are responsible for custom charges, including but not limited to, duty, tax, and other fees.

WARRANTIES EXCLUSIVE: IF THE TRENDNET PRODUCT DOES NOT OPERATE AS WARRANTED ABOVE, THE CUSTOMER'S SOLE REMEDY SHALL BE, AT TRENDNET'S OPTION, REPAIR OR REPLACE. THE FOREGOING WARRANTIES AND REMEDIES ARE EXCLUSIVE AND ARE IN LIEU OF ALL OTHER WARRANTIES, EXPRESSED OR IMPLIED, EITHER IN FACT OR BY OPERATION OF LAW, STATUTORY OR OTHERWISE, INCLUDING WARRANTIES OF MERCHANTABILITY AND FITNESS FOR A PARTICULAR PURPOSE. TRENDNET NEITHER ASSUMES NOR AUTHORIZES ANY OTHER PERSON TO ASSUME FOR IT ANY OTHER LIABILITY IN CONNECTION WITH THE SALE, INSTALLATION MAINTENANCE OR USE OF TRENDNET'S PRODUCTS.

TRENDNET SHALL NOT BE LIABLE UNDER THIS WARRANTY IF ITS TESTING AND EXAMINATION DISCLOSE THAT THE ALLEGED DEFECT IN THE PRODUCT DOES NOT EXIST OR WAS CAUSED BY CUSTOMER'S OR ANY THIRD PERSON'S MISUSE, NEGLIGENCE, IMPROPER INSTALLATION OR TESTING, UNAUTHORIZED ATTEMPTS TO REPAIR OR MODIFY, OR ANY OTHER CAUSE BEYOND THE RANGE OF THE INTENDED USE, OR BY ACCIDENT, FIRE, LIGHTNING, OR OTHER HAZARD.

LIMITATION OF LIABILITY: TO THE FULL EXTENT ALLOWED BY LAW TRENDNET ALSO EXCLUDES FOR ITSELF AND ITS SUPPLIERS ANY LIABILITY, WHETHER BASED IN CONTRACT OR TORT (INCLUDING NEGLIGENCE), FOR INCIDENTAL, CONSEQUENTIAL, INDIRECT, SPECIAL, OR PUNITIVE DAMAGES OF ANY KIND, OR FOR LOSS OF REVENUE OR PROFITS, LOSS OF BUSINESS, LOSS OF INFORMATION OR DATA, OR OTHER FINANCIAL LOSS ARISING OUT OF OR IN CONNECTION WITH THE SALE, INSTALLATION, MAINTENANCE, USE, PERFORMANCE, FAILURE, OR INTERRUPTION OF THE POSSIBILITY OF SUCH DAMAGES, AND LIMITS ITS LIABILITY TO REPAIR, REPLACEMENT, OR REFUND OF THE PURCHASE PRICE PAID, AT TRENDNET'S OPTION. THIS DISCLAIMER OF LIABILITY FOR DAMAGES WILL NOT BE AFFECTED IF ANY REMEDY PROVIDED HEREIN SHALL FAIL OF ITS ESSENTIAL PURPOSE.

Governing Law: This Limited Warranty shall be governed by the laws of the state of California.

Some TRENDnet products include software code written by third party developers. These codes are subject to the GNU General Public License ("GPL") or GNU Lesser General Public License ("LGPL").

Go to <http://www.trendnet.com/gpl> or <http://www.trendnet.com> Download section and look for the desired TRENDnet product to access to the GPL Code or LGPL Code. These codes are distributed WITHOUT WARRANTY and are subject to the copyrights of the developers. TRENDnet does not provide technical support for these codes. Please go to <http://www.gnu.org/licenses/gpl.txt> or <http://www.gnu.org/licenses/lgpl.txt> for specific terms of each license.



Product Warranty Registration

Please take a moment to register your product online.
Go to TRENDnet's website at <http://www.trendnet.com/register>

Free Manuals Download Website

<http://myh66.com>

<http://usermanuals.us>

<http://www.somanuals.com>

<http://www.4manuals.cc>

<http://www.manual-lib.com>

<http://www.404manual.com>

<http://www.luxmanual.com>

<http://aubethermostatmanual.com>

Golf course search by state

<http://golfingnear.com>

Email search by domain

<http://emailbydomain.com>

Auto manuals search

<http://auto.somanuals.com>

TV manuals search

<http://tv.somanuals.com>