



TRENDNET®



User's Guide

TV-IP100-N
TV-IP100W-N
H/W: V1.0R

TABLE OF CONTENTS

<i>ABOUT THIS GUIDE</i>	3
<i>INTRODUCTION</i>	4
FEATURES AND BENEFITS	5
UNPACKING THE PACKAGE	7
SYSTEM REQUIREMENT	8
COMPONENTS GUIDE	9
<i>HARDWARE INSTALLATION</i>	12
ATTACHING THE CAMERA TO THE STAND	12
CONNECTING THE ETHERNET CABLE	13
ATTACHING THE POWER SUPPLY	13
<i>SECURITY</i>	14
<i>APPLICATION</i>	15
APPLICATION DIAGRAMS OF THE CAMERA	16
<i>USING THE UTILITY</i>	17
AUTO-RUN INSTALLATION	17
SETUP WIZARD	19
<i>USING THE CAMERA</i>	28
WEB CONFIGURATION UTILITY	28
ADMINISTRATION	30

VIEW VIDEO – ACTIVE X MODE.....	64
VIEW IMAGE – JAVA MODE	65
<i>IPVIEW PRO</i>	67
INSTALLATION	67
GETTING STARTED.....	71
USING IPVIEW PRO	74
CONFIGURING THE SYSTEM	80
<i>APPENDIX</i>	96
A FREQUENTLY ASKED QUESTIONS	96
B PING YOUR IP ADDRESS	99
C TROUBLE SHOOTING	100
D TIME ZONE TABLE	104
E XPLUG CONTROL INSTALLATION.....	106
F ADJUST CAMERA FOCUS.....	110
G SPECIFICATION.....	111
H GLOSSARY OF TERMS.....	113
F	116
G	116

ABOUT THIS GUIDE

This manual provides instructions and illustrations on how to use your Camera, includes:

- Chapter 1, **Introduction**, provides the general information on the camera.
- Chapter 2, **Hardware Installation**, describes the hardware installation procedure for the camera.
- Chapter 3, **Security**, explains the security feature of the camera.
- Chapter 4, **Application of the Camera**, provides the illustrations of the camera's applications.
- Chapter 5, **Using the Utility**, guides you through the configuration using the utility.
- Chapter 6, **Using the Camera**, guides you through the configuration using the web browser.
- Chapter 7, **IPView Pro**, helps you to install and use the software.
- Chapter 8, **Appendix**.

Please note that the illustrations or setting values in this manual are **FOR YOUR REFERENCE ONLY**. The actual settings and values depend on your system and network. If you are not sure about the respective information, please consult your network administrator or MIS staff for help.

INTRODUCTION

Thank you for purchasing TV-IP100-N/ TV-IP100W-N Camera, a camera device that can be directly connected to an Ethernet or Fast Ethernet network. TV-IP100W-N supports additional wireless transmission based on the IEEE 802.11b/g standard. Compared to the conventional PC Camera, the Camera features a built-in CPU and web-based solutions that can provide a cost-effective solution to transmit real-time high-quality video images for monitoring.

The camera can be managed remotely, so that you can use a web browser to access and control it from any desktop/notebook computer over the Intranet or Internet. The simple installation procedures and web-based interface allow you to integrate it into your network easily. With comprehensive applications supported, the Camera is your best solution for remote monitor, high quality, and high performance video images.

Features and Benefits

Ease To Use

The TV-IP100-N/TV-IP100W-N (Wireless) Camera is a standalone system with built-in CPU requiring no special hardware (such as PC frame capture cards) or software required. The Camera supports both ActiveX mode (for Internet Explorer users) and Java mode (for Internet Explorer and Netscape Navigator users). Once you have a valid IP address, just connect it and you can view the image from your camera.

Support Variety of Platforms

Support TCP/IP networking, SMTP e-mail, HTTP and other Internet related protocols, and can be utilized in a mixed operating system environment such as Windows, Unix, and Mac. It can be integrated easily into other www/Intranet applications.

Web Configuration

Using a standard web browser, the administrator can configure and manage the camera directly from his own web page via the Intranet or Internet. Up to 64 users name and password are permitted with privilege setting controlled by the administrator.

Remote Utility

The powerful IPView Pro application assigns the administrator with a pre-defined user ID and password. The administrator can remotely modify the Camera settings or upgrade the firmware via

Intranet or Internet. Users are also allowed to monitor the image, and take snapshots.

Broad Range of Applications

With today's high-speed Internet services, the camera can provide the ideal solution for live video images and audio sounds over the Intranet and Internet. The camera allows remote access from a web browser for live image viewing, so that you can use it to monitor various objects and places anytime and anywhere, such as homes, offices, banks, hospitals, child-care centers, amusement parks and other varieties of industrial and public monitoring. The camera can be used for intruder detection; in addition, it can capture still images for archiving and many other applications.

Unpacking the Package

Unpack the package and check all the items carefully.

- One TV-IP100-N/ TV-IP100W-N
- One Detachable Antenna (TV-IP100W-N only)
- One Multi-Language Quick Installation Guide
- One Driver & Utility CD-ROM with User's Guide
- One External Power Adapter (5VDC 2.5A)
- One RJ-45 Network Cable
- One Camera Mounting Bracket

If any packaging content is damaged or missing, please contact your local dealer immediately. Also, keep the box and packing materials in case you need to ship the unit in the future.

System Requirement

Networking

Local Area Network:

- 10Base-T Ethernet or 100Base-TX Fast Ethernet.

Wireless Local Area Network (TV-IP100W-N Only):

- IEEE 802.11b/g Wireless LAN.

Accessing the Camera

For Web Browser Users

- Operating System: Microsoft® Windows® 98SE/ME/2000/XP/Vista
- CPU: 300MHz or above
- Memory Size: 32MB (64MB recommended)
- Resolution: 800x600 or above
- Microsoft® Internet Explorer 5.0 or above; Netscape 6.0 or above

For IPView Pro Application Users

- OS: Microsoft® Windows® 98SE/ME/2000/XP/Vista.
- CPU: 1GHz or above
- Memory Size: 256MB
- Resolution: 1024x768 or above

NOTE: When you connect multiple cameras and monitor their images synchronously, it is recommended to use a high performance system such as a Pentium4 & 2.4GHz PC.

Components Guide

This section provides the information of camera and explains the function of each component.

Front/Rear Panel



TV-IP100-N

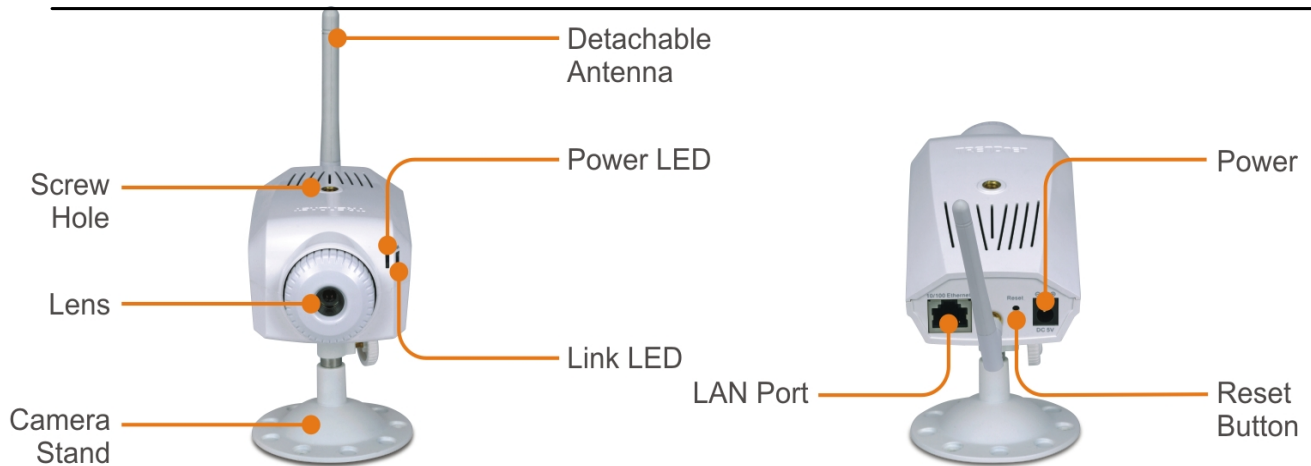

TV-IP100W-N

1. Screw Hole

It located on the top/bottom panel of the camera. The screw hole is used to connect the camera stand onto the camera by attaching the screw head on the camera stand into the screw hole of the camera.

2. Power LED

A steady **BLUE** light indicates that the Camera is powered on.

3. Link LED

A steady **ORANGE** light indicates that the camera has good connection to LAN/WLAN. It begins flashing to indicate the camera is receiving/sending data from/to the LAN/WLAN.

4. Power Connector

The DC power input connector is located on the back of Camera's rear panel, and is labeled DC5V with a single jack socket to supply power to the Camera. Power will be generated when the power supply is connected to a wall outlet.

5. Reset Button

Reset will be initiated when this button is pressed. Factory Reset will be initiated when this button is pressed continuously for five seconds.

6. 10/100 Ethernet LAN Port

This RJ-45 connector is used to connect the 10Base-T Ethernet or 100Base-TX Fast Ethernet network (which should be Category 5 twisted-pair cable). The port supports the N-Way protocol & Auto-MDIX, it allowing the camera automatically detects or negotiates the transmission speed of the network.

7. Detachable Antenna (TV-IP100W-N)

The detachable external antenna allows you to adjust its position to obtain the maximum signal.

2

HARDWARE INSTALLATION

Attaching the Camera to the Stand

The Camera comes with a camera stand, which has a swivel ball screw head that can be attached to the top/bottom of camera's screw hole. Attach the camera to the stand and station it for your application. There are three holes located in the base of the stand allowing the Camera to be mounted on the ceiling or any wall securely.



Connecting the Ethernet cable

Connect an Ethernet cable to the RJ-45 Port, and then connect it to the network.



Attaching the Power Supply

Attach the power supply to the power connector of the Camera. Then connect the power supply to the wall outlet.



SECURITY

To ensure the highest security and prevent unauthorized usage of the camera, the administrator has the exclusive privilege to access the System Administration for settings and control requirements to allow users the level of entry and authorize the privileges for all users. The camera supports multi-level password protection. Access to the camera is strictly restricted to define the user who has a “User Name” and “User Password” that is assigned by the administrator.

The administrator can release a public user name and password to allow remote users to access the camera.

***NOTE:** Since the default settings are Null String, it is highly recommended to set the "Admin Password" when you are the first time to use the camera. Once the password is defined, only the administrator is permitted to manage the camera. The security feature of the camera will not be enabled until the "Admin Password" is defined; therefore, you have to complete this procedure as soon as possible.*

APPLICATION

The TV-IP100-N/ TV-IP100W-N Camera can be applied in wide variety of applications, including:

- Monitoring of local and remote places and objects such as construction sites, hospitals, parks, schools and day-care centers through the use of a web browser.
- Capture single frame images from the IPView Pro application.
- Configure the camera to upload image or send-mail messages with a single frame image.

The following section provides the typical applications for your camera with the IPView Pro application, and also includes some basic knowledge to assist in the installation and configuration of the camera.

Application Diagrams of the Camera

Home or Business Applications

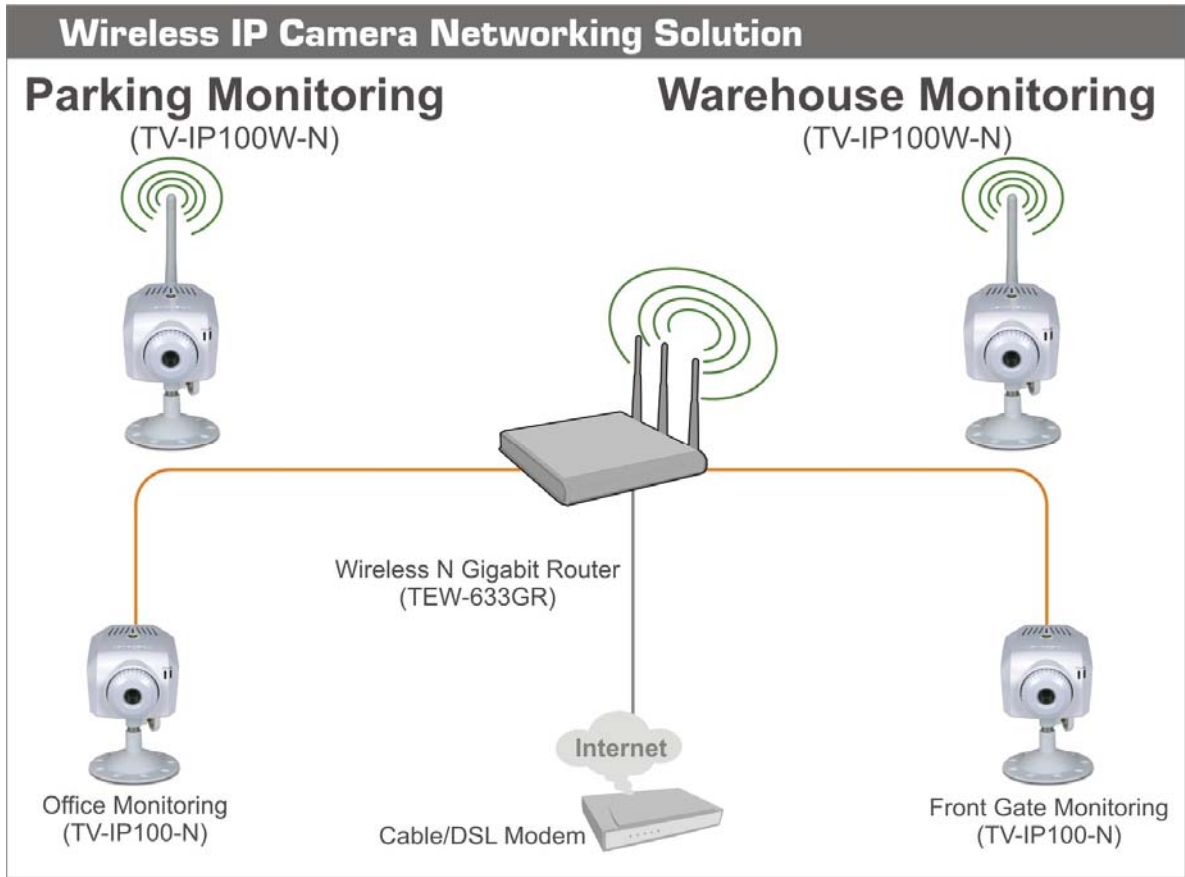

USING THE UTILITY

This chapter describes the software utilities for the IP camera, including how to set up your Camera with the utility. The **Setup Wizard** is designed with a user-friendly interface that allows you to set up the Camera easily.

Auto-Run Installation

Insert the Installation CD-ROM into your computer's CD-ROM drive to initiate the Auto-Run program.



- **Setup Wizard** – click to launch the Setup Wizard program which is helpful to set up the IP Camera configuration easily and quickly.
- **IPView**– click to install IPView program to control and navigate the camera. Please refer to the chapter 6 section for detailed information on installing the utility.
- **Xplug Control** – click to launch Xplug control. Please refer to Trouble Shooting section for more detail installation.
- **User's Guide** – click to preview the *User's Guide* in PDF format for detailed information of the IP Camera
- **Browse CD-ROM** – if you want to browse the contents of the Installation CD-ROM, click this button and the contents of the CD will be available for preview.
- **Exit** – click to close the Auto-Run program.

Setup Wizard

To avoid IP address conflicts in your network, you can use Setup Wizard to change the related settings of your Camera (such as the IP address) after finishing hardware installation.

Installing Setup Wizard

1. Click **Setup Wizard** from the Auto-Run menu screen. The InstallShield Wizard will appear. Click **Next >** when the **Welcome to the InstallShield Wizard for Setup Wizard** screen appears.

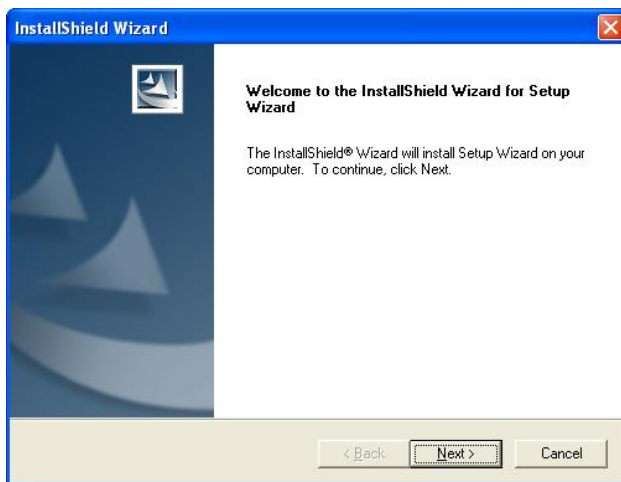

2. Click **Yes >** to accept the End User License Agreement.

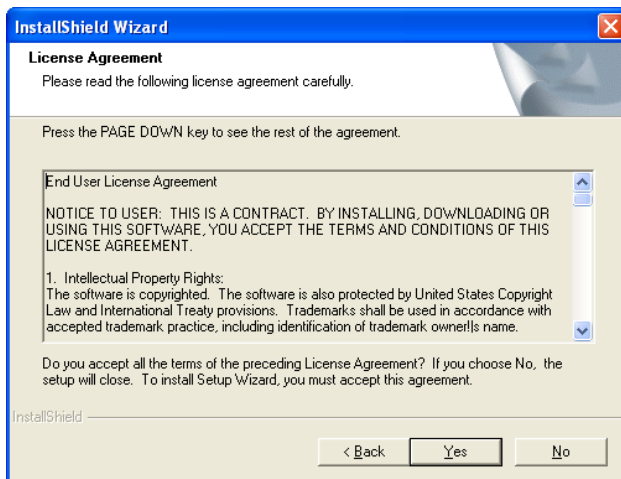

3. Click **Browse** to choose the desired destination location. By default, the destination location is C:\Program Files\Setup Wizard. Then click **Next >**.

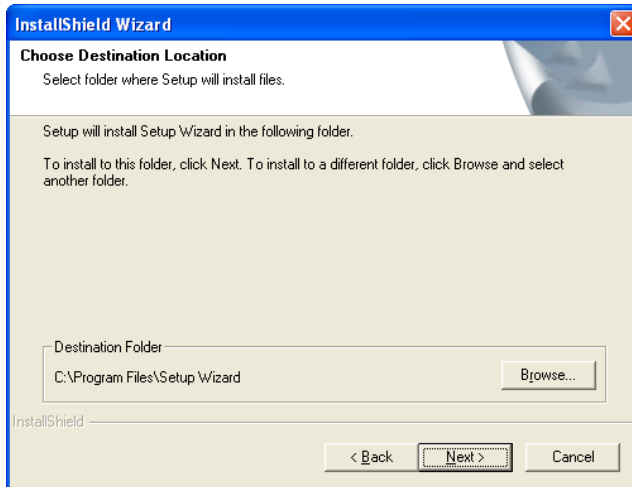

4. The InstallShield Wizard starts to install the software. A status screen appears indicating the progress of the installation.
5. When the **InstallShield Wizard Complete** window appears, click **Finish**.



After installing the utility, the application program for the camera is automatically installed to your computer, and creates a folder in **Start\Programs\SetupWizard**.

Using Setup Wizard

This section describes the operation of Setup Wizard. To launch the Wizard:

1. Click **Start -> Programs -> Setup Wizard**, and then click **SetupWizard**.

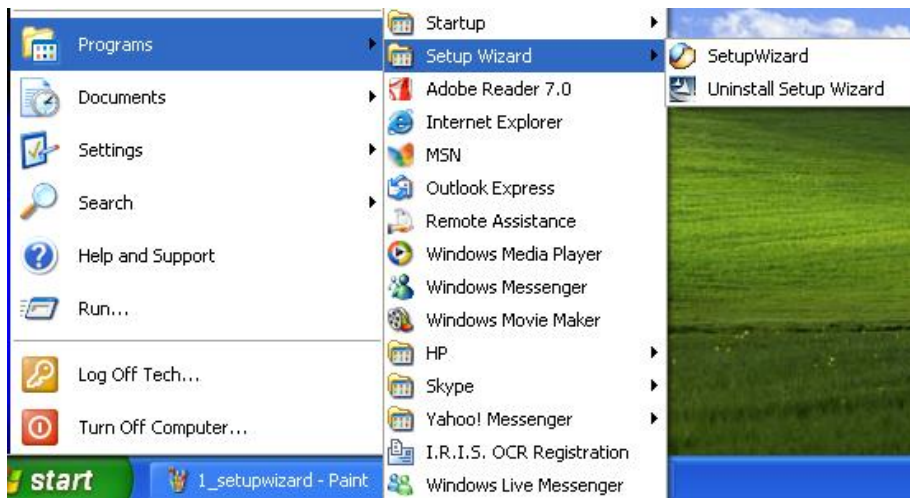

2. The window below will appear. The IP Camera Setup Wizard will automatically search for IP Cameras within the network and assign an available IP address for your camera.



Double click the found Device. The Windows Internet Explorer will ask you for User name and Password. Please type in default “admin” in both field and click OK. After this, you can access this camera. (Go to page 28)

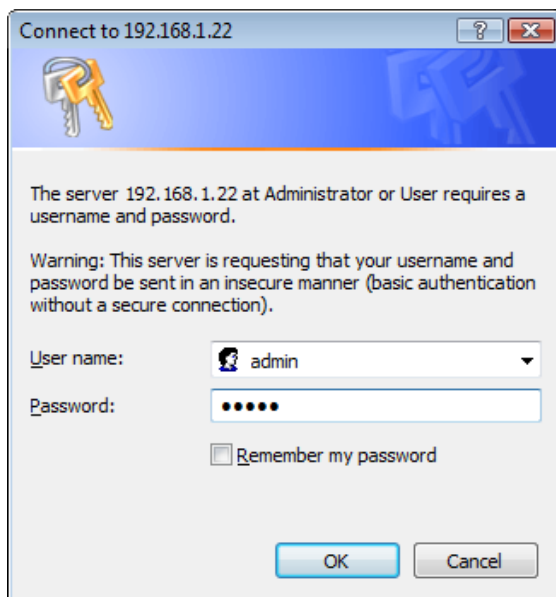

Wizard

- If you want to assign a dedicate IP address, you can change the IP address setting.

- Select IP Camera, then click **Wizard**
- If the Camera's default IP is different than your network's IP subnet, the Wizard will help you to search for a proper IP address. Click **YES** to change the IP address.



- Use the DHCP assigned IP address or manually set the IP address. The IP address must match your network's IP subnet. Then click **OK**.

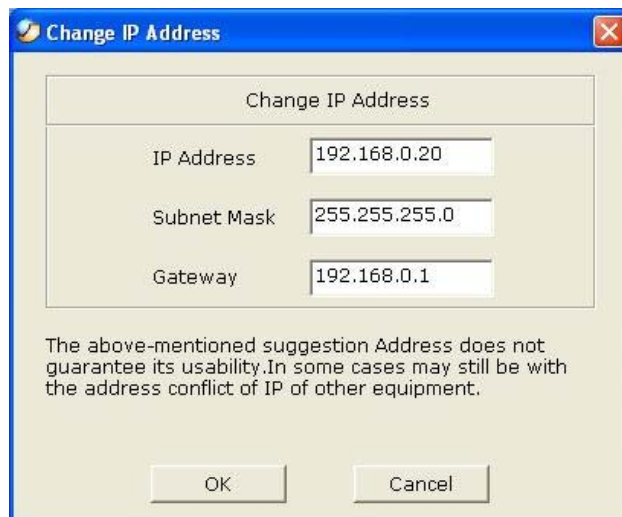

Note: Please note the IP address. This is the IP address for accessing the browser configuration of your camera from

your local area network. Your IP Address might look different than the example above.

- Assign Admin ID & Password here. By default, the Admin ID and Password are “admin”. You can select “**Change**” to type new Admin ID & Password. Then click **Next** (Right Arrow)

TRENDNET IP Camera Setup Wizard

Set up an Admin ID and Password to secure your camera.
Click Next to continue.

Admin ID Password

Change Change

New ID New Password

Reconfirm Reconfirm

Navigation buttons: Left Arrow, Right Arrow (highlighted), Back Arrow

- Setup the Primary DNS or Secondary DNS if necessary. Then click **Next** (Right Arrow)

TRENDNET IP Camera Setup Wizard

Set IP Address

DHCP Static IP

IP Address

Subnet Mask

Default Gateway

Primary DNS

Secondary DNS

Navigation buttons: Left Arrow, Right Arrow, Back Arrow

- Wireless Configure setting. (For TV-IP100W-N only)
Select the connection mode, type in your wireless network's SSID, select the security mode and then click **Next** (Right Arrow)

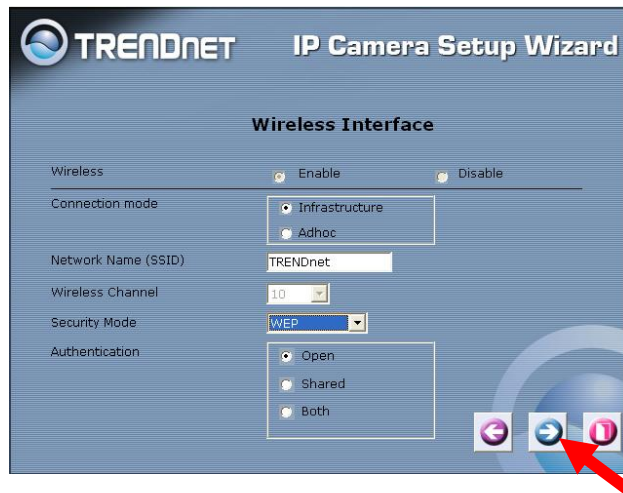

- Select the Encryption Mode, key format and enter the key. Then click **Next** (Right Arrow).

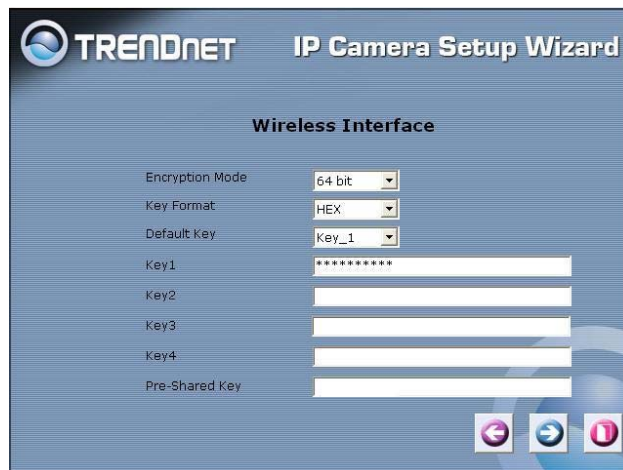

- Review all the setting then click restart.

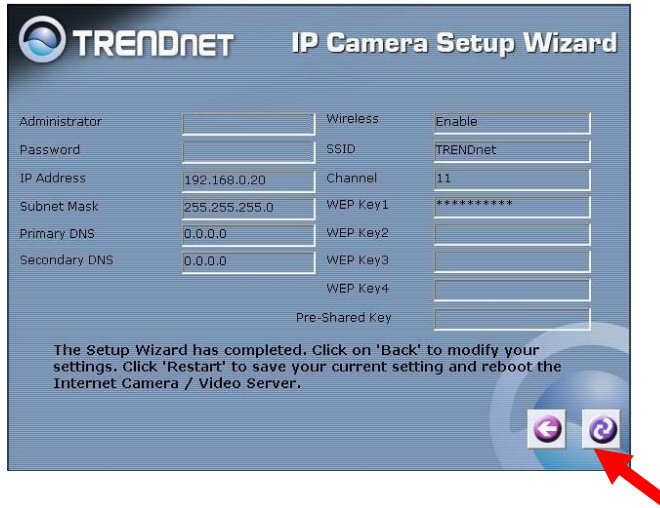

Search

- This button will search the available camera(s) within the network.



Link

- This button links to the web configuration section.

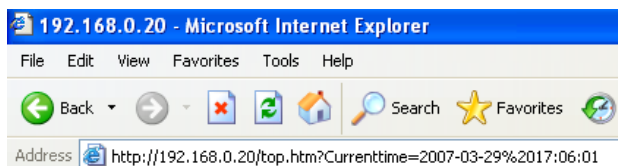

About

- This button displays Setup Wizard information.



Exit

- Exit the Setup Wizard

USING THE CAMERA

You can access and manage the camera through: 1) a web browser, and 2) the enclosed software IPView Pro. This chapter describes the Web Configuration Utility, and provides the instructions on using the camera with a web browser.

Web Configuration Utility

Whenever you want to configure the camera, open your web browser (e.g. Internet Explorer in this manual), and type the assigned DHCP IP address which can be found by using Setup Wizard in the Address bar and press [Enter]. If your network cannot assign DHCP IP address on your camera, your camera default IP will be changed to 192.168.0.20.

NOTE: The computer's IP address must correspond with the camera's IP address in the same segment for devices to communicate. Please refer to Chapter 5 for IP setting.

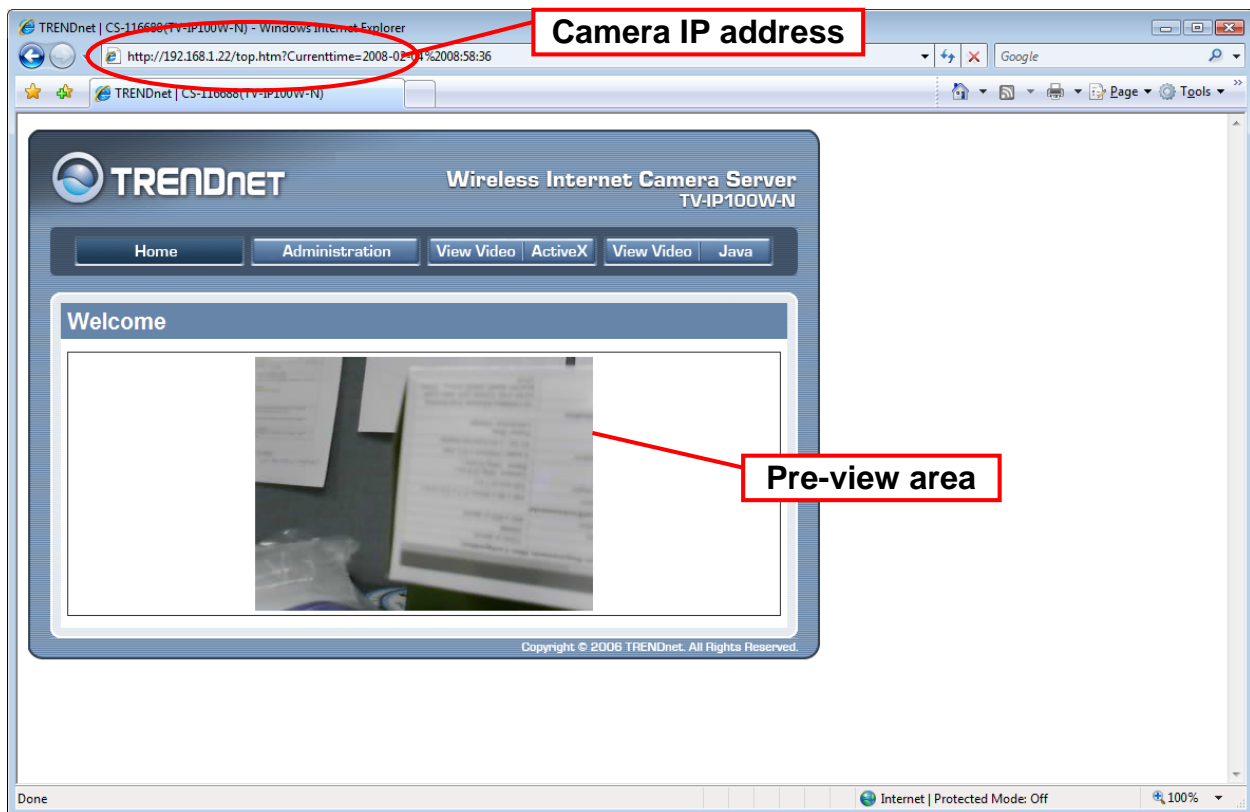

Welcome Screen of the Configuration Utility

After the default IP address is entered from the browser, the Camera Welcome screen will appear with a still image. There will be three options to choose from to set-up and view your Camera, including:

- **Administration**
- **View Video – ActiveX**
- **View Video – Java**

Administration

On the Welcome screen of the Configuration Utility, click **Administration** to enter the administration window that contains the settings required for the camera in the left hand menu bar, including **Status, Configuration, Tools and Help**.

*TIP: Click **Save** to store the settings, or **Cancel** to abandon, or **Refresh** to reload the status. Click **Home** on the top menu bar will link to the Welcome window.*

Administration → Status

The Status window contains the information of your configuration. Click the items in the left column to view your settings, including: **System, Video, Wireless (Wireless is for TV-IP100W-N only), Network, and Active User**.

The screenshot displays the administration interface for a TRENDNET Wireless Internet Camera Server (TV-IP100W-N). The interface includes a top navigation bar with buttons for Home, Administration, View Video (ActiveX), and View Video (Java). A left-hand menu bar contains buttons for Status, Configuration, Tools, and Help. The Status button is circled in red. Below the Status button, a list of sub-items is shown: System, Video, Wireless, Network, and Active Users. The main content area displays the 'System' status window, which includes a 'Device Status' table and an 'Ethernet Status' table. A 'Refresh' button is located at the bottom of the System status window.

Device Status	
Camera Name	CS-116688
Location	
Model	TV-IP100W-N
Firmware Version	3.36 (2008-01-25)
MAC Address	00 FF 11 11 66 88
IP Address	192.168.1.22

Ethernet Status	
Link	Yes
Speed	100M bps
Duplex	Full Duplex

System

Click the **System** item in the left column to display the device status of your camera.

The screenshot shows the TRENDnet web interface for a Wireless Internet Camera Server (TV-IP100W-N). The interface includes a navigation menu on the left with options like Home, Administration, View Video, ActiveX, View Video, Java, Status, Configuration, Tools, and Help. The main content area displays the 'System' page, which is divided into two sections: 'Device Status' and 'Ethernet Status'. The 'Device Status' section contains a table with the following information:

Device Status	
Camera Name	CS-116688
Location	
Model	TV-IP100W-N
Firmware Version	3.36 (2008-01-25)
MAC Address	00 FF 11 11 66 88
IP Address	192.168.1.22

The 'Ethernet Status' section contains a table with the following information:

Ethernet Status	
Link	Yes
Speed	100M bps
Duplex	Full Duplex

A 'Refresh' button is located below the Ethernet Status table. The copyright notice at the bottom of the interface reads: Copyright © 2006 TRENDnet. All Rights Reserved.

- **Device Status:** The information about the camera, including the Camera Name, Location, Model, Firmware Version, MAC Address and IP Address, can be found in this field.

Device Status	
Camera Name	CS-116688
Location	
Model	TV-IP100W-N
Firmware Version	3.36 (2008-01-25)
MAC Address	00 FF 11 11 66 88
IP Address	192.168.1.22

- **Ethernet Status:** You can monitor the networking status in this field, including the Link (network connection), Speed, and the Duplex mode.

Ethernet Status	
Link	Yes
Speed	100M bps
Duplex	Full Duplex
<input type="button" value="Refresh"/>	

Video

Click the **Video** item in the left column to display the video configuration of your camera.

The screenshot shows the web interface for a Trendnet Wireless Internet Camera Server (TV-IP100W-N). The interface includes a navigation menu with options like Home, Administration, View Video (ActiveX), and View Video (Java). A left sidebar contains a 'Status' section with links for System, Video, Wireless, Network, and Active Users, along with buttons for Configuration, Tools, and Help. The main content area is titled 'Video' and displays the 'Video Status' configuration table.

Video Status	
Video Resolution	320 X 240
Compression Rate	Medium
Frame Rate	Auto
Frame Size	6676 Bytes
Light Frequency	60 Hz
<input type="button" value="Refresh"/>	

Copyright © 2006 TRENDnet. All Rights Reserved.

- **Video Status:** The video configuration about the camera, including the Video Resolution, Compression Rate, Frame Rate, Frame Size and IP Address, can be found in this field.

Wireless (for TV-IP100W-N only)

Click the **Wireless** item in the left column to display the information of the wireless LAN.



The screenshot shows the administration interface for a TRENDnet Wireless Internet Camera Server (TV-IP100W-N). The interface includes a navigation menu on the left with options like Home, Administration, View Video, ActiveX, View Video, and Java. The main content area displays the 'Wireless' status, which includes a table with the following information:

Wireless Status	
Connection Mode	Infrastructure
Link	Yes
SSID	TRENDnet (MAC : 00 14 D1 35 43 FA)
Channel	6
Transmission Rate	54M bps
Encryption	No

Below the table is a 'Refresh' button. The interface also includes a 'Status' section on the left with sub-items like System, Video, Wireless, Network, and Active Users, and a 'Configuration' section. The copyright notice at the bottom reads: Copyright © 2006 TRENDnet. All Rights Reserved.

- **Wireless Status:** The items in this field display the information of the wireless LAN, such as the Connection Mode (Infrastructure or Ad-Hoc), Link, SSID, Channel, Transmission Rate, and WEP Encryption.

Network

Click the **Network** item in the left column to display the information of the LAN.

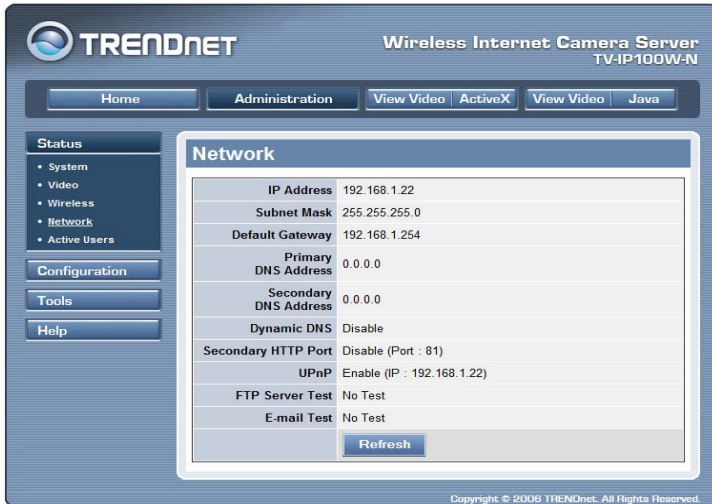

The screenshot shows the TRENDnet administration interface for a Wireless Internet Camera Server (TV-IP100W-N). The interface includes a navigation menu on the left with options like Status, Configuration, Tools, and Help. The main content area displays the Network configuration page, which lists various network parameters and their current values. A 'Refresh' button is located at the bottom of the configuration table.

Network	
IP Address	192.168.1.22
Subnet Mask	255.255.255.0
Default Gateway	192.168.1.254
Primary DNS Address	0.0.0.0
Secondary DNS Address	0.0.0.0
Dynamic DNS	Disable
Secondary HTTP Port	Disable (Port : 81)
UPnP	Enable (IP : 192.168.1.22)
FTP Server Test	No Test
E-mail Test	No Test

Refresh

- **Network Status:** The items in this field display the information of the LAN, such as the IP Address, Subnet Mask, Default Gateway, Primary DNS Address, Secondary DNS Address, Dynamic DNS, Secondary HTTP Port, and UPnP.

Active Users

Click the **User** item in the left column to display the user(s) information.

The screenshot shows the TRENDnet administration interface for a Wireless Internet Camera Server (TV-IP100W). The interface includes a navigation menu on the left with options like Home, Administration, View Video, ActiveX, View Video, and Java. The main content area displays the Network configuration page, which includes a table of network settings and a Refresh button.

Network	
IP Address	192.168.1.220
Subnet Mask	255.255.255.0
Default Gateway	0.0.0.0
Primary DNS Address	192.168.223.254
Secondary DNS Address	0.0.0.0
Dynamic DNS	Disable
Secondary HTTP Port	Enable (Port : 81)
UPnP	Enable (IP : 192.168.1.9)
FTP Server Test	No Test
E-mail Test	No Test

Refresh

Copyright © 2006 TRENDnet. All Rights Reserved.

- **Active Users:** The items in this field display the user(s) information, including the user(s) IP address, Name, and DateTime.

The screenshot shows the TRENDnet administration interface for a Wireless Internet Camera Server (TV-IP100W-N). The interface includes a navigation menu on the left with options like Home, Administration, View Video, ActiveX, View Video, and Java. The main content area displays the Active Users page, which includes a table of active users and a Refresh button.

Active Users			
IP Address	Name	DateTime	Millisecond / Packet

Refresh

Copyright © 2006 TRENDnet. All Rights Reserved.

Administration → Configuration

The **Configuration** window contains commands for settings that are required to input key details to setup the camera for operation. Click **Configuration** in the top menu bar and the Configuration window will appear as below:



System

Click the **System** item in the left column to setup the basic configuration of your camera.



- **System Setting:** In this field, you can configure the basic information of your camera.

- **Camera Name:** This field is used to enter a descriptive name for the device. The default setting for the Camera Server Name is **CS-xxxxxx**, where **xxxxxx** is the last six digit of the MAC Address. The maximum length is 32 (printable ASCII).
- **Location:** This field is used to enter a descriptive name for the location used by the camera (optional).
- **Admin:** This field is used to enter the administrator name along with the password to access the System Administration settings. Be sure to enter the password twice to confirm the details once in the **Admin Password** field and again in the **Confirm Password** field.

The default setting for administrator is “admin”, and the administrator name is limited a maximum length of 12 (printable ASCII) characters and enter the administrator password with a maximum length of 8 (printable ASCII) characters.

It is highly recommended to set your own Admin ID and Admin Password as soon as possible to enable security option for the Camera to function.

- **LED Control:** This option allows user to setup the LED illumination as desired. This feature provides the flexibility when surveillance activity is ON.

There are three options as follows:

Normal	Power - Steady On of the LED indicator. Link - Steady On of the LED indicator. When WLAN activity is present the LED indicator will flash steadily.
OFF	Power - LED indicator is off. Link – LED indicator is off.
Dummy	Power - Steady On of the LED indicator. Link - Steady On of the LED indicator with random flashing.

The default setting for the LED control is at *Normal*. When you have configured the LED control, the correct illumination will be set after 1 minute.

Video

Click the **Video** item in the left column to setup the image configuration of your camera.

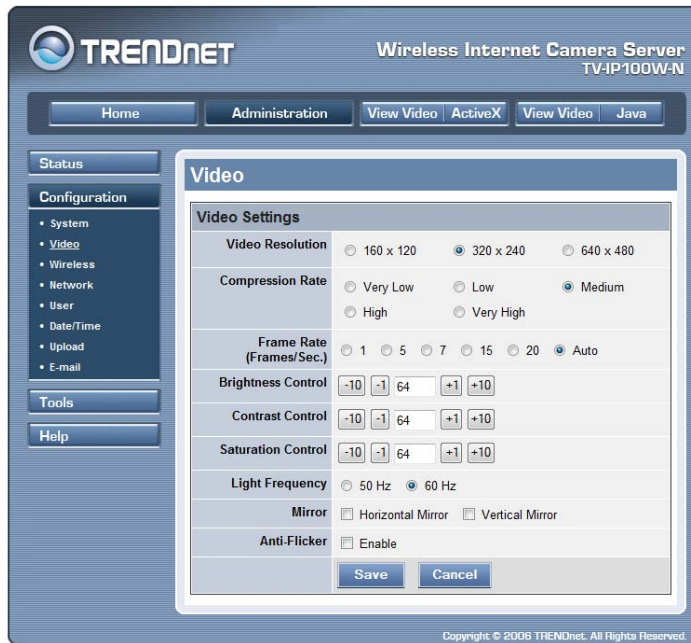

- **Video Setting:** In this field, you can configure the basic information of your camera.
 - **Video Resolution:** Select the desired video resolution format, including **160x120**, **320x240** (default) and **640x480**.
 - **Compression Rate:** Select the desired compression rate with five levels from **Very Low** to **Very High**. Higher video compression rate will generate more compact file size with less video quality and vice-versa. The default setting is **Medium**.
 - **Frame Rate:** Select the frame rate desired with default setting at **Auto** for optimal frame rate.

- **Brightness Control:** Adjust the brightness level with default setting at **64**.
- **Contrast Control:** Adjust the contrast level with default setting at **64**.
- **Saturation Control:** Adjust the saturation with default setting at **64**.
- **Light Frequency:** Adjust the light frequency to suit your area of operation from the options either **50 Hz** or **60 Hz** (default).

Wireless (for TV-IP100W-N only)

Click the **Wireless** item in the left column to setup the wireless LAN configuration of your camera.

TRENDnet Wireless Internet Camera Server
TV-IP100W-N

Home Administration View Video ActiveX View Video Java

Status

Configuration

- System
- Video
- Wireless**
- Network
- User
- Date/Time
- Upload
- E-mail

Tools

Help

Wireless

Wireless Interface

Connection Mode Infrastructure Ad-Hoc

SSID: TRENDnet (Manually Input or Select from List)
TRENDnet (dropdown)
Site Survey

Wireless Channel: 11 (dropdown)

Transmission Rate: Fully Automatic (dropdown)

Encryption

Encryption Type Disable WEP Encryption

Length: 64bits 128bits

Format: ASCII HEX

Key 1:

Key 2:

Key 3:

Key 4:

Encrypt Data Transmissions Using: Key 1 (dropdown)

Authentication Type: Open System Shared Key Both

WPA-PSK / WPA2-PSK

Preshared Key: PSK12345 (8-63 ASCII or 64 HEX characters)

Advanced Setting

Beacon Interval: 100 (ms)

Preamble: Long Short

Save Cancel

Copyright © 2006 TRENDnet. All Rights Reserved.

- Wireless Interface

Wireless Interface	
Connection Mode	<input checked="" type="radio"/> Infrastructure <input type="radio"/> Ad-Hoc
SSID	<input type="text" value="TRENDnet"/> (Manually Input or Select from List) <input type="text" value="TRENDnet"/> <input type="button" value="Site Survey"/>
Wireless Channel	<input type="text" value="11"/>
Transmission Rate	<input type="text" value="Fully Automatic"/>

- **Connection Mode:** Use this option to determine the type of wireless communication for your camera. There are two choices of Infrastructure mode and Ad-Hoc mode. The default setting is *Infrastructure*.
- **SSID:** The SSID (Service Set Identifier) is the name assigned to the wireless network. It will auto-detect and display the SSID of wireless network connected in this box (it displays *default* initially). This default setting will let the camera connect to ANY access point under the infrastructure network mode.
To connect the camera to a specific access point on the network, please make sure to set the SSID of the camera to correspond with the access point's SSID for communication. Type any string up to 32 characters long (spaces, symbols, and punctuation are not allowed) in the Network Name box.

To connect the camera to an Ad-Hoc wireless workgroup, make sure to set the same wireless channel and SSID to match with the PC/Notebook's configuration for direct wireless communication.

- **Wireless Channel:** This pull-down menu provides the wireless channel for communication. A "channel" is a range of frequencies to be used in communication between the camera and access point in Infrastructure mode, or the camera and PC/Notebook in Ad-Hoc mode. Select the appropriate channel from the list provided depending on the regulatory region where the unit is sold. The default setting is at channel *11*.
- **Transmission Rate:** Select the data transmit rate from this pull-down menu. The default setting is *Fully Automatic*.

- Encryption

Encryption

Encryption Type

Disable

WEP Encryption

Length : 64bits 128bits

Format : ASCII HEX

Key 1 :

Key 2 :

Key 3 :

Key 4 :

Encrypt Data Transmissions Using : ▼

Authentication Type :

Open System Shared Key Both

WPA-PSK

Preshared Key :
(8-63 ASCII or 64 HEX characters)

- **WEP Encryption:** Wireless network communications can be intercepted easily. WEP (Wired Equivalent Privacy) is an encryption method specified by the IEEE 802.11g standard to make any intercepted communications extremely difficult to interpret by unauthorized parties. The default setting for this option is *Disable*.
- **WEP Key Length:** Select the proper setting for WEP Encryption. In general, a larger key length creates a stronger cipher. The default is 64-bits.
- **WEP Key Format:** To enable WEP Encryption, you should decide the encryption format first by selecting the *ASCII* or *HEX* option, and then input the WEP key (in the following Key 1~4 box).

ASCII input format:

ASCII format causes each character you type to be interpreted as an eight-bit value. All unaccented upper- and lower-case Western European characters that can be input through your keyboard's typing zone are valid. To setup a 64-bit WEP key, input 5 ASCII characters. For example, '12345'. To setup an 128-bit WEP key, input 13 ASCII characters. For example, '1234567890123'. These character counts result in bit counts of 40 and 104 respectively; the camera will automatically pad your input to a bit count of 64 or 128.

HEX input format:

Hex format causes each pair of characters you type to be interpreted as an eight-bit value in hexadecimal (base 16) notation. Only the digits 0 through 9 and the letters A through F (in upper or lower case) are valid. To setup a 64-bit WEP key, input 10 HEX format. For example, '3132333435', which is the same with ASCII input '12345'. To setup an 128-bit WEP key, input 26 HEX format. For example, '31323334353637383930313233', which is the same with ASCII input '1234567890123'. These character counts result in bit counts of 40 and 104, respectively; the

Wireless Camera will automatically pad your input to a bit count of 64 or 128.

- **Encrypt Data Transmissions Using:** Use this pull-down menu to decide to use Key 1, 2, 3 or 4 for encryption).
- **WPA-PSK/WPA-PSK2:** This is a special mode designed for home and small business users who do not have access to network authentication servers. In this mode, the user has to manually enter the starting password in their access point or gateway, as well as in each PC on the wireless network.
- **Advanced Setting:** In this field, you can setup more advanced configuration.

Advanced Setting	
Beacon Interval	<input type="text" value="0"/> (ms)
Preamble	<input checked="" type="radio"/> Long <input type="radio"/> Short
<input type="button" value="Save"/> <input type="button" value="Cancel"/>	

- **Beacon Interval:** This option defines time interval between two images sent.
- **Preamble:** A preamble is a signal used in wireless environment to synchronize the transmitting timing including Synchronization and Start frame delimiter. Please NOTE that if you want to change the Preamble type into *Long* or *Short*, please check the setting of access point.
- **Authentication Type:** *Open System* communicates the key across the network. *Shared Key* allows communication only with other devices with identical WEP settings. The default setting is *Both*.

Network

Click the **Network** item in the left column to setup the LAN configuration of your camera.

The screenshot displays the Network configuration page for a TRENDNET Wireless Internet Camera Server (TV-IP100W-N). The interface includes a navigation menu on the left with options like Status, Configuration, Tools, and Help. The main content area is titled 'Network' and contains several sections:

- TCP/IP**:
 - IP Address Mode**:
 - Fixed IP: IP Address (192.168.10.30), Subnet Mask (255.255.255.0), Default Gateway (0.0.0.0)
 - Dynamic IP (DHCP)
 - PPPoE: User ID, Password
 - DNS IP Address**: 1. 0.0.0.0, 2. 0.0.0.0
 - Dynamic DNS**:
 - Enable, Disable
 - Service Provider: DynDNS.org
 - Host Name, User Name/E-mail, Password/Key
 - Second HTTP Port**:
 - Enable, Disable
 - Port Number: 81
 - UPnP**: Enable, Disable

Buttons for 'Save' and 'Cancel' are located at the bottom of the configuration area. The footer of the page reads 'Copyright © 2006 TRENDnet. All Rights Reserved.'

- **TCP/IP:** The items in this field display the information of the wireless LAN, such as the Connection Mode (Infrastructure or Ad-Hoc), Link, SSID, Channel, Transmission Rate, and WEP Encryption.
- **IP Address Mode:** This field provides your with three options to select the IP Address Mode:

Fixed IP – You can select this option and enter the IP address directly. The default settings are:

- IP Address – 192.168.0.20
- Subnet Mask – 255.255.255.0
- Default Gateway – 0.0.0.0

Dynamic Address (DHCP) – If your network uses the DHCP server, select this option. According to this setting, the camera will be assigned an IP address from the DHCP server automatically. Every time when the camera starts up, please make sure that the DHCP server is set to assign a static IP address to your camera.

PPPoE – If your application requires a direct connection from an ADSL modem through the camera's RJ-45 LAN port, click this option and enter the User ID and Password into the respective boxes. (*You should have an ISP PPPoE account.*) The camera will get an IP address from the ISP as starting up.

- **DNS IP Address:** DNS (Domain Name System) server is an Internet service that translates domain names into IP addresses. Enter at least one DNS IP Address in this field.
- **Dynamic DNS:** The Dynamic DNS service allows you to alias a dynamic IP address to a static hostname in any of the domains, allowing your computer to be more easily accessed from various locations on the Internet.
- **Second HTTP Port:** The default port for communication is via port 80, and you can change it according to your network configuration. Select ***Enable*** from the option and enter the desired port number in the following box.

- **UPnP:** UPnP is the architecture for pervasive peer-to-peer network connectivity of intelligent appliances, wireless devices, and PCs of all form factors. Check the *Enable* option to enable the function of your camera.

User

Click the **User** item in the left column to add, edit and delete users for your camera.

The screenshot shows the administration interface for a Trendnet Wireless Internet Camera Server (TV-IP100W-N). The interface is divided into several sections:

- Navigation:** Home, Administration, View Video (ActiveX), View Video (Java).
- Left Column:** Status, Configuration (System, Video, Wireless, Network, **User**, Date/Time, Upload, E-mail), Tools, Help.
- User Management Section:**
 - User Access Control:** Access Control Enable Disable. Buttons: Save, Cancel.
 - Define Users:** Add User form with fields for User Name, User Password, and Upload/E-mail Image (radio buttons for Yes/No, with No selected). Button: Add.
 - Delete User:** Delete User dropdown menu showing 'Hello(No)' and a Delete button. Below is a table:

	Name	Upload/E-mail Image
1	Hello	No

Copyright © 2006 TRENDnet. All Rights Reserved.

- **User Access Control:**
 - **Access Control:** The administrator has the authority to give permission for the privilege to control the device

to users by selecting *Enable* or *Disable*. The default setting is *No*.



The 'User Access Control' dialog box has a title bar with the text 'User Access Control'. Below the title bar, there is a section labeled 'Access Control' containing two radio buttons: 'Enable' (which is unselected) and 'Disable' (which is selected). At the bottom of the dialog, there are two buttons: 'Save' and 'Cancel'.

- **Define Users:** Use this field to add or delete users for your camera.

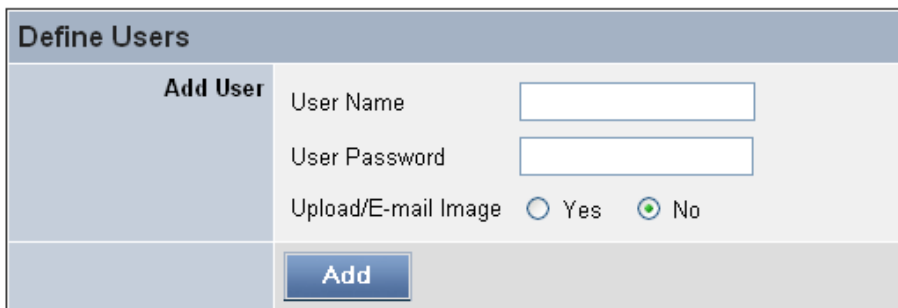

The 'Define Users' dialog box has a title bar with the text 'Define Users'. Below the title bar, there is a section labeled 'Add User' containing three input fields: 'User Name' (a text box), 'User Password' (a text box), and 'Upload/E-mail Image' (a radio button section with 'Yes' unselected and 'No' selected). At the bottom of the dialog, there is an 'Add' button.

- **Add User:** Enter the user name in this box, and enter the user's password assigned by the administrator. The maximum password length is 8 (printable ASCII). The administrator has the authority to give permission for the privilege to control the **Upload/E-mail Video** control to the users by selecting *Yes* or *No* to activate the **Upload/E-mail Video**.
To add a new user's name, enter the necessary information first and click the **Add** button.
- **Delete User:** Select the user you want to delete from the pull-down menu, and then click the **Delete** button.



The 'Delete User' dialog box has a title bar with the text 'Delete User'. Below the title bar, there is a section labeled 'Delete User' containing a pull-down menu and a 'Delete' button. Below this section, there are two columns: 'Name' and 'Upload/E-mail Image'.

- **User List:** This list displays the current users status of your camera.

DateTime

Click the **DateTime** item in the left column to setup time and date for your camera, providing correct information for the remote users who might be thousands of miles away from the camera's location.



- **Date & Time:** You can set up time and date manually or automatically by selecting the *Synchronized with Time Server* option.
 - **Synchronized with Time Server:** Select this option and the time will be based on GMT setting. The time will be synchronized every 10 minutes. When selecting this option, you have to enter the required information in the following fields:
 - IP Address* – Enter the IP Address of the Time Server in this box.
 - Protocol* – Two options of NTP or Time are available for your selection to link with the Time Server. The default setting is NTP.

TimeZone – Select the time zone for the region from the pull-down menu.

- **Set Manually:** Select this option to set the time manually. The system administrator must enter the date and time in the respective field manually.

Upload

Click the **Upload** item in the left column to setup configuration for FTP server, time schedule and manual operation.

The screenshot shows the configuration interface for the Upload section of a Trendnet Wireless Internet Camera Server (TV-IP100W-N). The interface is divided into several sections:

- Navigation:** Home, Administration, View Video, ActiveX, View Video, Java.
- Left Sidebar:** Status, Configuration (System, Video, Wireless, Network, User, Date/Time, Upload, E-mail), Tools, Help.
- Upload Section:**
 - FTP Server:**
 - Host Address: [Text Input]
 - Port Number: 21 (Default is 21)
 - User Name: [Text Input]
 - Password: [Text Input]
 - Directory Path: / [Text Input]
 - Passive Mode: Yes No
 - Time Schedule:**
 - Enable upload image to FTP server
 - Always
 - Schedule
 - Day: Mon Tue Wed Thu Fri Sat Sun
 - Time Period: Start 00:00:00 (Example: 08:30:00) Stop 00:00:00 (Example: 22:30:00)
 - Video Frequency: 1 Frames/Second 1 Seconds/Frame
 - Base File Name: [Text Input]
 - File: Overwrite Date/Time Suffix Sequence Number Suffix Up to 1024
 - Manual Operation:**
 - Enable upload image to FTP server
 - Base File Name: [Text Input]
 - File: Overwrite Date/Time Suffix Sequence Number Suffix Up to 1024
- Buttons:** Save, Cancel.

- **FTP Server:** This field contains the following six basic settings for your FTP server.

- **Host Address:** The IP Address of the target FTP server.
- **Port Number:** The standard port number for the FTP server is Port **21**, and it's also the default setting. If the FTP server uses a specific port, please confirm the IT manager.
- **User Name:** Enter the user name in this field.
- **Password:** Enter the user password in this field to login the FTP server.
- **Directory Path:** Enter an existing folder name in this field, and the images will be uploaded to the given folder.
- **Passive Mode:** This function depends on your FTP server. Please check with your IT manager if the FTP server uses passive mode. The default setting is *No*.
- **Time Schedule:** Select the “*Enable upload video to FTP server*” option and enter the relevant information, such as the schedule, video frequency and base file name.
 - **Schedule:** You can 1.) Choose *Always* to always upload the video to FTP server, or 2.) Set the *Schedule* to manage the uploading task. In the Schedule option, you can set the *Day* and *Time Period* option.
 - **Video Frequency:** There are two ways to set the video frequency: 1.) Set *Auto/1/2/3* frames per second, or 2.) Set the time in seconds for every frame.
 - **Base File Name:** Enter the file name to make sure that the images could be saved as the base file name.
 - **File:** Since you may not upload only one image to the FTP server, you can choose the filing rule, including *Overwrite*, *Date/Time Suffix*, and set up the *Sequence Number*.

- **Manual Operation:** When you click the **Upload Video** button in view video screen, it will start to upload the image. The setting refers to **Base File Name** and **File** information above.

E-mail

Click the **E-mail** item in the left column to setup configuration for E-mail account, time schedule and manual operation settings.

The screenshot shows the configuration interface for a Trendnet Wireless Internet Camera Server (TV-IP100W-N). The page is titled "E-mail" and is part of the "Administration" section. The left sidebar contains navigation options: Status, Configuration (with sub-items: System, Video, Wireless, Network, User, Date/Time, Upload, E-mail), Tools, and Help. The main content area is divided into three sections: E-mail Account, Time Schedule, and Manual Operation. Each section has several input fields and checkboxes. The "E-mail Account" section includes fields for SMTP Server Address, SMTP Port Number (set to 25), Sender's E-mail Address, Recipient's E-mail Address, User Name, and Password. The "Time Schedule" section has checkboxes for "Enable e-mail image to e-mail account", "Always" (selected), and "Schedule". The "Schedule" option includes checkboxes for days of the week (Mon, Tue, Wed, Thu, Fri, Sat, Sun) and time fields for Start (00:00:00) and Stop (00:00:00), with an interval of 300 seconds. The "Manual Operation" section has a checkbox for "Enable e-mail image to e-mail account" and an interval of 300 seconds. At the bottom of the form are "Save" and "Cancel" buttons. The footer of the page reads "Copyright © 2006 TRENDnet. All Rights Reserved."

- **E-mail Account:** This field contains the following six basic settings for your FTP server.
 - **SMTP Server Address:** SMTP (Simple Mail Transfer Protocol) is a protocol for sending e-mail messages between servers you need to input the mail server address in this field.
 - **Sender e-mail Address:** Enter the e-mail address of the user who will send the e-mail.
 - **Receiver e-mail Address:** Enter the e-mail address of the user who will receive the e-mail.
 - **User Name:** Enter the user name in this field.
 - **Password:** Enter the user password in this field to login receiver's mail server.
- **Time Schedule:** Select the “*Enable-mail video to e-mail account*” option to set schedule to send e-mail. Please refer to the instruction in “**Upload**” section. The *Interval* option is to define time interval between two images sent.
- **Manual Operation:** When you click the ***E-mail Video*** button in view video screen, it will start to e-mail image. The *Interval* option is to define time interval between two images sent.

Administration → Tools

The **Tools** window contains commands for restarting the camera. Click **Tools** in the top menu bar and the Tools window will appear as below:



FTP Server Test

Click the **FTP Server Test** item in the left column to test your FTP server.



E-mail Test

Click the **E-mail Test** item in the left column to test your e-mail account.



- **Test E-mail Account:** Click the **Test** button to test the e-mail account you provided.

Reset

Do you really want to reset this device? Click the **YES** button from this option, and you can restart the camera just like turning the device off and on and saved settings are retained. If you do not want to reset the camera, exit this window without clicking **YES**.



Factory Reset

Do you really want to factory reset this device? Click the **YES** button from this option, and you can resume all factory default settings for the camera. If you do not want to restore the factory settings, exit this window without clicking **YES**. Please NOTE that you have to configure the network settings again after a Factory Reset.



Firmware Upgrade

When new firmware is available, you can upgrade it through this window. Click the **Browse...** button to point to the firmware file (XXX.bin), and then click **Update** to start upgrading.



Backup

Click the **Backup** item in the left column to backup the current configuration.



- **Backup Device Configuration to File:** Do you really want to backup the configuration to file? Click the **Backup** button from this option, and you can save the current configuration to file.

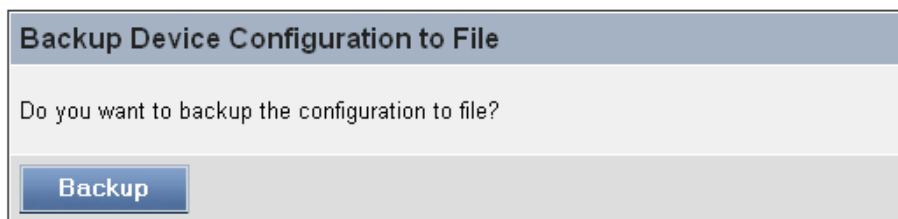

- **Restore Device Configuration from File:** You can resume the device configuration from saved file in the

computer. Click the **Browse...** button to point to the file, and then click **Restore** to start restoring.

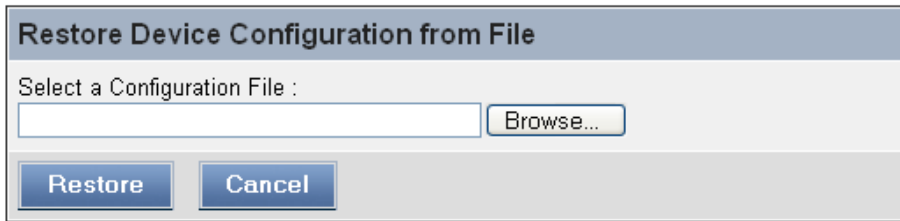

Administration → Help

The **Help** window provides the basic information of the camera. Click **Help** in the top menu bar and the Help window will appear as below:



About

Displays the camera's model name and version.



Once the configuration is completed, click **Home** to return to the Welcome screen and select the desired View Video option either through **ActiveX Mode** or **Java Mode** as described in the next section.

Then, position the camera to the desired location appropriately for your purpose. Followed by adjustment of the camera focus, done manually by turning the lens clockwise or anti-clockwise to the desired image quality. Please refer to *Appendix F* for detailed instruction.

View Video – ActiveX Mode

To view video images from the browser, click **View Image – ActiveX Mode** from the Welcome screen to access the video images from Internet Explorer as illustrated below:

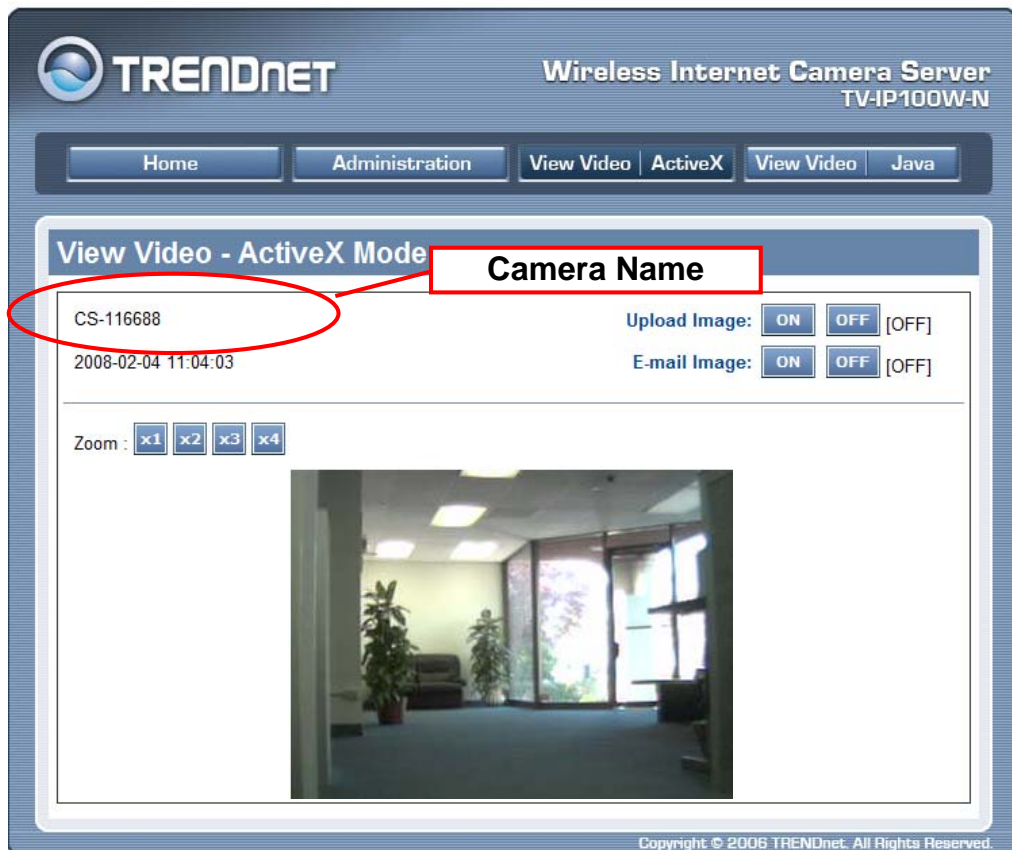

Camera Name: The Camera name will be displayed when the Camera Name field is entered in the Web Configuration setting under **Configuration**.

In the **View Video – ActiveX Mode**, you are allowed to use the **Upload Video** and **E-mail Video** options. Simply click the desired selection **ON** or **OFF** to utilize the options for each of the functions.

View Image – Java Mode

To view video images from the browser, click **View Image – Java Mode** from the Welcome screen to access the video images from Internet Explorer or Netscape browser as illustrated below:

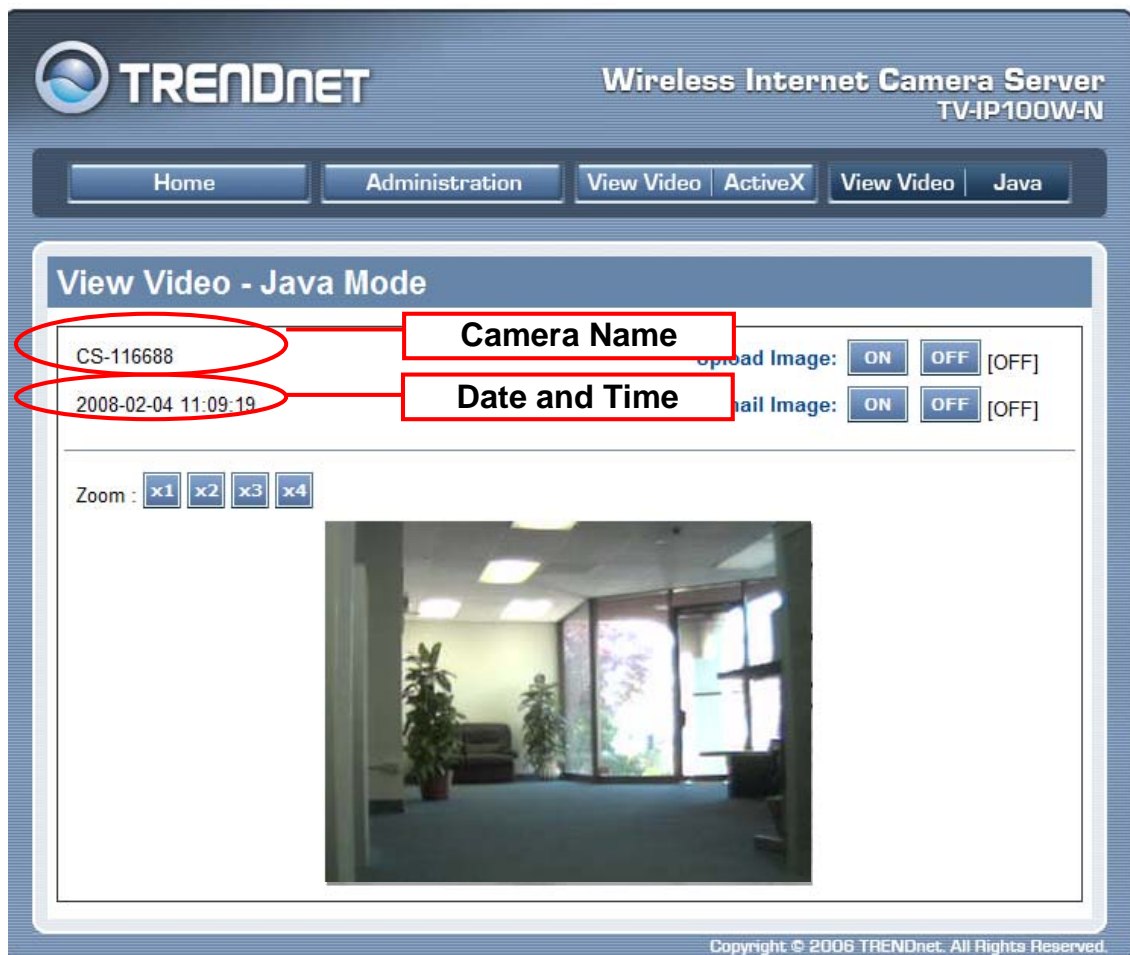

Camera Name: The Camera name will be displayed when the Camera Name field is entered in the Web Configuration setting under **Configuration**.

Date and Time: The date/time of the camera will be displayed here.

In the **View Video – Java Mode**, you are allowed to use the **Upload Video** and **E-mail Video** options. Simply click the desired selection **ON** or **OFF** to utilize the options for each of the functions.

NOTE:

- *Please refer to the appendix on how to install ActiveX, including 1.) install to the Web Server, and 2.) install to your Local PC.*
- *Please download Sun Microsystems **Java Runtime Environment (JRE)** to view image in JAVA mode.*
- *The administrator has the authority to set the upload video function through the setting in the **Upload** option under **Configuration**.*
- *The administrator has the authority to set the e-mail video function through the setting in the **E-mail** option under **Configuration**.*

IPVIEW PRO

This chapter describes the IPView PRO, which is a powerful software application designed with a user-friendly interface for ease of control and navigation requirements.

Installation

Step 1

Insert the CD-ROM into the CD-ROM drive to initiate the auto-run program. The menu screen will appear as below:



Step 2

Click the **IPView** item to activate the InstallShield Wizard. Click *Next* in the welcome screen.

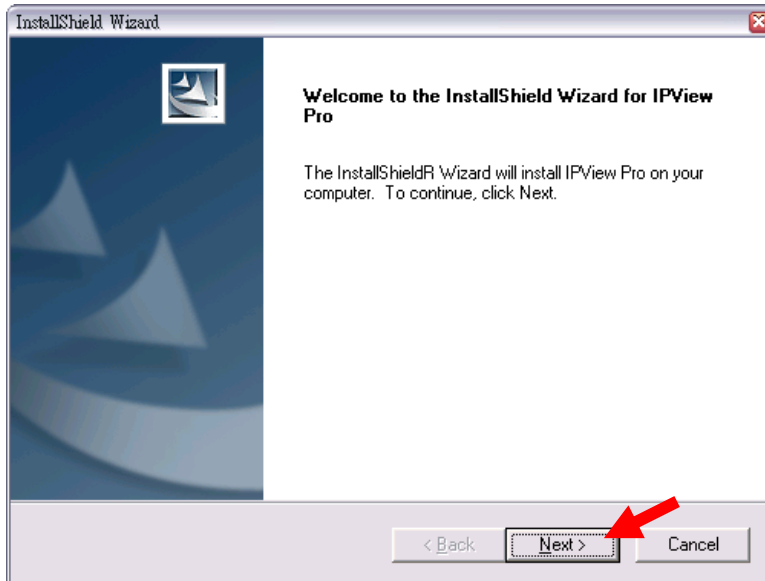

Step 3

Read and accept the License Agreement; then, click *Yes*.



Step 4

Choose the destination location. If no specific requirement, leave the default setting and click *Next*.

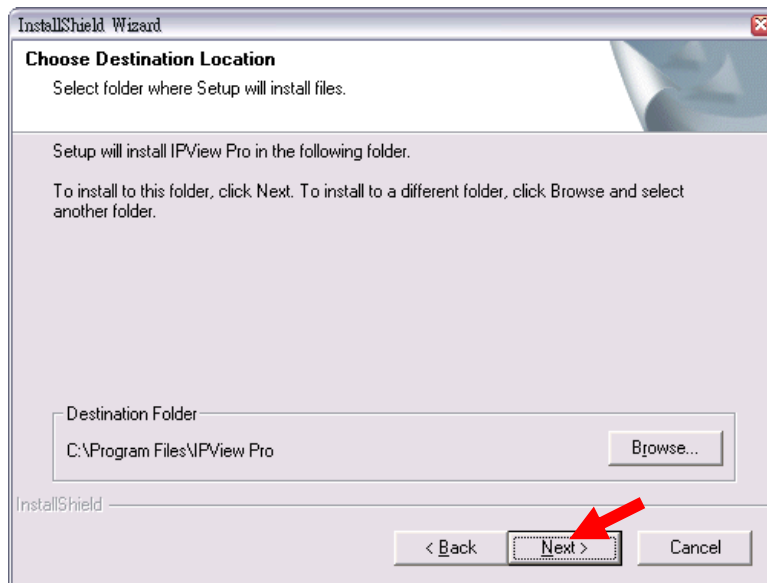

Step 5

The InstallShield Wizard starts to install the software, and the progress bar indicates the installation is proceeding.

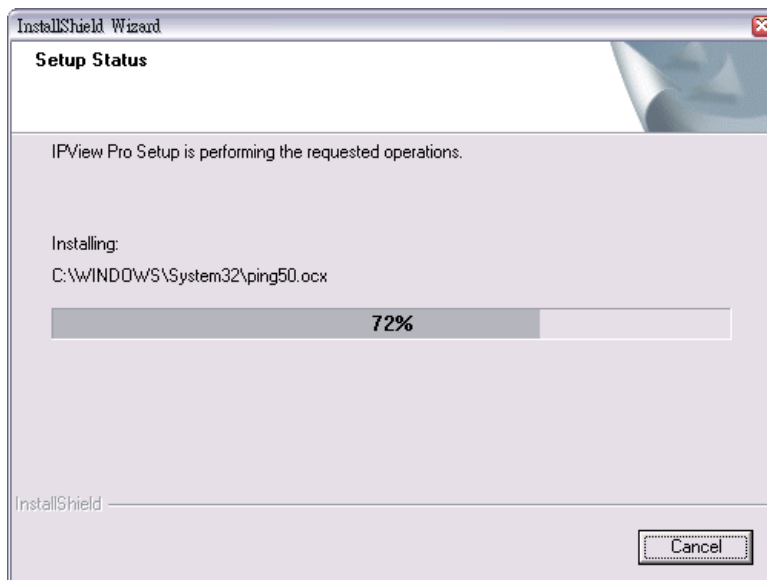

Step 6

Click *Finish* to complete the installation.

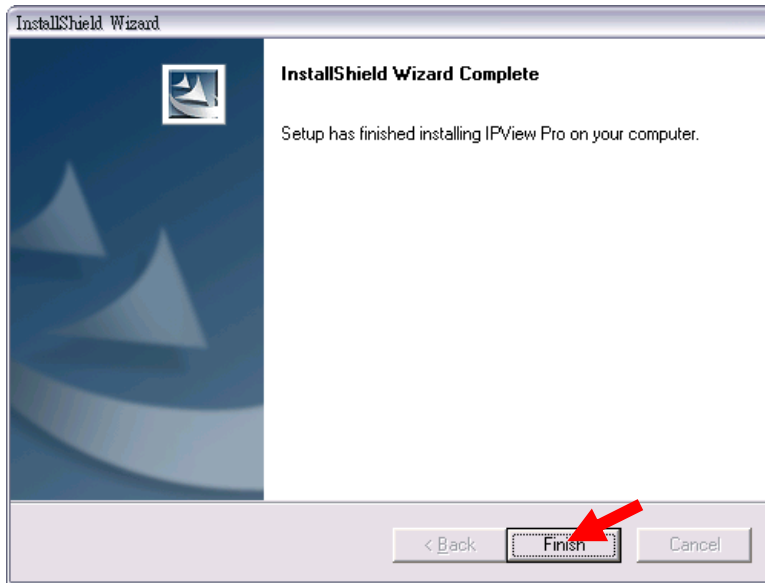

Getting Started





This section describes the User Interface of IPView Pro, with detailed procedures for using the application.









To launch IPView Pro, click **Start > Programs > IPView Pro > IPView Pro**. The main screen will appear as below:



NOTE: IPView Pro requires the system's resolution setting up to 1024x768. Please configure the resolution to 1024x768 or higher; otherwise, it may show incomplete screen when launching the program.

Item Feature

NO.	Item	Description
1	Date/Time	Show current date/time.
2	Status Mode Window	<p>Show the camera's status in this window. Click the <i>Change Status Mode</i> button () on the right lower corner of the window to change the display mode:</p> <div style="display: flex; justify-content: space-around; align-items: center;"> <div style="text-align: center;">  <p>Camera list mode</p> </div> <div style="text-align: center;">  <p>Camera information mode</p> </div> </div>
3	View Window	Show the camera's view in this window.
4	Connect/ Disconnect	Click to connect/disconnect the camera.
5	Rotate image angle	Click to rotate the image shown in the View Window.
6	Snapshot	Click to capture a still image from the View Window.
7	Audio ON/OFF	Click to turn on/off the camera's audio.
8	Zoom Mode	Click to zoom in/out the image in the View Window.
9	View Mode Buttons	<p>Select the view mode from these buttons.</p> <div style="display: flex; flex-direction: column; gap: 10px;"> <div style="display: flex; align-items: center;">  Show one camera in View Window. </div> <div style="display: flex; align-items: center;">  Show four cameras in View Window. </div> </div>

		 Show six cameras in View Window with the first one as the major view.  Show eight cameras in View Window with the first one as the major view.  Show nine cameras in View Window.  Show ten cameras in View Window with the first two as the major views.  Show thirteen cameras in View Window with the first one as the major view.  Show sixteen cameras in View Window.  Show the selected camera in full screen view.  Enable displaying the video views in circles.
10	Key Lock Button	Click to lock/unlock the camera. When locked, the user cannot operate any camera.
11	Power Button	Click to exit or minimize IPView Pro.
12	Record Button	Record video clip of the selected camera and save it in the computer. The storage position can be configured in System Configuration. When you click the button, you can select <i>Manual Record</i> , <i>Schedule Record</i> , or <i>Motion Record</i> .
13	Play Button	Play the recorded video file in the computer.
14	System Configuration	Click to enter the System Configuration.

Using IPView Pro

Adding a Camera

To add a camera:

1. Click the *System Configuration* button to enter the System Configuration.



If you are not sure of the camera's IP address, you can click *Search* to search the available camera(s) within the network.

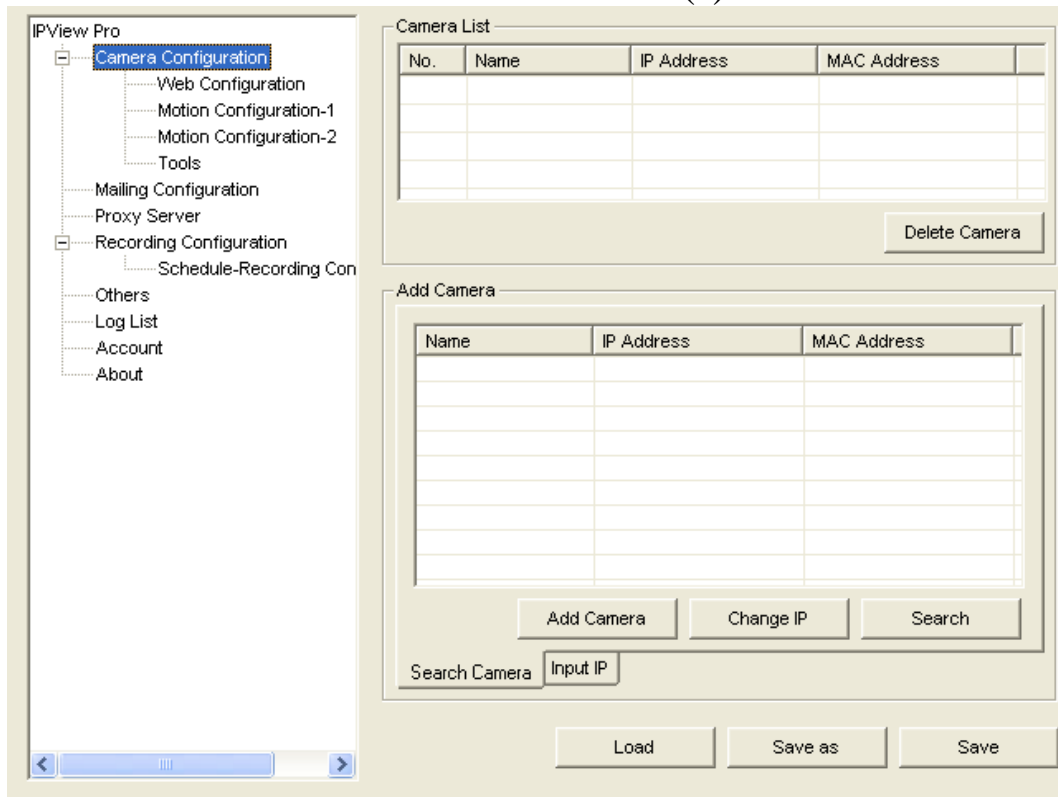

2. Select the camera you want by highlighting it, and then click **Add Camera**.

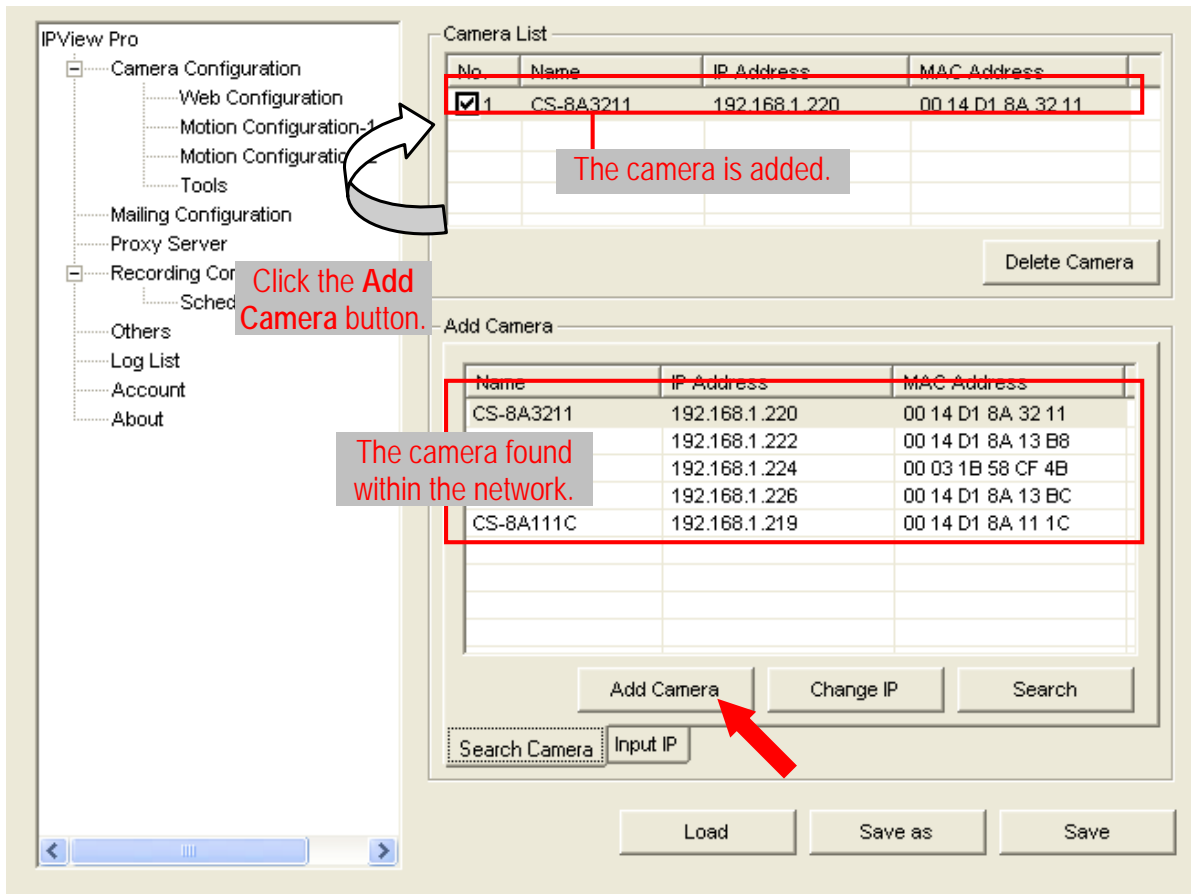

3. Click **Save**, and then click the **System Configuration** button to return to View Window. The selected camera's video will be displayed now. You can click **Save as** to save the selected cameras into the desired path and the selected cameras can be reloaded by **load** button.

Alternately, you can add a camera by entering the its IP address directly:

4. Select the **Input IP** tab.

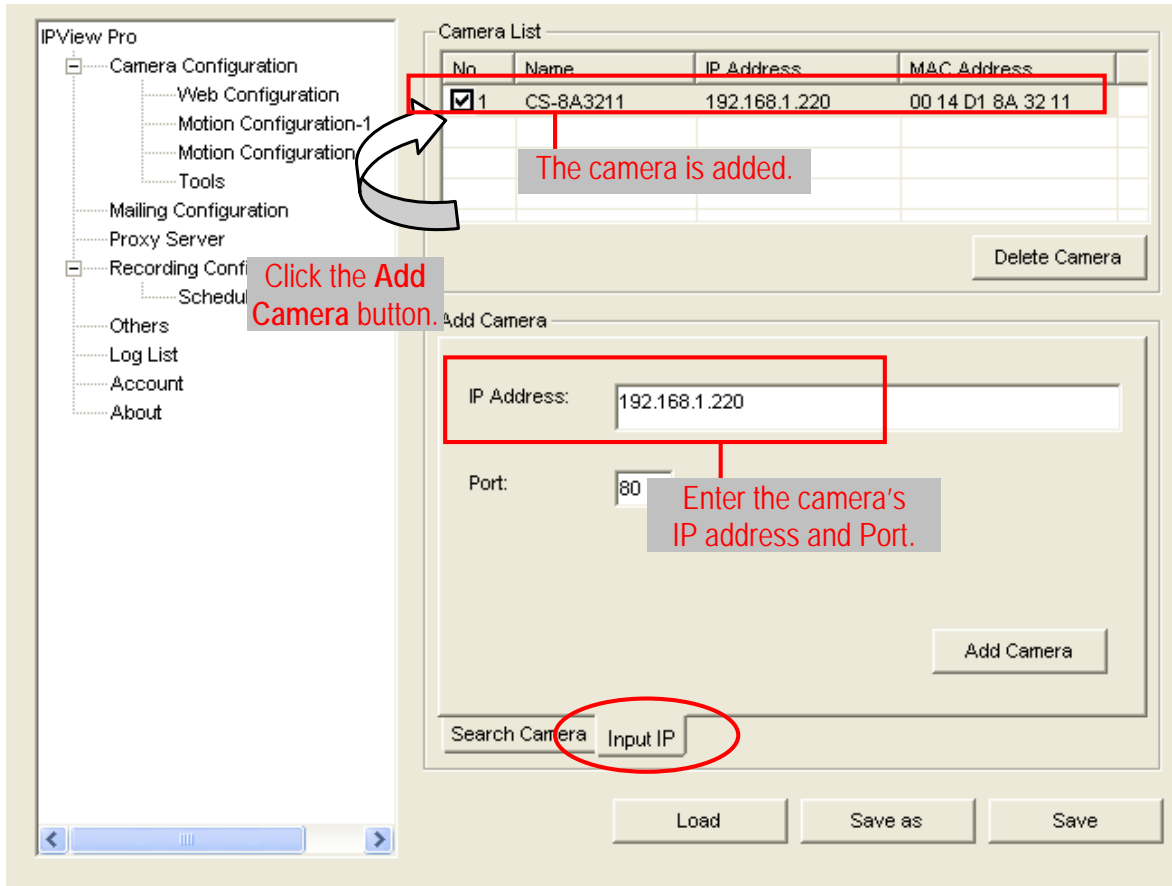

5. Enter the camera's IP address (default: 192.168.1.30) and Port (default: 80), and then click *Add Camera*.
6. Click *Save*, and then click the *System Configuration* button to return to View Window. The selected camera's video will be displayed now.

Removing a Camera

To remove the camera from the list:

1. Select the camera you want to remove.
2. Click *Delete Camera*.

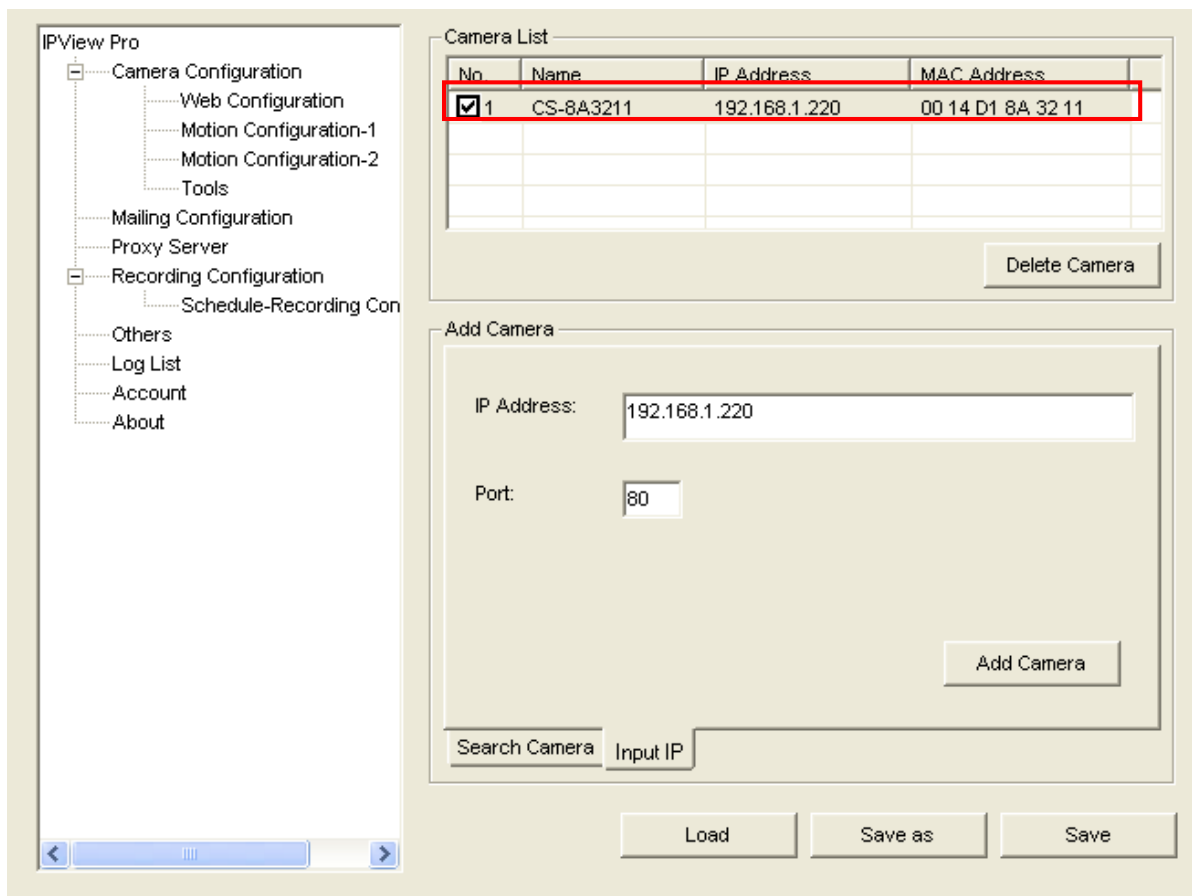

Viewing a Camera

From the View Modes of the panel, you can select one-camera mode or other modes to display your video. IPView Pro allows a maximum of 16 cameras for viewing.

For example, if you use only one camera, select one-camera mode (), and the View Window will display the view as *figure 1*.

If there are four cameras, select four-camera mode (), and the View Window will display the view as *figure 2*.

Figure 1



Figure 2



Recording Video

IPView Pro allows you to record the video clip and save it in your computer through the following methods: **Manual Record**, **Schedule Record**, and **Motion Record**.

When you click the *Record* button and select **Manual Record**, it will start recording. Click the button again to stop. If you select **Schedule Record** or **Motion Record**, the system will record the video clip according to the settings in System Configuration.

Playing Recorded Video

The recorded video clips are saved in your computer, and can be played using Windows Media Player. To start playback, simply click the *Play* button on the panel, and the following dialog screen will appear, allowing you to select the file to playback.

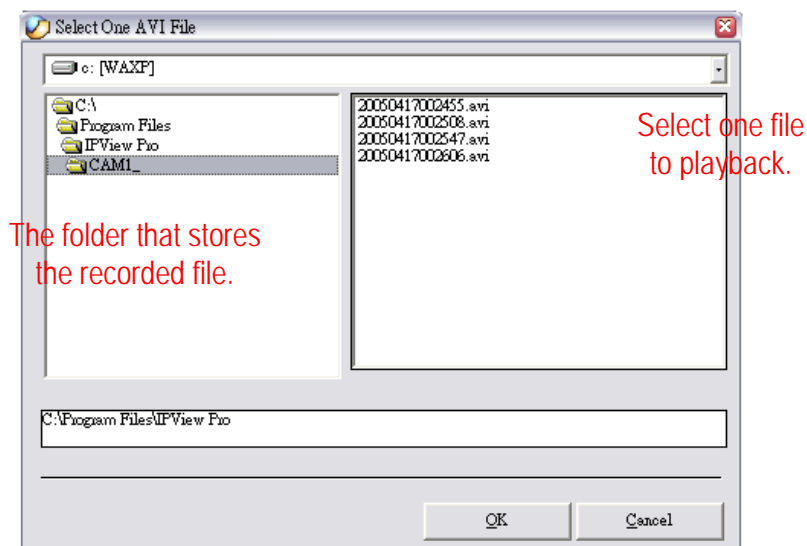

Select the recorded file in the computer, and then click *OK*.

Configuring the System

Clicking the *System Configuration* button on the panel allows you to configure the system settings, and the **System Configuration Screen** will appear in the View Window as shown below. Once configured, click *Save* to save the settings, and then click the *System Configuration* button again to exit configuration.

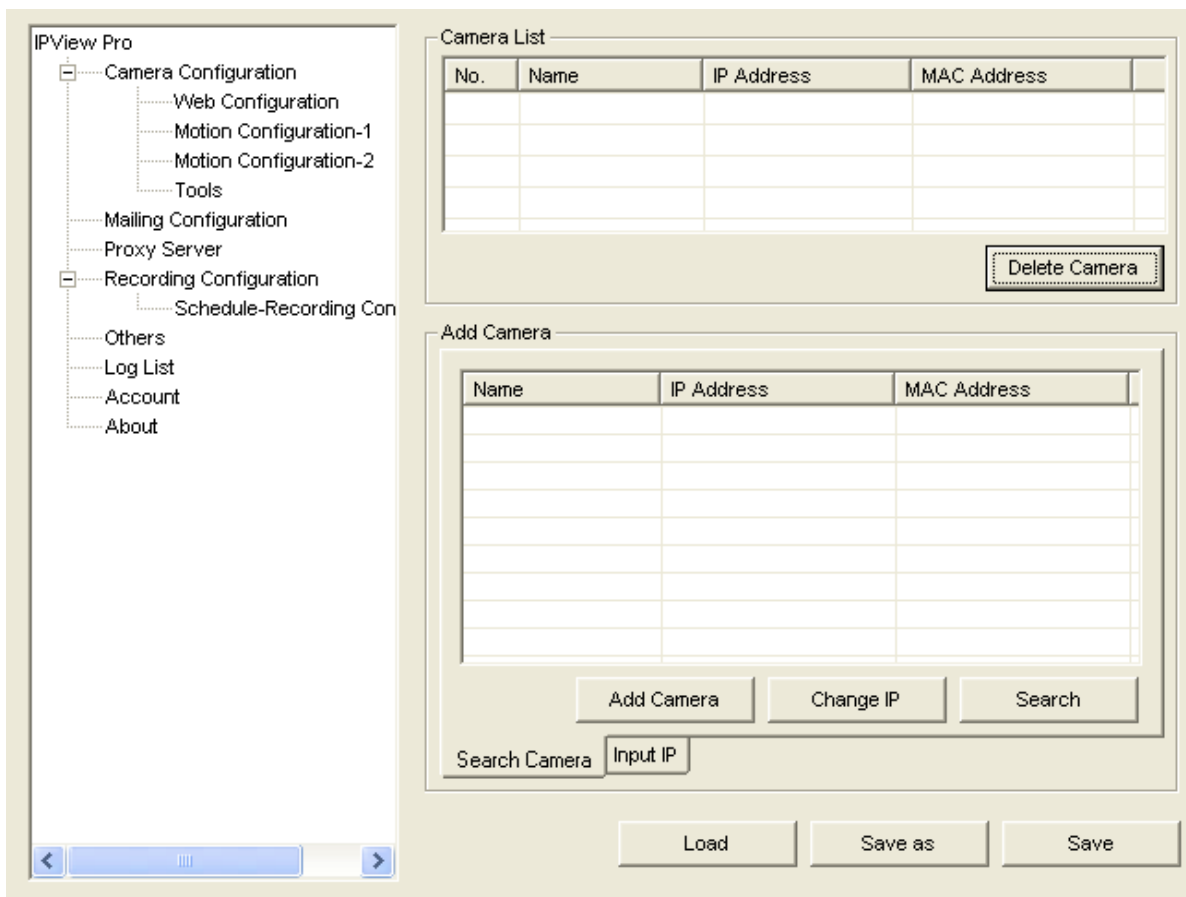

Camera Configuration

In this field, you can add/delete the camera (as described in the previous section). Also, you can configure the following settings:

Web Configuration

In the top low, selecting the **Administration** item will launch the Web Configuration Utility in View Window.

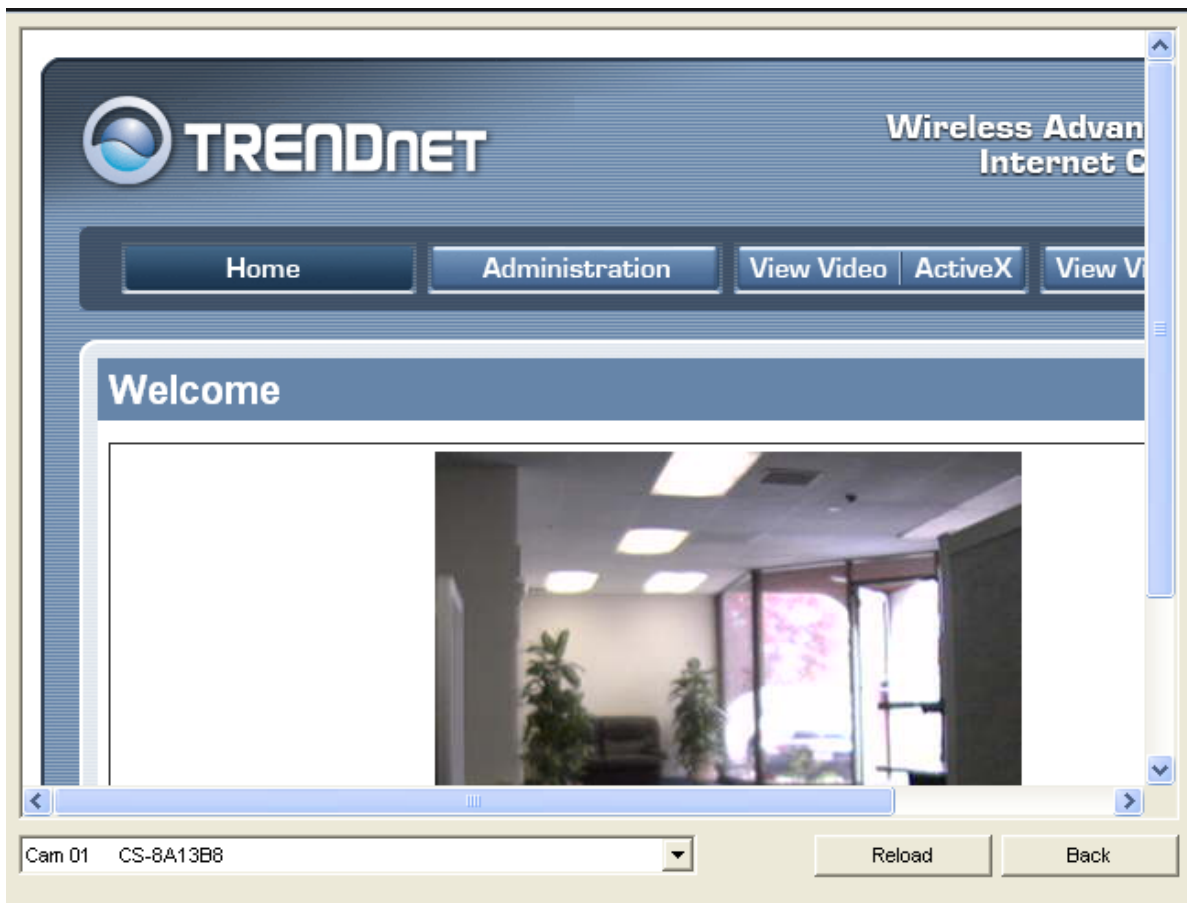

You can configure these settings according to the description in *Chapter 5, Using the Camera*. Click *Back* to exit the Web Configuration Utility.

Motion Configuration-1

The **Motion Configuration-1** item provides the commands for motion detection control. Before configuring, you should select one camera from the pull-down menu.

Select one camera.

Select Custom region.

No.	Coordinates
1	136 , 32 , 271 , 199
2	40 , 72 , 119 , 207

Region 1.

Region 2.

Sensitivity Level

Low High

Save

- **Detect Region:**
 - **Full picture** – When you select this option, the camera will monitor the whole area.

- **Custom region** – Click **Add Region**, and then use mouse to draw an area in the view screen; when some motion detected within the area, the camera starts recording automatically. You can set multiple areas in the view screen. Click **Delete Region** to remove the area selected. Click **Clear All Region** to remove all areas in the view screen.
- **Sensitivity Level:** Move the slide bar to adjust the sensitivity level for detecting motion to record video.

Motion Configuration-2

The **Motion Configuration-2** item allows you to configure to the alarm and e-mail setting.

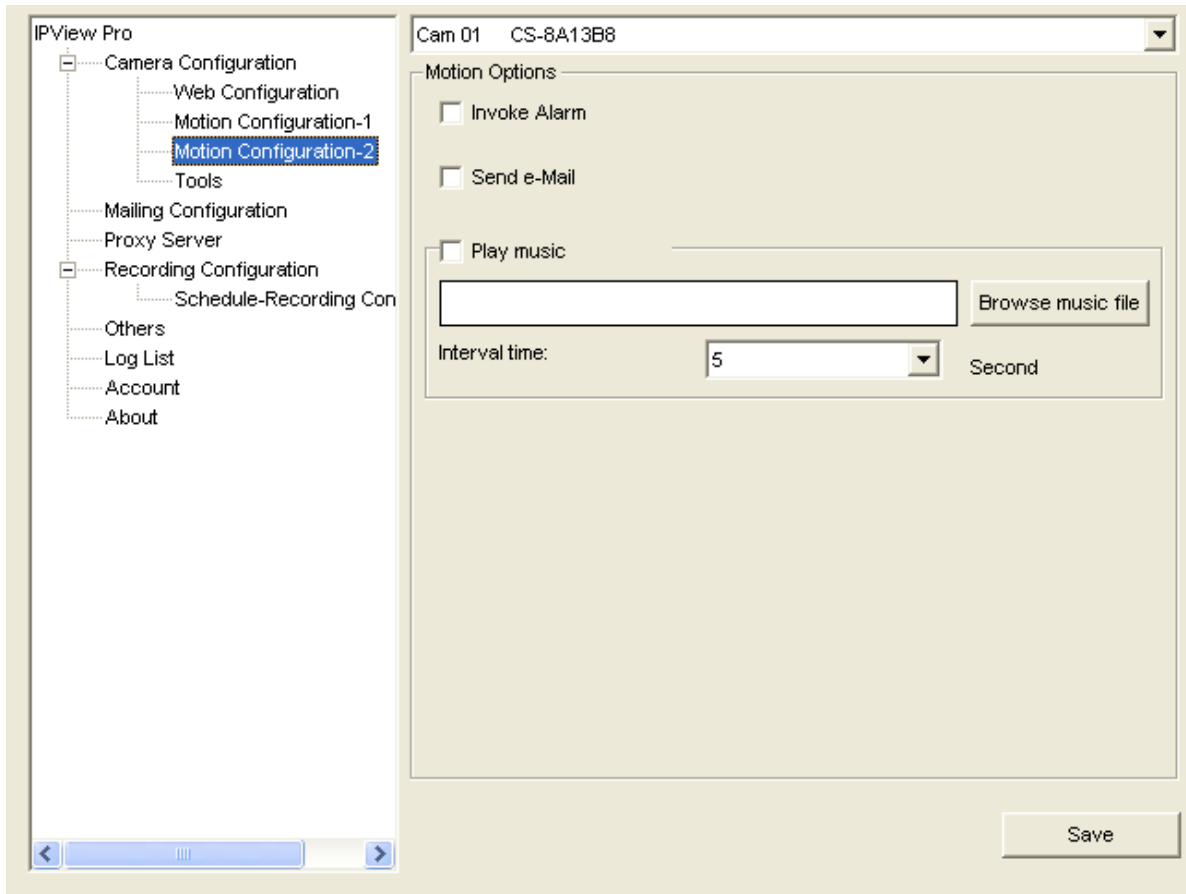

- **Invoke Alarm:** Select this option to enable alarm when some motion detected by the system.
- **Send e-mail:** When this option is checked, click the **Mailing Configuration** in the left column to enter the required information (see the following section).
- **Play music:** You can use the music file to alert the event. Click *Browse music file* to select the desired music, and set the **Interval time**.
- **Trigger1 active:** You can check this option to set the **Trigger-On holding time**.

Tools

The **Tools** item allows you to configure to the alarm and e-mail setting.

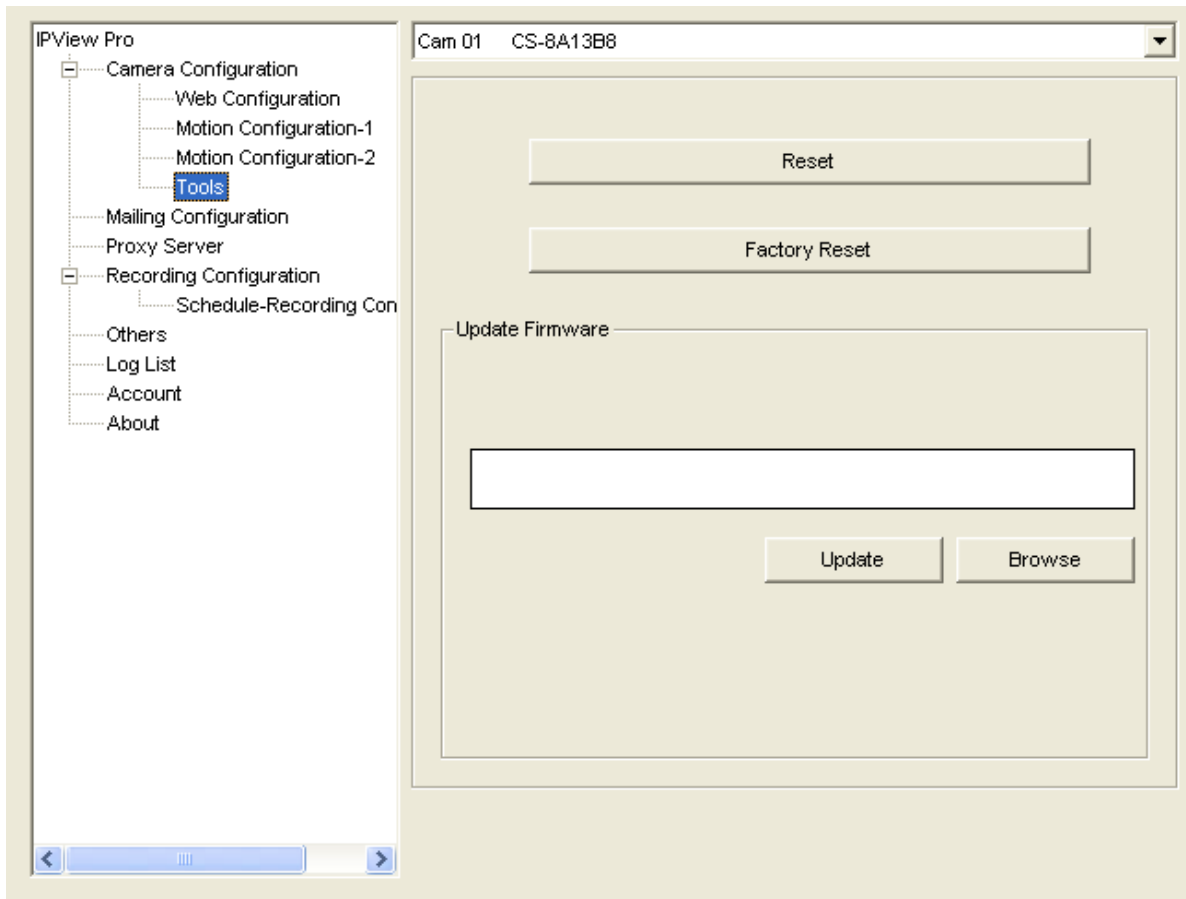

- **Reset:** Restore the original setting of your camera. Do you really want to reset this device? Click *Yes* in the pop-up dialog box to confirm.
- **Factory Reset:** Restore the factory default settings of the camera. Do you really want to factory reset this device? Click *Yes* in the pop-up dialog box to confirm.
- **Update Firmware:** When new firmware is available, you can upgrade it using this option. Click *Browse* to find the firmware file, and then click *Update*.

Mailing Configuration

When Motion Detection function is enabled and the **Send e-mail** option is checked, you should enter the required information in the respective fields.

The screenshot shows the 'Mailing Configuration' window in IPView Pro. The left sidebar contains a tree view with the following items: Camera Configuration (expanded), Web Configuration, Motion Configuration-1, Motion Configuration-2, Tools, Mailing Configuration (selected), Proxy Server, Recording Configuration (expanded), Schedule-Recording Con, Others, Log List, Account, and About. The main configuration area includes the following fields: Mail Server, Mail From, Mail To, Subject, User Name, Password, and Interval Time (set to 10 seconds). A 'Save' button is located at the bottom right of the window.

- **Mail Server:** Enter the mail server address that is used to send your e-mail.
- **Mail From/To:** Enter the sender's/receiver's e-mail address.
- **Subject:** Enter the title of the e-mail.
- **User Name/Password:** Enter the user name/password to login the mail server.
- **Interval Time:** Enter a number in this box to setup the time (in second) to send e-mail regularly.

Proxy Server

Check the Proxy Server option and enter the required settings in the **Address** and **Port** boxes to enable and use the Proxy Server function.

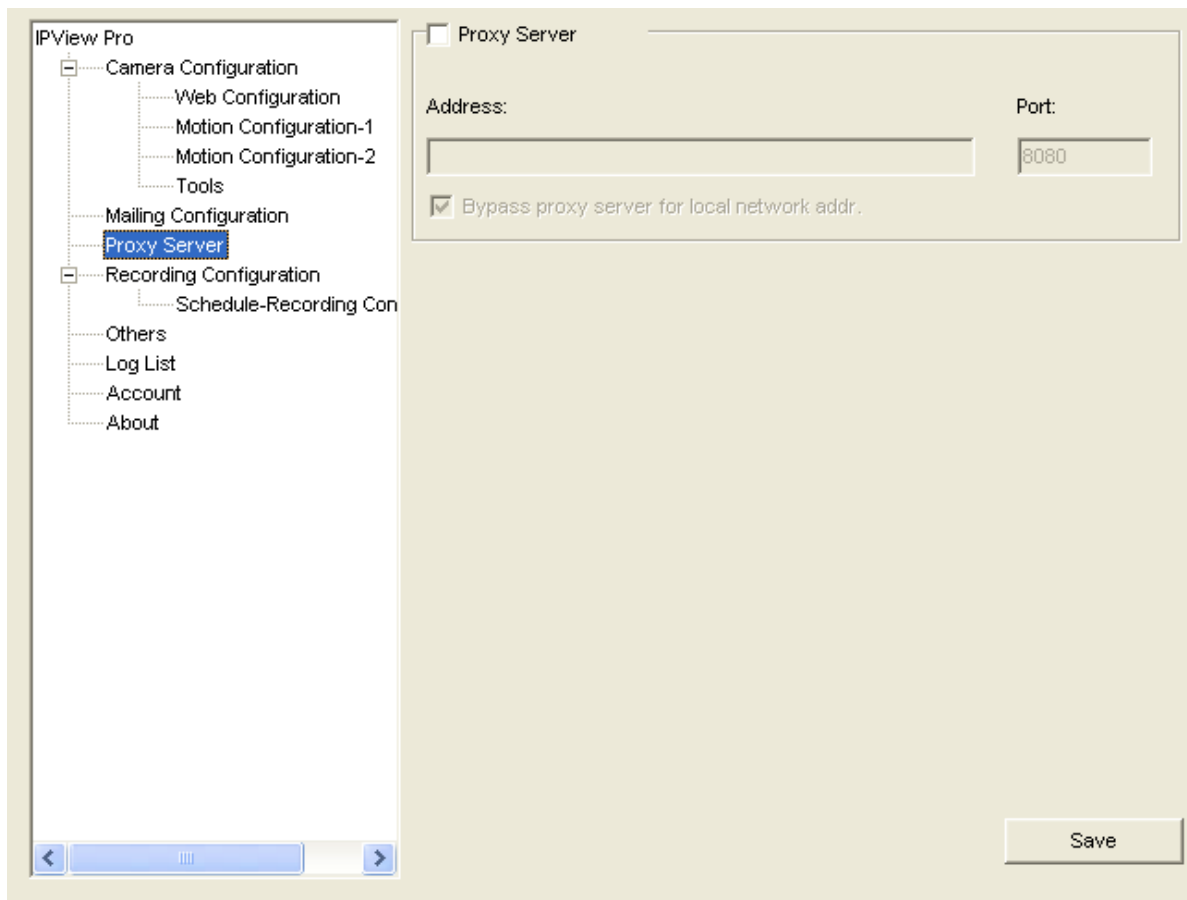

Recording Configuration

In this field, you can configure the storage settings.

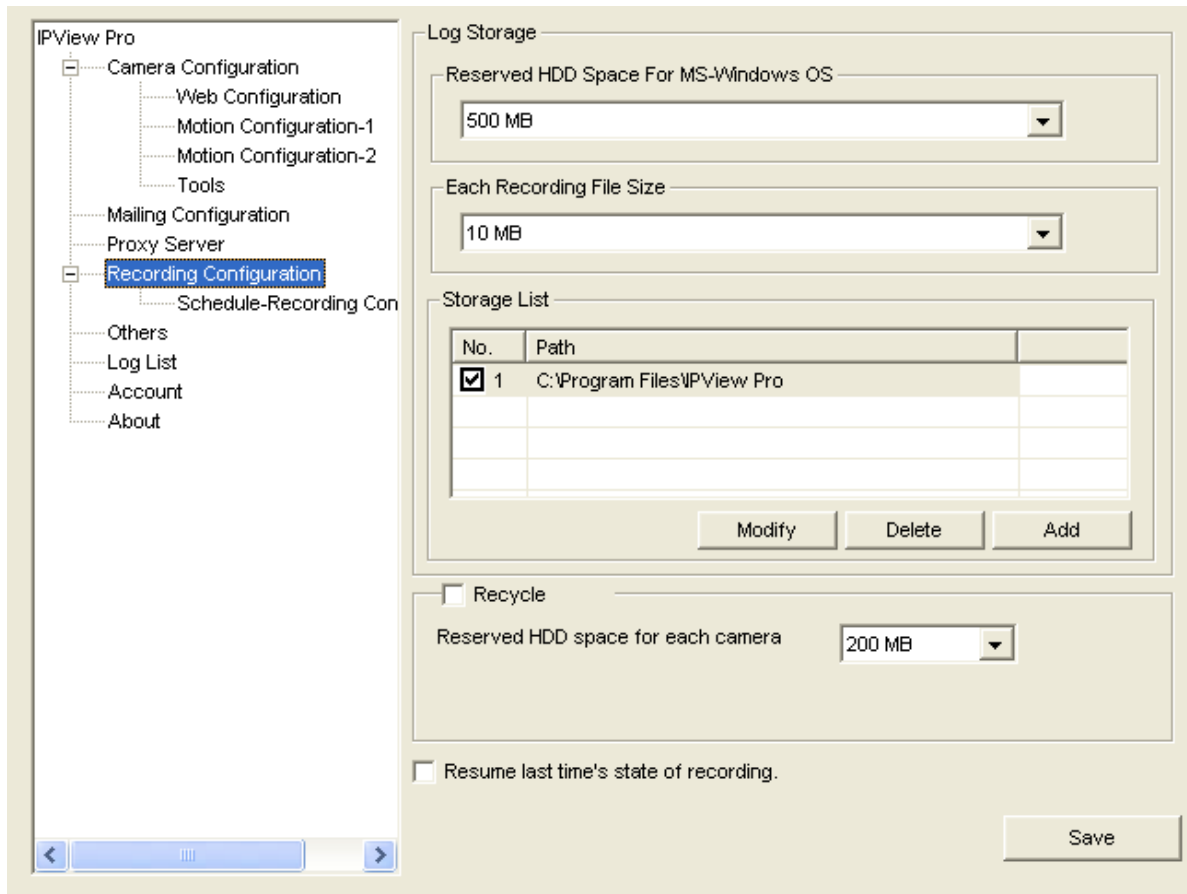

- Log Storage:

- **Reserved HDD Space For MS-Windows OS** – You can reserve **500 MB** to **10000 MB** hard disk space for the program.
- **Each Recording File Size** – If the recorded video files reach the file size limit, video images will be recorded into another file automatically. The available settings are from **10 MB** to **50 MB**.
- **Storage List** – The destination folder to save the recorded video file can be specified here. Click *Modify* to

change the current path setting; click *Add* to add a new destination folder; click *Delete* to remove a selected path setting. Please note that you are not allowed to delete a path setting if there is only one setting in the list.

- **Recycle:** You can check this option to clear the files when the unreserved space of your hard disk is filled. The available settings are from **200 MB** to **50000 MB**.
- **Resume last time's state of recording:** You can check this option to store the recording state, and resume the recording state on the next time you record.

Schedule-Recording Configuration

This recording function will work after you have enabled respective settings in the Schedule mode. The recording schedule can be defined by **Date Mode** or **Week Mode**.

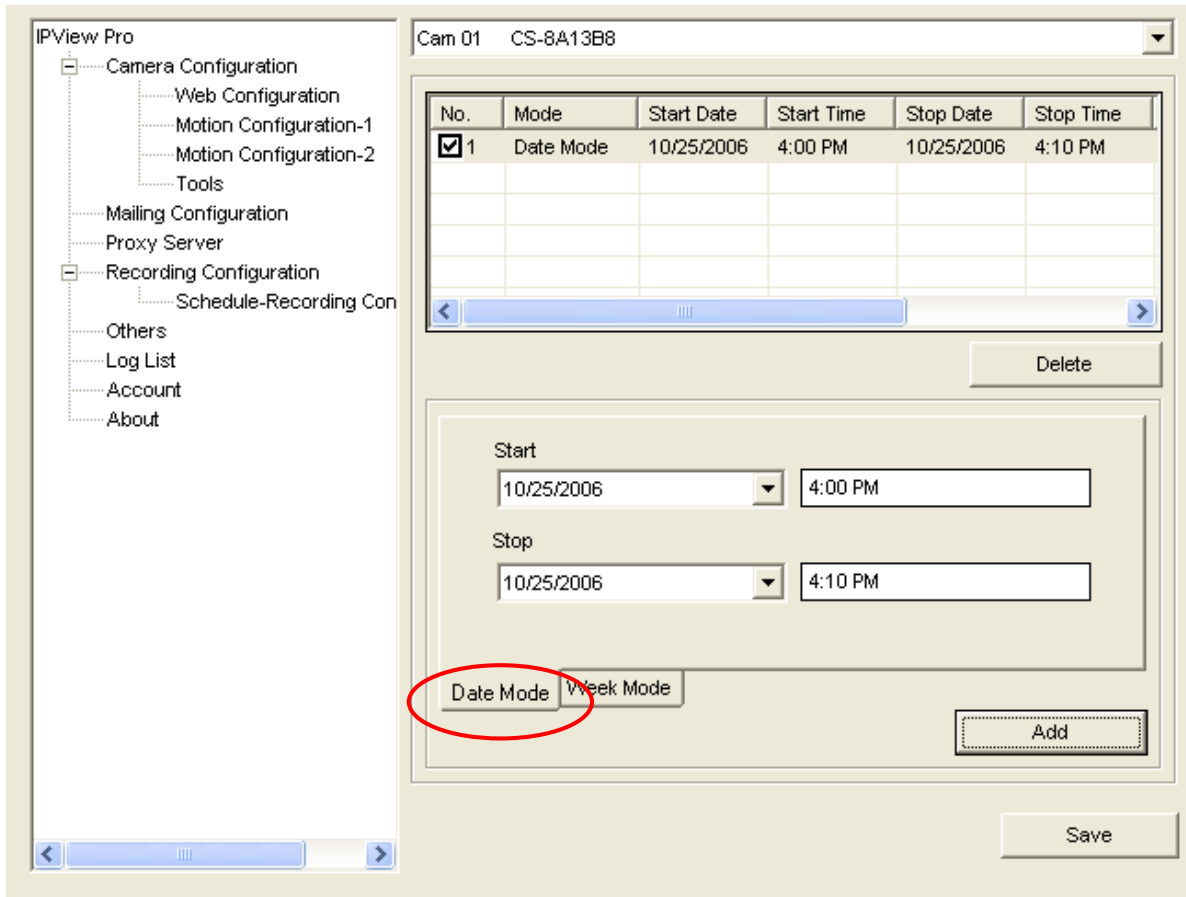

- **Date Mode:** First, select the camera desired from the pull-down menu. Then, setup the time in the **Start/Stop** fields. Click **Add** to add the recording schedule to the list. Click **Save** to save the settings.

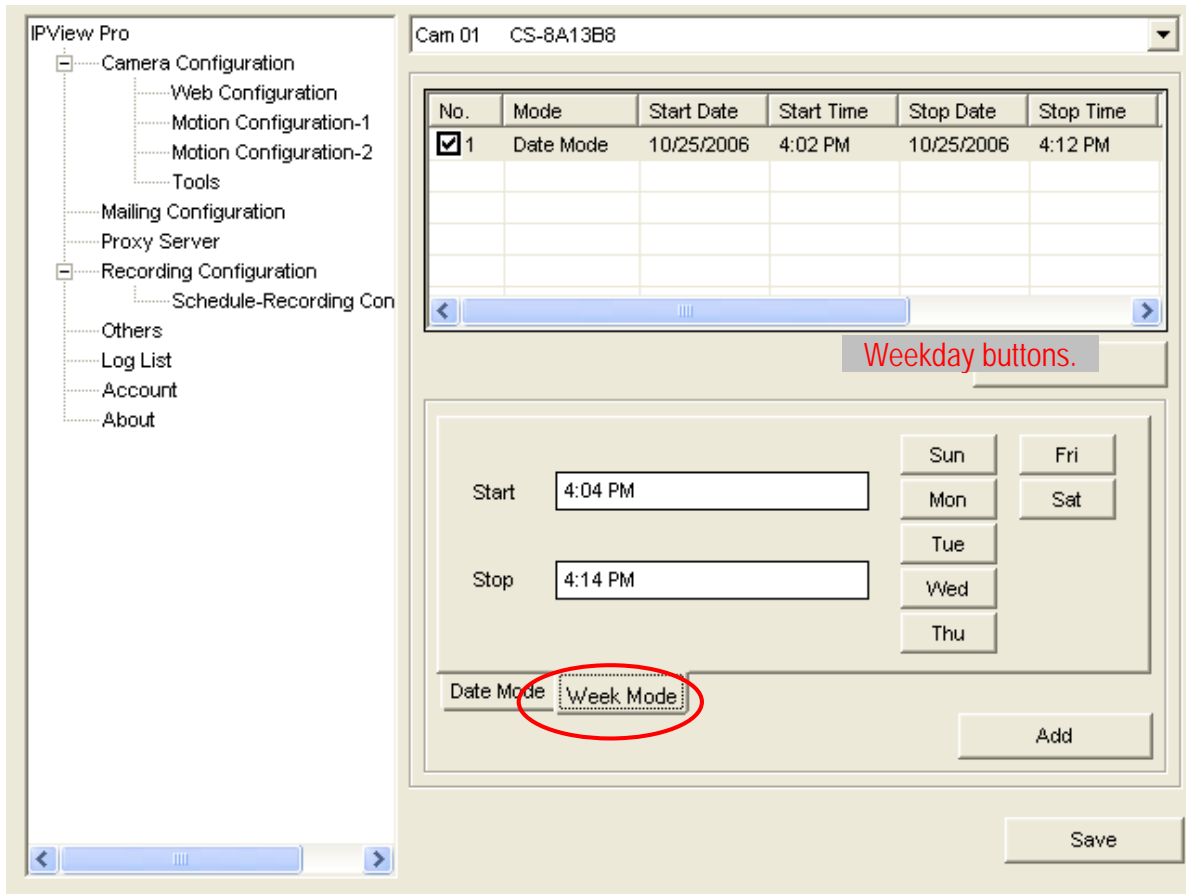

- **Week Mode:** First, select the camera desired from the pull-down menu. Then, setup the time in the **Start/Stop** fields, and select the weekday from the buttons. Click **Add** to add the recording schedule to the list. Click **Save** to save the settings.

Others

When multiple cameras connected, this option allows the system to display these views as the main view in circles according to your time settings. The range of **Time interval of scan** is from **1** to **20** seconds.

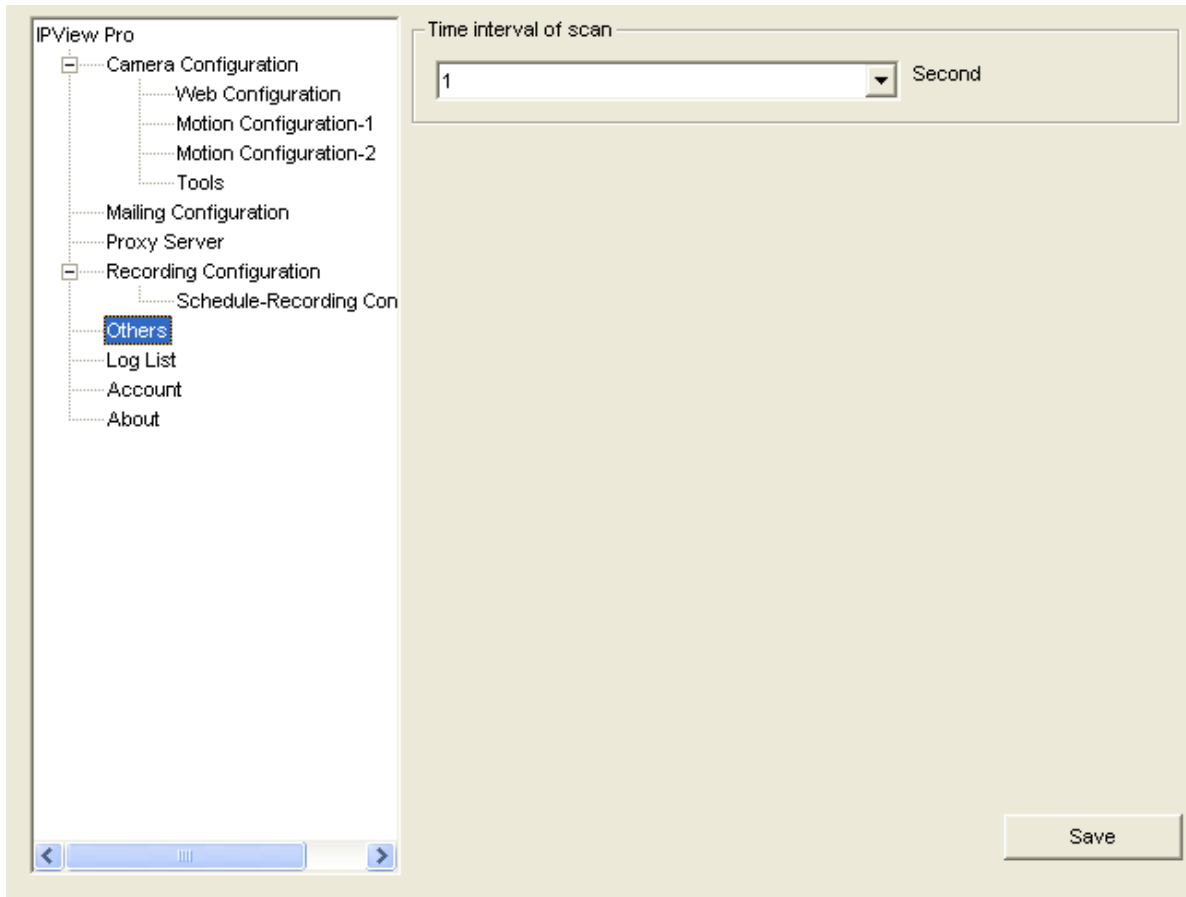

Log List

This filed displays the user(s) information, which includes the Date, MAC address, and the brief description of events.

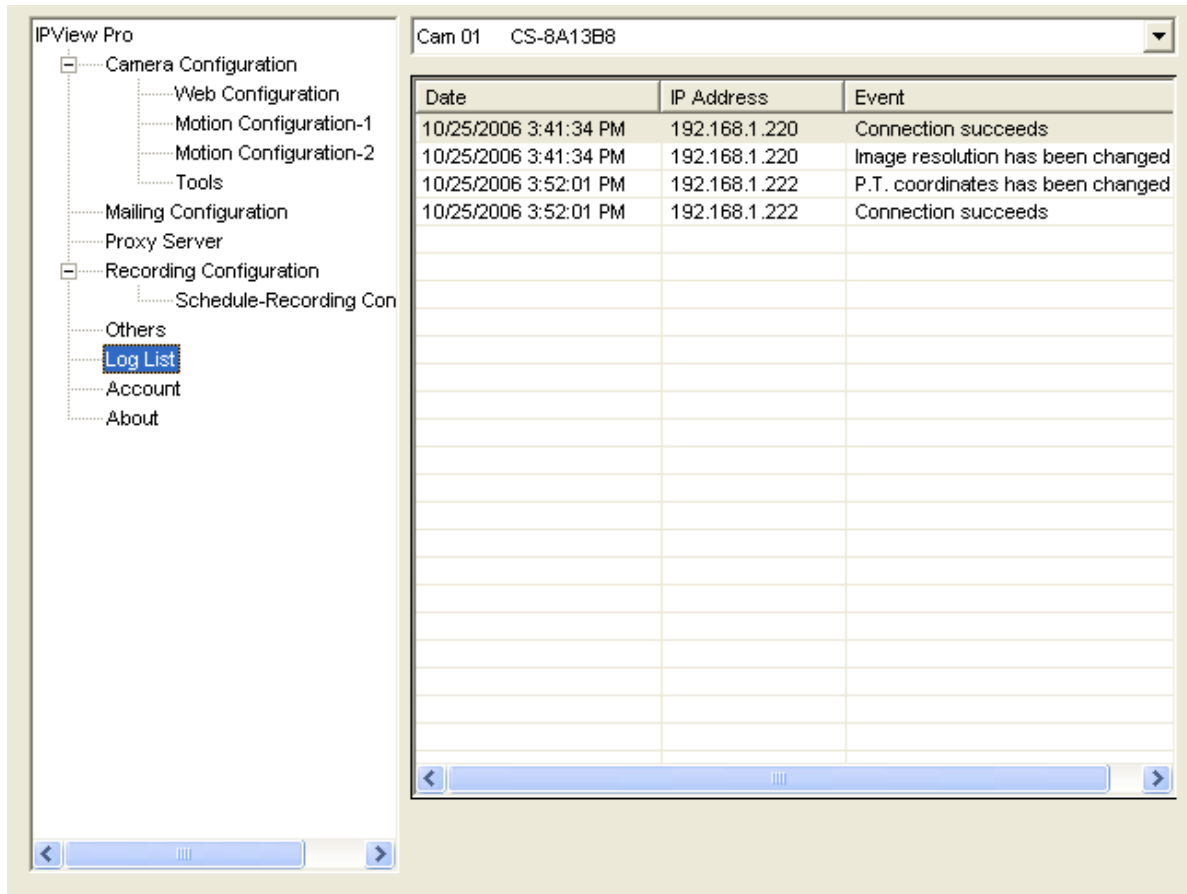

Account

This filed allows you to set the **Admin ID** and **Admin Password**. You can also check the **Login password check** option to secure your camera by checking the login password.

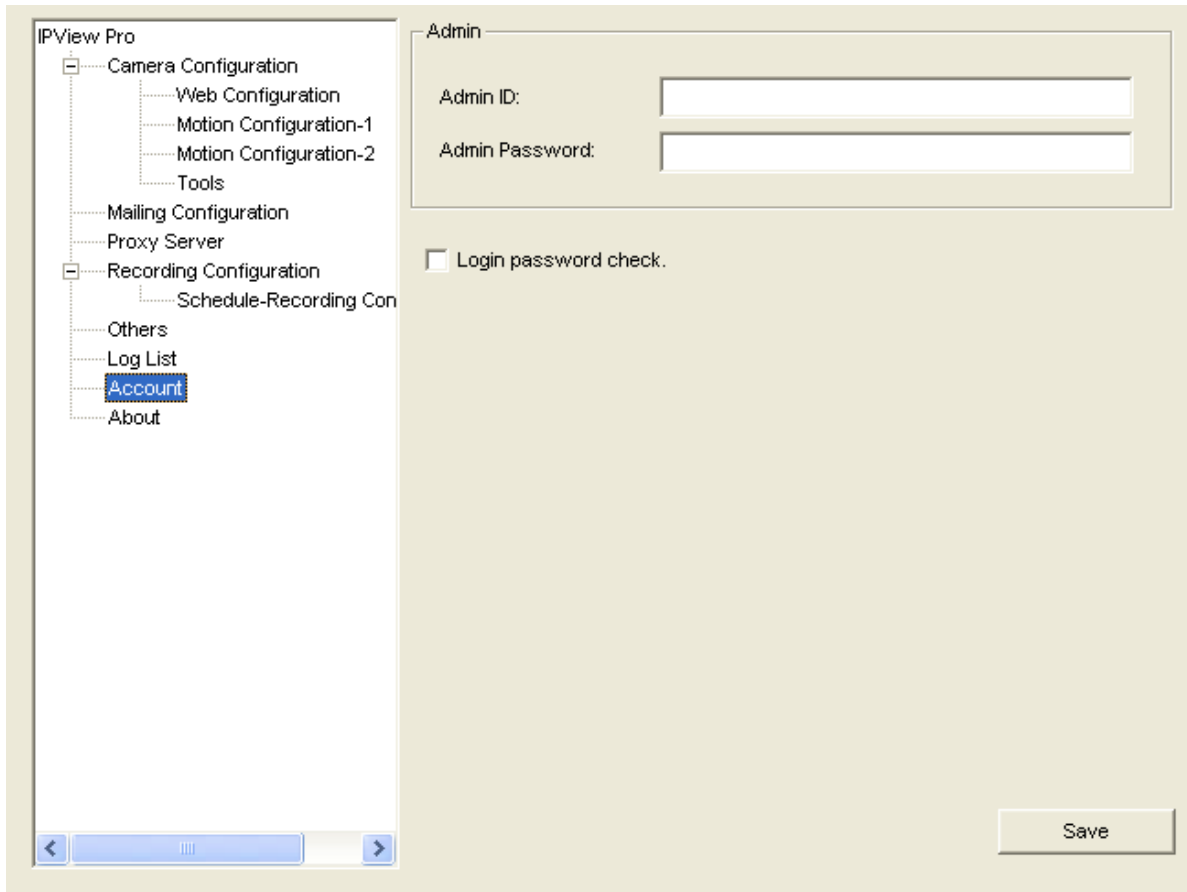

About

This file provides information of the software application.

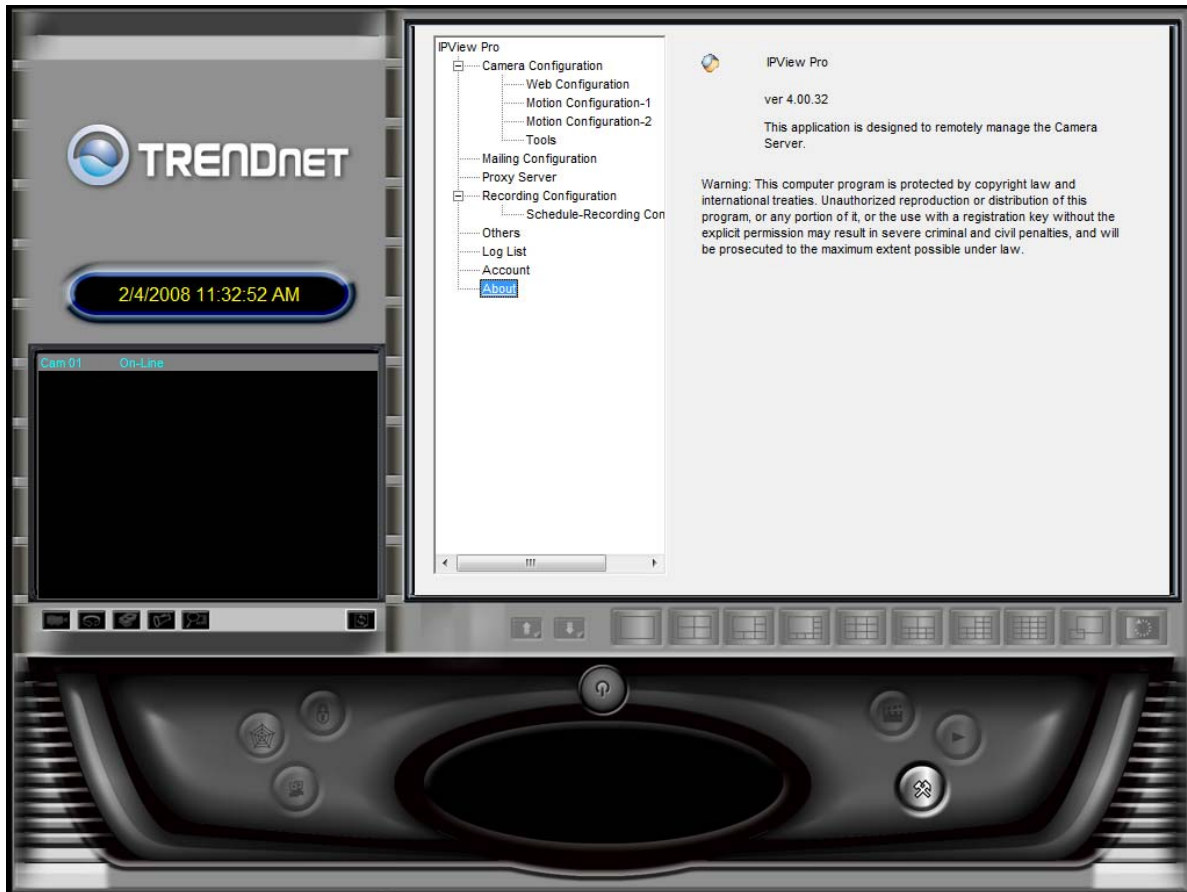

APPENDIX

A Frequently Asked Questions

Camera Features

Q: What is an Internet Camera Server?

A: The Camera is a standalone system connecting directly to an Ethernet or Fast Ethernet network and supported by the wireless transmission based on the IEEE 802.11b/g standard. It is different from the conventional PC Camera, the Camera is an all-in-one system with built-in CPU and web-based solutions providing a low cost solution that can transmit high quality video images for monitoring. The Camera can be managed remotely, accessed and controlled from any PC/Notebook over the Intranet or Internet via a web browser.

Q: What is the maximum number of users that can be allowed to access the Camera simultaneously?

A: Maximum number of users that can log onto the Camera at the same time is 64. Please keep in mind the overall performance of

the transmission speed will slow down when many users are logged on.

Q: What algorithm is used to compress the digital image?

A: The Camera utilizes the JPEG image compression technology providing high quality images for users. JPEG is adopted since it is a standard for image compression and can be applied to various web browser and application software without the need to install extra software.

Q: Can I change the wireless antenna attached to the Wireless Camera?

A: The wireless antenna can be changed for a variety of reasons such as extending the wireless transmission range, however, please consult authorized distributors before attempting as the connectors must be SMA connector type.

Q: What is the wireless transmission range for the Wireless Camera?

A: Generally the wireless distance can go up to 100 meters indoors and up to 300 meters outdoors. The range is limited by the number of walls, ceilings, or other objects that the wireless signals must pass through. Typical ranges vary depends on the types of materials and background Radio Frequency (RF) noise in your home or business and the configuration setting of your network environment.

Camera Installation

Q: Can the Camera be used out-doors?

A: The Camera is not weatherproof. It needs to be equipped with a weatherproof case to be used outdoors and it is not recommended.

Q: What network cabling is required for the Camera?

A: The Camera uses Category 5 UTP cable allowing 10 Base-T and 100 Base-T networking.

Q: Can the Camera be setup as a PC-Cam on the computer?

A: No, the Camera is an Camera used only on Ethernet and Fast Ethernet network and wireless transmission (Wireless only for TV-IP100W-N).

Q: Can the Camera be connected on the network if it consists of only private IP addresses?

A: The Camera can be connected to LAN with private IP addresses.

Q: Can the Camera be installed and work if a firewall exists on the network?

A: If a firewall exists on the network, port 80 is open for ordinary data communication. However, since the Wireless Camera transmits image data, the default port 8481 is also required. Therefore, it is necessary to open port 8481 of the network for remote users to access the Camera.

B PING Your IP Address

The PING (Packet Internet Groper) command can determine whether a specific IP address is accessible by sending a packet to the specific address and waiting for a reply. It can also provide a very useful tool to confirm if the IP address conflicts with the Wireless Camera over the network.

Follow the step-by-step procedure below to utilize the PING command. However, you must disconnect the Wireless Camera from the network first.

Start a DOS window.

Type ping x.x.x.x, where x.x.x.x is the IP address of the Wireless Camera.

The succeeding replies as illustrated below will provide useful explanation to the cause of the problem with the Wireless Camera IP address.

C Trouble Shooting

Q: I cannot access the Camera from a web browser.

A1: The possible cause might be the IP Address for the Camera is already being used by another device. To correct the possible problem, you need to first disconnect the Camera from the network. Then run the PING utility (follow the instructions in Appendix B - PING Your IP Address).

A2: Another possible reason is the IP Address is located on a different subnet. To fix the problem, run the PING utility (follow the instructions in Appendix B - PING Your IP Address). If the utility returns “no response” or similar, the finding is probably correct, then you should proceed as follows:

In Windows 95/98/2000 and Vista, double check the IP Address of the Wireless Camera is within the same subnet as your workstation.

Click “Start”, “Setting”, “Control Panel”, and the “Network” icon. Select TCP/IP from the “Network” dialog box and from the “TCP/IP Properties” dialog box click “Specify an IP address”.

If the Camera is situated on a different subnet than your workstation, you will not be able to set the IP address from this workstation. To verify make sure the first 3 sections of the IP address of the Camera corresponds to the first 3 sections of the workstation. Therefore the IP address of the Wireless Camera must be set from a workstation on the same subnet.

A3: Other possible problems might be due to the network cable. Try replacing your network cable. Test the network interface of the product by connecting a local computer to the unit, utilizing a standard Crossover (hub to hub) Cable. If the problem is not solved the Camera might be faulty.

Q: Why does the Power LED not light up constantly?

A: The power supply used might be at fault. Confirm that you are using the provided power supply DC 5V for the camera and verify that the power supply is well connected.

Q: Why does the Link LED not light up properly?

A1: There might be a problem with the network cable. To confirm that the cables are working, PING the address of a know device on the network. If the cabling is OK and your network is reachable, you should receive a reply similar to the following (...bytes = 32 time = 2 ms).

A2: The network device utilized by the camera is not functioning properly such as hubs or switches. Confirm the power for the devices are well connected and functioning.

A3: The wireless connection might be at fault. In ad-hoc mode make sure the wireless camera's wireless channel and SSID is set to match the PC/Notebook wireless channel and SSID for direct communication.

Under infrastructure mode make sure the SSID on the PC/Notebook and the Wireless Camera must match with the access point's SSID.

Q: Why does the Wireless Camera work locally but not externally?

A1: Might be caused from the firewall protection. Need to check the Internet firewall with your system administrator.

A2: The default router setting might be a possible reason. Need to double check if the configuration of the default router settings is required.

Q: Why does a series of broad vertical white line appear through out the image?

A: A likely issue is that the CMOS sensor becomes overloaded when the light source is too bright such as direct exposure to sunlight or halogen light. You need to reposition the Wireless Camera into a more shaded area immediately as this will damage the CMOS sensor.

Q: There is bad focus on the camera, what should be done?

A1: The focus might not be correctly adjusted for the line of sight. You need to adjust the camera focus manually as described in Adjust Camera Focus.

A2: There is no adaptor fitted with your C-type lens. If you have previously changed the supplied CS-type lens, you may have unintentionally installed a C-type lens without fitting the adaptor first.

Q: Noisy images occur how can I solve the problem?

A1: The video images might be noisy if the Wireless Camera is used in a very low light environment. To solve this issue you need more lighting.

A2: There might be wireless transmission interference make sure there are no other wireless devices on the network that will affect the wireless transmission.

Q: There is poor image quality, how can I improve the image?

A1: A probable cause might be the incorrect display properties configuration for your desktop. You need to open the Display Properties on your desktop and configure your display to show at least 65'000 colors for example at least 16-bit.

NOTE: *Applying only 16 or 256 colors on your computer will produce dithering artifacts in the image.*

A2: The configuration on the Wireless Camera image display is incorrect. Through the Web Configuration Image section you need to adjust the image related parameter for improve images such as brightness, contrast, hue and light frequency. Please refer to the Web Configuration section for detail information.

Q: There are no images available through the web browser?

A: The ActiveX might be disabled. If you are viewing the images from Internet Explorer make sure ActiveX has been enabled in the Internet Options menu. Alternatively, you can use the Java Applet (JRE) for viewing the required images.

D Time Zone Table

(GMT-12:00) Eniwetok, Kwajalein
(GMT-11:00) Midway Island, Samoa
(GMT-10:00) Hawaii
(GMT-09:00) Alaska
(GMT-08:00) Pacific Time (US & Canada); Tijuana
(GMT-07:00) Arizona
(GMT-07:00) Mountain Time (US & Canada)
(GMT-06:00) Central Time (US & Canada)
(GMT-06:00) Mexico City, Tegucigalpa
(GMT-06:00) Saskatchewan
(GMT-05:00) Bogota, Lima, Quito
(GMT-05:00) Eastern Time (US & Canada)
(GMT-05:00) Indiana (East)
(GMT-04:00) Atlantic Time (Canada)
(GMT-04:00) Caracas, La Paz

(GMT-04:00) Santiago
(GMT-03:30) Newfoundland
(GMT-03:00) Brasilia
(GMT-03:00) Buenos Aires, Georgetown
(GMT-02:00) Mid-Atlantic
(GMT-01:00) Azores, Cape Verde Is.
(GMT) Casablanca, Monrovia
(GMT) Greenwich Mean Time : Dublin, Edinburgh, Lisbon, London
(GMT+01:00) Amsterdam, Berlin, Bern, Rome, Stockholm, Vienna
(GMT+01:00) Belgrade, Bratislava, Budapest, Ljubljana, Prague
(GMT+01:00) Brussels, Copenhagen, Madrid, Paris, Vilnius
(GMT+01:00) Sarajevo, Skopje, Sofija, Warsaw, Zagreb
(GMT+02:00) Athens, Istanbul, Minsk
(GMT+02:00) Bucharest
(GMT+02:00) Cairo

(GMT+02:00) Harare, Pretoria
 (GMT+02:00) Helsinki, Riga, Tallinn
 (GMT+02:00) Jerusalem
 (GMT+03:00) Baghdad, Kuwait, Riyadh
 (GMT+03:00) Moscow, St. Petersburg, Volgograd
 (GMT+03:00) Nairobi
 (GMT+03:30) Tehran
 (GMT+04:00) Abu Dhabi, Muscat
 (GMT+04:00) Baku, Tbilisi
 (GMT+04:30) Kabul
 (GMT+05:00) Ekaterinburg
 (GMT+05:00) Islamabad, Karachi, Tashkent
 (GMT+05:30) Bombay, Calcutta, Madras, New Delhi
 (GMT+06:00) Astana, Almaty, Dhaka
 (GMT+06:00) Colombo

 (GMT+07:00) Bangkok, Hanoi, Jakarta
 (GMT+08:00) Beijing, Chongqing, Hong Kong, Urumqi
 (GMT+08:00) Perth
 (GMT+08:00) Singapore
 (GMT+08:00) Taipei
 (GMT+09:00) Osaka, Sapporo, Tokyo
 (GMT+09:00) Seoul
 (GMT+09:00) Yakutsk
 (GMT+09:30) Adelaide
 (GMT+09:30) Darwin
 (GMT+10:00) Brisbane
 (GMT+10:00) Canberra, Melbourne, Sydney
 (GMT+10:00) Guam, Port Moresby
 (GMT+10:00) Hobart
 (GMT+10:00) Vladivostok

 (GMT+08:00) Singapore
 (GMT+08:00) Taipei
 (GMT+09:00) Osaka, Sapporo, Tokyo
 (GMT+09:00) Seoul
 (GMT+09:00) Yakutsk
 (GMT+09:30) Adelaide
 (GMT+09:30) Darwin
 (GMT+10:00) Brisbane
 (GMT+10:00) Canberra, Melbourne, Sydney
 (GMT+10:00) Guam, Port Moresby
 (GMT+10:00) Hobart
 (GMT+10:00) Vladivostok
(GMT+11:00) Magadan, Solomon Is., New Caledonia
 (GMT+12:00) Auckland, Wellington
 (GMT+12:00) Fiji, Kamchatka, Marshall Is.

E Xplug Control Installation

Installation to Web Server

Important Information

It is highly recommended to install the Xplug Control application to the Web Server for IE 5.0. It must be installed to a Public Domain with Fixed IP address.

1. Installation:

Copy the “xplug.ocx” file to any WEB Server table.

2. Setting (Configuration):

From the Web Configuration menu select “System” and under the “Loading ActiveX From” input web server location

(<http://www.web server location.com/>).

Once the settings are completed, the user now is able to access the Camera from the web browser by selecting the image view – ActiveX mode.

Installation to Local PC

Insert the CD-ROM into the CD-ROM drive to initiate the auto-run program. Once completed, a menu screen will appear as below:



To install Xplug Control, click the “**Xplug Control**” button to activate the installation procedure for the plug-in program.

Once executed, a prompt will appear requesting the input of the desired language selection. Make the desired selection and click “**OK**” to continue.



The Welcome screen will appear. Click the “**N**ext” button to proceed with the installation.

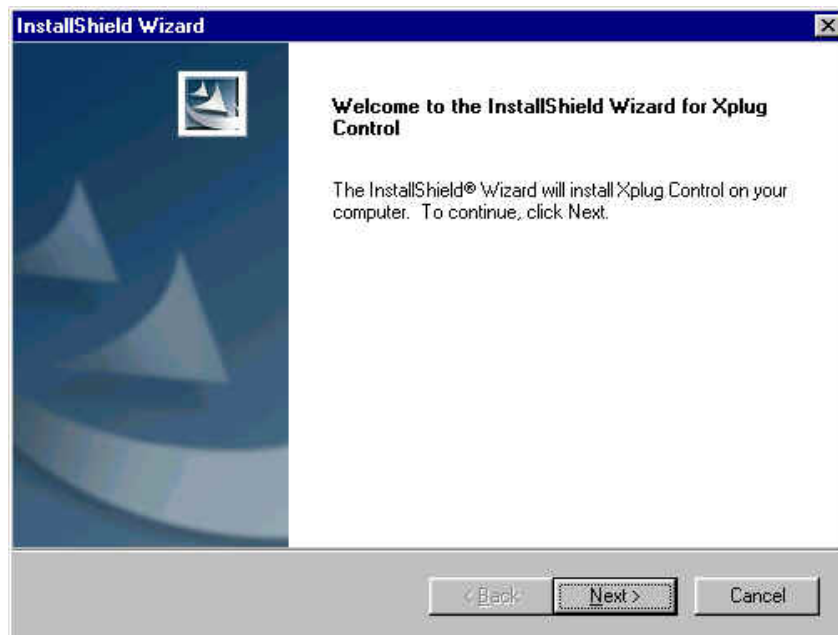

The License Agreement prompt will appear as below. Read the details carefully and click the “**Y**es” button to continue with the installation procedure.



Click the “**Finish**” button to complete Setup of the Xplug Control Utility program for the Wireless Camera.

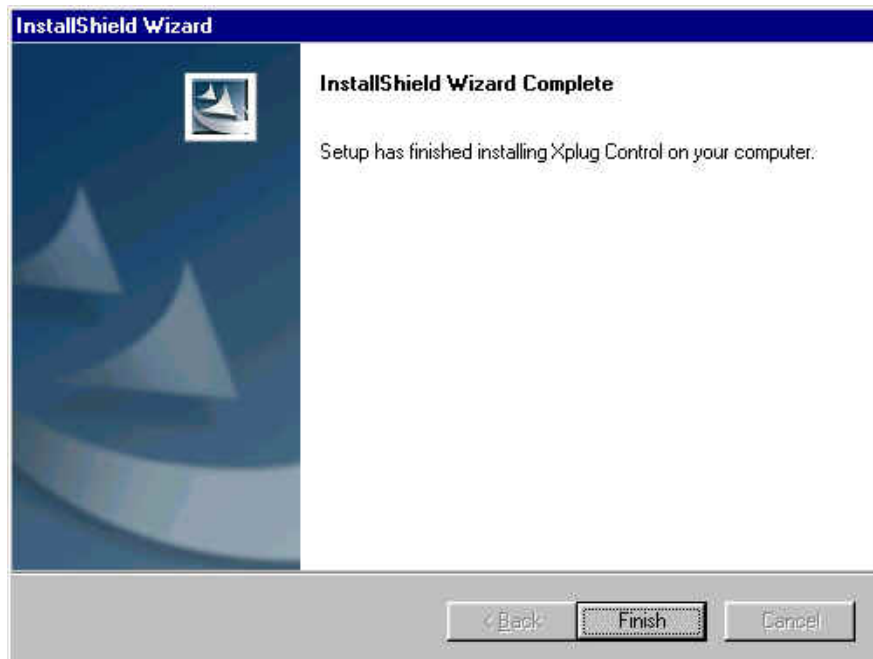

F Adjust Camera Focus

To adjust the focus of the lens, you need to turn the lens slowly in either clockwise or anti-clockwise direction until the desired image appears. DO NOT over turn the lens in either of the directions, as it will be out of focus.



NOTE: You can further adjust the Wireless Camera's image quality through System Administration – Image of Web Configuration. Please refer to Web Configuration section for further details.

Warning

Direct exposure to sunlight may cause permanent damage to the CMOS sensor. Therefore do not expose the Internet Camera's lens directly to sunlight. When operation is required in glaring light environment, it is recommended to use an iris lens.

The Internet Camera is designed for indoor usage and if your application requires prolong exposure to sunlight, a sun visor is recommended to protect the Internet Camera.

G Specification

Video specification

Resolution:	160 x 120, 320 x 240, 640 x 480 pixel
Sensor:	Color CMOS sensor
Lens:	f: 6.0 mm, F: 1.8
Gain control:	Automatic
Exposure:	Automatic
White Balance:	Automatic

Image (Video Setting)

Image compression:	JPEG
Frame rate:	30fps @ QCIF, 25fps @ CIF, 10fps @ VGA
Compression Rate selection:	5 levels: Very low/Low/Middle/High/Very high
Frame rate setting:	1, 5, 7, 15, 20, Auto (depends on the video format)
Video resolution:	160x120, 320x240, 640x480

Hardware Interface

LAN Connector:	One RJ-45 port, 10/100M auto-sensed, Auto-MDIX
Wireless LAN:	Built-in 802.11g wireless LAN
Communication protocol:	HTTP, FTP, TCP/IP, UDP, ARP, ICMP, BOOTP, DHCP, PPPoE, SMTP, DDNS, UPnP

CPU:	RDC R2880
RAM:	8MB
Flash ROM:	2MB
OS:	RTOS
Power Supply:	DC 5V, switching type
Power consumption:	5 Watt (1000mA x 5V)
LED Indicator:	Power LED (Blue) Activity LED (Orange)

Software

Browser:	Internet Explorer 5.0 or above; Netscape 6.0 or above
Application Software:	IPView PRO
OS supported:	Microsoft Windows 98SE/ME/ 2000/XP/Vista, Windows NT4.0

Operating environment

Operating temperature:	5°C ~ 40°C
Storage temperature:	-25°C ~ 50°C
Humidity:	5% ~ 95%, non-condensing

EMI

FCC, CE

H Glossary of Terms

NUMBERS

10BASE-T 10BASE-T is Ethernet over UTP Category III,IV, or V unshielded twisted-pair media.

100BASE-TX The two-pair twisted-media implementation of 100BASE-T is called *100BASE-TX*.

802.11g An IEEE standard for wireless local area networks. It offers transmissions speeds at up to 54 Mbps in the 2.4-GHz band.

A

Access point It is the hardware interface between a wireless LAN and a wired LAN. The access point attaches to the wired LAN through an Ethernet connection.

Applet Applets are small Java (JRE) programs that can be embedded in an HTML page. The rule at the moment is that an applet can only make an Internet connection to the computer from that the applet was sent.

ASCII American Standard Code For Information Interchange, it is the standard method for encoding characters as 8-bit sequences of binary numbers, allowing a maximum of 256 characters.

ARP Address Resolution Protocol. ARP is a protocol that resides at the TCP/IP Internet layer that delivers data on the same network by translating an IP address to a physical address.

AVI Audio Video Interleave, it is a Windows platform audio and video file type, a common format for small movies and videos.

B

BOOTP Bootstrap Protocol is an Internet protocol that can automatically configure a network device in a diskless workstation to give its own IP address.

C

Communication Communication has four components: sender, receiver, message, and medium. In networks, devices and application tasks and processes communicate messages to each other over media. They represent the sender and receivers. The data they send is the message. The cabling or transmission method they use is the medium.

Connection In networking, two devices establish a connection to communicate with each other.

D

DHCP Dynamic Host Configuration Protocol was developed by Microsoft a protocol for assigning dynamic IP

addresses to devices on a network. With dynamic addressing, a device can have a different IP address every time it connects to the network. In some systems, the device's IP address can even change while it is still connected. DHCP also supports a mix of static and dynamic IP addresses. This simplifies the task for network administrators because the software keeps track of IP addresses rather than requiring an administrator to manage the task. This means a new computer can be added to a network without the hassle of manually assigning it a unique IP address. DHCP allows the specification for the service provided by a router, gateway, or other network device that automatically assigns an IP address to any device that requests one

DNS

Domain Name System is an Internet service that translates domain names into IP addresses. Since domain names are alphabetic, they're easier to remember. The Internet however, is really based on IP addresses every time you use a domain name the DNS will translate the name into the corresponding IP address. For example, the domain name *www.network_camera.com* might translate to *192.167.222.8*.

E

Enterprise network

An enterprise network consists of collections of networks connected to each other over a geographically dispersed area. The enterprise network serves the needs of a widely distributed company and operates the company's mission-critical applications.

Ethernet The most popular LAN communication technology. There are a variety of types of Ethernet, including 10 Mbps (traditional Ethernet), 100 Mbps (Fast Ethernet), and 1,000 Mbps (Gigabit Ethernet). Most Ethernet networks use Category 5 cabling to carry information, in the form of electrical signals, between devices. Ethernet is an implementation of CSMA/CD that operates in a bus or star topology.

F

Fast Ethernet Fast Ethernet, also called 100BASE-T, operates at 10 or 100Mbps per second over UTP, STP, or fiber-optic media.

Firewall Firewall is considered the first line of defense in protecting private information. For better security, data can be encrypted. A system designed to prevent unauthorized access to or from a private network. Firewalls are frequently used to prevent unauthorized Internet users from accessing private networks connected to the Internet, especially Intranets all messages entering or leaving the intranet pass through the firewall, which examines each message and blocks those that do not meet the specified security criteria.

G

Gateway A gateway links computers that use different data formats together.

Group Groups consist of several user machines that have similar characteristics such as being in the same department.

H

HEX

Short for hexadecimal refers to the base-16 number system, which consists of 16 unique symbols: the numbers 0 to 9 and the letters A to F. For example, the decimal number 15 is represented as F in the hexadecimal numbering system. The hexadecimal system is useful because it can represent every byte (8 bits) as two consecutive hexadecimal digits. It is easier for humans to read hexadecimal numbers than binary numbers.

I

IEEE

Institute of Electrical and Electronic Engineers.

Intranet

This is a private network, inside an organization or company, that uses the same software you will find on the public Internet. The only difference is that an Intranet is used for internal usage only.

Internet

The Internet is a globally linked system of computers that are logically connected based on the Internet Protocol (IP). The Internet provides different ways to access private and public information worldwide.

Internet address

To participate in Internet communications and on Internet Protocol-based networks, a node must have an Internet address that identifies it to the other nodes. All Internet addresses are IP addresses

IP

Internet Protocol is the standard that describes the layout of the basic unit of information on the Internet (the *packet*) and also details the numerical addressing

format used to route the information. Your Internet service provider controls the IP address of any device it connects to the Internet. The IP addresses in your network must conform to IP addressing rules. In smaller LANs, most people will allow the DHCP function of a router or gateway to assign the IP addresses on internal networks.

IP address

IP address is a 32-binary digit number that identifies each sender or receiver of information that is sent in packets across the Internet. For example 80.80.80.69 is an IP address, it is the closet thing the Internet has to telephone numbers. When you “call” that number, using any connection methods, you get connected to the computer that “owns” that IP address.

ISP

Internet Service Provider, is a company that maintains a network that is linked to the Internet by way of a dedicated communication line. An ISP offers the use of its dedicated communication lines to companies or individuals who can't afford the high monthly cost for a direct connection.

J

JAVA

Java is a programming language that is specially designed for writing programs that can be safely downloaded to your computer through the Internet without the fear of viruses. It is an object-oriented multi-thread programming best for creating applets and applications for the Internet, Intranet and other complex, distributed network.

L

LAN

Local Area Network a computer network that spans a relatively small area sharing common resources. Most LANs are confined to a single building or group of buildings.

N

NAT

Network Address Translator generally applied by a router, that makes many different IP addresses on an internal network appear to the Internet as a single address. For routing messages properly within your network, each device requires a unique IP address. But the addresses may not be valid outside your network. NAT solves the problem. When devices within your network request information from the Internet, the requests are forwarded to the Internet under the router's IP address. NAT distributes the responses to the proper IP addresses within your network.

Network

A network consists of a collection of two or more devices, people, or components that communicate with each other over physical or virtual media. The most common types of network are:

LAN – (local area network): Computers are in close distance to one another. They are usually in the same office space, room, or building.

WAN – (wide area network): The computers are in different geographic locations and are connected by telephone lines or radio waves.

NWay Protocol A network protocol that can automatically negotiate the highest possible transmission speed between two devices.

P

PING Packet Internet Groper, a utility used to determine whether a specific IP address is accessible. It functions by sending a packet to the specified address and waits for a reply. It is primarily used to troubleshoot Internet connections.

PPPoE Point-to-Point Protocol over Ethernet. PPPoE is a specification for connecting the users on an Ethernet to the Internet through a common broadband medium, such as DSL or cable modem. All the users over the Ethernet share a common connection.

Protocol Communication on the network is governed by sets of rules called protocols. Protocols provide the guidelines devices use to communicate with each other, and thus they have different functions. Some protocols are responsible for formatting and presenting and presenting data that will be transferred from file server memory to the file server's net work adapter Others are responsible for filtering information between networks and forwarding data to its destination. Still other protocols dictate how data is transferred across the medium, and how servers respond to workstation requests and vice versa. Common network protocols responsible for the presentation and formatting of data for a network operating system are the Internetwork Packet Exchange (IPX) protocol or the Internet Protocol (IP). Protocols that dictate the format of data

for transfers the medium include token-passing and Carrier Sense Multiple Access with Collision Detection (CSMA/CD), implemented as token-ring, ARCNET, FDDI, or Ethernet. The Router Information Protocol (RIP), a part of the Transmission Control Protocol/Internet Protocol (TCP/IP) suite, forwards packets from one network to another using the same network protocol.

R

RARP Reverse Address Resolution Protocol, a TCP/IP protocol that allows a physical address, such as an Ethernet address, to be translated into an IP address.

RJ-45 RJ-45 connector is used for Ethernet cable connections.

Router A router is the network software or hardware entity charged with routing packets between networks.

S

Server It is a simple computer that provides resources, such as files or other information.

SMTP The Simple Mail Transfer Protocol is used for Internet mail.

SNMP Simple Network Management Protocol. SNMP was designed to provide a common foundation for managing network devices.

Station In LANs, a station consists of a device that can communicate data on the network. In FDDI, a station includes both physical nodes and addressable logical devices. Workstations, single-attach stations, dual-attach stations, and concentrators are FDDI stations.

Subnet mask In TCP/IP, the bits used to create the subnet are called the subnet mask.

T

(TCP/IP) Transmission Control Protocol/Internet Protocol is a widely used transport protocol that connects diverse computers of various transmission methods. It was developed by the Department of Defense to connect different computer types and led to the development of the Internet.

Transceiver A transceiver joins two network segments together. Transceivers can also be used to join a segment that uses one medium to a segment that uses a different medium. On a 10BASE-5 network, the transceiver connects the network adapter or other network device to the medium. Transceivers also can be used on 10BASE-2 or 10BASE-T networks to attach devices with AUI ports.

U

UDP The User Datagram Protocol is a connectionless protocol that resides above IP in the TCP/IP suite

ULP The upper-layer protocol refers to Application Layer protocols such as FTP,SNMP, and SMTP.

User Name The USERNAME is the unique name assigned to each person who has access to the LAN.

Utility It is a program that performs a specific task.

UTP Unshielded twisted-pair. UTP is a form of cable used by all access methods. It consists of several pairs of wires enclosed in an unshielded sheath.

W

WAN Wide-Area Network. A wide-area network consists of groups of interconnected computers that are separated by a wide distance and communicate with each other via common carrier telecommunication techniques.

Windows Windows is a graphical user interface for workstations that use DOS.

Workgroup A workgroup is a group of users who are physically located together and connected to the same LAN, or a group of users who are scattered throughout an organization but are logically connected by work and are connected to the same network group.

Workstations Workstation refers to the intelligent computer on the user's desktop. This computer may be an Intel-based PC, a Macintosh, or a UNIX-based workstation. The workstation is any intelligent device a user works from.

Limited Warranty

TRENDnet warrants its products against defects in material and workmanship, under normal use and service, for the following lengths of time from the date of purchase.

TV-IP100-N and TV-IP100W-N– 3 Years Warranty

If a product does not operate as warranted above during the applicable warranty period, TRENDnet shall, at its option and expense, repair the defective product or part, deliver to customer an equivalent product or part to replace the defective item, or refund to customer the purchase price paid for the defective product. All products that are replaced will become the property of TRENDnet. Replacement products may be new or reconditioned.

TRENDnet shall not be responsible for any software, firmware, information, or memory data of customer contained in, stored on, or integrated with any products returned to TRENDnet pursuant to any warranty.

There are no user serviceable parts inside the product. Do not remove or attempt to service the product by any unauthorized service center. This warranty is voided if (i) the product has been modified or repaired by any unauthorized service center, (ii) the product was subject to accident, abuse, or improper use (iii) the product was subject to conditions more severe than those specified in the manual.

Warranty service may be obtained by contacting TRENDnet office within the applicable warranty period for a Return Material Authorization (RMA) number, accompanied by a copy of the dated proof of the purchase. Products returned to TRENDnet must be pre-authorized by TRENDnet with RMA number marked on the outside of the package, and sent prepaid, insured and packaged appropriately for safe shipment.

WARRANTIES EXCLUSIVE: IF THE TRENDNET PRODUCT DOES NOT OPERATE AS WARRANTED ABOVE, THE CUSTOMER'S SOLE REMEDY SHALL BE, AT TRENDNET'S OPTION, REPAIR OR REPLACEMENT. THE FOREGOING WARRANTIES AND REMEDIES ARE EXCLUSIVE AND ARE IN LIEU OF ALL OTHER WARRANTIES, EXPRESSED OR IMPLIED, EITHER IN FACT OR BY OPERATION OF

LAW, STATUTORY OR OTHERWISE, INCLUDING WARRANTIES OF MERCHANTABILITY AND FITNESS FOR A PARTICULAR PURPOSE. TRENDNET NEITHER ASSUMES NOR AUTHORIZES ANY OTHER PERSON TO ASSUME FOR IT ANY OTHER LIABILITY IN CONNECTION WITH THE SALE, INSTALLATION MAINTENANCE OR USE OF TRENDNET'S PRODUCTS.

TRENDNET SHALL NOT BE LIABLE UNDER THIS WARRANTY IF ITS TESTING AND EXAMINATION DISCLOSE THAT THE ALLEGED DEFECT IN THE PRODUCT DOES NOT EXIST OR WAS CAUSED BY CUSTOMER'S OR ANY THIRD PERSON'S MISUSE, NEGLIGENCE, IMPROPER INSTALLATION OR TESTING, UNAUTHORIZED ATTEMPTS TO REPAIR OR MODIFY, OR ANY OTHER CAUSE BEYOND THE RANGE OF THE INTENDED USE, OR BY ACCIDENT, FIRE, LIGHTNING, OR OTHER HAZARD.

LIMITATION OF LIABILITY: TO THE FULL EXTENT ALLOWED BY LAW TRENDNET ALSO EXCLUDES FOR ITSELF AND ITS SUPPLIERS ANY LIABILITY, WHETHER BASED IN CONTRACT OR TORT (INCLUDING NEGLIGENCE), FOR INCIDENTAL, CONSEQUENTIAL, INDIRECT, SPECIAL, OR PUNITIVE DAMAGES OF ANY KIND, OR FOR LOSS OF REVENUE OR PROFITS, LOSS OF BUSINESS, LOSS OF INFORMATION OR DATA, OR OTHER FINANCIAL LOSS ARISING OUT OF OR IN CONNECTION WITH THE SALE, INSTALLATION, MAINTENANCE, USE, PERFORMANCE, FAILURE, OR INTERRUPTION OF THE POSSIBILITY OF SUCH DAMAGES, AND LIMITS ITS LIABILITY TO REPAIR, REPLACEMENT, OR REFUND OF THE PURCHASE PRICE PAID, AT TRENDNET'S OPTION. THIS DISCLAIMER OF LIABILITY FOR DAMAGES WILL NOT BE AFFECTED IF ANY REMEDY PROVIDED HEREIN SHALL FAIL OF ITS ESSENTIAL PURPOSE.

Governing Law: This Limited Warranty shall be governed by the laws of the state of California.

AC/DC Power Adapter, Cooling Fan, Power Supply and Cables carry 1 Year
Warranty



TRENDnet[®]

Customer Support

Visit www.trendnet.com/support

Email:

support@trendnet.com



Europe (Germany • France • Italy • Spain • Switzerland • UK)

Toll Free Telephone: +00800 60 76 76 67

English/Espanol - 24/7

Francais/Deutsch - 11am-8pm, Monday - Friday MET

Worldwide

Telephone: +(31) (0) 20 504 05 35

English/Espanol - 24/7

Francais/Deutsch - 11am-8pm, Monday - Friday MET

Product Warranty Registration

Please take a moment to register your product online.

Go to TRENDnet's website at <http://www.trendnet.com/register>

TRENDnet[®]

20675 Manhattan Place
Torrance, CA 90501
USA

Free Manuals Download Website

<http://myh66.com>

<http://usermanuals.us>

<http://www.somanuals.com>

<http://www.4manuals.cc>

<http://www.manual-lib.com>

<http://www.404manual.com>

<http://www.luxmanual.com>

<http://aubethermostatmanual.com>

Golf course search by state

<http://golfingnear.com>

Email search by domain

<http://emailbydomain.com>

Auto manuals search

<http://auto.somanuals.com>

TV manuals search

<http://tv.somanuals.com>