



TRENDNET®



User's Guide

TV-IP522P

1.01

CONTENTS

About This User's Guide.....	iv
Before You Start	iv
Packing List	iv
System Requirements	v
Default Settings	vi
Introductions	7
Features and Benefits	7
Camera Hardware Components	8
Front Panel Components	8
LED Indicators	8
Rear Panel Components	9
INSTALLING THE CAMERA.....	10
Attach Camera to Stand.....	10
Connect Ethernet Cable.....	11
Connect Power using AC Adapter and Power On Camera.....	11
Connect Power using PoE	12
Reset Camera	13
SD Card Slot	14
SETUPWIZARD.....	15
USING THE CAMERA WEB MANAGER	26
Accessing the Camera Video Display	26
Login.....	27
Web Manager and Live Video Display Page.....	27
Live Video Display User Interface	28
Camera Configuration Setup.....	30
System Settings.....	31
Network Settings	35
Video and Audio Settings.....	37
Action	40
Motion Detection.....	44
Tools.....	45
Device Information.....	47
IPVIEW PRO 2.0.....	48
IPView Pro 2.0 User Interface	51
Camera configuration with IPView Pro 2.0.....	54
Schedule Recording with IPView Pro 2.0.....	56
Setup Motion Detection and Digital Input with IPView Pro 2.0.....	57

PLAYING VIDEO FILES ON A COMPUTER	59
Load Saved Video Files	60
Play Video Files.....	61
ffdshow	62
TECHNICAL SPECIFICATIONS	68
I/O TERMINAL APPLICATION	71
Limited Warranty	73

About This User's Guide

This user's guide provides instructions on how to install the TV-IP522P ProView Megapixel Internet Camera and use it for camera monitoring applications. Camera monitor applications are accessible through an Ethernet local area network.

Before You Start

Please read and make sure you understand all the prerequisites for proper installation of your new PoE Network Camera. Have all the necessary information and equipment on hand before beginning the installation.

Packing List

Open the shipping carton and carefully remove all items. In addition to this Manual, ascertain that you have:

- One TV-IP522P
- One Camera Stand
- One Power Adapter
- One Ethernet Cable
- One Installation CD-ROM (Utilities and User's Guide)
- One Quick Installation Guide

If any of the above items are missing, please contact your reseller.

CAUTION: If powering up the camera with DC power, the Camera must be used with the power adapter included with the device.

System Requirements

Computer

- CPU:
 - For Intel x86 compatible CPUs: Intel Pentium IV 2.0Ghz or above
 - For IA64 compatible CPUs: AMD Athlon 64 3000+ and above
- Memory: 1GB or above
- VGA Resolution: 1024 x 768 or above (Independent Display Card recommended)
- 10BASE-T Ethernet or 100BASE-TX Fast Ethernet Network Interface Card
- CD-ROM Drive for SetupWizard on Installation CD-ROM
- IPView Pro 2.0 Application Users must use Microsoft® Windows® 7, Vista, XP or 2000 Operating System with Internet Explorer 6.0 or above with DirectX 9.0.



Note: When you connect multiple cameras and monitor their images synchronously, it is recommended to use a high performance system, such as a Pentium 4 2.4GHz PC.

Network

- Local Area Network: 100Base-TX Fast Ethernet or Gigabit

Default Settings

Use the default settings to access the web-based management software and live video display.

Default configuration settings	
Username	This is the Username you will be prompted to enter when you access the TV-IP522P configuration screens using a Web browser. The default Username is admin .
Password	This is the Password you will be prompted to enter when you access the configuration windows using a Web browser. The default Password is admin .
IP address	This is the IP address you will enter into the Address field of your Web browser to access the camera monitor screen and configuration menus using a Web Browser. The camera uses DHCP for IP settings by default. If a DHCP server is not detected, the default IP address is 192.168.10.30. (Make sure your computer is configured to belong to the 192.168.10.X subnet if using the default IP address of the camera.)
Subnet Mask	The default subnet mask is 255.255.255.0.

Introduction

The TV-IP522P ProView Megapixel Internet Camera transmits live real-time high-quality M-JPEG/ MPEG-4/H.264 video through an Ethernet network useful for remote monitoring applications. The live video can be viewed remotely and managed through the network from any computer connected to the network.

Features and Benefits

Easy to use - The Camera is a standalone system with built-in CPU, no special hardware or software is required. The camera supports DirectX 9.0; therefore, the only requirement you need is the web browser software such as Internet Explorer 6.0 or above. Once you have a valid IP Address, just connect it and you can view the picture and receive sound from your camera. In addition, the camera's stand allows you to adjust the camera for optimal viewing angle.

Motion detection and event triggered digital image or video recording – Use the Motion Detection to take a snapshot or digital video record of objects that move through a selected area of the video display.

Live audio for listen and speaking – The built-in mic is useful for listening for noise or voices in front of the camera. The sensitivity can be adjusted to pick up faint noise. An audio output connection allows use of external speakers for two way communication from the operator's station.

Supports variety of platforms - The camera supports TCP/IP networking, SMTP e-mail, HTTP and other Internet related protocols and can be integrated easily into other www/Intranet applications.

Web configuration - Applying a standard web browser, the administrator can configure and manage the camera directly from its own web page via the Intranet or Internet. Up to 20 user accounts are permitted with privilege settings controlled by the administrator.

Remote Utility - The powerful IPView Pro 2.0 application assigns the administrator with a pre-defined user ID and password, allowing the administrator to modify the camera settings from the remote site via Intranet or Internet. When new firmware is available, you can also upgrade remotely over the network for added convenience. Users are also allowed to monitor the image, and take snapshots.

Camera Hardware Components

Below is a summary description of the camera hardware:

Front and Side Components



Lens comes with 2 parts that's adjustable, Focus (front) and Aperture (back).
Please adjust the aperture first then the focus.

Rear Panel Components

The power connection to the camera when fitted with the Infrared lens is split between the camera body and lens using the power connection adapter cable attached to the infrared lens. All other cables connect to the camera at the rear panel.

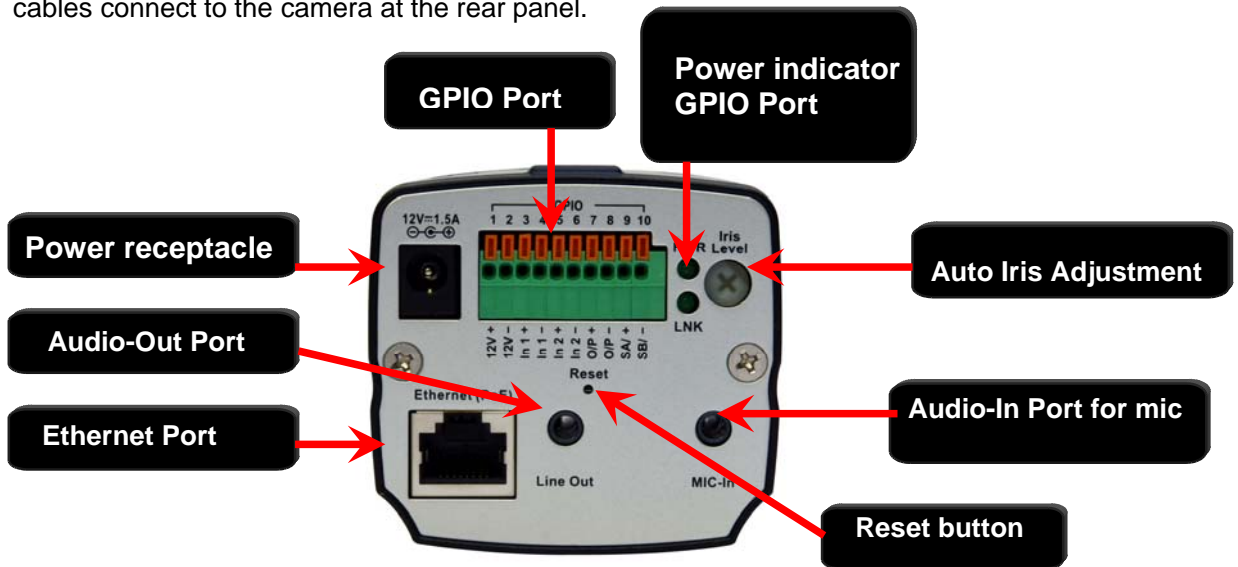

Rear Panel view of TV-IP522P

LED Indicators

LNK	This LED indicator lights green when the camera is powered on . It remains dark when powered off.
PWR	This LED indicator lights steady green when a valid Ethernet link is established. It blinks green when traffic is received or transmitted through the Ethernet link.

TV-IP522P ProView Megapixel Internet Camera

Mic-In	The camera is equipped with an internal microphone, however this can be augmented by an external mic. Use this audio jack socket for an external microphone.
Line Out	Use this audio jack socket to connect to external speakers for two-way audio communication.
DC 12V	Insert the power adapter shipped with the camera directly if using the regular lens; or insert the power adapter cable on the infrared lens connected to the power adapter cable if using the infrared lens. This is used to supply power to the camera. The camera will boot up when connected to a power source. There is no separate power switch.
Auto Iris Connector (DC drive)	Use this for fine-tuning adjustment of Auto Iris lens. Auto Iris lens are not included with the camera. Please see the instructions of the lens manufacturer for more information. Note: Auto Exposure should be turned off when using an Auto Iris lens.
Reset	Use to reset device to factory default settings including IP address and administrator user name and password.
Ethernet	Connect the Ethernet cable here.
Ethernet (PoE)	Connect the Ethernet cable here. PoE connection provides network and device power on networks that support PoE.
GPIO	The camera provides the I/O connectors on the rear panel (pins 1/2 are for DC12V +/-, pins 3/4/5/6 are for Photo-Relay Inputs, pins 7/8 are for Photo-Relay Outputs and pins 9/10 are for RS-485 +/-), which provides the physical interface to send and receive digital signals to a variety of external alarm devices.

Auto-Iris Connector (DC drive)

The camera supports additional Auto Iris Lens(DC drive), and provides the power control signal required for adjusting the lens through this Auto-Iris Connector(DC drive)(4-pin) .You can attach any standard Auto Iris Lens(DC drive)(optional) for specific purposes such as outdoor applications.

Installing the Camera

The camera should be attached to the stand included in the package. The camera stand can be mounted on a flat surface using the three screw holes on the base of the stand. The camera is intended for indoor use. The camera, the power adapter and power source should be protected from water and moisture, excessive heat, direct sunlight and cold. Make sure the power adapter and cord and Ethernet cable are safely arranged so they do not create a tripping hazard and will not be disturbed by people or objects moving past.

Attach Camera to Stand

Determine the location for the camera and assemble the camera stand. Secure the stand to the flat surface or ceiling with the mounting screws included in the package. When the stand is assembled and firmly attached to flat surface or ceiling, attach the camera. Do not attach network cables or the power cord until the camera is firmly mounted in place.

Follow the assembly and installation instructions below to mount the camera before connecting the power or network cables.

1. Determine where the camera will be located and assemble the camera stand. For wall mounting, use both arm sections of the camera stand. For ceiling or flat top surface mounting, use the straight section of the stand only.
2. Firmly attach the camera stand to a suitable flat surface by placing screws in the holes of the mount plate and screwing them into place. Make sure the stand is securely attached before attaching the camera.
3. Aim the camera at the area of coverage and hand tighten the nut to keep the camera in position.
4. Attach the Ethernet cable (see below).
5. Attach the power adapter and connect it to a suitable power source (see below). Check the power and Ethernet LED indicators to check for basic functionality.

The camera is shipped with a camera stand. The swivel ball screw head on the stand can be attached to the bottom screw hole of camera. The swivel ball mount allows the camera to be pointed in a direction and fixed in position. Three holes on the base of the camera stand are used to securely attach the stand to a wall or ceiling.



Connect Ethernet Cable

To connect the camera to your network, connect a Category 5 or better Ethernet cable to the network cable connector located on the camera's left side panel, and then attach it to the network. The Ethernet port will automatically detect and adjust to the speed (10 or 100 Mbps) and polarity (MDI-II or MDI-X) of the connection.

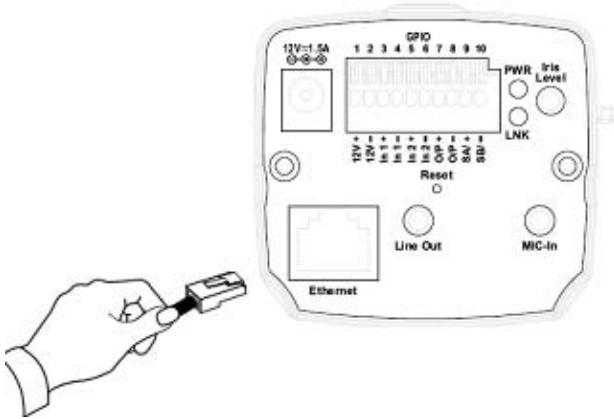

Connect Power using AC Adapter and Power On Camera

To provide power to the camera, connect the AC power adapter to the DC power input connector, also located on the camera's rear panel, and then plug it into a suitable power source. As with any electrical device, make sure the power source and camera are located in an area where it is not going to get wet or present an electrical hazard.

Note that there is a difference in how the power connection of the infrared lens assembly connects compared with the 6mm CCTV lens. The infrared lens requires power and therefore it is equipped with a special adapter to power both the camera and the lens.

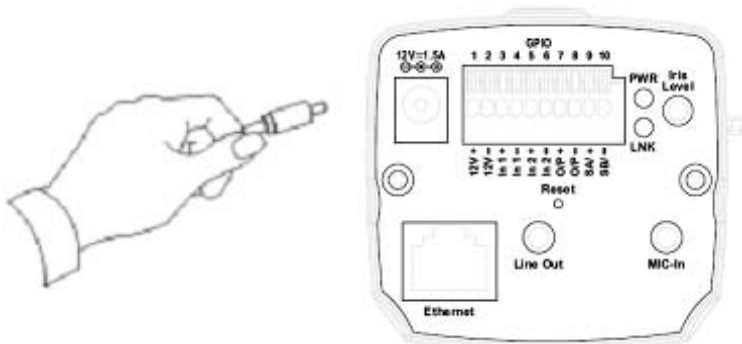

CAUTION: The Camera must be used with the power adapter included with the device.

Reset Camera

A manual reset can be conducted by following the procedure below. The reset button is located on the rear panel of the camera. To reset the system settings to factory defaults, please follow these steps:

1. Leave the camera powered on, do not disconnect the power.
2. Use a paper clip or similar object to press the reset button and hold. The reset button is located on the rear panel of the device. See the Rear Panel Components picture above to locate the reset button.
3. Keep the button pressed about 10 seconds.
4. Release the button.

The camera will then automatically reboot itself. Upon restarting the camera loads the factory default configuration settings. The default IP address 192.168.10.30 and subnet mask 255.255.255.0 will be applied unless a DHCP server is actively connected to the network. The administrator's default user name is admin and the password is admin. Use the SetupWizard shipped with the camera to reconfigure it or access it through the web-based management software.

SD Card Slot



The built in SD card slot allows you to insert Secure Digital Cards. This enables images taken by the camera to be saved to an external SD card.

SetupWizard

This section describes the how to setup a camera using the SetupWizard. To install the SetupWizard on a system running Windows, launch the SetupWizard on the installation CD-ROM and follow the setup instructions. Once the software is installed, the SetupWizard utility is ready for use.

Launching the SetupWizard

To launch the SetupWizard, click **Start > Programs > TRENDnet > SetupWizard > SetupWizard**.

SetupWizard- Install Your Camera



- Connect the camera to your LAN using the provided RJ45 cable.
- Connect the AC Power Adapter to the back of the camera and to a live power socket.
- Click **Next** to continue.

SetupWizard- Select Your Camera

The following screen appears showing the cameras that have been found on your network:



- Click on the camera you want to configure.
- Click **Next** to continue.

SetupWizard- Authentication

On the following screen type in the ID and Password that you will use to configuring the camera settings:

TRENDnet Setup Wizard

Authentication

Please enter ID and password to verify authorization for setting up camera. Click button "Next" to check. Or click button "Previous" to select another camera.

ID
admin

Password
..... (Default : admin)

The Wizard will help you to discover if there is a DHCP server in your network environment, so please click the "Unblock" button if you see a Windows Security Alert dialog.

Previous Next Exit

Copyright © 2009 TRENDnet. All Rights Reserved.

- Type a *User ID* in the **ID** field.
- Type the *password* of the User in the **Password** field.
- Click **Next** to continue.

SetupWizard- Change Password

The following screen allows you to change the default admin password:

TRENDnet Setup Wizard

Change Password

You can change the password here to secure your camera from being accessed by others. Leave the checkbox unchecked to skip this step.

Change Password

New Password

Confirm Password

Previous Next Exit

Copyright © 2009 TRENDnet. All Rights Reserved.

Carry out the following if you want to change the admin password:

- Tick the **Change Password** checkbox
- Type in a *New Password* in the **New Password** field and confirm it in the **Confirm Password** field
- Click the **Next** button to proceed to the next **Setup** window

If you don't want to change the admin password, leave the checkbox un-ticked and click **Next**.

SetupWizard- Select a Connection Option

The following window allows you to specify the connection method used by your camera network.

Click the radio button of the network environment your camera is connected to. The available options are:

- **PPPoE**
- **DHCP**
- **Fixed IP**

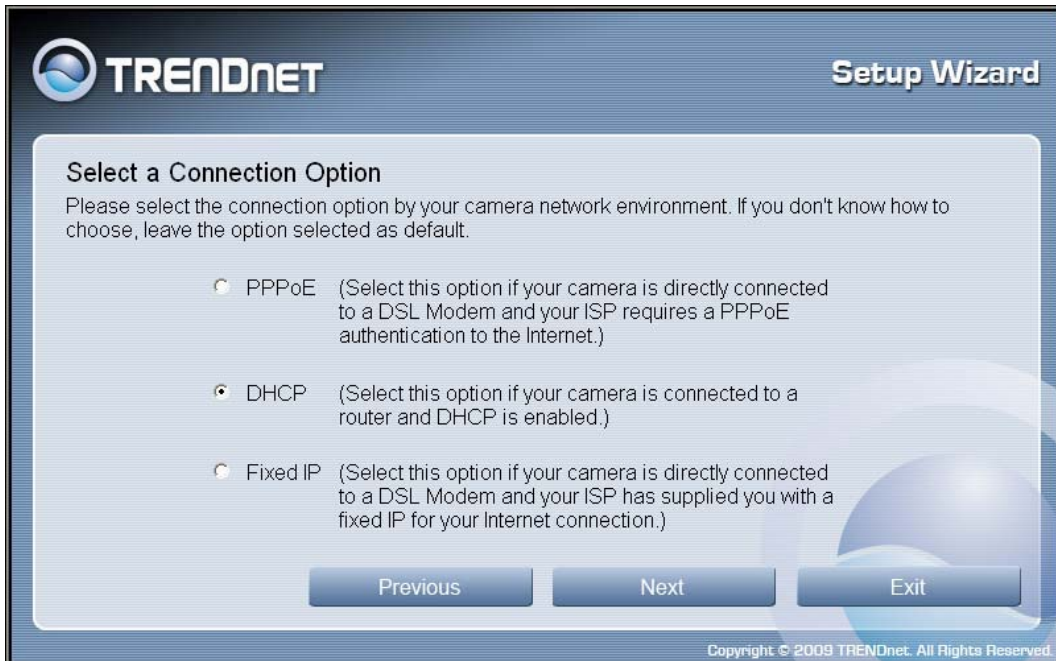

Setup Wizard- Select a Connection Option- PPPoE

If your connection method is PPPoE, click the **PPPoE** radio button and click **Next**:

TRENDnet Setup Wizard

Select a Connection Option

Please select the connection option by your camera network environment. If you don't know how to choose, leave the option selected as default.

PPPoE (Select this option if your camera is directly connected to a DSL Modem and your ISP requires a PPPoE authentication to the Internet.)

DHCP (Select this option if your camera is connected to a router and DHCP is enabled.)

Fixed IP (Select this option if your camera is directly connected to a DSL Modem and your ISP has supplied you with a fixed IP for your Internet connection.)

Previous Next Exit

Copyright © 2009 TRENDnet. All Rights Reserved.

The following window appears:

TRENDnet Setup Wizard

Authentication for PPPoE Connection

Please enter username and password while ensuring that your camera is directly attached to your modem. Click button "Next" to continue setting up. Or click button "Previous" to select another network environment.

User Name

Password

Confirm Password

Previous Next Exit

Copyright © 2009 TRENDnet. All Rights Reserved.

- Type the *User Name* used to connect to your PPPoE connection in the **User Name** field.
- Type the *Password* of the PPPoE User Name in the **Password** field and confirm it in the **Confirm Password** field.
- Click **Next** to proceed to the next setup window.

SetupWizard- Select a Connection Option- DHCP

If your connection method is DHCP, click the **DHCP** radio button and click **Next**:

TRENDnet Setup Wizard

Select a Connection Option

Please select the connection option by your camera network environment. If you don't know how to choose, leave the option selected as default.

- PPPoE (Select this option if your camera is directly connected to a DSL Modem and your ISP requires a PPPoE authentication to the Internet.)
- DHCP (Select this option if your camera is connected to a router and DHCP is enabled.)
- Fixed IP (Select this option if your camera is directly connected to a DSL Modem and your ISP has supplied you with a fixed IP for your Internet connection.)

Previous Next Exit

Copyright © 2009 TRENDnet. All Rights Reserved.

SetupWizard- Select a Connection Option- Fixed IP

If your connection method is Fixed IP, click the **Fixed IP** radio button:

TRENDnet Setup Wizard

Select a Connection Option

Please select the connection option by your camera network environment. If you don't know how to choose, leave the option selected as default.

- PPPoE (Select this option if your camera is directly connected to a DSL Modem and your ISP requires a PPPoE authentication to the Internet.)
- DHCP (Select this option if your camera is connected to a router and DHCP is enabled.)
- Fixed IP (Select this option if your camera is directly connected to a DSL Modem and your ISP has supplied you with a fixed IP for your Internet connection.)

Previous Next Exit

Copyright © 2009 TRENDnet. All Rights Reserved.

The following window appears:

TRENDnet Setup Wizard

Network Configuration

Please input correct information. You can click button "Auto" to let IP camera configured automatically. Click button "Next" to continue setting up.

IP Address	10.73.87.2
Subnet Mask	255.0.0.0
Default Gateway	10.1.1.254
Primary DNS	112.48.2.4
Secondary DNS	112.48.2.5

Auto Previous Next Exit

Copyright © 2009 TRENDnet. All Rights Reserved.

- Type in the *IP Address*, *Subnet Mask*, *Default Gateway*, *Primary DNS Server IP address* and *Secondary DNS Server IP Address* in the appropriate fields.
- Click **Next** to proceed to the next setup window.

SetupWizard- Other Settings

The following window allows you to configure additional camera settings:



TRENDNET Setup Wizard

Other Settings

You can have a name for the camera. And you can also adjust the camera's clock by input the current time on "Camera time" option. Click button "Next" to continue setting up.

Camera Name
TV-IP522P

Camera Time
2000/01/05
07:31:56

Copy Local Time Previous Next Exit

Copyright © 2009 TRENDnet. All Rights Reserved

- Type a name to help you identify the camera in the **Camera Name** field.
- Set the camera date and time from the **Camera Time** drop-down menus. To use the time settings from your computer, click the **Copy Local Time** button.
- Click **Next** when you have finished configuring the other settings.

SetupWizard- Setting Up The Camera

The following window appears, summarizing the network settings of your camera:



- When you have finished setting up the Camera click the **Next** button. To make any changes to your Camera settings, click the **Previous** button.

SetupWizard- Camera Restart

The following window appears, indicating that the camera is restarting:



SetupWizard- Complete

After the camera has restarted, the following window will appear:



- Click the hyper-link to connect to the camera web interface.
- If you want to setup an additional camera, click the **Setup Another Camera** button.
- When you have finished, click the **Exit** button to close the SetupWizard.

Using the Camera Web Manager

The camera is easy to use and manage. Use a normal web browser to access the camera's live video display, as well as the configuration software. It is recommended to check and make sure the computer can access and use the camera before placing it in the location where it will be used, especially if it is mounted to a ceiling or other area that is difficult to physically access.

For the initial setup, use the SetupWizard program located on the TV-IP522P CD-ROM included with the camera. Use the wizard to assign an IP address and other network settings. Once the camera has an IP address, follow the instructions below to access the camera's web management interface used to manage the camera and for video display.

Accessing the Camera Video Display

If the camera is used on a network with an active DHCP server, the camera will detect it and obtain an IP address. If you are using the camera on a network with a DHCP server it is necessary to first determine what the IP address of camera is. To do this, follow the instructions in the Quick Installation Guide to launch the IPCam Wizard software utility used with the TV-IP522P.



NOTE: If your network uses DHCP or has an active DHCP server running, use the SetupWizard utility on the installation CD-ROM shipped with the camera to first access the camera. Once it is accessed, you can change the IP address or continue to use the DHCP assigned address as preferred. See the Quick Installation Guide for instructions on using the SetupWizard utility.

If your network does not use a DHCP server, the camera will use a default IP address of 192.168.10.30. Use this address to access the web-based management software. Use a web browser and type in **http://** followed by the default IP address, **192.168.10.30** in the address bar of the browser and press the **Enter** key. The URL in the address bar should read: **http://192.168.10.30**

If the login dialog does not appear, check the proxy server settings on your browser.



NOTE: The wrong proxy server settings on your browser can prevent connection to the web manager. If you are having trouble connecting to the web interface of the VLAN Switch, configure the proxy settings to bypass the proxy server or disable use of proxy servers and try to connect again.

To check proxy setting for Windows Internet Explorer:

1. In Windows, click on the **Start** button, go to **Settings** and choose **Control Panel**.
2. In the **Control Panel** window, double-click on the **Internet Options** icon. (Alternatively you can access this **Internet Options** menu using the **Tools** pull-down menu in Internet Explorer.)
3. Click the **Connections** tab and click on the **LAN Settings** button.
4. Verify that the "Use proxy server" option is **NOT** checked. If it is checked, click in the checked box to deselect the option and click **OK**.

Login

To access the web manager directly from a computer or on a network without a DHCP server running, use the default IP address of the camera in the browser address entry to access the web manager. Type **http://192.168.10.30** in the address bar and press **Enter**. The login dialog appears when accessing the camera.

Type the default user name “admin”, default password “admin” and click on the **OK** button to access the camera’s management interface.



Web Manager and Live Video Display Page

The live video display appears after successful logging in to the web manager.

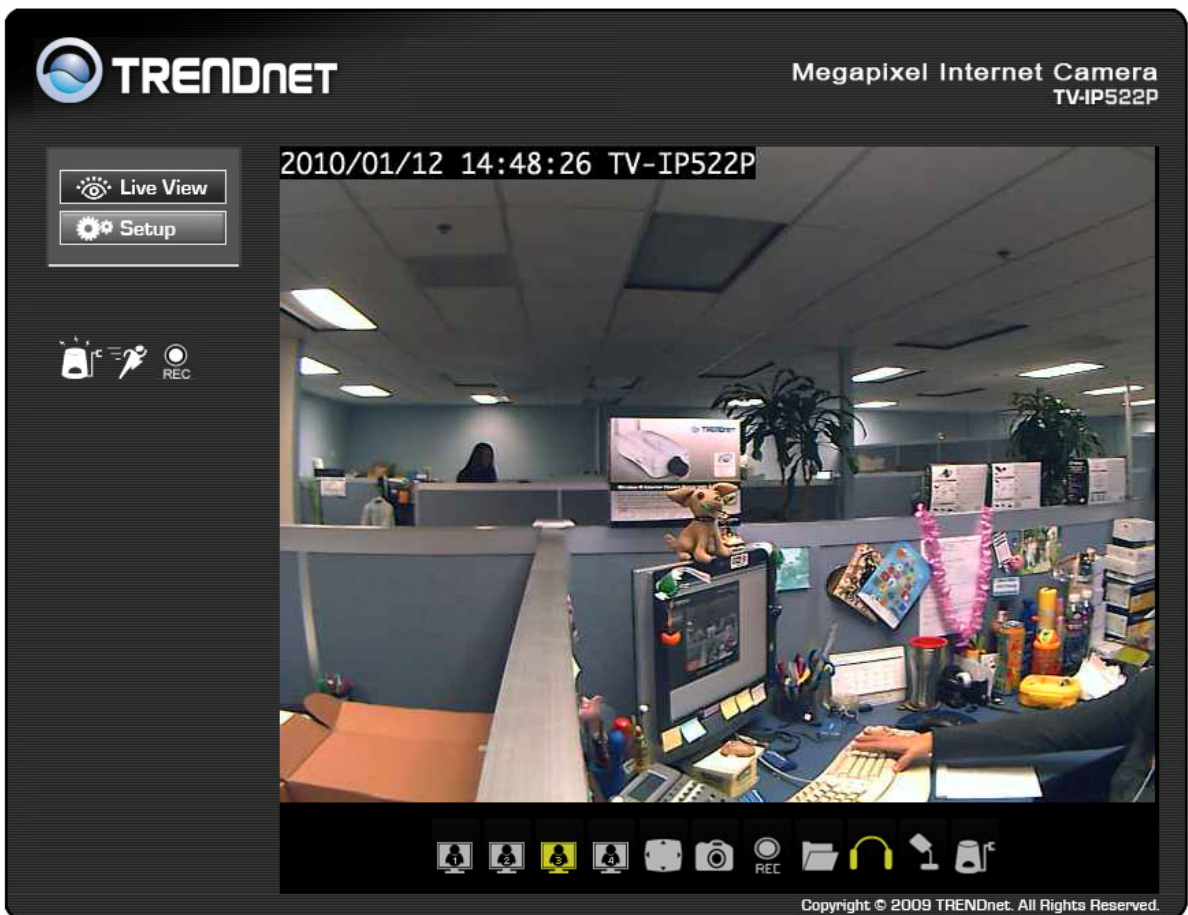

Camera video display in web manager

Live Video Display User Interface

The web manager's live video page presents icons at the bottom used to change the display size, control snapshot and recording of video and audio controls. Links to other management menus are located at the top right portion of the interface. Click the **SETUP** link to view menus used to configure various camera settings including advanced video and network configuration settings. Click the **SYSTEM** link to view menus used for device management, firmware upgrades, device logs, device reset and configuration settings back up.

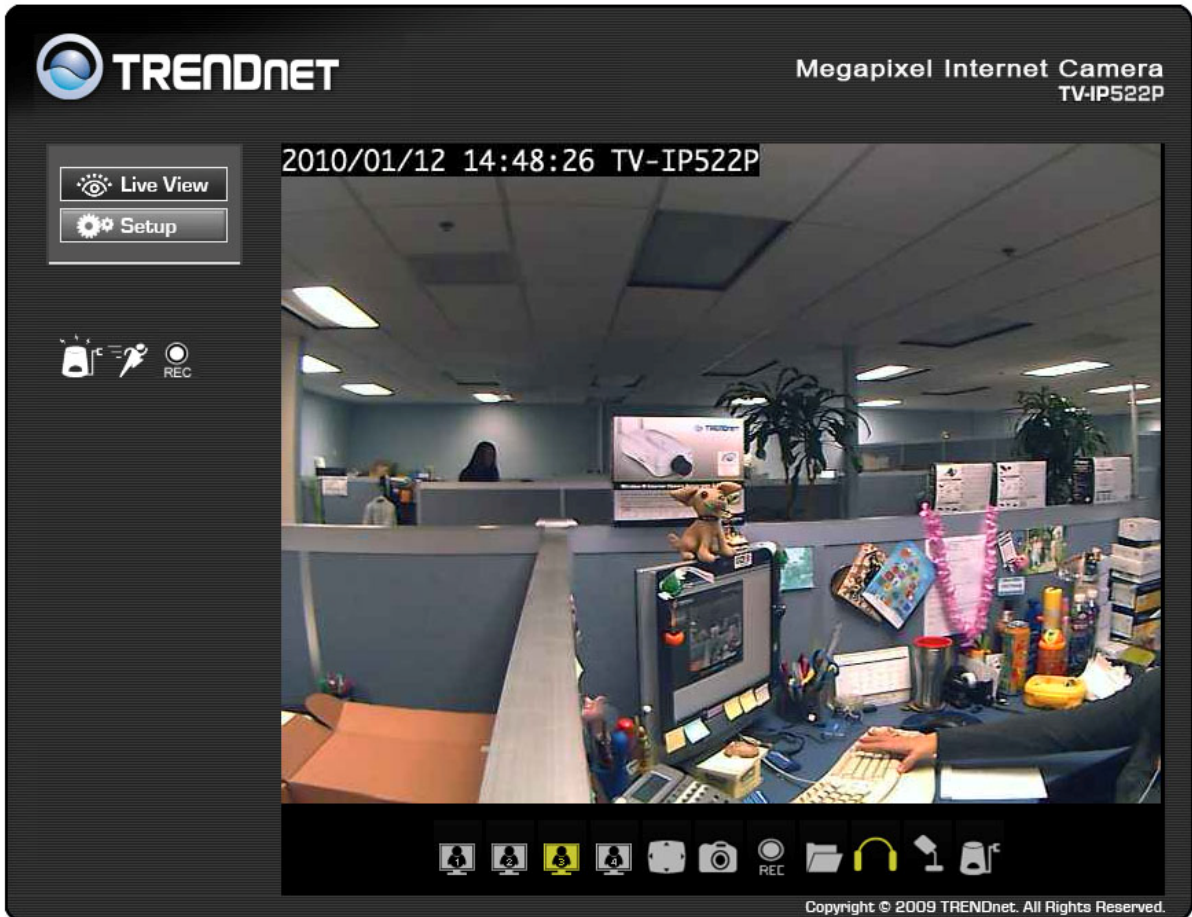

Live Video Display user interface

Video Display Control



Change display settings Click on the screen icon to change the resolution and format of the video display to a preconfigured video settings profile. Four profiles can be configured using the **Video and Audio Settings** menu. See the description of the menu below in the section of the same title. The yellow icon shows which profile is currently being used.

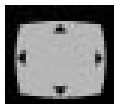

Full Screen Click on the Full Screen icon to use the entire monitor display area for live video output. Use the left click button on the mouse with the cursor placed at the top, bottom, left and right edges of the display to pan and tilt the view.

Recording, Snapshot, Audio and Digital Output Controls



Record and Snapshot Use the camera icon to take a snapshot of the video display. This will immediately cause the screen capture or snapshot to appear on the desktop in a new browser window. Use the Record (REC) icon to begin recording to the local hard disk. In order to do either of these however, first click on the file folder icon to select the location where the snapshot or video recording is to be stored (by default a folder is created in My Documents if not specified). The REC icon becomes yellow while recording is active.



Audio Input control Click to enable or disable the camera's built-in mic to provide audio surveillance or voice communication from the camera. This is enabled by default.



Audio Output control Audio speakers can be connected to the camera via the external audio miniplug. Use this control to enable or disable the audio output for voice or other audio through connected speakers. This is disabled by default.



Digital Output control Click to enable or disable the Digital Output Port. This icon will appear yellow if the Digital Output port is enabled.

Event Indicators



Digital Input indicator This appears yellow when the digital input mechanism is active. This requires a device or devices to be connected to the camera via the I/O terminal.



Motion Detection indicator The motion detection icon appears yellow when motion is detected in the zone previously configured for motion detection. Motion detection must be configured in the Motion Detection menu located in the Setup Menu directory.



Recording indicator (right panel) This appears yellow while the video display is being recorded.

Camera Setup

Click the **Setup** link to view the menus in the Setup Menu directory. These menus are used to configure network settings, video and other settings for the camera.

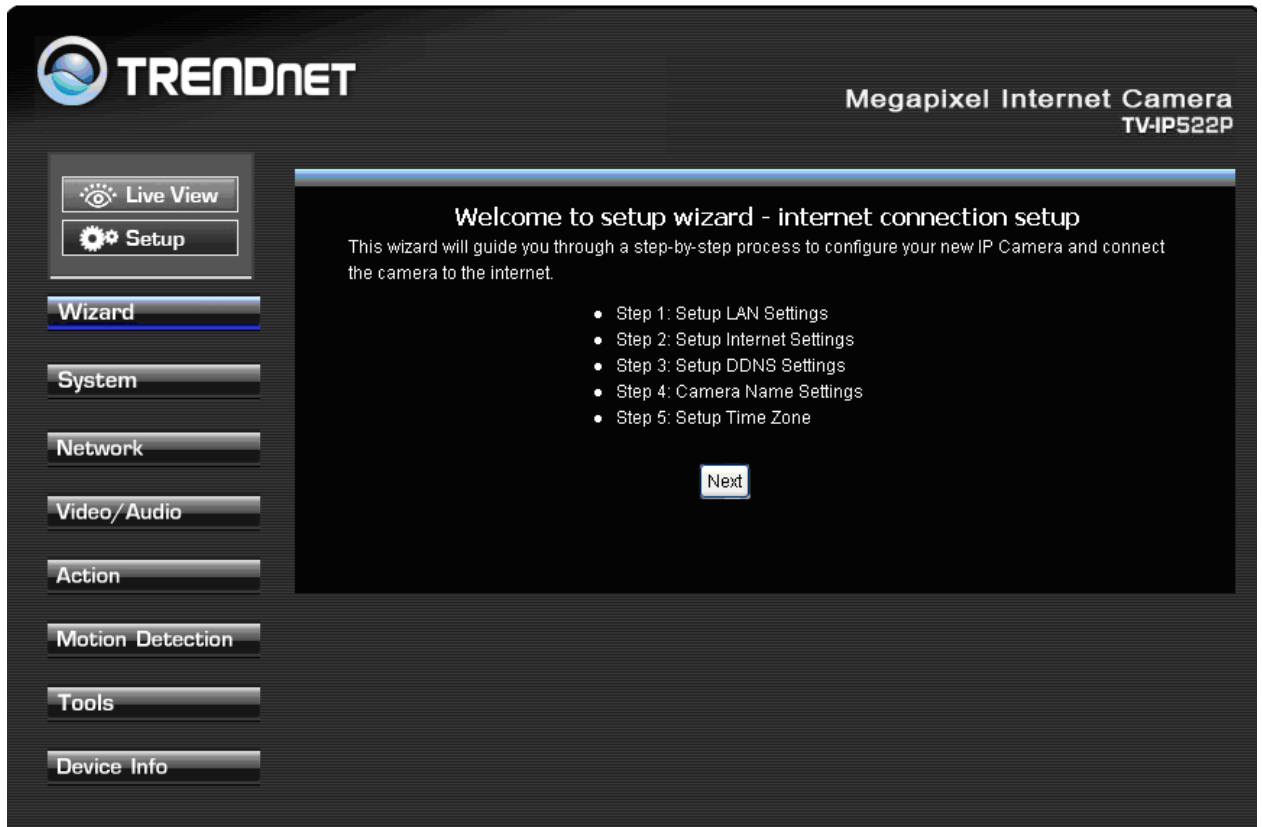

SetupWizard menu in Setup directory

To configure the camera with the web manager's Wizard, click the **Next** button and follow the instructions in the menus to configure network, time and name settings.

To configure these settings without using the wizard, click on the link for the settings to be configured to view the Setup menu. These menus are presented and described in the pages that follow.

System Configuration

The System configuration menus include the **Device Management** menu and Time and Date.

Device Management

TRENDNET Megapixel Internet Camera TV-IP522P

Device Management

Admin Password Setting

New Password 30 characters maximum

Retype Password Save

Add User Account

User Name 30 characters maximum

New Password 30 characters maximum

Retype Password

Add 20 users maximum

User List

User Name -- User list -- Delete

Device Setting

Camera Name TV-IP522P 36 characters maximum

Enable OSD

Label TV-IP522P 30 characters maximum

Show time

LED light On Off

Save

Copyright © 2009 TRENDnet. All Rights Reserved.

Device Management menu

Admin Password Setting

Use this section to change the Admin Password for the camera. Type in a **New Password** and confirm it in the **Retype Password** field. Click **Save** to set the new password.

Add User Account

Use this section to add a new user. Up to 20 User accounts can be created on the TV-IP522P camera. To create a new user, carry out the following:

- Type a name for the new user in the **User Name** field.
- Type in a new password in the **New Password** field.
- Confirm the password in the **Retype Password** field.
- Click **Add** to add the new user.

Note: The maximum number of users that can log onto the camera is 10 at the same time. Please keep in mind the performance of the transmission speed will be reduced if multiple users have logged onto the camera simultaneously.

User List

Use this section to delete existing users. Users can be removed by selecting the name from the **User Name** drop-down menu and clicking the **Delete** button.

Device Setting

Use this section to change the following Camera settings:

- **Camera Name** - This parameter sets the name of your camera. You can use this to type a name to help you identify the camera, e.g. *Front Door* could be used if your camera is focused on the front door of your house.
- **Enable OSD** - Tick the checkbox to make the information bar On Screen Display (OSD) appear when viewing video.
- **Label** - If enabling OSD, type a name that will appear as the text label on the On Screen Display (OSD), e.g. *Front Door* could be used if your camera is focused on the front door of your house.
- **Show time** - If enabling OSD, tick this checkbox to display the time on the On Screen Display (OSD).

Time and Date

Use the Time and Date menu to set the camera's time settings manually, from the computer's time or use a network time server (NTP server).

Time Zone

Use the drop-down menu to select your time zone.

Enable Daylight Saving

If the region you are located in use Daylight Saving Time adjustments, click this checkbox.

Time Configuration

Time Zone (GMT-08:00) Pacific Time (US & Canada) ▾

Enable Daylight Saving

Auto Daylight Saving

Set date and time manually

Offset +1:00 ▾

	Month	Week	Day of week	Hour	Minute
Start time	3 ▾	2 ▾	Sunday ▾	2	00
End time	11 ▾	1 ▾	Sunday ▾	2	00

Auto Daylight Saving

If enabling Daylight Saving Time, click this radio button to adjust Daylight Saving Time automatically.

Automatic time configuration

Synchronize with NTP Server

NTP Server

Set date and time manually

If enabling Daylight Saving Time carry out the following:

- Click this radio button to manually adjust Daylight Saving Time.
- Use the **Offset** drop-down menu to set the Daylight Saving adjustment that will be used.
- Set the **Start time** and **End time** of the Daylight Saving period by using the drop-down menus to set the **Month**, **Week** and **Day of Week**. Type the **Hour** and **Minutes** that the Daylight Saving adjustment will start and end in the respective fields.

Set date and time manually

Set date and time manually

Year	2000 ▾	Month	1 ▾	Day	5 ▾
Hour	8 ▾	Minute	45 ▾	Second	47 ▾

TV-IP522P ProView Megapixel Internet Camera

Automatic time configuration

- Click a radio button to specify the method used to set the time on the TV-IP522P.

Synchronize with NTP Server

- Click this radio button to specify that the TV-IP522P should be synchronized with an NTP Server.
- Type the *NTP Server URL* in the **NTP Server** textbox.

Set date and time manually

- Click this radio button to specify that the date and time will be set manually.
- Use the drop-down menus to select the current the **Year, Month, Day, Hour, Minute** and **Second**. Alternatively you can automatically fill in the drop-down menus with the current date and time from your computer by clicking the **Copy Your Computer's Time Settings** button.

When you have finished setting the time and date, click the **Ok** button at the bottom of the window.

Network Settings

The Network menu contains two sub-menus that provide the Networking Settings for the camera, such as the IP Setting, and DDNS Setting

TRENDNET Megapixel Internet Camera TV-IP522P

Live View
Setup

Wizard

System

Network

- Network Setup
- Dynamic DNS

Video/Audio

Action

Motion Detection

Tools

Device Info

Network Setup

Network Settings

LAN

DHCP Connection

Static IP Address

IP Address

Subnet Mask

Default Gateway

Primary DNS

Secondary DNS

Enable UPnP

Enable UPnP port forwarding

External HTTP port

External RTSP port

Enable PPPoE

User Name

Password

Confirm password

Network Setup menus

LAN IP Settings

The camera's IP settings can be configured as a DHCP client to obtain IP settings automatically, or configure static IP settings as needed for the private network.

To use IP settings automatically obtained from a DHCP server on the network, select the **DHCP Connection** option. For manually entered or static IP settings, choose the **Static IP Address** option and type an **IP Address** unique on the LAN, appropriate **Subnet Mask**, **Default Gateway** address and **Primary** and **Secondary DNS** server IP address (for example, used for functions that require Internet access and DNS service such as SNTP with a named server). Click the **OK** button at the bottom of the web page to change and save the IP settings.

TV-IP522P ProView Megapixel Internet Camera

UPnP

If you want to enable the TV-IP522P ProView Megapixel Internet Camera to connect to other UPnP devices in your network, tick the **Enable UPnP** checkbox.

UPnP port forwarding

To enable UPnP port forwarding, tick the **Enable UPnP port forwarding** checkbox. Enabling UPnP port forwarding allows the camera to add a port forwarding entry to be added to your router automatically.

If your network uses different port numbers for External HTTP and External RTSP type in the values used by your network in the **External HTTP port** and **External RSTP port** fields.

PPPoE

For PPPoE client Internet access, tick the **Enable PPPoE** checkbox and enter the user name and password used for the PPPoE connection. Click the **OK** button at the bottom of the web page to apply the PPPoE account settings.

DDNS

If a Dynamic DNS account has been setup, use the DDNS menu to enter account information.

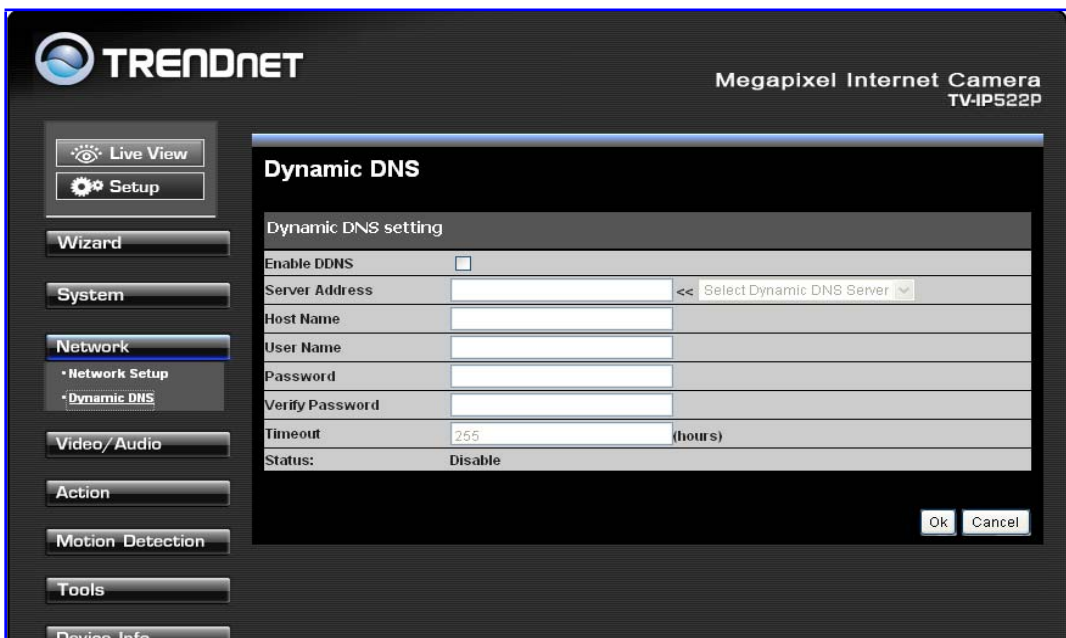

The screenshot shows the 'Dynamic DNS' configuration page in the camera's web interface. The page title is 'Dynamic DNS' and the breadcrumb is 'Dynamic DNS setting'. The interface includes a sidebar with navigation options: Live View, Setup, Wizard, System, Network (selected), Network Setup, Dynamic DNS, Video/Audio, Action, Motion Detection, Tools, and Device Info. The main content area contains the following fields:

Enable DDNS	<input type="checkbox"/>
Server Address	<input type="text"/> << Select Dynamic DNS Server >>
Host Name	<input type="text"/>
User Name	<input type="text"/>
Password	<input type="text"/>
Verify Password	<input type="text"/>
Timeout	<input type="text" value="255"/> (hours)
Status:	Disable

At the bottom right of the form are 'Ok' and 'Cancel' buttons.

DDNS menu

Click the **Enable DDNS** option and enter DDNS account information in the available entry fields. Click the **OK** button at the bottom of the web page to apply the DDNS configuration.

Port Detail

Use the Port Detail Settings menu to change the port used for HTTP web access or RSTP streaming access to the camera's video output.

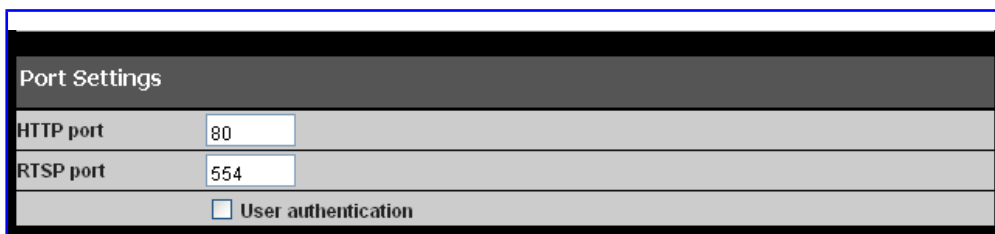

The screenshot shows the 'Port Settings' configuration page. The page title is 'Port Settings'. The interface contains the following fields:

HTTP port	<input type="text" value="80"/>
RTSP port	<input type="text" value="554"/>
	<input type="checkbox"/> User authentication

Port Detail settings menu

Setting up Video & Audio

The Video & Audio menu contains two sub-menus that provide the video and audio Settings for the camera and Use the Image Setup configuration to optimize the live video display.

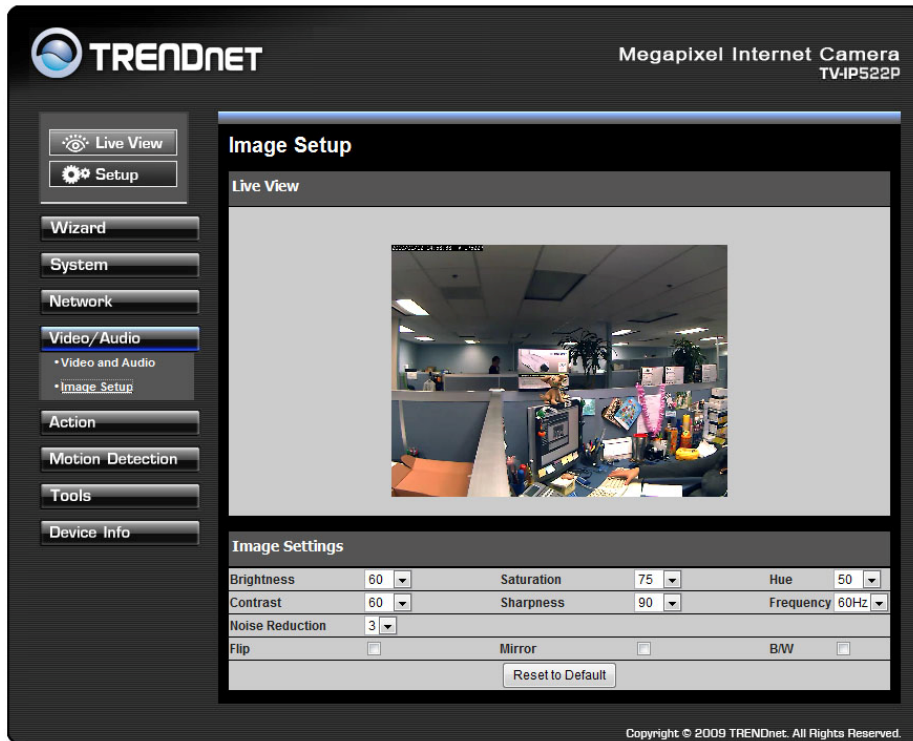

Brightness

Adjust the brightness level. The value range is from 0 – 100. (The default setting is 60)

Saturation

Adjust the saturation level. The value range is from 0 – 100 increments (The default setting is 75)

Hue

Adjust the hue level. The value range is from 0 – 100 increments (The default setting is 50)

Contrast

Adjust the contrast level. The value range is from 0 – 100 increments of 20. (The default setting is 100.)

Sharpens

Adjust the sharpens level. The value range is from 0 – 100 increments (The default setting is 90)

Frequency

Select the proper frequency (**50Hz** or **60Hz**) to eliminate flicker.

Flip

Use this to flip the image upside down. This is used with the Mirror option if the camera is mounted in a hanging position as from a ceiling.

B/W

This option changes the display to a black and white only display (that is, no color is displayed in the video).

TV-IP522P ProView Megapixel Internet Camera

Mirror

Use this to produce a mirror image display. This is used with the Flip option if the camera is mounted in a hanging position, as from a ceiling.

Reset to Default

Click this button to reset the TV-IP522P Image Settings back to factory defaults.

Video and Audio Settings

Use this menu to configure up to four video profiles. These are used to optimize video encoding type, resolution, frame rate and bit rate settings on the camera for the type of display being used.

video sensor						
When 4VGA mode is selected, only Profile 1 supports 1280x960.						
Sensor Output		<input type="radio"/> VGA (640x480)				
		<input type="radio"/> HDTV (1280x720)				
		<input checked="" type="radio"/> 4VGA (1280x960)				
VIDEO PROFILE 1						
Encode Type	Resolution	FPS	bps	JPEG Quality	RTSP URL	
H264	1280x960	15	2 Mbps	Standard	play1.sdp	
VIDEO PROFILE 2						
Encode Type	Resolution	FPS	bps	JPEG Quality	RTSP URL	
MPEG4	640x480	10	256 Kbps	Standard	play2.sdp	
VIDEO PROFILE 3						
Encode Type	Resolution	FPS	bps	JPEG Quality	RTSP URL	
JPEG	640x480	10	--	Excellent	play3.sdp	
VIDEO PROFILE 4 for Mobile device only						
Encode Type	Resolution	FPS	bps	JPEG Quality	RTSP URL	
MPEG4	320x240	5	64 Kbps	--	3gpp	
Night Mode						
Enable Night Mode		<input type="checkbox"/>				
		Shutter 1/15 Second				
Camera Environment						
ICR Control		Day Mode				
Placed Location		<input checked="" type="radio"/> Indoor <input type="radio"/> Outdoor				
Auto Exposure						
<input checked="" type="radio"/> On						
<input type="radio"/> Off for auto IRIS lens						
Audio Setup						
Enable Speaker		<input checked="" type="checkbox"/>				
Volume		100				
Enable Microphone		<input checked="" type="checkbox"/>				
Volume		100				
						Ok Cancel

TV-IP522P ProView Megapixel Internet Camera

Sensor Output: You can set the camera's sensor output to VGA quality (640x640), HDTV quality (1280x720), 4VGA quality (1280x960).

Encode Type: This sets the video codec used for the video stream. You can choose MPEG-4 or JPEG. IE browsers can view both MPEG-4 and MJPEG video streams, and non-IE browsers can only view MJPEG streams.

Resolution: This sets the display resolution of the video stream. If the Resolution is different than the Sensor Output size, the video will be shrunk or enlarged to the Resolution size you set here.

FPS: (Frames Per Second): This sets the target number of frames per second (FPS) for the video stream. Higher framerates will provide smoother video..

BPS: (Bits Per Second): BPS will affect the bit rate of the video recorded by the camera. Higher bit rate will increase the video quality.

JPEG Quality: This sets the JPEG quality of any manual snapshots you take when this video profile is selected.

RTSP URL: Is the URL used to connect to the camera when viewing for a mobile device or PDA.

Night Mode

Night mode allows the camera to use a longer shutter speed when the camera is in a low-light environment. If the camera is in an area where there is sufficient lighting, Night Mode will not affect the video stream. Choose a value in seconds to specify how long the shutter will remain open after the camera flashes from the Shutter drop-down menu. This is useful in low light situations as it allows you to get more ambient light from the background, allowing you to see more detail from both the subject and background of your video/picture.

Camera Environment

The **ICR** (IR CUT Filter Removable) function provides enhanced night viewing by increasing the IR sensitivity. The camera is equipped with a motorized ICR which can be removed in low-light or IR illuminated applications. IR Cut removable allows to schedule IR activation by automatic, Day Mode, Night mode.

- **Automatic:** Selecting the option that the camera will automatically switch between IR cut filter On and Off, according to the current lighting conditions.
- **Day mode:** Selecting this mode that the IR-cut filter is always turned on.
- **Night mode:** Selecting this mode that the IR-cut filter is turned off.

Placed Location

User can look for a place that best suits your needs, either outdoor or indoor. The option can prevent the outdoor direct strong Sunlight and indoor strong Lighting effecting images

Auto Exposure

The option controls the light coming into the camera through the electronic shutter. If auto-exposure is enabled, then the camera will attempt to adjust the exposure to match the requested luminance

Audio Setup

Use the Audio Setup menu to enable and disable the microphone and speaker as well as adjust the volume of each.

Click **Ok** to save the changes you have made to the Video and Audio settings.

Click **Cancel** to discard any changes made.

Action

The Action menu contains four sub-menus that provide the Recording, Snapshot, Digital output and RS-485 setting.

Recording

The Recording Setup menu is used to determine when and how digital video recordings are handled. Recordings can be saved to an SD memory card (requires the insertion of an SD card into the camera) or to a shared folder on a secure server. The recording can be scheduled or event based using motion detection as the trigger. One option allows resolution of recordings to be adjusted down to use less hard disk space. Recording can be stopped when the hard disk is full or choose the option to overwrite the disk to replace old recordings.

Enable recording

Tick this checkbox to enable the recording feature. There are two options available for recording, **SD Card** or **Samba network drive**.

Record to

Click a radio button to specify where the recording should be saved. The available options are **SD Card** or **Samba network drive**.

SD Card

This option specifies that the recording will be saved to the SD Card in the SD Slot on the side of the camera.

Samba network drive

This option specifies that the recording will be saved to a Samba drive on your network.

Samba Auth

Use the drop-down menu to specify whether a user name and password is required to access the Samba drive. If no user name or password is required to access the Samba drive, choose *Anonymous* from the drop-down menu. If a user name and password is required to access the Samba drive, choose the *Account* option from the drop-down menu and configure the parameters as described below:

- **User Name-** Type the user name required to access the Samba drive.
- **Password-** Type the password required to access the Samba drive.
- **Password Confirm-** Type the password required to access the Samba drive for verification.
- **Server-** Type the name or IP address of the server your Samba drive is on.
- **Shared Folder-** Enter the path that points to the shared server.

	Hours	Minutes	Hours	Minutes
<input checked="" type="checkbox"/> Sun	Start 00	:	00	End 24 : 00
<input checked="" type="checkbox"/> Mon	Start 00	:	00	End 24 : 00
<input checked="" type="checkbox"/> Tue	Start 00	:	00	End 24 : 00
<input checked="" type="checkbox"/> Wed	Start 00	:	00	End 24 : 00
<input checked="" type="checkbox"/> Thu	Start 00	:	00	End 24 : 00
<input checked="" type="checkbox"/> Fri	Start 00	:	00	End 24 : 00
<input checked="" type="checkbox"/> Sat	Start 00	:	00	End 24 : 00

Click the **Test** button to check that the TV-IP522P can connect to the Samba drive.

Snapshot Preferences

The Trigger menu is used to determine when and how recorded digital images from snapshots are handled. Use motion detection to trigger a snapshot and email it to the account configured here. Alternatively, the images can be sent to an FTP server. Configure FTP Server and email address information, and click to checkmark either or both options to use.

Scheduling

Snapshot scheduling includes three options, snapshots can be:

- **Event Based** Images are created based on triggering events (motion detection and digital input signal via I/O terminal).
- **Continuous (FTP only)** Images are created at set intervals and sent to an FTP server. The intervals determine how often the snapshots are made and are configured in the FTP Server setup menu.
- **Scheduled (FTP only)** Images are created based on a set schedule. Use the schedule provided to determine the time periods when images are configured and sent to an FTP server. This also requires an Interval setting to set the time period between snapshots.

Wizard		Snapshot								
System		<input type="checkbox"/> Enable Snapshot								
Network		Scheduling								
Video/Audio		<input type="checkbox"/> Event Based								
Action		<input type="checkbox"/> Motion Detection								
• Recording		<input type="checkbox"/> D1 Signal 1								
• Snapshot		<input type="checkbox"/> D1 Signal 2								
• Digital Output		<input type="checkbox"/> Continuous (FTP only)								
• RS-485		<input type="checkbox"/> Scheduled (FTP only)								
Motion Detection			Hours	Minutes	Hours	Minutes				
Tools		<input checked="" type="checkbox"/> Sun	Start	00	:	00	End	24	:	00
Device Info		<input checked="" type="checkbox"/> Mon	Start	00	:	00	End	24	:	00
		<input checked="" type="checkbox"/> Tue	Start	00	:	00	End	24	:	00
		<input checked="" type="checkbox"/> Wed	Start	00	:	00	End	24	:	00
		<input checked="" type="checkbox"/> Thu	Start	00	:	00	End	24	:	00
		<input checked="" type="checkbox"/> Fri	Start	00	:	00	End	24	:	00
		<input checked="" type="checkbox"/> Sat	Start	00	:	00	End	24	:	00

enu

Send to

Select the **E-mail Address** checkbox to specify that the images will be sent to an e-mail address. Configure the parameters as described below:

- **User Name-** Type the User Name or login name for your e-mail account.
- **Password-** Type the password for your e-mail account.
- **SMTP Mail Server-** Type the SMTP server for your e-mail account.
- **Sender E-mail Address-** Type the e-mail address that you want to appear as the "From:" e-mail address in the snapshot e-mail.
- **Recipient E-mail Address-** Enter the e-mail address that you want to send the snapshots to.
- **Port-** Enter the port number that will be used to send the snapshot e-mails.
- **Test-** Click this button to send a test e-mail from the TV-IP522P to the specified recipient e-mail address to verify that all the credentials have been configured correctly.

TV-IP522P ProView Megapixel Internet Camera

Select the **FTP Server** checkbox to specify that the images will be sent to an FTP Server. Configure the parameters as described below:

- **User Name-** Type the User Name of your FTP account.
- **Password-** Type the password for your FTP account.
- **Host Name-** Type the Host Name of your FTP server.
- **Path-** Enter the file path to the location on the FTP server you want to send snapshots to.
- **Filename Prefix-** Enter the prefix you want to attach to your snapshot files.
- **Port-** Enter the port number used by your FTP server.
- **Passive Mode-** Tick this checkbox if your FTP server requires you to use passive mode.

Click the **Ok** button to save your changes, or click **Cancel** to discard any changes made.

Digital images can also be sent to any display running the User Interface during the event. To enable this use the **Digital Output** menu (see below).

Digital Output

Use this menu to enable digital output triggered by motion detection or an input signal through the I/O terminal. The digital output signal is typically used to activate another device such as lights, alarm or some type of notification. For example, a device connected to the I/O terminal might be triggered when a door is opened.

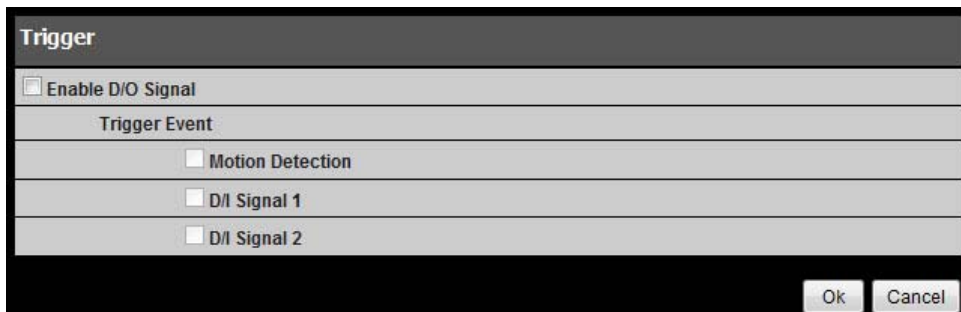

The screenshot shows a 'Trigger' configuration window. It has a title bar 'Trigger'. Below the title bar is a checkbox 'Enable D/O Signal'. Underneath is a section 'Trigger Event' with three sub-items: 'Motion Detection', 'D/I Signal 1', and 'D/I Signal 2', each with an unchecked checkbox. At the bottom right are 'Ok' and 'Cancel' buttons.

Digital Output

With the digital output enabled from a D/I Signal trigger event, a light switch is turned on and a recorded message is played.

TV-IP522P ProView Megapixel Internet Camera

RS-485

RS-485 control is used to enable use of external devices (such as motorized rotational or pan and tilt camera stand) operated through the I/O port.

Note: 485+/- of the I/O connector are used for RS-485. Refer to the manufacturer's user manual for proper connection instructions.

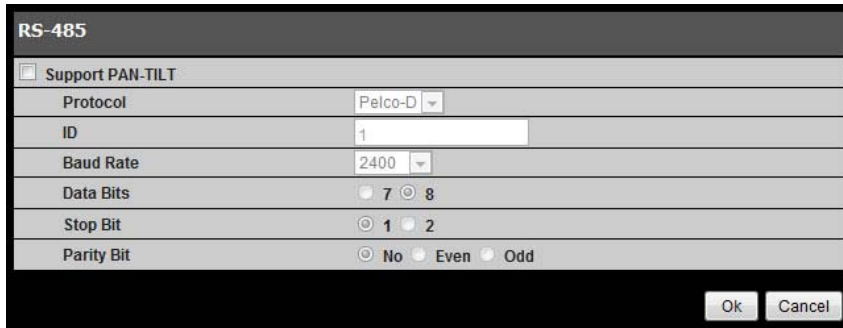

RS-485 support

To use a RS-485 Pan/Tilt device, click to check the **Support PAN-TILT** option box. Choose the Protocol used for the device from the pull-down list. Check the remaining settings to make sure they are compatible with the RS-485 device. Refer to the manufacturer's instructions included with the RS-485 device.

When the Pan/Tilt stand is properly connected and the RS-485 settings are compatible, the main user interface will include directional control arrows used for pan and tilt control of the stand.



Directional View Controls in the main User Interface

Home button Left click the round button labeled **[+]** at the center of the controls to return the camera to the **Home** position.

Pan / Tilt control Use your mouse and left click button to move the directional control in the right panel of the video display page and left click on the arrow to move the camera in that direction.

Motion Detection

Motion detection is used to trigger video recording when motion is detected in a designated portion of the video display. To designate a portion of the display used for motion detection, choose the **Draw motion area** option and use the mouse and left mouse button to draw a rectangular area. The drawn area appears as a red box on the display in the **Motion Detection** menu. Click the **Enable Video Motion** box to check mark it and click the **OK** button. **Sensitivity** level can be set by typing a value from 0 – 100, with 100 being the most sensitive.

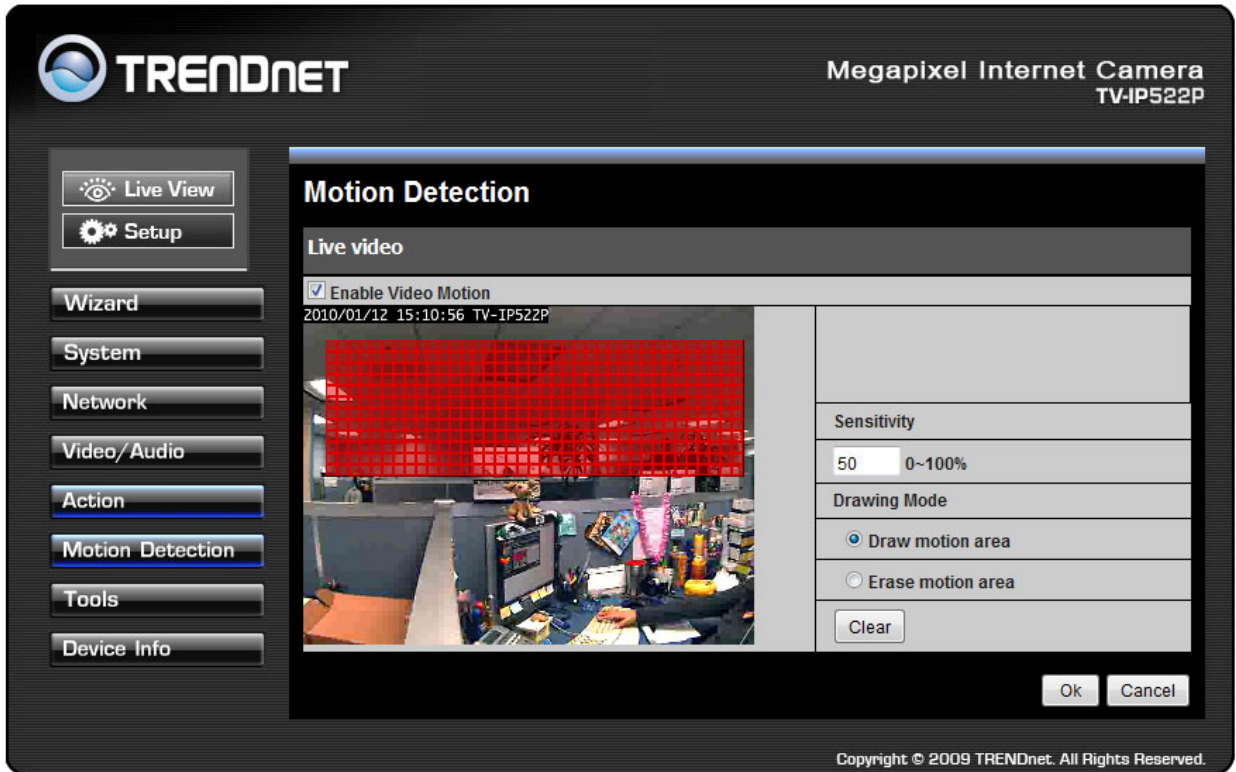

Motion detection menu (drawn area in red)

To remove an established drawn motion area, select the **Erase motion area** option and click **OK**. To remove an area that has not yet been saved, click **Clear**.

Tool

The Tool menu contains two sub-menus that provide the Backup and Restore and Firmware upgrade.

Back Up and Restore Camera Settings

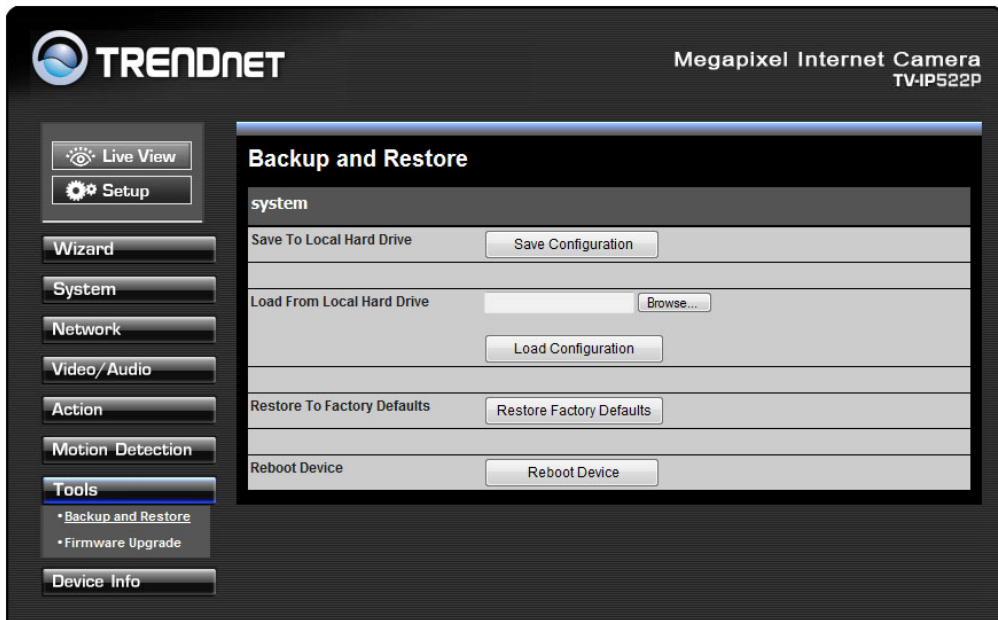

Save System Settings/Restore/Reboot menu

Save To Local Hard Drive

To save configuration settings for the camera to a file on a local hard disk, click the **Save Configuration** button. A prompt appears to confirm that you want to save the file. Choose the location and save the file to load the same settings.

Load From Local Hard Drive

To load a previously saved configuration settings file, click the **Browse** button to Load From Local Hard Drive to locate the file, and then click the **Load Configuration** button. It will take a few seconds to load the new settings. The camera will then restart.

Restore To Factory Defaults

To restore the camera to the factory default configuration settings, click the **Restore Factory Defaults** button. A prompt appears to confirm that you want to restore the default settings. Click OK to restore the settings.

Reboot Device

To perform a simple restart of the camera, click the **Reboot Device** button.

Firmware Upgrade

To upgrade the camera firmware, make sure the correct firmware file is located on your computer. Click the **Browse** button to locate the file. After locating the file, click the **Upload** button to load the file. It will take several seconds to load the firmware and restart the camera.

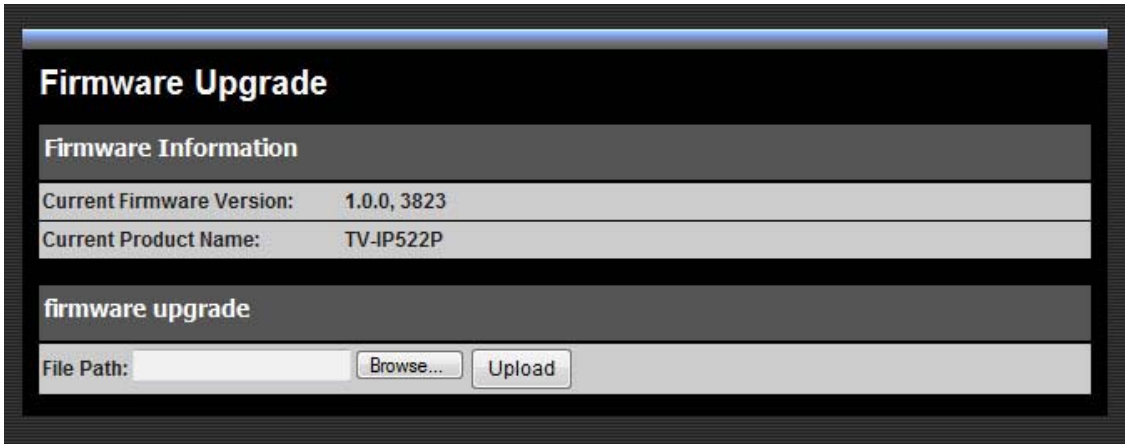

The screenshot shows a web interface for firmware upgrade. The title is "Firmware Upgrade". Below the title is a section titled "Firmware Information" which contains two rows of data: "Current Firmware Version: 1.0.0, 3823" and "Current Product Name: TV-IP522P". Below this is a section titled "firmware upgrade" which contains a "File Path:" label, an empty text input field, a "Browse..." button, and an "Upload" button.

Firmware Information	
Current Firmware Version:	1.0.0, 3823
Current Product Name:	TV-IP522P

firmware upgrade

File Path:

Firmware Upgrade
window

Device Information

Network information, MAC address and firmware version is displayed in the **Device Information** display.

Device Info	
Information	
Camera Name	TV-IP522P
Time & Date	Tue Jan 12 15:13:47 2010
Firmware Version	1.0.0, 3823
MAC Address	00:80:E2:45:B8:5E
IP Address	192.168.1.45
IP Subnet Mask	255.255.255.0
Default Gateway	192.168.1.254
Primary DNS	192.168.1.249
Secondary DNS	
PPPoE	Disable
DDNS	Disable

Device Information display

Log

Click the Log link to view the camera's current log. To save the log in simple text form on your computer, click the **Download** button. **Click Clear** to delete all entries in the log.

Log	
current log	
2000-01-02 10:15:01 System is booted up.	
<input type="button" value="Clear"/>	<input type="button" value="Download"/>

Camera Log

IPView Pro 2.0

This section describes the how to setup a camera using the IPView Pro 2.0 camera monitoring software. To install IPView Pro 2.0 on a system running Windows, launch the IPView Pro 2.0 installation software on the installation CD-ROM and follow the setup instructions. Once the software is installed, the IP Cam Center camera monitoring utility is ready for use. Add up to 32 network cameras to monitor using the software. Additional software, IPCam Player software is also installed. The IPCam Player is used for playing recorded video from cameras that have been configured to save recorded files.

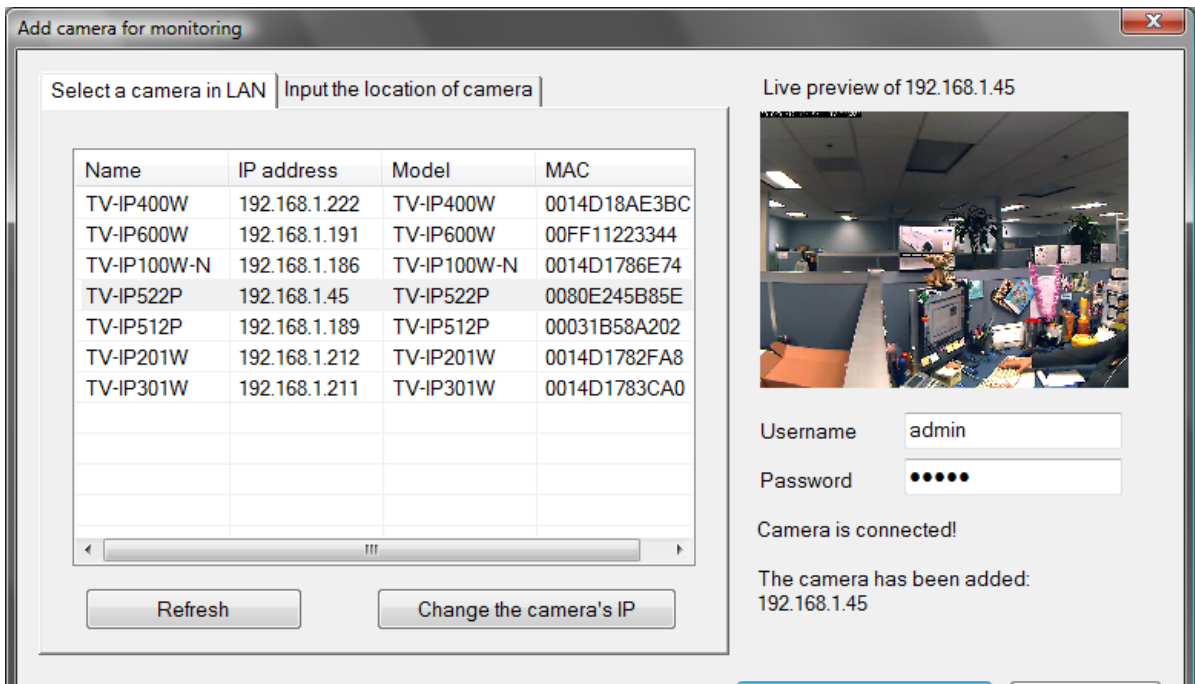

Launching IPView Pro 2.0 for the first time

To launch IPView Pro 2.0, click **Start > Programs > TRENDnet > IPView Pro 2.0 > IPView Pro 2.0**. If this is the first time using the software, the menu that appears is the **Add camera** menu:

Add a camera for monitoring

The Add camera menu is presented the first time the IPView Pro 2.0 software is launched. This menu is used to add cameras to the user interface for monitoring. After the first time running the software, this menu can be accessed at anytime from the Configuration menus. The Configuration menus are described in a later section of this chapter. Notice that the IPView Pro 2.0 software has automatically detected eligible cameras running on the network.

To add a camera to the IPCam user interface, follow these instructions:

1. Check the list of cameras detected by the software. If the camera you want to add does not appear on the list, click the **Refresh** button to conduct another search.

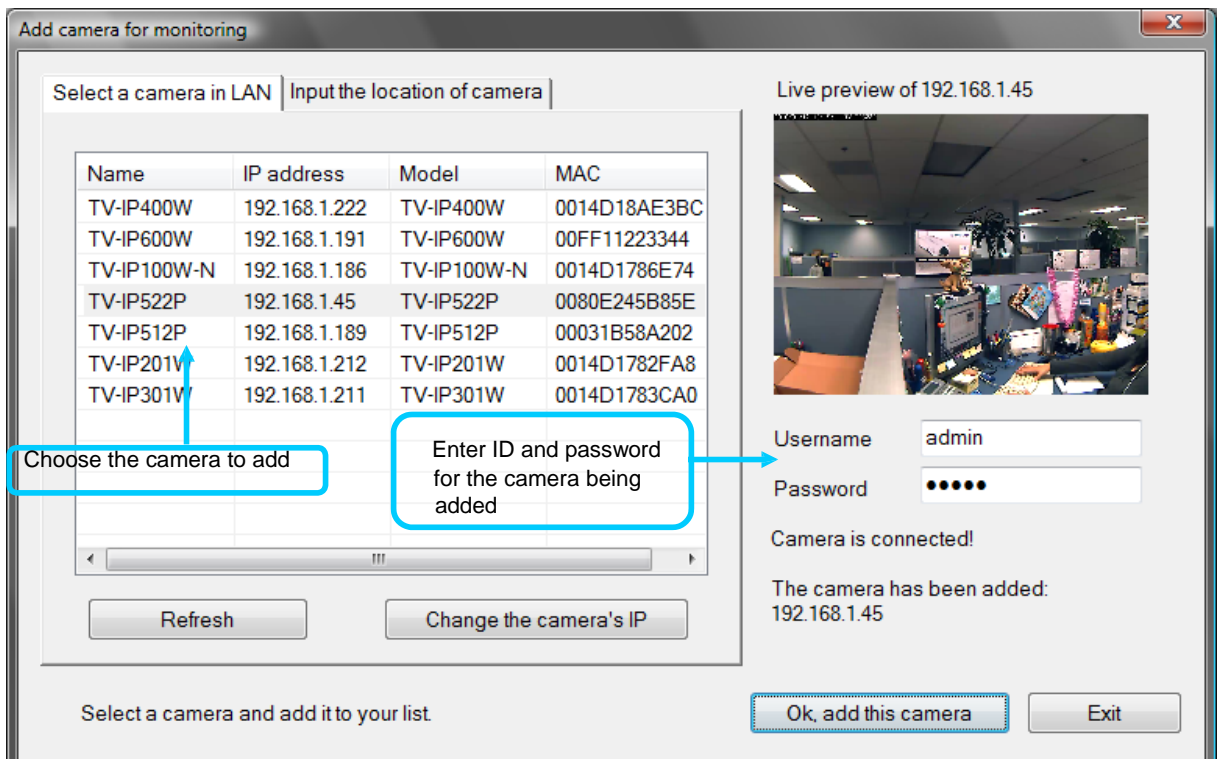

2. Select the camera to add from the list, enter the administrator's user name (ID:) and password, a preview of the live video display will appear. Click the OK, add this camera button, a confirmation message informs when the camera is connected and added to the IPView Pro 2.0 monitoring group. Repeat this procedure for all the cameras being added. Click the Exit button after all the cameras have been added.

TV-IP522P ProView Megapixel Internet Camera

If the camera does not appear listed, click the **Input the location of camera** tab above the list to view a new menu. Enter the IP address or the URL (for example, *ipcam.ddns.org*) of the camera being added, type the user name and password and click the **Preview** to verify that a link can be established. The live video of the camera should appear in the **Live preview** display. If a link cannot be established, run the SetupWizard software for the camera and verify the correct IP address. Click **Exit** to return to the main **Add camera menu**.

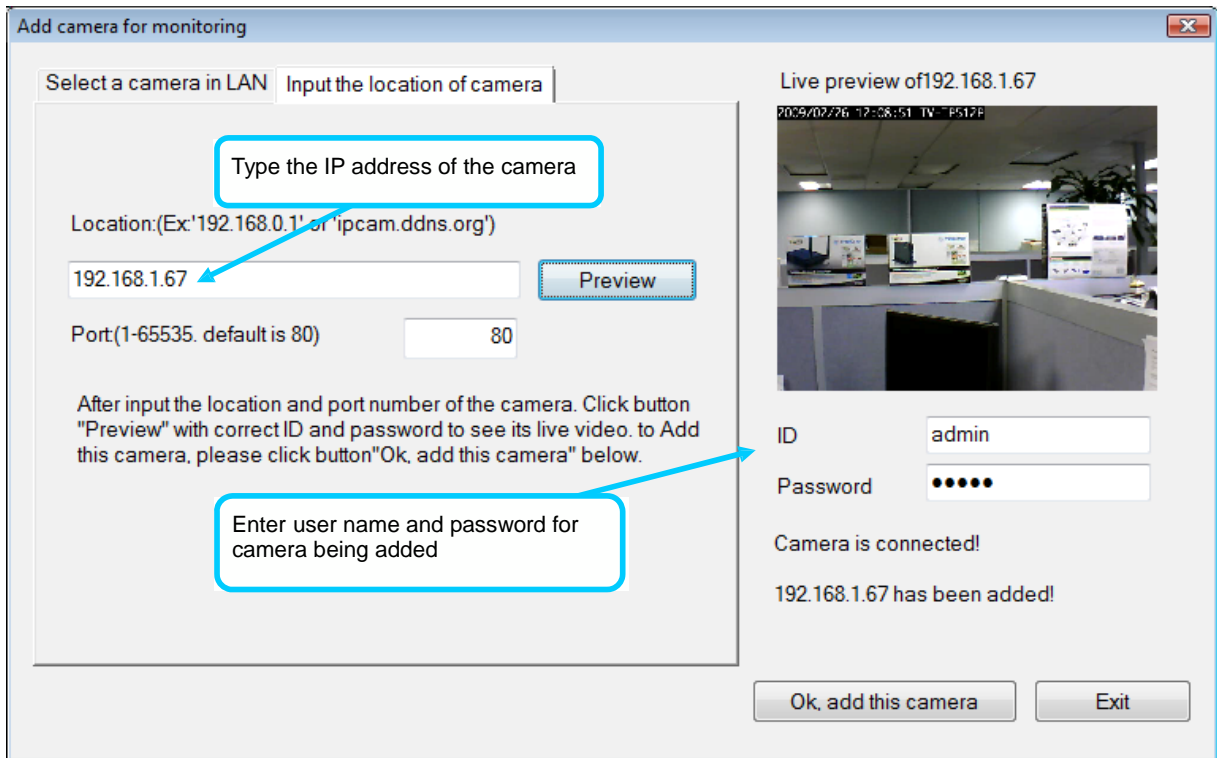

- Once the cameras have been added, they are ready to be used in the main IPView Pro 2.0 user interface. Close the Add camera menu (click **Exit**) to go to the main user interface. See below for a description.

IPView Pro 2.0 User Interface

Below is a general description of the user interface.

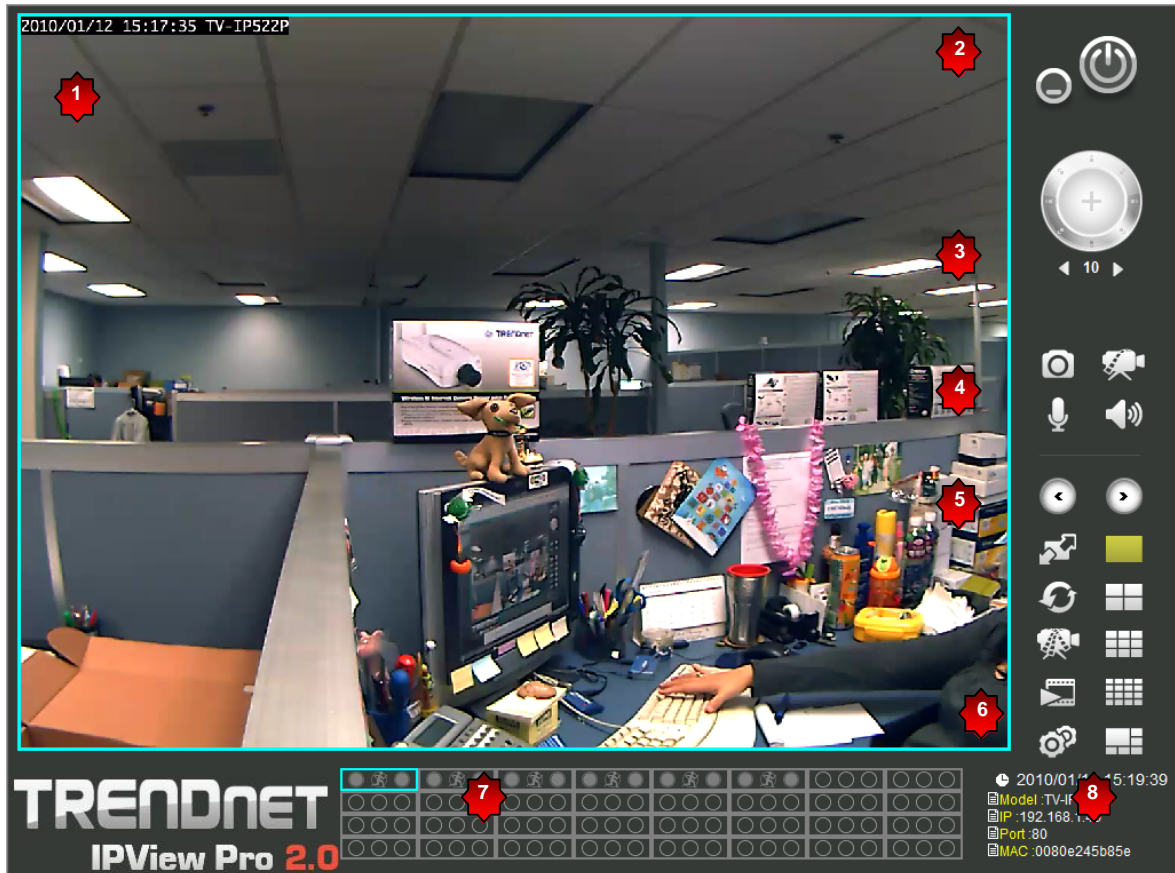

NO.	Item	Description
1	Live video display area	Display area for single or multiple cameras of live video. Right click on any display area to view a list of quick configure options for that camera including the "Replace camera content ..." option used to change the order of the live video displays for multiple camera views.
2	Minimize and Exit	Use to minimize IPView Pro 2.0 interface or exit the program, a confirmation is required to exit.
3	Pan and Tilt control (cameras using RS-485 Pan/Tilt device only)	Click directional arrows to move camera in that direction within the limits of the pan and tilt range. The + in the center of the control is used to return to the home or center view as configured for the camera.
4	Snapshot, recording and audio controls	See below for detailed information.
5	Live video display controls	See below for detailed information.
6	Camera configuration menu	See below for detailed information.
7	Camera status	Use to quickly assess the status of operating cameras. Click on box to select camera display. The status indicators for each camera display recording, motion detection and GP input status.
8	Camera information	Displays basic information on selected camera.

Display Controls

The primary display and IPView Pro 2.0 control icons are described in detail below. When there are more than one camera displays viewed, one of the displays can be selected for management or additional changes. Simply left click on any display to select it. Notice the border around the display is bright aqua blue, indicating the “selected” status. For example, to go to a single screen display for any one camera, select the camera and click on the single screen display.

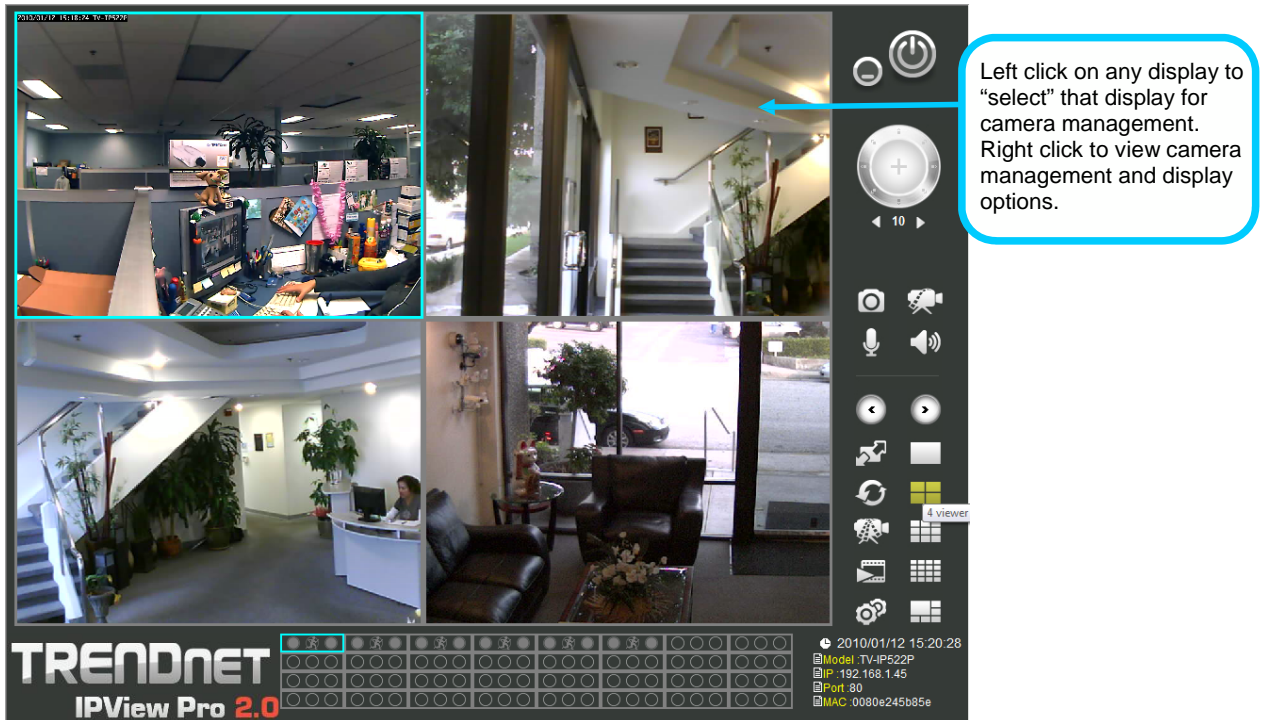

Snapshot, recording and audio controls

The still photo camera icon is used to take a snapshot of the selected live video display. The video camera icon is used to begin video recording of the selected live video display. Snapshot and videos files are stored in a default folder on the administrator’s system, or in a folder designated by the administrator.

The audio controls are represented by a microphone icon to activate the internal mic or the auxiliary audio input (if present), and a speaker icon for the audio output (remote speakers, if present).

Notice that when these functions are activated, the color of the icon changes from white to yellow.



Audio and video controls - inactive

Audio and video controls - activated

Live video display controls

Use the video display controls to change the view of the live video display. This is useful for multiple camera application.

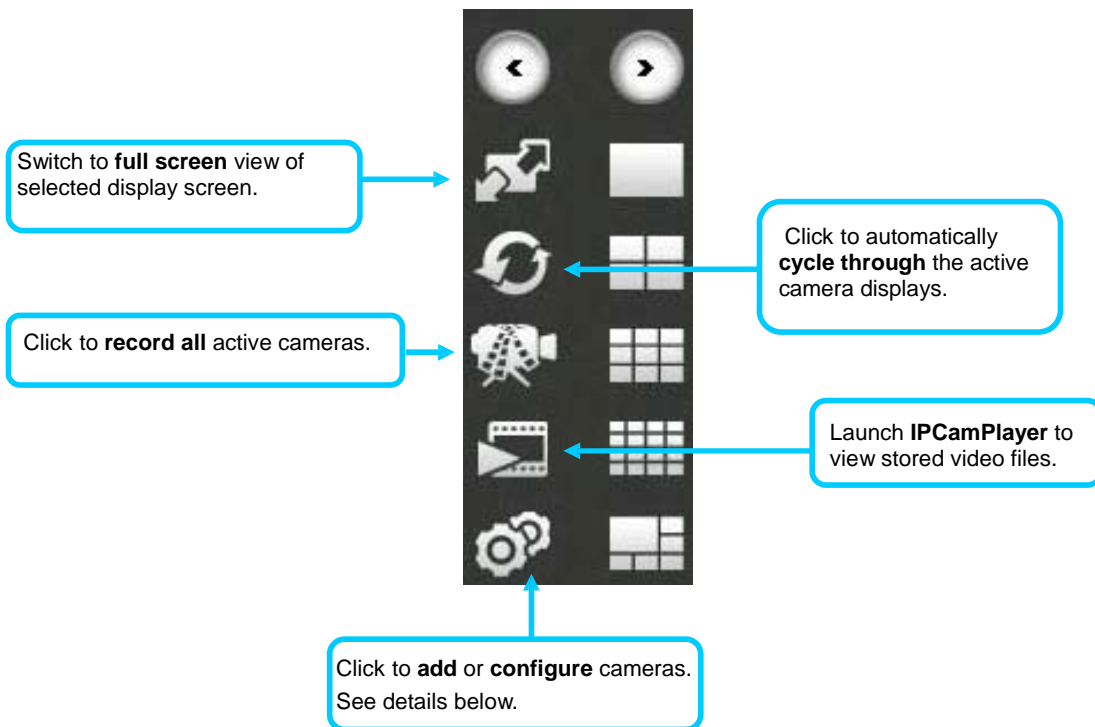
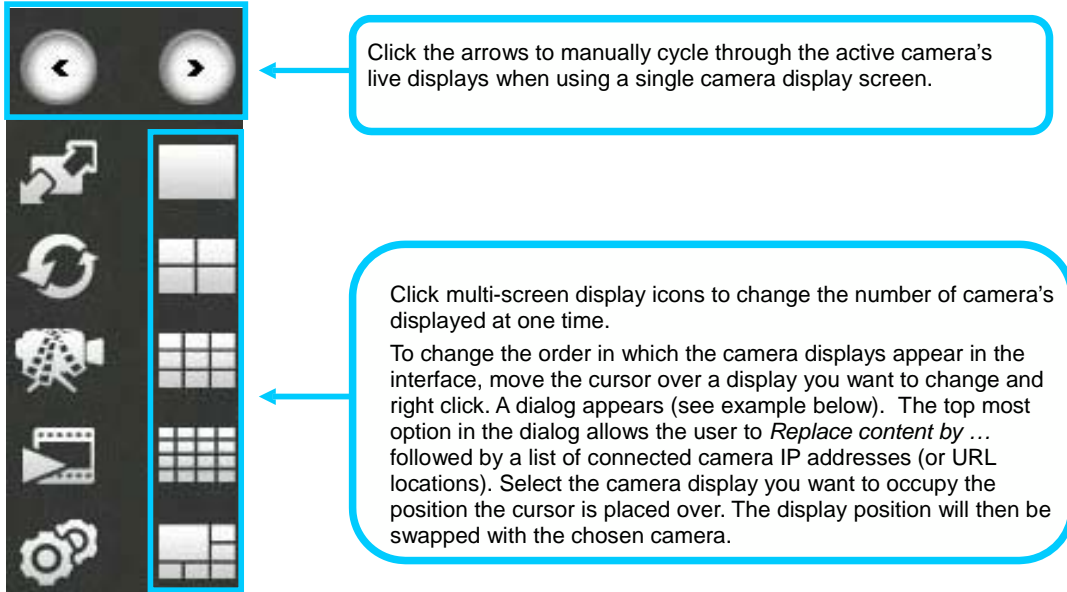

Camera configuration with IPView Pro 2.0

Access the camera configuration menus by clicking on the gear icon at the bottom of the right hand panel of the IPView Pro 2.0 user interface. Configuration options include adding and deleting cameras from the display view, configuration of motion detection and digital input with schedules, recording options, email alerts and other network settings.

Adding a Camera

The procedure to add a camera after the initial launch of the software is very similar to the procedure used during the first setup. Follow the instructions below to add cameras.

To add a camera:

1. Click the Configuration icon to view the Camera Setup menu. The top most tab of the menu is the Camera Management tab. A list of active cameras appears on the left half of the menu. Select the camera to be added from the list. **Click the Add Camera by IP Address** to find the specified IP address or network URL of the camera you want to add.

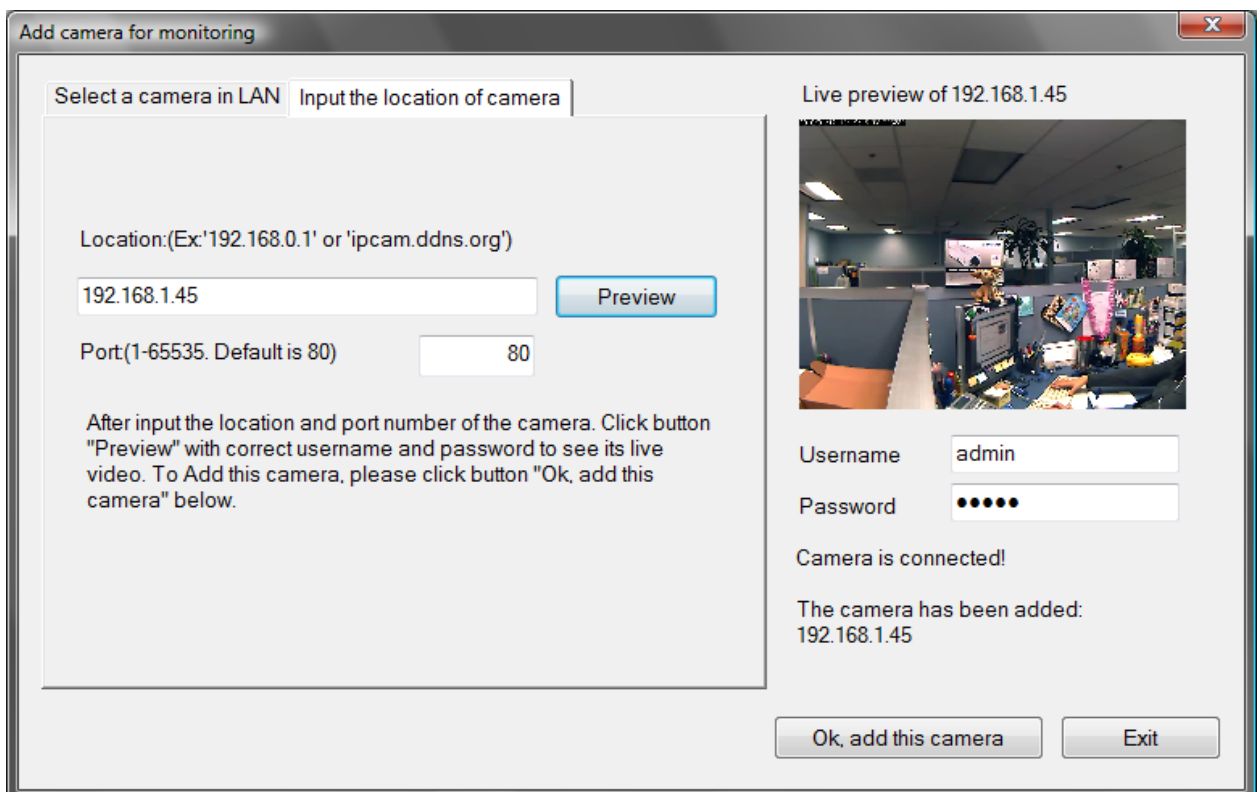

TV-IP522P ProView Megapixel Internet Camera

2. Select the camera to add from the list, enter the administrator's user name (**ID:**) and password, a preview of the live video display will appear. Click the **OK, add this camera** button, a confirmation message informs when the camera is connected and added to the IPView Pro 2.0 monitoring group. Repeat this procedure for all the cameras being added. Click the **Exit** button after all the cameras have been added.

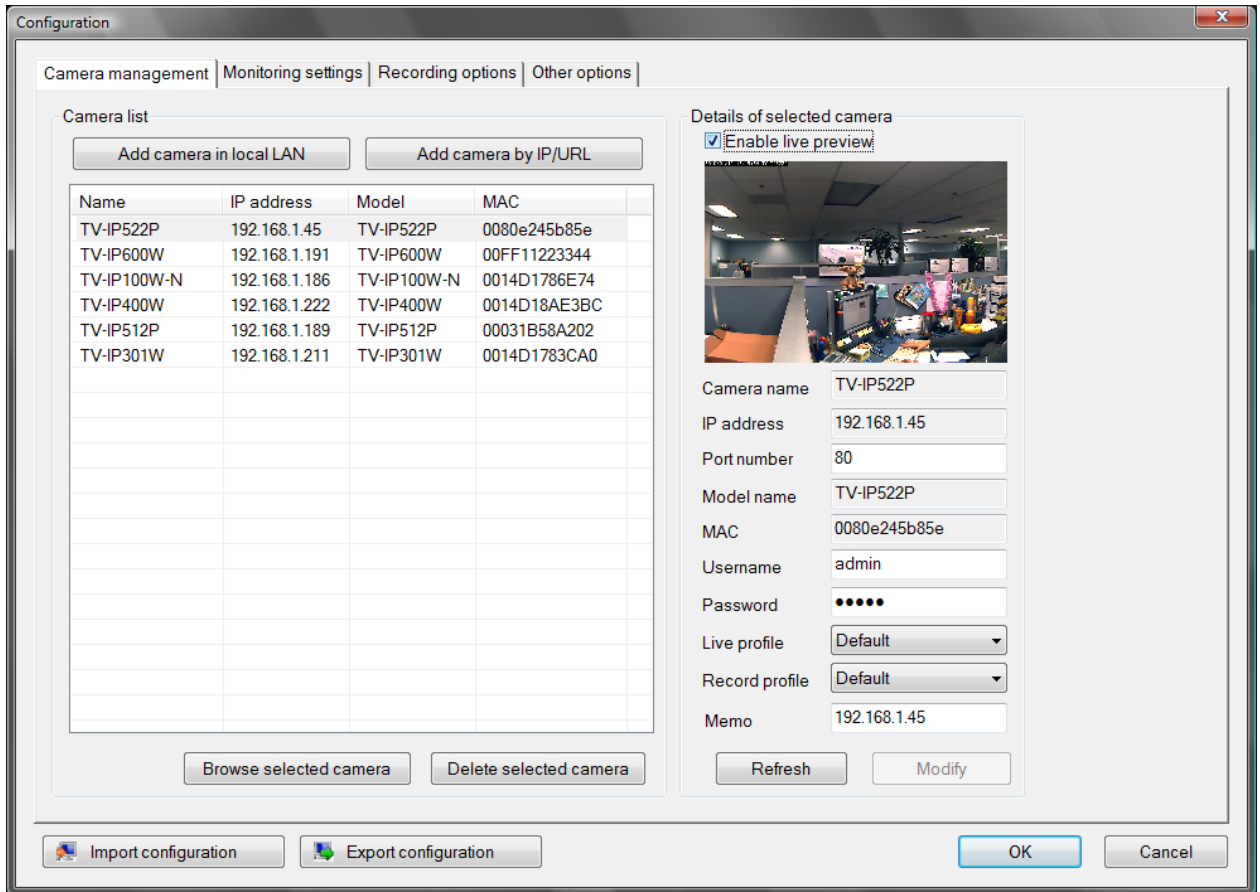

3. The camera added now appears in the Camera List. To launch the web manager for the newly added camera or any camera in the active camera list, select it and click the **Browse Selected Camera** button.

Removing a Camera

To remove the camera from the list of active:

1. Select the camera you want to remove.
2. Click **Delete Selected Camera**.

Note: Any camera display can be removed from the main IPView Pro 2.0 user interface by right-clicking on the display screen for the camera and selecting the **Remove this Camera** option.

Launch Web Manager for Selected Camera

To launch the web-based IP Camera manager for any active camera in the list, simply select it and click the **Browse Selected Camera** button.

Schedule Recording with IPView Pro 2.0

Use the **Monitoring Settings** menu to create schedules for recording and apply the schedules to any camera. Click the **Monitoring Settings** tab to view the **Schedule Recording** menu (the first menu viewed in the Camera Settings menu tab).

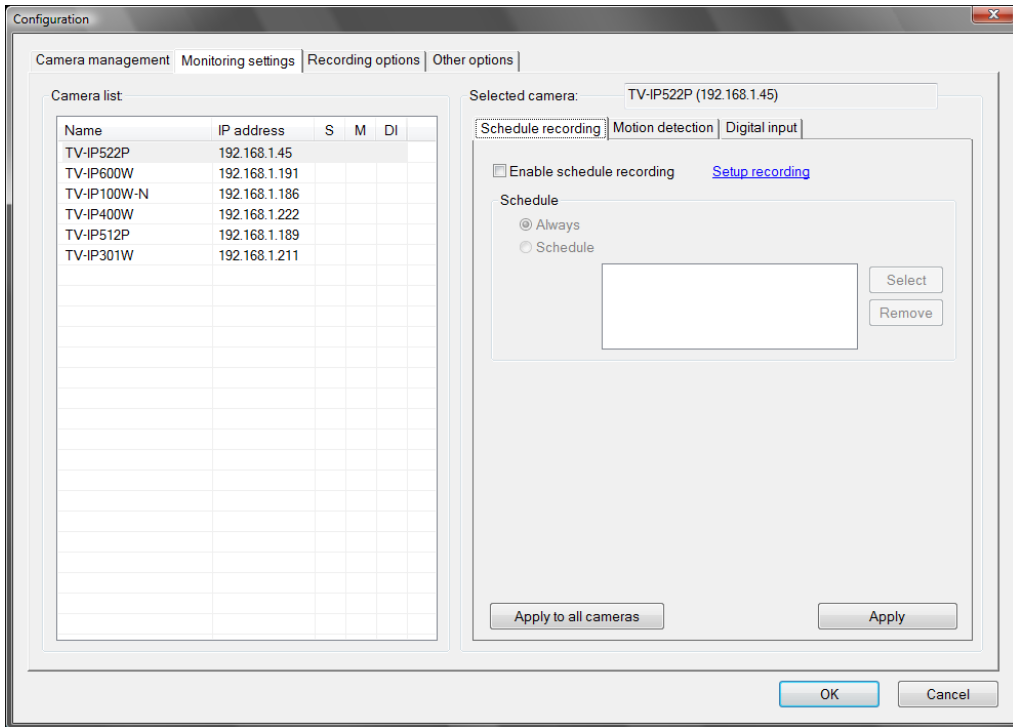

To apply an existing schedule profile, click the **Select** button and choose a schedule from the list of previously created schedule templates. If a new schedule is needed it can be created from the **Select Schedule Template** menu (See below).

Create Schedule Templates

To make a new schedule template, click the **Create Template** button to view the Create Schedule Profile menu. Use this menu to create new schedules for recording.

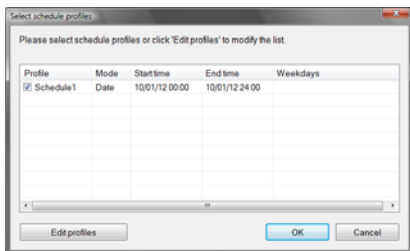

Click **Create Template** to make a new schedule.

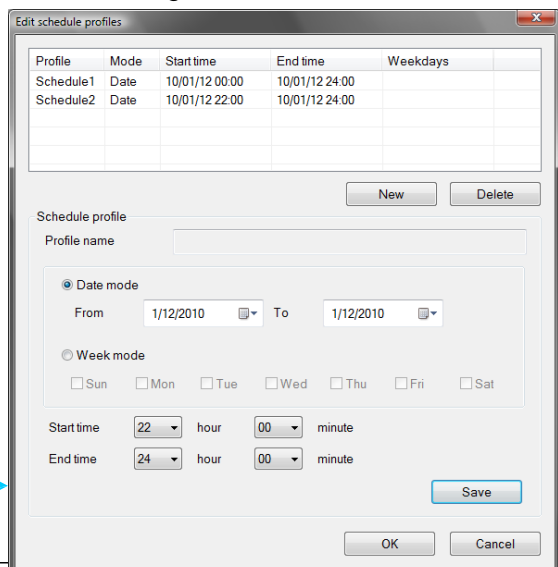

Setup Motion Detection and Digital Input with IPView Pro 2.0

The **Monitoring Settings** Camera Settings menus include **Motion Detection** setup and **Digital Input** control. Each menu has the schedule option to apply a schedule for the action taken or always take the specified action.

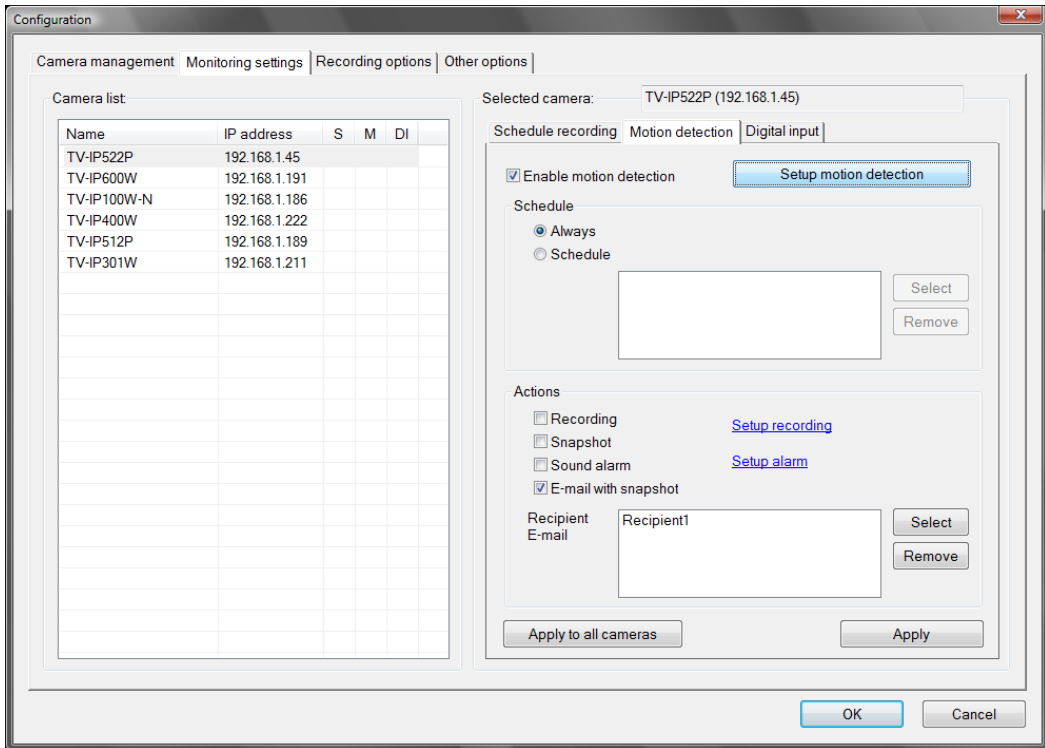

For Motion Detection, use the **Config motion detection area** menu to create the monitor area by clicking on the applicable location in the image. Check the Activate MD to enable motion detection feature and draw the area that you want to monitor, **Save settings** once done.

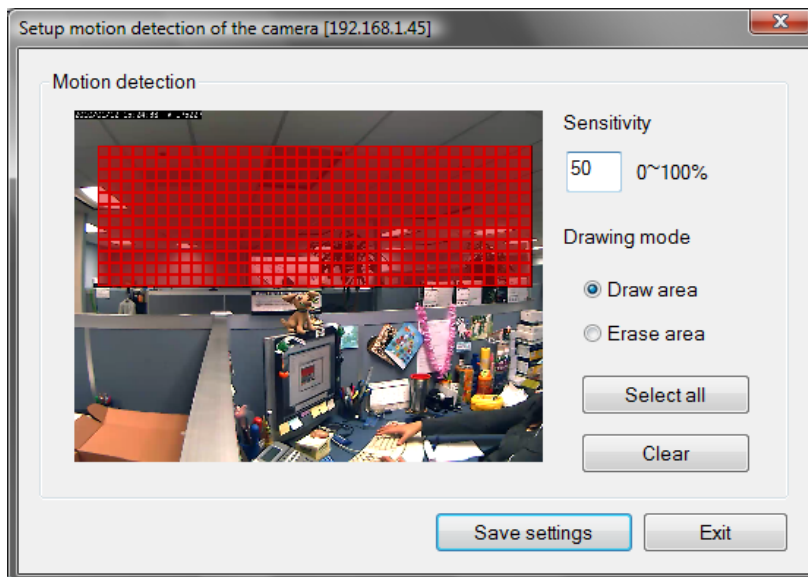

IPView Pro 2.0 Recording Options

The Recording Options configured in the IPView Pro 2.0 help to conserve and manage allowed memory storage (disk space) and for video file management. Recorded files can be limited by time elapsed or by size. Use the select storage folder to choose an alternative destination for stored video files. Storage limits can be set for each camera by time elapsed or hard disk space allowed. A limit can also be placed for the system and all cameras used in IPView Pro 2.0.

The screenshot shows the 'Recording options' tab in the IPView Pro 2.0 Configuration window. It is divided into three main sections: Recording configuration, Disk space usage information, and Recording file splitting.

Recording configuration:

- Folder:** Set the folder for recording and snapshot. The selected folder is 'Documents and Settings\06277\My Documents'.
- Reserved space:** Set the reserved HDD space for system. The value is set to 500 MB.
- Quota:** Set the quota for each camera, you can select by space or by time.
 - By space: 500 (MB)
 - By time: 1 (Days)

Disk space usage information (Disk C:):

A pie chart shows the disk usage: 45.5% Used (blue), 52.0% Free (pink), and 11.22% Reserved (green). A table to the right provides the following data:

Total	40013 MB
Used	18197 MB
Available:	21816 MB
Reserved	500 MB
Current camera number	1
Total quota:	500 MB
Free	20816 MB

Recording file splitting:

Set the length of the recording file. You can be set by recording time or by file size.

- Time interval
- Size interval
- Value: 60 Seconds (7200 seconds at most)

Buttons for 'OK' and 'Cancel' are located at the bottom right of the window.

IPView Pro 2.0 Miscellaneous Options

The Other Options available for configuration include Proxy server setup, email notification, scan interval and alert type settings.

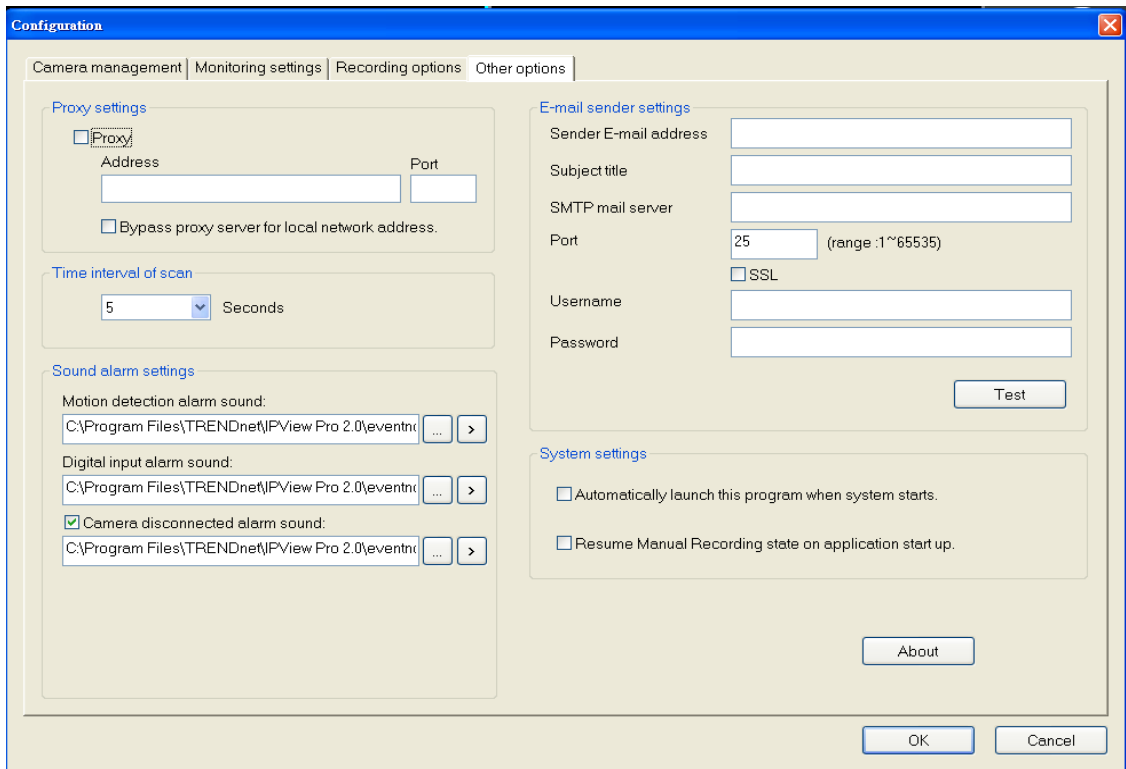

If you are using a SSL email account(eg. Gmail) to send the images; please select SSL at this location with the proper user name and password for the account.

Playing Video Files on a Computer

IPCamPlayer software is installed on the monitoring station or administrator's system along with the IPView Pro 2.0 monitoring software. Use it to playback and manage recorded video from the cameras added to the IPView Pro 2.0 group. In order to use the software however, it is necessary to first install the **ffdshow** package of codecs used for media files. There is an ffdshow installation file on the CD shipped with the camera. Install ffdshow before using the IPCamPlayer. For information on installation and use of ffdshow, see the ffdshow section at the end of this chapter.

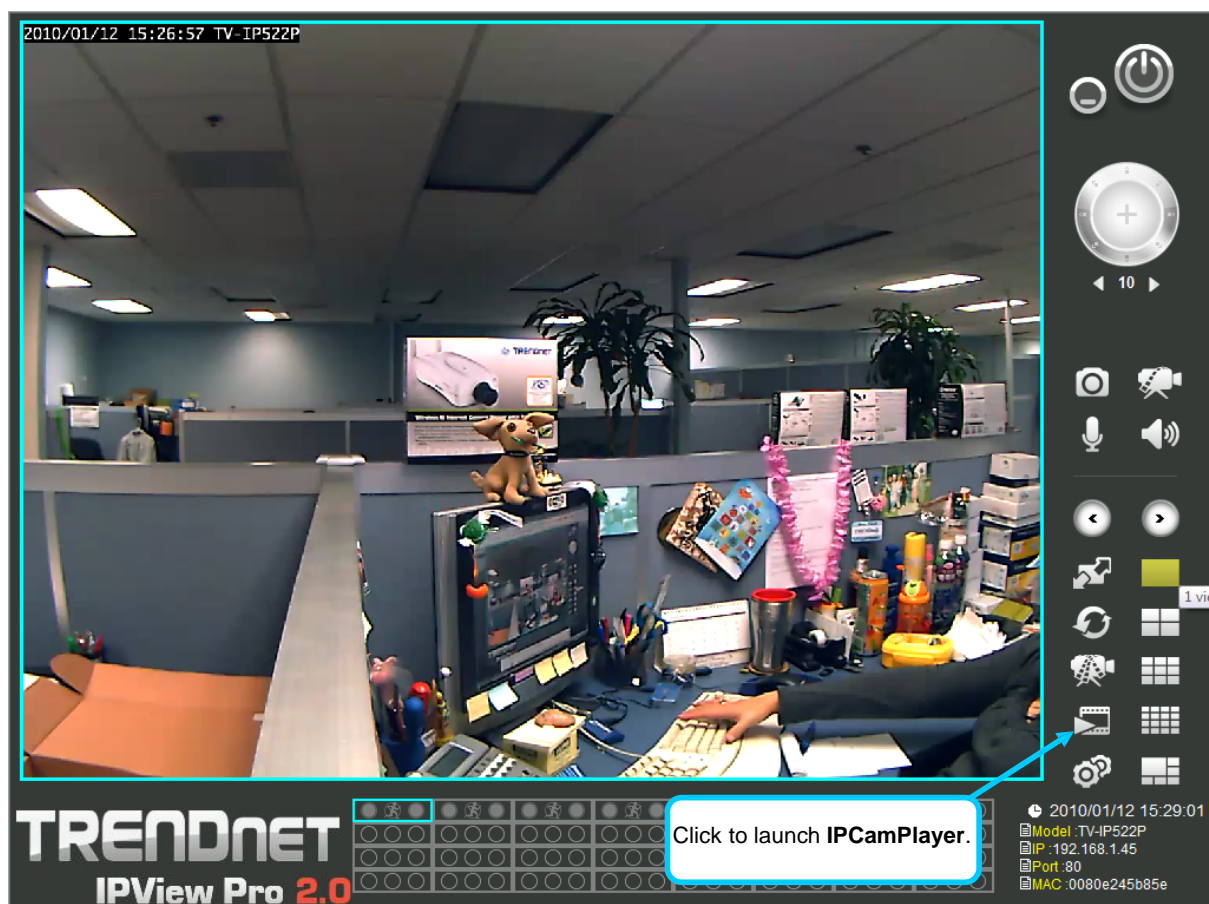

The IPCamPlayer can be launched directly from the IPCamCenter or from the Programs menu. To launch the program from the IPView Pro 2.0 interface, click the movie icon on the control panel of the main IPView Pro 2.0 interface to launch IPCamPlayer.



NOTE: Install the **ffdshow** package of video codecs from the installation CD before using the IPCamPlayer.

Load Saved Video Files

Each camera has a file created automatically for storing video files. These files are normally located in the My Documents folder in Windows. The file folders are named according to the IP address and camera model. For example, 192.168.10.30_TV-IP522P is the name of the file folder for the TV-IP522P using the default (non-DHCP) IP address.

IPCamPlayer User Interface

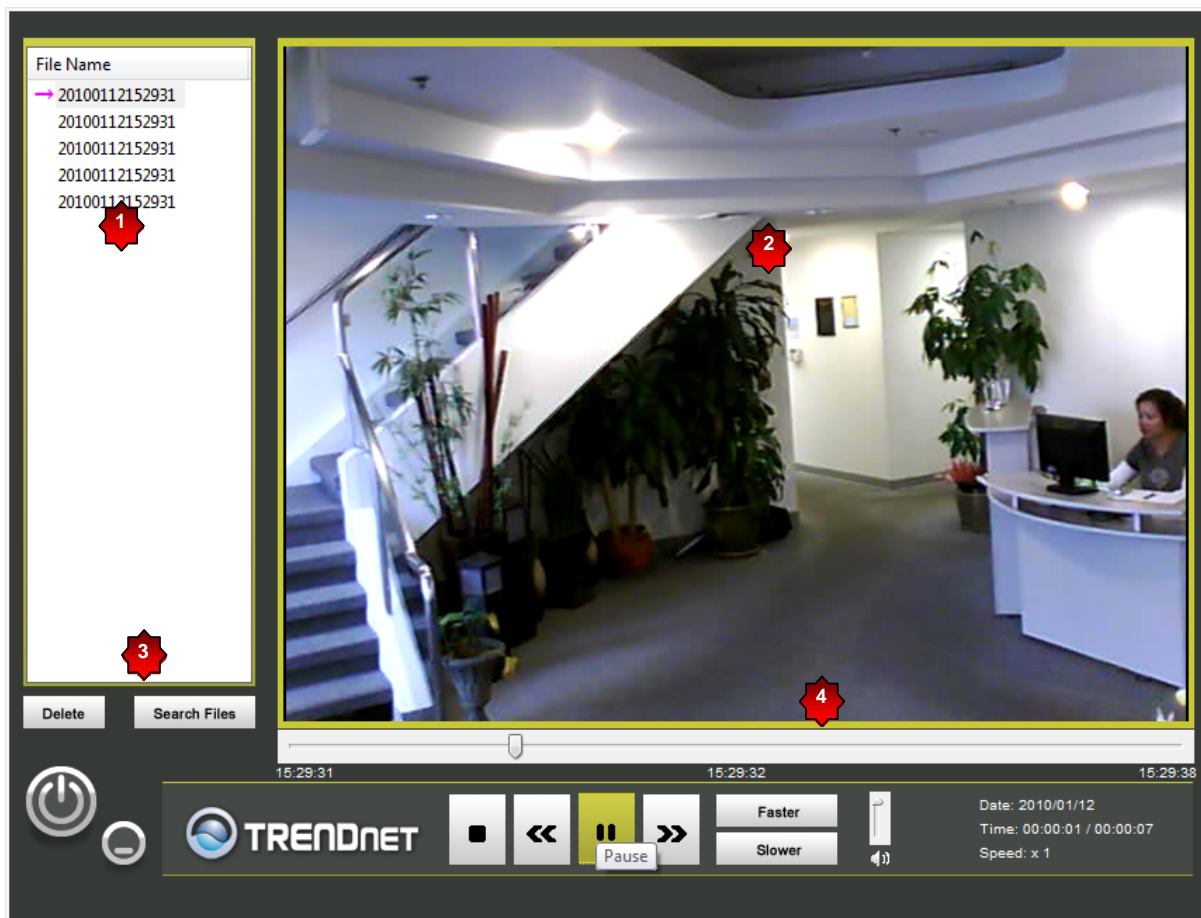

NO.	Item	Description
1	File list	Video files added to the list are viewed in the order listed.
2	View Screen	Video files in the list are played here. The progress bar and starting time of the video clip appears beneath the view screen.
3	Add/Delete files from list	Use the Search Files button to add recorded video files. A new menu pops up that is used to find and add files to the list. (See description on next page)
4	Playback controls	Standard video playback controls for Stop , Play/Pause , go to next file (>>) or go to previous file (<<) Faster and Slower to control speed of playback. Playback can be slowed to as much as 1/8 normal speed or speeded up to as fast as 8 times the normal speed. The vertical slider control is used for audio volume control.

To view recorded video files in the IPCamPlayer, it is first necessary to locate and select the files to be viewed and add them to the list. Click the **Search Files** button in the IPCamPlayer main interface and a new menu appears.

In the new menu, use the **Select Camera** pull-down menu to choose the video file folder of the camera to be reviewed. Use the **Search Time** menu to narrow the search to a specific time and date. Finally, the **Event** selection menu is used to further narrow the scope of the file search for videos triggered by **Motion Detection** or a **Digital Input** device. When the search criteria have been defined, click the **Search** button to place qualified files in the Search list.

IP Address	Camera Name	Date & Time
<input checked="" type="checkbox"/> 192.168.10.30	TV-IP522P	20091223114734

Select Camera : Search All Camera

Select Time :

From : 2009/12/22 12:02:14

To : 2009/12/23 12:02:14

Event : Motion Detection Digital Input

Select All Clear All Search OK

Choose the files to be added to the view file list by check marking the individual files or click the **Select All** button to check mark all files in the Search list, click **Add** to place the check marked files on the list of files for viewing.

After the files to be viewed have been chosen, click the **OK** button.

Play Video Files

Now that the recorded video files have been selected and placed on the file list, they can be played and reviewed in the IPCamPlayer. Use the standard playback controls to play video files at normal speed or slowed down, paused, speeded up etc. Use the mouse and left click to grab the playback sliding progress indicator to move back and forth through the video.

ffdshow

The ffdshow software is used for audio and video encoding and decoding, especially for MPEG-4 formats. It is free software used on Windows systems and enables the user to tweak media playback and select specific codecs and formats. For use with the IPCamPlayer, the default settings used for ffdshow installation are all that is needed. Expert users can change audio and video codecs as desired with one of the three ffdshow configuration utilities installed along with the codecs. The configuration utilities can be accessed after installation from the ffdshow folder in the Programs folder (Start > Programs > ffdshow >[configuration utility]).

Install ffdshow

1. Insert the CD-ROM into the CD-ROM drive to initiate the auto-run program
2. Click the **ffdshow** install link, and select the desired language in the pop-up dialog window.

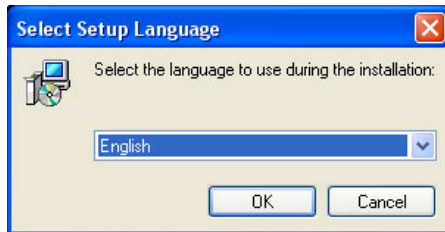

3. The InstallShield Wizard will appear, click **Next** in the welcome screen.



4. Accept the default location (Windows Programs folder) on the system for placement or **Browse** to choose an alternative, Click **Next** to continue.

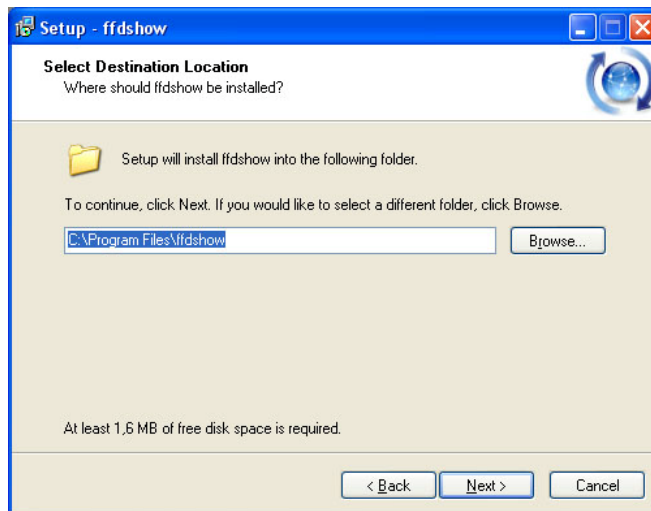

5. Click to check the components that will be installed. For IPCamPlayer it is only necessary to use the default components already selected. Click **Next** to continue.

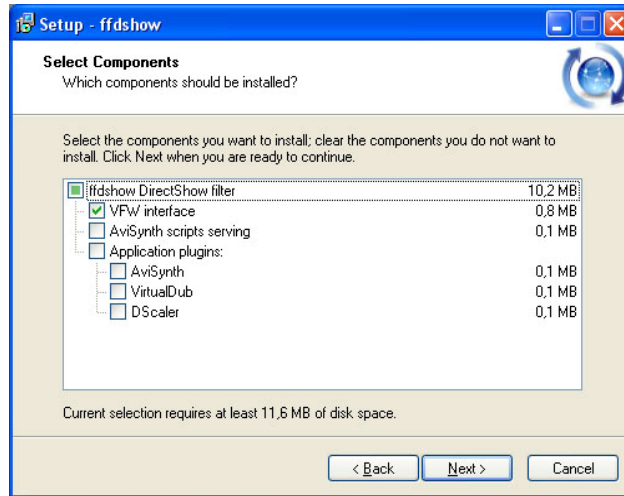

6. Accept the default destination folder (ffdshow) or **Browse** to choose an alternative, Click **Next** to continue.

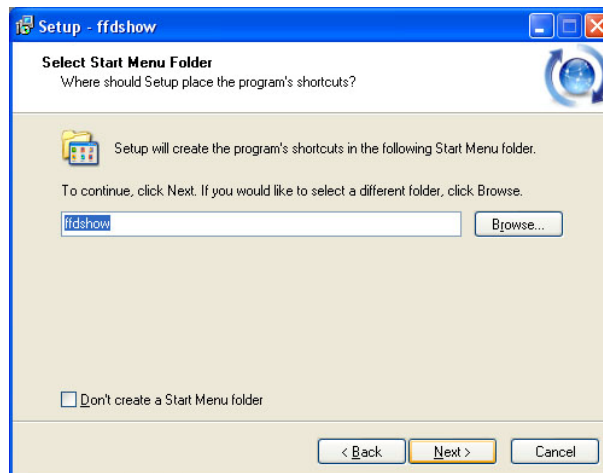

- Click to check the additional tasks that will be installed. For IPCamPlayer it is only necessary to use the default formats already selected. Click **Next** to continue.

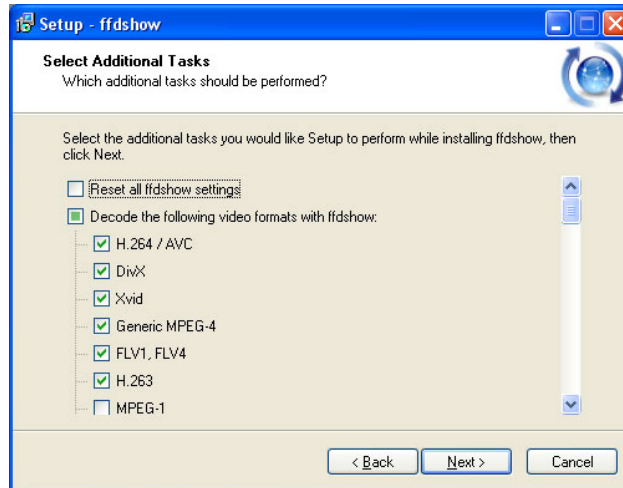

- Click to check the video applications that use ffdshow. For IPCamPlayer it is only necessary to use the default applications already selected. Click **Next** to continue.

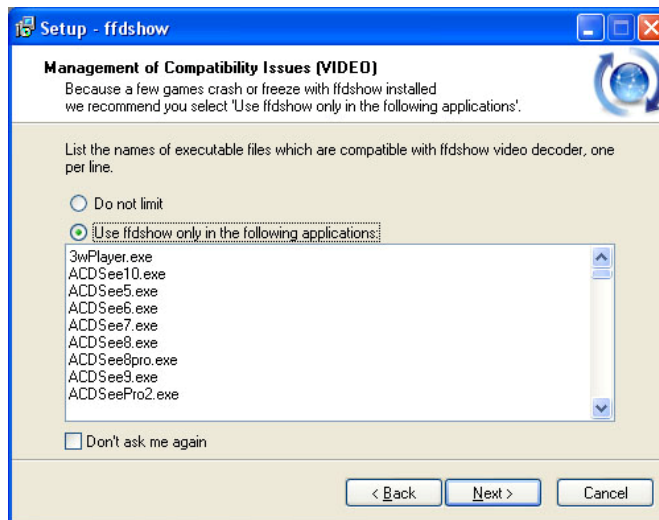

- Click to check the audio applications that use ffdshow. For IPCamPlayer it is only necessary to use the default applications already selected. Click **Next** to continue.

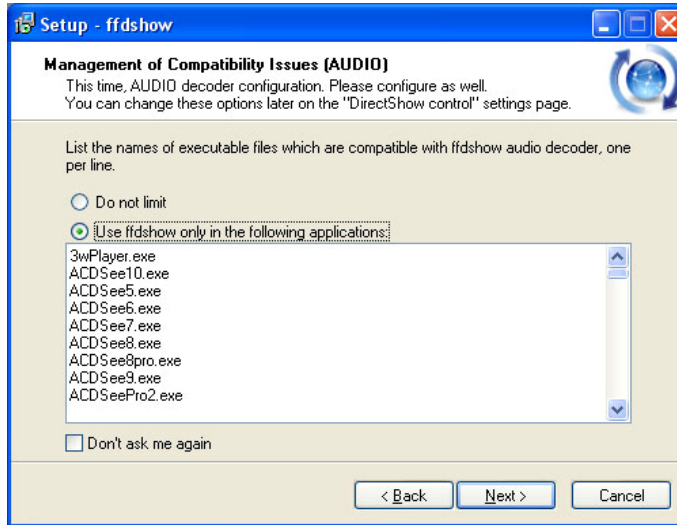

- Choose a speaker setup or choose Disable mixer if unsure. The audio function will work regardless of what speaker setup is chosen. Usually it will choose the default arrangement used on system on which it is being installed. Click **Next** to continue.

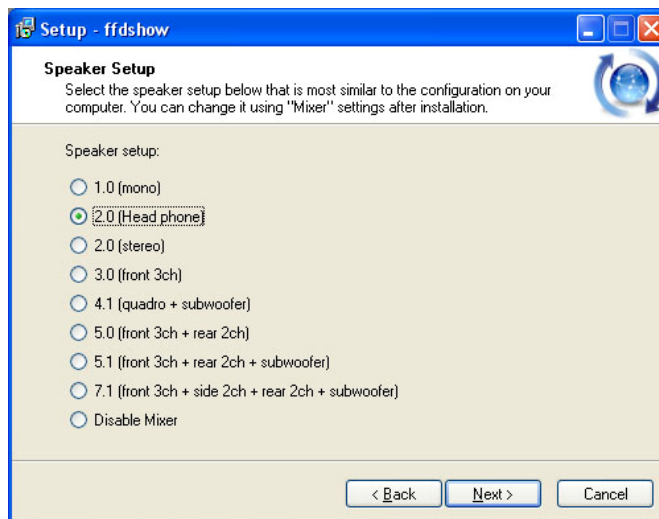

11. Review the information and click **Install** if satisfied that it is correct to install the necessary codecs. The installation will take a few seconds.

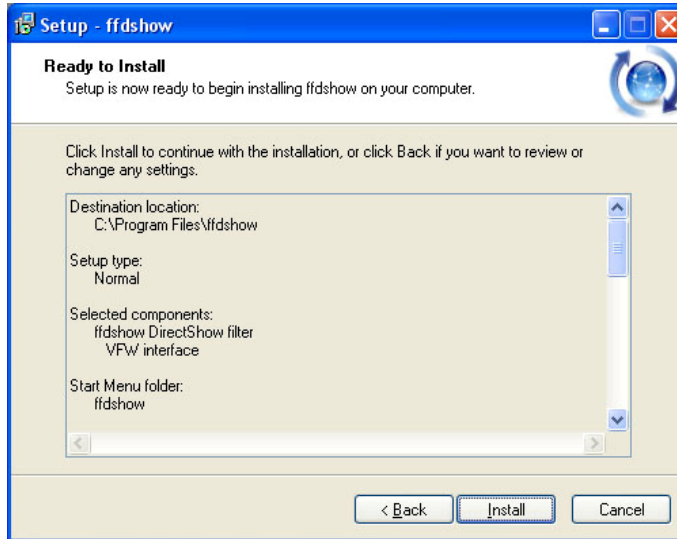

12. If desired, any of the three configuration utilities included with the ffdshow installation can be launched by checking the appropriate box. Click **Finish** to complete the installation.



NOTE: To download the latest copy of ffdshow please check the ffdshow website <http://ffdshow.en.softonic.com/>



Technical Specifications

Camera	
General	Sensor: 1/2.5" color CMOS image sensor Sensor Resolution: 2592(H) x 1944 (V) Lens: 1/2" CS-Mount, replaceable Focal Length: 4mm F/No: F1.4 Sensor Sensitivity: 1.4V/lux-sec (550nm) Minimum illumination: 0.5 lux@F1.4 Focus depth: 70cm ~ infinity View angle: -Horizontal: 55.70 degree (1280x960 mode) 43.21 degree (1280x720 mode) 55.70 degree (640x480 mode) -Vertical: 70.30 degree (1280x960 mode) 70.29 degree (1280x720 mode) 70.30 degree (640x480 mode) -Diagonal: 82.70 degree (1280x960 mode) 77.90 degree (1280x720 mode) 82.70 degree (640x480 mode)
Audio	Built-in omni-directional microphone Sensitivity: -40dB +/- 3dB (5 meters max.) Frequency: 100~10000Hz S/N: >60dB External speaker output (speaker sold separately) Two-way audio with echo canceling Codec: ARM/PCM
Image & Video	Compression: simultaneous H.264 / MPEG-4 / MJPEG Profiles: up to 4 profiles simultaneously Exposure/white balance control: automatic Resolution: 4VGA (1280x960) up to 15fps, HDTV (1280x720) up to 15fps, VGA (640x480) up to 30fps Built-in ICR
I/O Connector	12V DC output (pin 1/2) Input: 2 sets (pin 3/4, pin 5/6) Output: 1 set (pin 7/8) RS-485: 1 set (pin 9/10)
SD slot	Secure Digital card (up to 16G)

TV-IP522P ProView Megapixel Internet Camera

Hardware	
Network	IEEE 802.3u 10/100Mbps Fast Ethernet IEEE 802.3af PoE
LED	Power (green), Link (green)
Reset Button	Reset settings
Power Consumption	PoE input: 9 Watts (max.) DC input: 8 Watts (max.)
Power	12V, 1.5A external power adapter
Dimension	200 x 65 x 55 mm (7.9 x 2.6 x 2.2 in.)
Stand Dimension	128 mm (4.7 in.)
Weight	Camera: 455g (1 lb.) Stand: 116g (4.1 oz.)
Temperature	Operating: 0°C ~ 45°C (32°F ~ 113°F) Storage: -20°C ~ 70°C (-4°F ~ 158°F)
Certifications	CE, FCC
Requirement	
To View Camera	Internet Explorer 6.0 or above
To Run Software	Windows 7 (32/64-bit), Vista (32/64-bit), XP (32/64-bit)
IPView Pro 2.0	Channel: supports up to 32 cameras Record/Playback/Motion Detection/Audio
Network Protocols	IPv4, ARP, TCP, UDP, ICMP DHCP Client, NTP Client, DNS Client, DDNS Client, SMTP Client, FTP Client HTTP Samba Client PPPoE UPnP RTP (Real Time Protocol) RTCP (Real Time Control Protocol) RTSP (Real Time Streaming Protocol)
Management	
Account	Up to 20 user accounts
Remote	Remote management supported
Backup / Restore	Save/retrieve configuration files
Log	System log up to 500 entries
Settings	
Image	Brightness, contrast, noise reduction, saturation, sharpness, white balance, flip, mirror (horizontal/vertical), black/white, day, night, indoor, outdoor mode

TV-IP522P ProView Megapixel Internet Camera

Video	Sensor Output: 4VGA mode <ul style="list-style-type: none">- Encoding type: JPEG / MPEG-4 / H.264- Resolution: 1280 x 960, 640 x 480, 320 x 240- Max frame rate: 15fps- JPEG Quality: Low, Fair, Standard, Good, Excellent Sensor Output: HDTV mode <ul style="list-style-type: none">- Encoding type: JPEG / MPEG4 / H.264- Resolution: 1280 x 720, 640 x 352, 320 x 176- Max frame rate: 15fps- JPEG Quality: Low, Fair, Standard, Good, Excellent Sensor Output: VGA mode <ul style="list-style-type: none">- Encoding type: JPEG / MPEG4 / H.264- Resolution: 640 x 480, 320 x 240, 160 x 120- Max frame rate: 30fps- JPEG Quality: Low, Fair, Standard, Good, Excellent
Recording	Resolutions: multiple profiles Required storage: 32MB (minimum) Recording type: event based (motion detection and digital input trigger), continuous, and scheduled
Snapshot	Trigger event: motion detection or digital input signal Action: send alert email and/or upload to FTP
Port Settings	HTTP port: 80 (default) RTSP port: 554 (default)
Digital Zoom	16x
Dynamic DNS	Yes
Time	Synchronize with NTP server or set time/date manually

I/O Terminal Application

Typically used in association with programming scripts for developing applications for motion detection, event triggering, alarm notification via e-mail, and a variety of external control functions. The 8-pin I/O Terminal Block is located on the rear panel and provides the interface of a photo-coupled switch output and a photo-coupled input.

Connector Pin Assignment

Sign	FUNCTION	SPECIFICATION
12V+	DC12V output(+)	Connect to an IR illuminator or other device in parallel connection. The total output current should be under 200mA
12V-	DC12V output(-)	
In1+	Photo-Relay INPUT (+)	Active High voltage 5~40VDC
In1-	Photo-Relay INPUT (-)	Dropout voltage 0 VDC
In2+	Photo-Relay INPUT (+)	Active High voltage 5~40VDC
In2-	Photo-Relay INPUT (-)	Dropout voltage 0 VDC
O/P+	Photo-Relay Output(common)	Close circuit maximum 120mA(Peak load current)
O/P-	Photo-Relay Output(Normal Opne)	Open circuit voltage maximum 350v(Peak AC)
SA/+	RS-485 (+) or (A)	Compliant to RS-485
SB/-	RS-485 (-) or (B)	

Monitoring and Controlling

By entering http requests in your browser's URL field, you can:

- Monitor the status of digital input.
- Drive the output switch on or off.

Interface Schematic

1. Output device (load) is driven by external power supply.

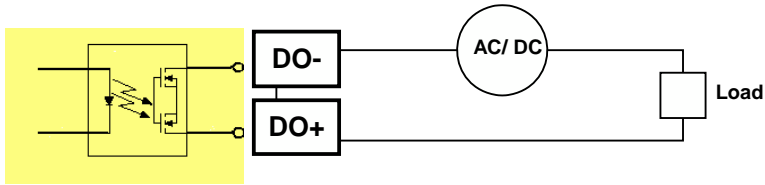

2. Input device (active control device) has independent power supply.

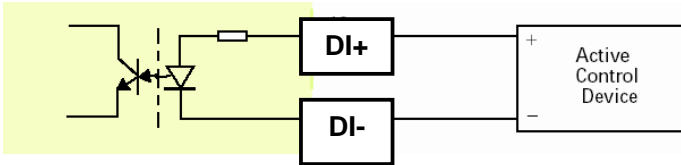

3. RS-485 Interface.

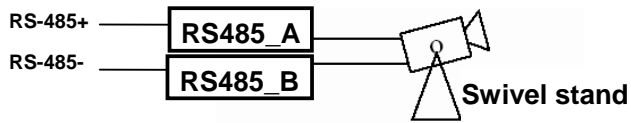

Limited Warranty

TRENDnet warrants its products against defects in material and workmanship, under normal use and service, for the following lengths of time from the date of purchase.

TV-IP522P – 3 Years Warranty

AC/DC Power Adapter, Cooling Fan, and Power Supply carry 1 year warranty.

If a product does not operate as warranted during the applicable warranty period, TRENDnet shall reserve the right, at its expense, to repair or replace the defective product or part and deliver an equivalent product or part to the customer. The repair/replacement unit's warranty continues from the original date of purchase. All products that are replaced become the property of TRENDnet. Replacement products may be new or reconditioned. TRENDnet does not issue refunds or credit. Please contact the point-of-purchase for their return policies.

TRENDnet shall not be responsible for any software, firmware, information, or memory data of customer contained in, stored on, or integrated with any products returned to TRENDnet pursuant to any warranty.

There are no user serviceable parts inside the product. Do not remove or attempt to service the product by any unauthorized service center. This warranty is voided if (i) the product has been modified or repaired by any unauthorized service center, (ii) the product was subject to accident, abuse, or improper use (iii) the product was subject to conditions more severe than those specified in the manual.

Warranty service may be obtained by contacting TRENDnet within the applicable warranty period and providing a copy of the dated proof of the purchase. Upon proper submission of required documentation a Return Material Authorization (RMA) number will be issued. An RMA number is required in order to initiate warranty service support for all TRENDnet products. Products that are sent to TRENDnet for RMA service must have the RMA number marked on the outside of return packages and sent to TRENDnet prepaid, insured and packaged appropriately for safe shipment. Customers shipping from outside of the USA and Canada are responsible for return shipping fees. Customers shipping from outside of the USA are responsible for custom charges, including but not limited to, duty, tax, and other fees.

WARRANTIES EXCLUSIVE: IF THE TRENDNET PRODUCT DOES NOT OPERATE AS WARRANTED ABOVE, THE CUSTOMER'S SOLE REMEDY SHALL BE, AT TRENDNET'S OPTION, REPAIR OR REPLACE. THE FOREGOING WARRANTIES AND REMEDIES ARE EXCLUSIVE AND ARE IN LIEU OF ALL OTHER WARRANTIES, EXPRESSED OR IMPLIED, EITHER IN FACT OR BY OPERATION OF LAW, STATUTORY OR OTHERWISE, INCLUDING WARRANTIES OF MERCHANTABILITY AND FITNESS FOR A PARTICULAR PURPOSE. TRENDNET NEITHER ASSUMES NOR AUTHORIZES ANY OTHER PERSON TO ASSUME FOR IT ANY OTHER LIABILITY IN CONNECTION WITH THE SALE, INSTALLATION MAINTENANCE OR USE OF TRENDNET'S PRODUCTS.

TRENDNET SHALL NOT BE LIABLE UNDER THIS WARRANTY IF ITS TESTING AND EXAMINATION DISCLOSE THAT THE ALLEGED DEFECT IN THE PRODUCT DOES NOT EXIST OR WAS CAUSED BY

CUSTOMER'S OR ANY THIRD PERSON'S MISUSE, NEGLIGENCE, IMPROPER INSTALLATION OR TESTING, UNAUTHORIZED ATTEMPTS TO REPAIR OR MODIFY, OR ANY OTHER CAUSE BEYOND THE RANGE OF THE INTENDED USE, OR BY ACCIDENT, FIRE, LIGHTNING, OR OTHER HAZARD.

LIMITATION OF LIABILITY: TO THE FULL EXTENT ALLOWED BY LAW TRENDNET ALSO EXCLUDES FOR ITSELF AND ITS SUPPLIERS ANY LIABILITY, WHETHER BASED IN CONTRACT OR TORT (INCLUDING NEGLIGENCE), FOR INCIDENTAL, CONSEQUENTIAL, INDIRECT, SPECIAL, OR PUNITIVE DAMAGES OF ANY KIND, OR FOR LOSS OF REVENUE OR PROFITS, LOSS OF BUSINESS, LOSS OF INFORMATION OR DATA, OR OTHER FINANCIAL LOSS ARISING OUT OF OR IN CONNECTION WITH THE SALE, INSTALLATION, MAINTENANCE, USE, PERFORMANCE, FAILURE, OR INTERRUPTION OF THE POSSIBILITY OF SUCH DAMAGES, AND LIMITS ITS LIABILITY TO REPAIR, REPLACEMENT, OR REFUND OF THE PURCHASE PRICE PAID, AT TRENDNET'S OPTION. THIS DISCLAIMER OF LIABILITY FOR DAMAGES WILL NOT BE AFFECTED IF ANY REMEDY PROVIDED HEREIN SHALL FAIL OF ITS ESSENTIAL PURPOSE.

Governing Law: This Limited Warranty shall be governed by the laws of the state of California.

Some TRENDnet products include software code written by third party developers. These codes are subject to the GNU General Public License ("GPL") or GNU Lesser General Public License ("LGPL").

Go to <http://www.trendnet.com/gpl> or <http://www.trendnet.com> Download section and look for the desired TRENDnet product to access to the GPL Code or LGPL Code. These codes are distributed WITHOUT WARRANTY and are subject to the copyrights of the developers. TRENDnet does not provide technical support for these codes. Please go to <http://www.gnu.org/licenses/gpl.txt> or <http://www.gnu.org/licenses/lgpl.txt> for specific terms of each license.

Warranty:

FCC:

Federal Communication Commission Interference Statement

This equipment has been tested and found to comply with the limits for a Class B digital device, pursuant to Part 15 of the FCC Rules. These limits are designed to provide reasonable protection against harmful interference in a residential installation. This equipment generates, uses and can radiate radio frequency energy and, if not installed and used in accordance with the instructions, may cause harmful interference to radio communications. However, there is no guarantee that interference will not occur in a particular installation. If this equipment does cause harmful interference to radio or television reception, which can be determined by turning the equipment off and on, the user is encouraged to try to correct the interference by one of the following measures:

- Reorient or relocate the receiving antenna.
- Increase the separation between the equipment and receiver.
- Connect the equipment into an outlet on a circuit different from that to which the receiver is connected.
- Consult the dealer or an experienced radio/TV technician for help.

This device complies with Part 15 of the FCC Rules. Operation is subject to the following two conditions: (1) This device may not cause harmful interference, and (2) this device must accept any interference received, including interference that may cause undesired operation.

TV-IP522P ProView Megapixel Internet Camera

The user's manual or instruction manual for an intentional or unintentional radiator shall caution the user that changes or modifications not expressly approved by the party responsible for compliance could void the user's authority to operate the equipment. In cases where the manual is provided only in a form other than paper, such as on a computer disk or over the Internet, the information required by this section may be included in the manual in that alternative form, provided the user can reasonably be expected to have the capability to access information in that form.



TRENDnet[®]

Product Warranty Registration

Please take a moment to register your product online.
Go to TRENDnet's website at <http://www.trendnet.com/register>

Free Manuals Download Website

<http://myh66.com>

<http://usermanuals.us>

<http://www.somanuals.com>

<http://www.4manuals.cc>

<http://www.manual-lib.com>

<http://www.404manual.com>

<http://www.luxmanual.com>

<http://aubethermostatmanual.com>

Golf course search by state

<http://golfingnear.com>

Email search by domain

<http://emailbydomain.com>

Auto manuals search

<http://auto.somanuals.com>

TV manuals search

<http://tv.somanuals.com>