



4" Field Monitor



5.6" Field Monitor



6.4" Monitor

For 19" Rack Mount Units see pages 10, 11, 12, 13, 14, 15, 17, 20, 21, 23, 24, 25, 27, 28, 30.



47" HD w/ Video & RGB

TOTE VISION®

The Leader in LCD Monitors

For Behind-the-mirror TVs see pages 5, 7, 8, 10, 13-15, 17, 19, 21, 23-25, 27, 28.



32" HD w/ Video & RGB

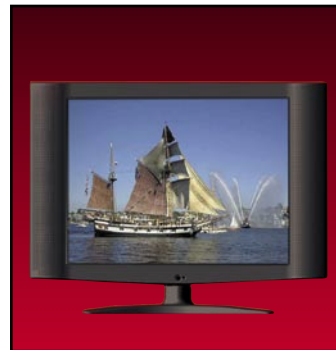

20" w/ Video & RGB



8" Monitor



7" HD Monitor

For Field Monitors see pages 22, 23, 26 and 29.



15.4" HD w/ Video & RGB

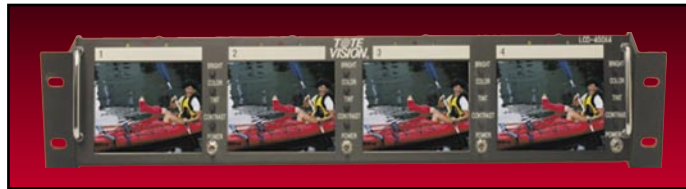

4" Monitor, 90° tilting, Quad Rack Mount Unit



10.4" TV



7" HD Monitor Dual Rack Mount Unit

For Sunlight Readable monitors see pages 9 and 18.

LCD-4700HD

with
RS-232 and
HDMI & DVI

The Biggest Thing in LCD HD Monitors



Active Matrix 47" Color LCD HD Monitor

• True HD displays 1080p/i without down scaling.
(also supports 480p/i, 576p/i, 720p)

• RS-232 feature allows external devices to
control the monitor through the serial port.

• PIP: Picture in picture capability

- 2 built-in speakers provide 3D MTS stereo and superior listening pleasure.
- SRS technology provides surround sound experience.
- Environmental protection includes power-saving capabilities, and the unit emits no x-radiation.
- Absence of video oscillations and user selection of color temperature (9300°, 7500°, 6500°) provides enhanced viewing pleasure.
- Hard anti-glare coating enhances viewing pleasure.
- Composite, S-Video, component, HDMI, DVI, and PC capability
- Top controls for channel up/down, volume up/down, source, menu
- Case made of durable plastic (black color)
- Active matrix technology allows wide viewing angle
- Active matrix technology eliminates distortion
- Built-in removable desk stand included
- Includes built-in power supply 100~200 VAC.
- Wireless remote control works within 30 feet.
- Widescreen 16:9 aspect ratio, 4:3, zoom

Optional Accessories

- WM-4700VT Heavy duty dual arm mount for LCD-4700HD, 200 lbs. limit, 4-way adjustable
- WM-3742 Fixed wall mount bracket



WM-3742

Resolution: 1920 (H) x 1080 (V) dots

Brightness rating: 550 cd/m² (Nit)

Contrast Ratio: 1600:1

Display: 47.0" TFT LCD active matrix

Back Light: Built-in (24 CCFT)

Input Signal: Composite NTSC/PAL, S-Video, component, analog RGB, HDMI, DVI

PC compatibility: IBM compatible

Dot Pitch: 0.5415(V) x 0.5415(H)mm

Colors: 16.7M

Number of Pixels: 2,073,600

Response Time: 8/8mS (rising/falling)

Audio output: 10W x 2

Speakers (separate): 10W + 10W

Viewing angle L/R/T/B: 89/89/89/89 degrees

Pixel Configuration: Stripe

Input Signal Level: 1.0V P-P (positive) 75 Ohm

Dimensions (WHD): 1165 x 870 x 340mm / 45.9" x 34.3" x 13.4"

Dimension w/o deskstand 1165 x 830 x 130mm / 45.9" x 32.7" x 5.1"

Actual visible screen size (WH): 1018 x 572mm / 42.6" x 22.5"

Operating temperature/humidity: 50 ~ 104°F / 10 ~ 40°C, 20% ~ 90% humidity

Power Requirements: 100 ~ 240 VAC, 50/60 Hz

Power Consumption: 236 W (max)

Rear Terminal Connections: [RCA video IN and RCA R/L IN audio jack] x 2

S-Video IN jack x 2, [RCA Y/Pb/Pr inputs & R/L audio inputs],

[RCA Y/Cb/Cr & R/L audio inputs]

RCA audio R & L output, PC audio IN jack,

15-pin D-sub, AC IN, 9-pin RS-232,

HDMI, DVI

Net Weight: 80.9 lbs. w/o desk stand

Gross Weight: 100.4 lbs.

1319 Dexter Ave. N • Ste. 020 • WA 98109

Tel: 206-623-6000 • FAX: 206-623-6609

E-mail: sales@totevision.com

http://www.totevision.com

**TOTE
VISION**

LCD-4200HD LCD-4000HD



with
RS-232 and
HDMI & DVI

The Biggest Thing in LCD HD Monitors

Active Matrix 42" and 40" Color LCD HDTV Monitor

• True HD displays 1080p/i without down scaling
(also supports 480p/i, 567p/i, 720p)

• RS-232 feature allows external devices to
control the monitor through the serial port.

- PIP: Picture in picture capability
- 2 rear speakers provide 3D MTS stereo and superior listening pleasure.
- SRS technology provides surround sound experience.
- Environmental protection includes power-saving capabilities, and the unit emits no x-radiation.
- Absence of video oscillations and user selection of color temperature (9300°, 7500°, 6500°) provides enhanced viewing pleasure.
- Hard anti-glare coating enhances viewing pleasure.
- Composite, S-Video, component, HDMI, DVI and PC capability
- Top controls for volume up/down, source, menu
- Case made of durable plastic (black color)
- Active matrix technology allows wide viewing angle
- Active matrix technology eliminates distortion
- Built-in removable desk stand included
- Includes built-in power supply 100~200 VAC.
- Wireless remote control works within 30 feet.
- Widescreen 16:9 aspect ratio, 4:3, zoom

Optional Accessories

- | | |
|-----------|---|
| PLT-3742 | VESA conversion plate for landscape or portrait |
| WM-3742VT | Fixed wall mount bracket |
| WM-4200VT | 4-way pan/tilt wall mount bracket (order w/ PLT-3742) |
| WMC-2342 | Ceiling mount bracket (order w/ PLT-3742) |



WM-3742



WM-4200VT

Resolution: 1920 (H) x 1080 (V) dots
Brightness rating: 500 cd/m² (Nit)
Contrast Ratio: 1000:1

- Display: LCD-4200HD: 42.0" TFT LCD active matrix
LCD-4000HD: 40.0" TFT LCD active matrix
- Back Light: Built-in (16 CCFT)
- Input Signal: Composite NTSC/PAL, S-Video, component, analog RGB, HDMI, DVI
- PC compatibility: IBM compatible
- Dot Pitch: 0.681(V) x 0.227(H)mm
- Colors: 16.7M
- Number of Pixels: 1,049,088
- Response Time:(rising/falling) : LCD-4200HD: 16/16mS, LCD-4000HD: 10/6mS
- Audio output: 8W x 2
- Speakers: 8W + 8W
- Viewing angle L/R/T/B: 85/85/85/85 degrees
- Pixel Configuration: Stripe
- Input Signal Level: 1.0V P-P (positive) 75 Ohm
- Dimensions (WHD): LCD-4200HD: 1038 x 698 x 254mm / 40.9" x 27.5" x 10"
LCD-4000HD: 1038 x 698 x 254mm / 40.9" x 27.5" x 10"
- Dimensions w/o deskstand (WHD): LCD-4200HD: 1038 x 639 x 90mm / 40.9" x 25.2" x 3.5"
LCD-4000HD: 1038 x 639 x 90mm / 40.9" x 25.2" x 3.5"
- Actual visible screen size (WH): LCD-4200HD: 914 x 520mm / 36" x 20.5"
LCD-4000HD: 885.6 x 498mm / 34.9" x 19.6"
- Operating temperature/humidity: 32 ~ 140°F / 0 ~ 60°C, 20% ~ 90% humidity
- Power Requirements: 90 ~ 240 VAC / 50 ~ 60 Hz
- Power Consumption: 360 W (max)
- Rear Terminal Connections: [RCA video IN and RCA R/L IN audio jack] x 2
S-Video IN jack x 2, [RCA Y/Pb/Pr inputs & R/L audio inputs], [RCA Y/Cb/Cr & R/L audio inputs]
RCA audio R & L output, PC audio IN jack, 15-pin D-sub, AC IN, 9-pin RS-232, HDMI, DVI
- Net Weight: 31.6 kg. / 70 lbs.
- Net Weight w/o desk stand: 24 kg. / 53 lbs.
- Gross Weight: 42.6 kg. / 94 lbs.

1319 Dexter Ave. N • Ste. 020 • WA 98109
Tel: 206-623-6000 • FAX: 206-623-6609

E-mail: sales@totevision.com
http://www.totevision.com



LCD-3700HD

with
RS-232 and
HDMI & DVI

The Biggest Thing in LCD HD Monitors



Active Matrix 37" Color LCD HD Monitor

• True HD displays 1080p without down scaling.
(also supports 480p/i, 576p/i, 720p, 1080i/p)

• RS-232 feature allows external devices to
control the monitor through the serial port.

- PIP: Picture in picture capability
- 2 external speakers provide 3D MTS stereo and superior listening pleasure.
- SRS technology provides surround sound experience.
- Environmental protection includes power-saving capabilities, and the unit emits no x-radiation.
- Absence of video oscillations and user selection of color temperature (9300°, 7500°, 6500°) provides enhanced viewing pleasure.
- Hard anti-glare coating enhances viewing pleasure.
- Composite, S-Video, component, HDMI, DVI, and PC capability
- Top controls for volume up/down, source, menu
- Case made of durable plastic (black color)
- Active matrix technology allows wide viewing angle
- Active matrix technology eliminates distortion
- Built-in removable desk stand included
- Includes built-in power supply 100~200 VAC.
- Wireless remote control works within 30 feet.
- Widescreen 16:9 aspect ratio, 4:3, zoom

Optional Accessories

| | |
|-----------|---|
| PLT-3742 | VESA conversion plate for landscape or portrait |
| WM-3742VT | Fixed wall mount bracket |
| WM-4200VT | 4-way pan/tilt wall mount bracket (order w/ PLT-3742) |
| WMC-2342 | Ceiling mount bracket (order w/ PLT-3742) |



WM-3742

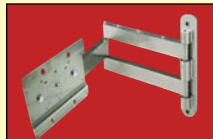

WM-4200VT

Resolution: 1920(H) x 1080 (V) dots
Brightness rating: 550 cd/m² (Nit)

Contrast Ratio: 800:1

Display: 37.0" TFT LCD active matrix
Back Light: Built-in (16 CCFT)
Input Signal: Composite NTSC/PAL, S-Video,
component, analog RGB, HDMI, DVI

PC compatibility: IBM compatible

Dot Pitch: 0.427(V) x 0.427(H)mm

Colors: 16.7M

Number of Pixels: 2,073,600

Response Time: 15/6mS (rising/falling)

Audio output: 8W x 2

Speakers: 8W + 8W

Viewing angle L/R/T/B: 85/85/85/85 degrees

Pixel Configuration: Stripe

Input Signal Level: 1.0V P-P (positive) 75 Ohm

Dimensions w/ speakers & deskstand (WHD): 1093 x 623 x 230mm / 43" x 24.5" x 9.1"

Dimensions w/o speakers & deskstand (WHD): 943 x 583 x 107mm / 37.1" x 23" x 4.2"

Package dimensions: 1063 x 730 x 300mm / 41.9" x 28.7" x 11.8"

Actual visible screen size (WH): 819 x 460mm / 32.2" x 18.1"

Operating temperature/humidity: 50 ~ 104°F / 10 ~ 40°C, 20% ~ 90% humidity

Power Requirements: 100 ~ 240 VAC / 50 ~ 60 Hz

Power Consumption: 170 W (max.)

Rear Terminal Connections: [RCA video IN and RCA R/L IN audio jack] x 2
S-Video IN jack x 2, [RCA Y/Pb/Pr inputs & R/L audio inputs],
[RCA Y/Cb/Cr & R/L audio inputs]
RCA audio R & L output, PC audio IN jack,
15-pin D-sub, AC IN, 9-pin RS-232,
HDMI, DVI

Net Weight: 21.63 kg. / 47.5 lbs.

Gross Weight: 26.5 kg. / 58.4 lbs.

1319 Dexter Ave. N • Ste. 020 • WA 98109

Tel: 206-623-6000 • FAX: 206-623-6609

E-mail: sales@totevision.com

http://www.totevision.com

**TOTE
VISION**

The Biggest Thing in HD LCD Monitors

LCD-3200HD LCD-3200HDL LCD-2600HD

with
RS-232 and
HDMI & DVI



LCD-3200HD

Shown without detachable speakers.



LCD-2600HD

Active Matrix 32" and 26" LCD HD Monitors

• **HD compatible (supports 480p/i, 720p, 1080i)**

• **RS-232 feature allows external devices to control the monitor through the serial port.**

- PIP: Picture in picture capability
- Widescreen 16:9 aspect ratio, 4:3, zoom
- LCD-3200HD: 2 detachable speakers provide 3D MTS stereo and superior listening pleasure.
LCD-2600HD: 2 built-in 10W speakers provide 3D MTS stereo and superior listening pleasure
- Environmental protection includes power-saving capabilities, and the unit emits no x-ray radiation
- Absence of video oscillations and anti-reflective hard coating provides enhanced viewing pleasure
- Composite, S-Video, component, DVI, PC
- Case made of durable plastic (black color)
- Built-in removable desk stand included
- Wireless remote control works within 30 ft.
- 3-comb filter
- LCD-3200HD: Response time: 12/12ms (rising/falling)
LCD-2600HD: Response time: 15/5ms (rising/falling)

Optional Accessories

| | |
|-----------|--|
| PLT-2300 | VESA conversion plate (for landscape & portrait positioning) |
| WM-3018VT | Fixed wall mount bracket |
| WM-4200VT | 4-way pan/tilt wall mount bracket (order w/ PLT-2300) |
| WMC-2342 | Ceiling mount (order w/ PLT-2300) |

**For unit in flush mount kit order
model LCD-3200HDL.**

Dimensions (WH): 33-3/8" x 21-3/8"

Distance between horizontal mounting holes: 32-3/8"

Resolution: 1366 (H) x 768 (V) dots
Brightness rating: 500 cd/m² (Nit)
Contrast Ratio: 800:1

Display: LCD-3200HD: 32.0" TFT LCD active matrix
LCD-2600HD: 26.0" TFT LCD active matrix

Input Signal: Composite NTSC/PAL, S-Video,
analog RGB, component, HDMI, DVI

PC compatibility: IBM compatible

Colors: 16.7M

Viewing angle L/R/T/B: 85/85/85/85 degrees

Number of Pixels: 983,040

LCD-3200HD: Dimensions (WHD): 1026 x 536 x 231mm / 40.4" x 21.1" x 9.1"

LCD-2600HD: Dimensions (WHD): 804 x 536 x 230mm / 31.6" x 21.1" x 9.1"

LCD-3200HD: Dimensions w/o speakers & deskstand (WHD): 804 x 496 x 120mm / 31.7" x 19.5" x 4.7"

LCD-2600HD: Dimensions w/o deskstand (WHD): 804 x 496 x 120mm / 31.7" x 19.5" x 4.7"

Actual visible screen size (WH): LCD-3200HD: 988 x 406mm / 38.9" x 16"

LCD-2600HD: 567 x 340mm / 22.3" x 13.4"

Operating temperature/humidity: 50 ~ 104°F / 10 ~ 40°C, 20% ~ 90% humidity

Power Requirements: 12VDC, 10.5A

Power Consumption: 130W (max.)

Rear Terminal Connections: [RCA video IN and RCA R/L IN audio jack] x 2

S-Video IN jack x 2,

[RCA Y/Pb/Pr inputs & R/L audio inputs],

[RCA Y/Cb/Cr & R/L audio inputs]

RCA audio R & L output, PC audio IN jack,

15-pin D-sub, AC IN, 9-pin RS-232,

HDMI, DVI

LCD-3200HD: Weight: Net: 16 kg./ 35 lbs. Gross: 24 kg./ 52 lbs.

LCD-2600HD: Weight: Net: 15.1 kg./ 33 lbs. Gross: 19 kg./ 42 lbs.

1319 Dexter Ave. N • Ste. 020 • WA 98109
Tel: 206-623-6000 • FAX: 206-623-6609

E-mail: sales@totevision.com
http://www.totevision.com

**TOTE
VISION**

LCD-2300HD

with
RS-232 and
HDMI & DVI



Active Matrix 23" Color LCD HD Monitor

• **HD compatible (supports 480p/i, 720p, 1080i)**

• **RS-232 feature allows external devices to control the monitor through the serial port.**

- PIP: Picture in picture capability
- 2 built-in speakers provide 3D MTS stereo and superior listening pleasure.
- Environmental protection includes power-saving capabilities, and the unit emits no x-ray radiation.
- Absence of video oscillations and anti-reflective hard coating provides enhanced viewing pleasure.
- Composite, S-Video, component, DVI, RS-232, and PC capability
- Case made of durable plastic (silver color)
- Active matrix technology allows wide viewing angle
- Active matrix technology eliminates distortion
- Built-in removable desk stand included
- Includes switching power supply 100-240VAC, 50/60 Hz
- Closed-caption and V-chip features
- Wireless remote control works within 30 feet.
- Widescreen 16:9 aspect ratio, 4:3, zoom
- 3D-comb filter
- Response time: 15/10ms (rising/falling)

Optional Accessories

- | | |
|-----------|---|
| PLT-2300 | VESA conversion plate (for landscape & portrait) |
| WM-3018VT | Fixed wall mount bracket |
| WM-4200VT | 4-way pan/tilt wall mount bracket (order w/ PLT-2300) |
| WMC-2342 | Ceiling mount (order w/ PLT-2300) |



WM-3018VT

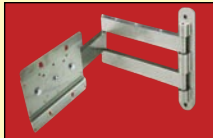

WM-4200VT

Resolution: 1366 (H) x 768 (V) dots

Brightness rating: 500 cd/m² (Nit)

Contrast Ratio: 400:1

Display: 23.0" TFT LCD active matrix

Back Light: Built-in (12 CCFT)

Input Signal: Composite NTSC/PAL, S-Video component, analog RGB, HDMI, DVI
Has digital RGB

C compatibility: IBM compatible

Dot Pitch: 0.39(V) x 0.39(H)mm

Colors: 16.7M

Contrast Ratio: 400:1

Number of Pixels: 983,040

Response Time: 15/10ms

Audio output: 10W x 2

Speakers: 10W + 10W

Viewing angle L/R/T/B: 85/85/85/85 degrees

Pixel Configuration: Stripe

Input Signal Level: 1.0V P-P (positive) 75 Ohm

Dimensions (WHD): 720 x 475 x 240mm / 28.3" x 18.7" x 9.4"

Dimensions w/o deskstand (WHD): 720 x 413 x 81mm / 28.3" x 16.3" x 3.2"

Actual visible screen size (WH): 499 x 299mm / 19.6" x 11.8"

Operating temperature/humidity: 50 ~ 104°F / 10 ~ 40°C, 20% ~ 90% humidity

Power Requirements: 12VDC, 10A

Power Consumption: 120 W (max)

Rear Terminal Connections: [RCA video IN and RCA R/L IN audio jack] x 2
S-Video IN jack x 2, [RCA Y/Pb/Pr inputs & R/L audio inputs],
[RCA Y/Cb/Cr & R/L audio inputs]
RCA audio R & L output, PC audio IN jack,
15-pin D-sub, AC IN, 9-pin RS-232,
HDMI, DVI

Net Weight: 11.58 kg. / 25.5 lbs.

Gross Weight: 14.56 kg. / 32.8 lbs.

1319 Dexter Ave. N • Ste. 020 • WA 98109

Tel: 206-623-6000 • FAX: 206-623-6609

E-mail: sales@totevision.com

http://www.totevision.com

**TOTE
VISION®**

The Biggest Thing in Big LCD Monitors

LCD-2007HD LCD-2007HDL LCD-2007HDT LCD-2007HDTL

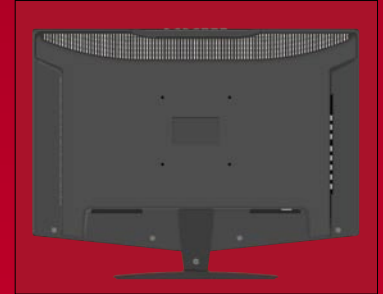
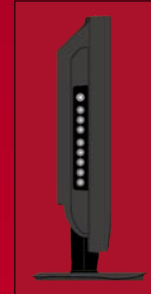

Active Matrix 20" Color LCD Monitor

• HD compatible (supports 480p/i, 576p/i, 720p, 1080i)

- Component input capability provides superior viewing pleasure
- Aspect ratio: 16:9
- Anti-glare hard coating covers glass surface
- Zoom function
- Wireless remote control
- Dual built-in front speakers for easy listening
- For color and B&W applications
- Low power consumption
- Case made of durable black ABS plastic
- Active matrix technology allows wide viewing angle
- Active matrix technology eliminates distortion
- Switching power supply (AC 90~240V, 50 ~ 60Hz) included
- Built-in removable desk stand included
- Built-in interface and proper cable exiting for wall or arm mounting VESA 100mm FPMPMI compliant
- Response Time: 8ms/8ms (rising/falling)

Perfect for behind-the-mirror applications. Order LCD-2007HDTL
Available 1Q08 with ATSC/NTSC/QAM tuner

Optional Accessories

- HM-400 Under-cabinet hinge mount (shown below)
- WM-31 Wall mount bracket (fixed)
- WM-302 Wall mount with swing arm & 4-way (shown below)
- WMC-1720 Ceiling mount

Resolution: 1366 (H) x 768 (V) dots
Brightness rating: 450 cd/m² (Nit)
Contrast Ratio: 700:1

Display: 20" TFT LCD active matrix
Back Light: Built-in CCFTs
Input Signal: Composite NTSC/PAL (auto sensing for video)
S-Video, component,
Analog RGB
LCD-2700HDT: RF TV Tuner: Cable ready (ATSC/NTSC/QAM), channels 1-125 (Available 4Q07)
Colors: 16.7 M
Number of Pixels: 480,000 dots
Viewing angle L/R/T/B: 80/80/70/70 degrees
Pixel Configuration: Stripe
Video Input Level: 1.0V p-p at 75 Ohm
Audio Input: 400 ± 50mV (rms) at 1 KHz Stereo
Audio Output: 1V P-P
Built-in Speakers: 3 W/ channel x 2
Dimensions w/ desk stand (WHD): 554.8 x 433 x 160mm / 21.8" x 17" x 6.3"
Dimensions w/o desk stand (WHD): 554.8 x 401 x 80mm / 21.8" x 15" x 2.75"
Actual visible screen size (WH): 408 x 306mm / 16" x 12"
Operating temperature: 50 ~ 104°F or 10 ~ 40°C
Storage temperature: -4 ~ 140°F or -20 ~ 60°C
Power Requirement: 100 ~ 240VAC, 50/60Hz, 12 VDC, 7A, negative ground
Power Consumption: 80 W (max)
Connectors: RCA A/V IN jacks, S-Video
RCA YPbPr inputs and RCA R/L audio inputs
15-pin D-sub, PC audio IN
Threaded "F" connector for LCD-2007HDT
2.1mm DC IN jack
Net weight: 5 kg. / 11 lbs.
Gross weight: 6.4 kg. / 14 lbs.

Specifications subject to change without notice

©2008 ToteVision

60K

Available through:

The Biggest Thing in Big LCD Monitors

LCD-2003 LCD-2002V LCD-2002VL

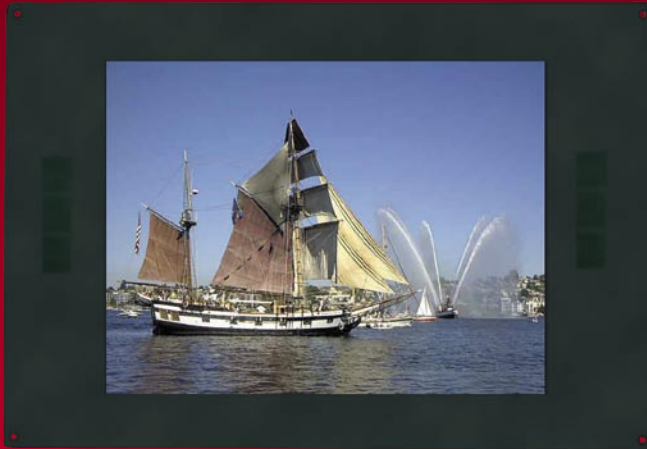

Unit in Flush Mount Kit



Side View

Active Matrix 20.1" Color LCD Monitor

- Hot key and remote control allow toggling between video input signals
- Component input capability provides superior viewing pleasure
- Aspect ratio: 4:3
- Anti-glare hard coating covers glass surface
- Zoom function
- Wireless remote control
- Handle (removeable) for easy portability
- Dual built-in front speakers for easy listening
- For color and B&W applications
- Low power consumption
- Case made of durable black ABS plastic
- Active matrix technology allows wide viewing angle
- Active matrix technology eliminates distortion
- Switching power supply (AC 90~240V, 50 ~ 60Hz) included
- Built-in removable desk stand included
- Built-in interface and proper cable exiting for wall or arm mounting VESA 100mm FPMPMI compliant
- Response Time: 16ms/16ms (rising/falling)

LCD-2002VL Flush Mount Unit (shown above)

Dimensions (WHD): 24" x 16.5" x 2.75"
 Installer's Cut-Out (WH): 21.75" x 15"
 Weight: 26 lbs.

Optional Accessories

- HM-400 Under-cabinet hinge mount (shown below)
- WM-31 Wall mount bracket (fixed)
- WM-302 Wall mount with swing arm & 4-way (shown below)
- WMC-1720 Ceiling mount



HM-400



WM-302

- Display: 20.1" TFT LCD active matrix
- Back Light: 4 Built-in CCFTs
- Input Signal: Composite NTSC/PAL (auto sensing for video)
S-Video, component,
Analog RGB (only for LCD-2002V/VL)
- Resolution: 800(H) x 600(V) dots @ 75 Hz
- Brightness rating: 500 cd/m² (Nit)
- Colors: 16.7 M
- Number of Pixels: 480,000 dots
- Contrast Ratio: 500:1
- Viewing angle L/R/T/B: 80/80/60/60
- Pixel Configuration: Stripe
- Video Input Level: 1.0V p-p at 75 Ohm
- Audio Input: 400 ± 50mV (rms) at 1 KHz Stereo
- Audio Output: 1V P-P
- Built-in Speakers: 3 W/ channel x 2
- Dimensions w/ desk stand (WHD): 554.8 x 433 x 160mm / 21.8" x 17" x 6.3"
- Dimensions w/o desk stand (WHD): 554.8 x 401 x 80mm / 21.8" x 15" x 2.75"
- Actual visible screen size (WH): 408 x 306mm / 16" x 12"
- Operating temperature: 50 ~ 104°F or 10 ~ 40°C
- Storage temperature: -4 ~ 140°F or -20 ~ 60°C
- Power Requirement: 100 ~ 240VAC, 50/60Hz, 12 VDC, 7A, negative ground
- Power Consumption: 80 W (max)
- LCD-2002V: Rear Down-facing Connectors: 9-pin component IN jack,
RCA A/V IN jacks,
S-VHS 4-Pin Mini Din IN jack,
Audio OUT 3.5 stereo headphone jack,
2.1mm DC IN jack
24-pin DVI-D (cable for PC connection included) ,
- LCD-2003: Rear Down-facing Connectors: 9-pin component IN jack,
RCA A/V IN jacks,
BNC composite IN/OUT
S-VHS 4-Pin Mini Din IN jack,
Audio OUT 3.5 stereo headphone jack,
2.1mm DC IN jack
- Net weight: 5 kg. / 11 lbs.
- Gross weight: 6.4 kg. / 14 lbs.

Specifications subject to change without notice ©2008 ToteVision 60K

Available through:

The Biggest Thing in Sunlight Readable LCD Monitors

LCD-2001VB LCD-1701VB LCD-1500VB

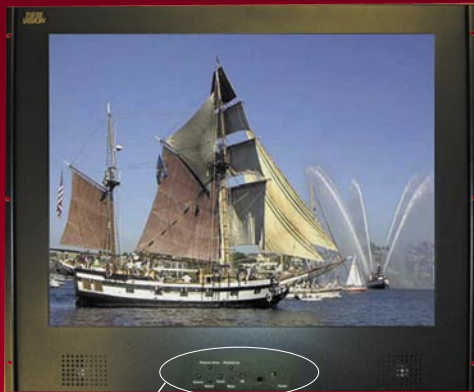

LCD-2001VB
20" in Metal Housing



LCD-1701VB
17" in Metal Housing



LCD-1500VB
15" in Metal Housing

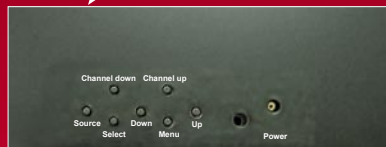

Front button controls
on LCD-2001VB

Active Matrix 20", 17", and 15" Color LCD Monitors

- **Ultra-bright technology provides sunlight reability**
- **PIP: Picture in picture capability**
- Wireless remote control allows easy access for monitor adjustment
- 4-stage brightness control
- Built-in ambient light sensor
- Built-in fan provides cooling
- On-screen display for: brightness, contrast, back light, hue, volume
- Component, composite, S-Video, & PC capability
- Slim space saving design
- For color and B&W applications
- Low power consumption
- LCD-2001VB, LCD-1701VB, and LCD-1500VB case made of black durable steel
- Active matrix technology allows wide viewing angle
- Active matrix technology eliminates distortion
- Includes switching power supply 90-240V, 12V, 100W
- VESA 100mm FPMPI compliant for LCD-1701VB and LCD-2001VB
VESA 75mm FPMPI compliant for LCD-1500VB.
- LCD-2001VB and LCD-1701VB come with built-in speakers for audio enjoyment
- Response Time, LCD-2001VB: 6ms/16ms (rising/falling)
Response Time, LCD-1701VB: 15ms/35ms (rising/falling)
Response Time, LCD-1500VB: 25ms/25ms (rising/falling)

Display: LCD-2001VB: 20.0" TFT LCD active matrix
LCD-1701VB: 17.0" TFT LCD active matrix
LCD-1500VB: 15.0" TFT LCD active matrix

Input Signal: Composite NTSC/PAL, S-Video, analog RGB

Resolution: LCD-2001VB: 800(H) x 600(V)
LCD-1701VB: 1280(H) x 1024(V)
LCD-1500VB: 1024 (V) x 768 (V)

Brightness / Contrast: LCD-2001VB: 1000 Nit / 500:1
LCD-1701VB: 1300 Nit / 300:1
LCD-1500VB: 1800 Nit / 350:1

Viewing angle L/R/T/B: 80/80/80/80

Speakers: LCD-2001VB: front, 8 ohms, 5 W
LCD-1701VB: rear, 8 ohms, 1 W, 28 x 40mm oval type (x2)

Dimensions (WHD): LCD-2001VB: 506 x 414 x 62mm / 20" x 16.3" x 2.4"
LCD-1701VB: 430 x 360 x 70mm / 16.9" x 14.2" x 2.8"
LCD-1500VB - Front: 14-7/8" x 11-5/8" x 2-1/2"
Back: 14-3/16" x 11" x 2-1/2"

Actual visible screen size (WH): LCD-2001VB: 408 x 306mm / 16.1" x 12"
LCD-1701VB: 337 x 270mm / 13.3" x 10.6"
LCD-1500VB: 304 x 288mm / 11.9" x 8.2"

Rear Terminal Connections: LCD-2001VB/1701VB/1500VB: BNC video IN/OUTjacks,
15-pin D-sub (female), S-Video, 4-pin DC IN jack,
9-pin component IN jack

Weight: LCD-2001VB: Net: 8.1 kg. / 17.8 lbs. Gross: 12.6 kg. / 27.8 lbs.
LCD-1701VB: Net: 8 kg. / 17.6 lbs. Gross: 8.6 kg. / 19 lbs.
LCD-1500VB: Net: 6 kg. / 13.2 lbs. Gross: 7.3 kg. / 16 lbs.

Optional Accessories

DC-1600 Factory approved car cord
HM-400 Under-cabinet hinge mount
WM-302 Wall mount with swing arm & 4-way adjustment

Touch screen is not available for the LCD-2001VB, LCD-1500VB, & LCD-1701VB.

Specifications subject to change without notice

©2008 ToteVision

60K

Available through:

The Biggest Thing in HD LCD Monitors

LCD-1901HD LCD-1901HDL LCD-1901HDR



LCD-1901HDR Rack Mount Unit



LCD-1901HDL Flush Mount Unit

Active Matrix 19" Color LCD Monitors

• HD compatible (supports 480p/i, 720p, 1080p/i)

• RS-232 feature allows external devices to control the monitor through the serial port.

• Underscan capability

- Displays 16:9 and 4:3
- Front controls for power menu, up/down, select
- On-screen display for: brightness, contrast, back light, hue, volume
- IR remote control
- Composite x 2, S-Video, component, and PC capability
- Active matrix technology allows wide viewing angle & eliminates distortion
- Anti-glare surface treatment provides enhanced viewing pleasure
- Case made of durable metal
- Built-in removable desk stand included
- Response Time: 16mS

LCD-1901HDL Unit in Flush Mount Kit

Dimensions (WHD): 19-3/8" x 13-5/16" x 2-5/16"

Installers Cut-Out (WH): 18" x 12-1/16"

Resolution: 1440 (H) x 900 (V) dots
Brightness rating: 300 cd/m² (Nit)
Contrast Ratio: 800:1

Display: 19" TFT LCD active matrix

Back Light: Built-in CCFT

Input Signal: Composite NTSC/PAL (*auto switching*),
S-Video, Analog RGB, component

PC compatibility: XGA, SVGA, VGA, MAC II

Dot Pitch: 0.25875 (H) x 0.25875(V)mm

Colors: 6-bit, 262, 144

Number of Pixels: 1,024,00 dots

Viewing angle L/R/T/B: 65/65/50/50

Pixel Configuration: Stripe

Input Signal Level: 1.0V P-P (positive) 75 Ohm

Speakers: 8 ohms, 2 W, 28 x 40mm oval type x 2

Speaker Amplifier: 2 W x 2 @ 10% THD, 100 mV

LCD-1901HDR: Dimensions (WHD): 19" x 12.3" x 12.1" (Occupies 7 RU)

Actual visible screen size (WH): 412 x 258mm / 16.2" x 10.1"

Operating temperature: 32~122°F or 0~50°C

Power Requirement: Regulated 12VDC, 3A, negative ground

Part No. DC-1500 required for use in vehicles

Power Consumption: 9.6 W (max)

Includes switching power supply: 100 ~ 240VAC, 47 ~ 63Hz

Rear Terminal Connections: BNC video IN/OUT, S-Video jack

3 RCA IN jacks (composite, audio L/R),

3.5 stereo audio OUT jack, 2.1mm DC IN jack

15-pin mini D-sub (female), RCA y/Pb/Pr jacks,

external IR jack, RCA video OUT jack for video 1 or 2

9-pin RS-232 jack

LCD-1901HDL: Weight: Net: 4.9 kg. /10.9 lbs Gross: 6.1 kg. /13.5 lbs.

LCD-1901HDR: Weight: Net: 4.9 kg. /10.9 lbs Gross: 6.1 kg. /13.5 lbs.

1319 Dexter Ave. N. • Ste. 020 • Seattle, WA 98109

Tel: 206-623-6000 • FAX: 206-623-6609

E-mail: sales@totevision.com

http://www.totevision.com

**TOTE
VISION**

The Biggest Thing in Rack Mounted LCD Monitors

LCD-1900VR LCD-1900V

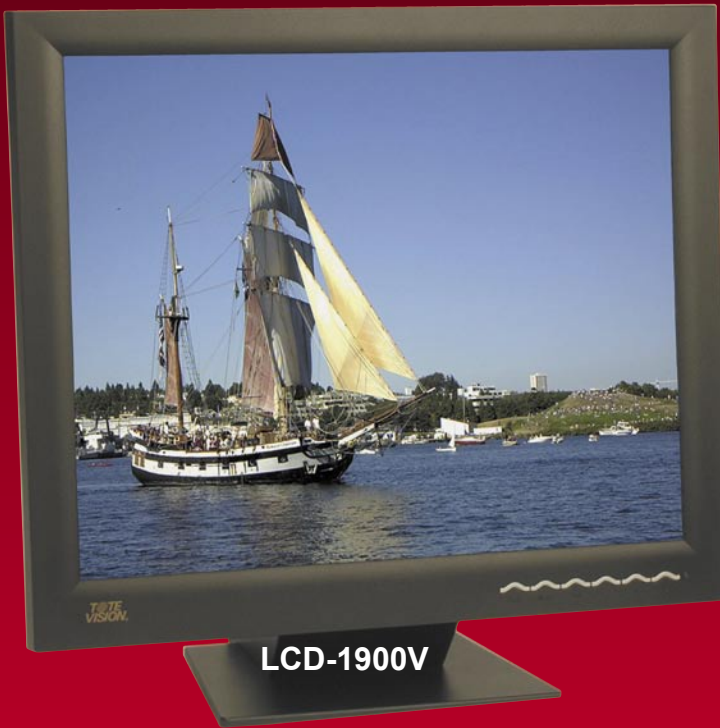

Active Matrix 19" Color LCD Monitors

- LCD-1900VR tilts 90° in rack for optimum viewing, occupies 9 rack units
- Hot key allows toggling between video, S-Video, component, and PC modes
- PIP: Picture in picture capability
- On-screen display for: brightness, contrast, back light, hue
- Low power consumption
- LCD-1900VR case made of durable metal
- LCD-1900V case made of durable ABS plastic
- Active matrix technology allows wide viewing angle
- Active matrix technology eliminates distortion
- LCD-1900VR: Response Time: 15ms / 10ms (rising/falling)
- LCD-1900V: Response Time: 25ms / 25ms (rising/falling)
- LCD-1900V has built-in removable desk stand and built-in interface for wall or arm mounting VESA 100mm FPMPMI compliant
- Includes switching power supply 90-240V, 12V, 50W

Optional Accessories

- | | |
|---------|--|
| DC-1500 | Factory approved car cord |
| HM-400 | Under-cabinet hinge mount |
| WM-30 | Wall mount bracket (fixed) |
| WM-302 | Wall mount with swing arm & 4-way adjustable |



HM-400



WM-302

**For touch screen for LCD-1900VR: order LCD-1900VRTS
Touch screen not available for LCD-1900V.**

- Display: 19.0" TFT LCD active matrix
- Back Light: Built-in (CCFT)
- Input Signal: Composite NTSC/PAL (auto switching), component, S-Video, Analog RGB
- Resolution: SXGA 1280(H) x 1024(V) dots
- PC compatibility: IBM / MAC compatible
- Dot Pitch: 0.264(H) x 0.264(V)mm
- Brightness rating: 450 cd/m² (Nit)
- Colors: 16.7M
- Contrast Ratio: 500:1
- Number of Pixels: 1,310,720 dots
- Viewing angle L/R/T/B: 85/85/85/85 degrees
- Pixel Configuration: Stripe
- Input Signal Level: 1.0V P-P (positive) 75 Ohm
- LCD-1900VR: Dimensions (WHD): 19" x 15.75" x 2.5" (Occupies 9 RU)
- LCD-1900V: Dimensions w/o desk stand (WHD): 444 x 376 x 73mm / 17.5" x 14.8" x 2.9"
- LCD-1900V: Dimensions w/ desk stand (WHD): 444 x 426 x 215mm / 17.5" x 16.8" x 8.5"
- Actual visible screen size (WH): 338 x 270 mm / 14.75" x 11.75"
- Operating temperature: 50 ~ 104°F or 10 ~ 40°C
- Power Requirement: Regulated 12VDC, A (TBA), negative ground
- Power Consumption: 48 W (max), 3 W (power saving off mode)
- Includes switching power supply: 100 ~ 240VAC (auto-sensing), 50 ~ 60Hz, A (TBA)
- LCD-1900VR: Rear Terminal Connections: BNC video IN/OUT jacks, S-Video, 15-pin mini D-sub (female), 4-pin DC IN jack, RCA video IN, RCA L/R audio IN, headphone jack, 9-pin component IN jack
- LCD-1900V: Rear Terminal Connections: BNC video IN/OUT jack, RCA video IN, 3.5 stereo audio IN/OUT jacks, 2.1mm DC IN jack, S-Video jack, 15 pin mini D-sub (female), 9-pin component IN jack
- LCD-1900VR: Weight: Net: 8.6 kg. / 19 lbs.
Gross: 11.8 kg. / 26 lbs.
- LCD-1900V: Net: 7.5 kg / 16.5 lbs.
Gross: 10 kg. / 22 lbs.

The Biggest Thing in LCD Monitors

LCD-1700V LCD-1700VR LCD-1703VRZ



LCD-1700V



LCD-1700VR
in 19" Rack Mount Kit



LCD-1703VRZ
in 19" 1 RU Rack Mount

Active Matrix 17" Color LCD Monitors

• RS-232 feature allows external devices to control the monitor through the serial port.

- LCD-1703VRZ, 17" LCD color monitor in standard 19" rack mount kit
 - Occupies 1 Rack Unit
 - Monitor automatically turns ON/OFF when tilted up/down
 - Rear mounting bracket extends from 24" to 30"

- Hot key allows toggling between video, S-Video, component, PC modes
- PIP: Picture in picture capability with front toggle key
- On-screen display for: brightness, contrast, back light, hue, volume
- Front control keys for power, menu, auto, +/-, up/down
- For color and B&W applications
- Low power consumption
- Case made of durable ABS plastic
- Active matrix technology allows wide viewing angle
- Active matrix technology eliminates distortion
- LCD-1700V includes built-in removable desk stand
- LCD-1700V has built-in interface for wall or wall mounting VESA 100mm FPMPMI compliant
- Response Time: 35/20ms (rising/falling)

Optional Accessories

- | | |
|----------|--|
| DC-1500 | Factory approved car cord |
| HM-400 | Under-cabinet hinge mount |
| WM-30 | Wall mount bracket (fixed) |
| WM-302 | Wall mount with swing arm & 4-way adjustable |
| WMC-1720 | Ceiling mount |



HM-400



WM-302

- Display: 17.0" TFT LCD active matrix
- Back Light: Built-in (CCFT)
- Input Signal: Composite NTSC/PAL (auto switching), S-Video, component, DVI, Analog RGB
- Resolution: SXGA 1280(H) x 1024(V) dots
- PC compatibility: IBM / MAC compatible
- Dot Pitch: 0.264(H) x 0.264(V)mm
- Brightness rating: 350 cd/m² (Nit)
- Colors: 16.7M
- Contrast Ratio: 500:1
- Number of Pixels: 1,310,720 dots
- Viewing angle L/R/T/B: 85/85/85/85 degrees
- Pixel Configuration: Stripe
- Input Signal Level: 1.0V P-P (positive) 75 Ohm
- Speakers: 8 ohms, 2W, 28 x 40mm oval type x 2
- Stereo Amplifier: 2 W x 2 @ 10% THD, 100 mV
- LCD-1700V: Dimensions w/o desk stand (WHD): 426 x 376 x 67mm / 16.8" x 14.8" x 2.6"
- LCD-1700V: Dimensions w/ desk stand (WHD): 426 x 432 x 162mm / 16.8" x 17" x 6.4"
- LCD-1700VR: Dimensions (WHD): 19" x 14" x 2.5"
- LCD-1703VRZ: Dimensions (WHD): 19" x 1.75" x 24"
- Actual visible screen size (WH): 338 x 270 mm / 13.3" x 10.6"
- Operating temperature: 50~104°F or 10~40°C
- Power Requirement: Regulated 12VDC, 4A, negative ground
Part No. DC-1500 required for use in vehicles
- Power Consumption: LCD-1700V: 45 W (max), 3 W (power saving off mode)
LCD-1700VR/ 1703VRZ: 48 W (max), 3 W (power saving off mode)
- Includes switching power supply: 100 ~ 240VAC (auto-sensing), 50 ~ 60Hz, 1.2A
- Rear Terminal Connections: BNC video IN/OUT jacks, 3.5 stereo audio IN jack, RCA video IN, RCA L/R audio IN, 2.1mm DC IN jack, S-Video jack, DVI (22 pin) w/ DVI /VGA cable, 3.5 mm RS-232 IN, 9-pin component IN
- LCD-1700V: Weight: Net: 7.3 kg. / 16 lbs. Gross: 9.5 kg. / 21 lbs.
- LCD-1700VR: Weight: Net: Est.7.4 kg./ 16.4 lbs Gross: 9.7 kg. / 21.4 lbs.
- LCD-1703VRZ: Weight: Net: 14.4 kg. / 13.8 lbs. Gross: 9.5 kg. / 21 lbs.

Touch Screen: order LCD-1700TS for model LCD-1700V
Touch screen not available for model LCD-1703VRZ

The Biggest Thing in HD LCD Monitors

LCD-1540HD LCD-1540HDL LCD-1540HDR



Back View



LCD-1540HDL Flush Mount Unit



LCD-1540HDR Rack Mount Unit

Active Matrix 15.4" Color LCD Monitors

• **HD compatible (supports 480p/i, 720p, 1080p/i)**

• **RS-232 feature allows external devices to control the monitor through the serial port.**

• **Underscan capability**

- Displays 16:9 and 4:3
- Front controls for power menu, up/down, select
- On-screen display for: brightness, contrast, back light, hue, volume
- IR remote control
- Composite x 2, S-Video, component, and PC capability
- Active matrix technology allows wide viewing angle & eliminates distortion
- Anti-glare surface treatment provides enhanced viewing pleasure
- Case made of durable metal
- Built-in removable desk stand included
- Response Time: 16mS
- Built-in interface for wall or wall mounting
VESA 75mm FPMPMI compliant

LCD-1540HDL Unit in Flush Mount Kit

Dimensions(WHD): 16.3" x 11.3" x 1.6"

Installers Cut-Out (WH): 14-3/4" x 10-1/8"

Optional Accessories

- HM-400 Under-cabinet hinge mount
- WM-30 Wall mount bracket (fixed)
- WM-302 Wall mount with swing arm & 4-way adjustable
- WMC-1720 Ceiling mount



HM-400



WM-302

Resolution: 1280 (H) x 800 (V) dots

Brightness rating: 200 cd/m² (Nit)

Contrast Ratio: 550:1

Display: 15.4" TFT LCD active matrix

Back Light: Built-in CCFT

Input Signal: Composite NTSC/PAL (*auto switching*),
S-Video, Analog RGB, component

PC compatibility: XGA, SVGA, VGA, MAC II

Dot Pitch: 0.25875 (H) x 0.25875(V)mm

Colors: 6-bit, 262, 144

Number of Pixels: 1,024,00 dots

Viewing angle L/R/T/B: 65/65/50/50

Pixel Configuration: Stripe

Input Signal Level: 1.0V P-P (positive) 75 Ohm

Speakers: 8 ohms, 2 W, 28 x 40mm oval type x 2

Speaker Amplifier: 2 W x 2 @ 10% THD, 100 mW

LCD-1540HD: Dimensions with desk stand (WHD): 378 x 295 x 40mm / 14.9" x 11.6" x 1.6"

LCD-1540HD: Dimensions w/o desk stand (WHD): 378 x 255 x 40mm / 14.9" x 10.0" x 1.6"

LCD-1540HDR: Dimensions (WHD): 19" x 10.5" x 1.6" (Occupies 6 RU)

Actual visible screen size (WH): 331 x 207mm / 13.0" x 8.2"

Operating temperature: 32~122°F or 0~50°C

Power Requirement: Regulated 12VDC, 3A, negative ground

Part No. DC-1500 required for use in vehicles

Power Consumption: 9.6 W (max)

Includes switching power supply: 100 ~ 240VAC, 47 ~ 63Hz

Rear Terminal Connections: BNC video IN/OUT, S-Video jack

3 RCA IN jacks (composite, audio L/R),

3.5 stereo audio OUT jack, 2.1mm DC IN jack

15-pin mini D-sub (female), RCA y/Pb/Pr jacks,

external IR jack, RCA video OUT jack for video 1 or 2

9-pin RS-232 jack

LCD-1540HD: Weight: Net: 3.2 kg. / 7.05 lbs. Gross: 6.72 kg. / 14.82 lbs.

LCD-1540HDL: Weight: Net: TBD Gross: 5 kg. / 11 lbs.

LCD-1540HDR: Weight: Net: TBD Gross: 5 kg. / 11 lbs.

1319 Dexter Ave. N. • Ste. 020 • Seattle, WA 98109

Tel: 206-623-6000 • FAX: 206-623-6609

E-mail: sales@totevision.com

http://www.totevision.com



LCD-1510V

with
RS-232 &
DVI

The Biggest Thing in LCD Monitors



Shown with RM-1510V Rack Mount



Shown with LM-1510V Flush Mount

Active Matrix 15.1" Color LCD Monitors

• **HD compatible (supports 480p/i, 720p)**

• **RS-232 feature allows external devices to control the monitor through the serial port.**

- Hot key allows toggling between video, S-Video, and PC modes
- PIP: Picture in picture capability
- Front controls for power menu, up/down, +/-
- On-screen display for: brightness, contrast, back light, hue, volume
- Composite, S-Video, component, and PC capability
- Case made of durable ABS plastic
- Built-in removable desk stand included
- Response Time: 30mS/20mS (rising/falling)

Optional Accessories

- | | |
|---|--|
| DC-1500 | Factory approved car cord |
| HM-1215 | Under-cabinet hinge mount bracket |
| HM-400 | Under-cabinet hinge mount |
| LM-1510V | Flush mount kit, Black metal 17" (W) x 15"(H) x 2.4"(D) |
| Installer's Cut-out: 15.5"(W) x 14.8"(H) | |
| PLT-1000 | VESA compliant plate (75mm) FPMPMI |
| WM-31 | Wall mount bracket (fixed) (order w/ PLT-1000) |
| WM-302 | Wall mount with swing arm & 4-way adjustable (order w/ PLT-1000) |
| WM-1000 | 2-way adjustable wall mount bracket |
| WMC-1015 | Ceiling mount (order PLT-1000) |



HM-400



WM-302

Touch screen not available for the LCD-1510V.

- Display: 15.1" TFT LCD active matrix
- Back Light: Built-in (CCFT)
- Input Signal: Composite NTSC/PAL (auto switching), S-Video, Analog RGB
- Resolution: XGA 1024 (H) x 768 (V) dots
- PC compatibility: XGA, SVGA, VGA, MAC II
- Dot Pitch: 0.297 (H) x 0.297 (V) mm
- Brightness rating: LCD-1510V: 500 cd/m² (Nit)
- Colors: 16.7M
- Contrast Ratio: 400 : 1
- Number of Pixels: 786,432 dots
- Viewing angle L/R/T/B: LCD-1510V: 60/60/60/60 degrees
- Pixel Configuration: Stripe
- Input Signal Level: 1.0V P-P (positive) 75 Ohm
- Speakers: 8 ohms, 2 W, 28 x 40mm oval type x 2
- Speaker Amplifier: 2 W x 2 @ 10% THD, 100 mV
- Dimensions w/o desk stand (WHD): 378 x 322 x 60mm / 14.9" x 12.7" x 2.4"
- Dimensions w/ desk stand (WHD): 378 x 355 x 162mm / 14.9" x 14" x 6.4"
- Actual visible screen size (WH): 309 x 232mm / 12.1" x 9.1"
- Operating temperature: 32~122°F or 0~50°C
- Power Requirement: Regulated 12VDC, 3500mA, negative ground
Part No. DC-1500 required for use in vehicles
- Power Consumption: 35 W (max)
- Includes switching power supply: 100 ~ 240VAC, 1A/47 ~63Hz
- Rear Terminal Connections: BNC video IN/OUT, S-Video jack
3 RCA IN jacks (composite, audio L/R),
3.5 stereo audio OUT jack, 2.1mm DC IN jack
15-pin mini D-sub (female), 9-pin Component IN jack,
RS-232, DVI

Weight: Net: 4.82 kg. / 10.62 lbs. Gross: 6.72 kg. / 14.82 lbs.

1319 Dexter Ave. N. • Ste. 020 • Seattle, WA 98109

Tel: 206-623-6000 • FAX: 206-623-6609

E-mail: sales@totevision.com

http://www.totevision.com



The Biggest Thing in LCD TV Monitors

LCD-1411T
LCD-1411TC
LCD-1411TL
LCD-1411TR
LCD-1411TW

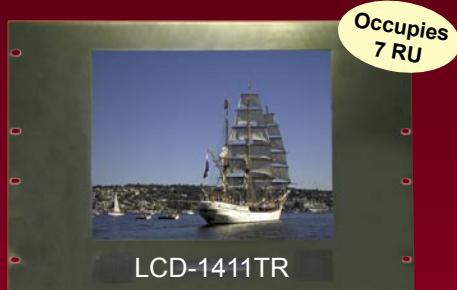

Active Matrix 14.1" Color LCD TV Monitor

- Cable ready ATSC/NTSC/QAM TV tuner
- Wireless remote control
- Dual front speakers for easy listening
- Top controls for power, menu, channel/volume up/down, mode, mute
- On-screen display for : brightness, contrast, tint, H/V position, saturation, sharpness
- Slim space saving design
- For color and B&W applications
- Low power consumption
- Case made of durable black ABS plastic
- Active matrix technology allows wide viewing angle
- Built-in removeable desk stand included
- Response time: 15mS (rising), 10mS (falling)
- VESA conversion plate makes this unit 75mm compliant
- Wireless stereo FM transmitter

LCD-1411TL Unit in Flush Mount Kit (Shown Above)

Dimensions (WHD): 406 x 368 x 73.6mm / 16" x 14.5" x 2.9"
 Installer's Cut-out (WH): 368 x 330mm / 14.5" x 13"
 Black metal front with plastic back

LCD-1411TC Unit with Custom 4-way Counter Mount and all cables hidden (bulk special order only)

LCD-1411TR Unit in Rack Mount Kit (Shown above)

Dimensions (WHD): 19" x 12.25" x 2.9"(Occupies 7 RU)

LCD-1411TW Unit with Custom 4-way Wall Mount and all cables hidden (bulk special order only)

Optional Accessories

- HM-400 Under-cabinet hinge mount (shown below)
 WM-30 Wall mount bracket (fixed)
 WM-302 Wall mount with swing arm & 4-way (shown below)



- Display: 14.1" TFT LCD active matrix
 Back Light: Built-in (CCFT)
 Input Signal: Composite NTSC/PAL (auto sensing), ATSC/NTSC/QAM/CATV
 Resolution: VGA 640 (H) x 480 (V) dots
 Dot Pitch: 0.4425 (H) x 0.4425 (V) mm
 Brightness rating: 450 cd/m² (Nit)
 Colors: 16.7M
 Contrast Ratio: 400 : 1
 Number of Pixels: 307,200 dots
 Viewing angle L/R/T/B: 85/85/85/85 degrees
 Pixel Configuration: RGB Vertical Stripe
 Input Signal Level: 1.0V P-P (positive) 75 Ohm
 Speakers: 4 ohms, 1 W x 2
 Dimensions w/o desk stand (WHD): 352 x 307 x 73 mm / 13.9" x 12.1" x 2.9"
 Dimensions w/ desk stand (WHD): 352 x 307 x 93 mm / 13.9" x 12.1" x 3.7"
 Actual visible screen size (WH): 283 x 212mm / 11.1" x 8.3"
 Operating temperature: 50~104°F or 10~40°C
 Power Requirement: Regulated 12VDC, 5A, negative ground
 Power Consumption: 60 W (max)
 Includes switching power supply: 100 ~ 240VAC, 1A/47 ~63Hz
 Rear Terminal Connections: RCA video IN/OUT jacks, RCA R/L audio IN/OUT jacks, headphone jack x 2, "F" connector for CATV, 2.1mm DC IN jack
 Net Weight: 6 kg. / 13.2 lbs.
 Gross Weight: 6.4 kg. / 14 lbs.

10.4" Color LCD with Component Input

LCD-1048HDM



Back Case

Active Matrix 10.4" Color LCD Monitor in Metal Case

Tempered glass helps to protect display panel.

Screw-down DC feature provides additional security for power connection.

Composite video BNC input provides security for video connection.

Durable metal case helps monitor to withstand severe conditions in the field.

- 3mm thick tempered glass helps to protect display panel from damage in the field.
- HD compatible (supports 480p/i, 720p, 1080p/i)
- RS-232 serial control provided
- Composite video BNC IN/OUT capability
- Underscan capability
- On-screen display controls, with front controls for power, Select, Menu, and Volume Up/Down.
- Wireless remote control provided.
- Hot key on remote control allows easy toggling between composite, S-Video, component, & PC inputs
- Rear IR jack allows direct connection for use with IR repeater systems
- Speaker output on board allows screw down connection for R/L audio
- Built-in amplifier provides ample power to drive right and left stereo 8 ohm speakers
- Made of durable metal with black powder coating.
- Built-in interface and proper cable exiting for wall arm mounting, VESA 75mm compliant
- Response time: 15/25 ms (rising/falling)
- SPS included, 100~240 VAC

Display: 10.4" TFT LCD active matrix
 Back Light: 2 x CCFT
 Input Signal: [Composite, component, & S-Video, NTSC/PAL auto sensing] analog RGB
 Dot Pitch: 0.206 (H) x 0.206 (V)mm
 Resolution: 1024(H) x 768(V) [700 lines for CCTV] or
 Number of Pixels: 786,432 dots
 Brightness Rating: 350 cd/m² (Nit)
 Colors: 262,144
 Contrast Ratio: 500:1

Viewing Angle L/R/T/B: 90/90/90/90 degrees
 Pixel Configuration: RGB Vertical Stripe
 Audio output: 5W x 2, 8 ohm
 Dimensions (WHD): 247 x 215 x 60mm / 9.7" x 8.5" x 2.4"
 Actual visible screen size (WH): 210 x 158mm / 8.3" x 6.2"
 Operating temperature: 50~104°F or 10~40°C
 Storage temperature: 14~158°F or -10~70°C
 Power requirement / consumption: 12VDC, 2A, negative ground / 24W
 Rear Terminal Connections: 15-pin mini D-sub, 4-pin RS-232, S-Video, component (RCA x 3), 3.5 PC audio IN, RCA x 2 and BNC composite IN/OUT, RCA L/R audio IN, 3.5 audio line OUT, 3.5 IR IN, L/R screw down speaker connectors, 2.1mm DC jack and screw down DC connector
 LCD-1048HDM Weight: Net: 2.4 kg. / 5.3 lbs. Gross: 3.7 kg. / 8.05 lbs

Optional Accessories

- DC-1500 Factory approved car cord
- HM-400 Under-cabinet hinge mount
- WM-31 Wall mount bracket (fixed)
- WM-302 Wall mount with swing arm & 4-way adjustable



HM-400



WM-302

10.4" Color LCD with Component Input

LCD-1048HDL LCD-1048HDR LCD-1048HD

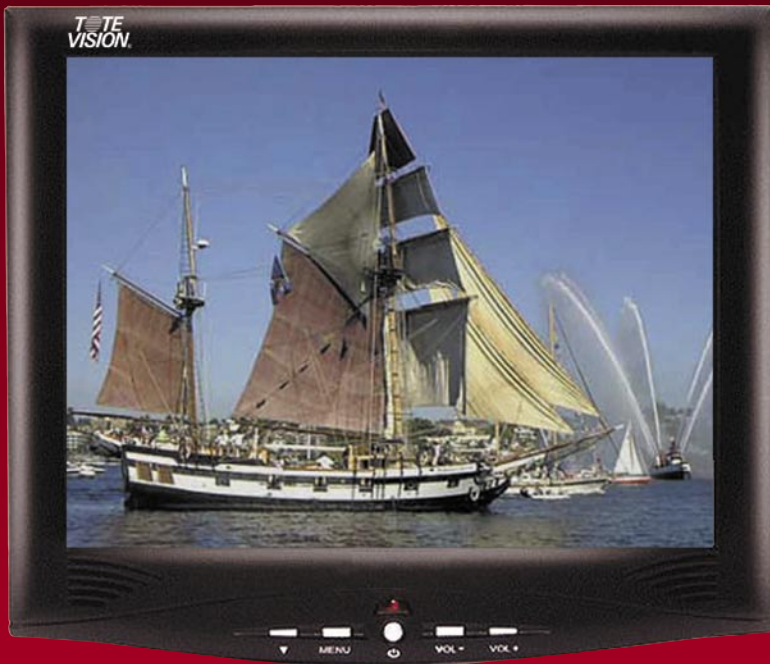

Back View

HD Compatible (supports 480p/i, 720p, 1080p/i)

- RS-232 serial control provided
- Composite video BNC IN/OUT capability
- Underscan capability
- On-screen display controls, with front controls for power, Select, Menu, and Volume Up/Down.
- Wireless remote control provided.
- Hot key on remote control allows easy toggling between composite, S-Video, component, & PC inputs
- Rear IR jack allows direct connection for use with IR repeater systems
- Speaker output on board allows screw down connection for R/L audio
- Built-in amplifier provides ample power to drive right and left stereo 8 ohm speakers
- 2 built-in speakers
- LCD-1048HDL and LCD-1048HDR are made of durable metal with black powder coating.
- LCD-1048HD cabinet is made of durable ABS plastic with 2 key hole slots for wall mounting
- Built-in interface and proper cable exiting for wall arm mounting, VESA 75mm compliant
- Screw down DC feature provides additional security for power connection
- Response time: 15/25 ms (rising/falling)
- SPS included, 100~240 VAC

LCD-1048HDL Unit in Flush Mount Kit

Dimensions(WHD): 337 x 247x 42mm / 13.3" x 9.7" x 1.7"
Installers Cut-Out (WH): 299 x 209mm / 11.8" x 8.2"

LCD-1048HDR Unit in 19" Rack Mount Kit

Occupies 4 RU

Optional Accessories

- | | |
|---------|--|
| DC-1500 | Factory approved car cord |
| HM-400 | Under-cabinet hinge mount |
| WM-31 | Wall mount bracket (fixed) |
| WM-302 | Wall mount with swing arm & 4-way adjustable |



HM-400



WM-302



LCD-1048HDL



LCD-1048HDR

Display: 10.4" TFT LCD active matrix

Back Light: 2 x CCFT

Input Signal: [Composite, component, & S-Video, NTSC/PAL auto sensing] analog RGB

Dot Pitch: 0.206 (H) x 0.206 (V)mm

Resolution: 1024(H) x 768(V) [700 lines for CCTV] or

Number of Pixels: 786,432 dots

Brightness Rating: 350 cd/m² (Nit)

Colors: 262,144

Contrast Ratio: 500:1

Viewing Angle L/R/T/B: 90/90/90/90 degrees

Pixel Configuration: RGB Vertical Stripe

Audio output: 5W x 2, 8 ohm

LCD-1048HDR Dimensions (WHD): 19" x 7" x 2" (Occupies 4 RU)

LCD-1048HD Dimension w/o desk stand (WHD): 269 x 229 x 47mm / 10.6" x 9.0" x 1.9"

LCD-1048HD Dimension with desk stand (WHD): 269 x TBD x TBDmm / 10.6" x TBD x TBD

Actual visible screen size (WH): 210 x 158mm / 8.3" x 6.2"

Operating temperature: 50~104°F or 10~40°C

Storage temperature: 14 ~ 158°F or -10 ~ 70°C

Power requirement/consumption: 12VDC, 2A, negative ground /24W

Rear Terminal Connections: 15-pin mini D-sub, 4-pin RS-232, S-Video, component (RCA x 3), 3.5 PC audio IN, RCA x 2 and BNC composite IN/OUT, RCA L/R audio IN, 3.5 audio line OUT, 3.5 IR IN, L/R screw down speaker connectors, 2.1mm DC jack and screw down DC connector

LCD-1048HDL Weight: Net: 1.94 kg. / 4.28 lbs. Gross: 3.4 kg. / 7.4 lbs.

LCD-1048HDR Weight: Net: 2.79 kg./ 6.14 lbs. Gross: 3.9 kg. / 8.5 lbs.

LCD-1048HD Weight: Net: 1.2 kg. / 2.5 lbs. Gross: 3.3 kg. / 7.3 lbs.

The Biggest Thing in Sunlight Readable LCD Monitors

LCD-1211VB LCD-1042VB



LCD-1042VB



LCD-1211VB

Active Matrix 10.4" and 12.1" Color Ultra-Bright LCD Monitor

NEW • LED backlight provides longer life, uses less power and provides better color saturation

• Ultra-bright technology provides sunlight readability

- Mercury and lead free green design
- High shock and vibration resistance
- On-screen display for: brightness, contrast, back light, hue
- Composite, S-Video, PC capability
- For color and B&W applications
- Low power consumption
- Case made of durable steel
- Active matrix technology allows wide viewing angle
- Front controls for power, menu, up/down
- Built-in interface for wall or arm mounting
VESA 75mm FPMPPI compliant
- Response Time: LCD-104VB 40ms
LCD-1211VB 23ms

Optional Accessories

- | | |
|----------|---|
| DC-1500 | Factory approved car cord |
| HM-400 | Under-cabinet hinge mount bracket (shown below) |
| WM-30 | Wall mount bracket (fixed) |
| WM-31 | Wall mount bracket (fixed) |
| WM-302 | Wall mount with swing arm & 4-way (shown below) |
| WMC-1015 | Ceiling mount |



HM-400



WM-302

Touch screen: Order LCD-1211TS or LCD-1042TS

Display: LCD-1042VB: 10.4" TFT LCD active matrix
LCD-1211VB: 12.1" TFT LCD active matrix

Back Light: LED

Input Signal: Composite NTSC/PAL (menu select),
S-Video, analog RGB

Pixel Pitch: LCD-1042VB: 0.20(H) x 0.20(V) mm
LCD-1211VB: 0.24(H) x 0.24(V)mm

Resolution: LCD-1042VB: 1024(H) x 768(V)
LCD-1211VB: 1024(H) x 768(V)

Display Modes: VGA, SVGA (LCD-1211VB)

Brightness rating: LCD-1042VB: 1000 Nit
LCD-1211VB: 1000 Nit

Contrast Ratio: LCD-1042VB: 800:1
LCD-1211VB: 700:1

Pixel Configuration: Stripe

Colors: LCD-1042VB: 16.2M
LCD-1211VB: 262,144

Number of Pixels: LCD-1042VB: 307,200 dots,
LCD-1211VB: 786,432

Viewing angle L/R/T/B LCD-1042VB: 65/65/55/55, LCD-1211VB: 70/70/70/70

Input Signal Level: 1.0V P-P (positive) 75 Ohm

Dimensions (WHD): LCD-1042VB: 340 x 229 x 54mm / 13.4" x 9" x 2.1"
LCD-1211VB: 338 x 278 x 59mm / 13.3" x 10.9" x 2.3"

Actual visible screen size (WH): LCD-1042VB: 210.4 x 157.8mm / 8.3" x 6.2"
LCD-1211VB: 246 x 184.5mm / 9.7" x 7.3"

Operating temperature: 32 ~ 122°F or 0 ~ 50°C, 95% RH

Storage temperature: -4 ~ 140°F or -20 ~ 60°C, 95% RH

Power Requirement: Regulated 12VDC, 5A, negative ground

Part No. DC-1500 required for use in vehicles

Power Consumption: LCD-1042VB: 18 W, LCD-1211VB: 18.5 W (max)

LCD-1042VB: Includes switching power supply: 110 ~ 240VAC, 4.16 A / 47 ~ 63Hz

LCD-1211VB: Includes switching power supply: 110 ~ 240VAC, ___ A / 47 ~ 63Hz

Rear Terminal Connections: BNC video IN/OUT jacks, 15-pin mini D-sub (female),
S-Video jack, 2.1mm DC IN jack

LCD-1042VB Weight: Net: 2.4 kg. / 5.3 lbs. Gross: 4.8 kg. / 10.6 lbs.

LCD-1211VB Weight: Net: 3.4 kg. / 7.5 lbs. Gross: 4.5 kg. / 10 lbs.

Specifications subject to change without notice

©2008 ToteVision

70K

Available through:

The Biggest Thing in LCD TV Monitors

LCD-1044T
LCD-1044TC
LCD-1044TL
LCD-1044TU
LCD-1044TW

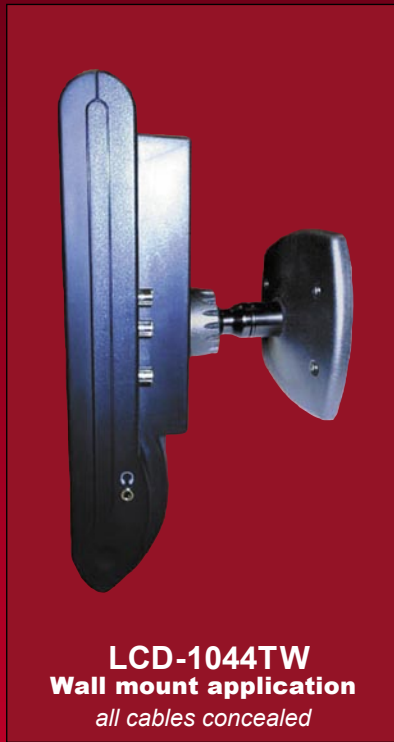

Active Matrix 10.4" Color LCD TV Monitor

- Cable ready ATSC/NTSC/QAM TV tuner
- Built-in AC power contributes to esthetic appearance (electrician required for connection).
- Custom 4-way mount allows user to position unit for maximum viewing pleasure.
 - LCD-1044TC Pan/Tilt 30°/30°/60°/0° (L/R/T/B)
 - LCD-1044TU Pan/Tilt 30°/30°/0°/60° (L/R/T/B)
 - LCD-1044TW Pan/Tilt 30°/30°/30°/30° (L/R/T/B)
- Wall mount and ceiling mount versions attach to double gang electrical box.
- Wireless remote control
- Dual front speakers for easy listening
- Front controls for power, menu, channel/volume up/down, mode, mute
- On-screen display for : brightness, contrast, tint, H/V position, saturation, sharpness
- Case made of durable black ABS plastic
- LCD-1044TC is water tight for protection of cabinetry.
- Response time: 10mS (rising), 25mS (falling)

LCD-1044T Stand Alone Model

- Built-in removeable desk stand included.
- 75mm VESA compliant with plate
- Powered by external AC adapter
- Optional Accessories for LCD-1044T:
 - HM-400 Under-cabinet hinge mount
 - WM-302 4-way adjustable wall mount
 - WM-30 Wall mount bracket (fixed)
 - WM-31 Wall mount bracket (fixed)



LCD-1044TL Unit in Flush Mount Kit

Dimensions (WHD): 305 x 279 x 56mm / 12" x 11" x 2.2"
Cut-Out (WH): 279 x 245mm / 11" x 9.6"

**Perfect for
behind-the-mirror
applications**

- Display: 10.4" TFT LCD active matrix
- Back Light: Built-in (CCFT)
- Input Signal: Composite NTSC/PAL (auto sensing), ATSC/NTSC/QAM/CATV
- Resolution: VGA 800 (H) x 600 (V) dots
- Dot Pitch: 0.264 (H) x 0.264 (V) mm
- Brightness rating: 400 cd/m² (Nit)
- Colors: 16.7M
- Contrast Ratio: 500 : 1
- Number of Pixels: 307,200 dots
- Viewing angle L/R/T/B: 60/60/40/60 degrees
- Pixel Configuration: RGB Vertical Stripe
- Input Signal Level: 1.0V P-P (positive) 75 Ohm
- Speakers: 4 ohms, 1 W x 2
- LCD-1044T: Dimensions w/o desk stand (WHD): 277 x 246 x 58mm / 10.9" x 9.7" x 2.3"
- LCD-1044T: Dimensions w/ desk stand (WHD): 277 x 246 x 73.7mm / 10.9" x 9.7" x 2.9"
- LCD-1044TC: Dimensions (WHD): TBD
- LCD-1044TU: Dimensions (WHD): TBD
- LCD-1044TW: Dimensions (WHD): 307 x 342 x 178mm / 12.1" x 13.5" x 7"
- Actual visible screen size (WH): 211.2 x 158.4mm / 8.3" x 6.2"
- Operating temperature: 50~104°F or 10~40°C
- Power Requirement: Regulated 12VDC, 4A, negative ground
- Power Consumption: 60 W (max)
- Includes switching power supply: 100 ~ 240VAC, 1A / 47 ~ 63Hz
- Rear Terminal Connections: RCA video IN/OUT jacks, RCA R/L audio IN/OUT jacks, headphone jack x 2, "F" connector for CATV, 2.1mm DC IN jack for LCD-1044T
- LCD-1044T: Weight: Net: 1.6 kg./3.5 lbs. Gross: 2.6 kg./5.9 lbs.
- LCD-1044TC: Weight: Net: Est. 2.1 kg. / 4.7 lbs. Gross: 3.4 kg. / 7.6 lbs.
- LCD-1044TU: Weight: Net: Est. 2.1 kg. / 4.7 lbs. Gross: 3.4 kg. / 7.6 lbs.
- LCD-1044TW: Weight: Net: 1.5 kg./ 3.3 lbs. Gross: 2.8 kg./ 6.2 lbs.

GSA Schedule For model LCD-1044TC, LCD-1044TU, & LCD-1044TW only.
GS-07F-0069L, SIN: 246-42(1), 246-50

The Biggest Thing in Rack Mounted LCD Monitors

LCD-841D LCD-841DS

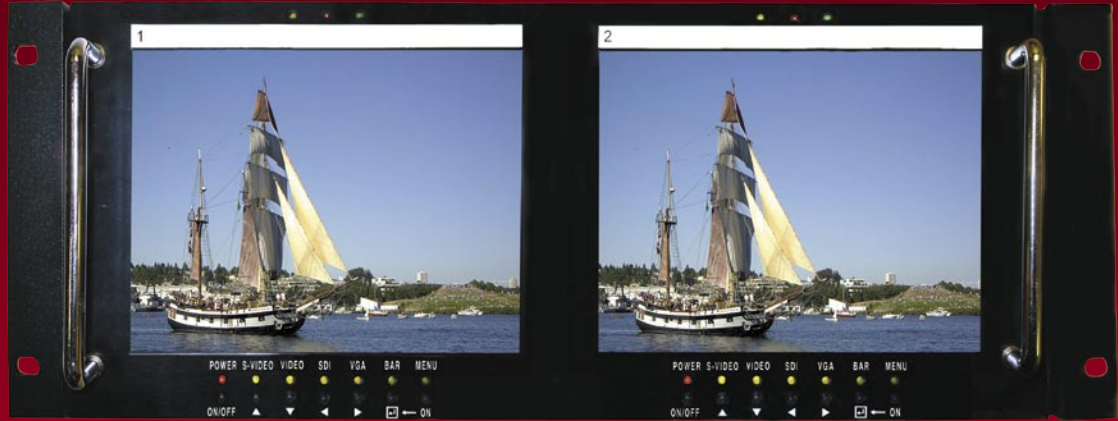

LCD-841DS



Back View of LCD-841D



Back View of LCD-841DS

Active Matrix 8.4" Color LCD Monitor with PC Capability

For unit with SDI input/output order model LCD-841DS

• **Blue gun feature provides for easy adjustment of screen display**

• **Underscan capability**

- Space saving design - occupies 4 RU
- Tilts 90° in the rack for optimum viewing
- Self-powered 3 color tally system is provided for each monitor
- Model LCD-841SDI has SDI input capability
- Active matrix technology allows wide viewing angle
- Active matrix technology eliminates distortion
- Switching power supply (included) powers both monitors
- Built-in memory saves current setup when unit is powered down
- Active loop through feature is always on as long as power is on
- Scaler accepts 640x480, 800x600, 1024x768, 1152x864, and 1280x1024
- Response Time: 15ms/25ms (rising/falling)
- For color and B/W applications
- Built-in color bar generator
- Each screen has individual front mounted direct source selector buttons

- Display: 8.4" (diagonal) TFT LCD active matrix
- Back Light: Built-in CCFT
- Input Signal: NTSC/PAL auto sensing, composite video, S-Video, analog RGB
- Resolution: 800(H) x 600(V) dots
- Dot Pitch: 0.213(H) x 0.213(V)mm
- Brightness rating: 350 cd/m²(Nit)
- Contrast Ratio: 250:1
- Number of Pixels: 480,000 Dots
- Viewing angle L/R/T/B: 60/60/40/60
- Colors: 262,144
- Color Configuration: RGB Vertical Stripe
- Power Requirements: Regulated 12 VDC, 3A
- Power Consumption: 36 W (max)
- Video Input Level: 1.0 V P-P (positive) 75 Ohm
- Dimensions (WHD): Occupies 4 RU (7") x 1.75" (D)
- Actual visible screen size (WH): 170 x 127mm / 6.7" x 6.4"
- Operating temperature: 50 ~ 104°F or 10 ~ 40°C
- Storage temperature: -4 ~ 158°F or -20 ~ 70°C
- LCD-841D: Rear Connections: BNC video IN/OUT (x2), S-Video IN/OUT, 15-pin mini D-sub (female), RS-232 OUT or USB (for touch screen), Tally, 2.1 DC IN jacks
- LCD-841DS: Rear Connections: BNC video IN/OUT, S-Video IN, SDI IN/OUT x 2, 15-pin mini D-sub (female) x 2, RS-232 x 2 (only functional for touch screen model)
- Net Weight: 2.7 kg. / 6 lbs.

GSA Schedule
GS-07F-0069L, SIN: 246-42(1), 246-50

Specifications subject to change without notice ©2008 ToteVision 50K

Available through:

The Biggest Thing in Little PC Capable LCD Monitors

LCD-840D
LCD-840V
LCD-840VL
LCD-641V
LCD-641VL



LCD-840D Rack Mount Unit



LCD-840V In Metal Case

Shown with optional MB-3 desk stand



LCD-840VL Flush Mount Unit



LCD-641V In Metal Case
 (Bulk Special Order Only)

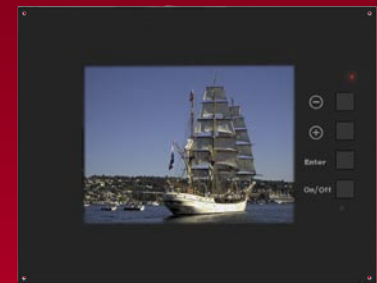

LCD-641VL Flush Mount Unit
 (Bulk Special Order Only)

Active Matrix 8.4" and 6.4" Color LCD Monitors with PC Capability

- For color and B/W applications
- Active matrix technology allows wide viewing angle
- Active matrix technology eliminates distortion
- A/C adaptor included
- Response Time: 20ms/30ms (rising/falling)
- Built-in interface for wall or arm mounting
- VESA 75mm FPMPI compliant

LCD-840VL 8.4" Unit in Flush Mount Kit

Dimensions (WHD): 290 x 213 x 40.6mm / 11.4" x 8.4" x 1.6"
 Installer's Cut-out (WH): 229 x 175mm / 9" x 6.9"
 Weight: Net: Est. 1.8 kg. / 4 lbs. Gross: Est. 2.7 kg. / 6 lbs.

LCD-641VL 6.4" Unit in Flush Mount Kit

Dimensions (WHD): 272 x 213.5 x 37.5mm / 11" x 8.4" x 1.5"
 Installer's Cut-out (WH): 227 x 172mm / 9" x 6.9"
 Weight: Net: 1.8 kg. / 4 lbs. Gross: 2.7 kg. / 6 lbs.
 (Bulk Special Order Only)

LCD-641V 6.4" in Metal Case (Bulk Special Order Only)

Optional Accessories

MB-3 Desk stand (shown above)
 HM-400 Under-cabinet hinge mount

Touchscreen: For 8.4" order LCD-840TS
For 6.4" order LCD-641TS

- Display: LCD-840 series: 8.4" TFT LCD active matrix
 LCD-641 series: 6.4" TFT LCD active matrix
- Input Signal: NTSC/PAL(auto sensing), S-Video, Analog RGB
- Resolution: LCD-840 series: 800(H) x 600(V) dots
 LCD-641 series: 640(H) x 480(V) dots
- Brightness rating: LCD-840 series: 150 cd/m²(Nit)
 LCD-641 series: 350 cd/m²(Nit)
- Contrast Ratio: LCD-840 series: 200:1, LCD-641 series: 150:1
- Viewing angle L/R/T/B: LCD-840 series: 45/45/35/15
 LCD-641 series: 55/55/35/15
- Power Requirements: Regulated 12 VDC, 3A (LCD-641V: Regulated 12 VDC, 2A)
- Power Consumption: LCD-840 series: 30 W (max)
 LCD-641 series: 8 W (max)
- Video Input Level: 1.0 V P-P (positive) 75 Ohm
- Dimensions (WHD): LCD-840D: 19" x 7" (Occupies 4 RU) x 1.75"
 LCD-840V: 264 x 163 x 38mm / 10.4" x 6.4" x 1.5"
 LCD-641V: 225 x 133 x 41mm / 8.9" x 5.2" x 1.6"
 LCD-641VL: 272 x 213.5 x 37.5mm / 11" x 8.4" x 1.6"
- Actual visible screen size (WH): LCD-840 series: 174 x 131mm / 6.9" x 5.2"
 LCD-641 series: 129 x 97mm / 5.1" x 3.8"
- Operating temperature: 50 ~ 104°F or 10 ~ 40°C
- Connections: RCA video IN, S-Video, BNC video IN/OUT, 2.1 DC IN jacks, 15-pin mini D-sub (female)
- Weight: LCD-840D: Net: 2.5 kg. / 5.6 lbs. Gross: 5.4 kg. / 12 lbs.
 LCD-840V: Net: 3.2 kg. / 5.4 lbs. Gross: 3.6 kg. / 8 lbs.
 LCD-840VL: Net: Est. 2.9 kg. / 6.4 lbs. Gross: 4.1 kg. / 9 lbs.
 LCD-641V: Net: 1.4 kg. / 3 lbs. Gross: 2.7 kg. / 6 lbs.

Specifications subject to change without notice

©2008 ToteVision

30K

Available through:

P.21

Download from www.Sematerials.com. All Manuals Search And Download: <http://www.totevision.com>

1319 Dexter Ave. N. • Ste. 020 • Seattle, WA 98109
 Tel: 206-623-6000 • FAX: 206-623-6609
 Email: sales@totevision.com



The Biggest Thing in Small HD Monitors

LCD-703HDA LCD-703HDV



LCD- 703HDA Unit with Anton Bauer QRC -Gold mount



LCD- 703HDV Unit with "V" lock mount for IDX batteries

Active Matrix 7" Color LCD Monitors

• **HD compatible (supports 480p/i, 576p/i, 720p, 1080p/i)**
Both component & DVI inputs accept 1080p/i.

NEW • **LED backlight provides longer life, uses less power and provides better color saturation**

• **RS-232 feature allows external devices to control the monitor through the serial port.**

• **Underscan capability**

• **Blue gun feature provides for easy adjustment of screen display**

- DVI-D input jacks accepts digital input.
- Anti-glare treatment adds to viewing pleasure
- Displays either 16:9 or 4:3 aspect ratio
- Front controls for : menu, up, down, On/Off, mode
- IR remote control
- Case made of durable metal.
- A/C adaptor (Part No. AC-1000) included
- Built-in interface and proper cable exiting for wall or arm mounting VESA 75mm FPMPMI compliant
- Response time: 22mS (Rising), 35mS (Falling)
- Mounting pad with ¼-20 threaded socket (located at bottom and can be moved to top).



Front View

Display: 7" TFT LCD active matrix
 Back Light: LED
 Input Signal: NTSC/PAL (auto sensing)
 Resolution: 800 (H) x 480 (V) dots
 Dot Pitch: 0.19(H) x 0.19(V)mm
 Brightness rating: 350 cd/m² (Nit)
 Contrast Ratio: 300 : 1
 Number of Pixels: 1.2 M
 Viewing angle L/R/T/B: 65/65/55/60 degrees
 Pixel Configuration: Stipe
 Power Requirements: 6~20 VDC, 500mA, + pin, - ground
 Power Consumption: 350mA@ 12 VDC (max)
 Video Input Level: 1.0 V P-P (positive) 75 Ohm
 LCD-703HDA/HDV: Dimensions (WHD): 174 x 134 x 35mm / 6.9" x 5.3" x 1.4"
 (Height including 5mm mounting pad: 134 + 5mm = 139mm)
 Actual visible screen size (WH): 152.4 x 91.4mm / 6" x 3.6"
 Operating temperature: 10 ~ 104°F / -12 ~ 40°C
 Storage temperature: -13 ~ 140°F / -25 ~ 60°C
 Rear inputs: BNC composite video IN/OUT,
 S-Video IN/OUT, BNC component IN/OUT
 RS-232, Tally, DVI-D, 2.1mm DC IN jack
 LCD-703HDA / HDV: Weight: Net: 0.7 kg./ 1.5 lbs Gross: TBD

Custom Tote Bag

Order TB-703HD for nylon tote bag with sun shield.



**Metal Sun Shield
SS-703HD**

Optional Accessories

| | |
|----------|---|
| HS-1 | Hot shoe mount |
| MB-3 | Desk stand |
| SS-703HD | Sun shield |
| TB-703 | Custom Tote bag with sun shield for LCD-703HD |
| WM-30 | Wall mount bracket (fixed) |

GSA Schedule
GS-07F-0069L, SIN: 246-42(1), 246-50

The Biggest Thing in Small HD Monitors

**LCD-703HD
LCD-703HD1
LCD-703HD2
LCD-703HDL**



Back View



LCD-703HDL Unit in flush mount kit

Active Matrix 7" Color LCD Monitors

• **HD compatible (supports 480p/i, 576p/i, 720p, 1080p/i)**

NEW

• **LED backlight provides longer life, uses less power and provides better color saturation**

• **RS-232 feature allows external devices to control the monitor through the serial port.**

• **Underscan capability**

• **Blue gun feature provides for easy adjustment of screen display**

- Anti-glare treatment adds to viewing pleasure
- Displays either 16:9 or 4:3 aspect ratio
- Front controls for : menu, up, down, On/Off, mode
- IR remote control
- Case made of durable metal.
- A/C adaptor (Part No. AC-1000) included
- Built-in interface and proper cable exiting for wall or arm mounting VESA 75mm FPMPI compliant
- Response time: 22mS (Rising), 35mS (Falling)
- Mounting pad with 1/4"-20 threaded socket

LCD-703HDL Flush mount kit (shown above)

Dimensions (WHD): 215 x 175 x 35mm / 8.5" x 6.9" x 1.4"
Installer's Cut-out (WH): 180 x 138mm / 7.1" x 5.4"

LCD-703HDLX - w/ no LEDs & no controls showing
- Special Order Only

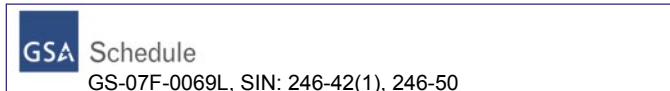

LCD-703HD2 Dual Rack Mount Unit

LCD-703HD1 Single Rack Mount Unit

- Display: 7" TFT LCD active matrix
- Back Light: LED
- Input Signal: NTSC/PAL (auto sensing)
- Resolution: 800 (H) x 480 (V) dots
- Dot Pitch: 0.19(H) x 0.19(V)mm
- Brightness rating: 350 cd/m² (Nit)
- Contrast Ratio: 300 : 1
- Number of Pixels: 1.2 M
- Viewing angle L/R/T/B: 65/65/55/60 degrees
- Pixel Configuration: Stipe
- Power Requirements: 6~20 VDC, 500mA, + pin, - ground
- Power Consumption: 350mA@ 12 VDC (max)
- Video Input Level: 1.0 V P-P (positive) 75 Ohm
- LCD-703HD: Dimensions (WHD): 174 x 134 x 35mm / 6.9" x 5.3" x 1.4"
(Height including 5mm mounting pad: 134 + 5mm = 139mm)
- LCD-703HD1 / LCD-703HD2: Dimensions (WHD): 482 x 133.4 x 55mm / 19" x 5.25" x 2.2", 3RU
- Actual visible screen size (WH): 152.4 x 91.4mm / 6" x 3.6"
- Operating temperature: 10 ~ 104°F / -12 ~ 40°C
- Storage temperature: -13 ~ 140°F / -25 ~ 60°C
- Rear inputs: BNC composite video IN/OUT, S-Video IN/OUT, BNC component IN/OUT, RS-232, Tally, DVI-D, 2.1mm DC IN jack
- LCD-703HD: Weight: Net: 0.6 kg. / 1.35 lbs Gross: 0.86 kg. / 1.9 lbs.
- LCD-703HD2: Weight: Net: 2.5 kg. / 5.5 lbs Gross: 3.2 kg. / 7 lbs.
- LCD-703HDL: Weight: Net: 0.86 kg. / 1.9 lbs Gross: 1.1 kg. / 2.45 lbs

Field Monitor Kit

Order LCD-703HD KIT for unit with monitor, tote bag, and rechargeable 2600MAH battery pack (approx. 6 hours operation).

Optional Accessories

- HS-1 Hot shoe mount
- MB-3 Desk stand
- SS-703HD Sun shield
- TB-703 Custom Tote bag with sun shield for LCD-703HD
- WM-30 Wall mount bracket (fixed)



The Biggest Thing in LCD Monitors

LCD-801 LCD-800 LCD-800D LCD-800L



Occupies 4 RU

LCD-800D Dual Monitors in 19" Rack Mount Kit



LCD-801
Unit in ABS Housing



Shown with MB-2
desk stand/wall mount bracket



Shown with
MB-3
desk stand

LCD-800
Unit in Metal Housing



LCD-800L
Unit with Flush Mount Kit

Active Matrix 8" Color LCD Monitor

- S-Video capability
- Mirror and upside down image picture control
- Anti-glare coating provides enhanced display
- Remote control for maximum convenience
- LCD-801: Key lock feature allows front control buttons to be disabled
- LCD-801: Power saving ON/OFF feature
- A/C adaptor included
- LCD-801 : MB-2 desk stand/ wall mount included (shown above)
- LCD-800 and LCD-800L have built-in interface for wall or arm mounting VESA 75mm FPMPLI compliant

LCD-800L Unit in Flush Mount Kit (shown above)

Dimensions (WHD): 292 x 216 x 38mm / 11.5" x 8.5" x 1.5"
 Installer's Cut-out (WH): 249 x 173mm / 9.8" x 6.8"
 Black metal.

Optional Accessories

- BP-563 Rechargeable battery pack 2600mAh NiCad battery pack (provides approximately 5 hrs. operation)
- HM-400 Under-cabinet hinge mount (shown below)
- MB-3 ABS desk stand (shown above)
- WM-302 Wall mount with swing arm & 4-way (shown below)



HM-400



WM-302

Display: 8" (diagonal) TFT LCD active matrix
 Back Light: Built-in 2 CCFT
 Input Signal: NTSC/PAL
 Resolution: 1440(H) x 468(V) dots
 Dot Pitch: 0.112(H) x 0.252(V)mm
 Brightness rating: 300 cd/m²(Nit)
 Contrast Ratio: 350:1
 Number of Pixels: 673,920 Dots
 Viewing angle L/R/T/B: 50/50/15/35
 Colors: 262,144

Color Configuration: Stripe

LCD-801: Power Requirements: 12 ~ 24VDC, 2000mA, + pin

LCD-800: Power Requirements: 12 ~ 24VDC, 1A, + pin

LCD-801: Power Consumption: 10 W (max)

LCD-800: Power Consumption: 15 W (max)

Video Input Level: 1.0 V P-P (positive) 75 Ohm

LCD-801: Dimensions (WHD): 209 x 159 x 32mm / 8.2" x 6.3" x 1.3"

LCD-800: Dimensions (WHD): 192 x 144 x 29mm / 7.6" x 5.7" x 1.1"

LCD-800D Dimensions (WHD): Occupies 4 RU (7") x 1.5"

Actual visible screen size (WH): 161.28 x 117.94mm / 6.3" x 4.6"

Operating temperature: 50 ~ 104°F or 10 ~ 40°C

Storage temperature: -25 ~ 140°F or -32 ~ 60°C

Operating/Storage Humidity: 85% RH (max.)

Connections: LCD-801: Cable w/ RCA video IN,

2.1mm DC IN jack,

and cable w/ S-Video jack

LCD-800 / 800D: Mini DIN cable w/ RCA video IN,

BNC video IN/OUT, S-Video

2.1 DC IN jacks

LCD-801 Weight: Net: 650 g, 22.8 oz. / Gross: Est. 2.3 kg / 5 lbs.

LCD-800 Weight: Net: 1.64 kg./ 3.61 lbs. / Gross: 2.8 kg. / 6.1 lbs.

LCD-800D Weight: Net: Est. 3.2 kg. / 7lbs. / Gross: 4.4 kg. / 9.7 lbs.

LCD-800L Weight: Net: 1.64 kg./ 3.62 lbs. / Gross: 2.88 kg. / 6.35lbs.

GSA Schedule

GS-07F-0069L, SIN: 246-42(1), 246-50

Specifications subject to change without notice

©2008 ToteVision

30K

Available through:

The Biggest Thing in Little LCD Monitors

LCD-642 LCD-642D LCD-640

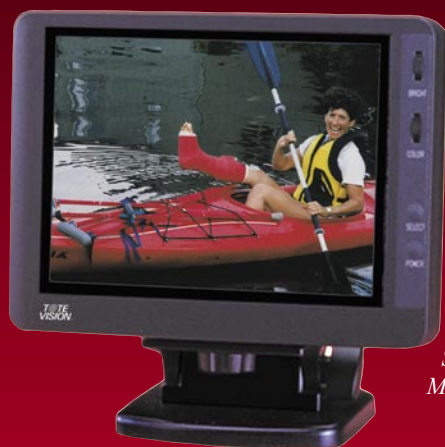

LCD-642
monitor with 2 Video inputs
and LED indicators

*Shown with
MB-1 optional
desk stand*



LCD-640
monitor with audio



*LCD-642 shown with
Flush Mount Kit*



LCD-642D Dual 19" Rack Mount Unit

Active Matrix 6.4" Color LCD Monitor

- Slim space saving design
- For color and B&W applications
- Low power consumption
- Case made of durable ABS plastic
- Compact and light weight for easy installation or mobile use
- Active matrix technology allows wide viewing angle
- Active matrix technology eliminates distortion
- A/C adaptor Part No. AC-2000 included
- For LCD-642 mirror image capable (order optional Part No. LCD-642RCBL)

Optional Accessories

| | |
|-------------|---|
| BB-5000 | Metal bracket for Anton-Bauer battery for LCD-642 |
| BP-563 | Rechargeable 2600mAh battery pack Provides approximately 5 hrs. of operation |
| DC-12 | Car Cord |
| DC-12D | Dual Car Cord |
| HS-1 | Hot Shoe mount |
| LCD-642RCBL | Cable to affect mirror image for LCD-642 |
| LM-642 | Flush mount kit, black metal 9.1"(W) x 8.3"(H) x 0.8"(D) Installer's Cut-Out: 7.1" (W) x 5.4" (H) |
| MB-1 | Desk Stand (shown above) |
| MB-72M | Mounting Bracket |
| RM-642 | Dual rack mount panel, black metal 19"(W) x 7"(H) x 1.5"(D) (occupies 4 RU) • Included with LCD-642D rack mount kit order |
| TB-640 | Custom Totebag with sunshield for LCD-640 |
| WM-1 | Wall mount bracket |

Display: 6.4" TFT LCD active matrix

Back Light: Built-in CCFT

Input Signal: NTSC/ PAL (auto switching)

Dot Format: 960(H) x 234(V) dots

Dot Pitch: 0.416mm(H) x 0.136mm(V)

Brightness rating: LCD-642: 250 cd/m² (Nit)

LCD-640: 300 cd/m² (Nit)

Number of Pixels: 224,640 dots

Contrast Ratio: 150 : 1

Pixel Configuration: Stripe

Power Requirements: 12~24 VDC(ripple 0.5V p-p), 1000mA, + pin

Power Consumption: 8 W (max)

Input Signal Level: 1.0V P-P (positive) 75 Ohm

LCD-640: Audio IN: 100 ~ 300mv (RMS)

LCD-640: Audio output: 0.4W

LCD-640: Speakers: 1.5"

Viewing angle (L/R/T/B): 45/45/10/30 degrees

Dimensions (WHD): LCD-642: 180 x 135 x 35mm / 7.1" x 5.3" x 1.4"

LCD-640: 175 x 140 x 35mm / 6.8" x 5.5" x 1.4"

Actual visible screen size (WH): 130 x 98mm / 5.2" x 3.9"

Monitor Mounting: mounting pad with ¼-20 threaded socket

Operating temperature: 50~104°F or 10~40°C

Connections: DIN cable w/ 2 RCA video IN jacks (LCD-642),
DIN cable w/ BNC video and RCA audio (LCD-640),
2.1mm DC IN jack

Weight: LCD-642D: Net: 4.7 kg. / 10.4 lbs. Gross: 5.4 kg. / 12 lbs.

LCD-642: Net: 500g/17.5oz. Gross: 1.4 kg. / 3.1 lbs.

LCD-640: Net: 0.6 kg. / 1.2 lbs. Gross: 1.2g. / 2.6 lbs.



Schedule For LCD-642D only.
GS-07F-0069L, SIN: 246-42(1), 246-50

Specifications subject to change without notice ©2008 ToteVision 30K

Available through:

The Biggest Thing in LCD Field Monitors

LCD-565 LCD-562



LCD-565



*Side View
shown with MB-1
desk stand*



**LCD- 562
Unit with Audio**

Active Matrix 5.6" Color LCD Monitor

• **BNC IN/OUT jacks located on top for easy access (with self-termination feature)**

NEW • **LED backlight provides longer life, uses less power and provides better color saturation**

- Battery pack for field monitor use included
- Ideal for troubleshooting system setup/fault location
- Switch for Auto/Manual color adjustment
- Low power consumption
- Case made of durable ABS plastic
- Manual controls for tint, color, brightness (and audio volume for LCD-562)
- Battery pack provides approximately 5 ~ 6 hrs operation
- Snap-on battery pack holds 8AA or 10 NiCad rechargeable batteries (batteries not included)
- Response Time: 60ns/60ns (Rising/Falling)

LCD-562 Unit with Audio Capability (without BNC IN/OUT) shown in inset above.

Optional Accessories

- AC-2000 AC adaptor
- BP-563 Rechargeable 2600mh NiCad battery pack
Provides approximately 6 hrs. operation.
- DC-12 Car cord
- DC-12D Dual car cord
- HS-1 Hot Shoe mount
- MB-1 Desk Stand (shown above in side view)
- MB-72M Metal Mounting Bracket
- TB-565 Custom Totebag with sun shield
- WM-1 Wall mount bracket

- Display: 5.6" a-Si TFT LCD active matrix
- Black Light: Built-in LED
- Input Signal: NTSC/PAL (automatically match)
- Dot Format: 960(H) x 234(V) dots
- Dot Pitch: 0.188mm(H) x 0.362mm(V)
- Brightness rating: 350 cd/m² (Nit)
- Number of Pixels: 224,640 Dots
- Contrast Ratio: 300 : 1
- Viewing angle L/R/T/B: 65°/65°/45°/65°
- Pixel Configuration: RGB Stripe
- Power Requirements: 11VDC ~ 14VDC, 500mA, +pin, - ground
- Power Consumption: 4.0 W (340mA @ DC 12V)
- Input Signal Level: 1.0V P-P (positive) 75 Ohm
- Dimensions w/ pack (WHD): 158 x 130 x 55mm / 6.2" x 5.1" x 2.2"
- Dimensions w/o pack (WHD): 158 x 130 x 42mm / 6.2" x 5.1" x 1.7"
- Actual visible screen size (WH): 113.3 x 85mm / 4.5" x 3.3"
- Monitor Mounting: Mounting pad with ¼ - 20 threaded socket
- Operating temperature: 10~104°F or 12~40°C
- Storage temperature: -13 ~ 140°F or -25 ~ 60°C
- LCD-565: Connections: BNC video IN/OUT (female) jacks
2.1mm DC IN jack
- Net Weight: LCD-562/565: 400g / 14.0 oz.
- Gross Weight: LCD-562: 0.7 kg/ 1.6 lbs
LCD-565: 0.6 kg/ 1.3 lbs.

**For Rechargeable Battery Pack
order BP-563
to go in TB-565 tote bag**

The Biggest Thing in Small LCD Monitors

LCD-560
LCD-560L
LCD-560LX
LCD-560X3

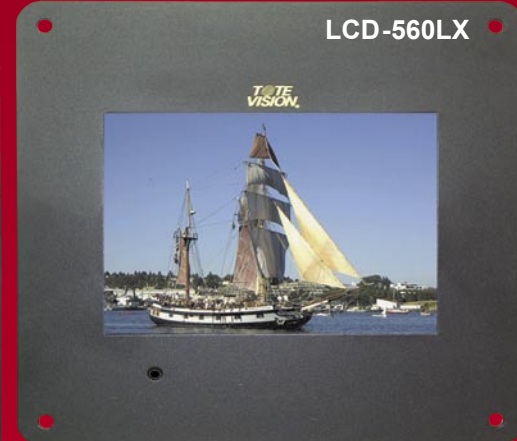

LCD-560 Back View

Video Cable

LCD-560X3 Triple Rack Mount Unit

Active Matrix 5.6" Color LCD Monitors

NEW

• LED backlight provides longer life, uses less power and provides better color saturation

- LCD-560 and LCD-560L features 2 composite video inputs with front controls for channels A & B, contrast, tint, color, brightness, and power
- LCD-560 and LCD-560 DIP switches allow user to select mirror image or Up/Down image for both channels A and B, and "auto ON with power" feature
- LCD-560X3 tilts 90° in 19" rack for optimum viewing, occupies 3 rack units
 - Composite video passive loop through capability for all 3 monitors (always active regardless of power). Loop out termination is provided.
 - Self-powered 3 color tally system
 - Front controls: contrast, tint, color, brightness, power, video, S-Video
- Broadcast quality display by auto termination switch in the BNC connector
- LCD-560LX: Rear controls: contrast, tint, color, brightness
 - Front control for power can be disabled by DIP switch
- For color and B&W applications
- Low power consumption
- LCD-560 and LCD-560L cases made of durable steel
- LCD-560X3 case made of durable aluminum & steel
- Active matrix technology allows wide viewing angle
- Active matrix technology eliminates distortion
- Response Time: 22ms
- 1/4-20 mounting pad included for LCD-560
- VESA 75mm compliant
- AC adaptor included.

LCD-560L/LX Flush Mount Kits

Installer's Cut-out (WH): 140 x 134mm / 5.5" x 5.25"

Display: 5.6" TFT LCD active matrix

Back Light: LED

Input Signal: NTSC/PAL (auto sensing)

Resolution: 960(H) x 234(V) dots

Dot Pitch: 0.118(H) x 0.362(V)

Brightness: 350 cd/m² (Nit)

Contrast Ratio: 300:1

Viewing angle L/R/T/B: 65/65/55/55

Power Requirements: 10 ~ 15 VDC, 0.4 A @ 12 VDC

Power Consumption: 5 W

LCD-560: Dimensions (WHD): 134 x 134 x 21mm / 5.3" x 5.3" x 0.8"

LCD-560L / LCD-560LX: Dimensions (WHD): 174 x 175 x 22mm / 6.8" x 6.8" x 0.9"

LCD-560X3: Dimensions (WHD): 432 x 132 x 50mm / 19" x 5.2" x 2", 3RU

Actual visible screen size (WH): 114 x 87mm / 4.5" x 3.4"

Operating temperature: 50 ~ 104°F or 10 ~ 40°C

Storage temperature: -13 ~ 140°F or -25 ~ 60°C

LCD-560 / LCD-560L Connectons: Cable w/ 2 female BNC and one 2.1mm DC inputs

LCD-560X3 Rear Connectons: BNC video IN/OUT jacks x 3

S-Video IN/OUT jacks x 3

15-pin DB for tally system

2.1mm DC IN jack

LCD- 560: Weight: Net: 400g / 14 oz.

Gross: 0.88 kg. / 1.95 lbs.

LCD- 560L/LX: Weight: Net: 700g / 24.6 oz.

Gross: 0.9 kg. / 2 lbs.

LCD- 560X3: Weight: Net: 2.5 kg. / 5.2 lbs.

Gross: 2.7 kg. / 5.85 lbs.

GSA Schedule

GS-07F-0069L, SIN: 246-42(1), 246-50

Specifications subject to change without notice

©2008 ToteVision

20K~30K

Download from www.Somanuals.com. All Manuals Search And Download

1319 Dexter Ave. N. • Ste. 020 • Seattle, WA 98109

Tel: 206-623-6000 • FAX: 206-623-6609

Email: sales@totevision.com

<http://www.totevision.com>

**TOTE
VISION**

The Biggest Thing in Little LCD Monitors

LCD-501 LCD-501X3



LCD- 501X3
Triple 19" Rack Mount

Active Matrix 5" Color LCD Monitor



LM-BR-501
Unit in Brass Flush Mount Kit



LCD- 501

- Wide operating power range (10 ~ 30VDC)
- Picture on demand/power saving feature
- Front mounted stereo headphone jack for private listening (no built-in speakers)
- Slim space saving design
- For color and B&W applications
- Compact and light weight for easy installation or mobile use
- Low power consumption
- Case made of durable ABS plastic
- Active matrix technology allows wide viewing angle
- Active matrix technology eliminates distortion
- Front controls for color, brightness and audio volume
- A/C adaptor, Part No. AC-2000, included

Optional Accessories

| | |
|-----------|--|
| BB-5000 | Metal bracket for Anton-Bauer battery |
| BP-563 | Rechargeable 2600mAH battery pack provides approximately 5 hrs. of operation |
| DC-12 | Car Cord |
| DC-12D | Dual Car Cord |
| HS-1 | Hot Shoe mount |
| LM-BR-501 | Brass Flush Mount Kit (see above) Requires rear access to install. Dimensions (WH): 5.82" x 5.43" Installer's cut-out: 5.15"(W) x 4.44"(H) |
| MB-1 | Desk Stand |
| MB-72M | Metal Mounting Bracket |
| RM-501 | EIA Rack Mount Panel, black metal (shown above) 19"(W) x 5.3"(H) x 0.8"(D) (occupies 3 RU) Holds 3 monitors. |
| WM-1 | Wall mount bracket |

- Display: 5" TFT LCD active matrix
- Back Light: CCFT
- Input Signal: NTSC/PAL (auto switching)
- Resolution: 600(H) x 234(V) dots
- Active Area: 102.6(H) x 73.9(V)
- Dot Pitch: 0.171(H) x 0.316(V)
- Brightness rating: 240 cd/m² (Nit)
- Number of Pixels: 140,400
- Contrast Ratio: 120:1
- Viewing angle L/R/T/B: 55°/55°/15°/35°
- Pixel Configuration: Stripe
- Power Requirement: 12VDC (1A, + pin)
- Operating Power Range: 10 ~ 30 VDC
- Power Consumption: 7 W (max.)
- Input Signal Level: 1.0V P-P (positive) 75 Ohm
- Audio Input Level: 1.0V P-P
- Audio output: 0.3 W
- Audio Input Impedance: 10K ohm
- Audio Band Width: 15 KHz
- Dimensions (WHD): 146 x 105 x 30.5mm / 5.7" x 4.1" x 1.2"
- Actual visible screen size(WH): 102 x 74mm / 4" x 2.9"
- Monitor Mounting: Mounting pad with ¼-20 threaded socket
- Operating temperature: 50 ~ 104°F or 10 ~ 40°C, 85% RH max.
- Storage temperature: -4 ~ 140°F or -20 ~ 60°C, 85% RH max.
- DIN Cable Connections: RCA video IN
RCA right audio IN
RCA left audio IN
2.1 DC IN jack
- LCD-501 Weight: Net: 363g / 12.8oz.
Gross: 1.2 kg. / 2.7 lbs.
- LCD-501X3 Weight: Net: 2.4 kg / 5.3 lbs.
Gross: Est. 5.3 kg. / 11.8 lbs.

GSA Schedule For LCD-501X3 only.
GS-07F-0069L, SIN: 246-42(1), 246-50

Specifications subject to change without notice ©2008 ToteVision 10K
Available through:

The Biggest Thing in LCD Field Monitors

LCD-411 LCD-410



LCD-411
Monitor with BNC

Active Matrix 4" Color LCD Monitor



Right Side



Left Side



LCD-411
Shown with optional
MB-1 desk stand



LCD-410
Monitor with Audio

• **BNC IN/OUT jacks located on top for easy access (with self-termination feature)**

NEW • **LED backlight provides longer life, uses less power and provides better color saturation**

- Battery pack for field monitor use included
- Ideal for troubleshooting system setup/fault location
- Snap on battery pack holds 8AA Alkaline or 9 Nicad rechargeable batteries (batteries not included)
- Controls for tint, color, brightness (and audio volume for LCD-410)
- Case made of durable ABS plastic
- Battery pack provides 5.5hrs operation (approximately)
- Response Time: 30ms/50ms (Rising/Falling)

LCD-410 Unit with Audio Capability (without BNC IN/OUT) shown in inset above.

Optional Accessories

- AC-1000 A/C adaptor
- BP-563 Rechargeable 2600mAH battery pack provides approximately 7 hrs of operation.
- DC-12 Car Cord
- DC-12D Dual Car Cord
- HS-1 Hot Shoe mount
- MB-1 Desk Stand (shown above)
- MB-72M Metal mounting bracket
- TB-410 Custom Totebag with sun shield
- WM-1 Wall mount bracket

Display: 4" TFT LCD active matrix

Back Lights: Built-in LED

Input Signal: NTSC/PAL

Resolution: 383(H) x 234(V) dots

Dot Pitch: 0.214(H) x 0.234(V)

Brightness Rating: 300 cd/m² (Nit)

Contrast Ratio: 150:1

Viewing angle L/R/T/D: 45/45/30/10.

Power Requirements: 12VDC, 380mA, + pin

Power Consumption: 5 W

Dimensions w/ pack (WHD): 145 x 117 x 58mm / 5.7" x 4.6" x 2.3"

Dimensions w/o pack (WHD): 145 x 117 x 45mm / 5.7" x 4.6" x 1.8"

Actual visible screen size (WH): 82 x 62mm/ 3.2" x 2.4"

Monitor Mounting: Mounting pad with ¼-20 threaded socket

Operating temperature: 50~104°F or 10~40°C

Storage temperature: -13 ~ 140°F or -25 ~ 60°C

LCD-411: Connections: BNC video IN/OUT (female) jacks
2.1mm DC IN jack

Net Weight: 425g. / 15oz.

Gross Weight: 0.61 kg. / 1.35 lbs.

**For Rechargeable Battery Pack
order BP-563
to go in TB-410 tote bag**

LCD-400X4

The Biggest Thing in Rack Mounted Monitors



Back View

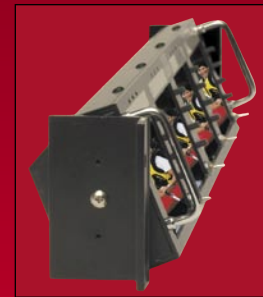

Side View

4" LCD in Quad Rack Mount Kit

NEW

LED backlight provides longer life, uses less power and provides better color saturation

- Broadcast quality display
- Space saving design - occupies only 2 RU
- Tilts 90° in the rack for optimum viewing
- Front controls for power, contrast, tint, color, brightness and NTSC/PAL selection
- Composite video loop through capability for all 4 monitors (always active regardless of power). Loop out termination is provided by auto termination switch in the BNC connector
- Self-powered 3 color tally system
- For color and B&W applications
- Low power consumption
- Case made of durable aluminum & steel
- Active matrix technology allows wide viewing angle
- Active matrix technology eliminates distortion
- Single A/C adaptor power supply provides power for all 4 monitors (included)
- Response Time: 10ms/10ms (Rising/Falling)

Display: 4" TFT LCD active matrix

Back Light: Built-in LED

Input Signal: NTSC/PAL Switchable

Resolution: 480(H) x 234(V) dots

Dot Pitch: 0.171(H) x 0.264(V)

Brightness: 300 cd/m² (Nit)

Contrast Ratio: 150:1

Viewing angle L/R/T/B: 45/45/30/10

Power Requirements: 12VDC, 1.5A, + pin

Power Consumption: 60 W

Dimensions (WHD): 482 x 89 x 50mm / 19" x 3.5" x 2"

Actual visible screen size (WH): 82.1 x 61.8mm / 3.2" x 2.4"

Operating temperature: 50 ~ 104°F or 10 ~ 40°C

Storage temperature: -13 ~ 140°F or -25 ~ 60°C

Connectons: BNC video IN jack x 4

BNC video OUT jack x 4

2.1mm DC IN jack

Net Weight: Est. 2.3 kg. / 5 lbs.

Gross Weight: Est. 2.4 kg. / 5.2 lbs.

GSA

Schedule

GS-07F-0069L, SIN: 246-42(1), 246-50

Specifications subject to change without notice

©2008 ToteVision

30K

Available through:

P.30

Download from www.Somanuals.com. All Manuals Search And Download

1319 Dexter Ave. N. • Ste. 020 • Seattle, WA 98109
Tel: 206-623-6000 • FAX: 206-623-6609

E-mail: sales@totevision.com
<http://www.totevision.com>



ATSC-100



Front View

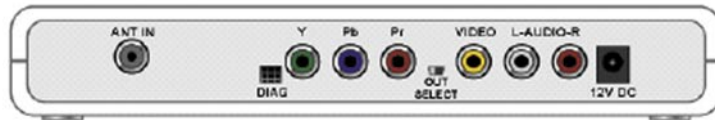

Rear View

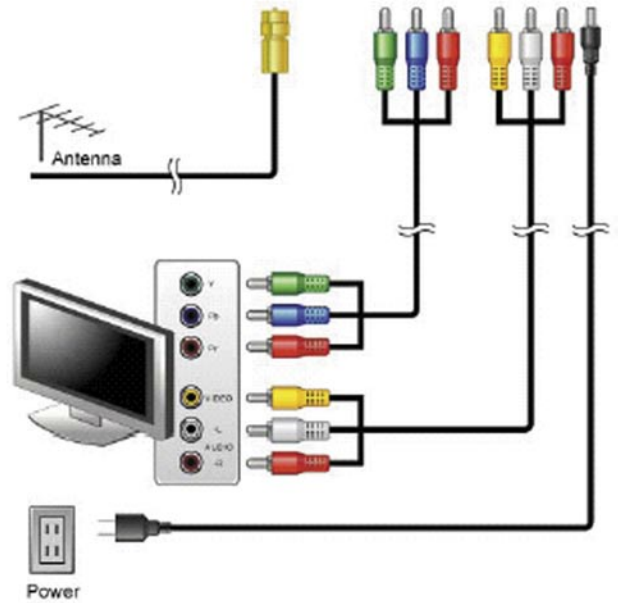

Stand Alone ATSC/NTSC/QAM Receiver

- ATSC/NTSC/Clear QAM receiver
- Tunes and decodes all 18 approved ATSC DTV broadcast formats
- Selectable DTV output resolution (480i/480p/720p/1080i)
- Standard definition NTSC 480i output
- Aspect ratio control 4:3 and 16:9 mode
- Component (YPbPr) and composite (CVBS) video outputs
- Remote control
- Stereo analog audio output
- On-Screen Menu
- Advanced Electronic Program Guide
- V-CHIP & Closed Captioning from ATSC and NTSC source
- Support English, French, Spanish multi-languages
- Compact size

▼ RF Inputs

| | |
|------------------------|---|
| Digital off-air (ATSC) | ATSC reception of broadcast physical channels 2-69 / tuning frequency 55.25 to 859.25 MHz |
| Analog off-air (NTSC) | NTSC reception of broadcast physical channels 2-69 / tuning frequency 5.25 to 859.25 MHz |
| Cable TV (NTSC/QAM) | NTSC reception of cable channels 2-125 (STD) and 1-125 (HRC, IRC) |
| Input Impedance | 75 Ω female F-Connector |
| Bandwidth | 6 MHz |
| Demodulator | 8 VSB |
| ATSC TOV (Sensitivity) | Min. -80dBm Max. -8dBm |

▼ Video

| | |
|--------------------------------|--|
| Formats | MPEG-2 Compatible MP@HL |
| Aspect Ratio | 4:3, 16:9 |
| Picture Resolution / TV Format | Selectable 1080i/720p/480p/480i/ All 18 ATSC DTV format |
| Video Output | CVBS, YPbPr |
| Composite (CVBS) | CVBS Level: 1Vpp ± 10% @ external 75 Ω impedance |
| Component (YPbPr) | Y Level: 1 Vpp ± 10% @ external 75 Ω impedance Pb Level: 0.7Vpp ± 10% @ external 75 Ω impedance, DC Couple Pr Level: 0.7Vpp ± 10% @ external 75 Ω impedance, DC Couple |

▼ Audio

| | |
|--------------------------|-------------------------------------|
| Decode | MPEG-1 (Layer I & II), AC-3 |
| Sampling Rate | 32 KHz, 44.1 KHz, 48KHz |
| Output | Stereo, mono-LR |
| Left/Right Channel Level | 2Vpp 10% @ internal 10K Ω impedance |

▼ Applications & Software

| | |
|--------------------------|------------------------------|
| On-Screen Menu | Supported |
| Graphical Menu | 256 indexed true color |
| OSD transparency setting | 5 levels |
| Closed Caption | EIA-708B & EIA-608 |
| V-CHIP | Support MPAA, USTV (EIA-766) |
| Electronic Program Guide | 16-day EPG |

▼ Physical & Hardware

| | |
|-------------------|--|
| Dimensions | L (215 mm) x W (128.5mm, exclude connectors) / W (140mm, include connectors) H (37 mm, exclude rubber foot) / H (40mm, include rubber foot) |
| Power Supply | +12VDC |
| Power Consumption | 12 Watts (Max.) |

**Celebrating
More Than
25 Years
of
Customer-Focused
Solutions**



Free Manuals Download Website

<http://myh66.com>

<http://usermanuals.us>

<http://www.somanuals.com>

<http://www.4manuals.cc>

<http://www.manual-lib.com>

<http://www.404manual.com>

<http://www.luxmanual.com>

<http://aubethermostatmanual.com>

Golf course search by state

<http://golfingnear.com>

Email search by domain

<http://emailbydomain.com>

Auto manuals search

<http://auto.somanuals.com>

TV manuals search

<http://tv.somanuals.com>