



10" / 12" / 14" Televisions

OWNER'S MANUAL & INSTALLATION GUIDE

LCD-1044TW / LCD-1212TW / LCD-1411TW



10" TV

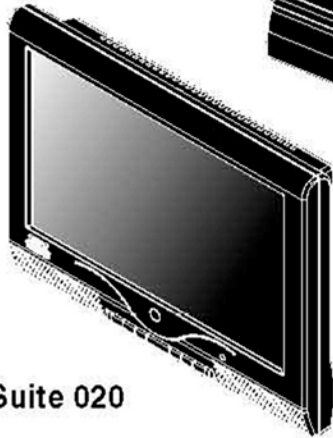

12" TV



14" TV

1319 Dexter Ave. N., Suite 020
Seattle, WA 98109
Tel: 206 623 6000
Fax: 206 623 6609
www.totevision.com

Important Notes :

1. Before operating the unit, please read these instructions carefully.
2. Retain this manual for future reference.
3. Do not remove any WARNING stickers on the unit.
4. You are advised to follow the instructions carefully when operating the unit.
5. Do not use any chemical solvent, cleaning agent or corrosive detergent to clean away dirt on the surface of the screen. By doing so, you may cause irreversible damage to the surface of the TFT screen. To clean off dirt or fingerprints, we recommend the use of a soft damp lens cleaning cloth.
6. Using spare parts from another manufacturer may caused permanent damage to the unit.
7. Place the unit on a flat, hard and stable surface.
8. Avoid installing the monitor screen in a position that is under direct sunlight and place unit away from hot air vent.
9. Install unit in a dry location away from condensation.
10. Keep ventilation areas clear to allow unit to cool properly.
11. Ensure the plugs are properly plugged in before operating the unit.
12. Should the LCD panel be broken, avoid all human contact with the broken glass or fluid leaking out from the enclosure. If you come into contact, flush and clean affected areas with plenty of water. Seek medical attention immediately.
13. When operating the display unit, avoid touching or pressing on the LCD glass panel. Excessive force may cause irreparable damage to the LCD screen.

CONTENTS :

1. INTRODUCTION	
Overview	01
2. PRODUCT SPECIFICATION	
Basic Specifications and Safety Precautions	02
3. 10"/12"/14" CONTENTS / ACCESSORIES	03
4. FRONT PANEL CONTROL	
10" Panel Control and Input/Output	04
12" Panel Control and Input/Output	05
14" Panel Control and Input/Output	06
5. GUEST REMOTE CONTROL FUNCTION	07
6. INSTALLATION GUIDE	
10"/12"/14" Input (RCA) AV	08
10"/12"/14" Output (RCA) to Other AV Equipment	09
7. BASIC FUNCTIONS	
10"/12"/14" Power Signal	11
10"/12" Mode	12
10"/12"/14" Volume Setting	13
10"/12"/14" Channel Search	14
TV Station Memory Mode (Master Remote Control only)	15
8. OSD MENU SETTING (Master Remote Control only)	
Input Menu	16
Menu Setting	16
The Electronic Program Guide	16
Picture	17
Audio	18
Tune	19
Setup	21

CONTENTS :

9. BASIC SPECIFICATIONS	
10" Panel Specs	22
General Specifications	22
12" Panel Specs	23
General Specifications	23
14" Panel Specs	24
General Specifications	24

ONE YEAR LIMITED WARRANTY

Overview :

Congratulations on your purchase. We are committed to bringing you the most technologically advanced products available, and we are pleased that you chose our product. The 10"/12"/14" televisions provide all necessary functions for your viewing pleasure.

This system incorporates the use of screen display menu controls that allow you to configure the system to suite your own preferences.

Basic Specification :

1. 10" (4:3) /12"(16:9) /14" (4:3) Color Active Matrix TFT LCD display
2. Digital Off-Air (ATSC) : ATSC Reception of Broadcast Channels 2-69
3. Analog Off-Air (ATSC) : NTSC Reception of Broadcast Channels 2-69
4. Cable TV (ATSC) : Reception of Cable Channels 2-125 (STD) and 1-125 (HRC, IRC)
5. Built-in left and right stereo speakers
6. AC/DC power adaptors
7. Wall mounting capability

Safety Precautions :

1. Ensure the plug is securely plugged into the main socket before operating the unit.
2. Ensure the Voltage on the main socket is the same as specified on the unit.
3. In the event of thunder & lightning or when not using the unit for a long period of time, remove the plug from the main socket for safety.
4. Do not plug in too many appliances together with this unit to prevent overloading the power supply.
5. Use parts only manufactured by authorized manufacturers.

In case of the following emergencies, remove plug from the main socket immediately:

1. Plug or cables are damaged.
2. Any form of foreign objects dropped inside the enclosure.
3. Unit is being exposed to rain and/or water.
4. Unit unable to operate under normal operation.

Note: The monitor will take about 15 seconds to turn on when you first plug in the power, and, after that, it will only take 1 to 2 seconds if the plug is left plugged into the electrical outlet.

(Please check the content of the Package.)

10.4" Monitor

(LCD-1044TW)

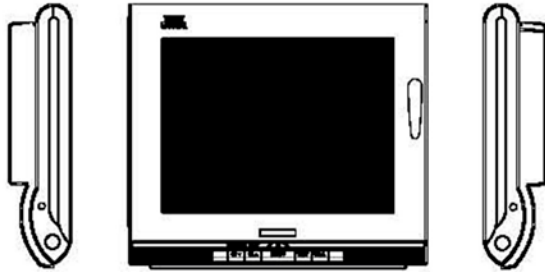

12" Monitor

(LCD-1212TW)

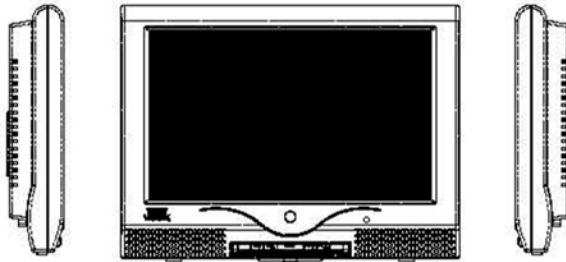

14.1" Monitor

(LCD-1411TW)

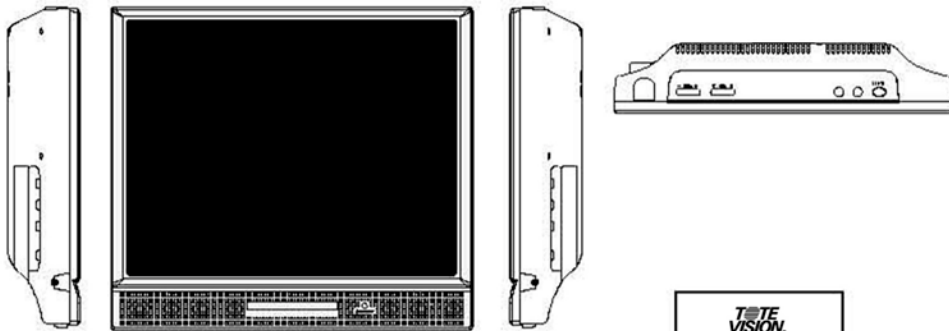

Remote Control



User Manual

Monitor

10.4" PANEL CONTROL : (TV-1044TW)

- | | |
|--------------------------|----------------------------|
| 1. LCD Monitor | 5. Volume/Menu Down button |
| 2. Remote Sensor | 6. On/Off button |
| 3. Speakers | 7. TV channel up button |
| 4. Volume/Menu Up button | 8. TV channel down button |
| | 9. Power/Stand by LED |

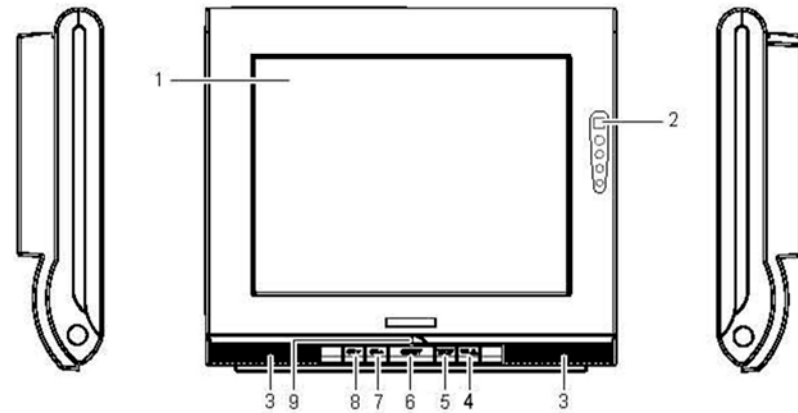

INPUT/OUTPUT :

- 10. Audio L(Output)
- 11. Audio R(Output)
- 12. Video(Output)
- 13. Audio L(Input)
- 14. Audio R(Input)
- 15. Video(Input)

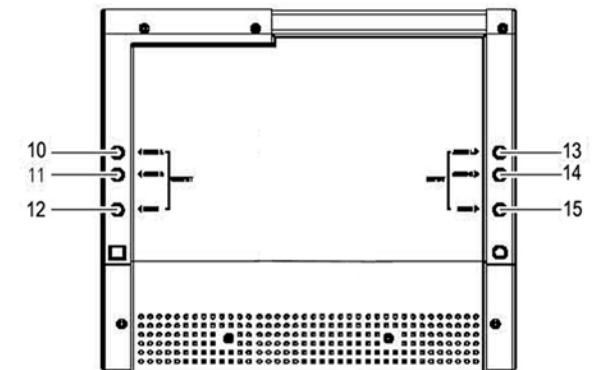

12" PANEL CONTROL : (LCD-1212TW)

PANEL CONTROL :

- | | |
|---------------------------|----------------------------|
| 1. LCD Monitor | 6. TV channel up button |
| 2. Nameplate | 7. On/Off button |
| 3. Speakers | 8. Volume/Menu Down button |
| 4. Remote Sensor | 9. Volume/Menu Up button |
| 5. TV channel down button | 10. Power/Stand by LED |

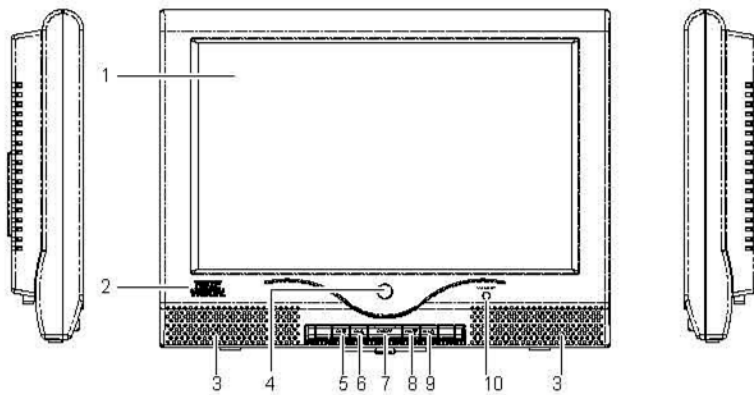

INPUT/OUTPUT :

- 12. Audio R (Output)
- 13. Audio L (Output)
- 14. Video (Output)
- 15. Audio R (Input)
- 16. Audio L (Input)
- 17. Video (Input)

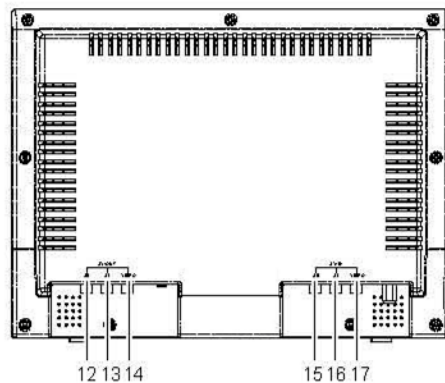

14.1" PANEL CONTROL : (LCD-1411TW)

PANEL CONTROL :

- | | |
|-----------------------|------------------------------|
| 1. LCD Monitor | 4. Volume Up/Down button |
| 2. Power/Stand by LED | 5. TV channel Up/Down button |
| 3. Speaker | 6. Power button |

INPUT/OUTPUT :

- 7. AV Input
- 8. AV Output

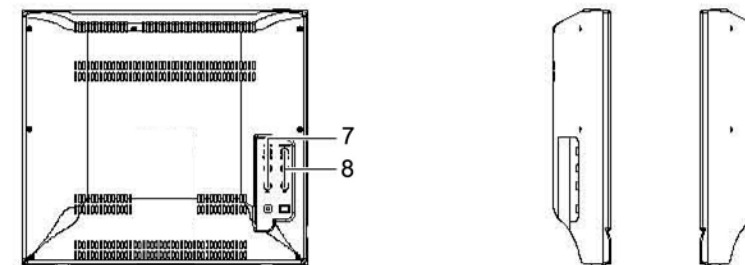
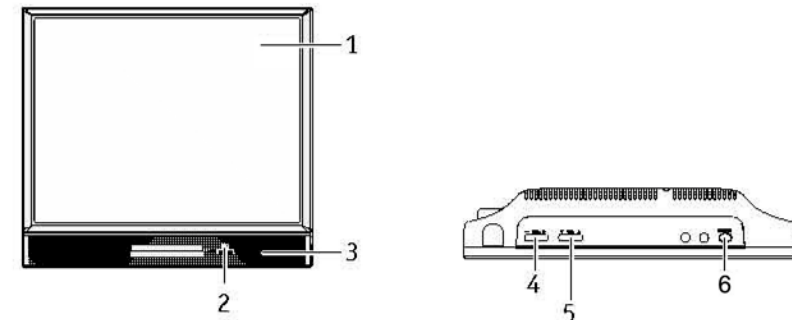

(When using the remote control, point it towards the IR sensor.)

Guest Remote Control

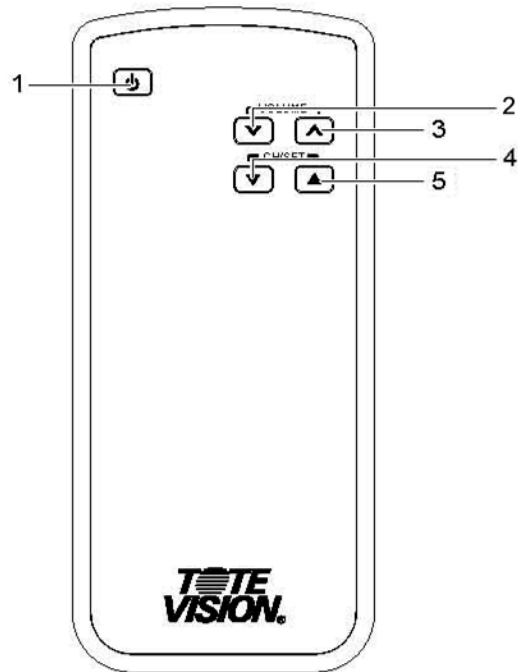

1. POWER : Power On/Off
2. VOL : Decrease Volume Button
3. VOL : Increase Volume Button
4. CH/ SET : Channel/Setting Up Button
5. CH/ SET : Channel/Setting Down Button

Connecting to an AV IN Source :

1. This unit is able to support various input settings. You can connect your video recorder, amplifier, game console etc, to the unit, to enjoy high quality, digital audio-visual effects.
2. Connect your AV cable to the equipment.

10.4" INPUT (RCA) AV :

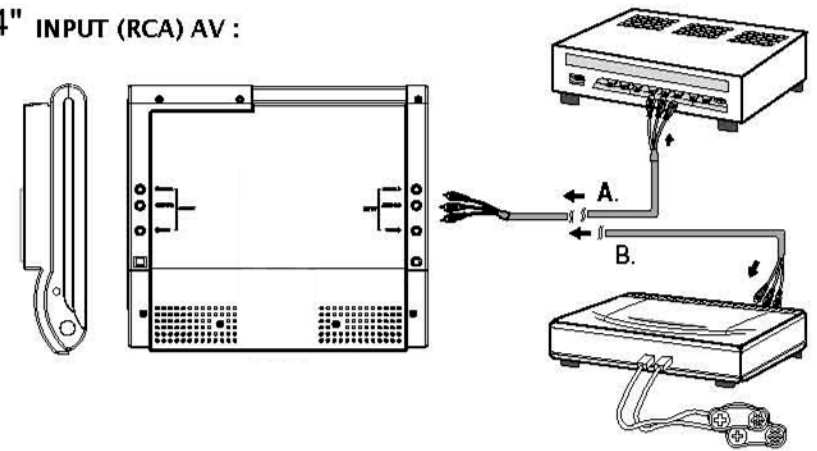

12" INPUT (RCA) AV :

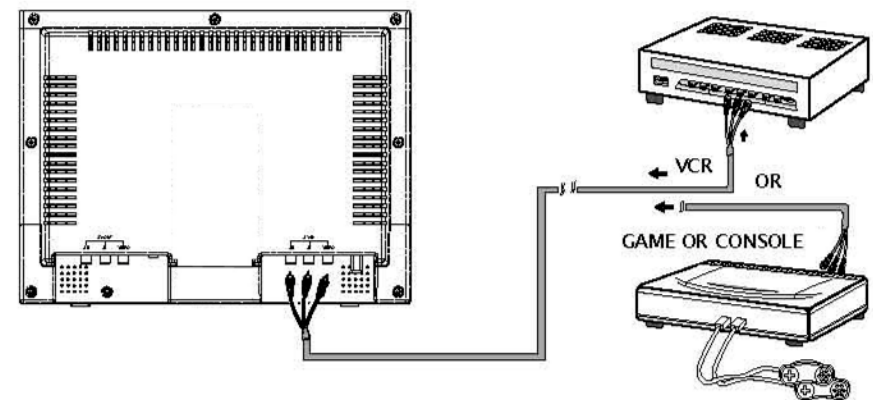

Connecting to an AV IN Source :

1. This unit is able to support various input setting. You can connect your video recorder, amplifier, game console etc, to the unit, to enjoy high quality, digital audio-visual effect.
2. Connect your AV cable to the equipment.

14.1" INPUT (RCA) AV :

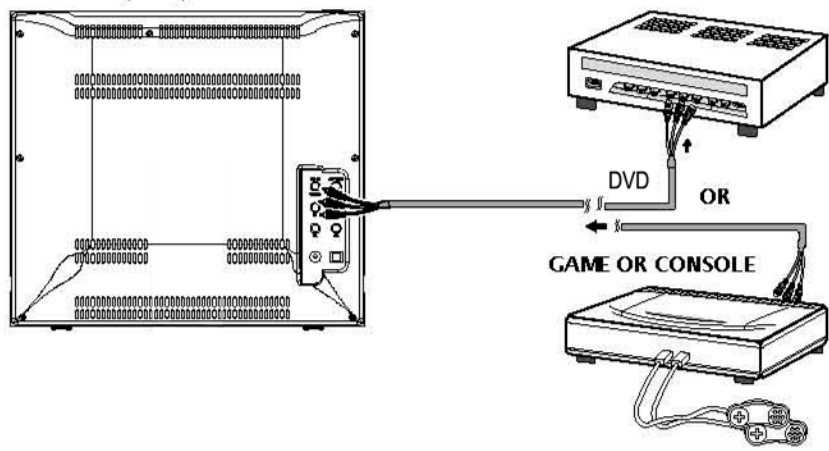

10.4" Output (RCA) to other AV Equipment :

Output the AV Signal using the unit AV output socket.

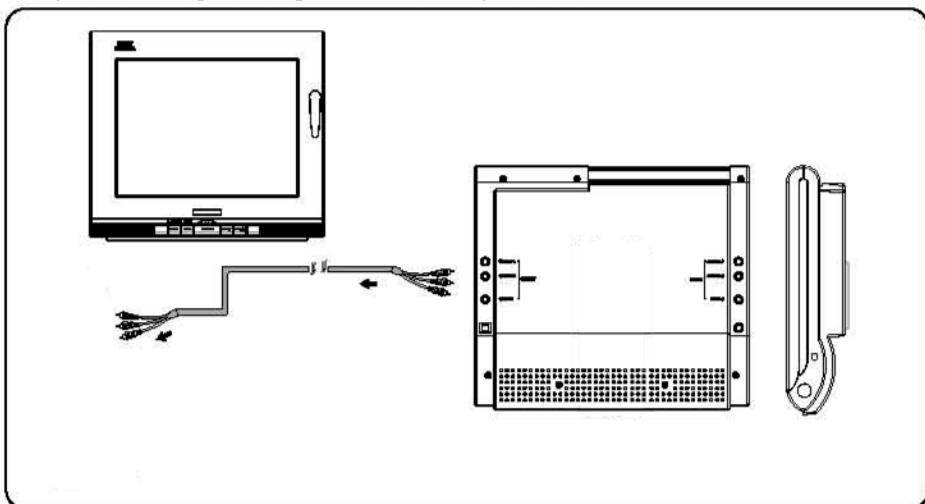

12" Output (RCA) to other AV Equipment :

Output the AV Signal using the unit AV output socket.

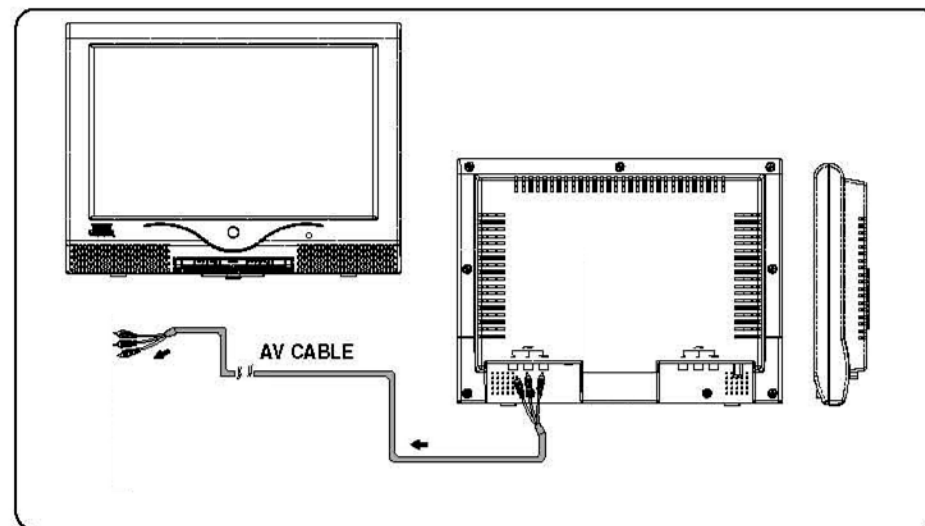

14.1" Output (RCA) to other AV Equipment :

Output the AV Signal using the unit AV output socket.

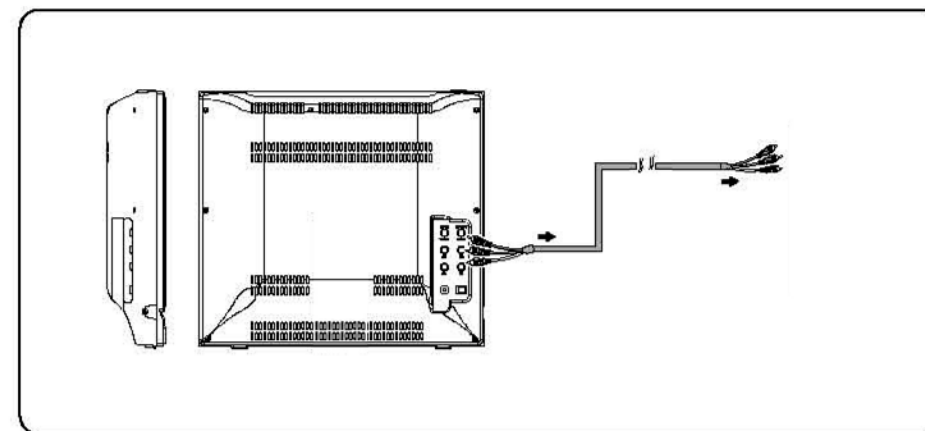

10.4" Power Signal :

1. POWER indication LED on unit turns RED in color indicating power is connected.
2. Press the ON/OFF button on control panel or power button on remote, the POWER indication LED on TV front control panel will turn GREEN in color.

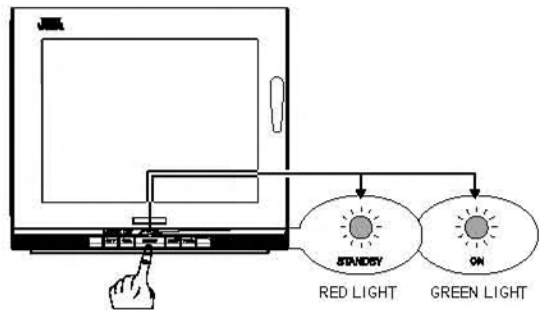
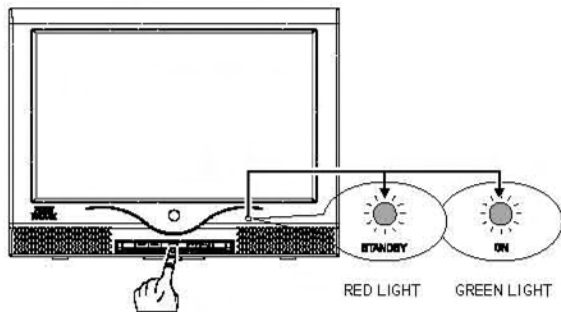
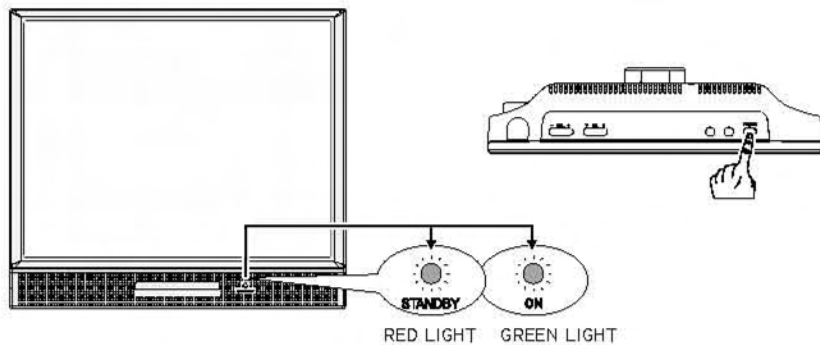
**12" Power Signal :****14.1" Power Signal :****10.4" Mode :**

1. Press the "Mode" button on remote or on front control panel to select from the various mode settings.
2. The mode setting status will change each time the "Mode" button is pressed – "TV-CVBS"

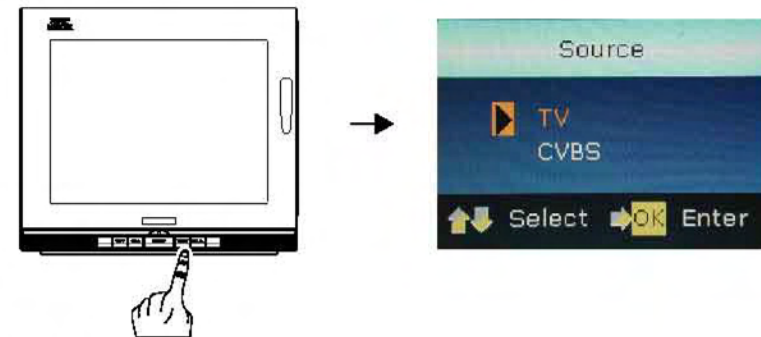
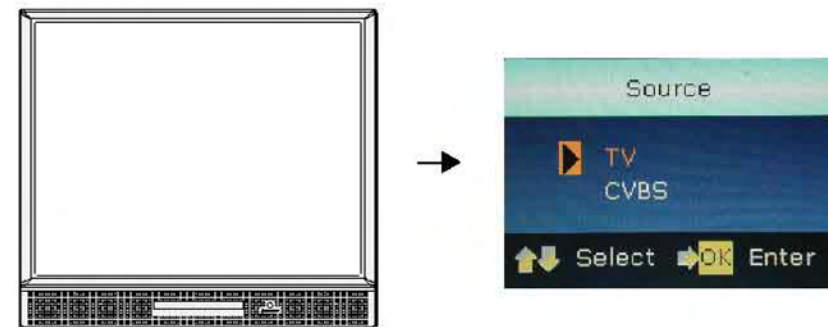
**14.1" Mode :**

10.4" Volume setting :

Press the "VOL ▲/▼" button on front control panel or "VOLUME ▲/▼" on remote to adjust the volume level.

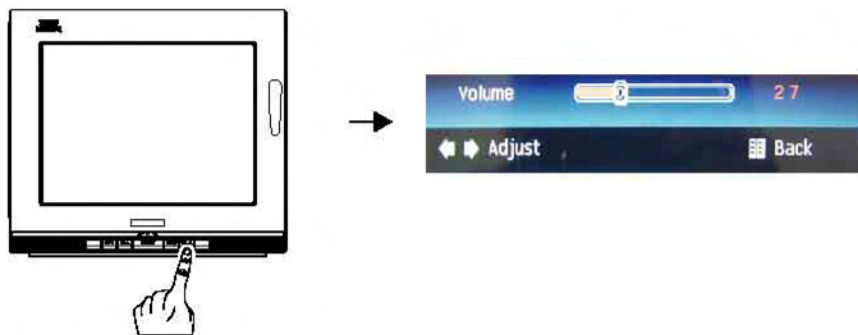

12" Volume setting :

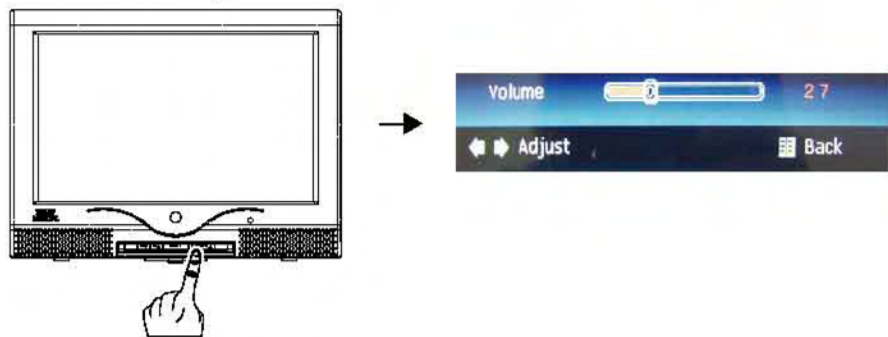

14.1" Volume setting :



10.4" Channel search :

1. Press the "CH ▲/▼" button on remote or the TV Front control panel to change/select channels.
2. Press on the number buttons on the remote control to change/select channel directly.

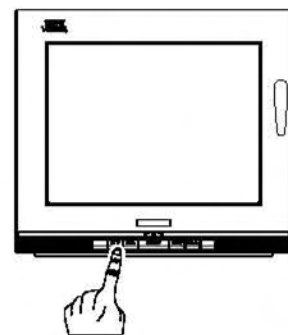

Guest Remote Control



12" Channel search :

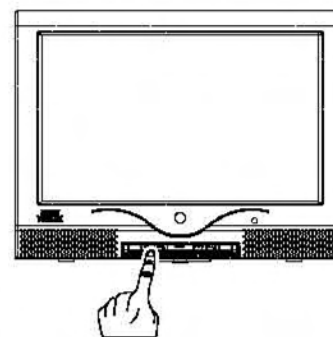

Guest Remote Control

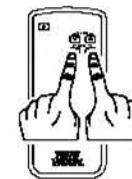

14.1" Channel search :

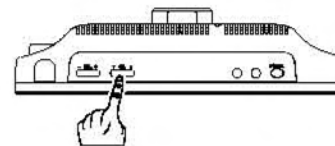

Guest Remote Control



Note: These functions are only available using Master Remote Control.

TV Station Memory Mode:

1. Under TV mode, select channel by using "CH/SET▲/▼" on remote (eg. CH01).
2. Press "ENTER" button on remote, main menu option will display on the screen as below:

CH	1
▶ ATV	2
ATV	3
ATV	4
ATV	5
ATV	6
ATV	7
ATV	8
ATV	9
ATV	10

↑↓ Select [OK] Enter

3. Use (▲/▼) button on remote to select to select memory number to be set. (total 15 memory)
4. Press "ENTER" to return to TV channel, the memory number has been set to be the most frequent selected channels (eg. CH01).
5. Repeat above steps to set all 15 favorite channels.
6. After all memory has been set, press the "MEMORY +/-" button on remote to select favorite channels.

Note: These functions are only available using Master Remote Control.

Input Menu :

To change the input source, press the "mode" button on the remote to display the Input Source menu. When the input menu is open, press the "mode" button again to switch to the next input or use the up/down arrows to scroll through the inputs and the press enter to confirm the highlighted input. The input menu will timeout after 3 seconds and switch to the input that is currently highlighted

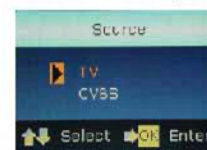

Menu Setting :

To select a sys menu, press ▲ / ▼ on the right side of the High Definition LCD TV or the ▲ / ▼ key on the remote control. This Unit provide the "OSD" setting, enable you to customize the setting for the following:



To display the OSD main menu, press the SYS MENU key on the remote control. Use the ◀ / ▶ keys to highlight the desired OSD Main Menu.

The Electronic Program Guide :

This High Definition LCD TV supports Electronic Program Guide (EPG) to help you navigate through all the possible viewing options. The EPG supplies information, such as program lists, the start and end times of all available channels, and a detailed description of the program. The availability and the amount of program details will vary depending on the broadcaster. You can select EPG from the TV OSD menu to display the Electronic Program Guide. The EPG begins its list with the channel that is currently active.

No.	Channel Name	12/31/99	Program Name
25-00			
26-00			
27-00			
28-00			
29-00			

- 1. Channel Number**
Shows the current physical channel number and all the available virtual channels.
- 2. Channel name**
Shows this channel name at this channel number.
- 3. Program Time Paragraph**
Displays the program times from start to end.
- 4. Program name**
Shows this program name at this channel.
- 5. Abstract**
Displays detailed information for the selected digital program. The availability of detailed information depends on the broadcaster.
- 6. Current Time and Date**
Shows the current time and date.

8. OSD Menu Setting :

p.17

Note: These functions are only available using Master Remote Control.

Picture :

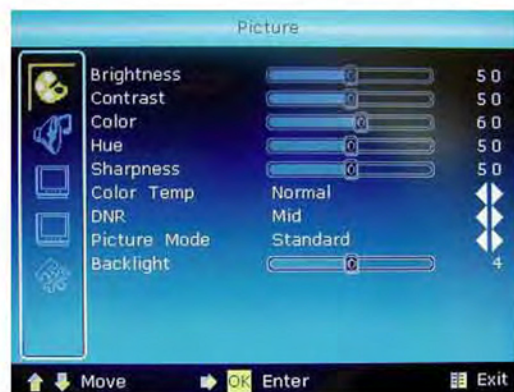

Function Name	Function
Brightness	Adjust the black level of the display.
Contrast	Adjust the white level of the display.
Color	Adjust the intensity of the colors.
Hue	Adjust the color towards either red or green.
Sharpness	Adjust the clarity of the picture.
Color Temp	Cool , Normal , Warm Color Temp selection.
DNR	OFF , Low , Hid Digital Noise Reduction selection.
Picture Mode	User , Vivid , Standard , Gentle Picture selection.
Backlight	Adjust the intensity of the lamp that illuminates the LCD TV.

8. OSD Menu Setting :

p.18

Note: These functions are only available using Master Remote Control.

Audio :



Function Name	Function
Bass	Adjust the amount of Bass in the audio.
Treble	Adjust the amount of Treble in the audio.
Balance	Adjust the left and right audio balance.
BTSC Mode	Multi-Channel Television Sound consists of three different settings. Select one of the following: <ul style="list-style-type: none"> • Mono • Stereo • SAP

8. OSD Menu Setting :

p.19

Note: These functions are only available using Master Remote Control.

Tune :

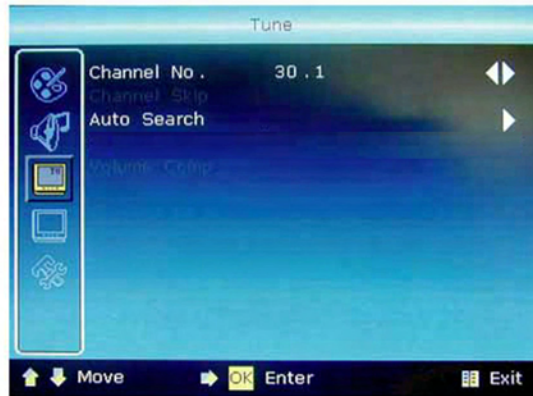

Function Name	Function
Channel No.	Channel selection.
Channel Skip	ON , OFF Skip the channel selection.
Auto Search	TV Channel Auto Search.

8. OSD Menu Setting :

p.20

Note: These functions are only available using Master Remote Control.

Tune :



Function Name	Function
DTV CC	Digital closed caption service selection for DTV.
DTV VCHIP2.0	Digital V-Chip Level control for DTV.
Def AudioLang	English , French , Spanish Audio Language selection.
DayLight Saving	ON , OFF , Auto DayLight Saving selection.
Timezone	Hawaii , Alaska , Pacific , Mountain , Central , Eastern Time zone selection.

*Above function is only for DTV.

8. OSD Menu Setting :

p.21

Note: These functions are only available using Master Remote Control.

Setup :



Function Name	Function
Language	Switches the language of the OSD to one of the following: <ul style="list-style-type: none"> • English
Sleep Time	Sets the High Definition LCD TV to turn off after a specified amount of time. <ul style="list-style-type: none"> • Off / 30 minutes / 60 minutes / 90 minutes / 120 minutes NOTE: The LCD TV will take a few seconds to come back from sleep mode.
OSD Timer	Sets the amount of time of inactivity before the OSD disappears.
Parental Control	Control V-Chip Level Password 0000.
Closed Caption	Analog closed caption service selection.
Reset	Resets all OSD menu settings (except parental controls) of the High Definition LCD TV back to the factory defaults.

9. Basic Specifications :

p.22

10.4" Panel Specs (LCD-1044TW) :

The LCD module has a TFT matrix type liquid crystal panel. Each pixel is divided into Red, Green and Blue sub-pixels or dots which are arranged in vertical stripes. The panel is intended to support displays where high brightness, wide viewing angle, high color saturation, and high color depth.

Screen diagonal	264mm (10.4")
Outline dimension	243(H) x 184(V) x 10.6(D) mm
Display Area	211.2(H) x 158.4(V) mm
Resolution	800(H) x 600 (V)
Pixel Pitch	0.264 (H) x 0.264 (V)
Pixel Arrangement	R.G.B Vertical Stripe
Typical White Luminance	400cd/m ²
Contrast Ratio	500:1 typ.
Viewing Angle	60(left),60(right),40(up),60(down)

General Specifications:

Input/Output	1 x AV Input / 1 x AV Output
OSD Language	English
Operating Voltage	AC110-230V 50/60Hz DC:10-16V 4A
Remote	Remote range: 5 Meters (15 feet)
TV Specification	Channel Scan: ATSC, NTSC and QAM channels TV Audio system: MONO / STEREO / SAP V-Chip: Both ATSC and NTSC are supported
Accessories	User manual / Remote control (w/BATTERY)

12" Panel Specs (LCD-1212TW) :

The LCD module has a TFT matrix type liquid crystal panel. Each pixel is divided into Red, Green and Blue sub-pixels or dots which are arranged in vertical stripes. The panel is intended to support displays where high brightness, wide viewing angle, high color saturation, and high color depth.

Screen diagonal	307mm (12.1")
Outline dimension	320 (H) x 240(V) x 52.5 (D) mm
Display Area	263.04(H) x 157.824(V) mm
Resolution	1280(H) x 768 (V)
Pixel Pitch	0.205 (H) x 0.205 (V)
Pixel Arrangement	R.G.B Vertical Stripe
Typical White Luminance	300cd/m ²
Contrast Ratio	600:1 typ.
Viewing Angle	30(left),30(right),20(up),10(down)

General Specifications:

Input/Output	1 x AV Input / 1 x AV Output
OSD Language	English
Operating Voltage	AC110-230V 50/60Hz DC:10-16V 4A
Remote	Remote range: 5 Meters (15 feet)
TV Specification	Channel Scan: ATSC, NTSC and QAM channels TV Audio system: MONO / STEREO / SAP V-Cltip: Both ATSC and NTSC are supported
Accessories	User manual / Remote control (w/BATTERY) /

14.1" Panel Specs (LCD-1411TW) :

The LCD module has a TFT matrix type liquid crystal panel. Each pixel is divided into Red, Green and Blue sub-pixels or dots which are arranged in vertical stripes. Gray scale or the brightness of the sub-pixels is 16.2M colors for each dot. The panel is intended to support displays where high brightness, wide viewing angle, high color saturation, and high color depth.

Screen diagonal	354mm (13.94")
Outline dimension	326(H) x 239(V) x 18.9(D) mm
Display Area	283(H) x 212(V) mm
Resolution	640(R,G,B) x 480
Pixel Pitch	0.4425 (H) x 0.4425 (W)
Pixel Arrangement	R.G.B Vertical Stripe
Typical White Luminance	450cd/m ²
Contrast Ratio	400:1 typ.
Support Colors	16.2M colors
Viewing Angle	85(left),85(right),85(up),85(down)

General Specifications:

Input/Output	1 x AV Input / 1 x AV Output
OSD Language	English
Operating Voltage	AC110-230V 50/60Hz DC:10-16V 5A
Remote	Remote range: 5 Meters (15 feet)
TV Specification	Channel Scan: ATSC, NTSC and QAM channels TV Audio system: MONO / STEREO / SAP V-Cltip: Both ATSC and NTSC are supported
Accessories	User manual / Remote control (w/BATTERY)

All specifications are subjected to change without prior notice.

ONE YEAR LIMITED WARRANTY

ToteVision warrants to the original purchaser that this product is free from defects in workmanship and material under normal use and conditions for a period of 1 year from the date of original purchase, subject to the limitations below. Should service be required by reason of any defect or malfunction during the warranty period, ToteVision will repair or at its discretion replace this product, without charge (subject to verification of the defect or malfunction), upon delivery of this product to the Factory Service Center listed below with proof of date of purchase. During the warranty period ToteVision will repair or replace, free of charge, defective units **WHICH ARE NOT DEFECTIVE DUE TO ORDINARY WEAR AND TEAR, USER ABUSE, OR OTHER CAUSES NOT ARISING OUT OF MANUFACTURER'S DEFECTS IN MATERIALS OR WORKMANSHIP.**

Before returning this product for service:

1. If it is necessary to pack the unit in other than original carton and protectors, please insure proper packaging for good protection.
2. Enclose a photocopy of your dated sales receipt, credit card statement, or other proof of the date of purchase, a description of your complaint, your name, address and daytime telephone number. Do not use P.O. Box numbers since UPS cannot deliver to P.O. Boxes. Your warranty registration information must be on file in our office as a method of identification. If proof of original ownership is not in our records, the repair will be treated as "out-of-warranty" and your unit will be returned to you C.O.D. for repair and handling charges.
3. Obtain a Return Authorization from ToteVision, ship the unit prepaid and insured to the ToteVision Service Center listed below. Enclose a description of your complaint, your name, company name, address, and daytime telephone number. If your unit needs service after the warranty period has expired, you will be advised of estimated repair charges.

NOTE: This warranty is valid only if the product is used for the purpose for which it was designed. It does not cover:

- (i) products which have been damaged by negligence, misuse, accidents, abuse, acts of God, or units which have been modified or repaired by unauthorized persons,
- (ii) cracked or broken units or units damaged by excessive heat or cold, or units exposed to excessive UV light.
- (iii) products which have their serial numbers removed, altered or rendered illegible,
- (iv) the cost of shipping this product to the Factory Service Center.

No warranty, expressed or implied, as to merchantability or fitness for a particular use is made beyond this Limited Warranty. ToteVision will not be liable for incidental or consequential damages or lost profits arising from product defects or malfunctions. This warranty is valid only in the United States of America and does not extend to owners of the product subsequent to the original purchaser. Any applicable implied warranties are also limited to 1 year and ToteVision will not be liable for consequential damages. (Some states do not allow limitations on implied warranties or exclusions of consequential damages, so that these restrictions may not apply to you.) This warranty gives you specific legal rights, and you may also have other rights, which vary from state to state.

As a precondition to receiving any of the benefits of this limited warranty, your completed warranty registration information must be on file in our office. **IF YOUR INFORMATION IS NOT ON FILE WITH US, ALL WARRANTY CLAIMS WILL BE DENIED. TO PROTECT YOUR WARRANTY, MAIL YOUR REGISTRATION INFORMATION TODAY!** Submission of a unit determined not defective will result in a charge to you of \$65.00 for testing and handling the unit. Thoroughly test your unit before submitting it for warranty claim repair.

Send unit to: TOTEVISION SERVICE CENTER 1319 Dexter Avenue N. #020, Seattle, WA 98109

For further information: call (206) 623-6000 or fax (206) 623-6609

WARRANTY REGISTRATION

Protect your Warranty by completing and mailing this form to: ToteVision, 1319 Dexter Avenue N. #020, Seattle, WA 98109

Model Number: _____ Serial Number: _____

Name: _____

Address: _____

City: _____ State: _____ Zip: _____

Telephone number: (_____) _____

Dealer: _____ Dealer City: _____ State: _____

Free Manuals Download Website

<http://myh66.com>

<http://usermanuals.us>

<http://www.somanuals.com>

<http://www.4manuals.cc>

<http://www.manual-lib.com>

<http://www.404manual.com>

<http://www.luxmanual.com>

<http://aubethermostatmanual.com>

Golf course search by state

<http://golfingnear.com>

Email search by domain

<http://emailbydomain.com>

Auto manuals search

<http://auto.somanuals.com>

TV manuals search

<http://tv.somanuals.com>