

4Runner

2009 Quick Reference Guide



2009 4Runner

This *Quick Reference Guide* is a summary of basic vehicle operations. It contains brief descriptions of fundamental operations so you can locate and use the vehicle's main equipment quickly and easily.

The *Quick Reference Guide* is not intended as a substitute for the *Owner's Manual* located in the vehicle's glove box. We strongly encourage you to review the *Owner's Manual* and supplementary manuals so you will have a better understanding of the vehicle's capabilities and limitations.

Your dealership and the entire staff of Toyota Motor Sales, U.S.A., Inc. wish you many years of satisfied driving in your new 4Runner.

! A word about safe vehicle operations

This *Quick Reference Guide* is not a full description of 4Runner operations. Every 4Runner owner should review the *Owner's Manual* that accompanies this vehicle.

Pay special attention to the boxed information highlighted in color throughout the *Owner's Manual*. Each box contains safe operating instructions to help you avoid injury or equipment malfunction.

All information in this *Quick Reference Guide* is current at the time of printing. Toyota reserves the right to make changes at any time without notice.

INDEX

OVERVIEW

Engine maintenance	7
Fuel tank door release and cap	6
Hood release	7
Indicator symbols	4-5
Instrument cluster	4
Instrument panel	2-3
Keyless entry¹	6

FEATURES/OPERATIONS

Air Conditioning/Heating	17
Audio	18-19
Auto lock functions^{1,2}	8
Automatic Transmission	8
Bottle holders	23
Clock	13
Cruise control	16
Cup holders	22
Door locks	20
Four-wheel drive	9
Garage door opener (HomeLink®) ³	21
Light control-Instrument panel	13
Lights¹ & turn signals	14
Moonroof¹	22
Parking brake	12
Power outlets-12V DC	23
Power outlets-115V AC	23
Rear seat entertainment system	20
Seat adjustments-Front	10
Seat adjustments-Rear	11
Seat heaters	16
Seats-Head restraints	12
Tilt and telescopic steering wheel	10
VSC OFF button	21
Windows¹	15
Window-Rear hatch¹	15
Windshield wipers & washers	13

SAFETY AND EMERGENCY FEATURES

Doors-Child safety locks	24
Seat belts	24
Seat belts-Shoulder belt anchor	24
Spare tire & tools	25
Tire Pressure Monitoring (warning) System	24

¹ Visit your Toyota dealer for information on customizing this feature.

² Programmable by customer. Refer to the Owner's Manual for instructions and more information.

³ HomeLink® is a registered trademark of Johnson Controls, Inc.

OVERVIEW

Instrument panel

Steering wheel controls

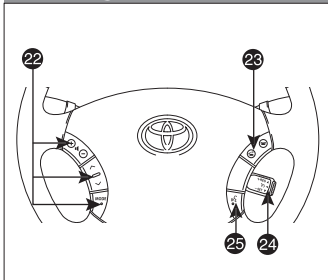

Rear console box

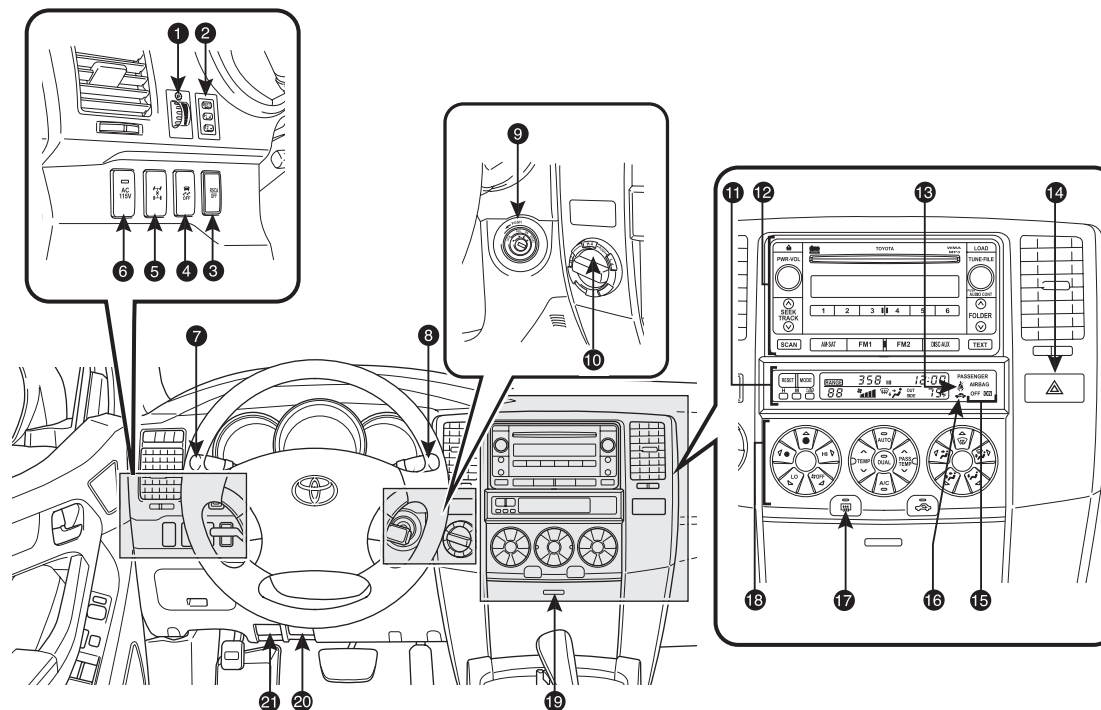
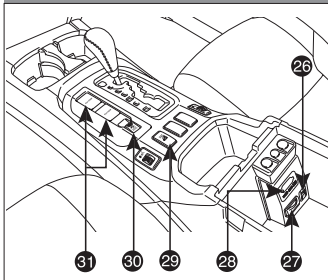

- 1 Instrument panel light control
- 2 Driving position memory switches¹
- 3 “RSCA OFF” (Roll Sensing of Curtain shield Airbags “OFF”) switch¹
- 4 VSC OFF switch¹
- 5 Center differential lock switch¹
- 6 115V AC Power outlet ON/OFF switch¹
- 7 Headlight, turn signal and front fog light¹ control
- 8 Wiper and washer controls
- 9 Engine switch
- 10 Four-wheel drive selector¹ (full-time 4WD models) or two wheel/ four-wheel drive selector¹ (part-time 4WD models)
- 11 Multi-information display
- 12 Audio system or navigation system²
- 13 Front passenger seat belt reminder light
- 14 Emergency flasher switch
- 15 Front passenger occupant classification indicator
- 16 Engine immobilizer/Theft deterrent system indicator¹

- 17 Back window and outside rearview mirror defogger¹ switch
- 18 Air Conditioning controls
- 19 Auxiliary boxes
- 20 Hood release
- 21 Fuel tank door opener
- 22 Steering wheel audio controls^{1,2}
- 23 Telephone switches^{1,2}
- 24 Cruise control
- 25 Navigation voice command button^{1,2}
- 26 AUX adapter
- 27 115V AC Power outlet¹
- 28 A/V input adapter¹
- 29 Downhill Assist Control switch¹
- 30 Power back window switch
- 31 12V DC Power outlet/Cigarette lighter

¹ If equipped

² For vehicles with a navigation system, refer to the “Navigation System Owner’s Manual.”

Instrument cluster

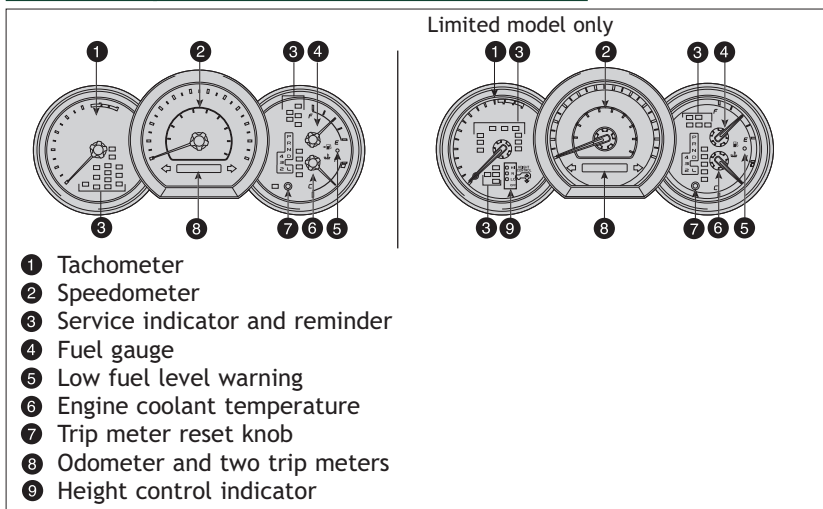

Indicator symbols

	Brake system warning ¹
	Driver/Front passenger seat belt reminder ¹
	Charging system warning ¹
	Low engine oil pressure warning ¹
	Malfunction/Check Engine indicator ¹
	Engine oil replacement reminder ¹
	Open door warning ¹
	Airbag SRS warning ¹
	Automatic Transmission fluid temperature warning ¹
	Low Tire Pressure Warning ¹
	Engine immobilizer/Theft deterrent system indicator

	Roll Sensing of Curtain shield Airbag OFF indicator ²
	AIR BAG ON indicator
	AIR BAG OFF indicator
	Headlight high beam indicator
	Turn signal indicator
	Front fog light indicator
	Automatic Transmission indicator
	Low speed four-wheel drive indicator ³
	Center differential lock indicator ³
	Vehicle Stability Control "OFF" indicator ¹
	Four-wheel drive indicator ³
	Slip indicator
	AUTO Limited Slip Differential indicator
	Downhill Assist Control indicator
	Height control indicator ⁴
	Cruise control indicator ⁵
	Anti-lock Brake System warning ¹
	Low fuel level warning ¹
	Active traction control indicator
	Rear differential lock indicator

¹ For details, refer to "If a warning light turns on or warning buzzer sounds..." Section 5-2, 2009 Owner's Manual.

² For details, see "SRS airbags" Section 1-7, 2009 Owner's Manual.

³ If this light flashes, refer to "Four-wheel drive system," Section 2-4, 2009 Owner's Manual.

⁴ If "OFF" indicator flashes, refer to "Electronically modulated air suspension" Section 2-4, 2009 Owner's Manual.

⁵ If this light flashes, refer to "Cruise control," Section 2-4, 2009 Owner's Manual.

Fuel tank door release and cap

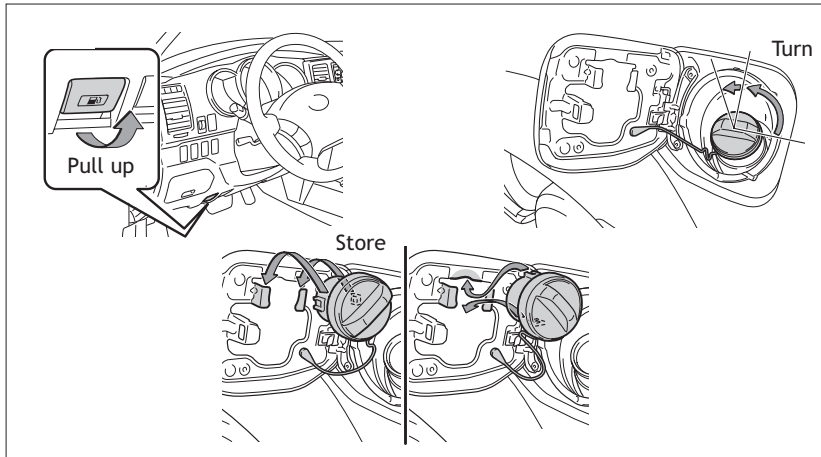

NOTE: Tighten until one click is heard. If the cap is not tightened enough, Check Engine “” indicator may illuminate.

Keyless entry (if equipped)

Beep sound can be switched ON or OFF. Refer to the *Owner's Manual* for more details.

Locking operation

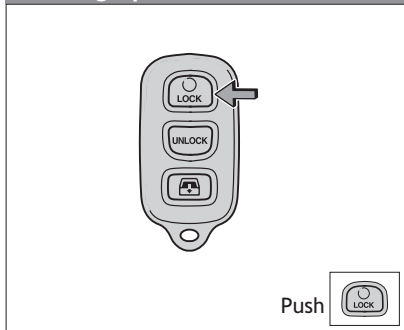

Unlocking operation

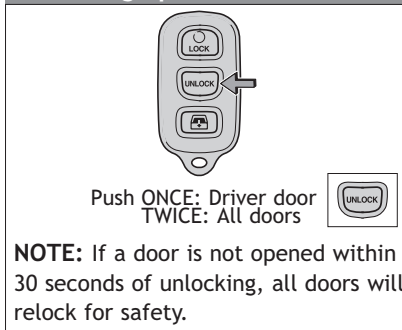

Back window operation

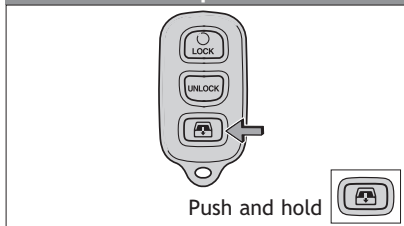

Panic button

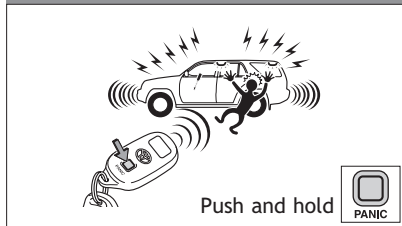

Hood release

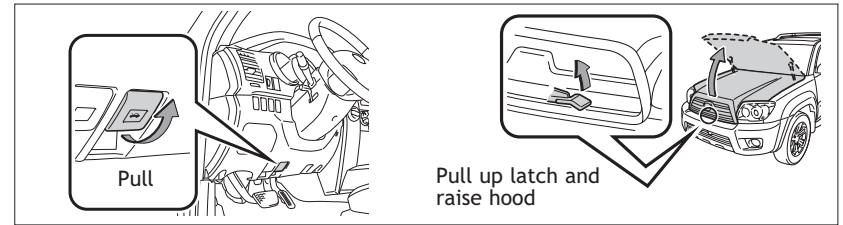

Engine maintenance

6 cylinder (1GR-FE) engine

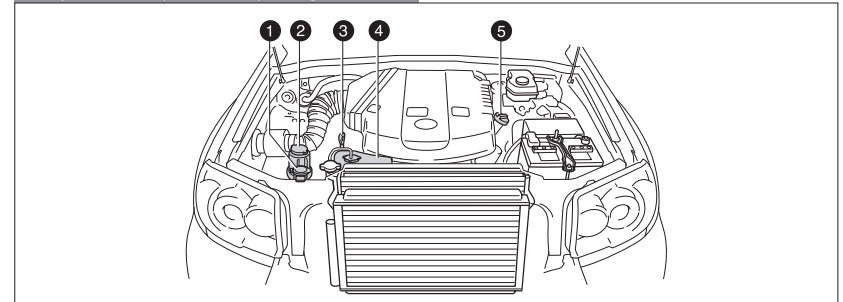

8 cylinder (2UZ-FE) engine

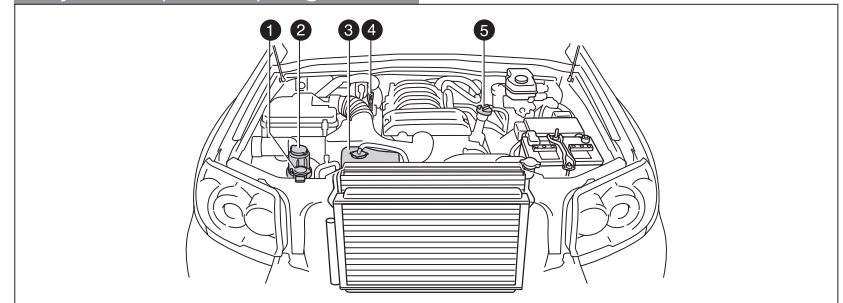

- ① Windshield and back window washer fluid tank
- ② Power steering fluid reservoir
- ③ Engine oil level dipstick
- ④ Engine coolant reservoir
- ⑤ Engine oil filler cap

Note: Regularly scheduled maintenance, including oil changes, will help extend the life of your vehicle and maintain performance. Please refer to the “Owner's Warranty Information Booklet,” “Scheduled Maintenance Guide” or “Owner's Manual Supplement.”

FEATURES/OPERATIONS

Auto lock functions

Automatic door locks can be programmed to operate in four different modes, or turned OFF.

- Doors lock when shifting from Park.
- Doors lock when the vehicle speed goes above approximately 12 mph.
- Doors unlock when shifting into Park.
- Doors unlock when the engine switch is set from "ON" to "ACC" or "LOCK" and driver's door is opened.

Refer to the *Owner's Manual* for more details.

Automatic Transmission

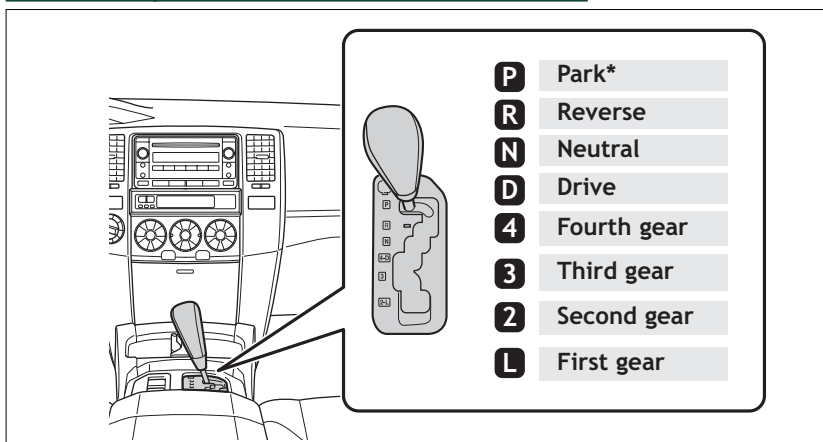

* The engine switch must be "ON" and the brake pedal depressed to shift from Park.

Downshifting increases power going uphill, or provides engine braking downhill. For best fuel economy during normal driving conditions, always drive with the shift lever in the "D" position.

Four-wheel drive (if equipped)

Part-time four-wheel drive models

-
- A diagram showing the four-wheel drive selector knob for part-time models. The knob has positions for H2, H4, and L4. Arrows indicate the direction of rotation and the push action for the L4 position.
- H2** High speed (2WD)
 - H4** High speed (4WD)
Turn to "H4" with speed below 62 mph.
 - L4** Low speed (4WD)
Shift to "N" position, then push and turn to "L4."

Full-time four-wheel drive models

-
- A diagram showing the four-wheel drive selector knob for full-time models. The knob has positions for H4 and L4. An arrow indicates the direction of rotation for the L4 position.
- H4** High speed
Turn to "H4" with speed below 62 mph.
 - L4** Low speed
Shift to "N" position, then push and turn to "L4."

Center differential lock button

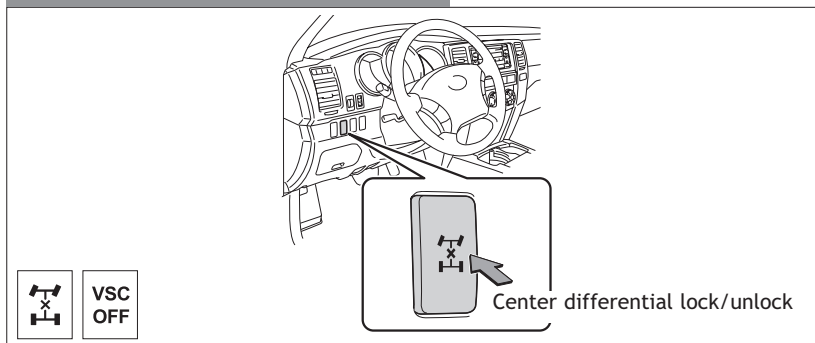

For best fuel economy and performance under normal driving conditions:

- "H2" position (part-time four-wheel drive models)
- "H4" position (full-time four-wheel drive models), center differential unlocked (center differential lock indicator and "VSC OFF" indicator are not illuminated).

Tilt and telescopic (if equipped) steering wheel

(1) Angle

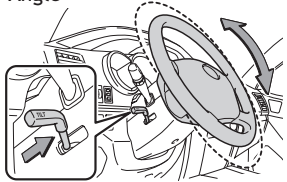

(2) Column length

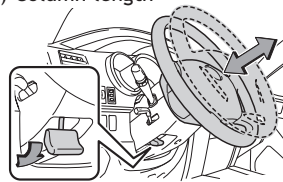

- (1) **To change the angle** Hold the steering wheel, pull the lock release lever, tilt to the desired angle, and release the lever.
- (2) **To change the column length** Push the lock release lever down, set the desired length, and return the lever to its locked position.

Note: Do not attempt to adjust while the vehicle is in motion.

Seat adjustments-Front

Manual seat

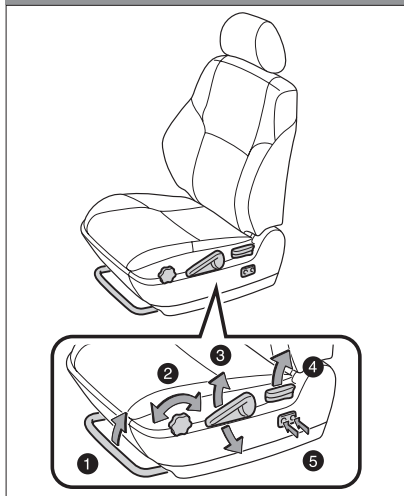

Power seat

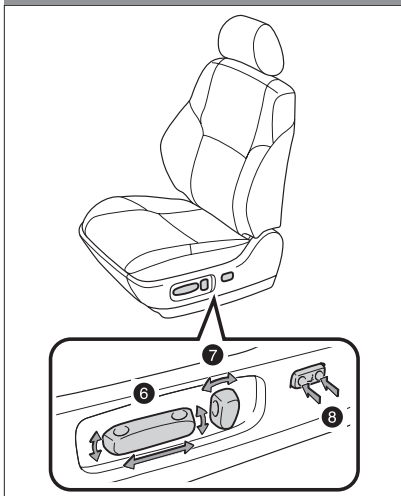

- 1 Seat position (forward/backward)
- 2 Cushion angle (driver side only)
- 3 Height crank (driver side only)
- 4 Seatback angle
- 5 Lumbar support (driver side only)
- 6 Driver seat: position, cushion angle and height
Passenger seat: position
- 7 Seatback angle
- 8 Lumbar support (driver side only)

Seat adjustments-Rear (vehicles with third row seats)

Second row seats

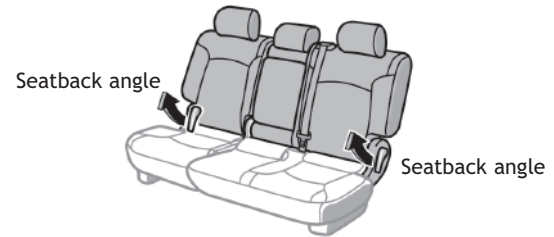

Third row seats



Seat adjustments-Rear (vehicles without third row seats)

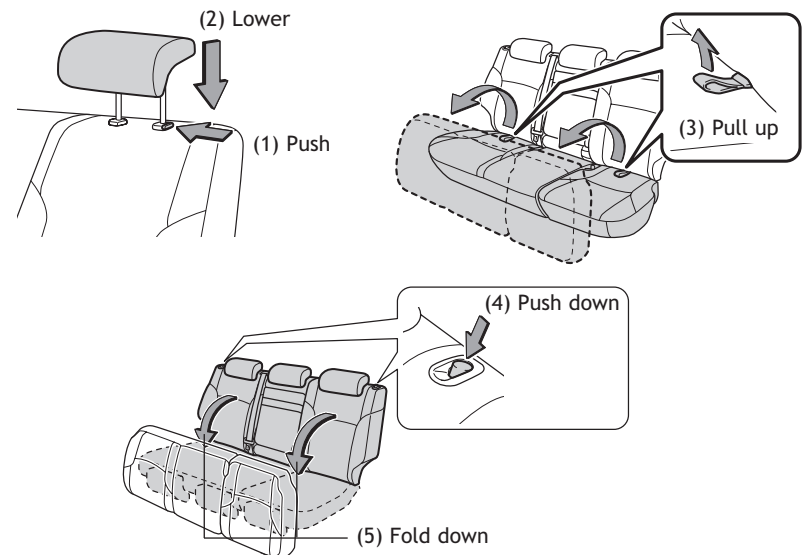

Parking brake

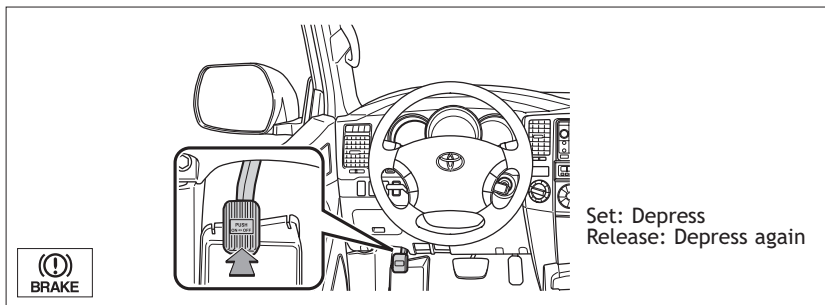

Seats-Head restraints

Front

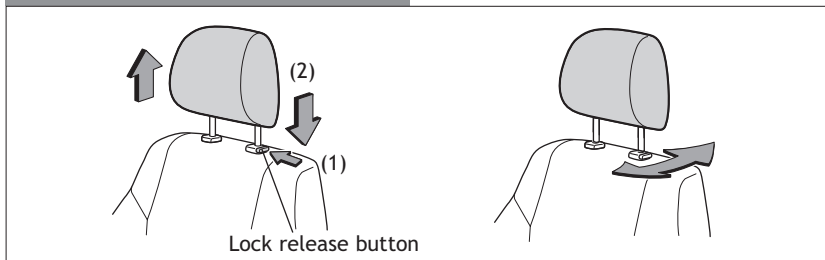

Second row

With third seat

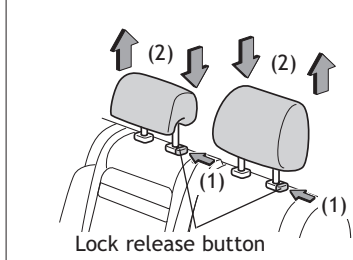

Without third seat

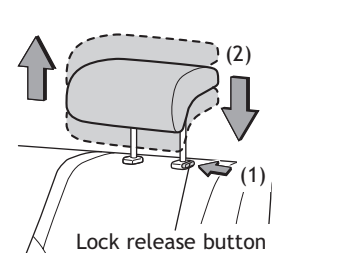

Third row

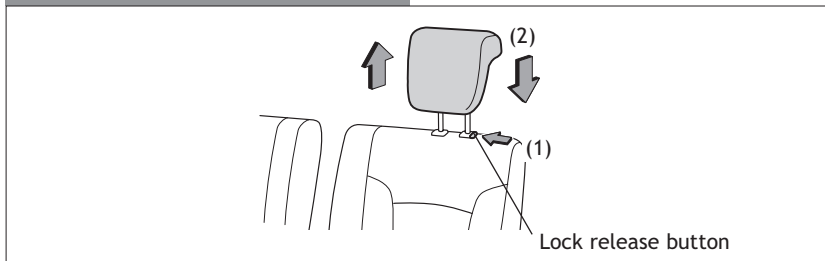

Windshield wipers & washers

Front

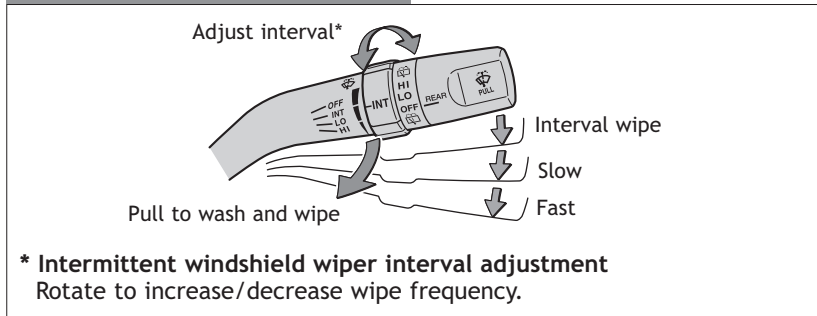

Rear

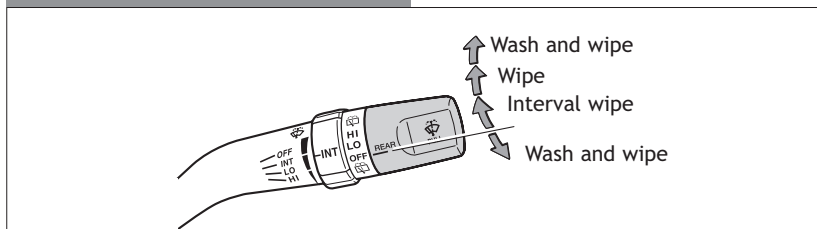

NOTE: Rear wiper and washer operate only when rear window is fully closed. If battery is disconnected, rear washer will not function until rear window is reinitialized by being fully opened and then closed.

Light control-Instrument panel

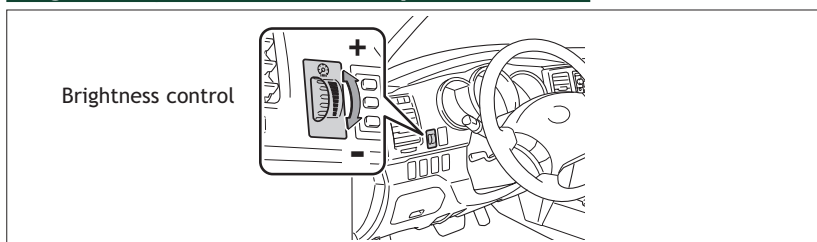

Clock

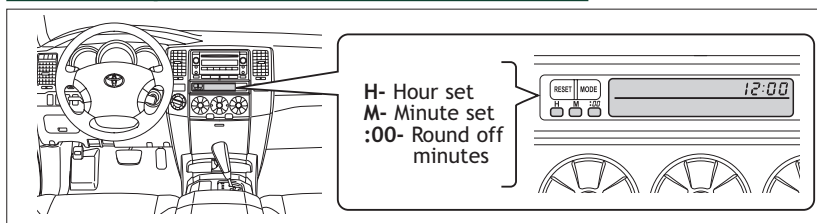

Lights & turn signals

Headlights

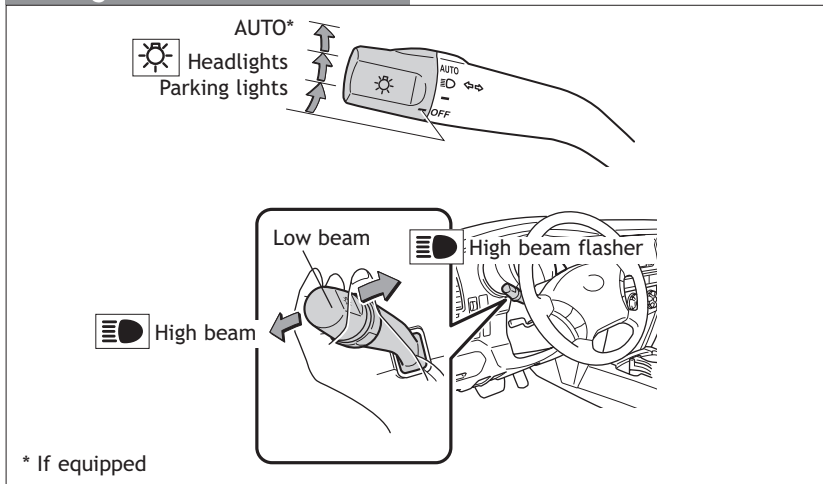

-Daytime Running Light system (if equipped)

Automatically turns on the headlights at a reduced intensity.

-Automatic light cut off system Will automatically turn lights off after a delay of 30 seconds, or the lock switch on remote may be pushed after locking.

Turn signals

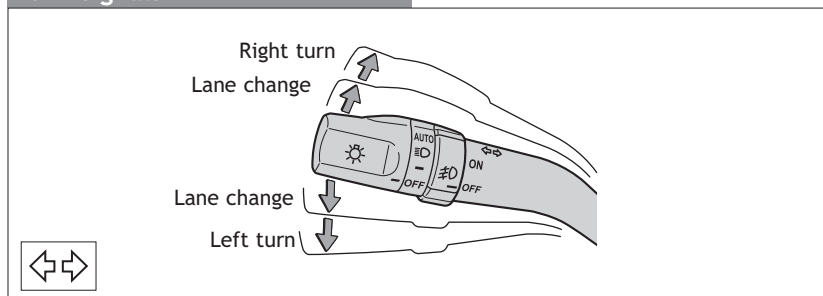

Front fog lights (if equipped)

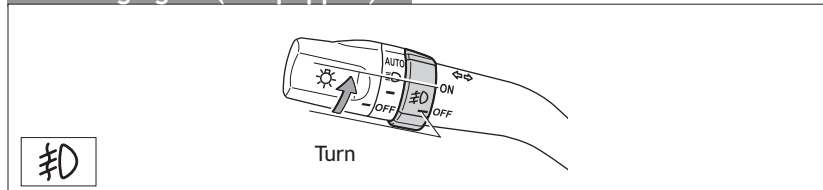

Front fog lights come on only when the headlights are on low beam.

Windows

Driver side

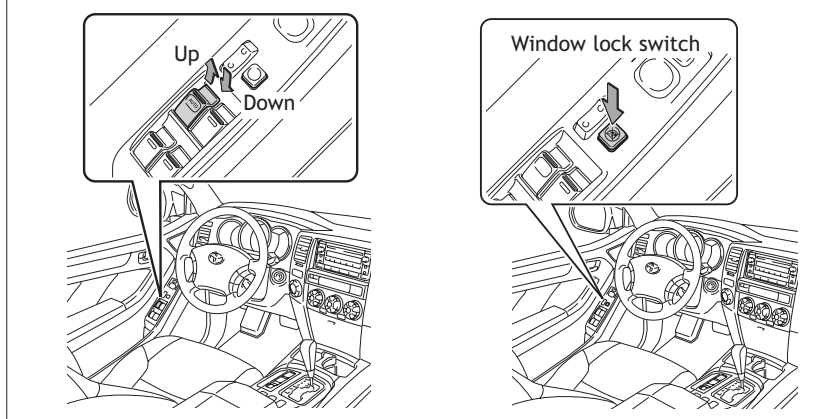

Automatic operation (driver side only) Push the switch completely down or pull it completely up and release to fully open or close. To stop window midway, lightly push the switch in the opposite direction.

Window lock switch Deactivates all passenger windows. Driver's window remains operable.

NOTE: If the battery is disconnected, the window will need to be reinitialized. Refer to the *Owner's Manual* for more details.

Window-Rear hatch

Operating from inside

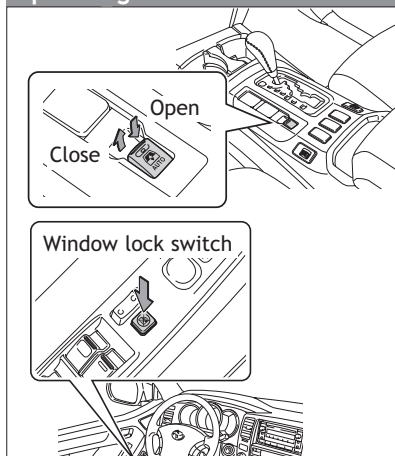

Operating from outside

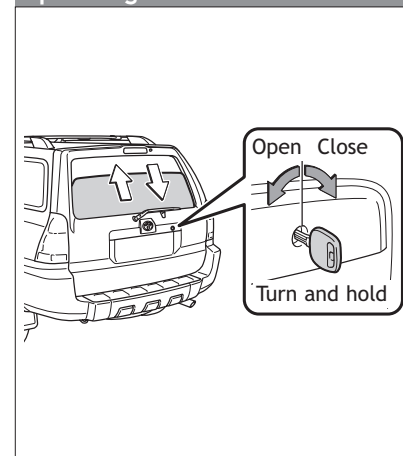

NOTE: If the battery is disconnected, the rear hatch window will need to be reinitialized. Refer to the *Owner's Manual* for more details.

Cruise control

Turning system ON/OFF

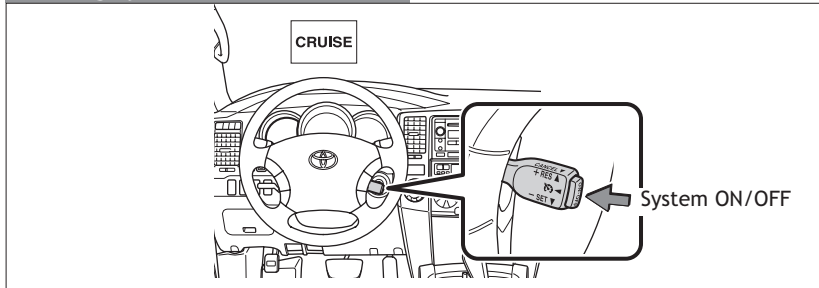

Functions

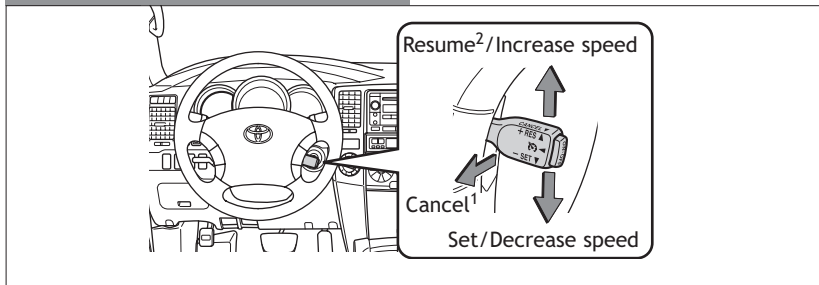

¹ The set speed may also be cancelled by depressing the brake pedal.

² The set speed may be resumed once vehicle speed exceeds 25 mph.

Refer to the *Owner's Manual* for more details.

Seat heaters (if equipped)

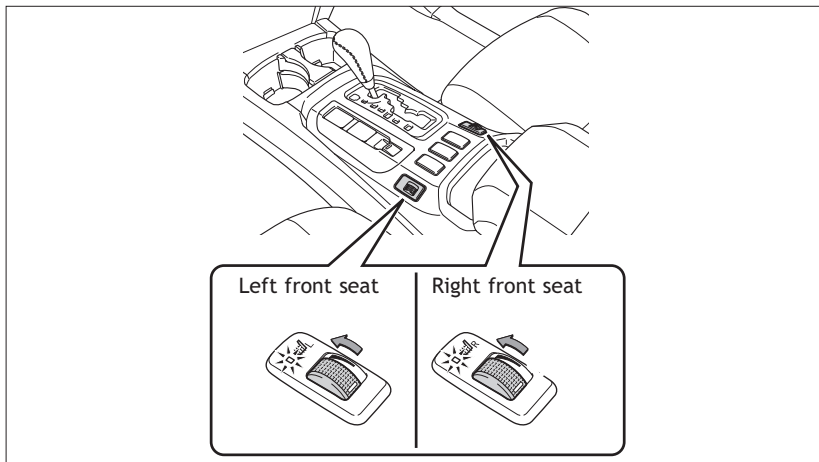

Air Conditioning/Heating

With "DUAL" button

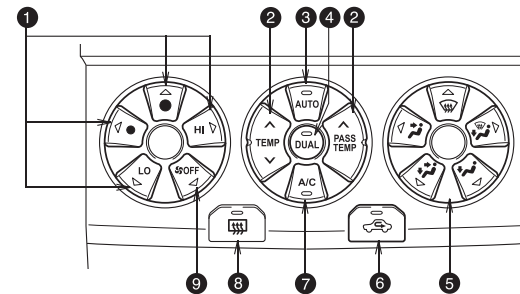

Without "DUAL" button

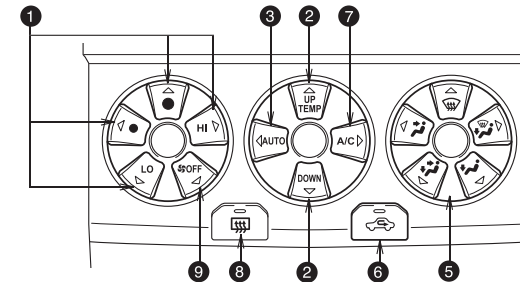

- 1 Fan speed
- 2 Temperature selector
- 3 Automatic climate control ON/OFF
- 4 "DUAL" button
Indicator ON: Separate temperature settings for driver and passenger.
Indicator OFF: Synchronize temperature settings for driver and passenger.
- 5 Airflow vent
 In " " mode, use fresh air (" indicator OFF) to reduce window fogging. " mode uses fresh air only.
- 6 Fresh or recirculated cabin air
- 7 Air Conditioning ON/OFF
- 8 Rear defogger
- 9 Climate control OFF

Audio

Type 1

Preset buttons - functions in other modes indicated above number.

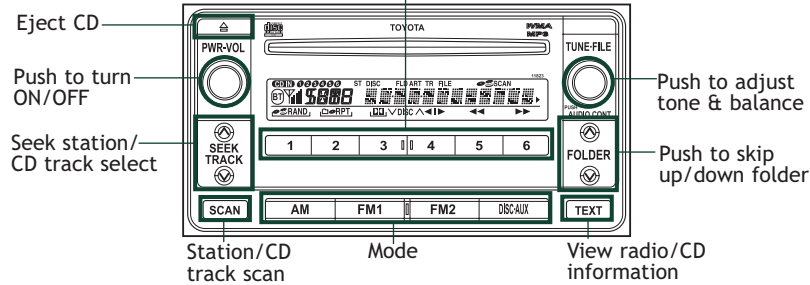

Type 2 additional functions

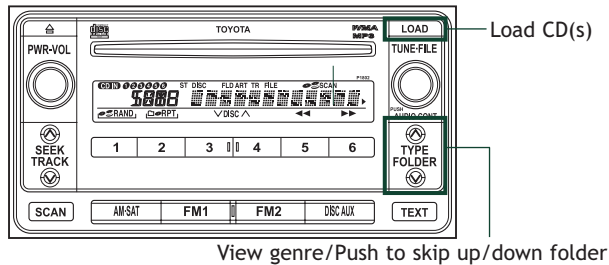

Type 3 additional functions

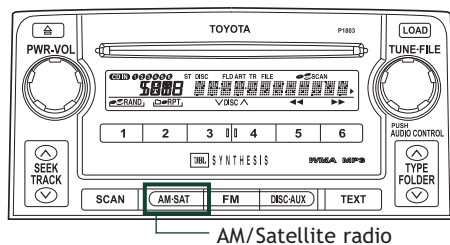

CD PLAYER

To scan tracks on a disc Push "SCAN." Push again to hold selection.
CD Changer (Types 2 and 3)
 -To load one disc Push "LOAD" and insert disc.
 -To load multiple discs Push and hold "LOAD" until you hear a beep. Insert one disc. Shutter will close and then re-open for next disc.
 To select a file (MP3/WMA only) Turn "TUNE-FILE."
 To select a folder (MP3/WMA only) Push either side of "FOLDER" or "TYPE/FOLDER."

RADIO

To preset stations Tune in the desired station and hold down a preset button (1-6) until you hear a beep. Push desired preset button (1-6) to select.

To scan stations Push "SCAN." Push and hold to scan preset stations. Push again to hold selection.

Steering wheel controls (if equipped)

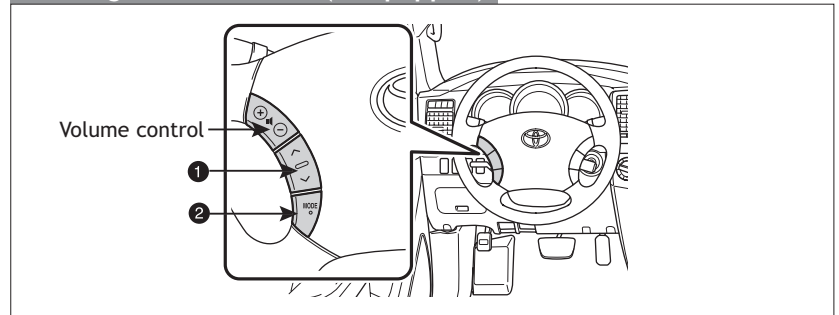

- 1 "▲ ▼"
 -In radio mode Push to select a preset station; push and hold to seek the next strong station.
 -In CD mode Push to skip up or down to next/previous track.
- 2 "MODE"
 Push to turn audio ON and select an audio mode. Push and hold to turn audio system OFF.

AUX adapter

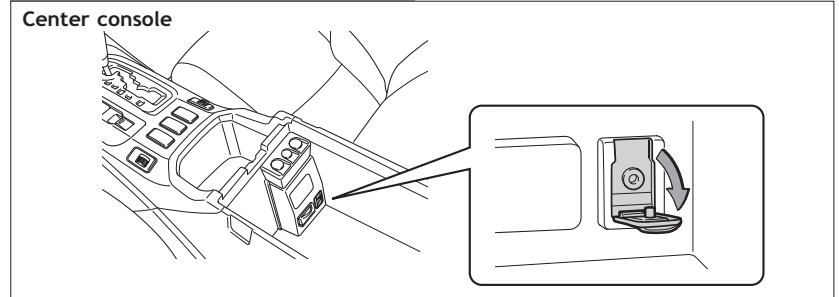

By inserting a mini plug into the AUX audio jack, you can listen to music from a portable audio device through the vehicle's speaker system while in AUX mode.

Door locks

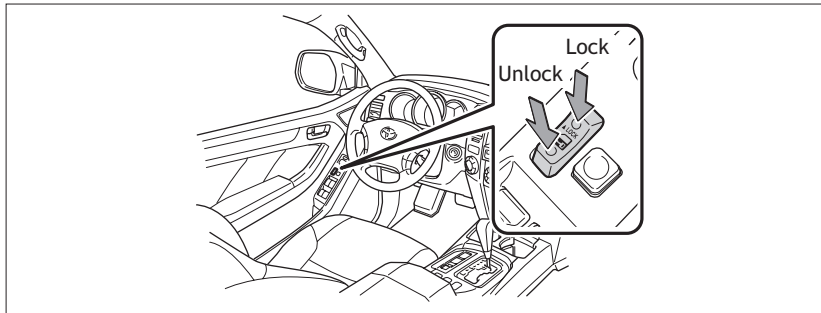

Rear seat entertainment system (if equipped)

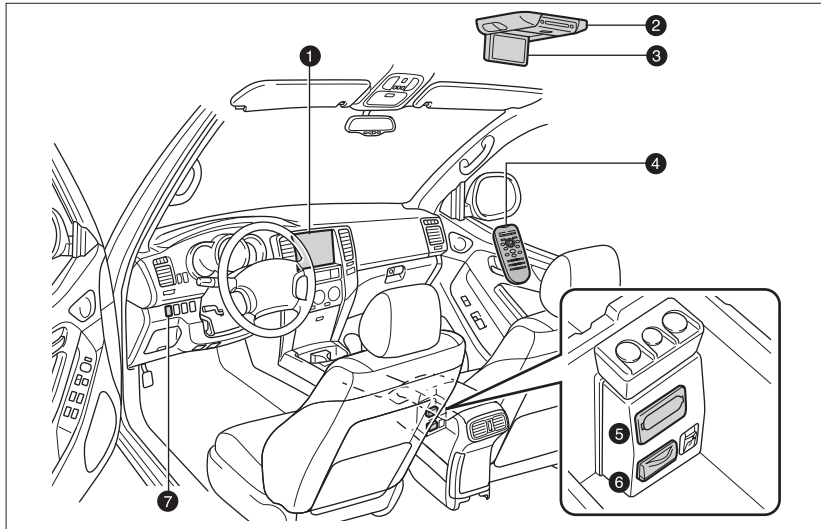

- 1 Front audio system
- 2 DVD player
- 3 DVD screen
- 4 Remote control
- 5 A/V input adapter
- 6 115V AC Power outlet
- 7 115V AC Power outlet ON/OFF switch

Garage door opener (HomeLink®)* (if equipped)

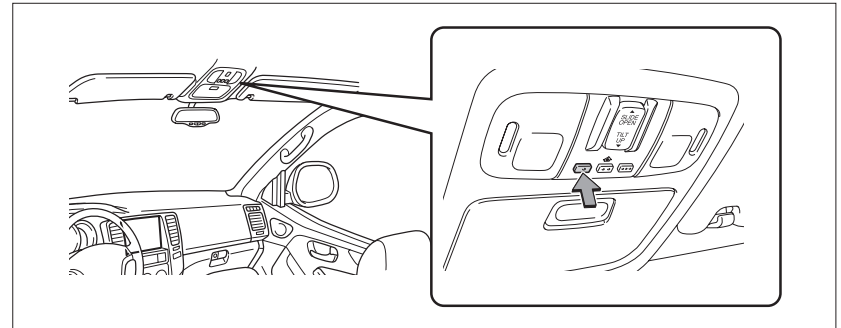

Garage door openers manufactured under license from HomeLink®* can be programmed to operate garage doors, estate gates, security lighting, etc.

Refer to the *Owner's Manual* for more details.

For programming assistance, contact the Toyota Customer Experience Center at 1-800-331-4331, or visit <http://www.homelink.com>.

* HomeLink® is a registered trademark of Johnson Controls, Inc.

VSC OFF button

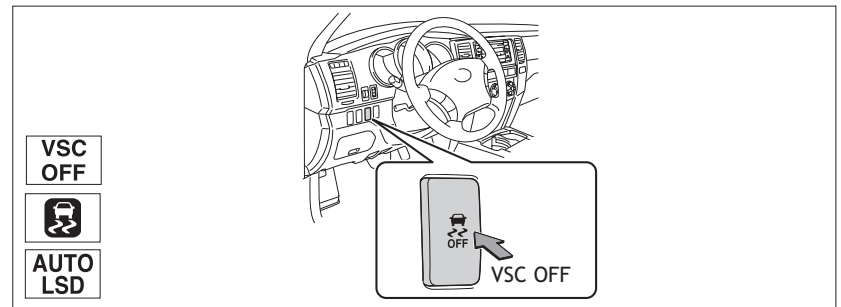

The VSC OFF button is used to switch between modes related to the TRAC, VSC and Auto LSD functions.

Refer to Section 2-4 of the *Owner's Manual* for more information.

Moonroof (if equipped)

Sliding operation

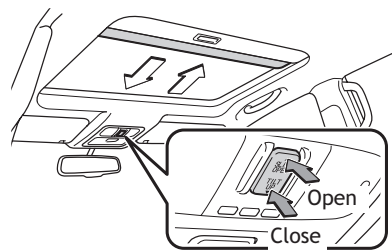

Push once to open/close completely. To stop partway, press switch lightly.

Tilting operation

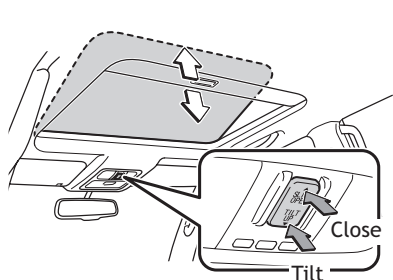

NOTE: If battery is disconnected, the moonroof will need to be reinitialized. Refer to the *Owner's Manual* for more details.

Cup holders

Center console

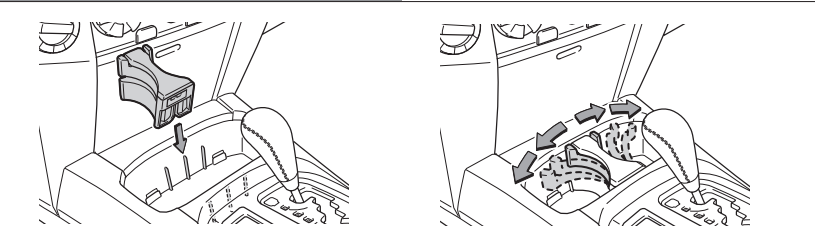

Rear (without third seats)

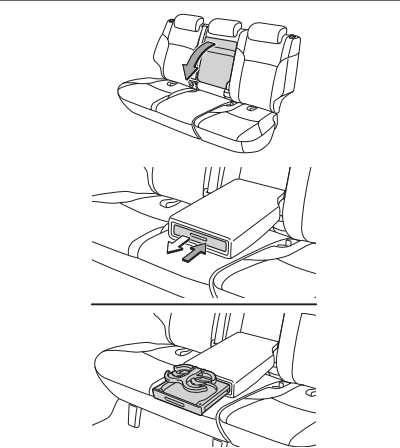

Rear (with third seats)

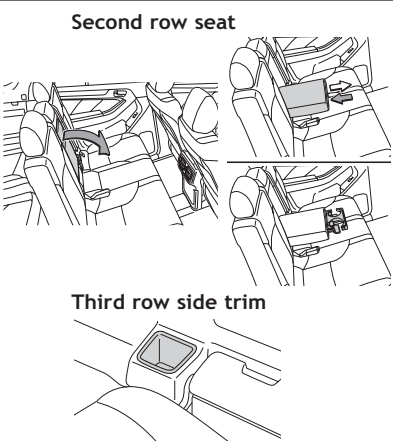

Bottle holders

Front doors

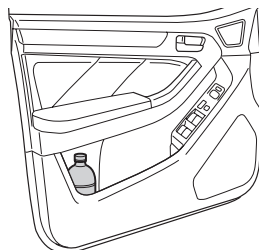

Rear doors

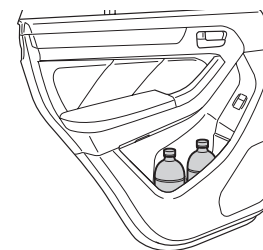

Power outlets-12V DC

Auxiliary box

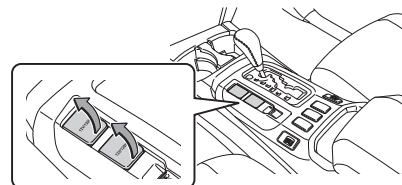

Luggage compartment

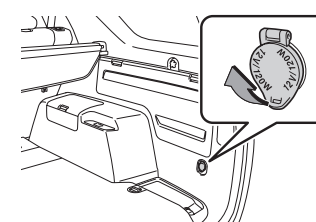

NOTE: Designed for car accessories. Engine switch must be in the "ACC" or "ON" position to be used.

Power outlets-115V AC (if equipped)

ON/OFF switch

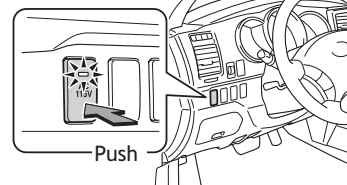

Inside center console

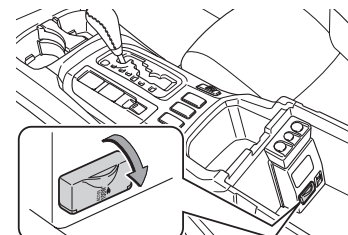

NOTE: Engine switch must be in the "ON" position to be used.

SAFETY AND EMERGENCY FEATURES

Doors-Child safety locks

Rear door

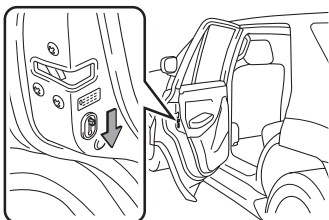

Moving the lever to “LOCK” will allow the door to be opened only from the outside.

Seat belts

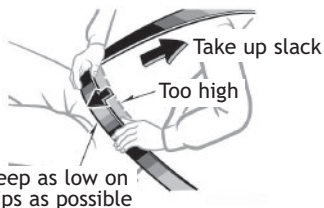

If belt is fully extended, then retracted even slightly, it cannot be re-extended beyond that point, unless fully retracted again. This feature is used to help hold child restraint systems securely.

To find more information about seat belts, and how to install a child restraint system, refer to the *Owner's Manual*.

Seat belts-Shoulder belt anchor

Push up or squeeze lock release to lower

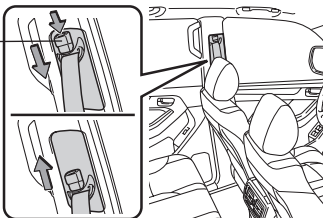

Tire Pressure Monitoring (warning) System

If tire pressure becomes critically low on any of the tires (including the spare), indicator light will come on. Correctly adjusting tire inflation will turn off the light after a few minutes. If the light does not turn off, have the system checked by your Toyota dealer.

Refer to the *Owner's Manual* for more details.

Spare tire & tools

Tool location

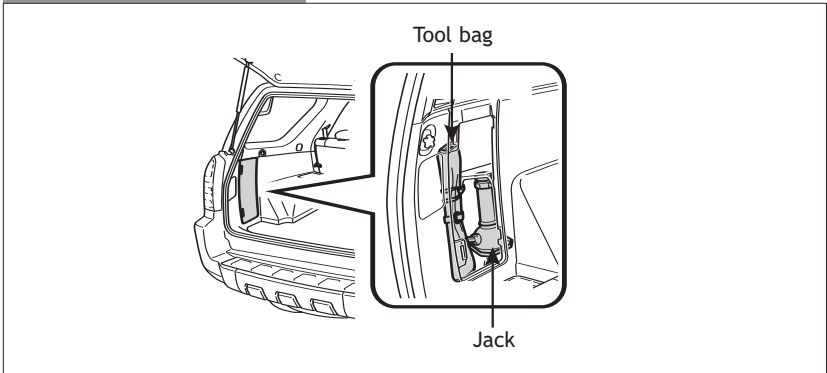

Removing the spare tire

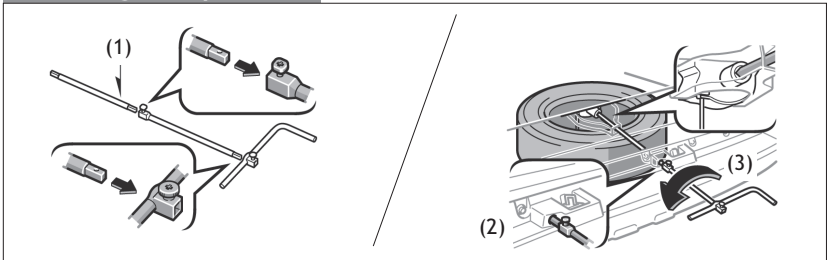

- (1) Assemble the jack handle.
- (2) Insert the jack handle end through the opening in the bumper, and into the lowering screw.
- (3) Turn the jack handle counterclockwise.

Refer to the *Owner's Manual* for tire changing and jack positioning procedures.



Customer Experience Center
1-800-331-4331

MN 00505-QRG09-4RUN
Printed in the USA 7/08

Download from www.somanuals.com. All Manuals Search And Download.

Free Manuals Download Website

<http://myh66.com>

<http://usermanuals.us>

<http://www.somanuals.com>

<http://www.4manuals.cc>

<http://www.manual-lib.com>

<http://www.404manual.com>

<http://www.luxmanual.com>

<http://aubethermostatmanual.com>

Golf course search by state

<http://golfingnear.com>

Email search by domain

<http://emailbydomain.com>

Auto manuals search

<http://auto.somanuals.com>

TV manuals search

<http://tv.somanuals.com>