

Customer Experience Center
1-800-331-4331

www.toyotaownersonline.com



moving forward ▶

RAV4



2006
Pocket Reference Guide

MN 00452-PRG06-RAV
Printed in USA 10/05

Download from Www.Somanuals.com. All Manuals Search And Download.

2006 RAV4

This Pocket Reference Guide is a summary of basic vehicle operations. It contains brief descriptions of fundamental operations so you can locate and use the vehicle's main equipment quickly and easily.

The Pocket Reference Guide is not intended as a substitute for the Owner's Manual located in the vehicle's glove box. We strongly encourage you to review the Owner's Manual and supplementary manuals so you will have a better understanding of the vehicle's capabilities and limitations.

Your dealership and the entire staff of Toyota Motor Sales, U.S.A., Inc. wish you many years of satisfied driving in your new RAV4.

! A word about safe vehicle operations

This Pocket Reference Guide is not a full description of RAV4 operations. Every RAV4 owner should review the Owner's Manual that accompanies this vehicle.

Pay special attention to the boxed " ⚠ CAUTION " information highlighted in this reference guide and throughout the Owner's Manual. Each box contains safe operating instructions to help you avoid injury or equipment malfunction.

⚠ CAUTION

This utility vehicle has a significantly higher rollover rate than other types of vehicles. Refer to the Owner's Manual for important rollover information.

All information in this Pocket Reference Guide is current at the time of printing. Toyota reserves the right to make changes at any time without notice.

Spare tire & tools

Tool location

Luggage compartment
Inside left side box

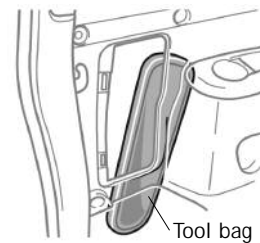

Luggage compartment
Inside right side box

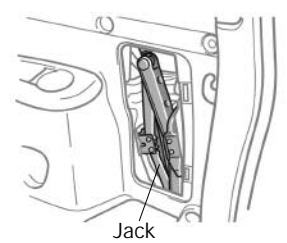

Removing the spare tire

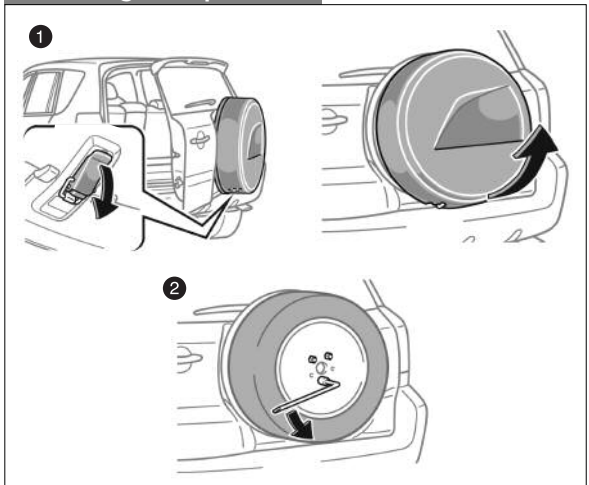

- 1 To remove the spare tire cover,* open the back door. Unhook the latch on the bottom of the cover. After closing the back door, remove the cover.

NOTE: To prevent theft, the latch can only be released when the back door is opened

- 2 To remove the spare tire, turn the wheel nuts counterclockwise with the wheel nut wrench and remove.

* If installed

Refer to the Owner's Manual for jack positioning and tire changing procedures.

INDEX

Item	Page no.
OVERVIEW	
Engine maintenance	7
Fuel tank door release and cap	6
Hood release	7
Indicator symbols	4-5
Instrument cluster	4
Instrument panel	2-3
Keyless entry ¹	6
FEATURES/OPERATIONS	
Active torque control 4WD	8
Air Conditioning/Heating	14-15
Audio	16-17
Auto LSD (Limited Slip Differential)	19
Automatic transmission	8
Bottle holders	19
Clock	13
Cruise control	14
Cup holders	19
Door locks	18
Light control-Instrument panel	13
Lights & turn signals	12
Moonroof	18
Parking brake	12
Power outlets	18
Seat adjustments-Front	9
Seat adjustments-Second row seats	10
Seat heaters	15
Seats-Head restraints	9
Seats-Fold down second row seats	10
Seats-stowing third row seats	11
Tilt and telescopic steering wheel	13
Windows	13
Windshield wiper & washer	11
SAFETY AND EMERGENCY FEATURES	
Doors-Child safety locks	20
Seat belts	20
Seat belts-Shoulder belt anchor	20
Spare tire & tools	21
Tire Pressure Warning System	20

¹ Visit your Toyota dealer for information on this and other customizable options.

OVERVIEW

Instrument panel

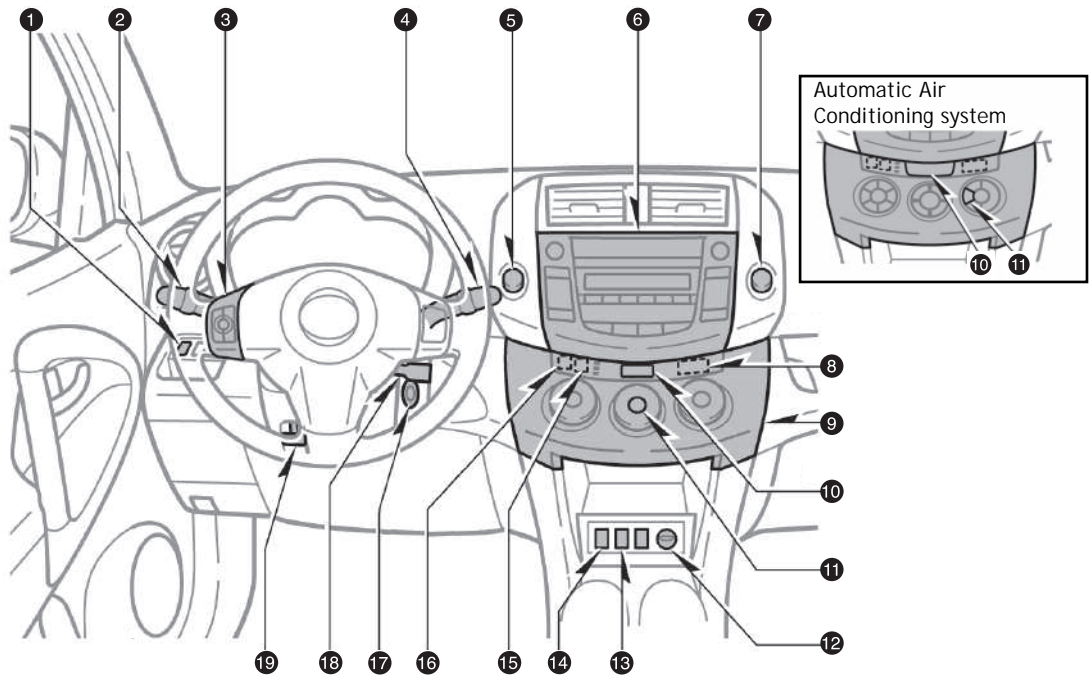

- ❶ Instrument panel light control
- ❷ Headlight, turn signal and front fog light¹ control
- ❸ Audio steering wheel switches¹
- ❹ Wiper and washer controls
- ❺ Four-wheel drive lock switch (4WD models) or "AUTO LSD" switch (2WD models)
- ❻ Audio
- ❼ Emergency flasher switch
- ❽ Front passenger occupant classification indicator lights
- ❾ Air Conditioning controls
- ❿ Clock
- ⓫ Rear window and outside rearview mirror defogger¹ switch
- ⓬ 12V DC Power outlet
- ⓭ Seat heater switch
- ⓮ Downhill Assist Control (DAC) switch
- ⓯ Front passenger seat belt reminder light
- ⓰ Engine immobilizer indicator light¹
- ⓱ Ignition
- ⓲ Cruise control
- ⓳ Tilt and telescopic steering release

¹ If equipped

Instrument cluster

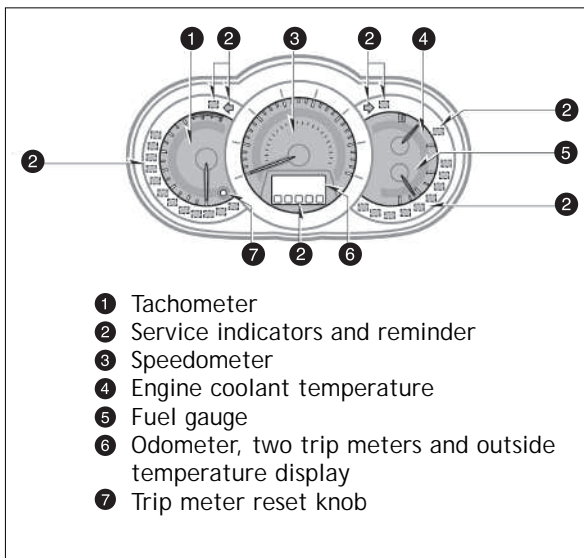

Indicator symbols

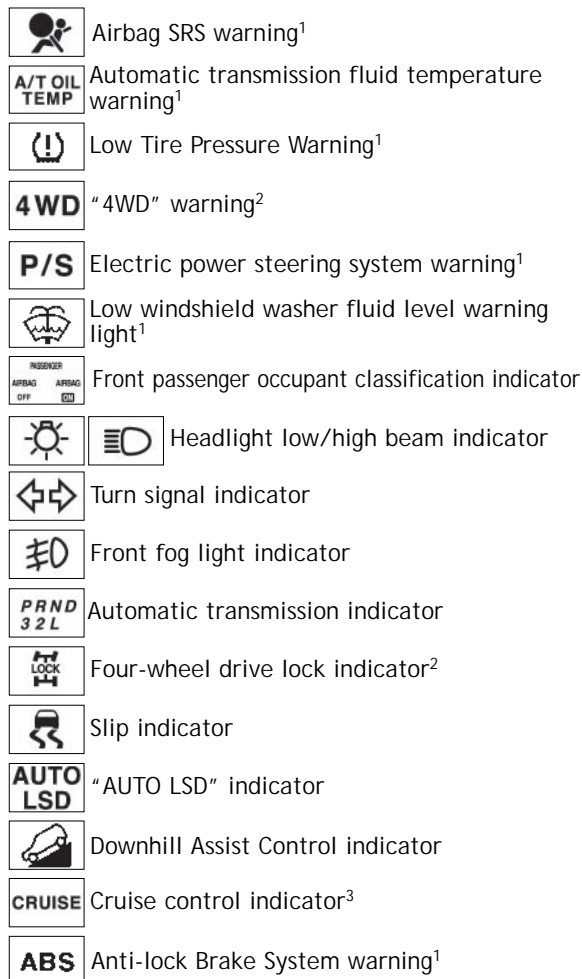
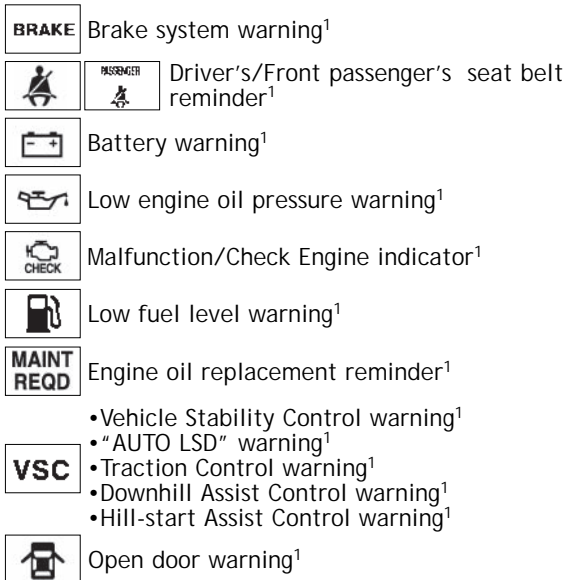

CAUTION

When the Anti-lock Brake System (ABS) function is in action, you may feel the brake pedal pulsating and hear a noise. In this situation, to let the Anti-lock Brake System work for you, just hold the brake pedal down more firmly. Do not pump the brake as this will result in reduced braking performance.

¹ For details, refer to "Service reminder indicators and warning buzzers," Section 1-6, 2006 Owner's Manual.

² For details, refer to "Active torque control 4WD system," Section 1-7, 2006 Owner's Manual.

³ If this light flashes, refer to "Cruise control," Section 1-7, 2006 Owner's Manual.

Fuel tank door release and cap

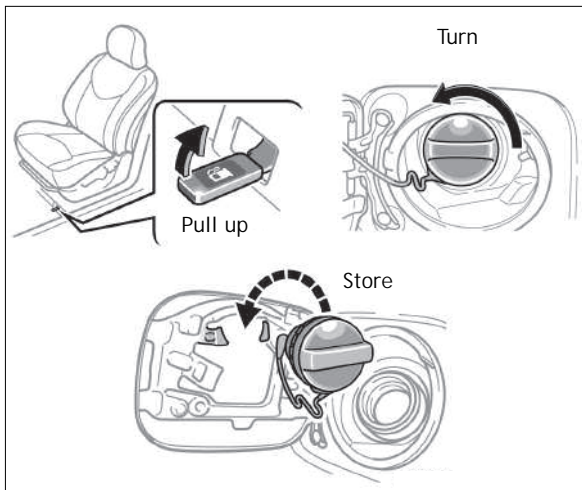

NOTE: If the cap is not tightened enough, the Check Engine "  " indicator may illuminate.

Keyless entry (if equipped)

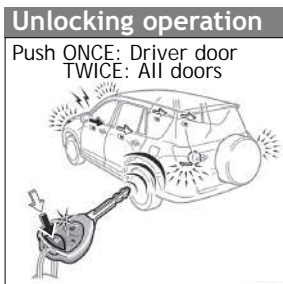
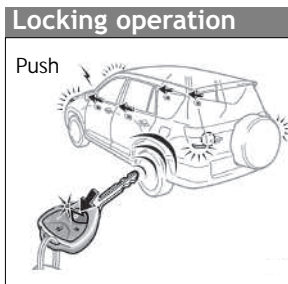

NOTE: After unlocking, if a door is not opened within thirty (30) seconds, all doors will relock for safety.

Alarm operation



Hood release

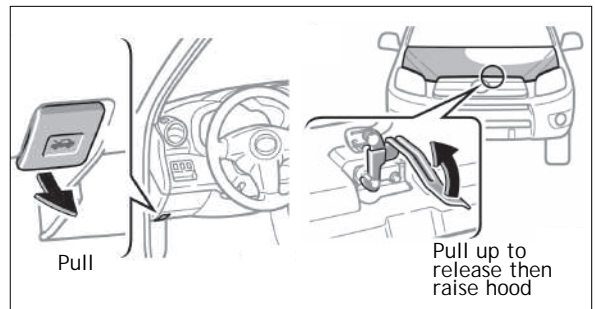

Engine maintenance

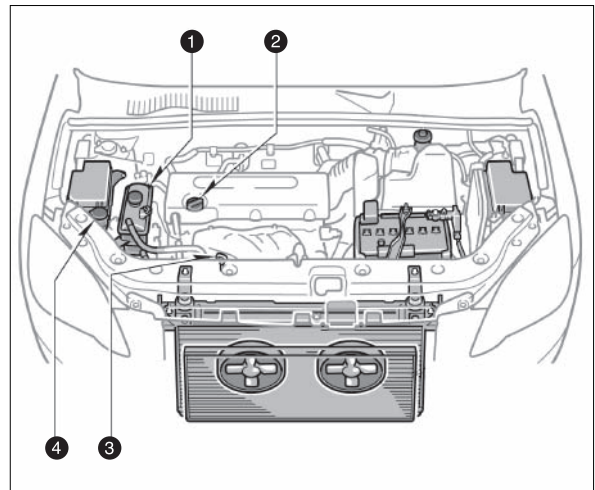

- ① Engine coolant reservoir
- ② Engine oil filler cap
- ③ Engine oil level dipstick
- ④ Windshield and back window washer fluid tank

Note: Regularly scheduled maintenance, including oil changes, will help extend the life of your vehicle and maintain performance. Please refer to the "Owner's Warranty Information Booklet," "Scheduled Maintenance Guide" or "Owner's Manual Supplement."

FEATURES/OPERATIONS

Automatic transmission

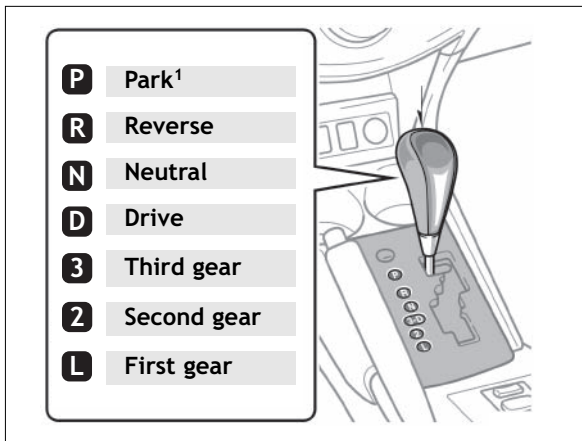

¹ The key must be in the "ON" or "ACC" position and the brake pedal depressed.

Downshifting increases power going uphill, or provides engine braking downhill. For best fuel economy during normal driving conditions, always drive with the shift lever in the "D" position.

Active torque control 4WD (4WD models)

Four-wheel drive lock switch

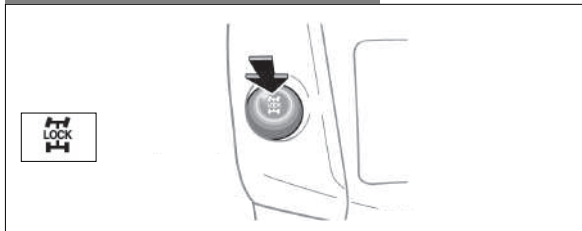

Push the switch to ensure that the engine torque is applied to the 4 wheels.

NOTE: It should ONLY be used when wheel spinning occurs on loose or unpaved surfaces.

Refer to the Owner's Manual for complete details.

Seat adjustments-Front

Manual Seat



Power Seat



- 1 Position
- 2 Height crank (driver side only)
- 3 Seatback angle
- 4 Driver's seat: position and cushion angle/height
Passenger's seat: position only
- 5 Seatback angle
- 6 Lumbar support

Seats-Head restraints

Front seats

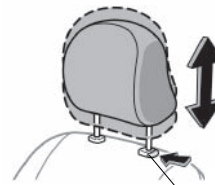

Second row seats

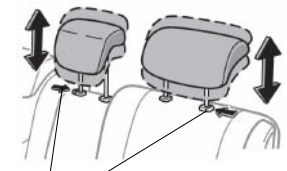

Lock release button

Third row seats

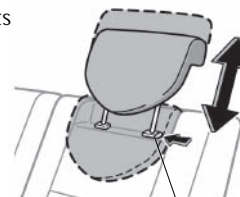

Lock release button

Seat adjustments-second row seats

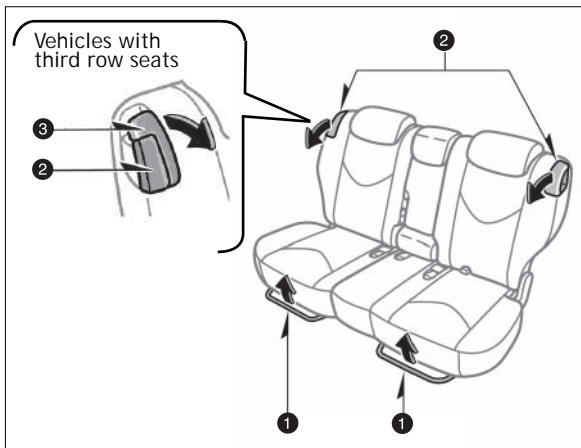

- ① Position
- ② Seatback angle
- ③ Seatback lock release

Seats-fold down second row seats

Vehicles without third row seats

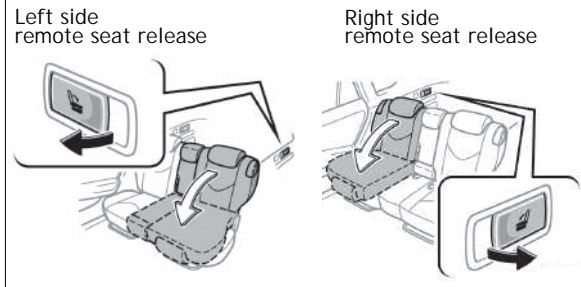

Vehicles with third row seats

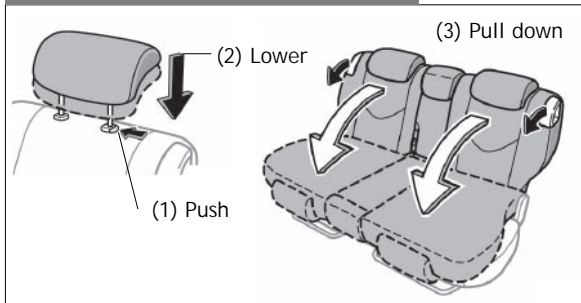

Seats-stowing third row seats (if equipped)

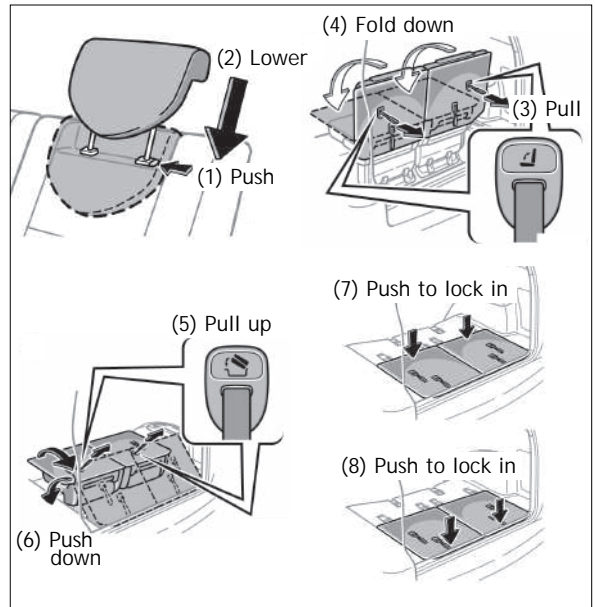

Windshield wiper & washer

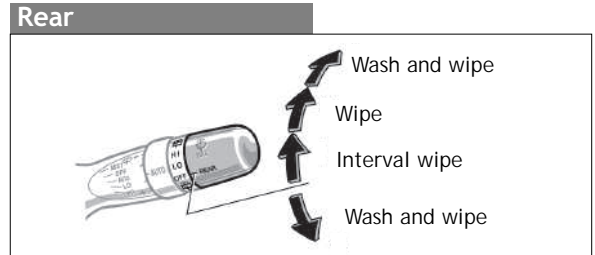
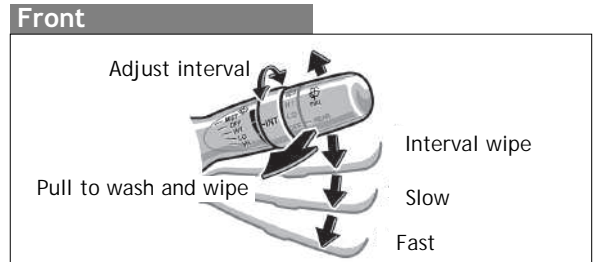

NOTE: Do not attempt to adjust while the vehicle is in motion.

Lights & turn signals

Headlights

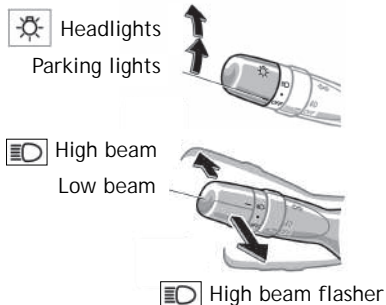

-Automatic light cutoff system Automatically turns lights off after 30 seconds when the driver's door is opened and closed with the key in "ACC" or "LOCK." Lights may also be turned off by pushing lock button on remote.

-Daytime Running Light system (if equipped) Automatically turns on the headlights at a reduced intensity.

Turn signals

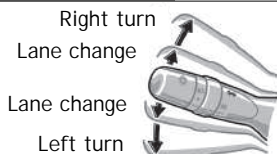

Front fog lights (if equipped)

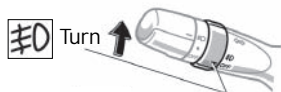

Front fog lights come on only when the headlights are on low beam.

Parking brake

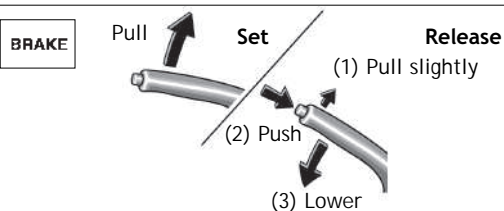

Clock

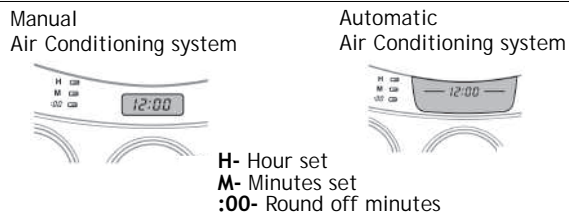

Light control-Instrument panel



Tilt and telescopic steering wheel

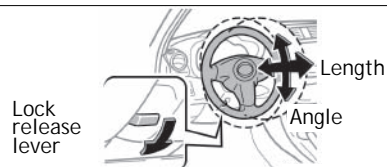

Hold wheel, push lever down, set angle and length, then return lever.

Windows

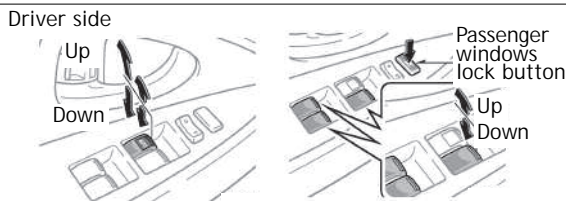

Automatic operation (Driver side only) Push the switch completely down or pull it completely up and release to fully open or close. To stop window midway, lightly push the switch in the opposite direction.

NOTE: If the battery is disconnected, windows need to be reinitialized. Refer to the Owner's Manual for more details.

Cruise control

Turning system ON/OFF

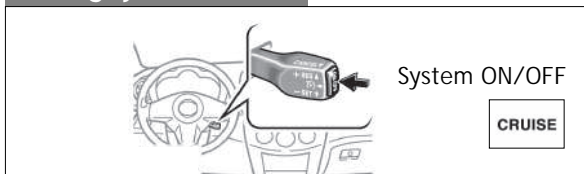

Functions

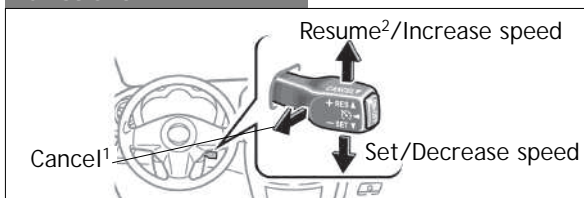

¹ The set speed may be cancelled by depressing the brake pedal.

² Unless vehicle drops below 10 mph, the set speed may be resumed once vehicle exceeds 25 mph.

Air Conditioning/Heating

Manual air conditioning

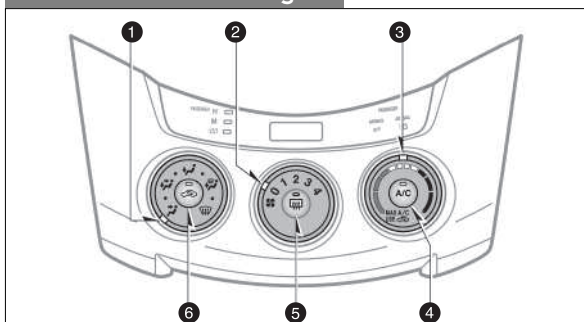

1 Air flow vent selector

In " " or " " mode, use fresh air (" " indicator OFF) to reduce window fogging.

2 Fan speed

3 Temperature

4 Air Conditioning ON/OFF

NOTE: Use fresh air to quickly cool interior, then change to recirculate for cooler air

5 Rear defogger

6 Fresh or recirculated cabin air

Automatic air conditioning

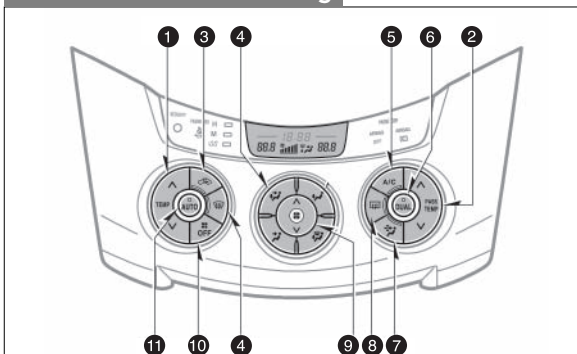

1 Temperature (Driver side)

2 Temperature (Front passenger side)

3 Fresh or recirculated cabin air

4 Air flow vent selector

In " " or " " mode, use fresh air (" " indicator OFF) to reduce window fogging

5 Air Conditioning ON/OFF

6 "DUAL" button

7 Micro dust and pollen filter ON/OFF

8 Rear defogger

9 Fan speed

10 Climate control OFF

11 Automatic climate control ON/OFF

Seat heaters (if equipped)

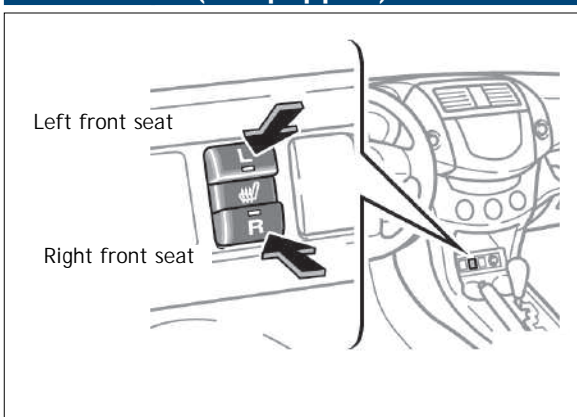

Audio

Type 1

Push to turn ON/OFF

Preset buttons - button functions in other modes indicated above number.

Eject CD
Seek station/
CD track select

Station/CD track scan

Mode

View radio and CD information

Push to adjust tone & balance

Push to skip up/down folder

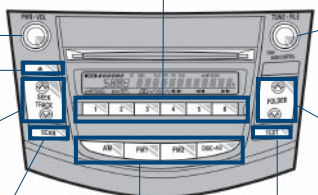

Type 2 other functions:



Load CD(s)

Push to skip up/down folder

Type 2 (with JBL speakers)



RADIO

Preset buttons Tune in the desired station and press a preset button (1-6) until you hear a beep. Push desired preset button (1-6) to select.

"SCAN" Push and hold "SCAN" to scan preset stations. Push again to hold selection.

Steering wheel switches (if equipped)

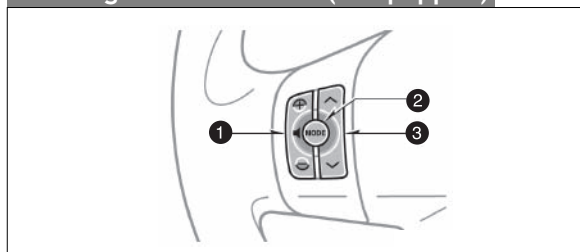

- ① **"- +"**
Volume control
- ② **"MODE"**
Push to turn audio on and select an audio mode. Push and hold to turn the audio "OFF."
- ③ **"^ v"**
-In **radio mode** Push to select a preset station, push and hold to seek the next strong station.
-In **CD mode** Push to skip up or down to the next or previous track.

AUX audio jack

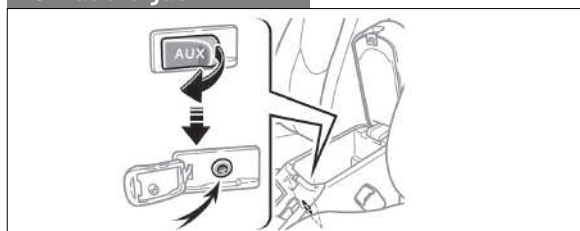

By inserting a mini plug of a commercially available component into the AUX audio jack, you can listen to music from a portable audio device through the vehicle's speaker system.

CD PLAYER

To scan tracks on a disc Push "SCAN." Push again to hold selection.

CD Changer (Type 2)

-To load one disc Push "LOAD" and insert 1 disc.

-To load multiple discs Push and hold "LOAD" until you hear a beep. Insert one disc. Shutter will close and then re-open for next disc.

To select a file (MP3/WMA only) Turn "TUNE·FILE" to file up/down.

To select a folder (MP3/WMA only) Push either side of "FOLDER."

Door locks

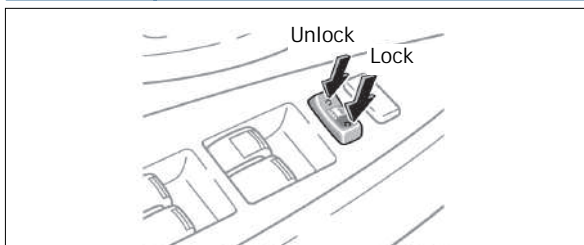

Moonroof (if equipped)

Sliding operation

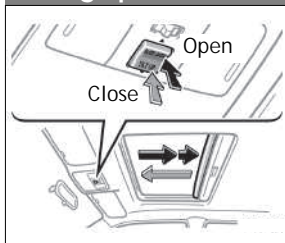

Tilting operation

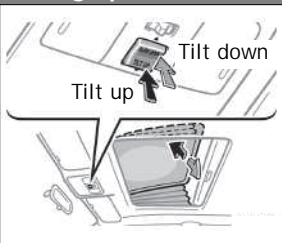

If battery is disconnected, the moonroof needs to be reinitialized. Refer to the Owner's Manual for more details.

Power outlets

12V DC

Instrument panel



Inside rear console



Luggage Compartment



NOTE: Key must be in the "ON" position to be used.

Auto LSD (Limited Slip Differential) (2WD models)



Indicator light

Push the "AUTO LSD" switch when the vehicle is stopped. To deactivate, push the switch again.

NOTE: It will **ONLY** work for 2-wheel drive models. It should **ONLY** be used when wheel spinning occurs on slippery or unpaved surfaces.

Refer to the Owner's Manual for complete details on this system before attempting to use it.

Bottle holders

Front doors



Rear doors



Cup holders

Front

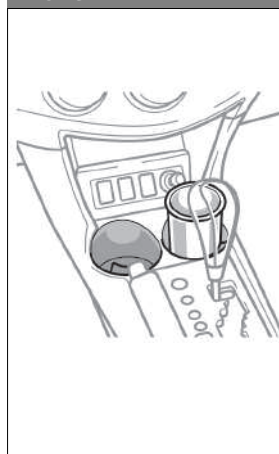

Rear

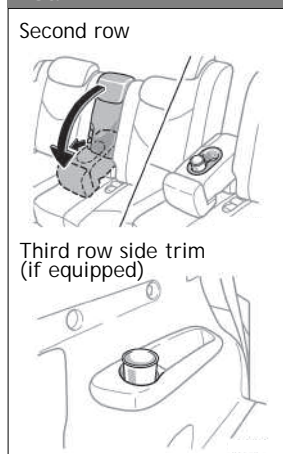

Second row

Third row side trim (if equipped)

SAFETY AND EMERGENCY FEATURES

Doors-Child safety locks

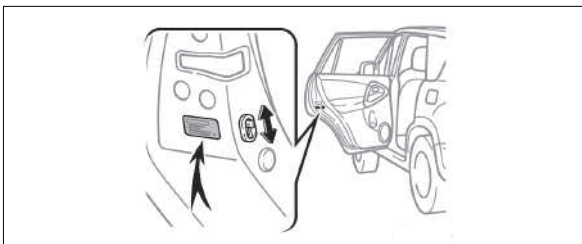

Move the lever to "LOCK," allowing the door to be opened only from the outside.

Seat belts

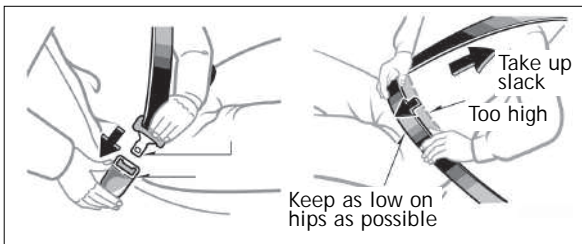

If belt is fully extended, then retracted even slightly, it cannot be re-extended beyond that point, unless fully retracted again. This feature is used to help hold child restraint systems securely.

To find more information about seat belts, and how to install a child restraint system, refer to the Owner's Manual.

Seat belts-Shoulder belt anchor

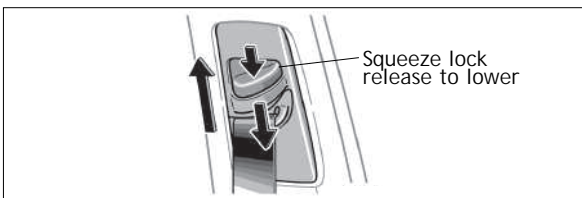

Tire Pressure Warning System

The system is designed to provide a warning when tire pressure of any one of the tires (including the spare) is critically low.

Refer to the Owner's Manual for more details.

Free Manuals Download Website

<http://myh66.com>

<http://usermanuals.us>

<http://www.somanuals.com>

<http://www.4manuals.cc>

<http://www.manual-lib.com>

<http://www.404manual.com>

<http://www.luxmanual.com>

<http://aubethermostatmanual.com>

Golf course search by state

<http://golfingnear.com>

Email search by domain

<http://emailbydomain.com>

Auto manuals search

<http://auto.somanuals.com>

TV manuals search

<http://tv.somanuals.com>