



Installation Owner Diagnostics

Water-to-Water Water-Source Heat Pump Models WPWD, GSWD and EXWA



Models

"A" and later Design Sequence

WPWD

024-072 — 60 HZ

GSWD

024-072 — 60 HZ

EXWA

240 — 60 HZ

WSHP-SVX02A-EN



Notice

NOTICE:

Warnings and Cautions appear at appropriate sections throughout this manual. Read these carefully.

⚠ WARNING -Indicates a potentially hazardous situation which, if not avoided, could result in death or serious injury.

⚠ CAUTION -Indicates a potentially hazardous situation which, if not avoided, may result in minor or moderate injury. It may also be used to alert against unsafe practices.

CAUTION -Indicates a situation that may result in equipment or property-damage-only accidents.

Important!
Equipment is shipped FOB (Free on Board) at the manufacturer. Therefore, freight claims for damages against the carrier must be initiated by the receiver.

NOTICE:
Unit contains HCFC (R-22) Refrigerant

Instructions!

Section 608, Paragraph C of the 1990 Clean Air Act states:
Effective July 1, 1992, it shall be unlawful for any person, in course of maintaining, servicing, repairing, or disposing of an air conditioning system, to knowingly vent or release any CFC or HCFC refrigerant. Minimal releases (air purges or refrigerant hoses) associated with good faith attempts to recapture or recycle are exempt from the ban on venting.

Responsible Refrigerant Practices!
Trane believes that responsible refrigerant practices are important to the environment, our customers, and the air conditioning industry. All technicians who handle refrigerants must be certified. The Federal Clean Air Act (Section 608) sets forth the requirements for handling, reclaiming, recovering and recycling of certain refrigerants and the equipment that is used in these service procedures. In addition, some states or municipalities may have additional requirements that must also be adhered to for responsible management of refrigerants. Know the applicable laws and follow them.

Contents

Installation/Startup/Commissioning	4
Pre-installation Checklist	4
General Information	5
Dimensions/Weights	6
Installation Instructions	10
Electrical Requirements	19
Pre-Startup Checklist	20
Startup/Commissioning	21
Sequence of Operation	21
Operating Pressures	22
Startup Checklist & Log	24
Maintenance	25
Warranty Information	26
Troubleshooting Checklist	28
Unit Wiring	29



Pre-installation Checklist

WARNING Fiberglass Wool!

Product contains fiberglass wool. Disturbing the insulation in this product during installation, maintenance or repair will expose you to airborne particles of glass wool fibers and ceramic fibers known to the state of California to cause cancer through inhalation. Glass wool fibers may also cause respiratory, skin or eye irritation.

Jobsite Inspection

Always perform the following checks before accepting a unit:

1. Verify that the nameplate data matches the data on the sales order and bill of lading (including electrical data).
2. Verify that the power supply complies with the unit nameplate specifications.
3. Visually inspect the exterior of the unit, for signs of shipping damage. *Do not sign the bill of lading accepting the unit(s) until inspection has been completed. Check for damage promptly after the unit(s) are unloaded. Once the bill of lading is signed at the jobsite, the unit(s) are now the property of the SOLD TO party and future freight claims MAY NOT be accepted by the freight company.*
4. Verify that the refrigerant charge has been retained during shipment by use of gauges. Schrader taps are located external to the cabinet on the 2-ton through 6-ton equipment.
5. After assuring that charge has been retained, reinstall the schrader caps to assure that refrigerant leakage does not occur.

WARNING Microbial Growth!

Wet interior unit insulation can become an amplification site for microbial growth (mold), which may cause odors and damage to the equipment and building materials. If there is evidence of microbial growth (mold) on the interior insulation, the insulation should be removed and replaced prior to operating the system.

Jobsite Storage

This unit is intended for indoor use only. To protect the unit from damage due to the elements, and to prevent possible IAQ contaminant sources from growing, the unit should be stored indoors. If indoor storage is not possible, the following provisions for outdoor storage must be met:

1. Place the unit(s) on a dry surface or raise above the ground to assure adequate air circulation beneath the unit.
2. Cover the unit(s) with a water proof tarp to protect them from the elements.
3. Make provisions for continuous venting of the covered units to prevent moisture from standing on the unit(s) surfaces. Wet interior unit insulation can become an amplification site for microbial growth (mold) which has been determined to be a cause of odors and serious health related indoor air quality problems.
4. Store units in the normal UP orientation to maintain oil in the compressor.
5. Do not stack more than three units in total height for the WPWD/GSWD 2-ton through 6-ton configurations, and no more than two units high for the EXWA 20-ton configuration.

General Information

Unit Nameplate

The unit nameplate is located at the front of the unit. It includes the unit model number, serial number, electrical characteristics, refrigerant charge, and other pertinent unit data.

Compressor Nameplate

The nameplate for the compressors are located on the compressor shell.

Unit Description

Before shipment, each unit is leak tested, dehydrated, charged with refrigerant and run tested for proper control operation.

Water-to-Refrigerant Coils

The brazed-plate water-to-refrigerant heat exchangers for the 2-ton through 6-ton equipment are constructed of stainless steel.

The water-to-refrigerant heat exchangers for the 20-ton equipment are an inner copper tube or cupro-nickel (*option available on the source-side only*) and steel tube (*tube-within-a-tube*) design.

Both heat exchanger types are leak tested to assure there is no cross leakage between the water and refrigerant gas.

Water Connections

One inch brass swivel connections are provided for the 2-ton through 6-ton equipment. Each brass fitting has a one inch gasket for the connector. The gaskets are shipped in the electrical compartment to prevent loss at the job site.

Water connections for the 20-ton are located inside the unit at the units front (source-side) and back (load-side). The fitting consist of a 2-inch female pipe threaded connection.

Controls

The *control system* offered to control the unit is a Basic 24 volt control for the 2-ton through 6-ton unit sizes, and a deluxe 24 volt micro processing board for the 20-ton unit.

All power wiring to the equipment is made at the unit contactor for the 2-

ton through 6-ton equipment, and at the power block for the 20-ton equipment.

All low voltage wiring is made at the unit's low voltage terminal board.

Wiring Connections

Troubleshooting and connection diagrams for the equipment may be located in the back of this manual.

Basic 24V Controls

(for 2-ton through 6-ton units)

Safety devices for equipment containing the basic 24V control option include a low pressure switch and a freeze-stat to prevent compressor operation during low temperature activity. The switch is set to activate at refrigerant pressures of 35 psig or 7 psig to fit most applications.

A high pressure switch prevents compressor operation during high or excessive discharge pressures exceeding 395 psig.

The lockout relay communicates the low or high pressure situation to the compressor to prevent operation. The relay may be reset at the thermostat, or by cycling power to the unit.

General alarm may be accomplished through the lockout relay to drive light emitting diodes (LEDs) on a field supplied status indicating thermostat. Terminal 6 on the lockout relay is open for field use in malfunction indications.

This feature will drive dry contacts only, and cannot be used to drive field installed control inputs.

Deluxe 24V Controls

(for 20-ton unit)

Units containing the Deluxe 24V control design will incorporate a microprocessor-based control board. The Trane microprocessor board is factory wired to a terminal strip to provide all necessary terminals for field connection. The deluxe board is equipped with a random start relay, anti-short cycle timer, brown out protection, compressor disable, unit safety control, diagnostics and a generic relay

(which may be available for field use). See page 17 for diagnostic information.

Desuperheater

(Option for 2-ton through 6-ton units)

For units containing the desuperheater option, the unit is shipped from the factory with a desuperheater water coil and pump mounted internal to the unit cabinetry. For domestic hot water hook-up instructions, see manual WSHPC-IN-4 or 72-9006-02.

The desuperheater pump fuse is located in the control box within a container. The fuse is not factory installed to avoid possible pump damage at initial start-up. If the fuse is installed and the unit is started without water in the system, the pump will be damaged. See page 17 for fuse installation.

Schrader Connections

Connections for the low and high side of the refrigeration system are located conveniently on the unit's right side for the 2-ton through 6-ton units, and behind the front, refrigeration access panel for the 20-ton unit.



Dimensions/Weights/ Clearance

Table 1: Unit weights

Size	Shipping Weight with pallet (lb)	Shipping Weight w/o pallet (lb)
024	163	153
036	183	173
042	203	193
048	214	204
060	244	234
072	277	267
240	1222	1156

WARNING Improper Unit Lift!

Test lift unit approximately 24 inches to verify proper center of gravity lift point. To avoid dropping of unit, reposition lifting point if unit is not level. Failure to properly lift unit could result in death or serious injury or possible equipment or property-only damage.

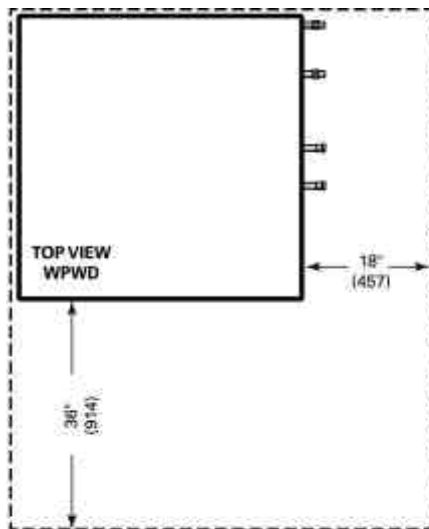

Unit Location and Clearances
Locate the unit in an indoor area. The ambient temperature surrounding the unit must not be less than 45°F. Do not locate the unit in areas subject to freezing.

Attention should be given to service clearance and technician safety. The unit access panels may be easily removed. There must be enough space for service personnel to perform maintenance or repair. Provide sufficient room to make water, and electrical connection(s). Local and national codes should be followed in providing electrical power connections. See *Figure 1* for mechanical clearances.

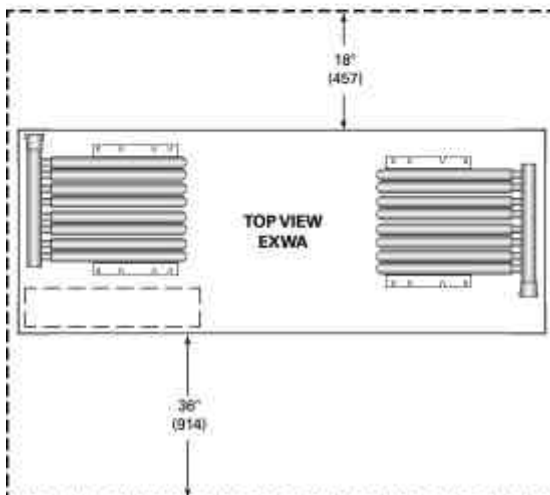
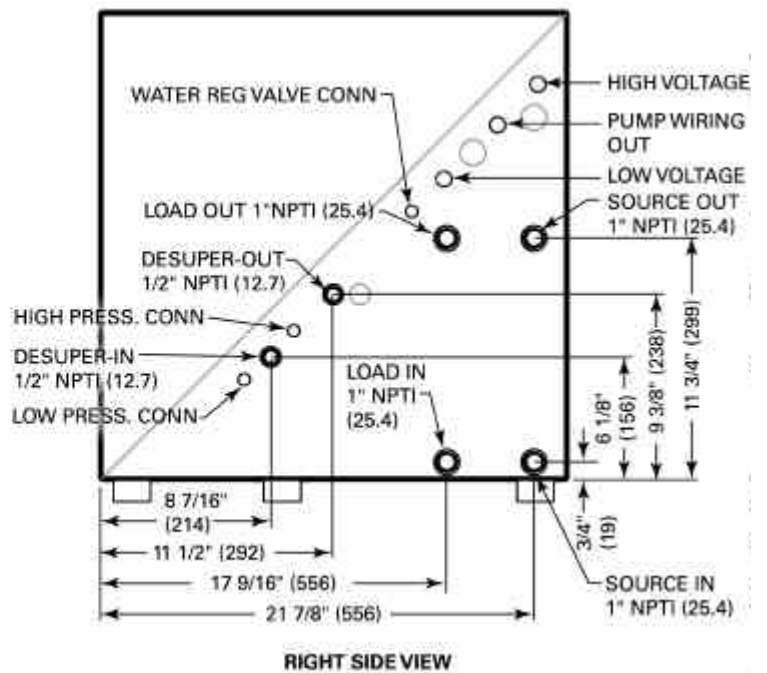
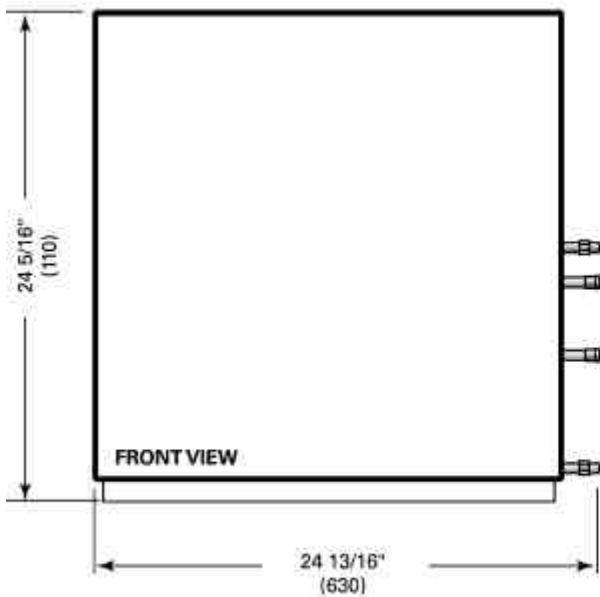
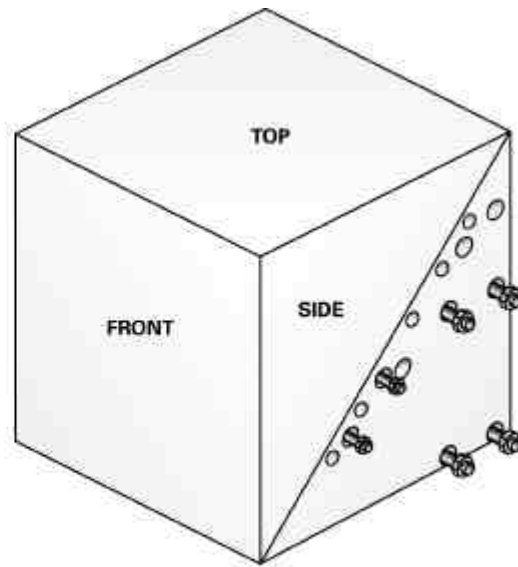
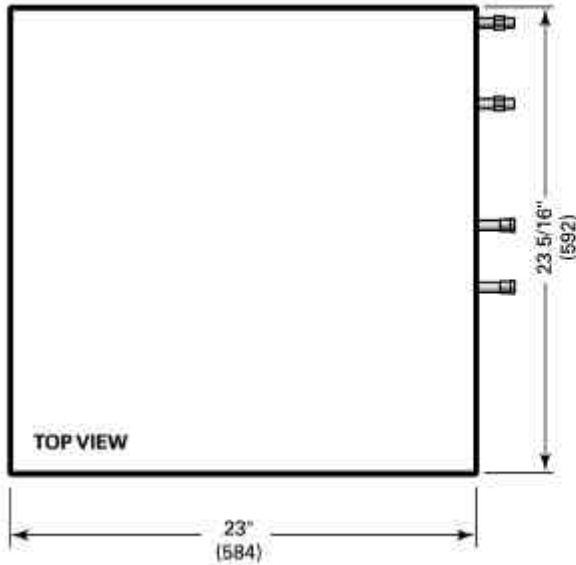

Figure 1: Mechanical clearances

Dimensions

WPWD/GSWD 024-036



Dimensions

WPWD/GSWD 042-072

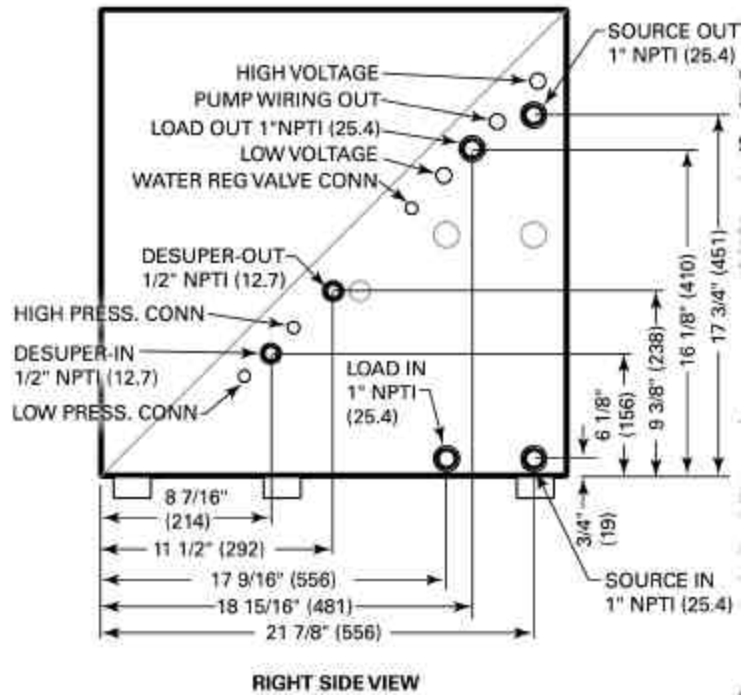
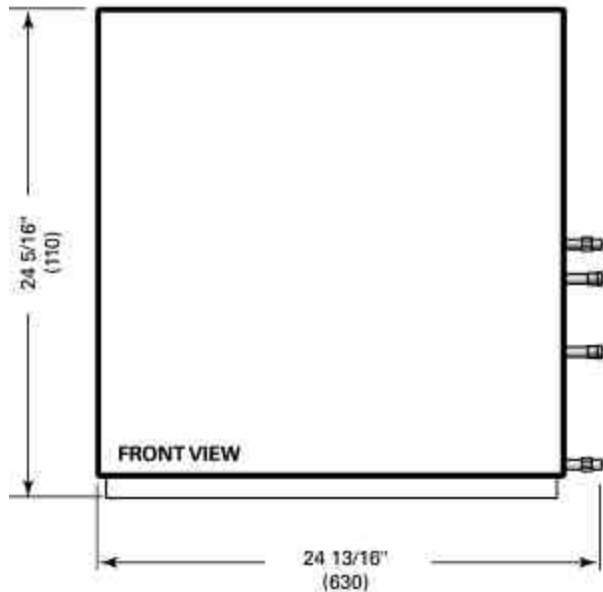
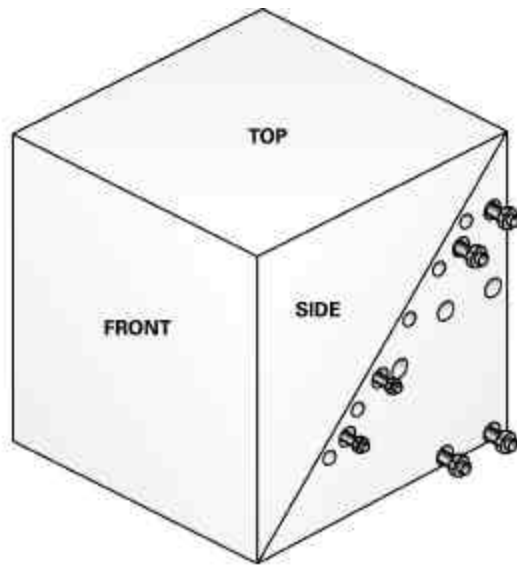
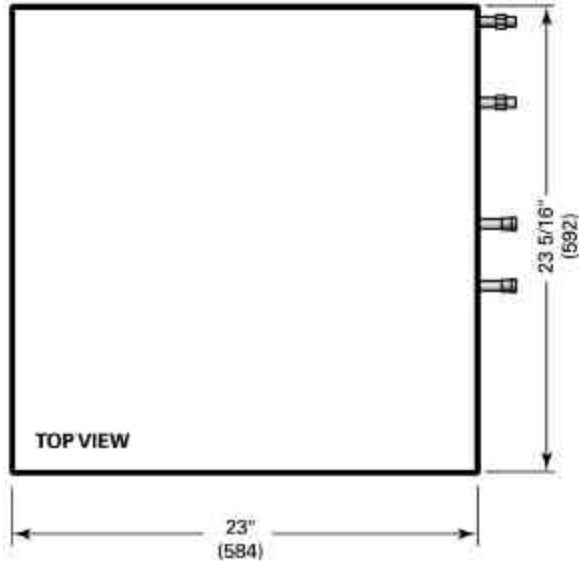

Dimensions

EXWA 240

20 TON WATER-to-WATER MODEL EXW

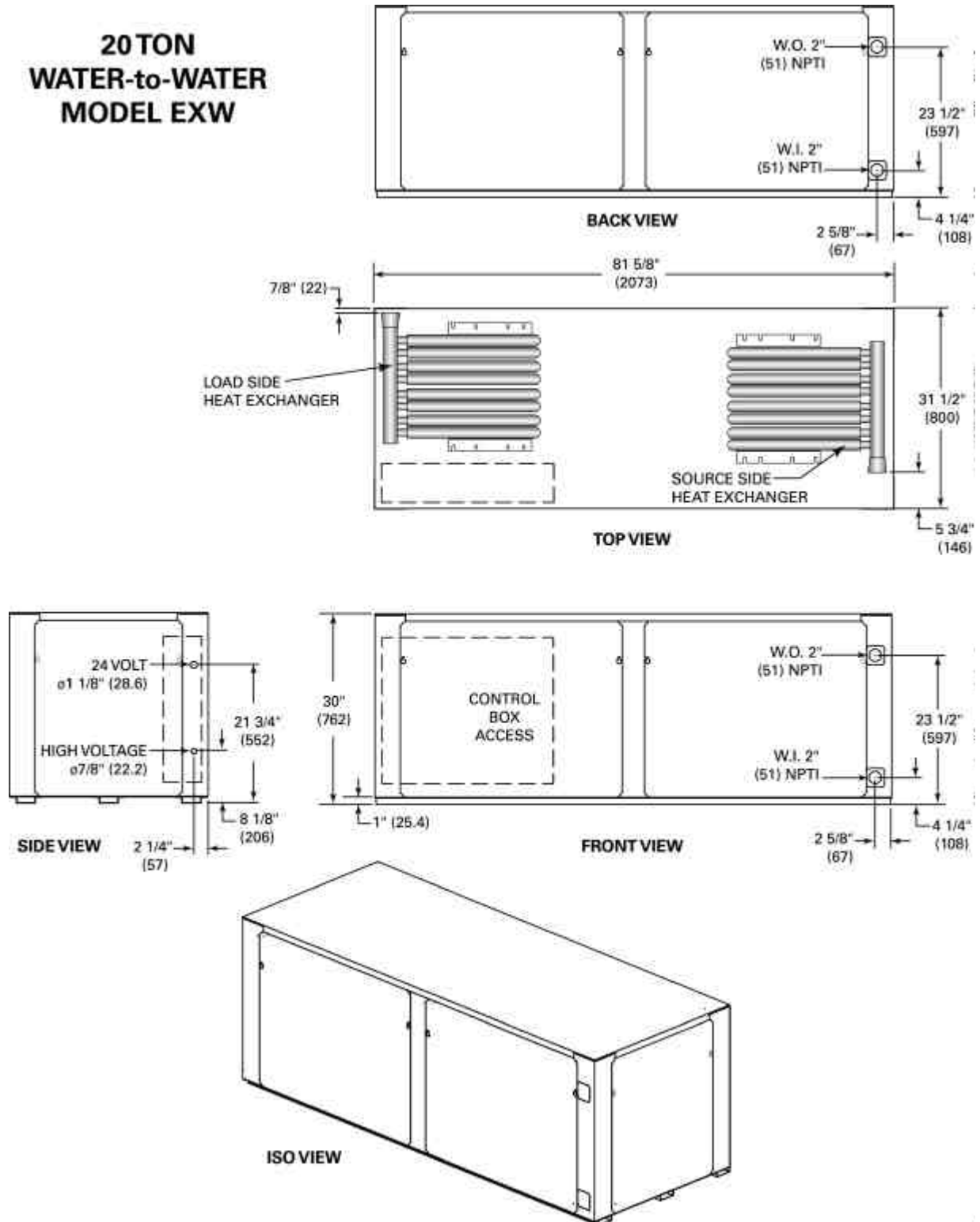



Installation

General Installation Checks

The checklist below is a summary of the steps required to successfully install a unit. This checklist is intended to acquaint the installing personnel with procedures required in the installation process. It does not replace the detailed instructions called out in the applicable sections of this manual.

- 1 Remove packaging and inspect the unit. Check the unit for shipping damage and material shortage; file a freight claim and notify appropriate sales representation.

Note: The units have been tied to the skid by (4) angle brackets. Remove these brackets from the unit to slide unit from skid.

- 2 Verify the correct model, options and voltage from the unit nameplate.
- 3 Verify the installation location of the unit will provide the required clearance for proper operation.
- 4 Remove refrigeration access panel and inspect the unit. Be certain the refrigerant tubing has clearance from adjacent parts.

WARNING Hazardous Voltage!

Disconnect all electric power, including remote disconnects before servicing. Follow proper lockout/tagout procedures to ensure the power can not be inadvertently energized. Failure to disconnect power before servicing could result in death or serious injury.

Main Electrical

- 5 Verify the power supply complies with the unit nameplate specifications.
- 6 Inspect all control panel components; tighten any loose connections.
- 7 Connect properly sized and protected power supply wiring to a field-supplied/installed disconnect switch and to the main power terminal block (1TB1) in the unit control box for the 20-ton equipment, or (1K1) for the 2-ton through 6-ton equipment.
- 8 Install proper grounding wires to an earth ground.

Note: All field-installed wiring must comply with NEC and applicable local codes.

Low Voltage Wiring (AC & DC) Requirements

- 9 Connect properly sized control wiring to the proper termination points between the field supplied thermostat and the terminal strip located in the equipment control box.

Installation



Figure 2: Racking installation

WARNING Improper Unit Lift!

Test lift unit approximately 24 inches to verify proper center of gravity lift point. To avoid dropping of unit, reposition lifting point if unit is not level. Failure to properly lift unit could result in death or serious injury or possible equipment or property-only damage.

Unit Placement

Units may be placed into a field supplied mechanical rack (See Figure 2), or placed on a finished floor. Loosen compressor bolts to release tension of the rubber grommets to help reduce vibration during operation. Sound proofing material (field supplied) is recommended to help attenuate noise generated by compressor vibration.

It is important to leave appropriate clearances around the unit to achieve maintenance and serviceability to the equipment. See page 6 for service clearance dimensions.

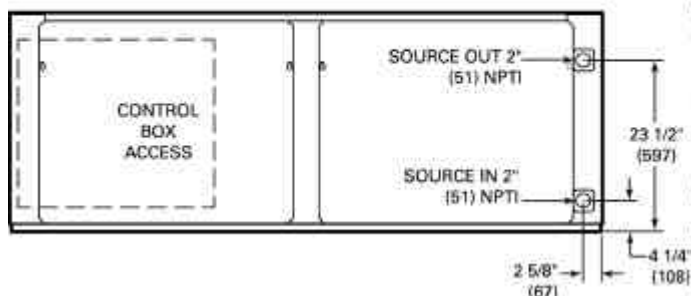
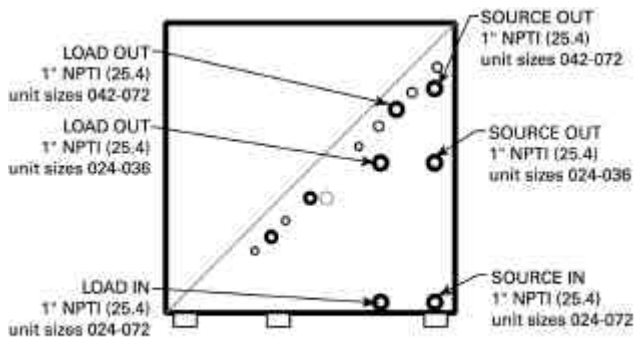

Figure 3: Water connection

Water Connection

Connect the source-side and load-side water-in/water-out from the water-to-water heat pump to the source system and the load system.

Note: The source for a water-to-water heat pump is typically a boiler/cooling tower or geothermal loop.

The load for a water-to-water heat pump is typically fresh-air unit(s), fan coil(s), hydronic coil(s), radiant heat, wall fin, or potable water.

The source and load connections for the 2-ton through 6-ton equipment is on the right hand side of the unit.

The 20-ton equipment incorporates the source-side connection at the unit's front, and the load-side connection at the unit's back.

For vibration isolation, it is recommended that flexible steel braided hoses be installed instead of hard piping the equipment to the main loop system or mechanical device.

Trane offers 4-types of hose kit variations:

- Stainless steel braided flexible hose with manual shut-off (ball) valves
- Stainless steel braided flexible hose with manual deluxe shut-off (ball) valves
- Stainless steel braided flexible hose with manual circuit-setter valve
- Stainless steel braided flexible hose with automatic balancing valve

Additional accessories, such as a strainer are recommended for use to eliminate contaminants from entering the brazed-plate or co-axial water-to-refrigerant heat exchangers.

Installation

Cleaning and Flushing the Water Loop

After the piping system is complete, the flexible hose connectors should be doubled back to complete the water circuit external to the unit (avoiding trash settle-out in the condenser). *Figure 4*. An extra pipe may be necessary to connect the hose kits. See *Page 14* for antifreeze/water mixture by volume.

(1) Water circulation system should be filled with clean water using the water make up connections. Note: Air vents should be opened during filling.

(2) With the air vents closed, start the circulating pump and then crack the air vents to bleed off the trapped air, assuring circulation through all components of the system.

Note: Make up water must be available to the system to replace the volume formerly occupied by the air that is

bled off.

(3) With the air vented and the water circulating, the entire system should be checked for leaks with repairs made as required.

(4) Operate the supplementary heat system making checks per manufacturer's instructions. During this operation, visual checks should be made for leaks that may have occurred due to increased heat. Repair as required.

(5) Open the system at the lowest point for the initial blow down (making sure the make up water is equal to the water being dumped). Continue blow down until the water leaving the drain runs clear, but not less than 2 hours.

(6) Shut down pumps and supplementary heat system. Reconnect the hoses placing the water-to-refrigerant heat exchanger in the water circulating system.

Note: Vents should be open when the pumps and supplementary heat system are shut down.

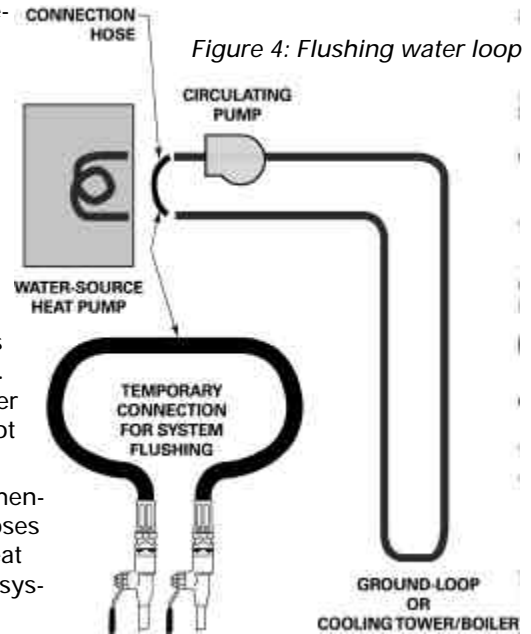

Connecting a Loop Pump Kit Closed Loop System

All piping external to the unit is the responsibility of the installer. The water pipe installation must be done in accordance with local codes. If no local code applies, national codes should be followed. It is the contractor's responsibility to know and adhere to all applicable codes.

Water inlet and outlet to the unit's water-to-refrigerant heat exchanger are clearly marked on the submittal drawings found on pages 7 through 9. The supply and return piping must be installed correctly to the unit to ensure the safety devices will work properly. Units that are not piped accordingly will not obtain the manufacturer's warranty.

A pump module (*Figure 5*) and hose kit (*Figure 6*) are typically used to connect the unit to closed loop piping in domestic applications.

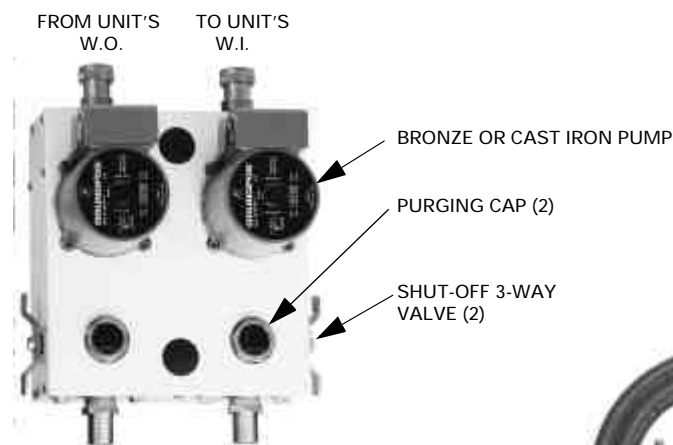

Figure 5 Pump module

1" MPT x BARB FITTINGS, 1" MPT x BARB ELBOWS with PRESSURE TEMPERATURE PORTS, AND 10' OF RUBBER HOSE with 4 HOSE CLAMPS.



Figure 6: Hose kit

Installation

Supply/Return Pipe Connections to the Loop Pump Kit

(1) Connect the supply and return hoses to the water-inlet (from supply) and water-outlet (to return) of the unit. *The rubber gaskets for the water-in and water-out connections are located in the control box. These gaskets require field installation prior to connecting the water piping to the unit.*

(2) Hand tighten the 1" FPT brass swivel quick connections to the 1" MPT adapter with P/T ports. Using a wrench, tighten the adapter approximately 1/2 additional turn. *Care must be taken to avoid overtightening as to not dislodge the snap ring.*

(3) The water lines should be routed not to interfere with access to the unit. The use of a short length of high pressure hose with the swivel fitting may simplify the connections and prevent vibration. Pressure/Temperature (P/T) ports are required for troubleshooting the hydronic side of the unit. *Extreme care should be taken by the installing contractor to prevent dirt or other foreign matter from entering the pipes or piping components during construction. Pipes should be capped until they are in place and ready to be connected to the system.*

(4) Install the Trane loop pump module. See installation manual WSHPC-IN-5 or 72-9006-03 for instructions. If the unit *does not* contain a Trane loop pump module, two ball valves must be installed between the unit and the loop's water pump to isolate the unit from the system's water loop during maintenance and emergency situations. *See Figure 7.*

If the unit *s* contain a Trane loop pump module, shut-off valves are supplied by the manufacturer within the pump module assembly.

(5) Connect the unit's water-in and water-out hose to the loop pump module.

(6) The pumps connect to the load side 230 volt compressor contactor, and require a field installed 6 amp in-line fuse and holder.

(7) Insulate all indoor piping. *Equipment is designed to operate with fluid temperature of 25°F to 120°F*

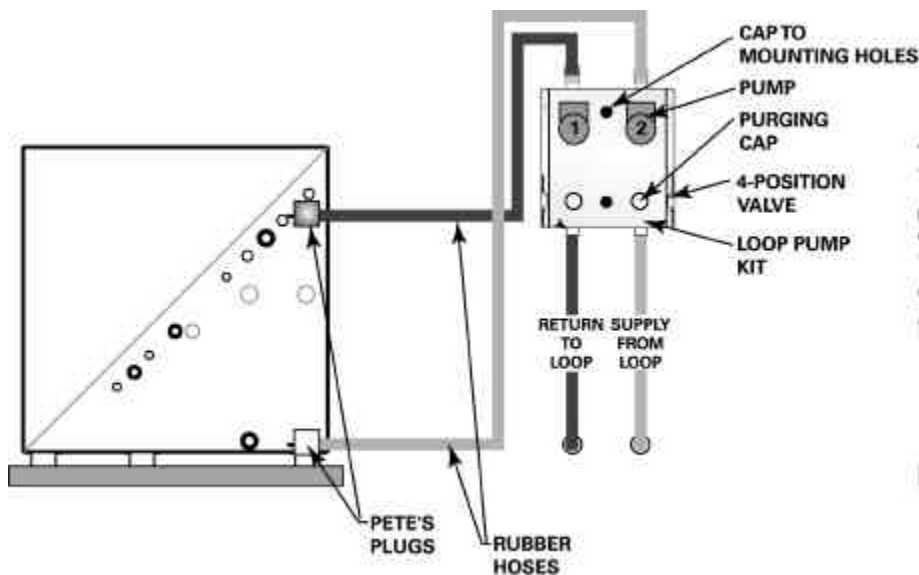

Figure 7: Loop pump kit installation

Installation

Water Heater Hook-up (option)

Instructions for connection from the desuperheater (option) water-in/out to the domestic hot water heater may be found in WSHPC-IN-4 or 72-9006-02. This water heater kit (Figure 8) ships in all units with the desuperheater option. The kit is zip tied to the compressor base; and consists of piping connections and shut-off valve.

For units containing the desuperheater option, the desuperheater pump fuse is located within a container inside of the control box. The fuse is not factory installed.

Note: If the fuse is installed, and the unit is started without water in the system, pump damage may occur.

Using Antifreeze

In areas of the country where entering water temperatures drop below 45°F or where piping is being run through areas subject to freezing, the loop must be freeze protected by using an approved antifreeze solution to prevent the earth loop water from freezing inside the heat exchanger.

Methanol and glycols are the most commonly used antifreeze solutions. Consult your geothermal unit supplier for locally approved solutions in your area.

Propylene glycol is not recommended in installations where the water temperature are expected to fall below 30°F. At extreme temperatures, the viscosity increases to the point where normal loop circulating pumps may not maintain proper flow.

If propylene glycol is the only locally approved solution for anti-freeze, good engineering practices should be used to achieve the desired flow.

Calculate the approximate volume of water in the system by using the requirements detailed in Table 2. Add three gallons to this total to allow for the water contained in the hose kit and geothermal unit.

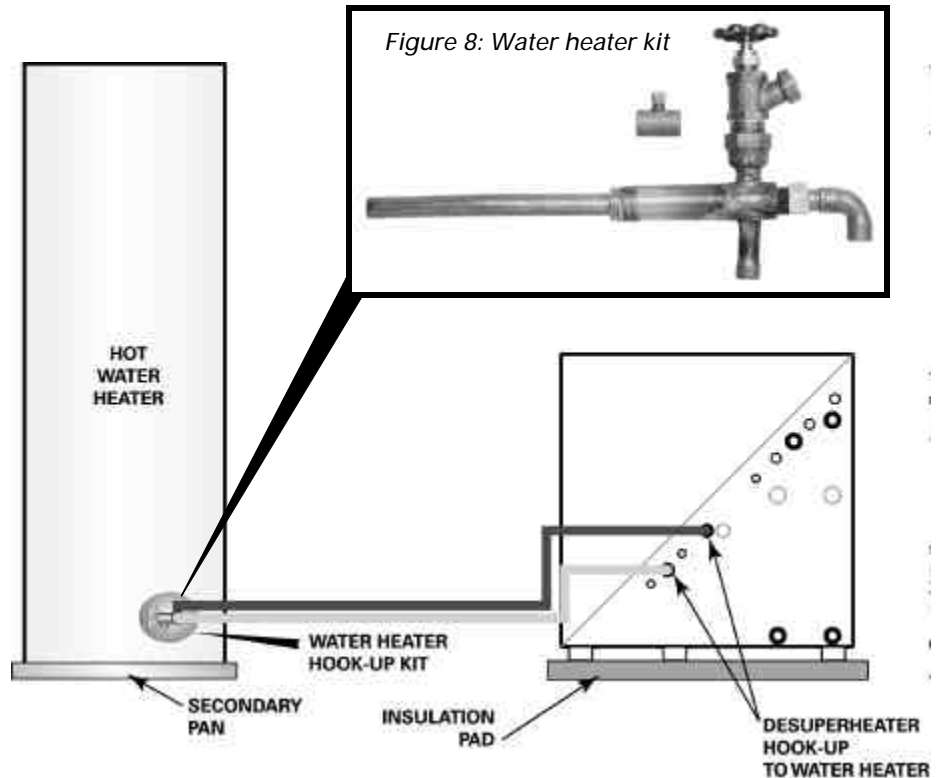

Table 2: Antifreeze requirements based on volume

Type of Antifreeze	Minimum Temperature for Freeze Protection				
	10°F	15°F	20°F	25°F	30°F
Methanol	25%	21%	16%	10%	3%
Propylene Glycol	-	-	-	-	6%

Installation

Filling the Loop Pump Kit System
Once the loop, pump module and unit are fully connected, the system will need to be filled with water or water/antifreeze solution. See *Page 14* for antifreeze/water mixture by volume.

Fill both sides of the outside portion of the loop first via the pump module. The hose kit and unit should be filled last after purging of the ground loop is complete.

To fill the outside loop; (1) attach a water hose to the 1-inch FPT brass valve ports located on the front of the pump module (the caps at the front of the module should be removed). (2) Rotate both valve 1 and valve 2 to the "Position B" to prevent water from going to the unit. (3) Turn on the water and allow the earth loop to slowly fill with water. (4) Run the water until a steady flow of water without air bubbles is observed coming out of the discharge hose.

To fill the hose kit and unit; (1) Reposition valve 1 to the "Position A" to fill the unit and hose kit. (2) Turn the water on and allow the hose kit and unit to be filled slowly with water. (3) Run the water until a steady flow of water without air bubbles is observed coming out of the discharge hose.

System Pressurization

(1) Rotate both valves 1 and 2 to the "Position D" to pressurize the system. (2) Examine all internal unit fittings or connections for leaks. (3) After checking for leaks, the system is ready to be flushed.

Note: There may be a certain amount of entrained air left in the loop system.

Cleaning and Flushing the Water Loop

All installations must be thoroughly flushed to remove air and dirt from the earth loop before running the system. The pumps used in the pump module are not adequate to use for the flushing out of the unit. A secondary pump capable of delivering 50 gpm at 60 feet of head (a 1 1/2 hp or larger pump) is

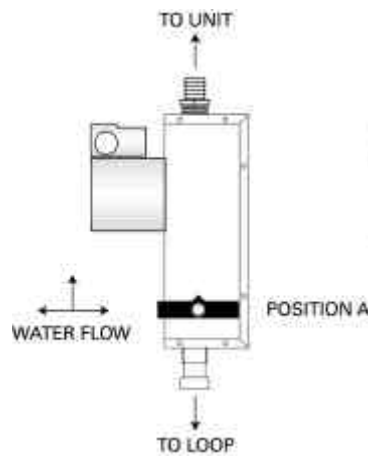

Filling the Hose Kit and Unit and/or
Hose Kit and Unit Flush

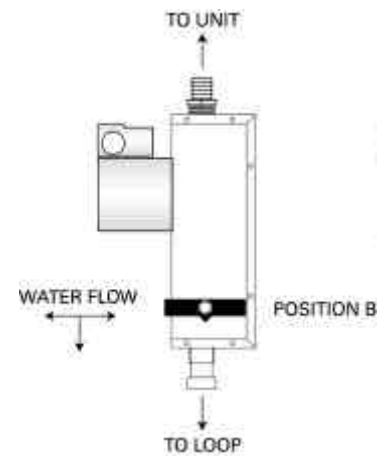

Filling the Outside Loop and/or
Outside Loop Flush

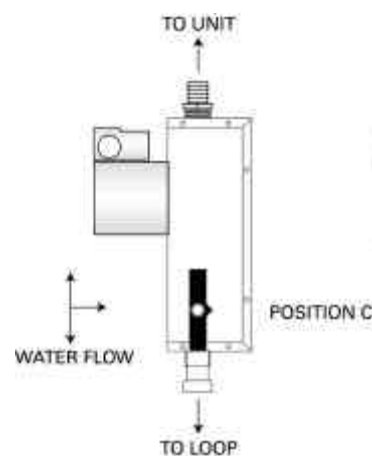

Run System

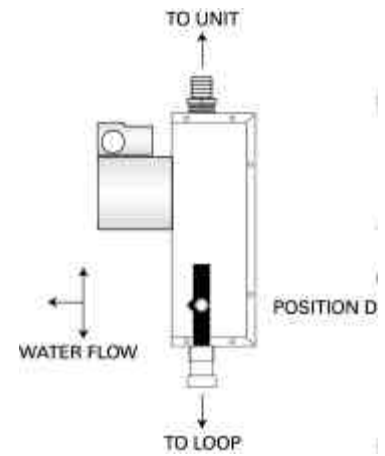

Full System Flush

normally suitable for jobs up to six tons. The loop must be flushed with a high volume of water at a minimum velocity of (2 feet per second) in both directions. See *Table 3* for flow rates required to flush earth loops.

Table 3: System flushing flow rates

Pipe	Gallons per 100 Ft.	Minimum Flush GPM
3/4" PE	3.02	3.8
1" PE	4.73	6.0
1 1/4" PE	7.55	9.5
1 1/2" PE	9.93	13.0
2" PE	15.36	21.0

Note: The plastic 1-inch MPT valve plugs must be replaced after filling and/or flushing is completed.

See "Position C" for valve rotation to place the valves in RUN position.



Installation Power Wiring

Field Installed Power Wiring

Power wiring to the equipment must conform to National and Local Electric Codes (NEC) by a professional electrician.

WARNING Live Electrical Components!

During installation, testing, servicing and troubleshooting of this product, it may be necessary to work with live electrical components. Have a qualified licensed electrician or other individual who has been properly trained in handling live electrical components perform these tasks. Failure to follow all electrical safety precautions when exposed to live electrical components could result in death or serious injury.

Verify that the power supply available is compatible with the unit's nameplate. Use only copper conductors to connect the power supply to the unit.

CAUTION Use Copper Conductors Only!

Unit terminals are not designed to accept other types of conductors. Failure to use copper conductors may result in equipment damage.

Main Unit Power Wiring

A field supplied disconnect switch must be installed at or near the unit in accordance with the National Electric Code (NEC latest edition).

Location of the applicable electric service entrance for HIGH (line voltage) may be found on the unit submittal at the front of this manual (pages 7 through 9).

The high voltage connection is made at the 1TB1 terminal block for the 20-ton equipment, and at 1K1 for the 2-ton through 6-ton equipment. The terminal block or contactor is located inside the unit control box. Refer to the customer connection diagram that is shipped with the unit for specific termination points.

Provide proper grounding for the unit in accordance with the local and national codes.

Control Power Transformer

The 24-volt control power transformers are to be used only with the accessories called out in this manual.

Transformers rated greater than 50 VA are equipped with internal circuit breakers. If a circuit breaker trips, turn OFF all power to the unit before attempting to reset it.

WARNING Hazardous Voltage!

Disconnect all electric power, including remote disconnects before servicing. Follow proper lockout/tagout procedures to ensure the power can not be inadvertently energized. Failure to disconnect power before servicing could result in death or serious injury.

The transformer is located in the control box.

Installation

Low Voltage Wiring

Controls Using 24 VAC

Before installing any wire, refer to the electrical access locations on the unit submittals located on pages 7 through 9.

Ensure that the AC control wiring between the controls and the unit's termination point does not exceed three (3) ohms/conductor for the length of the run.

Note: Resistance in excess of 3-ohms per conductor may cause component failure due to insufficient AC voltage supply.

Check all loads and conductors for grounds, shorts, and mis-wiring.

Use copper conductors unless otherwise specified.

Do not run the AC low voltage wiring in the same conduit with the high voltage power wiring.

Table 4: 24V AC conductors

Distance from unit to Control	Recommended Wire Size
000-460 feet	18 gauge
461-732 feet	16 gauge
733-1000 feet	14 gauge

Low voltage connection diagrams are shown in *Figure 9*. Optional desuperheater fuse installation shown in *Figure 10*.

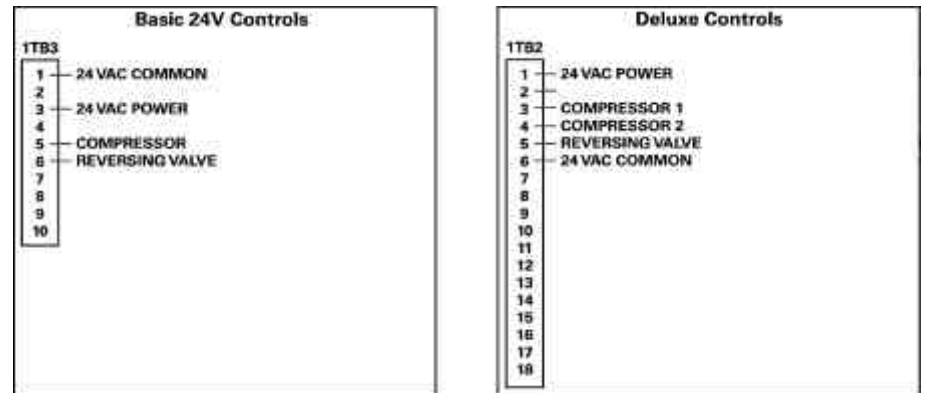

Figure 9: Low voltage connection

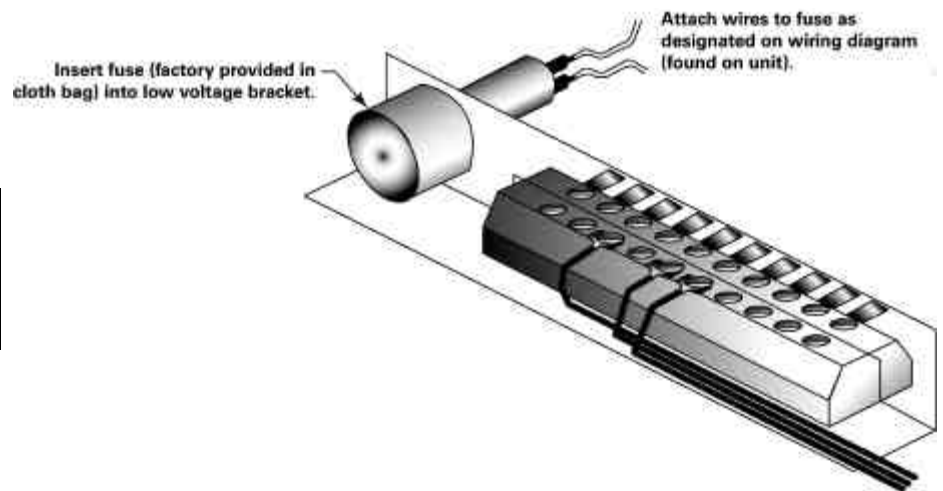

Figure 10: Desuperheater fuse installation

Table 5: Deluxe controller diagnostic LEDs

Color: Green	Color: Red		Controller Mode
LED1	LED2	LED3	
OFF	OFF	OFF	Control OFF
ON	OFF	OFF	Normal/Compressor OFF
ON	OFF	FLASH	Anti-short Cycle
ON	OFF	ON	Normal/Compressor ON
FLASH	ON	OFF	Brownout Condition
ON	FLASH	ON	Soft Lockout (low pressure)
ON	FLASH	FLASH	Soft Lockout (high pressure)
ON	ON	ON	Manual Lockout (low pressure)
ON	ON	FLASH	Manual Lockout (high pressure)
ON	FLASH	OFF	Manual Lockout (condensate overflow)
ON	ON	OFF	Compressor Disable

Installation

Changing Freezestat or Low Pressure Cutout Switches

(WPWD/GSWD models ONLY)

Each unit has two factory installed low pressure cutout switches and one freezestat. Only one of the low pressure cutout switches is connected to the 24 volt control circuit, dependent on which freezestat is being used (i.e. 35°F or 20°F). Both the freezestat and the low pressure cutout are in the lockout relay circuit. The freezestat monitors the temperature of the water leaving the source and load side water-to-refrigerant heat exchangers, protecting the heat exchanger from fluid freeze up. The low pressure cutout monitors the suction pressure of the compressor to protect the compressor from liquid floodback or operating under loss of charge conditions.

Units can be ordered from the factory with either the 35°F or 20°F freezestat option. The 20°F freezestat is ONLY used on closed loop systems with antifreeze solution. The 35°F freezestat is used on all other systems. The type of freezestat on a unit can be determined from the appropriate digit in the model number. Digit 11 and/or 12 with a selection of 1 is a 35°F freezestat, whereas selection 2 is a 20°F freezestat.

What Freezestat Should Be Applied?

As previously mentioned, every unit is shipped from the factory with two low pressure cutouts installed in the refrigerant circuit. One of the low pressure cutouts disables the compressor at 35 psig, while the other disables the compressor at 7 psig. The 35 psig cutout is used with the 35°F freezestat, while the 7 psig cutout is used with the 20°F freezestat.

Occasionally it will be necessary to change the freezestat in the field. Examples of when this change-out is necessary include:

(1) A unit with a 35°F freezestat is going to be put on a closed loop system with antifreeze. By definition, the unit requires a 20°F freezestat.

(2) A unit with a 20°F freezestat is going to be put on an open well system or a closed loop system with NO antifreeze solution. By definition, the unit must have a 35°F freezestat installed prior to operation.

The best time to install the freezestat/low pressure cutout is prior to installing the unit. The freezestat is easily accessible from the top service door.

WARNING Hazardous Voltage!

Disconnect all electric power, including remote disconnects before servicing. Follow proper lockout/tagout procedures to ensure the power can not be inadvertently energized. Failure to disconnect power before servicing could result in death or serious injury.

Changing a Freezestat and Low Pressure Cutout

The freezestat is located in the top of the source-side water-to-refrigerant heat exchanger leaving water line. The freezestat is located in the twelve o'clock position. The capillary tube is inserted into the well approximately 8-inches. Remove the existing freezestat and replace it with the new freezestat.

Note: The wires must be moved from one low pressure cutout to the other.

The low pressure cutouts are located in the *insulated refrigerant lines*. The high pressure cutout is located in the un-insulated compressor discharge line and is the only pressure cutout located in this line. Change the wires from

the old low pressure cutout to the new low pressure cutout.

Identifying the Low Pressure Cutouts
The 7 psig low pressure cutout is used with a 20°F freezestat. It is installed in the insulated line and is in the piping tee going to the external schrader port. The 35 psig low pressure cutout is used with a 35°F freezestat. It is installed in the insulated line and is not connected to any fittings.

The 395 psig high pressure cutout is installed in the un-insulated compressor discharge line. It is the only cutout located in this line. Further, it is connected to an external schrader port.

If the low pressure cutout is not changed when the freezestat is changed, problems will occur. If the 35 psig low pressure cutout is connected to a 20°F freezestat, the unit will go out repeatedly on the low pressure cutout. If the 7 psig low pressure cutout is used with the 35°F freezestat, no problems will occur as long as the freezestat is operating normally. However, if the freezestat does fail, the loop water could freeze before the suction pressure dropped low enough for the 7 psig cutout to take the unit off the line. Also, in a loss of charge situation, the heat exchanger would freeze before the freezestat could take the unit off-line.

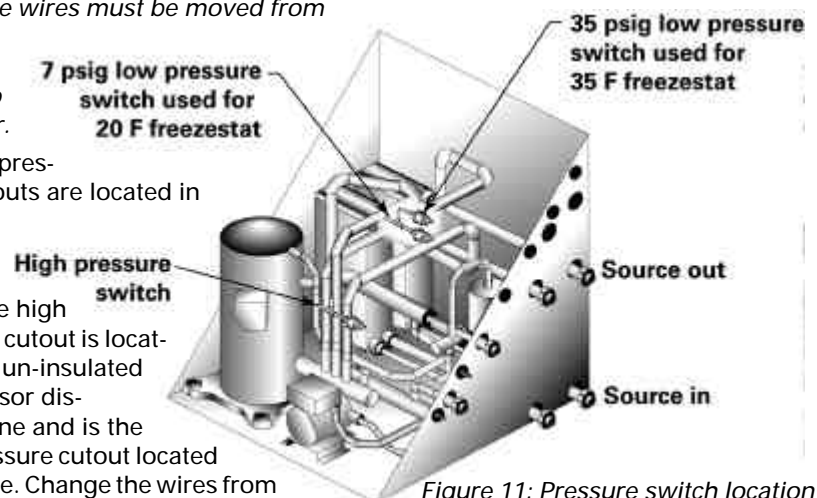

Figure 11: Pressure switch location

Electrical Requirements

Table E-1: Electrical performance WPWD/EXWA

Model/MBH	VOLTS-AC/HZ/PH	Min. Util. Volt	Max Util. Volt	Compressor Each RLA	LRA	No. of Comp	Without Desup		With Desup		
							MCA	Max Fuse	Desup RLA	MCA	Max Fuse
WPWD024	208-230/60/1	197	253	11.4	56.0	1	14.3	25	0.4	14.7	25
	220-240/50/1	198	264	9.6	47.0	1	12.0	20	0.4	12.4	20
	265/60/1	239	292	9.6	47.0	1	12.0	20	0.4	12.4	20
WPWD036	208-230/60/1	197	253	15.0	73.0	1	18.8	30	0.4	19.2	30
	208-230/60/3	197	253	10.7	63.0	1	13.4	20	0.4	13.8	20
	220-240/50/1	198	264	14.3	71.0	1	17.9	30	0.4	18.3	30
	265/60/1	239	292	14.3	71.0	1	17.9	30	0.4	18.3	30
	380-415/50/3	342	456	5.0	31.0	1	6.3	15.0	0.4	6.7	15.0
	460/60/3	414	506	5.0	31.0	1	6.3	15	0.4	6.7	15
WPWD042	208-230/60/1	197	253	18.4	95.0	1	23.0	40	0.4	23.4	40
	208-230/60/3	197	253	11.4	77.0	1	14.3	25	0.4	14.7	25
	220-240/50/1	198	264	16.4	83.0	1	20.5	35	0.4	20.9	35
	265/60/1	239	292	16.4	83.0	1	20.5	35	0.4	20.9	35
	380-415/50/3	342	456	5.7	39.0	1	7.1	15.0	0.4	7.5	15.0
	460/60/3	414	506	5.7	39.0	1	7.1	15	0.4	7.5	15
WPWD048	208-230/60/1	197	253	20.4	109.0	1	25.5	45	0.4	25.9	45
	208-230/60/3	197	253	13.9	88.0	1	17.4	30	0.4	17.8	30
	380-415/50/3	342	456	7.1	44.0	1	8.9	15.0	0.4	9.3	15.0
	460/60/3	414	506	7.1	44.0	1	8.9	15	0.4	9.3	15
WPWD060	208-230/60/1	197	253	28.0	169.0	1	35.0	60	0.4	35.4	60
	208-230/60/3	197	253	20.0	123.0	1	25.0	45	0.4	25.4	45
	380-415/50/3	342	456	7.5	49.5	1	9.4	15.0	0.4	9.8	15.0
	460/60/3	414	506	7.5	49.5	1	9.4	15	0.4	9.8	15
	575/60/3	517	633	6.4	40.0	1	8.0	15	0.4	8.4	15
WPWD072	208-230/60/1	197	253	32.1	169.0	1	40.1	70	0.4	40.5	70
	208-230/60/3	197	253	19.3	137.0	1	24.1	40	0.4	24.5	40
	380-415/50/3	342	456	10.0	62.0	1	12.5	20.0	0.4	12.9	20.0
	460/60/3	414	506	10.0	62.0	1	12.5	20	0.4	12.9	20
	575/60/3	517	633	7.8	50.0	1	9.8	15	0.4	10.2	15
EXWA180	380-415/50/3	342	456	16.7	133.0	2	37.58	50	--	--	--
EXWA240	208/60/3	197	229	31.7	232.0	2	71.39	100	--	--	--
	230/60/3	207	253	31.7	261.0	2	71.39	100	--	--	--
	460/60/3	414	506	14.1	112.0	2	31.73	45	--	--	--
	575/60/3	518	633	11.2	92.0	2	25.24	35	--	--	--

Table E-2: Electrical performance GSWD

Model/MBH	VOLTS-AC/HZ/PH	Min. Util. Volt	Max Util. Volt	Compressor Data		No. of Comp	Aux Pump Amps	Desup		
				RLA	LRA			Pump RLA	MCA	Max Fuse
GSWD024	208-230/60/1	197	253	11.4	56.0	1	2.5	0.4	17.2	25
GSWD036	208-230/60/1	197	253	15.0	73.0	1	2.5	0.4	21.7	35
GSWD042	208-230/60/1	197	253	18.4	95.0	1	2.5	0.4	25.9	40
GSWD048	208-230/60/1	197	253	20.4	109.0	1	2.5	0.4	28.4	45
GSWD060	208-230/60/1	197	253	28.0	169.0	1	2.5	0.4	37.9	60
GSWD072	208-230/60/1	197	253	32.1	169.0	1	2.5	0.4	43.0	70



Pre-Start Checklist

Pre-Start-up Checklist

Before energizing the unit, the following system devices must be checked:

- Is the high voltage power supply correct and in accordance with the nameplate ratings?
- Is the field wiring and circuit protection the correct size?
- Is the low voltage control circuit wiring correct per the unit wiring diagram?
- Is the piping system clean/complete and correct? *(A recommendation of all system flushing of debris from the water-to-refrigerant heat exchanger, along with air purging from the water-to-refrigerant heat exchanger be done in accordance with the Closed-Loop/Ground Source Heat Pump Systems Installation Guide).*
- Is vibration isolation provided? (i.e. unit isolation pad, hosekits)
- Is unit serviceable? *(See clearance specifications on page 6).*
- Are the low/high-side pressure temperature caps secure and in place?
- Are all the unit access panels secure and in place?
- Is the thermostat in the OFF position?
- Is the water flow established and circulating through all the units?
- Is the zone sensor correctly wired and in a good location?
- Has all work been done in accordance with applicable local and national codes?
- Has heat transfer fluid been added in the proper mix to prevent freezing in closed system application?



Sequence of Operation

Initial Unit Start-up

Start-up with the system controls is included below: *Note: Air Handlers should not be operated in the construction phase of dry walling. The air-to-refrigerant coil will foul, and the warranty will be void.*

1. Set the system control to the desired mode of operation.
2. Set the control switch to fans and circulation pumps. *The compressor should NOT run.*
3. Reduce the temperature control setting until the compressor, reversing valve, solenoid valve, and loop pump are energized. *Adjust water flow utilizing pressure/temperature plugs and comparing to tables contained in specification sheet data. Water leaving the heat exchanger should be warmer than the entering water temperature (approximately 9° F-12° F); compressor amps should be within data plate ratings; the suction line should be cool with no frost observed in the refrigerant circuit.*
4. Check the cooling refrigerant pressures against values in Table OP1. (Page 22).
5. Turn the system control switch to the OFF position. *Unit should stop running and the reversing valve should de-energize.*
6. Leave unit off for approximately FIVE minutes to allow for pressure equalization.
7. Turn the thermostat to the lowest setting.
8. Set the thermostat system switch to the opposite mode of operation.
9. Adjust the temperature setting upward until the unit is energized. *A water temperature decrease of approximately 5° F-9° F leaving the heat exchanger should be noted. The compressor operation should be smooth with no frost observed in the refrigeration circuit.*
10. Check the heating refrigerant pressures against values in Table OP1. (Page 22)
11. Set the system control to maintain the desired space temperature.
12. Instruct the owner on system operation.



Operating Pressures

Operating Pressures

Table OP-1: Cooling mode operating pressures

Unit Size	Entering Load (Degree F)	Entering Source Temperature (Degree F)					
		50		86		104	
		Suction Pressure	Discharge Pressure	Suction Pressure	Discharge Pressure	Suction Pressure	Discharge Pressure
EXWA 240	53.6	46-56	103-143	49-59	188-228	49-59	238-278
EXWA 240	86	61-71	111-151	84-94	205-245	87-97	259-299

Table OP-2: Heating mode operating pressures

Unit Size	Entering Load (Degree F)	Entering Source Temperature (Degree F)					
		50		68		104	
		Suction Pressure	Discharge Pressure	Suction Pressure	Discharge Pressure	Suction Pressure	Discharge Pressure
EXWA 240	75	46-56	160-200	65-75	170-210	86-96	183-223
EXWA 240	104	49-59	245-285	68-78	254-294	94-107	268-308
EXWA 240	122	49-59	310-350	68-78	320-360	95-105	333-373



Operating Pressures

Water Pressure Drop

Tables 6 and 7 should be used to define feet of head/pressure drop. *Note: To calculate feet of head, when using gauges that read in PSIG, multiply PSI by 2.31.*

Table 6: Cooling water pressure drops (WPD) in feet of head

Unit Size	GPM	Source		Load	
		EWT F	Ft. Head Pressure	EWT F	Ft. Head Pressure
024	3.8	80	1.3	53.6	1.6
	7.0		4.5		5.4
	8.9		7.2		8.7
036	4.6	80	1.9	53.6	2.3
	8.5		6.6		7.9
	10.8		10.6		12.7
042	5.2	80	2.4	53.6	3.0
	9.5		8.6		10.3
	12.1		14.1		17.1
048	6.0	80	3.3	53.6	4.0
	11.0		11.6		14.0
	14.0		19.1		23.1
060	7.6	80	5.4	53.6	6.5
	14.0		19.1		23.1
	17.8		31.5		38.1
072	8.7	80	7.1	53.6	8.6
	16.0		25.3		30.5
	20.4		41.8		50.5
240	30.0	80	2.9	53.6	3.6
	55.0		8.1		9.7
	70.0		12.2		14.7

Table 7: Heating water pressure drops (WPD) in feet of head

Unit Size	GPM	Source		Load	
		EWT F	Ft. Head Pressure	EWT F	Ft. Head Pressure
024	3.8	60	1.5	80	1.3
	7.0		5.1		4.5
	8.9		8.3		7.2
036	4.6	60	2.2	80	1.9
	8.5		7.6		6.6
	10.8		12.2		10.6
042	5.2	60	2.8	80	2.4
	9.5		9.8		8.6
	12.1		16.2		14.1
048	6.0	60	3.8	80	3.3
	11.0		13.3		11.6
	14.0		21.9		19.1
060	7.6	60	6.2	80	5.4
	14.0		21.9		19.1
	17.8		36.1		31.5
072	8.7	60	8.2	80	7.1
	16.0		28.9		25.3
	20.4		47.9		41.8
240	30.0	60	3.4	80	2.9
	55.0		9.2		8.1
	70.0		13.9		12.2

Water Volume

Table 8 is provided for use in calculating glycol requirements for the unit.

Table 8: Water volume

Unit Size	Water Side Volume Cubic In.	Water Side Volume Cubic Ft.	Water Side Volume Gallons
024	55	0.032	0.238
036	105	0.061	0.455
042	105	0.061	0.455
048	259	0.150	1.121
060	259	0.150	1.121
072	259	0.150	1.121
240	1057	0.615	4.576

Note: The EXWA 240 has two circuits.

Flow Checks

For the operating temperature drop (heating) and rise (cooling), refer to Table OP1 and OP2 for the proper water temperature change. Depending on the unit size, entering water temperature and water flow rate, the cooling temperature rise is from 8°F-16°F. Based on the same criteria for heating, the temperature drop is from 2°F-13°F.

Pressure

Using the P/T ports and one 0-60 psi pressure gauge with the P/T port adapter, measure the pressure difference between the water-in and water-out connections. Compare the pressure differential to Table 6 to determine flow.

Start-up Checklist and Log

Use the form on page 24 to log system and unit temperatures during start-up.



Start-up Checklist and Log

Installing Contractor: Use this form to thoroughly check-out the system and units before and during start-up. (This form need not be returned to the factory unless requested during technical service support).

Job Name: _____
 Model Number: _____
 Date: _____
 Serial Number: _____

In order to minimize troubleshooting and costly system failures, complete the following checks and data entries before the system is put into full operation.

MODE	HEAT		COOL	
	Source	Load	Source	Load
Entering fluid temperature	<input type="text" value="F"/>	<input type="text" value="F"/>	<input type="text" value="F"/>	<input type="text" value="F"/>
Leaving fluid temperature	<input type="text" value="F"/>	<input type="text" value="F"/>	<input type="text" value="F"/>	<input type="text" value="F"/>
Temperature differential	<input type="text" value="F"/>	<input type="text" value="F"/>	<input type="text" value="F"/>	<input type="text" value="F"/>
Water coil heat exchanger (Water Pressure IN)	<input type="text" value="PSIG"/>	<input type="text" value="PSIG"/>	<input type="text" value="PSIG"/>	<input type="text" value="PSIG"/>
Water coil heat exchanger (Water Pressure OUT)	<input type="text" value="PSIG"/>	<input type="text" value="PSIG"/>	<input type="text" value="PSIG"/>	<input type="text" value="PSIG"/>
Pressure Differential	<input type="text" value="PSIG"/>	<input type="text" value="PSIG"/>	<input type="text" value="PSIG"/>	<input type="text" value="PSIG"/>
COMPRESSOR				
Amps	<input type="text"/>	<input type="text"/>	<input type="text"/>	<input type="text"/>
Volts	<input type="text"/>	<input type="text"/>	<input type="text"/>	<input type="text"/>
Discharge line temperature (after 10 minutes)	<input type="text" value="F"/>	<input type="text" value="F"/>	<input type="text" value="F"/>	<input type="text" value="F"/>

Maintenance

Preventive Maintenance

Maintenance on the unit is simplified with the following preventive suggestions:

⚠ WARNING Hazardous Voltage!

Disconnect all electric power, including remote disconnects before servicing. Follow proper lockout/tagout procedures to ensure the power can not be inadvertently energized. Failure to disconnect power before servicing could result in death or serious injury.

Check the contactors and relays within the control panel at least once a year. It is good practice to check the tightness of the various wiring connections within the control panel.

A strainer (60 mesh or greater) must be used on an open loop system to keep debris from entering the unit heat exchanger and to ensure a clean system.

For units on well water, it is important to check the cleanliness of the water-to-refrigerant heat exchanger. Should it become contaminated with dirt and scaling as a result of bad water, the heat exchanger will have to be back flushed and cleaned with a chemical that will remove the scale. This service should be performed by an experienced service person.

⚠ WARNING Hazardous Chemicals!

Coil cleaning agents can be either acidic or highly alkaline. Handle chemical carefully. Proper handling should include goggles or face shield, chemical resistant gloves, boots, apron or suit as required. For personal safety, refer to the cleaning agent manufacturers Materials Safety Data Sheet and follow all recommended safe handling practices. Failure to follow all safety instructions could result in death or serious injury.

It should be noted that the water quality should be checked periodically. See *Table 9*.

Table 9: Water Quality Table

Scaling	
Calcium and magnesium (total hardness)	Less than 350 ppm
Corrosion	
pH	7-9.5
Hydrogen Sulfide	Less than 1 ppm
Sulfates	Less than 25 ppm
Chlorides	Less than 125 ppm
Carbon Dioxide	Less than 75 ppm
Total dissolved solids (TDS)	Less than 1000 ppm
Biological Growth	
Iron Bacteria	Low
Erosion	
Suspended Solids	Low



Warranty Information

Warranty Information

Standard Warranty

The standard water-source heat pump warranty is Trane's parts-only warranty, running 12-months from start-up, not to exceed 18-months from shipment.

Extended Warranty

The *optional* extended warranty is a second through fifth year warranty. The time starts at the end of standard 1-year coverage through the fifth year.

These extended warranties apply only to new equipment installed in domestic Trane Commercial Systems Group sales territories and must be ordered prior to start-up.

Troubleshooting

WARNING

Hazardous Service Procedures!

The maintenance and troubleshooting procedures recommended in this section of the manual could result in exposure to electrical, mechanical or other potential safety hazards. Always refer to the safety warnings provided throughout this manual concerning these procedures. When possible, disconnect all electrical power including remote disconnects before servicing. Follow proper lockout/tagout procedures to ensure the power can not be inadvertently energized. When necessary to work with live electrical components, have a qualified licensed electrician or other individual who has been trained in handling live electrical components per these tasks. Failure to follow all of the recommended safety warnings provided, could result in death or serious injury.

Preliminary Trouble Inspection
If operational difficulties are encountered, be sure to perform the preliminary checks before referring to the troubleshooting chart on page 28.

- Verify that the unit is receiving electric supply power.
- Ensure that the fuses in the fused disconnect are intact.

After completing the preliminary checks, inspect the unit for other obvious problems such as leaking connection, broken or disconnected wires, etc. If everything appears to be in order, but the unit still fails to operate properly, refer to the troubleshooting chart on page 28.

General Operation

The standard model is designed for indoor installation. When the unit is installed in an unconditioned space, the unit may not start in cool weather (approximately 45°F). It may then be necessary to start the unit in the cooling mode for three to five minutes. The unit may then be shut-off (there will be a two minute time-out of the unit), and restarted in the heating mode. The freeze protection thermostat should also be checked as it may be adversely affected by ambient temperature. Like any other type of mechanical equipment, the unit performs best when it is well maintained.

Operation with a Conventional Thermostat

The unit is equipped with safety controls, including high pressure control, low pressure control and a freeze protection thermostat, set to shut off the compressor under abnormal temperature or pressure conditions. If the safeties shut off the compressor, a lockout relay prevents short cycling from the abnormal condition. When conditions are corrected, the lockout control can be reset by setting the thermostat system switch to OFF wait a few minutes for the system pressure to equalize, and then return to HEAT or COOL. If the condition continues, an authorized service person should check out the unit.



Troubleshooting Checklist

Problem	Heating	Cooling	Cause	Correction	
No response to any thermostat setting	X	X	Main power off	Check fuses	
	X	X	Defective control transformer	Replace	
	X	X	Broken or loose connection	Repair	
	X	X	Defective thermostat	Replace	
	X	X	Transformer	Reset Transformer	
Unit short cycles	X	X	Thermostat or sensor improperly located	Relocate	
Insufficient capacity	X	X	Low on refrigerant charge	Locate leak, repair and recharge by weight (not by superheat)	
	X	X	Restricted thermal expansion valve	Replace	
	X	X	Defective reversing valve	See WSHP-IOM-# for touch test chart	
	X	X	Thermostat improperly located	Relocate	
	X	X	Unit undersized	Recalculate heat gains/losses	
	X	X	Inadequate water flow	Increase GPM	
	X	X	Scaling in heat exchanger	Clean or replace	
			X	Water too hot	Decrease temperature
High pressure switch open			X	Water too cold	Increase temperature
			X	Inadequate GPM	Increase water flow to unit
			X	Water too hot	Decrease temperature
	X	X	Overcharged with refrigerant	Decrease charge	
	X	X	Defective pressure switch	Check or replace	
High head pressure			X	Trash in heat exchanger	Backflush
			X	Low water flow	Increase GPM
	X	X	Overcharge of refrigerant	Decrease charge	
	X	X	Non-condensable in system	Evacuate and recharge by weight	
Low suction pressure	X	X	Water too hot	Decrease temperature	
	X	X	Undercharged	Locate leak, repair and recharge	
	X	X	Restricted thermal expansion valve	Repair / replace	
	X		Inadequate GPM	Increase GPM	
Low Pressure switch open	X		Inadequate GPM	Increase GPM	
	X		Water too cold	Increase temperature	
	X	X	Undercharged with refrigerant	Increase charge	
	X	X	Defective pressure switch	Replace	
	X	X	Heat transfer fluid too cold	Raise water temperature. For smaller tonnage units, switch pressure switch wires from 35 psig to 7 psig	
Freezestat open	X		Inadequate GPM	Increase GPM	
	X		Water too cold	Increase GPM	
	X	X	Defective freezestat	Replace freezestat	
	X		Heat transfer fluid too cold	Replace freezestat. For smaller tonnage units, switch pressure wires from 35 psig to 7 psig.	

Unit Wiring 2-ton through 6-Ton Equipment

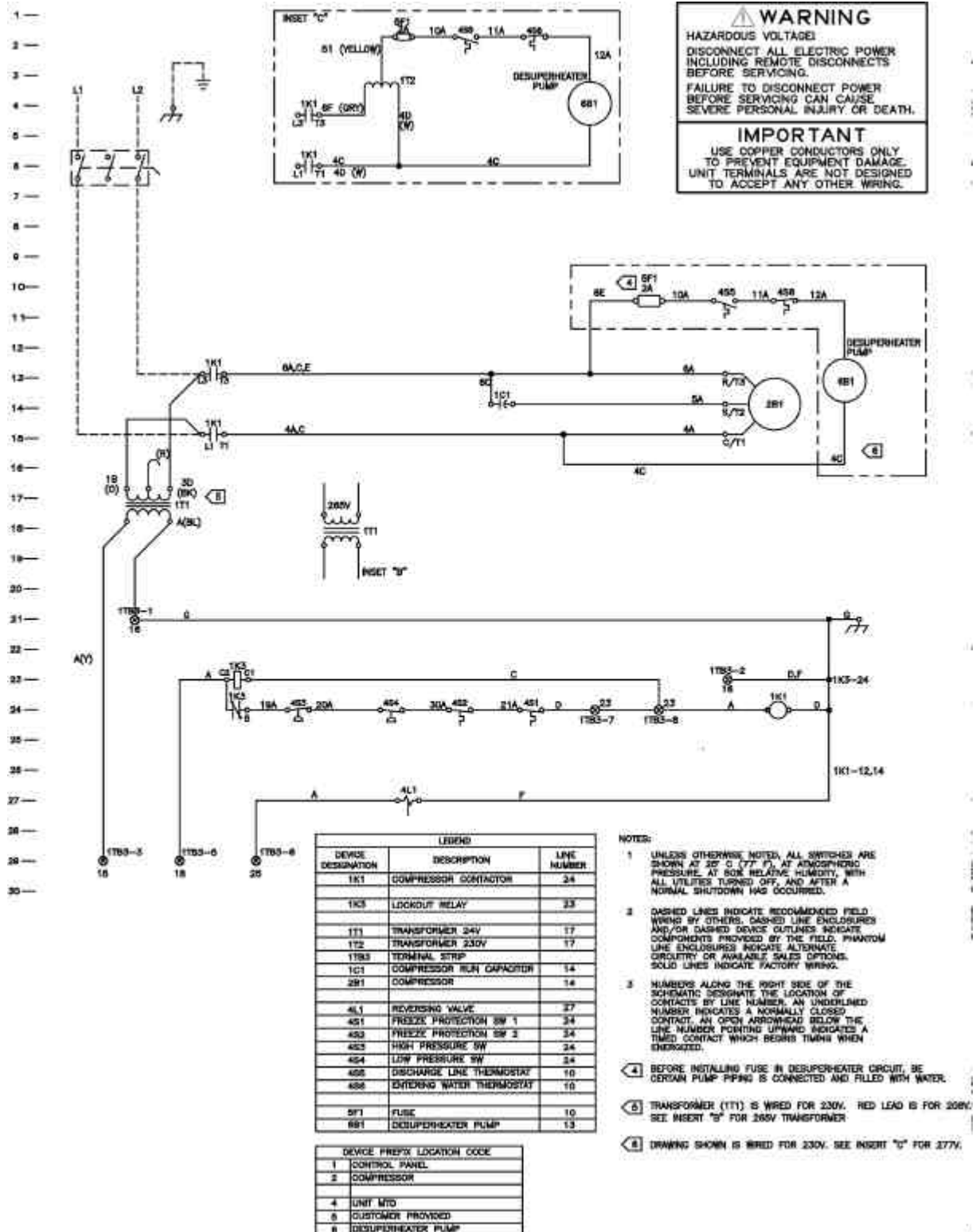

Unit Wiring 20-Ton Equipment

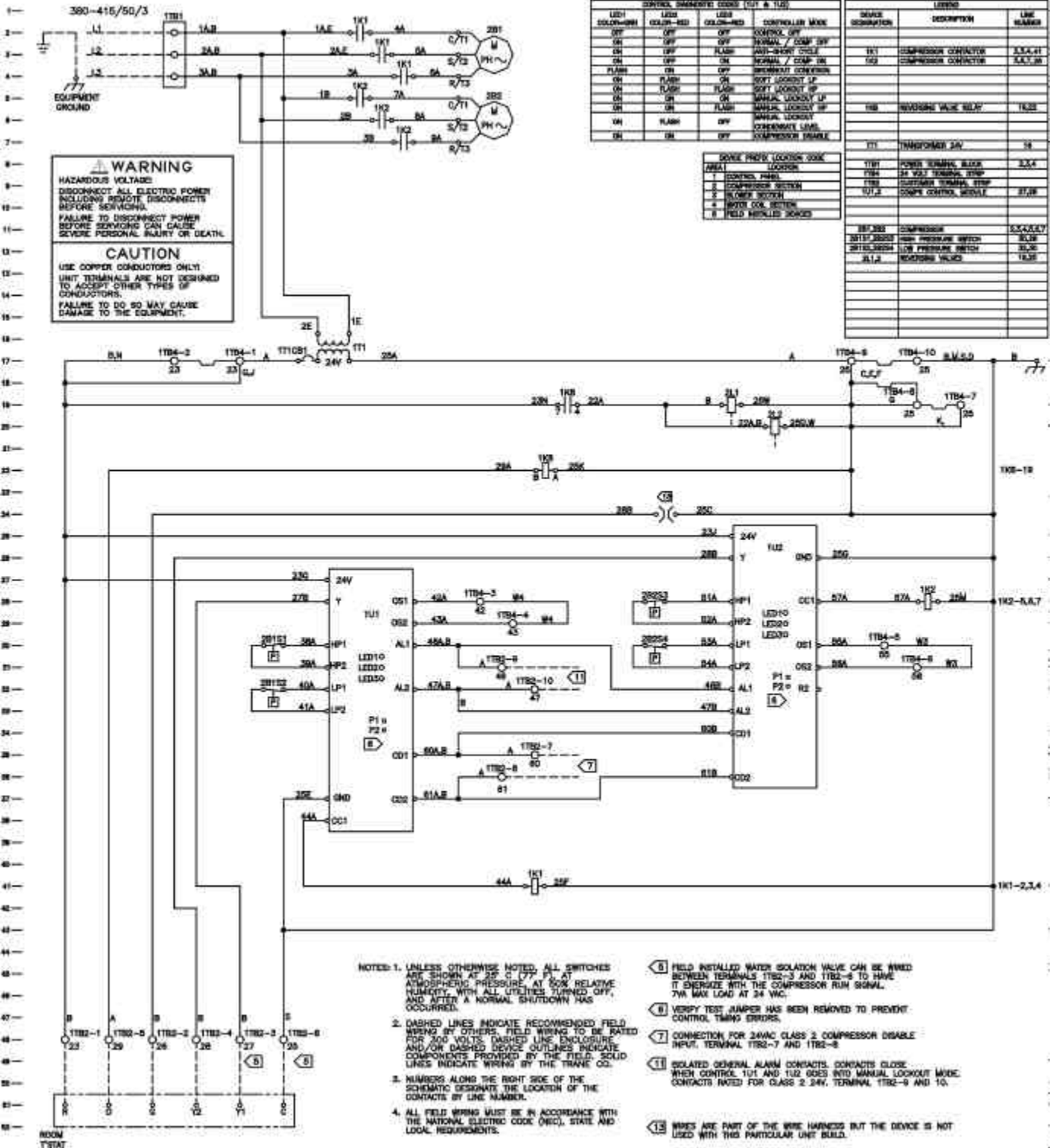



Trane
An American Standard Company
www.trane.com

For more information, contact
your local district office or e-mail us at
comfort@trane.com

Literature Order Number	WSHP-SVX02A-EN
File Number	SV-UN-WSHP-SVX02A-8-02
Supersedes	WSHPC-IOM-4 and 72-9036-02
Stocking Location	Inland

Since Trane has a policy of continuous product and data improvement and reserves the right to change design and specifications without notice.

Free Manuals Download Website

<http://myh66.com>

<http://usermanuals.us>

<http://www.somanuals.com>

<http://www.4manuals.cc>

<http://www.manual-lib.com>

<http://www.404manual.com>

<http://www.luxmanual.com>

<http://aubethermostatmanual.com>

Golf course search by state

<http://golfingnear.com>

Email search by domain

<http://emailbydomain.com>

Auto manuals search

<http://auto.somanuals.com>

TV manuals search

<http://tv.somanuals.com>