



# Installation Owner Diagnostics

---

Tracer® ZN.520 for Classroom  
Unit Ventilator



---

UV-SVP01A-EN

# Start-up Procedures

---

## Installation of New Units

1. Follow all instruction for installation of classroom unit ventilators as detailed in UV-IOM-1 (Installation Operation Maintenance manual).
2. Disconnect power or disable the circuit breaker to unit.
3. Run communication link wire when required. (See wiring diagram in the unit).
4. Install zone sensor when required. (See wiring diagram in the unit and zone sensor submittals).
5. Reapply power.
6. Check for GREEN Status LED operation to ensure power has been made to the Tracer™ ZN.520 unit controller.
7. Check for YELLOW Comm LED operation to help ensure communication has been made to the Tracer ZN.520 unit controller when required.

Peel IDENTIFICATION TAG from unit and place in the Appendix of this document, or on building plans for future location use. The actual room location on the tag may be hand written.



# Start-up Procedures

---

## Power Up Sequence

Manual output test can be initiated at any time in the power up sequence or during normal operation.

When 24 VAC power is initially applied to the controller, the following sequence occurs:

1. Green Status LED turns on.
2. All outputs are controlled Off.
3. The controller reads input values to determine initial values.
4. Standalone control is assumed unless occupancy data is communicated.
5. Random start timer expires (5 to 30 seconds, random).
6. Power-up control Wait feature is applied. When power up control Wait is enabled, the controller waits 120 seconds to allow ample time for communicated control data to arrive. If, after 120 seconds, the controller does not receive a communicated occupancy request, the unit assumes standalone operation.
7. All modulating valves and damper calibrate closed, face and bypass damper calibrate to bypass (when present).
8. Normal operation begins after 290 (potentially) seconds have passed.

*Note: Manual output test can be initiated at any time.*

# General Information

## Tracer® ZN.520 Overview

The Trane® Tracer® ZN.520 controller is a factory-installed and commissioned, direct-digital controller (DDC) offering for classroom unit ventilator systems. (See Figure 1: "Tracer ZN.520 Control Board") The Tracer ZN.520 can also be applied to other Trane® interoperable HVAC equipment, including the fan coil and blower coil products. (For more information see, Table 1: *Tracer™ ZN.520 Unit Controller features and coil availability, on page 8 for more information.*) For more information regarding the application of the Tracer ZN.520 to other Trane products, contact the appropriate local Trane sales office.

Trane offers a complete solution to space comfort control with the flexibility of Integrated Comfort System (ICS) and stand-alone control packages. The ICS control package combines HVAC equipment and building management into one environmental comfort system.

Integrating the Tracer ZN.520 on classroom unit ventilators, and tying them to a Tracer Summit® system will provide a complete building management system. The stand-alone control package offers the features and functionality of the direct digital control without a front-end building automation system, while providing future considerations for ICS.

Equipment problems can often be diagnosed on each unit without having to access the unit components. These diagnostics can be received remotely via a modem with a Tracer Summit building automation system, thus reducing the number of actual on-site service calls; through the Rover® service tool connected to a communication jack located inside the Trace zone sensor; or connected to the unit.

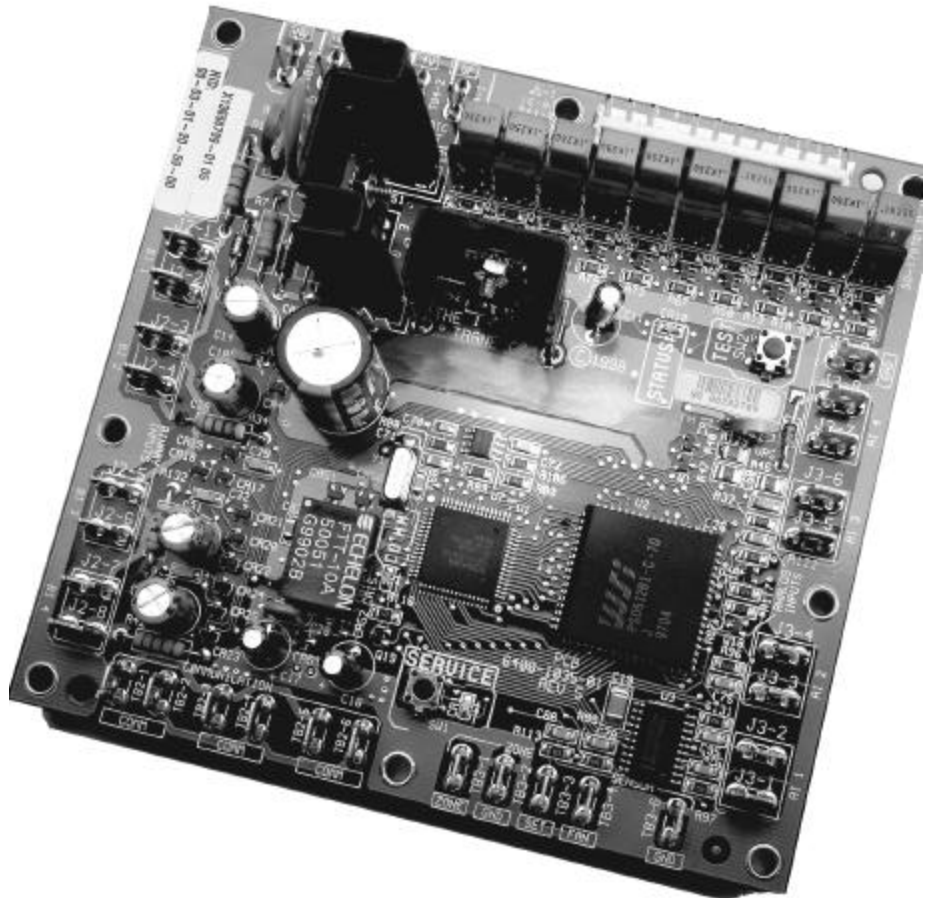

Figure 1: Tracer ZN.520 Control Board

The Tracer ZN.520 is factory-mounted, tested, wired, configured and commissioned for the selected application.

The Tracer ZN.520 configuration has flexible point and product configurations. For example, with point configuration, a specific binary point can be configured to accept input from either a time clock or some type of generic device.



# General Information

Table 1: Tracer™ ZN.520 Unit Controller features and coil availability

Coil	Multiple Fan Speeds	Dehumidification	Auto Damper Adjust	Face and Bypass Damper	Valve Control	Economizer Damper	Auxiliary Heat <sup>2</sup>	Entering Water Temperature Sampling
2-pipe changeover	X		X	X	X	X	X	X
2-pipe hot water only	X		X	X	X	X	X	
2-pipe steam only	X		X	X		X	X	
2-pipe changeover/ electric heat	X	X	X		X	X	X	X
2-pipe cool only	X		X		X	X		
2-pipe cool only/ electric heat	X <sup>1</sup>		X <sup>1</sup>		X	X	X	
4-pipe hot water/ chilled water	X	X	X	X <sup>3</sup>	X	X	X	
4-pipe changeover	X	X	X	X <sup>3</sup>	X	X	X	X
4-pipe steam/chilled water	X		X		X	X	X	
Electric heat only						X	X	
DX/hot water	X <sup>1</sup>		X <sup>1</sup>		X	X	X	
DX/steam	X <sup>1</sup>		X <sup>1</sup>		X	X	X	
DX/electric heat						X	X	
DX cooling only						X		

1. Multiple fan speeds are available in hydronic units only.

2. Auxiliary heat is designed to bring on baseboard heat as the second stage of heating. The baseboard heat must be the same type as the unit heating coil.

3. Units with face bypass dampers cannot actively dehumidify.

# Controller Circuit Board Features

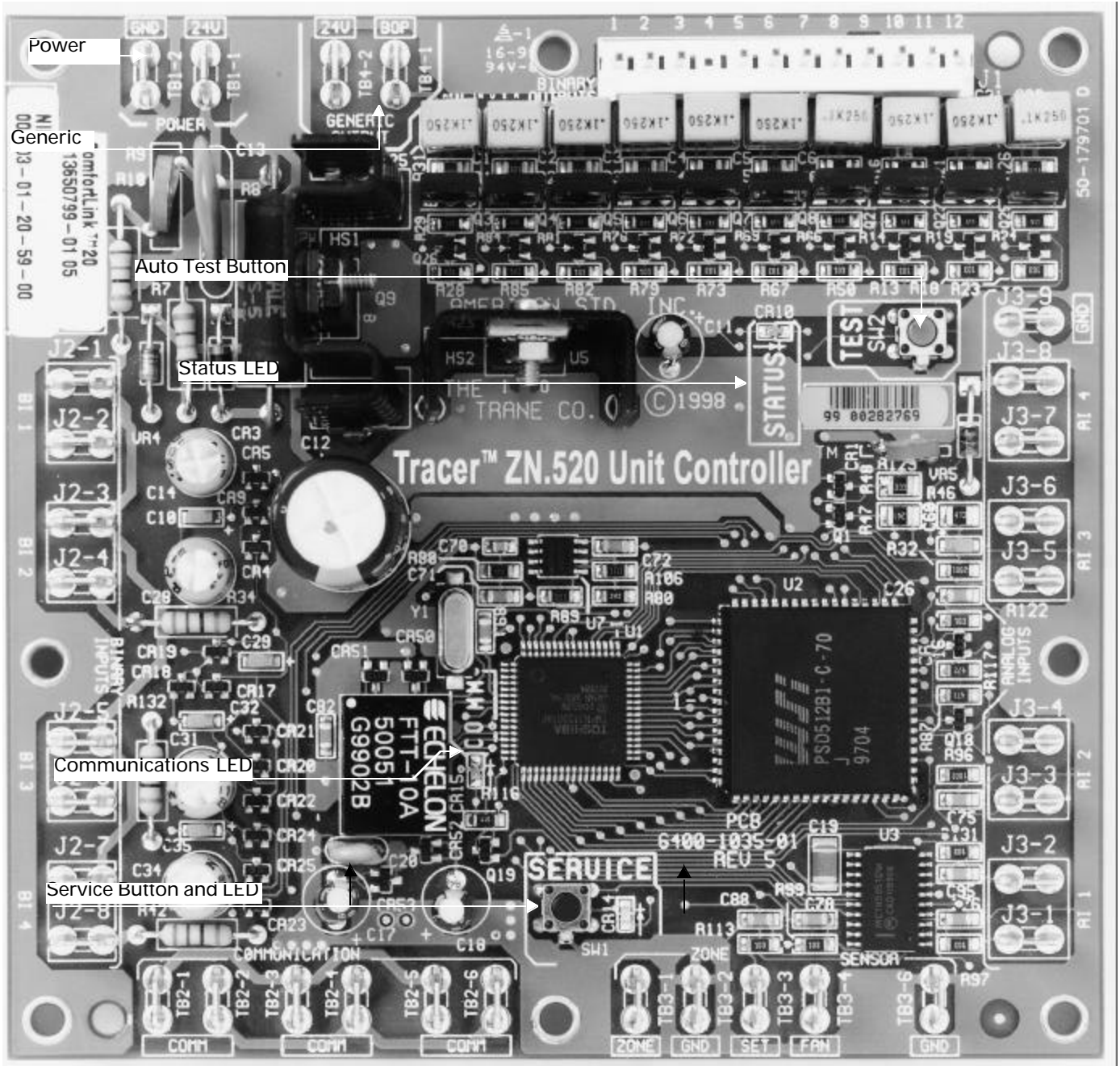

Communications

Zone Sensor Connections

Figure 2: Tracer ZN.520 unit controller circuit board

# Controller Features

Each Tracer ZN.520 unit controller circuit board is equipped with enhancements to help facilitate service, testing, and diagnosis.

Each board has

- ❑ Manual test button,
- ❑ Status LED,
- ❑ Communication status LED,
- ❑ Service button,
- ❑ Quick terminal connectors, and
- ❑ Easy to read screen printing.  
(See Figure 1: "Tracer ZN.520 Control Board").

## Service

The Trane Tracer ZN.520 unit controller is serviced using Rover®, the ICS software service tool. Rover is designed to support the Tracer ZN.520 unit controller on the classroom unit ventilator.

For "remote" access to the communicating units, the zone sensors offered with the Tracer ZN.520 have a telephone style (RJ-11) connector allowing field connection between Rover and the zone sensor; however, the RJ-11 connector must be connected to the terminals TB2-5 and TB2-6 on the Tracer ZN.520 unit controller. (See Figure 3: "Rover service tool connected to the RJ-11 communication jack in a zone sensor")

The zone sensor may also be used when trying to locate a unit. By pressing the ON button on the zone sensor for 5 seconds or using the "wink" command in Rover, the circuit board receives the signal causing the Communication LED to "wink". Winking allows visual identifier on the board for service technicians.

The Tracer ZN.520 also includes features such as a test output to manually test all of the end devices and color coded wires (i.e. red for heating valves and blue for cooling valves) to aid in the troubleshooting process. (See "Manual Output Test" on page 48, for more information.)

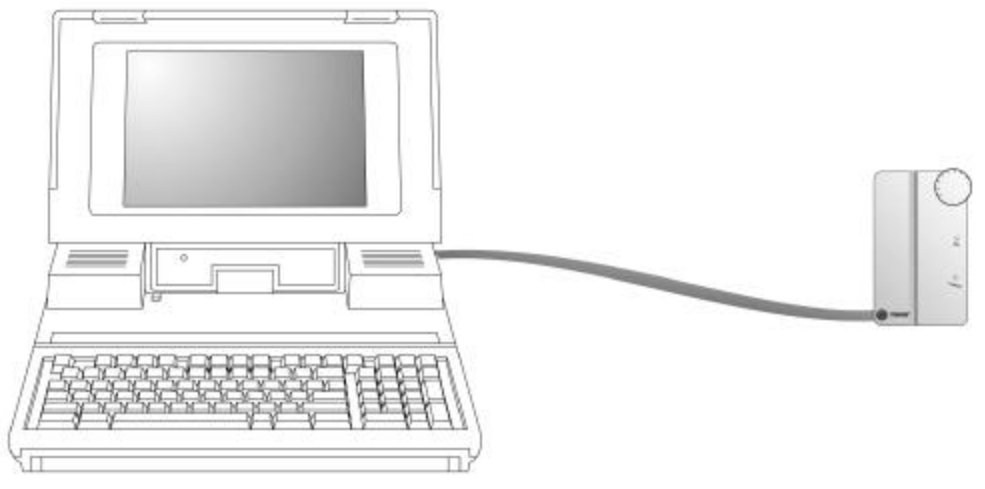

Figure 3: Rover service tool connected to the RJ-11 communication jack in a zone sensor

## Typical Components

A typical classroom unit ventilator system with a DDC package consists of the following physical components, in addition to the mechanical equipment:

- ❑ Tracer ZN.520—contains the sensor input circuits, service adjustments, microprocessor control electronics, and communications hardware.
- ❑ Power is supplied by a separately mounted 24 VAC\90 VA transformer.
- ❑ Sensor Modules—a variety of analog sensors that provide temperature and optional humidity sensing and CO<sub>2</sub> sensor; and an operator interface to the Tracer ZN.520 for operating modes, status, and temperature setpoints.
- ❑ Standard End Devices—a variety of devices that help to gather information, control capacity, and provide ventilation are used by the Tracer ZN.520 in its control algorithm to condition the space to the desired temperature and relative humidity level. (See "Standard End Devices" on page 13, for more information.)

# Communication Configurations

*Note: The Tracer ZN.520 is a configured controller. It will not operate without a valid downloaded configuration file.*

The Tracer ZN.520 controller supports ICS and peer-to-peer communications as well as stand-alone operation. A number of control features may be configured at the factory or by using the Rover service tool. (See "Configuration" on page 32, for more information.)

## Integrated Comfort System

*Note: The Tracer ZN.520 controller may only be used with Tracer Summit version 11.0 or greater with a Comm5 communications card.*

Classroom unit ventilators can operate as part of a large building automation system controlled by Tracer Summit. The Tracer ZN.520 is linked directly to the Tracer Summit via a twisted pair communication wire. Each Tracer Summit building automation system can

connect to a maximum of 120 Tracer ZN.520 controllers.

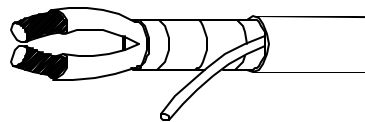

Figure 4: Communications link wire

The ICS system allows for complete communication with the classroom unit ventilators via Tracer ZN.520 unit controller. All points connected to the Tracer ZN.520 may be observed from the Tracer Summit front-end controller. The Tracer Summit can also initiate an alarm on a loss of performance or equipment malfunctions.

The ICS system also allows all of the classroom unit ventilators to share information without the presence of hardwired sensors at each unit. Some typical shared points include outside air temperature, entering water temperature, and occupancy schedules.

## Peer-to-Peer Communications

On a peer-to-peer communication system, multiple Tracer ZN.520 controllers may share data, via a twisted pair communication wire, without the need for a Tracer Summit system. (See Figure 5: "Peer-to-peer communication connections")

Peer-to-peer communications allows features such as master/slave operation, in which multiple units operate off of a single zone sensor. This is typically seen in large spaces requiring multiple units.

The Rover service tool is required to set up peer-to-peer communications.

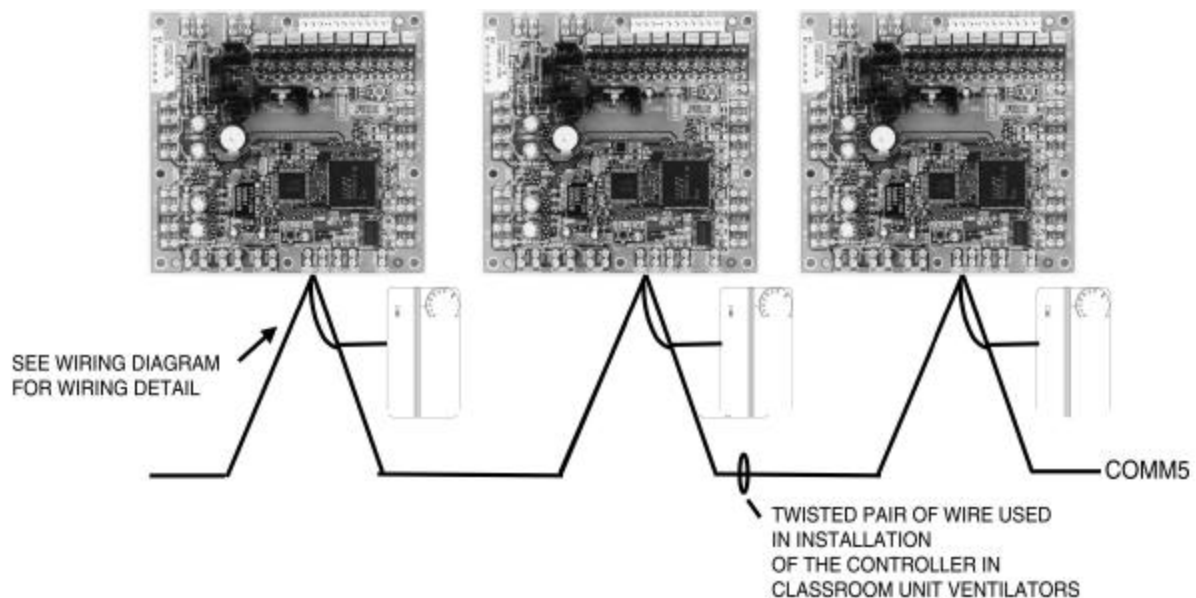

Figure 5: Peer-to-peer communication connections





# Communication Configurations

## Stand-Alone

In a stand-alone configuration, commands for operation are determined based on input from the zone sensor, humidity sensor, and factory- or field-mounted time-clock. (See Figure 6: "Typical classroom unit ventilator installation")

- ❑ The timeclock is wired to the Tracer ZN.520 to index the unit between occupied and unoccupied modes.
- ❑ A unit-mounted, analog, outside-air temperature sensor is used to initiate the dry bulb economizer and freeze avoidance routines.
- ❑ On changeover units, a unit-mounted, analog, entering water temperature sensor is used to automatically control the system in the heat/cool mode.

These sensors are required for proper system operation and are provided as standard on stand-alone units.



Figure 6: Typical classroom unit ventilator installation

## Communication Interface

*Important! To help ensure optimal performance of the Rover service tool, please use the latest version. To obtain the latest version contact your local Trane sales representative or service technician.*

*Note: Refer to the Tracer system manuals for more information on communications.*

The Tracer ZN.520 communicates via Comm5 (LonTalk) to a building management system, the Rover service tool, and other unit controllers on the communications link. Each Tracer ZN.520 requires a unique address for the system to operate properly. Every Tracer ZN.520 has this address (Neuron ID) embedded in the microprocessor, which eliminates the need for field-addressing of the units. Each unit also ships from the factory with a unit identification tag. (See "Location Identifier" on page 38, for more information.)

### Building automation system

Trane offers a state-of-the-art front-end building automation system designed to coordinate and monitor Trane equipment and controllers: Tracer Summit.

The Tracer Summit system allows the user to monitor and/or change Tracer ZN.520:

- ❑ status, parameters, sensor data, diagnostics, and internal variables; and
- ❑ setpoints, operating modes, and outputs.

### Service tool

Trane also offers a service tool to work in conjunction with the Tracer Summit system or with peer-to-peer and stand-alone systems: the Rover service tool.

Communication to the Tracer ZN.520, or multiple controllers, can also be accomplished by using the ICS software service tool.

A personal computer running Rover may be directly connected to a standalone Tracer ZN.520; connected to the communications jack in the Trane zone sensor; or connected to a communicating unit's Tracer ZN.520 unit controller, to access all of the units on a communicating link.



Rover allows the user to interface with the Tracer ZN.520, but will not allow any advanced control (e.g. equipment scheduling or trending). To purchase a copy of the ICS software service tool, contact the BAS department at your local Trane dealer.

## Interoperability

Trane has lead the industry with BACnet interoperability and Trane is now expanding the realm of interoperable solutions by offering LonMark certified unit controllers. The Tracer ZN.520 controller conforms to the LonMark Space Comfort Controller profile. (See "Appendix—Data Lists" on page 64, for more information.) This allows the ZN.520 to be used as a unit controller on other control systems that support LonTalk and the SCC profile. Now building owners have more choices and design engineers have more flexibility to meet the challenges of building automation.



# Standard End Devices

Table 2: End Device Specifications

Device	Characteristic	Description	
	Material	Contact Blade—Pilot duty rated	
	Operating Temperature Range	-40°F/250°F (-40°C/120°C)	
	Contact Form	SPST-NO	
	Preset	Fan status - 0.07"	
	Trip Temperature:	36°F ± 2°F (2°C ± 1.11°C)	
	Release Temperature	44°F ± 3°F (6.67°C ± 1.67°C)	
	Rating—Auto Reset	Pilot Duty (24 VAC)	120 VAC    240 VAC
		FLA	10.0    5.0
		LRA	60.0    30.0
	Sensing Element	Thermistor 10 KOhms @ 77°F ± 1.8°F (25°C ± 1°C)	



# Standard End Devices

Table 2: End Device Specifications

Device	Characteristic	Description
	Description	Three-point floating with spring return
	Ambient Temperature Rating	-25°F to 125°F
	Power Consumption	5 VA
	Torque	35 in-lbs.
	Drive Time	90 seconds, 95 degree stroke
	Description	Three-point floating
	Ambient Temperature Rating	32°F to 122°F
	Power Consumption	3 VA
	Torque	35 in-lbs.
	Drive Time	80-110 seconds, 95 degree stroke
	Description	Three-point modulating
	Ambient Temperature Rating	140°F at 95% relative humidity
	Drive Time	50 seconds
	Max Pressure	400 psi water
	Close Off	Varied by size and Cv
	Temperature	Water 200°F maximum



# Standard End Devices

Table 2: End Device Specifications

Device	Characteristic	Description
<p>3-way Control Valve</p> 	Description	Three-point modulating
	Ambient Temperature Rating	140°F at 95% relative humidity
	Drive Time	50 seconds
	Max Pressure	400 psi water
	Close Off	Varied by size and Cv
	Temperature	Water 200°F maximum
<p>Time clock</p> 	Size	2.83" x 4.0" x 2.06"
	Power Consumption	4.4 VA
	Switch	SPDT dry contacts, silver cadmium oxide
	Switch Rating	16A 250V resistive, 1000 Watts tungsten
	Minimum Switching Current	100mA, 230V
	Shortest Switching Time	1 minute
	Ambient Temperature Range	-14°F to 131°F
	Wiring Connections	Screw terminals suitable for #10 to #24 AWG
Backup	Seven day capacitor backup	
<p>Zone sensor</p> 	Zone Sensor Wiring Size And Maximum Lengths	16-22 AWG: up to 200 feet

# Standard End Devices

Table 2: End Device Specifications

Device	Characteristic	Description
	Sensing Element	Polymer capacitive
	Sensing Element	Accuracy: $\pm 5\%$ over 20-95% RH @ 77°F
	Range	0 to 99% RH
	Operating Temperature Range	0°F to 140°F
	Max Supply Voltage	24VDC
	Output Characteristics	4 to 20 MA for 0-100% RH
	Drift Rate	Less than 1% per year
	Sensing Element	Accuracy: $\pm 100$ ppm full scale
	Range	0-2000 ppm
	Operating Temperature Range	59°F to 95°F
	Supply Voltage	24VAC
	Output Characteristics	0-10 VDC for 0-2000 ppm
	Power consumption	10 VA
	Drift Rate	$\pm 5\%$ full scale over four years
	Contact Rating	20 amps at 120/240 vac 3/4 hp at 120 vac 1 1/2 hp at 240 vac 20 amps @ 28 vdc DPDT
	Terminals	0.25 quick connect
	Contact material	Silver-Cadium Oxide
	Coil	24 vac 2.7 va

# Standard End Devices

Table 2: End Device Specifications

<i>Device</i>	<i>Characteristic</i>	<i>Description</i>
<i>Control Transformer</i>	<i>Type</i>	<i>N.E.C. Class 2</i>
	<i>Primary Voltage</i>	<i>120 vac</i>
	<i>Secondary voltage</i>	<i>24 vac at 90 va Manual reset 4amp fuse in 24-volt circuit</i>



# Installation and Wiring

## Specifications

### Dimensions

Tracer ZN.520 board and mounting hardware:

- Height: 5.25 inches (133 mm.)
- Width: 5.50 inches (140 mm)
- Depth: 2.25 inches (57 mm)

### Power Requirements

- 18 to 32 VAC (24 VAC nominal)
- 50 or 60 Hz
- 570 mA AC

### Operating Environment

- 32° to 140°F (0° to 60°C)
- 5% to 95% relative humidity, non-condensing

### Storage Environment

- -40° to 185°F (-40° to 85°C)
- 5% to 95% relative humidity, non-condensing

### Agency Listings

- UL and CUL 916 Energy Management System
- Agency Compliance IEC 1000-4-2 (ESD), IEC 1000-4-4(EFT), IEC 1000-4-5 (Surge)

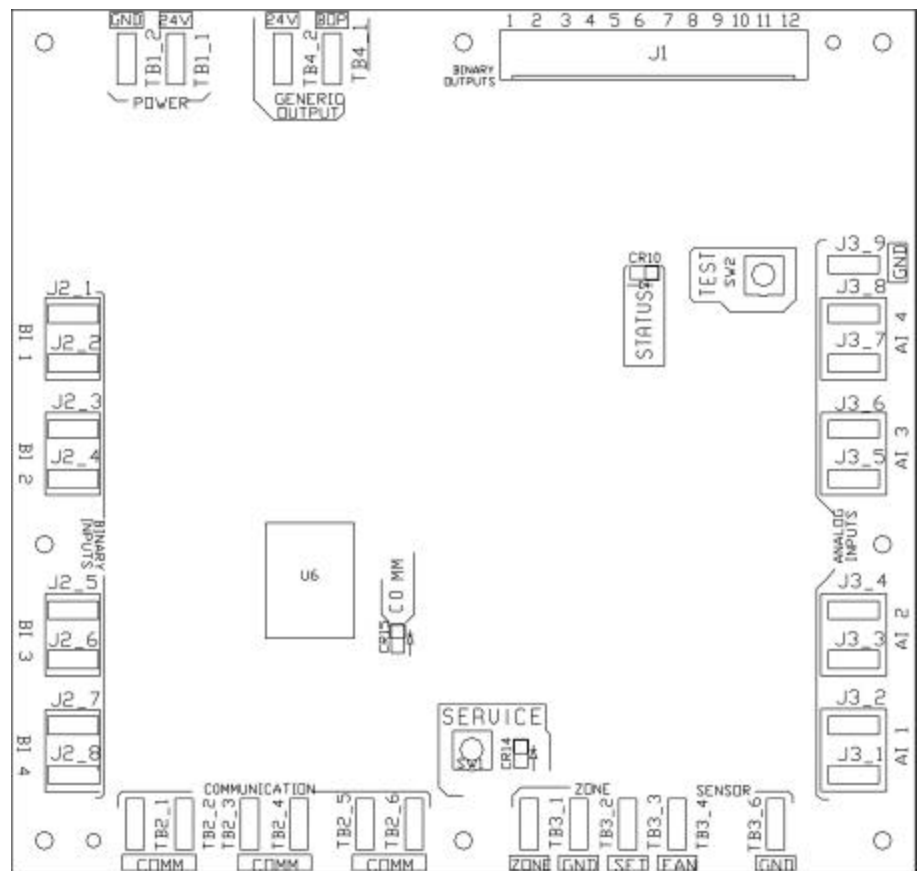

Figure 7: Tracer ZN.520 circuit board schematic

# Installation and Wiring

## Binary Inputs

Each binary input associates an input signal of 0 VAC with open contacts and 24 VAC with closed contacts.

Table 3: Binary inputs (typically 24 mA AC)

<i>Description</i>	<i>Terminals</i>	<i>Terminal Function</i>
<i>Binary input 1 (BI 1)</i>	<i>J2-1</i>	<i>24 VAC</i>
	<i>J2-2</i>	<i>Input</i>
<i>Binary input 2 (BI 2)</i>	<i>J2-3</i>	<i>24 VAC</i>
	<i>J2-4</i>	<i>Input</i>
<i>Binary input 3 (BI 3)</i>	<i>J2-5</i>	<i>24 VAC</i>
	<i>J2-6</i>	<i>Input</i>
<i>Binary input 4 (BI 4)</i>	<i>J2-7</i>	<i>24 VAC</i>
	<i>J2-8</i>	<i>Input</i>





# Installation and Wiring

## Binary Outputs

Outputs are load side switching triacs. The triac acts as a switch, either making or breaking the circuit between the load (valve, damper, contactor, relay) and ground.

Table 4: Binary outputs

Description	Terminals	Output Rating	Load Energized	Load De-energized
Fan high	J1-1	12 VA	1 VAC RMS (typical)	24 VAC RMS (typical)
Fan medium, Exhaust fan	J1-2	12 VA	1 VAC RMS (typical)	24 VAC RMS (typical)
Fan low	J1-3	12 VA	1 VAC RMS (typical)	24 VAC RMS (typical)
No connection	J1-4 (Key)	—	—	—
Cool open, face bypass cool valve DX, 2-position cooling valve, BI 5	J1-5	12 VA	1 VAC RMS (typical)	24 VAC RMS (typical)
Cool close	J1-6	12 VA	1 VAC RMS (typical)	24 VAC RMS (typical)
Face/bypass damper open	J1-7	12 VA	1 VAC RMS (typical)	24 VAC RMS (typical)
Face/bypass damper close	J1-8	12 VA	1 VAC RMS (typical)	24 VAC RMS (typical)
Heat open Face bypass isolation valve, 2-position heating valve Electric heat 1 <sup>st</sup> stage	J1-9	12 VA	1 VAC RMS (typical)	24 VAC RMS (typical)
Heat close Electric heat 2 <sup>nd</sup> stage	J1-10	12 VA	1 VAC RMS (typical)	24 VAC RMS (typical)
Economizer damper open	J1-11	12 VA	1 VAC RMS (typical)	24 VAC RMS (typical)
Economizer damper close	J1-12	12 VA	1 VAC RMS (typical)	24 VAC RMS (typical)

## Generic/baseboard Heat Binary Output

Table 5: Generic binary outputs

Description	Terminals	Output Rating	Load Energized	Load De-energized
Generic/ baseboard heat output	TB4-1	12 VA	1 VAC RMS (typical)	24 VAC RMS (typical)
24VAC	TB4-2	12 VA	NA	NA

# Installation and Wiring

## Analog Inputs

Table 6: Analog inputs

Description	Terminals	Function	Range
Zone	TB3-1	Space temperature input	5° to 122°F (-15° to 50°C)
Ground	TB3-2	Analog ground	NA
Set	TB3-3	Setpoint input	40° to 115°F (4.4° to 46.1°C)
Fan	TB3-4	Fan switch input	4821 to 4919 Ω (Off) 2297 to 2342 Ω (Auto) 10593 to 10807 Ω (Low) 13177 to 13443 Ω (Medium) 15137 to 16463 Ω (High)
Ground	TB3-6	Analog ground	NA
Analog Input 1	J3-1	Entering water temperature	-40° to 212°F (-40° to 100°C)
	J3-2	Analog ground	NA
Analog Input 2	J3-3	Discharge air temperature	-40° to 212°F (-40° to 100°C)
	J3-4	Analog ground	NA
Analog Input 3	J3-5	Outdoor air temperature / Generic temperature	-40° to 212°F (-40° to 100°C)
	J3-6	Analog ground	NA
Analog Input 4	J3-7	Power port	4-20 mA
	J3-8	Universal input	0 – 100%
		Generic 4-20ma	0 – 100%
Humidity		0 – 2000ppm	
	J3-9	Analog ground	NA

# Installation and Wiring

---

## Mounting

The Tracer ZN.520 circuit board is mounted in the left-hand end pocket for all classroom unit ventilator configurations. The sheet metal mounting plate has raised embosses to accept the mounting feet on the circuit board. (See Figure 8: "Classroom unit ventilator control box with close-up of horseshoe embosses and circuit board mounting feet.") This design allows the Tracer ZN.520 controller to be secured with a minimal number of sheet metal screws.

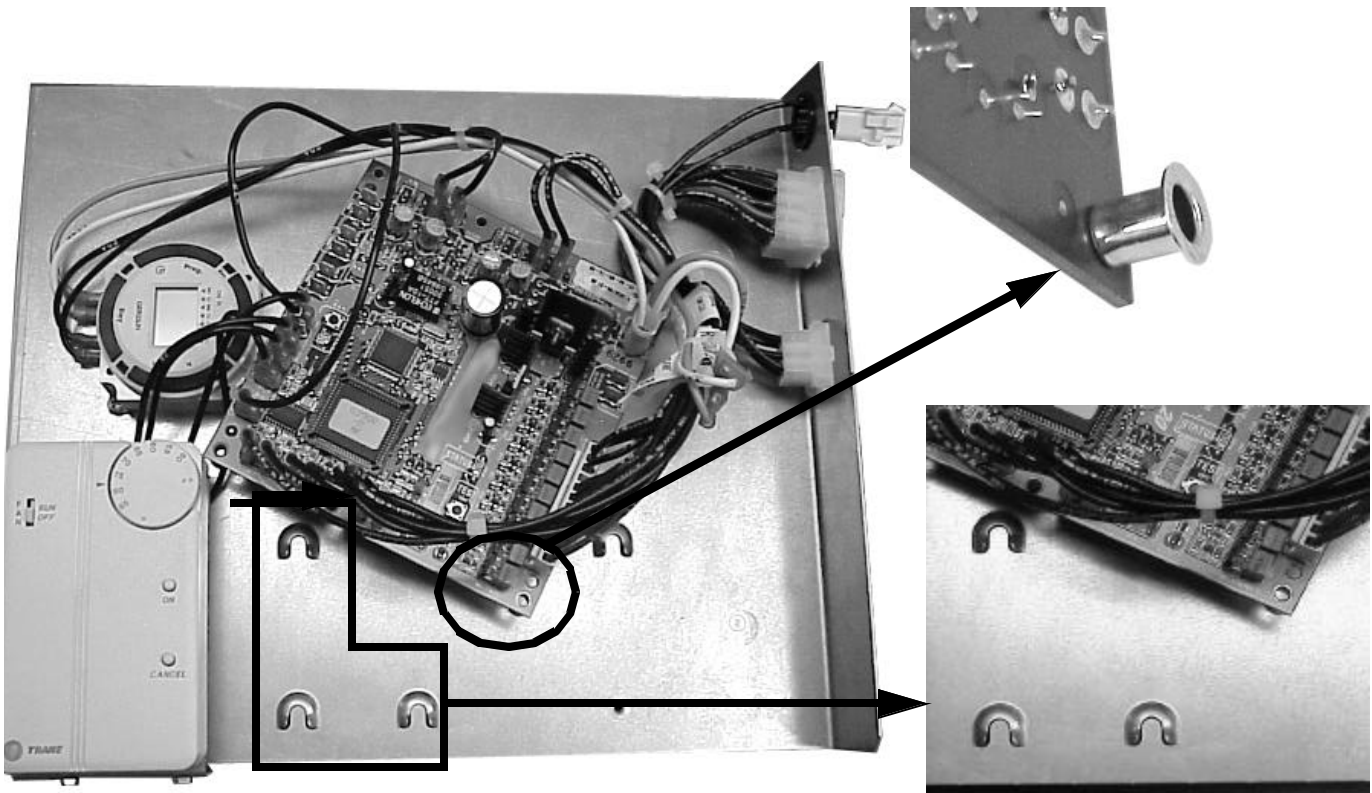
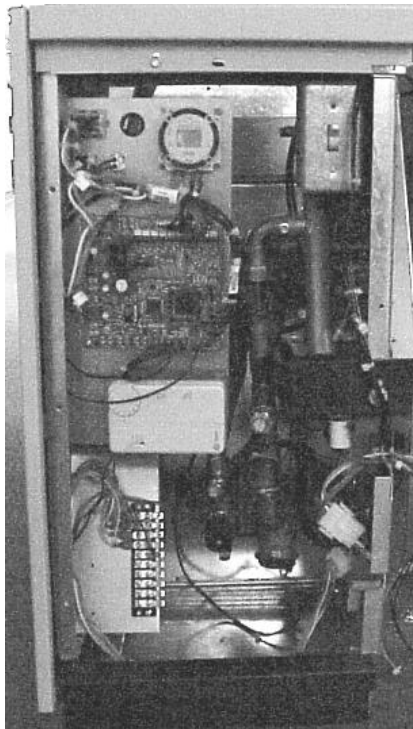

Figure 8: Classroom unit ventilator control box with close-up of horseshoe embosses and circuit board mounting feet.

# Installation and Wiring

The mounting position on the *vertical classroom unit ventilator* configuration allows complete access to the Tracer ZN.520 by removing the front panel. (See *Figure 9: "Vertical classroom unit ventilator end pocket"*) The mounting plate swings out of the way with the removal of a single screw to allow access to the components behind the control board.



*Figure 9: Vertical classroom unit ventilator end pocket*

The mounting plate on the *horizontal classroom unit ventilator* configuration is designed to slide out with the removal of a single screw for complete access to the Tracer ZN.520. (See *Figure 10: "Horizontal classroom unit ventilator end pocket"*) The location of the control board on this unit configuration allows complete access to the other components in the end pocket when the front panel is removed.



*Figure 10: Horizontal classroom unit ventilator end pocket*

For additional convenience, quick connects and modular wire harnesses are used on the control board and mounting plate. (See *Figure 11: "Quick connects to control board in the classroom unit ventilator"*) These quick connects help facilitate ease of wiring devices (e.g., zone sensor) to the control board, and helps add accessibility to major components.



*Figure 11: Quick connects to control board in the classroom unit ventilator*

# Installation and Wiring

## Wiring

### ⚠ WARNING

**Warning! Disconnect all electrical power before servicing unit to prevent injury or death due to electrical shock. Use copper conductors only. The use of aluminum or other incorrect types of wire may result in overheating and equipment damage.**



### ⚠ CAUTION

**Caution: To prevent damage to the unit ventilator, refer to the diagram provided on the inside of the unit's access panel for specific wiring information.**

**Information. All controls are wired at the factory. Single point power, zone sensor, and communication wiring is to be installed by the contractor.**

*Important! All wiring must comply with state, local, and federal guidelines. Contact the appropriate local agency for further information.*

*Important! Wires for temperature sensors, communication lines, 24 VAC, and contact closure sensing inputs should not be bundled with or run near high voltage wiring.*

- ❑ Power wiring must be separated from the Tracer ZN.520 and all low voltage wires. External input wires should be run in separate conduits from high voltage wires.
- ❑ Wires connected to pin headers should be formed and routed so as to cause minimum strain on the Tracer ZN.520 connector.
- ❑ A minimum of 1.5" clearance (from the pin centerline) for wires up to 16 AWG is recommended for bending and forming wires.

- ❑ All sensor and input circuits are at or near ground potential. Do not connect any sensor or input circuit to an external ground connection.
- ❑ A close-coupled ground connection is required for the Tracer ZN.520. T
- ❑ Table 7: Tracer ZN.520 Wiring Requirements, shows Tracer ZN.520 wire types and lengths.

Table 7: Tracer ZN.520 Wiring Requirements

Application	Wire Type	Length
Contact Closure	18 AWG	Up to 1000 ft.
24 VAC	16-22 AWG	Up to 1000 ft.
Thermostat	16-22 AWG	Up to 1000 ft.
Zone Sensor	16-22 AWG	Up to 200 ft.
Communications	Belden 8760 or equivalent	Up to 5000 ft.

## Power

The Tracer ZN.520 controller is powered by 24 VAC. (See Table 7: "Tracer ZN.520 Wiring Requirements") A total of two 1/4-inch quick-connect terminals are provided for 24 VAC connection to the board.

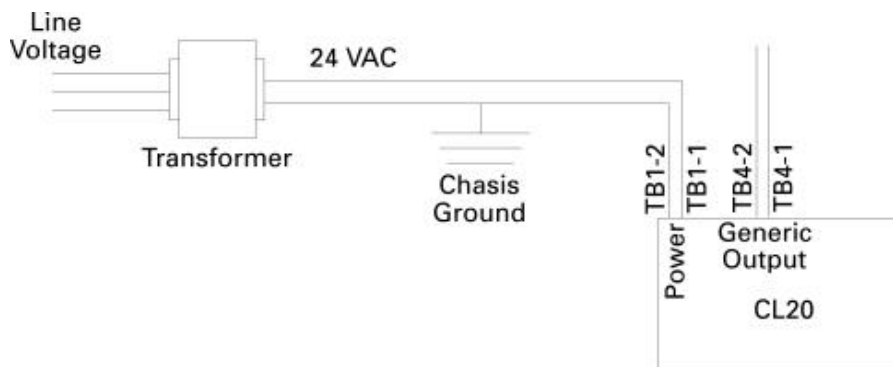

Figure 12: Power connection to the Tracer ZN.520 unit controller

# Installation and Wiring

## Installing the Wall-Mounted Zone Sensor (Optional)

Zone sensor location is an important element of effective room control and comfort.

The best sensor location is typically on a wall, remote from the HVAC unit. Readings at this location assure that the desired setpoint is achieved across the space, not just near the unit itself.

*Note: It may be necessary to subdivide the zone with multiple units to ensure adequate control and comfort throughout the space.*

The following are typical areas where the zone sensor should *NOT* be mounted:

- Near drafts or "dead spots" (e.g., behind doors or corners);
- Near hot or cold air ducts;

- Near radiant heat (e.g., heat emitted from appliances or the sun);
- Near concealed pipes or chimneys;
- On outside walls or other non-conditioned surfaces; or
- In air flows from adjacent zones or other units.

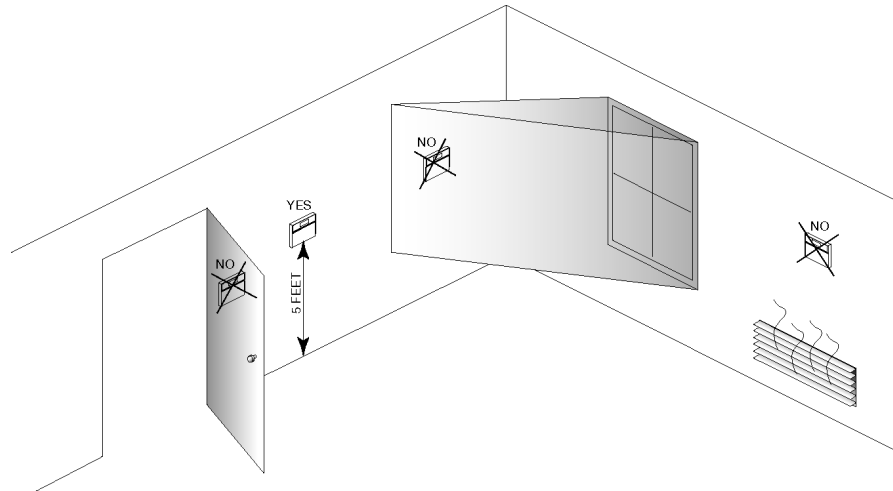

Figure 13: Proper zone sensor placement

*Note: All zone sensor wiring will be done in the factory unless zone sensor options are selected to be wall mounted.*

When a unit-mounted speed switch is selected with a wall-mounted zone sensor, the contractor must disconnect the cooling setpoint on the unit mounted sensor if the wall mounted cooling setpoint is used. The zone signal will be cut at the factory. The unit-mounted speed switch cannot be used as a zone sensor.

The communications link is not connected in the factory. Communications should be wired to the wall-mounted sensor.

# Installation and Wiring

## Humidity and CO<sub>2</sub> Sensors

Humidity and CO<sub>2</sub> sensors should be mounted in a similar location as the zone sensor.

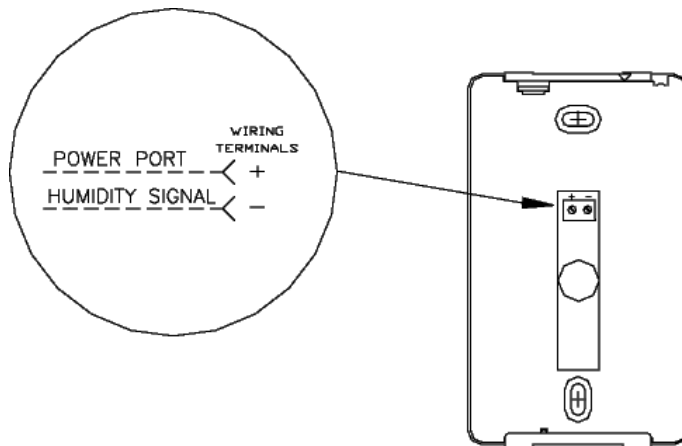
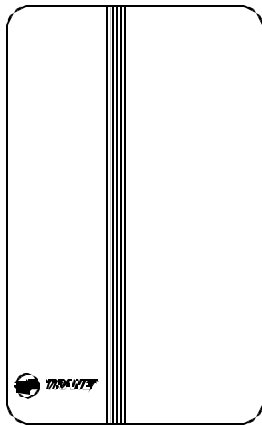
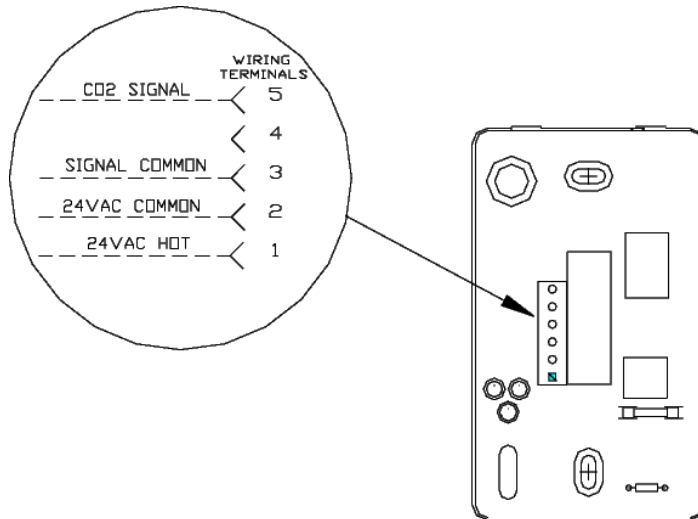
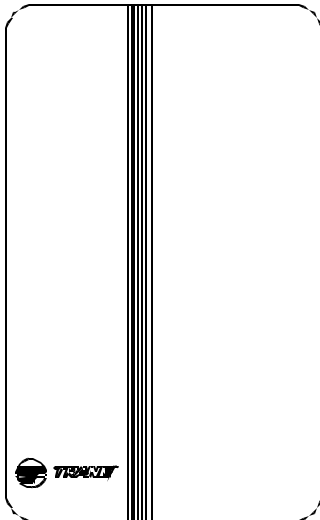

Figure 14: Relative humidity sensor



VIEW WITH COVER REMOVED.

Figure 15: CO<sub>2</sub> Sensor

# Typical Wiring Diagram—Wall Mounted Zone Sensor

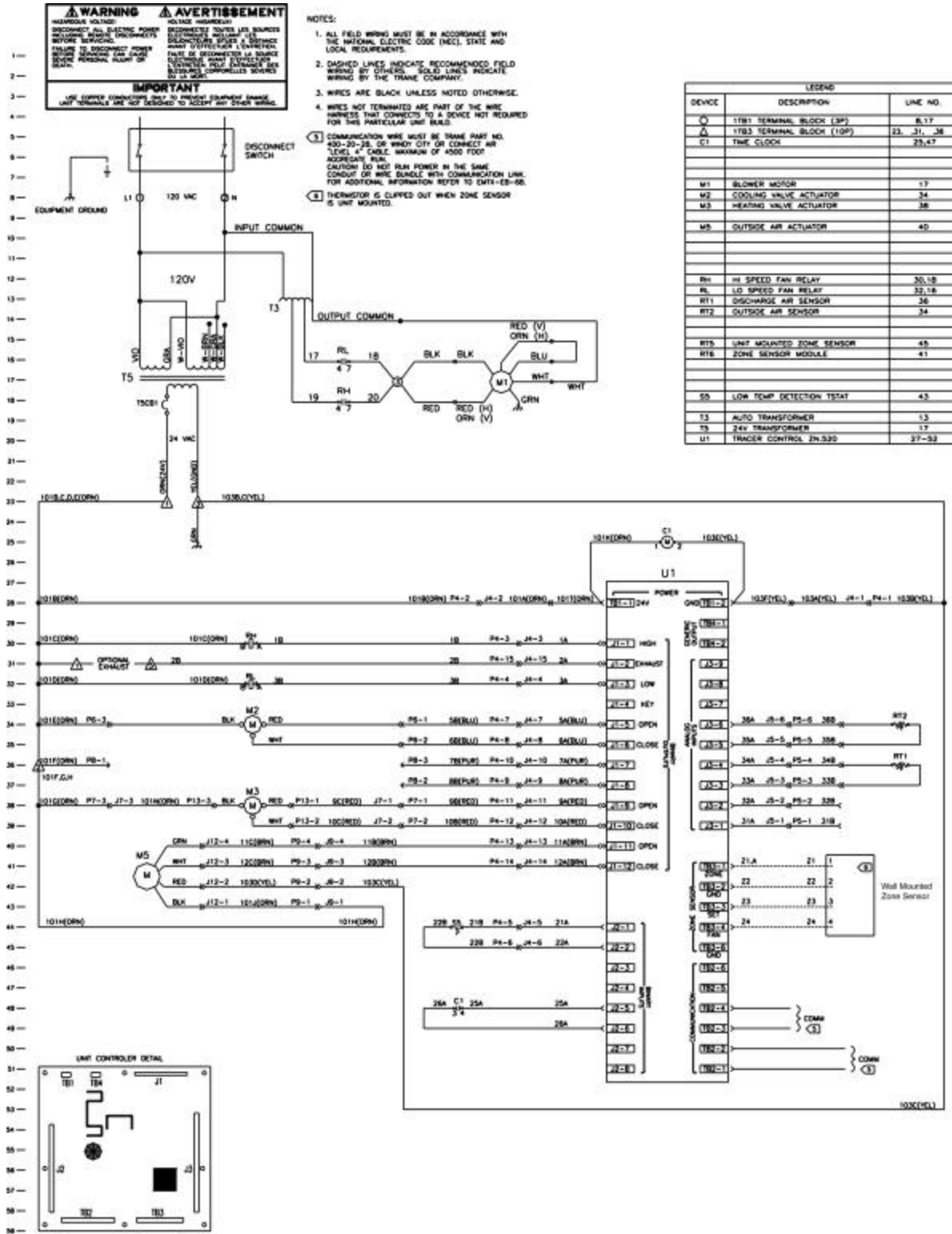



# Typical Wiring Diagram—Unit Mounted Zone Sensor

**AVERTISSEMENT**  
LECTURE OBLIGATOIRE  
DISCONNECT ALL ELECTRICAL POWER INCLUDING REMOTE DISCONNECTS BEFORE SERVICING.  
FAN AIR IS SUPPLYING POWER BEFORE SERVICE CAN BE STARTED. REMOVAL OF FAN AIR SWITCH CAN CAUSE DEATH.

**IMPORTANT**  
LIRE COPIER CONDUCITEUR POUR TOUJOURS EQUIPEMENT MARQUE. UNIT TERMINALS ARE NOT DESIGNED TO ACCEPT ANY OTHER WIRING.

**AVERTISSEMENT**  
LECTURE OBLIGATOIRE  
DISCONNECTEZ TOUJOURS LES SOURCES D'ENERGIE ELECTRIQUE Y COMPRIS LES DISCONNECTS LOUJOURS AVANT DE SERVICER.  
L'AIR DE BRASAGE ALIMENTE LA UNITE AVANT DE COMMENCER LE TRAVAIL. LE RETRAIEMENT DE L'INTERRUPTEUR DE L'AIR DE BRASAGE PEUT CAUSER LA MORT.

- NOTES:
1. ALL FIELD WIRING MUST BE IN ACCORDANCE WITH THE NATIONAL ELECTRIC CODE (NEC), STATE AND LOCAL REQUIREMENTS.
  2. DASHED LINES INDICATE RECOMMENDED FIELD WIRING BY OTHERS. SOLID LINES INDICATE WIRING BY THE TRANE COMPANY.
  3. WIRES ARE BLACK UNLESS NOTED OTHERWISE.
  4. WIRES NOT TERMINATED ARE PART OF THE WIRE HARNESS THAT CONNECTS TO A DEVICE NOT REQUIRED FOR THIS PARTICULAR UNIT BUILD.
  5. COMMUNICATION WIRE MUST BE TRANE PART NO. 490-22-28, OR WHVY CITY OR CONNECT AIR "LOW" 4" CABLE. MAXIMUM OF 4500 FOOT WORKING RUN. CAUTION: DO NOT RUN POWER IN THE SAME CONDUIT OR WIRE BUNDLE WITH COMMUNICATION WIRE. FOR ADDITIONAL INFORMATION REFER TO EMX-ES-68.
  6. THERMISTOR IS CLIPPED OUT WHEN FAN SWITCH IS UNIT MOUNTED.

REVISION	20 CAD	REVISED	2307-9587
REV SHE 8/19/88	BY M.L.	REVISED	2307-9587
REV SHE 10/1/88	BY M.L.	REVISED	2307-9587
REV SHE 05/20/99	BY M.L.	REVISED	2307-9587

DEVICE	DESCRIPTION	LINE NO.
○	17B1 TERMINAL BLOCK (21P)	8,17
□	17B3 TERMINAL BLOCK (10P)	25, 31, 36
□	TIME CLOCK	29, 27
M1	BLOWER MOTOR	17
M2	COOLING VALVE ACTUATOR	34
M3	HEATING VALVE ACTUATOR	38
M5	OUTSIDE AIR ACTUATOR	40
M4	HI SPEED FAN RELAY	35, 18
RL	LO SPEED FAN RELAY	32, 16
RT1	DISCHARGE AIR SENSOR	38
RT2	OUTSIDE AIR SENSOR	34
RTA	UNIT MOUNTED ZONE SENSOR	35
RTB	FAN SWITCH MODULE	41
ES	LOW FAN DETECTION TEST	33
T3	AUTO TRANSFORMER	13
T5	24V TRANSFORMER	17
U1	TRACER CONTROL ZN-520	27-52

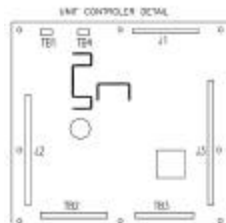
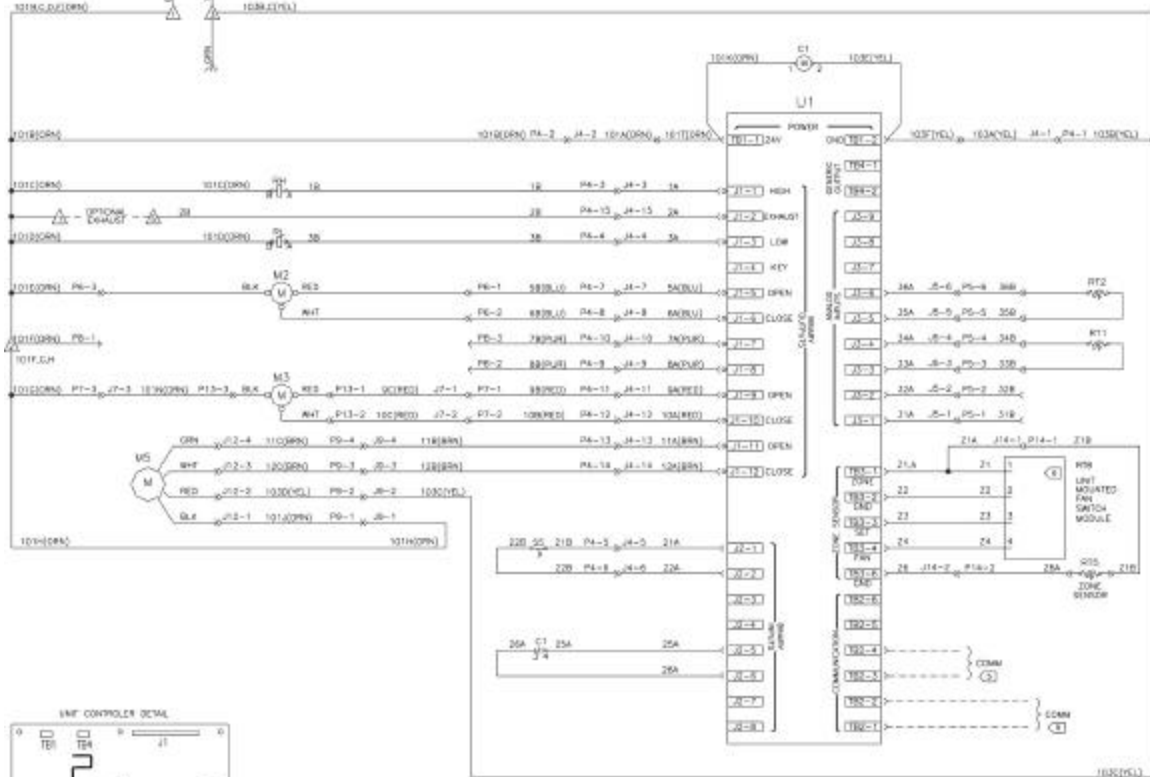
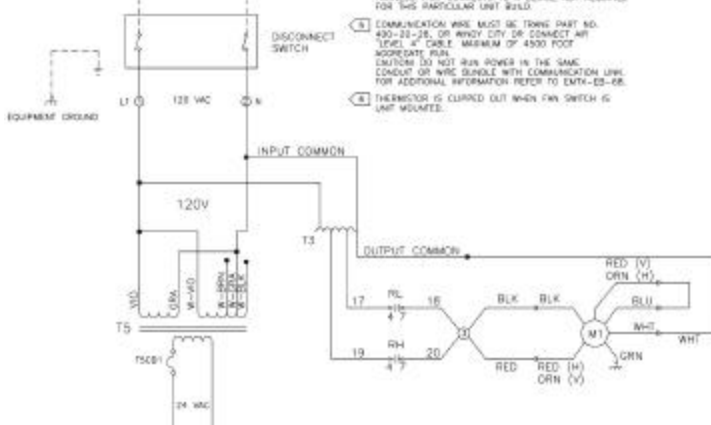

# Typical Wiring Diagram—Unit Mounted Switch, Wall Mounted Sensor

**IMPORTANT**  
USE COPPER CONDUCTORS ONLY TO PREVENT EQUIPMENT DAMAGE. UNIT TERMINALS ARE NOT DESIGNED TO ACCEPT ANY OTHER WIRING.

- NOTES:**
- ALL FIELD WIRING MUST BE IN ACCORDANCE WITH THE NATIONAL ELECTRIC CODE (NEC), STATE AND LOCAL REQUIREMENTS.
  - DASHED LINES INDICATE RECOMMENDED FIELD WIRING BY OTHERS. SOLID LINES INDICATE WIRING BY THE TRANE COMPANY.
  - WIRES ARE BLACK UNLESS NOTED OTHERWISE.
  - WIRES NOT TERMINATED ARE PART OF THE WIRE HARNESS THAT CONNECTS TO A DEVICE NOT REQUIRED FOR THIS MODULAR UNIT BUILD.
  - COMMUNICATION WIRE MUST BE TRANE PART NO. 430-20-26, OR RING CITY OR CONNECT AIR TUBE AT CABLE MAXIMUM OF 4500 FOOT APPROPRIATE PERM.
  - EXHAUSTOR IS CURTLED OUT WHEN FAN SWITCH IS UNIT MOUNTED.
  - WHEN A UNIT-MOUNTED SPEED SWITCH IS SELECTED WITH A WALL-MOUNTED ZONE SENSOR, THE CONTRACTOR MUST DISCONNECT THE COOLING SETPOINT (CSP) ON THE UNIT-MOUNTED SENSOR IF THE WALL-MOUNTED CSP IS USED.

DEVICE	DESCRIPTION	LINE NO.
○	1701 TERMINAL BLOCK (2P)	8,17
△	1702 TERMINAL BLOCK (10P)	23, 31, 36
□	TMR CLOCK	25, 47
M1	BLOWER MOTOR	17
M2	COOLING VALVE ACTUATOR	34
M3	HEATING VALVE ACTUATOR	36
M5	OUTSIDE AIR ACTUATOR	40
M6	HE SPEED FAN RELAY	35, 36
M7	LO SPEED FAN RELAY	32, 35
M11	DISCHARGE AIR SENSOR	36
M12	OUTSIDE AIR SENSOR	34
M16	ZONE SENSOR MODULE	46
M18	FAN SWITCH MODULE	41
EN	LOW TEMP DETECTION TEST	43
T3	AUTO TRANSFORMER	13
T8	24V TRANSFORMER	17
U1	TRACER CONTROL ZNS20	27-32

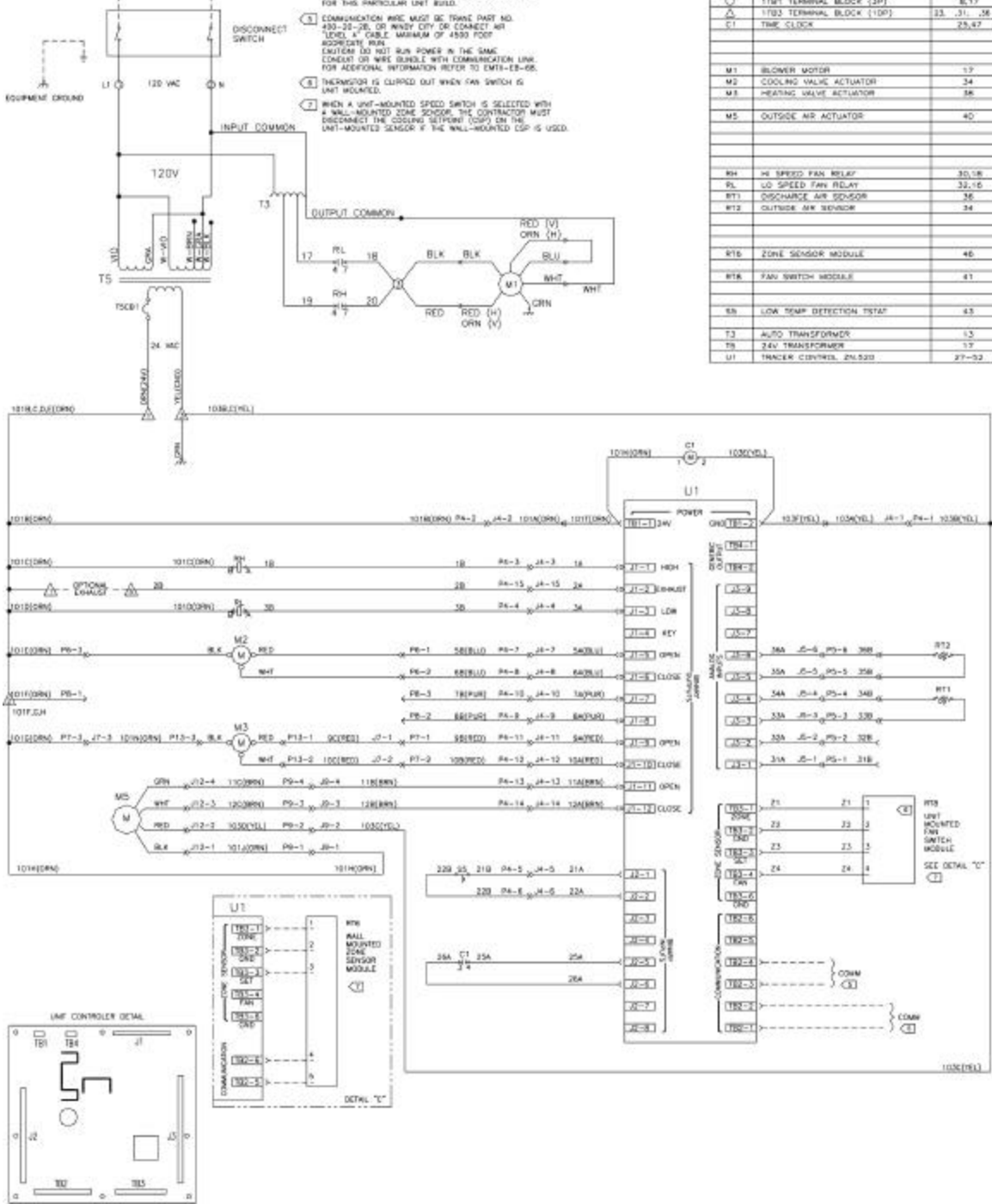



# Input/Output Summary

## Input/Output Summary

The following lists all possible binary and analog inputs and outputs available for the classroom unit ventilator applications. Some of the points listed may be mutually exclusive and some are optional. (See Table 8: Input and output summary)

Most binary inputs and outputs are wired from the factory based on unit configuration and options. If the generic inputs and outputs are to be used, wiring connections are made at the 1/4" quick-connect terminals provided.

Analog inputs from a wall-mounted zone sensor, humidity sensor, CO<sub>2</sub> sensor, or a generic device

must be wired to the 1/4" quick-connect terminals provided. Most other analog inputs will be wired from the factory.

Table 8: Input and output summary

Input	Description
Binary Inputs	Freezestat
	Fan Status
	Occupancy/Generic
Binary Outputs	J1-1 Fan High Speed
	J1-3 Fan Low Speed
	J1-2 Exhaust Fan
	J1-5 Cooling Open (Modulating valve/DX/ Isolation valve)
	J1-6 Cooling Close
	J1-7 Face and Bypass Damper Open
	J1-8 Face and Bypass Damper Close
	J1-9 Heat Open (Modulating valve/Isolation valve) or 1 <sup>st</sup> Stage Electric Heat
	J1-10 Heat Close or 2 <sup>nd</sup> Stage Electric Heat
	J1-11 Economizer Damper Open
	J1-12 Economizer Damper Close
	TB4-1 Generic/Baseboard Heat
	TB4-2 24 VAC

# Input/Output Summary

---

Table 8: Input and output summary

<i>Input</i>	<i>Description</i>
<i>Analog Inputs</i>	<i>Zone Temperature</i>
	<i>Setpoint</i>
	<i>Fan Speed</i>
	<i>Entering Water Temperature</i>
	<i>Discharge Air Temperature</i>
	<i>Outdoor Air Temperature/ Generic</i>
	<i>Generic/Humidity/CO2 (4- 20mA)</i>



# Configuration

Note: The Tracer Zn.520 unit controller only supports cascade control by controlling the discharge air temperature. Therefore, the controller requires both a space temperature input and a discharge air temperature input.

Trane configures the Tracer® ZN.520 Unit Controller at the factory per the selected unit configuration. The controller is applied classroom unit ventilator configurations that support modulating valves, 2-position valves, economizer damper (modulating only), direct expansion (DX) cooling, 1-

and 2 -stage electric heat, face-and-bypass damper, baseboard heat, dehumidification, and generic I/O. The controller also supports HIGH and LOW fan speeds with exhaust fan output on 1- and 2-speed fan applications.

Table 9: Typical applications supported

Configuration	Type of valve		Options		
	Modulating	2 position	Electric Heat (1 or 2 stage)	Economizer Damper	Baseboard Heat
2-pipe cooling only	✓	✓	✓	✓	
2-pipe heating only	✓	✓		✓	✓
2-pipe changeover	✓	✓	✓	✓	✓
4-pipe	✓	✓		✓	✓
4-pipe changeover	✓	✓		✓	✓
2-pipe face bypass heating only		✓ <sup>1</sup>		✓	✓
2-pipe face bypass changeover		✓ <sup>1</sup>		✓	✓
4-pipe face bypass		✓ <sup>1</sup>		✓	✓
DX cooling only	NA	NA		✓	
DX cooling, 2-pipe heating	✓	✓		✓	✓
DX cooling, electric heating	NA	NA	✓	✓	✓
Electric heat only (1 or 2 stage)	NA	NA	✓	✓	✓

1. Isolation valves are 2-position only.

## Configurable parameters

Rover service tool uses the unit type to determine and download many other aspects of the unit configuration, such as the default analog input configuration, the default binary input configuration, and the default binary output configuration.

### Cooling source

- None
- Hydronic (main coil changeover)
- Dedicated hydronic
- DX

### Heating source

- None
- Hydronic
- Dedicated hydronic
- Steam
- Electric heat
- Hydronic (main coil changeover) + dedicated hydronic (auxiliary coil)
- Hydronic (main coil changeover)

# Configuration

## Binary Outputs<sup>1</sup>

Table 10: Binary output summary

Binary output	Classroom unit ventilator		Valid range	
J1-1	Fan high		NA	
J1-2	Exhaust fan or none		NA	
J1-3	Fan low		NA	
J1-4	(Key)		NA	
J1-5	Cooling valve open		NA	
	Face bypass cool isolation valve		Normally open or normally closed <sup>2</sup>	
	2-position cooling		Normally open or normally closed <sup>2</sup>	
	DX		NA	
J1-6	Cooling valve close		NA	
J1-7	Face bypass damper open		NA	
J1-8	Face bypass damper close		NA	
J1-9	Heating valve open		NA	
	Face bypass heat isolation valve		Normally open or normally closed <sup>2</sup>	
	Electric heat stage 1		NA	
	2-position heating		Normally open or normally closed <sup>2</sup>	
J1-10	Heating valve close		NA	
	Electric heat stage 2		NA	
J1-11	Outdoor air damper open		NA	
J1-12	Outdoor air damper close		NA	
TB4-1/TB4-2	Terminals	Output Rating	Load Energized	Load De-energized
Generic/baseboard heat output	TB4-1	12 VA	1 VAC RMS (typical)	24 VAC RMS (typical)
24 VAC	TB4-2			

1. Trane's Rover service tool uses the unit type to determine and download the proper default binary output configuration.

2. The normally open/closed configuration item refers to the inactive state of the controlled end device (such as an 2-position cooling valve output).



# Configuration

## Binary Inputs<sup>1</sup>

Table 11: Binary input summary

Binary input	Configuration	Valid range
BI 1	Low coil temperature detection or not used	Normally open Normally closed
BI 2	Not used	Normally open Normally closed
BI 3	Occupancy, generic, or not used	Normally open Normally closed
BI 4	Fan status or not used	Normally open Normally closed

1. Trane Rover service tool uses the unit type to determine and download the proper default binary input configuration.

## Analog Inputs<sup>1</sup>

Table 12: Analog input summary

Analog input	Configuration	Calibration range
Zone	Space temperature	+/- 10.0°F (0.1°F resolution)
Set	Setpoint (hardwired)	+/- 10.0°F (0.1°F resolution)
Fan	Fan switch	NA
AI 1	Entering water temperature	NA
AI 2	Discharge air temperature	NA
AI 3	Outdoor air temperature or generic temperature input (Note 2)	NA
AI 4	Humidity, CO2 or generic 4-20mA input	NA

1. Trane Rover service tool uses the unit type to determine and download the proper default analog input configuration.

2. Analog input 3 (AI 3) configured as generic temperature input does not affect unit operation. When configured, the Tracer™ ZN.520 Unit Controller communicates the generic temperature value to Rover or Tracer Summit and displays it as generic temperature.

# Configuration

## Fan Configuration

Table 13: Fan configuration ranges

Fan configuration	Default	Valid range
Fan operation in heating	Continuous	Continuous (during occupied) Cycling with capacity (unoccupied)
Fan operation in cooling	Continuous	Continuous (during occupied) Cycling with capacity (unoccupied)
Number of fan speeds	Varies <sup>2</sup>	1, 2
Configurable fan speed heating	Varies <sup>2</sup>	Off, low, high, auto
Configurable fan speed cooling	Varies <sup>2</sup>	Off, low, high, auto
Zone sensor fan switch	Enable	Disable or enable

## End Device Configurations

Table 14: End device ranges

	Default	Valid range
Main, cooling/changeover valve stroke time	Varies <sup>2</sup>	30 - 360 seconds
Entering water sampling	Varies <sup>2</sup>	Disable or enable
Auxiliary, heating valve stroke time	Varies <sup>2</sup>	30 to 360 seconds
Outdoor air damper stroke time	Varies <sup>2</sup>	30 to 360 seconds
Occupied outdoor air damper minimum position	15%	0 to 100%
Occupied standby outside air damper minimum position	15%	0 to 100%
Alternate minimum outside air damper position for low fan speed	40%	0 to 100%
Economizer enable temperature	55 °F	30 to 70°F
Exhaust fan enable setpoint	9%	0 to 100%, 101% disables the exhaust fan
Face-and-bypass damper stroke time	65 seconds	30-360 seconds

1. The exhaust fan is energized when the outdoor air damper is equal to or greater than the exhaust fan enable point, and the exhaust fan is turned off when the outdoor air damper is 10% less than the exhaust fan enable point.

2. Varies with unit configuration.





# Configuration

## Setpoints

Table 15: Setpoint defaults

Setpoint	Default	Valid range
Occupied heating setpoint	71°F	40 to 115°F
Occupied cooling setpoint	74°F	40 to 115°F
Occupied standby heating setpoint	67 °F	40 to 115°F
Occupied standby cooling setpoint	78 °F	40 to 115°F
Unoccupied heating setpoint	60°F	40 to 115°F
Unoccupied cooling setpoint	85°F	40 to 115°F
Heating setpoint low limit <sup>1</sup>	40°F	40 to 115°F
Cooling setpoint low limit <sup>1</sup>	40°F	40 to 115°F
Heating setpoint high limit <sup>1</sup>	105°F	40 to 115°F
Cooling setpoint high limit <sup>1</sup>	110°F	40 to 115°F
Thumbwheel setpoint	Enable	Disable or enable

1. The heating and cooling setpoint high and low limits only apply to the occupied and occupied standby setpoints and are never applied to the unoccupied setpoints.

## Discharge Air Limits

Table 16: Discharge air limit ranges

	Default	Valid range
Low limit <sup>1</sup>	38 °F	30 to 50°F
Control point high limit <sup>2</sup>	150 °F	38 to 150°F
Control point low limit <sup>2</sup>	45 °F	35 to 150°F

1. The low limit is the temperature at which the controller shuts down the unit to prevent the coil from freezing.

2. The control algorithm is limited to calculating this discharge air temperature based on capacity request.

## Freeze Avoidance

Table 17: Freeze avoidance setpoint range

	Default	Valid range
Freeze avoidance setpoint <sup>1</sup>	40 °F	20 to 60°F

The controller disables freeze avoidance when the outdoor air temperature rises 3 °F above the freeze avoidance setpoint.

# Configuration

---

## Occupied Bypass Timer

Table 18: Bypass timer range

	Default	Valid range
Occupancy bypass timer <sup>1</sup>	120 Minutes	0 to 240 minutes (1 minute resolution)

1. The occupied bypass timer is used for timed override applications.

## Power-Up Control Wait

Table 19: Control wait timer

	Default	Valid range
Power up control wait (2 minutes)	120 seconds	Disable or enable

## Maintenance Timers

Table 20: Maintenance timer range

	Default	Valid range
Maintenance timer	0	0 to 10,000 hours

# Location Identifier

## Unit Identification Tag

The unit identification tag is factory mounted and provided for easy identification of an installed unit. It contains model number, tagging, and location information.

The top portion of the unit identification tag remains permanently affixed to the unit for identification purposes. The bottom portion of the tag provides pertinent information that is removable to be placed on building plans or in "Appendix—Location Identifier" on page 68. This provides identification history about the unit's location for quick reference.

These tags provide information about

- unit serial number;
- NID (neuron identification number)—The NID is similar to the serial number of the unit but is specific to the identification of the Tracer ZN.520 unit controller circuit board; and
- unit location—The location identification is a customer defined, clear English description, of the unit's physical location. This is a 27 character description, including spaces, of the location. For example, if the location identification for a unit is "Conference Room 101", the ZN.520, Rover (the Trane Comm 5 service tool), and Tracer Summit, will recognize this clear English description.

If location identification is not defined, it will default to the unit serial number. This unit identification tag provides some information so the user has multiple references to the unit. The blank location is provided for field modification in case the unit is moved from the initial location.

<u>Unit Identification Tag</u>					
Model #: VUVC15011A0FACR91EE11CH100C01110					
Order #: D2A012CA					
Serial #: W99C13405					
Tagging: HP-C					
NID: 01-00-3A-50-2C-00					
Location: ROOM 303					
The Trane Company 182 Cotton Belt Parkway McGregor, Texas 76657					
<table border="1" style="width: 100%; border-collapse: collapse; border-style: dashed;"> <tbody> <tr> <td style="width: 50%; padding: 2px;">NID: 01-00-3A-50-2C-00</td> <td style="width: 50%; padding: 2px;">Location:</td> </tr> <tr> <td style="width: 50%; padding: 2px;">Serial #: W99C13405</td> <td style="width: 50%; padding: 2px;">Location: Room 303</td> </tr> </tbody> </table>		NID: 01-00-3A-50-2C-00	Location:	Serial #: W99C13405	Location: Room 303
NID: 01-00-3A-50-2C-00	Location:				
Serial #: W99C13405	Location: Room 303				

Note: Fold and tear carefully along dashed removable line.

Figure 16: Unit identification tag

### Winking

Winking a device causes the green status LED on the device selected to blink at a rate of twice per second for approximately 10 seconds. This feature is useful when a discrepancy in device location exists. As part of the troubleshooting process, one person can *WINK* the device while another can observe the blinking and verify the device's physical location.

**Important!** If the status LED on the ZN.520 does not blink, the device may not be communicating or it may not be the device you selected according to the stored address.

A Tracer ZN.520 unit controller may be set to wink by

- holding the ON button on the zone sensor for 5 seconds
- using Rover, Trane's communication service tool

# Unit Operation

## Power-Up

When 24 VAC is initially applied to the controller, the following sequence of events occurs:

- ❑ Green status LED turns ON.
- ❑ All outputs are controlled OFF.
- ❑ The controller reads input values to determine initial values.
- ❑ Random-start timer expires (5 to 30 seconds).
- ❑ When *POWER-UP CONTROL WAIT* is enabled, the controller waits 0-120 seconds (depending on configuration) to allow ample time for communicated control data to input. If the controller does not receive communicated information, standalone control is assumed.
- ❑ All modulating valves and dampers calibrate closed.
- ❑ *NORMAL* operation begins.

## Occupancy

The valid occupancy modes for the Tracer ZN.520 controller are:

- ❑ *OCCUPIED* - Normal operating mode for occupied spaces or daytime operation.
- ❑ *UNOCCUPIED* - Normal operating mode for unoccupied spaces or nighttime operation.
- ❑ *OCCUPIED STANDBY* - Mode used to reduce the heating and cooling demands, while providing ventilation, during the occupied hours when the space is vacant or unoccupied.
- ❑ *OCCUPIED BYPASS* - Used to temporarily place the unit into the occupied operation.

The occupancy mode can be hardwired to the controller via the occupancy binary input or communicated to the controller.

## *OCCUPIED mode*

When the controller is in the *OCCUPIED* mode, the unit attempts to maintain the space temperature at the active occupied heating or cooling setpoint.

*OCCUPIED* mode is the default mode of the Tracer ZN.520 controller.

## *UNOCCUPIED mode*

When the controller is in the *UNOCCUPIED* mode, the unit attempts to maintain space temperature at the stored unoccupied heating or cooling setpoint (i.e., configurable through Tracer Summit or the Rover service tool) regardless of the presence of a hardwired or communicated setpoint. When the space temperature exceeds the stored unoccupied setpoint, the controller brings on 100% of the primary heating or cooling capacity.

The *UNOCCUPIED* mode can be initiated through a hardwired signal to the occupancy binary input or by a communicated request.

## *OCCUPIED STANDBY mode*

The *OCCUPIED STANDBY* mode allows the unit to operate at a heating or cooling setpoint between the occupied and unoccupied setpoints to help maintain the environment while decreasing energy consumption.

This mode decreases the ventilation for heating or cooling during brief periods of vacancy in the space. Unit operation in this mode is similar to the occupied mode except for the different heating and cooling setpoints and a different outside air damper position.

The *OCCUPIED STANDBY* mode is initiated only when occupancy is communicated to the Tracer ZN.520 controller and the hardwired signal to the occupancy input is calling for unoccupied operation.

## *OCCUPIED BYPASS mode*

The *OCCUPIED BYPASS* mode is used to transition the unit from the *UNOCCUPIED* mode to the *OCCUPIED* mode for a period of time from 0 to 4 hours (configurable through Rover. Default=*RUN*). The controller can be placed in *OCCUPIED BYPASS* mode by either communicating an occupancy request of *BYPASS* or by using the *TIMED OVERRIDE* (i.e., *ON*) button on the Trane zone sensor.

### *ON and CANCEL Buttons*

Some Trane zone sensors have *ON* and *CANCEL* buttons for timed override operation. Pressing the *ON* button on the zone sensor when the unit is in the *UNOCCUPIED* mode initiates the *OCCUPIED BYPASS* mode and initializes the bypass timer. The *CANCEL* button is used to send the unit back into *UNOCCUPIED* mode before the bypass timer has expired.

The *ON* button may also be used for the unit identification or the "*WINK*" feature. (See "*Winking*" on page 38 for more information.) When the Tracer ZN.520 controller is connected to a Tracer Summit system or the Rover service tool, the *ON* button may be used in place of the service pin for easy unit identification.

## Heating And Cooling Changeover Logic

The Tracer™ ZN.520 Unit Controller can receive communicated requests for heating or cooling operation. The communicated variable *nviApplicMode* is used to communicate the requests for the controller's operating mode based on the following values:

- 0 = Auto (mode determined by controller)
- 1 = Heat (uses heating setpoints)
- 2 = Morning Warm-up
- 3 = Cool (uses cooling setpoints)



# Unit Operation

- 4 = Night Purge (air changeover) not supported
- 5 = Pre-cool (morning cool down)
- 6 = Off (no unit operation allowed)
- 7 = Test (special test mode)
- 8 = Emergency Heat not supported

- 9 = Fan Only (no heating or cooling allowed)

All other enumerations will be interpreted as Auto.

As the controller automatically determines its heating or cooling mode, it changes from cool to heat or from heat to cool, while the error (integrated over time between the active setpoint and the space tem-

perature) is ( $900^{\circ}\text{F} \cdot \text{Sec}$ ). Integration only begins once the heating and cooling capacity is equal to 0% or the discharge air temperature is being limited by the discharge air temperature control limits. (See *Figure 17: "Heat/Cool Changeover logic"*).

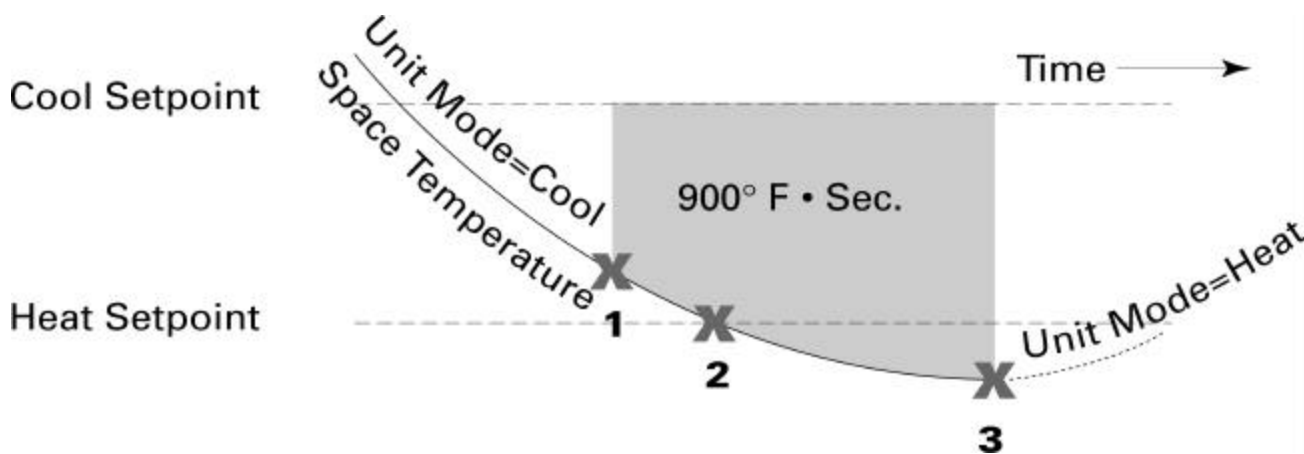

Figure 17: Heat/Cool Changeover logic

If the measured space temperature is  $69^{\circ}\text{F}$  and the active cooling setpoint is  $72^{\circ}\text{F}$ , the error between the space temperature and the setpoint is three degrees. If the same error exists for one minute (60 seconds), the integration term is ( $3^{\circ}\text{F} \cdot 60 \text{ Sec}$ ) or ( $180^{\circ}\text{F} \cdot \text{Sec}$ ).

The Tracer™ ZN.520 Unit Controller changes from heating to cooling and cooling to heating when the integration term exceeds ( $900^{\circ}\text{F} \cdot \text{Sec}$ ). Along with satisfying the integration for heating and cooling changeover, the measured space temperature must fall outside the setpoint range. This means the space temperature must be greater than the active

cooling setpoint or lower than the active heating setpoint.

Example: If the cooling setpoint is  $75^{\circ}\text{F}$  and the heating setpoint  $70^{\circ}\text{F}$ , any space temperature greater than  $75^{\circ}\text{F}$  or less than  $70^{\circ}\text{F}$  is outside the setpoint range.

Once the integration term is satisfied and the space temperature is outside the setpoint range, the controller changes modes. However, before the unit's heating or cooling capacity ramps up, the controller checks to make sure it is capable of heating or cooling.

For some units, heating and cooling capability exists with local resources such as electric heat or

compressors. For these units, central heating or cooling plan operation is not required for heating or cooling because they are capable of providing their own local heating or cooling.

For 2-pipe changeover and 4-pipe changeover units with hydronic capacity, heating and cooling is provided through hydronic. For those hydronic, central heating or cooling plant operation is required for the unit to deliver heating or cooling. To determine whether the central plant is providing the desired water temperature, an entering water temperature sensor (either hardwired or communicated) must be present.

# Unit Operation

The entering water must be five degrees or more above the space temperature to allow hydronic heating, and five degrees or more below the space temperature to allow hydronic cooling.

If the desired water temperature is available, the unit begins normal heating and cooling operation. If the measured entering water temperature is not adequate for the desired heating or cooling, the controller begins the entering water temperature sampling logic.

The Tracer™ ZN.520 Unit Controller operates the modulating valves and dampers based on a heating or cooling capacity calculated by the control algorithm. The control algorithm calculates the heating or cooling capacity based on the measured space temperature, the active setpoint and the discharge air temperature. When the measured space temperature is within the active heating and cooling setpoints, the heating and cooling capacity approaches zero.

## Cooling Operation

During the *COOLING* mode, the Tracer ZN.520 controller attempts to maintain the space temperature at the active cooling setpoint. Based on the controller's occupancy mode, the active cooling setpoint is one of the following:

- Occupied cooling setpoint
- Occupied standby cooling setpoint
- Unoccupied cooling setpoint

The controller uses the measured space temperature, the active cooling setpoint, and discharge air temperature along with the control algorithm to determine the requested cooling capacity of the unit (0-100%). The outputs are controlled based on the unit configuration and the requested cooling capacity.

## Heating Operation

During the *HEATING* mode, the Tracer ZN.520 controller attempts to maintain the space temperature at the active heating setpoint. Based on the controller's occupancy mode, the active heating setpoint is one of the following:

- Occupied heating setpoint
- Occupied standby heating setpoint
- Unoccupied heating setpoint

The controller uses the measured space temperature, the active heating setpoint, and discharge air temperature along with the control algorithm to determine the requested heating capacity of the unit (0-100%). The outputs are controlled based on the unit configuration and the requested heating capacity.

## Fan Operation

For multiple fan speed applications, the Tracer ZN.520 controller allows separate default fan speeds to be configured for heating and cooling modes. When the fan mode switch is in the *AUTO* position or no hardwired input exists, the fan operates at the configured default fan speed (i.e., *HIGH*).

The Tracer ZN.520 controller also allows the default fan speed to be configured as *AUTO*. When the fan speed switch is in the *AUTO* position and the default fan speed is configured as *AUTO*, the unit may change fan speeds based on the requested heating or cooling capacity. In this mode, the unit fan will operate at *LOW* speed until the requested capacity requires *HIGH* fan speed operation to maintain space comfort.

The fan mode request can be either hardwired or communicated to the Tracer ZN.520 controller. When both are present, the communicated request has priority over the hardwired input. Additional flexibility in the controller al-

lows the fan speed switch to be disabled. When this occurs, the unit will operate at the default fan speed unless a communicated request is present.

During *OCCUPIED*, *OCCUPIED STANDBY*, and *OCCUPIED BYPASS* modes, the fan will normally operate continuously at the appropriate fan speed. The fan will only be OFF in these modes when the *MANUAL OUTPUT TEST* has been initiated, a latching diagnostic is present, or the communicated or hardwired fan speed is OFF. (See "*Manual Output Test*" on page 48 for more information.)

During the *UNOCCUPIED* mode, the unit fan is controlled OFF. When capacity is required to maintain the unoccupied heating or cooling setpoint, the unit fan is controlled to high speed regardless of a hardwired or communicated fan speed.

Table 21: Absolute two-speed fan switch points

Fan Speed Change	Absolute Temperature Error
Low to High	2.00 °F
High to Low	1.25 °F

## Fan Off Delay

When a heating output is controlled off, the Tracer™ ZN.520 Unit Controller automatically holds the fan on for an additional 30 seconds. This 30-second delay gives the fan time to blow off any residual heat from the heating source, such as a steam coil. When the unit is heating, the fan off delay is normally applied to control the fan; otherwise, the fan off delay does not apply.

## Fan Start On High Speed

On a transition from off to any other fan speed, the Tracer™ ZN.520 Unit Controller automatically starts the fan on high speed and runs the fan at high speed for 0.5

# Unit Operation

seconds. This provides the ample torque required to start all fan motors from the off position.

## Exhaust fan/damper operation

This binary point is a shared point with medium fan speed. For this point to be used for exhaust control, the controller must be configured for a 1- or 2-speed fan. The exhaust fan/damper is coordinated with the unit fan and outdoor damper operation. The exhaust output is energized only when the unit fan is operating and the outdoor damper position is greater than or equal to the configurable exhaust enable point. The exhaust fan output is disabled when the outdoor air damper position drops 10% below the exhaust enable point. If the enable point is less than 10%, the unit turns on at the enable point and off at 0.

## Valve Operation

### Modulating Valves

The Tracer ZN.520 controller supports one or two modulating valves for hydronic heating and cooling operation. The main valve/coil is used for cooling only, heat/cool changeover (2-pipe applications), or cooling (4-pipe applications). The auxiliary valve/coil provides heating in 4-pipe and heating only applications.

At power-up, the Tracer ZN.520 controller drives the modulating valves to the closed position. The controller calibrates to the full closed position by overdriving the actuator 135%. Whenever the controller requests a valve position of zero or 100%, the controller overdrives the actuator 135% regardless of the current valve position.

## Face-and-Bypass Isolation Valves

Face-and-bypass units may use isolation valves to prevent unwanted water flow in the coil. This eliminates problems such as radiant heat or excessive condensate in 2-pipe systems.

In 4-pipe applications, the isolation valves are used to prevent conflicting capacities within the unit.

## Face-and-Bypass Damper Operation

*Note: The Face-and-bypass actuator is located in the right-hand end pocket of the classroom unit ventilator.*

The Tracer ZN.520 controller actuates a face-and-bypass damper to modulate a percentage of air to the face of the coil to maintain space comfort. When a requested capacity is present, the unit modulates the damper to allow more air to the face of the coil. An averaging sensor is used on the discharge air to provide accurate capacity control.

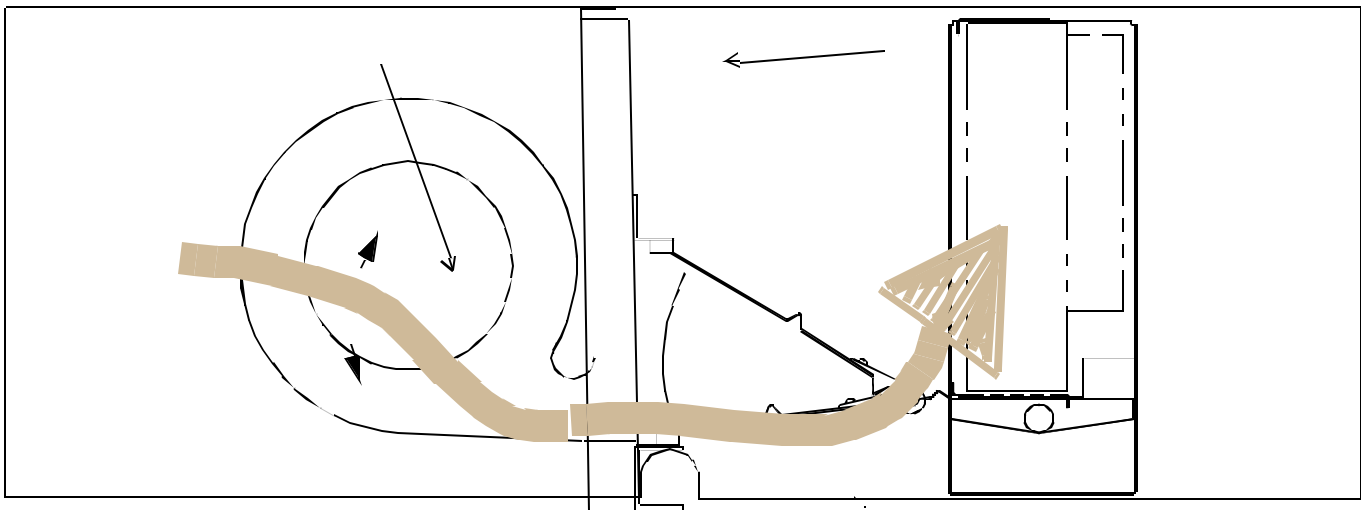

Figure 18: Horizontal unit with face-and-bypass damper option.

# Unit Operation

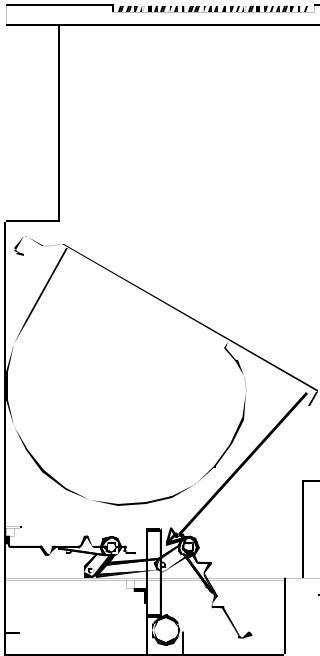

Figure 19: Vertical unit with face-and-bypass damper operations

Upon power-up, the controller calibrates the face-and-bypass damper to the full bypass position by overdriving the damper actuator. During normal operation, whenever the Tracer ZN.520 controller generates a face-and-bypass damper position request of zero or 100%, the unit calibrates the actuator by overdriving the damper actuator 135%.

## Entering Water Temperature Sampling

Units with 4-pipe changeover and 2-pipe changeover require an entering water temperature to determine if the appropriate water temperature is present for the requested mode (heating or cooling). This temperature may be communicated in an ICS system or hardwired to the Tracer ZN.520

controller for standalone applications.

When a unit uses 2-way modulating valves, it is possible for the water near the entering water temperature sensor to migrate towards ambient temperature. The Tracer ZN.520 controller has a water sampling feature for these applications. When the sensed water temperature is not sufficient for the requested heat/cool mode (5°F above the zone temperature for heating or 5°F below the zone temperature for cooling), the controller drives the valve fully open. The controller then monitors the water temperature until the appropriate temperature is sensed or until the three minute time limit expires. If the water temperature is acceptable for the requested capacity, the unit continues normal operation. If the three minute timer expires and the water temperature is still unsuitable, the unit closes the valve and waits one hour before invoking the sampling feature again.

Table 22: Water assumption chart

Unit Configuration	Temperature Assumed <sup>1</sup>
2-pipe Heating valve	Hot
2-pipe cooling valve	Cold
2-pipe H/C valve with auto changeover enabled	Hot
2-pipe H/C valve with auto changeover disabled	Cold

1. Assumption based on absence of a valid entering water temperature

## Modulating Outdoor Air Operation

The Tracer ZN.520 controller operates a modulating (3-wire floating) outdoor air damper actuator according to the effective occupancy, outdoor air temperature, space temperature, effective setpoint, discharge air temperature, and discharge air temperature set-

point. Default minimum damper positions are provided and can be changed for occupied and occupied standby modes, or for low speed operation. The controller can also receive a communicated outdoor air damper minimum position from Tracer Summit. A communicated minimum position from Tracer Summit has priority over all configured setpoints.

During the *OCCUPIED* mode the outdoor air damper will always be controlled to the effective minimum position unless ASHRAE Cycle I, ASHRAE Cycle II, or economizing modes are active.

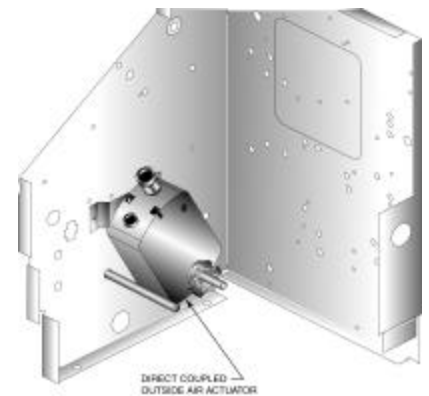

Figure 20: OA/RA actuator mounting for the vertical unit ventilator



Figure 21: Figure 2: OA/RA actuator mounting for the horizontal unit ventilator



# Unit Operation

## Automatic Outdoor Air Damper Adjustment

The Tracer ZN.520 controller is capable of using different minimum outdoor air damper positions for high and low fan speeds, which are configurable. This allows the ventilation rate to be maintained when switching between fan speeds.

*Note: The typical reduction in airflow between high and low fan speeds is 25%, however, if precise control is desired, an air balancer should be consulted.*

## Economizer Operation

*Note: When there is a request for 0% or 100% actuator position, the actuator will overdrive the actuator 135% to help maintain calibration.*

With a valid outdoor air temperature (hardwired or communicated), Tracer ZN.520 uses the modulating economizer damper as the highest priority source of cooling.

The controller initiates the economizer function if the outdoor air temperature is cold enough to be used for free cooling capacity. If the outdoor air temperature is less than the economizer enable setpoint (absolute dry bulb), the controller modulates the outdoor air damper between the minimum position and 100% to control the amount of cooling capacity. When the outdoor air temperature rises 5°F above the economizer enable setpoint, the outdoor air damper returns to its minimum position and mechanical cooling is initiated.

## ASHRAE Cycle I

ASHRAE Cycle I admits 100% outdoor air except during the warm up cycle or the unoccupied mode. To set up the Tracer ZN.520 controller for ASHRAE Cycle I conformance, set the occupied outdoor air damper minimum position to 100%.

## ASHRAE Cycle II

The Tracer ZN.520 controller conforms to ASHRAE Cycle II by allowing the modulating outdoor air damper to maintain a minimum position during the occupied mode unless economizing is enabled or the space temperature falls more than 3°F below the effective setpoint.

If the space temperature falls more than 2°F below the setpoint, the outdoor air damper will begin to close. When the space temperature hits 3°F below the setpoint, the outdoor air damper is completely closed.

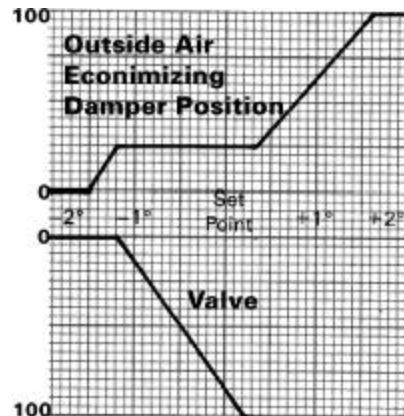

Figure 22: ASHRAE cycle 2

## DX Operation

Tracer ZN.520 supports direct expansion (DX) compressor operation for cooling only.

The controller does not allow both the DX compressor and economizer to operate at the same time. This prevents problems where the entering air temperature is too low for the evaporator coil to operate as designed.

Tracer ZN.520 also includes a fixed minimum on/off time of 3 minutes for compressor operation to prevent short cycling of the compressor.

## Electric Heat Operation

The Tracer ZN.520 controller supports 1 or 2 stages of electric heat control.

To control space temperature, electric heat is cycled to control the discharge air temperature. The rate of cycling is dependent on the load in the space and the temperature of the incoming fresh air.

## Baseboard Heat Operation

The Tracer ZN.520 controller can be configured to support one stage of baseboard heat. A 2 position valve or an electric heat contactor will be energized at 2.5°F below the effective heating setpoint. The baseboard heat is de-energized at 1°F below the effective heating setpoint.

The unit will provide heating capacity as required regardless of the presence of baseboard heat. If the unit can not maintain the space temperature, the baseboard heat will come on as a secondary stage.

If baseboard heat is to be used as the primary source of heating, the discharge air high limit should be set to a moderate temperature. This will allow the ventilation air to be tempered and avoid a "drafty" feeling. The baseboard heat will then operate as the heating capacity for the space.

In the *UNOCCUPIED* mode, the baseboard heat and unit heating capacity are brought on simultaneously as needed to maintain the unoccupied setpoint.

## Exhaust Fan Operation

The exhaust fan is coordinated with the unit fan and outdoor air damper operation. The exhaust fan output is energized only when the unit fan is operating and the outdoor air damper position is greater

# Unit Operation

than or equal to the configurable exhaust enable setpoint. This is useful for exhaust fans designed to offset the added economizer ventilation.

The exhaust fan is disabled when the outdoor air damper position drops 10% below the exhaust enable point. If the exhaust fan enable setpoint is less than 10%, the Tracer ZN.520 controller energizes the exhaust fan at the enable point and disables it when the outdoor air damper closes.

## Output Overrides

### Manual Output Test

Manual output test allows the binary outputs to be energized in a predefined sequence. (*For more information see, Manual Output Test, on page 48 for more information.*)

### Water Valve Override

To enable quicker water balancing, the controller allows a user to specify the desired state of all water valves. The values supported are:

- Open all valves
- Close all valves

The valves in the system will remain open for two hours or until normal operation is resumed.

The Tracer Summit or the Rover service tool is required to access this feature.

## Fan Status

There are two ways to do fan status monitoring:

1. The status of the fan is reported based on the state of the binary output(s) dedicated to fan control. The fan status is reported as HIGH or LOW whenever the corresponding binary output is directed ON.

The fan status is reported as OFF when none of the fan outputs are directed ON.

2. The Tracer ZN.520 controller has a binary input available for a fan status device (current sensing relay or differential pressure switch) which can provide feedback of fan operation. If the device does not indicate fan operation after 1 minute, a unit shutdown is initiated, and the unit is latched OFF.

## Filter Status/ Maintenance Timer

The unit filter status/maintenance timer is based on the cumulative run hours of the unit fan. The controller compares the fan run time against an adjustable fan run hour limit and recommends unit maintenance as required.

The Rover service tool is used to edit the maintenance required setpoint time. Once the setpoint limit is exceeded, the controller generates a MAINTENANCE REQUIRED informational diagnostic. When the maintenance required setpoint time is set to zero, the controller disables this feature.

You can use the Trace Summit or the Rover service tool to clear the MAINTENANCE REQUIRED informational diagnostic. Once the diagnostic is cleared, the controller resets the fan run time to zero and begins accumulating fan run hours again.

*Note: If at any time the unit loses power, the timer is reset to zero.*

## Other Modes

### DEHUMIDIFICATION

*Note: If the unit is in the unoccupied mode, the dehumidification routine will not operate*

Dehumidification is possible when mechanical cooling is available; the heating capacity is in the re-heat position; and the space relative humidity setpoint is valid.

The controller starts dehumidifying the space when the space humidity exceeds the humidity setpoint. The controller continues to dehumidify until the sensed humidity falls below the setpoint minus the relative humidity offset.

The controller uses the cooling and reheat coils simultaneously to dehumidify the space. When dehumidifying, the discharge air temperature is controlled to maintain the space temperature at the current setpoint.

Economizing is disabled during the dehumidification mode.

*Note: While in the dehumidification mode, if there is a call for capacity by the unit, the zone temperature setpoint will take priority over the relative humidity setpoints.*

### DEFROST

For defrost operation, a sensor is wired in series with the DX cooling relay. When a defrost condition is detected, the condensing unit is disabled, and the unit is placed in the DEFROST mode.

During DEFROST the condensing unit is OFF the outside air damper is set to the minimum positions, and the fan will continue to operate as continuous. The unit will remain in the DEFROST mode until the sensor resets at 48°F. The unit will return to NORMAL operation after the mode is discontinued.

### FREEZE AVOIDANCE

FREEZE AVOIDANCE is used as low ambient temperature protection, and is only invoked when the fan is OFF. This includes the UNOCCUPIED mode when there is no call for capacity, or any other time the fan is

# Unit Operation

OFF due to a safety or command. The controller enters the *FREEZE AVOIDANCE* mode when an outdoor air temperature is present (communicated or hardwired) and it is below the freeze avoidance setpoint (configurable). The controller disables freeze avoidance when the outdoor air temperature rises 3°F above the freeze avoidance setpoint.

When the controller is in the freeze avoidance mode:

- All water valves are driven open to allow water flow through the coil
- Fan is OFF
- Face-and-bypass damper (when present) is in full *BYPASS*
- DX and electric heat are OFF

### MORNING WARM-UP

The Tracer ZN.520 controller keeps the modulating outdoor air damper closed anytime during the *OCCUPIED* mode when the space temperature is 3°F or more below the heating setpoint.

The damper remains closed indefinitely during morning warm-up until the space temperature is within 2°F of the effective heating setpoint. The unit runs at full capacity until setpoint is met.

### COOL-DOWN

The Tracer ZN.520 controller keeps the modulating outdoor air damper closed for up to one hour at every transition from *UNOCCUPIED* to *OCCUPIED* mode when the space temperature is 3°F or more above the cooling setpoint.

The damper remains closed during cool-down until the space temperature is within 2°F of the effective cooling setpoint. The unit runs at full capacity until setpoint is met.

### Data Sharing—LonWorks

Tracer ZN.520 allows peer-to-peer data communication through the use of LonWork's technology. Data such as space temperature setpoint, occupancy, etc. can be shared from a master controller to

a peer controller over a twisted pair of communication wire with or without the presence of a front end building management system. (See Figure 23: "Simple data sharing application") This ability allows units to operate with the same data to prevent conflicting control.

Data sharing is established through the use of "bindings". Bindings are set up through the Rover service tool.

The Tracer ZN.520 controller includes a network variable for master/slave operation. This variable includes all of the information required for the slave units to operate with master controller. (See Figure 24: "More complex data sharing application")

For more information on establishing bindings, see the Rover service tool manual. For a complete listing on shared points see "Appendix—Data Lists" on page64.

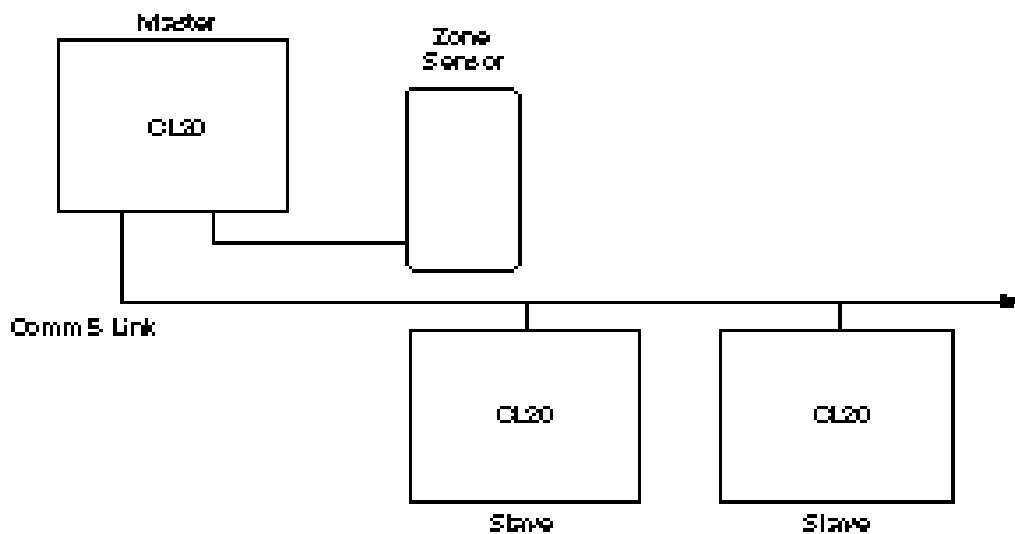

Figure 23: Simple data sharing application

# Unit Operation

---

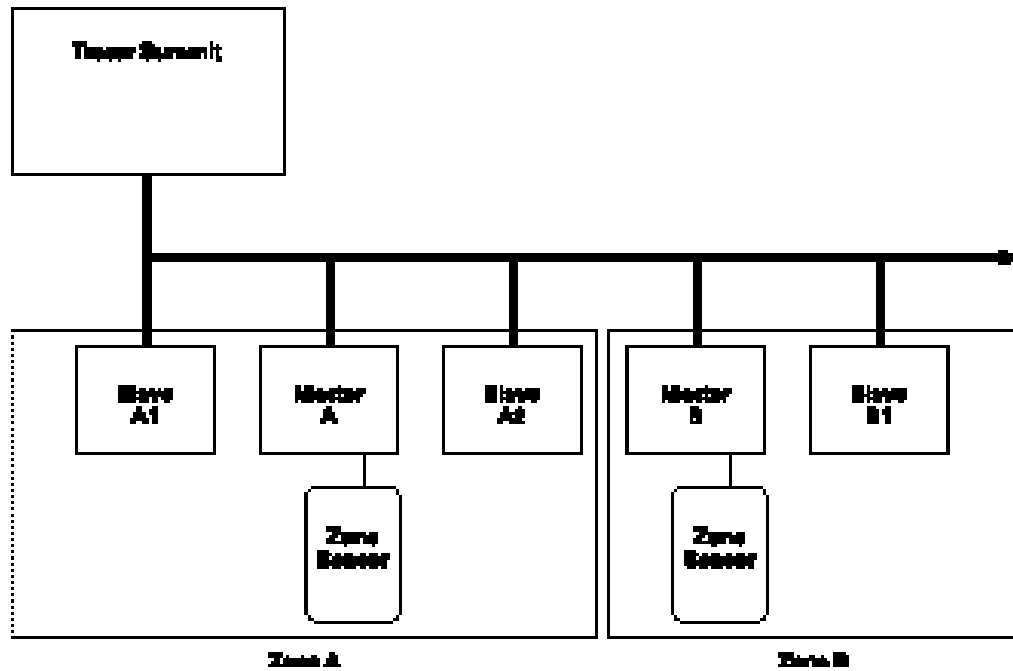

Figure 24: More complex data sharing application

# Unit Operation

## Power-Up

When 24 VAC is initially applied to the controller, the following sequence of events occurs:

- ❑ Green status LED turns ON.
- ❑ All outputs are controlled OFF.
- ❑ The controller reads input values to determine initial values.
- ❑ Random-start timer expires (5 to 30 seconds).
- ❑ When *POWER-UP CONTROL WAIT* is enabled, the controller waits 0-120 seconds (depending on configuration) to allow ample time for communicated control data to input. If the controller does not receive communicated information, standalone control is assumed.
- ❑ All modulating valves and dampers calibrate closed.
- ❑ *NORMAL* operation begins.

## Occupancy

The valid occupancy modes for the Tracer ZN.520 controller are:

- ❑ *OCCUPIED* - Normal operating mode for occupied spaces or daytime operation.
- ❑ *UNOCCUPIED* - Normal operating mode for unoccupied spaces or nighttime operation.
- ❑ *OCCUPIED STANDBY* - Mode used to reduce the heating and cooling demands, while providing ventilation, during the occupied hours when the space is vacant or unoccupied.
- ❑ *OCCUPIED BYPASS* - Used to temporarily place the unit into the occupied operation.

The occupancy mode can be hardwired to the controller via the occupancy binary input or communicated to the controller.

## *OCCUPIED mode*

When the controller is in the *OCCUPIED* mode, the unit attempts to maintain the space temperature at the active occupied heating or cooling setpoint.

*OCCUPIED* mode is the default mode of the Tracer ZN.520 controller.

## *UNOCCUPIED mode*

When the controller is in the *UNOCCUPIED* mode, the unit attempts to maintain space temperature at the stored unoccupied heating or cooling setpoint (i.e., configurable through Tracer Summit or the Rover service tool) regardless of the presence of a hardwired or communicated setpoint. When the space temperature exceeds the stored unoccupied setpoint, the controller brings on 100% of the primary heating or cooling capacity.

The *UNOCCUPIED* mode can be initiated through a hardwired signal to the occupancy binary input or by a communicated request.

## *OCCUPIED STANDBY mode*

The *OCCUPIED STANDBY* mode allows the unit to operate at a heating or cooling setpoint between the occupied and unoccupied setpoints to help maintain the environment while decreasing energy consumption.

This mode decreases the ventilation for heating or cooling during brief periods of vacancy in the space. Unit operation in this mode is similar to the occupied mode except for the different heating and cooling setpoints and a different outside air damper position.

The *OCCUPIED STANDBY* mode is initiated only when occupancy is communicated to the Tracer ZN.520 controller and the hardwired signal to the occupancy input is calling for unoccupied operation.

## *OCCUPIED BYPASS mode*

The *OCCUPIED BYPASS* mode is used to transition the unit from the *UNOCCUPIED* mode to the *OCCUPIED* mode for a period of time from 0 to 4 hours (configurable through Rover. Default=*RUN*). The controller can be placed in *OCCUPIED BYPASS* mode by either communicating an occupancy request of *BYPASS* or by using the *TIMED OVERRIDE* (i.e., *ON*) button on the Trane zone sensor.

## *ON and CANCEL Buttons*

Some Trane zone sensors have *ON* and *CANCEL* buttons for timed override operation. Pressing the *ON* button on the zone sensor when the unit is in the *UNOCCUPIED* mode initiates the *OCCUPIED BYPASS* mode and initializes the bypass timer. The *CANCEL* button is used to send the unit back into *UNOCCUPIED* mode before the bypass timer has expired.

The *ON* button may also be used for the unit identification or the "*WINK*" feature. (See "*Winking*" on page 38 for more information.) When the Tracer ZN.520 controller is connected to a Tracer Summit system or the Rover service tool, the *ON* button may be used in place of the service pin for easy unit identification.

## Heating And Cooling Changeover Logic

The Tracer™ ZN.520 Unit Controller can receive communicated requests for heating or cooling operation. The communicated variable *nviApplicMode* is used to communicate the requests for the controller's operating mode based on the following values:

- 0 = Auto (mode determined by controller)
- 1 = Heat (uses heating setpoints)
- 2 = Morning Warm-up
- 3 = Cool (uses cooling setpoints)

# Unit Operation

- 4 = Night Purge (air changeover) not supported
- 5 = Pre-cool (morning cool down)
- 6 = Off (no unit operation allowed)
- 7 = Test (special test mode)
- 8 = Emergency Heat not supported

- 9 = Fan Only (no heating or cooling allowed)

All other enumerations will be interpreted as Auto.

As the controller automatically determines its heating or cooling mode, it changes from cool to heat or from heat to cool, while the error (integrated over time between the active setpoint and the space tem-

perature) is ( $900^{\circ}\text{F} \cdot \text{Sec}$ ). Integration only begins once the heating and cooling capacity is equal to 0% or the discharge air temperature is being limited by the discharge air temperature control limits. (See *Figure 17: "Heat/Cool Changeover logic"*).

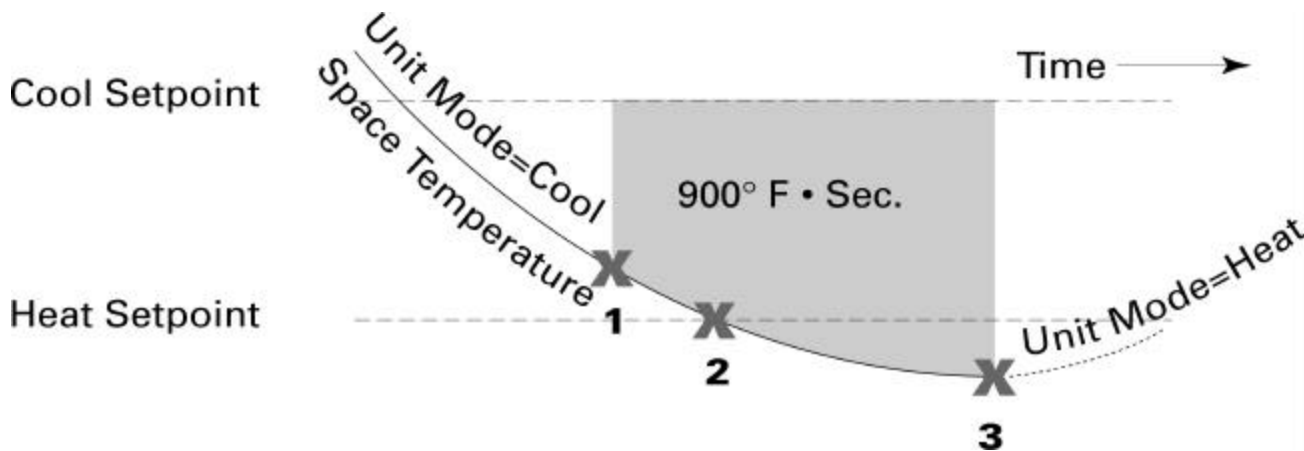

Figure 17: Heat/Cool Changeover logic

If the measured space temperature is  $69^{\circ}\text{F}$  and the active cooling setpoint is  $72^{\circ}\text{F}$ , the error between the space temperature and the setpoint is three degrees. If the same error exists for one minute (60 seconds), the integration term is ( $3^{\circ}\text{F} \cdot 60 \text{ Sec}$ ) or ( $180^{\circ}\text{F} \cdot \text{Sec}$ ).

The Tracer™ ZN.520 Unit Controller changes from heating to cooling and cooling to heating when the integration term exceeds ( $900^{\circ}\text{F} \cdot \text{Sec}$ ). Along with satisfying the integration for heating and cooling changeover, the measured space temperature must fall outside the setpoint range. This means the space temperature must be greater than the active

cooling setpoint or lower than the active heating setpoint.

Example: If the cooling setpoint is  $75^{\circ}\text{F}$  and the heating setpoint  $70^{\circ}\text{F}$ , any space temperature greater than  $75^{\circ}\text{F}$  or less than  $70^{\circ}\text{F}$  is outside the setpoint range.

Once the integration term is satisfied and the space temperature is outside the setpoint range, the controller changes modes. However, before the unit's heating or cooling capacity ramps up, the controller checks to make sure it is capable of heating or cooling.

For some units, heating and cooling capability exists with local resources such as electric heat or

compressors. For these units, central heating or cooling plan operation is not required for heating or cooling because they are capable of providing their own local heating or cooling.

For 2-pipe changeover and 4-pipe changeover units with hydronic capacity, heating and cooling is provided through hydronic. For those hydronic, central heating or cooling plant operation is required for the unit to deliver heating or cooling. To determine whether the central plant is providing the desired water temperature, an entering water temperature sensor (either hardwired or communicated) must be present.

# Unit Operation

The entering water must be five degrees or more above the space temperature to allow hydronic heating, and five degrees or more below the space temperature to allow hydronic cooling.

If the desired water temperature is available, the unit begins normal heating and cooling operation. If the measured entering water temperature is not adequate for the desired heating or cooling, the controller begins the entering water temperature sampling logic.

The Tracer™ ZN.520 Unit Controller operates the modulating valves and dampers based on a heating or cooling capacity calculated by the control algorithm. The control algorithm calculates the heating or cooling capacity based on the measured space temperature, the active setpoint and the discharge air temperature. When the measured space temperature is within the active heating and cooling setpoints, the heating and cooling capacity approaches zero.

## Cooling Operation

During the *COOLING* mode, the Tracer ZN.520 controller attempts to maintain the space temperature at the active cooling setpoint. Based on the controller's occupancy mode, the active cooling setpoint is one of the following:

- Occupied cooling setpoint
- Occupied standby cooling setpoint
- Unoccupied cooling setpoint

The controller uses the measured space temperature, the active cooling setpoint, and discharge air temperature along with the control algorithm to determine the requested cooling capacity of the unit (0-100%). The outputs are controlled based on the unit configuration and the requested cooling capacity.

## Heating Operation

During the *HEATING* mode, the Tracer ZN.520 controller attempts to maintain the space temperature at the active heating setpoint. Based on the controller's occupancy mode, the active heating setpoint is one of the following:

- Occupied heating setpoint
- Occupied standby heating setpoint
- Unoccupied heating setpoint

The controller uses the measured space temperature, the active heating setpoint, and discharge air temperature along with the control algorithm to determine the requested heating capacity of the unit (0-100%). The outputs are controlled based on the unit configuration and the requested heating capacity.

## Fan Operation

For multiple fan speed applications, the Tracer ZN.520 controller allows separate default fan speeds to be configured for heating and cooling modes. When the fan mode switch is in the *AUTO* position or no hardwired input exists, the fan operates at the configured default fan speed (i.e., *HIGH*).

The Tracer ZN.520 controller also allows the default fan speed to be configured as *AUTO*. When the fan speed switch is in the *AUTO* position and the default fan speed is configured as *AUTO*, the unit may change fan speeds based on the requested heating or cooling capacity. In this mode, the unit fan will operate at *LOW* speed until the requested capacity requires *HIGH* fan speed operation to maintain space comfort.

The fan mode request can be either hardwired or communicated to the Tracer ZN.520 controller. When both are present, the communicated request has priority over the hardwired input. Additional flexibility in the controller al-

lows the fan speed switch to be disabled. When this occurs, the unit will operate at the default fan speed unless a communicated request is present.

During *OCCUPIED*, *OCCUPIED STANDBY*, and *OCCUPIED BYPASS* modes, the fan will normally operate continuously at the appropriate fan speed. The fan will only be OFF in these modes when the *MANUAL OUTPUT TEST* has been initiated, a latching diagnostic is present, or the communicated or hardwired fan speed is OFF. (See "*Manual Output Test*" on page 48 for more information.)

During the *UNOCCUPIED* mode, the unit fan is controlled OFF. When capacity is required to maintain the unoccupied heating or cooling setpoint, the unit fan is controlled to high speed regardless of a hardwired or communicated fan speed.

Table 21: Absolute two-speed fan switch points

Fan Speed Change	Absolute Temperature Error
Low to High	2.00 °F
High to Low	1.25 °F

## Fan Off Delay

When a heating output is controlled off, the Tracer™ ZN.520 Unit Controller automatically holds the fan on for an additional 30 seconds. This 30-second delay gives the fan time to blow off any residual heat from the heating source, such as a steam coil. When the unit is heating, the fan off delay is normally applied to control the fan; otherwise, the fan off delay does not apply.

## Fan Start On High Speed

On a transition from off to any other fan speed, the Tracer™ ZN.520 Unit Controller automatically starts the fan on high speed and runs the fan at high speed for 0.5

# Unit Operation

seconds. This provides the ample torque required to start all fan motors from the off position.

## *Exhaust fan/damper operation*

This binary point is a shared point with medium fan speed. For this point to be used for exhaust control, the controller must be configured for a 1- or 2-speed fan. The exhaust fan/damper is coordinated with the unit fan and outdoor damper operation. The exhaust output is energized only when the unit fan is operating and the outdoor damper position is greater than or equal to the configurable exhaust enable point. The exhaust fan output is disabled when the outdoor air damper position drops 10% below the exhaust enable point. If the enable point is less than 10%, the unit turns on at the enable point and off at 0.

## Valve Operation

### *Modulating Valves*

The Tracer ZN.520 controller supports one or two modulating valves for hydronic heating and cooling operation. The main valve/coil is used for cooling only, heat/cool changeover (2-pipe applications), or cooling (4-pipe applications). The auxiliary valve/coil provides heating in 4-pipe and heating only applications.

At power-up, the Tracer ZN.520 controller drives the modulating valves to the closed position. The controller calibrates to the full closed position by overdriving the actuator 135%. Whenever the controller requests a valve position of zero or 100%, the controller overdrives the actuator 135% regardless of the current valve position.

## *Face-and-Bypass Isolation Valves*

Face-and-bypass units may use isolation valves to prevent unwanted water flow in the coil. This eliminates problems such as radiant heat or excessive condensate in 2-pipe systems.

In 4-pipe applications, the isolation valves are used to prevent conflicting capacities within the unit.

## Face-and-Bypass Damper Operation

*Note: The Face-and-bypass actuator is located in the right-hand end pocket of the classroom unit ventilator.*

The Tracer ZN.520 controller actuates a face-and-bypass damper to modulate a percentage of air to the face of the coil to maintain space comfort. When a requested capacity is present, the unit modulates the damper to allow more air to the face of the coil. An averaging sensor is used on the discharge air to provide accurate capacity control.

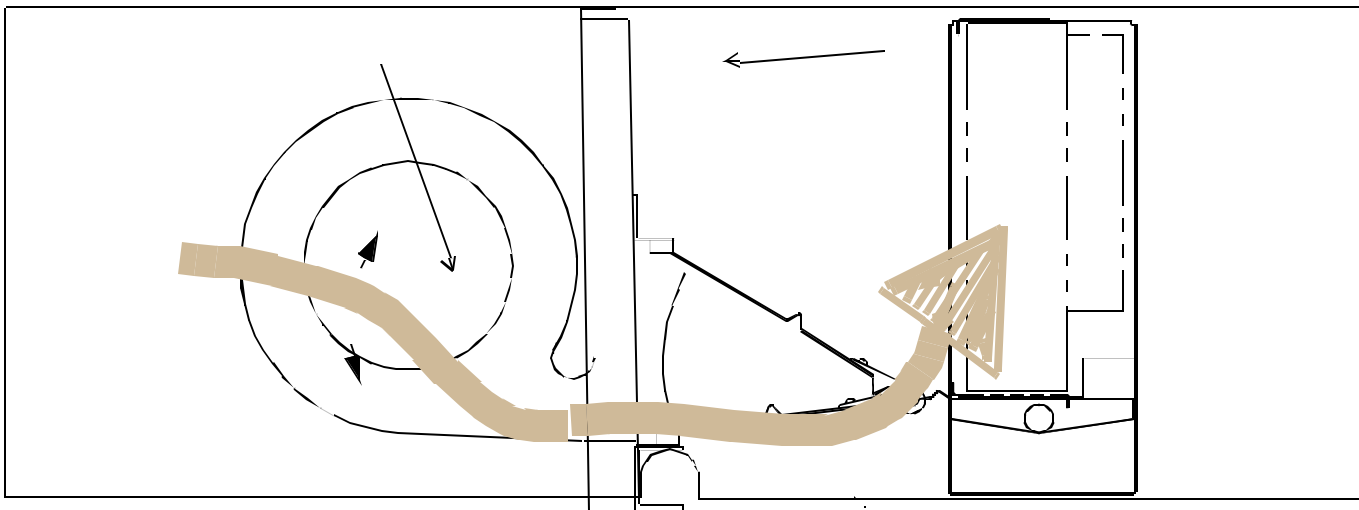

Figure 18: Horizontal unit with face-and-bypass damper option.



# Unit Operation

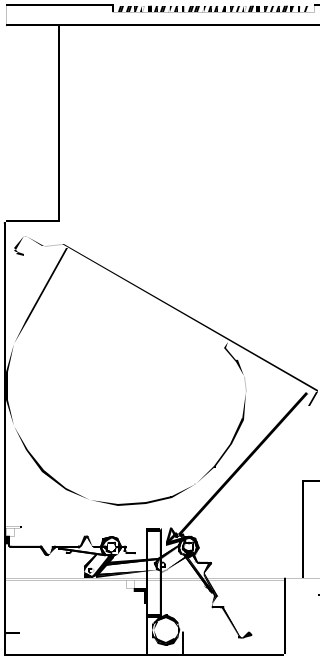

Figure 19: Vertical unit with face-and-bypass damper operations

Upon power-up, the controller calibrates the face-and-bypass damper to the full bypass position by overdriving the damper actuator. During normal operation, whenever the Tracer ZN.520 controller generates a face-and-bypass damper position request of zero or 100%, the unit calibrates the actuator by overdriving the damper actuator 135%.

## Entering Water Temperature Sampling

Units with 4-pipe changeover and 2-pipe changeover require an entering water temperature to determine if the appropriate water temperature is present for the requested mode (heating or cooling). This temperature may be communicated in an ICS system or hardwired to the Tracer ZN.520

controller for standalone applications.

When a unit uses 2-way modulating valves, it is possible for the water near the entering water temperature sensor to migrate towards ambient temperature. The Tracer ZN.520 controller has a water sampling feature for these applications. When the sensed water temperature is not sufficient for the requested heat/cool mode (5°F above the zone temperature for heating or 5°F below the zone temperature for cooling), the controller drives the valve fully open. The controller then monitors the water temperature until the appropriate temperature is sensed or until the three minute time limit expires. If the water temperature is acceptable for the requested capacity, the unit continues normal operation. If the three minute timer expires and the water temperature is still unsuitable, the unit closes the valve and waits one hour before invoking the sampling feature again.

Table 22: Water assumption chart

Unit Configuration	Temperature Assumed <sup>1</sup>
2-pipe Heating valve	Hot
2-pipe cooling valve	Cold
2-pipe H/C valve with auto changeover enabled	Hot
2-pipe H/C valve with auto changeover disabled	Cold

1. Assumption based on absence of a valid entering water temperature

## Modulating Outdoor Air Operation

The Tracer ZN.520 controller operates a modulating (3-wire floating) outdoor air damper actuator according to the effective occupancy, outdoor air temperature, space temperature, effective setpoint, discharge air temperature, and discharge air temperature set-

point. Default minimum damper positions are provided and can be changed for occupied and occupied standby modes, or for low speed operation. The controller can also receive a communicated outdoor air damper minimum position from Tracer Summit. A communicated minimum position from Tracer Summit has priority over all configured setpoints.

During the *OCCUPIED* mode the outdoor air damper will always be controlled to the effective minimum position unless ASHRAE Cycle I, ASHRAE Cycle II, or economizing modes are active.

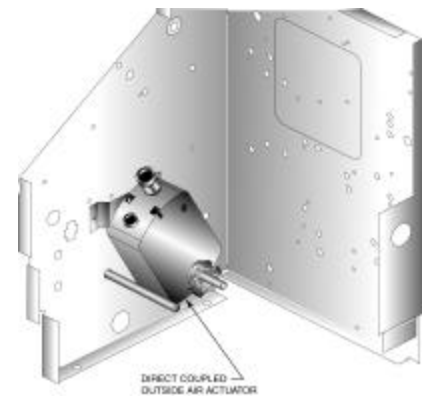

Figure 20: OA/RA actuator mounting for the vertical unit ventilator



Figure 21: Figure 2: OA/RA actuator mounting for the horizontal unit ventilator

# Unit Operation

## Automatic Outdoor Air Damper Adjustment

The Tracer ZN.520 controller is capable of using different minimum outdoor air damper positions for high and low fan speeds, which are configurable. This allows the ventilation rate to be maintained when switching between fan speeds.

*Note: The typical reduction in airflow between high and low fan speeds is 25%, however, if precise control is desired, an air balancer should be consulted.*

## Economizer Operation

*Note: When there is a request for 0% or 100% actuator position, the actuator will overdrive the actuator 135% to help maintain calibration.*

With a valid outdoor air temperature (hardwired or communicated), Tracer ZN.520 uses the modulating economizer damper as the highest priority source of cooling.

The controller initiates the economizer function if the outdoor air temperature is cold enough to be used for free cooling capacity. If the outdoor air temperature is less than the economizer enable setpoint (absolute dry bulb), the controller modulates the outdoor air damper between the minimum position and 100% to control the amount of cooling capacity. When the outdoor air temperature rises 5°F above the economizer enable setpoint, the outdoor air damper returns to its minimum position and mechanical cooling is initiated.

## ASHRAE Cycle I

ASHRAE Cycle I admits 100% outdoor air except during the warm up cycle or the unoccupied mode. To set up the Tracer ZN.520 controller for ASHRAE Cycle I conformance, set the occupied outdoor air damper minimum position to 100%.

## ASHRAE Cycle II

The Tracer ZN.520 controller conforms to ASHRAE Cycle II by allowing the modulating outdoor air damper to maintain a minimum position during the occupied mode unless economizing is enabled or the space temperature falls more than 3°F below the effective setpoint.

If the space temperature falls more than 2°F below the setpoint, the outdoor air damper will begin to close. When the space temperature hits 3°F below the setpoint, the outdoor air damper is completely closed.

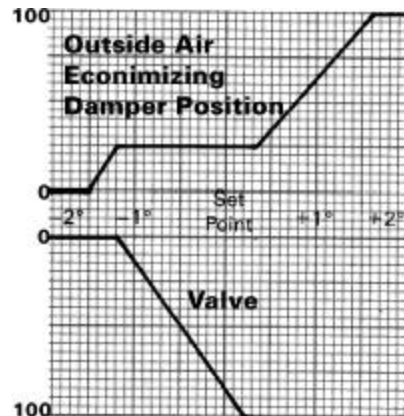

Figure 22: ASHRAE cycle 2

## DX Operation

Tracer ZN.520 supports direct expansion (DX) compressor operation for cooling only.

The controller does not allow both the DX compressor and economizer to operate at the same time. This prevents problems where the entering air temperature is too low for the evaporator coil to operate as designed.

Tracer ZN.520 also includes a fixed minimum on/off time of 3 minutes for compressor operation to prevent short cycling of the compressor.

## Electric Heat Operation

The Tracer ZN.520 controller supports 1 or 2 stages of electric heat control.

To control space temperature, electric heat is cycled to control the discharge air temperature. The rate of cycling is dependent on the load in the space and the temperature of the incoming fresh air.

## Baseboard Heat Operation

The Tracer ZN.520 controller can be configured to support one stage of baseboard heat. A 2 position valve or an electric heat contactor will be energized at 2.5°F below the effective heating setpoint. The baseboard heat is de-energized at 1°F below the effective heating setpoint.

The unit will provide heating capacity as required regardless of the presence of baseboard heat. If the unit can not maintain the space temperature, the baseboard heat will come on as a secondary stage.

If baseboard heat is to be used as the primary source of heating, the discharge air high limit should be set to a moderate temperature. This will allow the ventilation air to be tempered and avoid a "drafty" feeling. The baseboard heat will then operate as the heating capacity for the space.

In the *UNOCCUPIED* mode, the baseboard heat and unit heating capacity are brought on simultaneously as needed to maintain the unoccupied setpoint.

## Exhaust Fan Operation

The exhaust fan is coordinated with the unit fan and outdoor air damper operation. The exhaust fan output is energized only when the unit fan is operating and the outdoor air damper position is greater

# Unit Operation

than or equal to the configurable exhaust enable setpoint. This is useful for exhaust fans designed to offset the added economizer ventilation.

The exhaust fan is disabled when the outdoor air damper position drops 10% below the exhaust enable point. If the exhaust fan enable setpoint is less than 10%, the Tracer ZN.520 controller energizes the exhaust fan at the enable point and disables it when the outdoor air damper closes.

## Output Overrides

### Manual Output Test

Manual output test allows the binary outputs to be energized in a predefined sequence. (*For more information see, Manual Output Test, on page 48 for more information.*)

### Water Valve Override

To enable quicker water balancing, the controller allows a user to specify the desired state of all water valves. The values supported are:

- Open all valves
- Close all valves

The valves in the system will remain open for two hours or until normal operation is resumed.

The Tracer Summit or the Rover service tool is required to access this feature.

## Fan Status

There are two ways to do fan status monitoring:

1. The status of the fan is reported based on the state of the binary output(s) dedicated to fan control. The fan status is reported as HIGH or LOW whenever the corresponding binary output is directed ON.

The fan status is reported as OFF when none of the fan outputs are directed ON.

2. The Tracer ZN.520 controller has a binary input available for a fan status device (current sensing relay or differential pressure switch) which can provide feedback of fan operation. If the device does not indicate fan operation after 1 minute, a unit shutdown is initiated, and the unit is latched OFF.

## Filter Status/ Maintenance Timer

The unit filter status/maintenance timer is based on the cumulative run hours of the unit fan. The controller compares the fan run time against an adjustable fan run hour limit and recommends unit maintenance as required.

The Rover service tool is used to edit the maintenance required setpoint time. Once the setpoint limit is exceeded, the controller generates a MAINTENANCE REQUIRED informational diagnostic. When the maintenance required setpoint time is set to zero, the controller disables this feature.

You can use the Trace Summit or the Rover service tool to clear the MAINTENANCE REQUIRED informational diagnostic. Once the diagnostic is cleared, the controller resets the fan run time to zero and begins accumulating fan run hours again.

*Note: If at any time the unit loses power, the timer is reset to zero.*

## Other Modes

### DEHUMIDIFICATION

*Note: If the unit is in the unoccupied mode, the dehumidification routine will not operate*

Dehumidification is possible when mechanical cooling is available; the heating capacity is in the re-heat position; and the space relative humidity setpoint is valid.

The controller starts dehumidifying the space when the space humidity exceeds the humidity setpoint. The controller continues to dehumidify until the sensed humidity falls below the setpoint minus the relative humidity offset.

The controller uses the cooling and reheat coils simultaneously to dehumidify the space. When dehumidifying, the discharge air temperature is controlled to maintain the space temperature at the current setpoint.

Economizing is disabled during the dehumidification mode.

*Note: While in the dehumidification mode, if there is a call for capacity by the unit, the zone temperature setpoint will take priority over the relative humidity setpoints.*

### DEFROST

For defrost operation, a sensor is wired in series with the DX cooling relay. When a defrost condition is detected, the condensing unit is disabled, and the unit is placed in the DEFROST mode.

During DEFROST the condensing unit is OFF the outside air damper is set to the minimum positions, and the fan will continue to operate as continuous. The unit will remain in the DEFROST mode until the sensor resets at 48°F. The unit will return to NORMAL operation after the mode is discontinued.

### FREEZE AVOIDANCE

FREEZE AVOIDANCE is used as low ambient temperature protection, and is only invoked when the fan is OFF. This includes the UNOCCUPIED mode when there is no call for capacity, or any other time the fan is

# Unit Operation

OFF due to a safety or command. The controller enters the *FREEZE AVOIDANCE* mode when an outdoor air temperature is present (communicated or hardwired) and it is below the freeze avoidance setpoint (configurable). The controller disables freeze avoidance when the outdoor air temperature rises 3°F above the freeze avoidance setpoint.

When the controller is in the freeze avoidance mode:

- All water valves are driven open to allow water flow through the coil
- Fan is OFF
- Face-and-bypass damper (when present) is in full *BYPASS*
- DX and electric heat are OFF

### MORNING WARM-UP

The Tracer ZN.520 controller keeps the modulating outdoor air damper closed anytime during the *OCCUPIED* mode when the space temperature is 3°F or more below the heating setpoint.

The damper remains closed indefinitely during morning warm-up until the space temperature is within 2°F of the effective heating setpoint. The unit runs at full capacity until setpoint is met.

### COOL-DOWN

The Tracer ZN.520 controller keeps the modulating outdoor air damper closed for up to one hour at every transition from *UNOCCUPIED* to *OCCUPIED* mode when the space temperature is 3°F or more above the cooling setpoint.

The damper remains closed during cool-down until the space temperature is within 2°F of the effective cooling setpoint. The unit runs at full capacity until setpoint is met.

### Data Sharing—LonWorks

Tracer ZN.520 allows peer-to-peer data communication through the use of LonWork's technology. Data such as space temperature setpoint, occupancy, etc. can be shared from a master controller to

a peer controller over a twisted pair of communication wire with or without the presence of a front end building management system. (See Figure 23: "Simple data sharing application") This ability allows units to operate with the same data to prevent conflicting control.

Data sharing is established through the use of "bindings". Bindings are set up through the Rover service tool.

The Tracer ZN.520 controller includes a network variable for master/slave operation. This variable includes all of the information required for the slave units to operate with master controller. (See Figure 24: "More complex data sharing application")

For more information on establishing bindings, see the Rover service tool manual. For a complete listing on shared points see "Appendix—Data Lists" on page64.

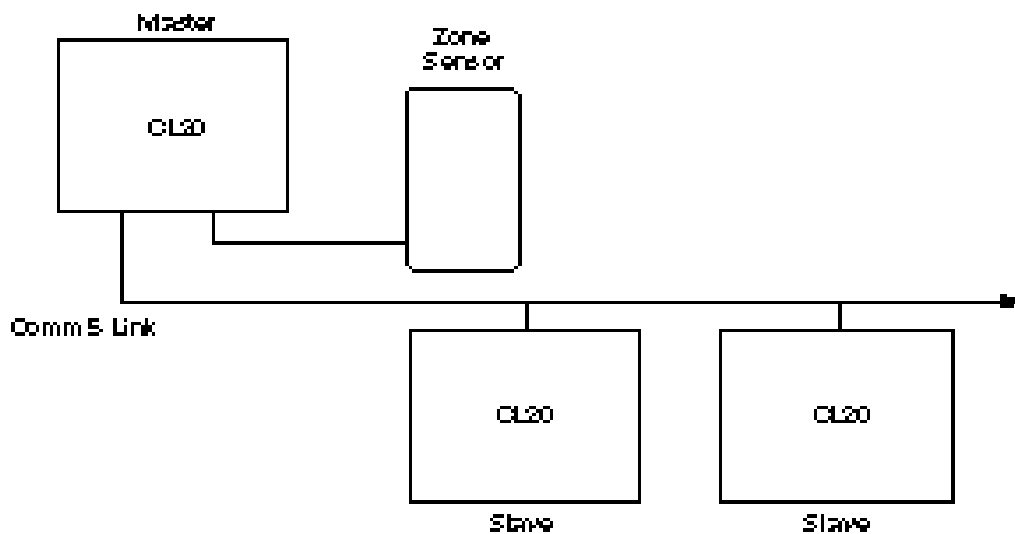

Figure 23: Simple data sharing application

# Unit Operation

---

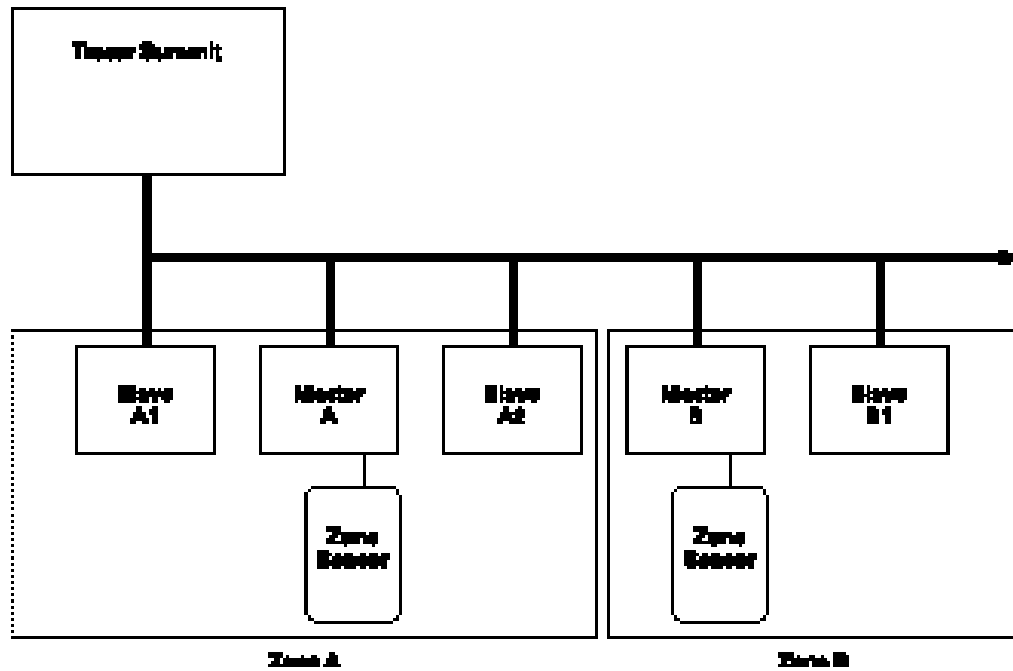

Figure 24: More complex data sharing application

# Troubleshooting

**Important! When viewing the Tracer ZN.520 through the Rover service tool, it is important that the version be up-to-date. To help ensure that your version is the most recent, contact your local Trane sales representative or service center.**

## Led Operation

### Red Service LED

**Table 23: Red service LED activity**

Red LED activity	Description
LED is OFF continuously after power is applied to the controller.	Normal operation.
LED is ON continuously, even when power is first applied to the controller.	Someone is pressing the Service push button or the controller has failed.
LED flashes about once every second.	Un-install (normal controller mode). Use Rover service tool to restore the unit to normal operation. Refer to the Rover product literature for more information.

### Black Service Push Button

**Note: If the Service push button is held down for more than 15 seconds, the Tracer™ ZN.520 Unit Controller will un-install itself from the ICS communication network and shut down all unit operation. This mode is indicated by the red Service LED flashing once every second. See the Red Service LED section. Use Rover service tool to restore the unit to normal operation.**

The Service push button, located at the bottom center of the controller, can be used to install the Tracer™ ZN.520 Unit Controller in a communication network. Refer to the Rover and Tracer Summit product literature for more information.

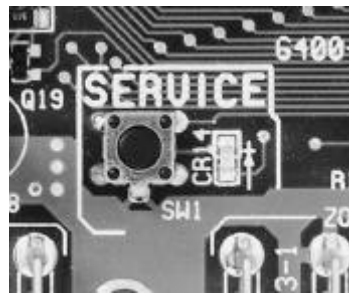

Figure 25: Black service button

### Green Status LED

The green LED normally indicates whether or not the controller is powered on (24 VAC).

**Table 24: Green status LED activity**

Green LED activity	Description
LED is ON continuously.	Power ON (normal operation).
LED blinks (1 blink per second).	The controller is in manual output test mode. No diagnostics present.
LED blinks (2 blinks per second).	The controller is in manual output test mode. One or more diagnostics are present.
LED blinks (1/4 second on, 1/4 second off for 10 seconds).	Wink mode.
LED OFF.	Power is off. Controller failure. Test button is pressed.

### Yellow Comm LED

The yellow Comm LED blinks at the rate the controller receives communication. The yellow LED does not blink when the controller is transmitting communication data.

**Table 25: Yellow comm LED activity**

Yellow LED activity	Description
LED OFF continuously.	The controller is not detecting any communication. (Normal for standalone applications.)
LED blinks or flickers.	The controller detects communication. (Normal for communicating applications, including data sharing.)
LED ON continuously.	Abnormal condition or extremely high traffic on the link.

## Manual Output Test

The test sequence verifies output and end device operation. The manual output test can be conducted to verify output wiring and actuator operation, without using the Rover service tool, by pressing the test button.



Figure 26: Blue test button

Many service calls are initiated due to unit diagnostics, so the test sequence attempts to clear unit diagnostics and restore normal unit operation prior to testing the outputs. If the diagnostics remain after an attempt to clear diagnostics, the status LED lights in a two-blink pattern, indicating the diagnostic condition is still present.

# Troubleshooting

If a two-blink pattern remains after an attempt to clear diagnostics, the diagnostic condition is still present and may affect the manual output test. The diagnostic must then be cleared using another method. (See "Resetting Diagnostics" on page 54 for more information.)

## Test Procedure

The procedure for testing is:

1. Press and hold the Test button for at least two seconds, then

release the button to start the test mode.

2. When manual output test mode begins, the controller turns off all outputs and calibrates modulating end devices closed.
3. Press the Test button once to advance through the test sequence.

**Note: To help ensure accurate testing do not press the test button more than once per second.**

Alternatively, the manual output test can be controlled over the communications network by using Rover.

When conducting the manual output test via communications network, the sequence must start with Step 1 (OFF), as shown in Table 26: Test sequence for non face-and-bypass unit configurations and Table 27: Test sequence for face-and-bypass unit configurations. However, subsequent steps may be conducted in any order.

**Table 26: Test sequence for non face-and-bypass unit configurations**

Step	Fan			DX, or cool or heat/cool changeover valve		Face-and-bypass damper		Electric heat, or heat valve		Outdoor air damper		Generic/baseboard heat
	J1-1	J1-2	J1-3	J1-5	J1-6	J1-7	J1-8	J1-9	J1-10	J1-11	J1-12	TB4-1
1: Off <sup>1</sup>	Off	Off	Off	Off	On	NA	NA	Off	Hydronic: on EH: off	Off	On	Off
2: Fan high <sup>2</sup>	High	Off	Off	Off	Off	NA	NA	Off	Off	Off	Off	Off
3: Fan med <sup>3</sup>	Off	Med	Off	Off	Off	NA	NA	Off	Off	Off	Off	Off
4: Fan low <sup>4</sup>	Off	Off	Low	Off	Off	NA	NA	Off	Off	Off	Off	Off
5: Main open, DX on	High	Off	Off	On	Off	NA	NA	Off	Off	Off	Off	Off
6: Main close, DX off, aux open, EH1 on	High	Off	Off	Off	On	NA	NA	On	Off	Off	Off	Off
7: Aux open, EH1 on, exhaust fan <sup>5</sup>	High	Exh	Off	Off	Off	NA	NA	On	Off	Off	Off	Off
8: Aux close, EH1 off, EH2 on, damper open	High	Off	Off	Off	Off	NA	NA	Off	On	On	Off	Off
9: Damper close	High	Off	Off	Off	Off	NA	NA	Off	Off	Off	On	Off
10: Generic / baseboard heat energized	High	Off	Off	Off	Off	NA	NA	Off	Off	Off	Off	On
11: Exit <sup>6</sup>	Exit											

1. Upon entering manual output test mode, the controller turns off all fan, DX, and electric heat outputs and drives all dampers and valves closed (if required).

2. At the beginning of step 2, the controller attempts to clear all diagnostics.

3. If the unit is configured for a 3-speed fan, the medium fan speed output will energize at step 3. If the unit is configured for a 2-speed fan, the fan remains on high speed at step 3.

4. If the unit is configured for a 3-speed fan, the medium fan speed output energizes at step 3. If the unit is configured for a 2-speed fan, the low fan speed output energizes at step 3. If the unit is configured for a 1-speed fan, the fan remains on high speed at step 3.

5. If the unit is configured for a 1- or 2-speed fan, the exhaust fan output energizes on step 7. The exhaust fan output is shared with medium fan speed.

6. After step 10, the test sequence performs an exit. This initiates a reset and attempts to return the controller to normal operation.

# Troubleshooting

**Table 27: Test sequence for face-and-bypass unit configurations**

Step	Fan			DX, or cool or heat/ cool changeover valve		Face-and- bypass damper		Electric heat, or heat valve		Outdoor air damper		Generic/ baseboard heat
	J1-1	J1-2	J1-3	J1-5	J1-6	J1-7	J1-8	J1-9	J1-10	J1-11	J1-12	TB4-1
<b>1:</b> Off <sup>1</sup>	Off	Off	Off	Off	NA	Off	On	Off	NA	Off	On	Off
<b>2:</b> Fan high <sup>2</sup>	High	Off	Off	Off	NA	On	Off	Off	NA	Off	Off	Off
<b>3:</b> Fan med <sup>3</sup>	Off	Med	Off	Off	NA	On	Off	Off	NA	Off	Off	Off
<b>4:</b> Fan low <sup>4</sup>	Off	Off	Low	Off	NA	On	Off	Off	NA	Off	Off	Off
<b>5:</b> Main open, DX on	High	Off	Off	On	NA	On	Off	Off	NA	Off	Off	Off
<b>6:</b> Main close, DX off, aux open	High	Off	Off	Off	NA	On	Off	On	NA	Off	Off	Off
<b>7:</b> Aux open, exhaust fan <sup>5</sup>	High	Exh	Off	Off	NA	On	Off	On	NA	Off	Off	Off
<b>8:</b> Aux close, damper open	High	Off	Off	Off	NA	Off	On	Off	NA	On	Off	Off
<b>9:</b> Outdoor air damper close	High	Off	Off	Off	NA	Off	On	Off	NA	Off	On	Off
<b>10:</b> Generic / baseboard heat energized	High	Off	Off	Off	NA	Off	On	Off	NA	Off	Off	On
<b>11:</b> Exit <sup>6</sup>	Exit											

1. Upon entering manual output test mode, the controller turns off all fan outputs and drives all dampers and valves closed (if required).
2. At the beginning of step 2, the controller attempts to clear all diagnostics.
3. If the unit is configured for a 2-speed fan, the fan remains on high speed at step 3.
4. If the unit is configured for a 2-speed fan, the low fan speed output energizes at step 3. If the unit is configured for a 1-speed fan, the fan remains on high speed at step 3.
5. If the unit is configured for a 1- or 2-speed fan, the exhaust fan output energizes on step 7. The exhaust fan output is shared with medium fan speed.
6. After step 10, the test sequence performs an exit. This initiates a reset and attempts to return the controller to normal operation.



# Troubleshooting

## Safeties

### Freeze Protection

The Tracer ZN.520 controller has two methods of freeze protection.

1. An optional binary freeze stat that is wired to a binary input. The freeze stat is a capillary tube type and is factory set to 35 °F. When this device opens, a “Low Coil Temp Detect” diagnostic is generated.
2. Using the discharge air temperature sensor, if the discharge air temperature falls below the discharge air low limit, the controller increases the heating capacity to temper the air. If the discharge air temperature remains below the discharge air low limit for 3 minutes, the controller generates a “Low Coil Temp Detect” diagnostic.

### Fan Failure

A “Low Air Flow—Fan Failure” diagnostic is generated when a fan status device is present and fails to close after 1 minute of unit start-up or when it opens for more than 1 minute during normal unit operation.

### Space Temperature Failure

If the Tracer ZN.520 has validated a space temperature input and then the input becomes invalid, a space temperature failure diagnostic occurs.

### Entering Water Temperature Failure

If the Tracer ZN.520 has validated an entering water temperature input and then the input becomes invalid, an entering water temperature failure diagnostic occurs.

### Discharge Air Temperature Limit

When the discharge air exceeds the high or low limit setpoint and the unit can not correct it by altering capacity, a “Discharge Air Temp Limit” diagnostic is generated.

### Outdoor Air Temperature Failure

If the Tracer ZN.520 has validated an outdoor air temperature input and then the input becomes invalid, an outdoor air temperature failure diagnostic occurs.

### Humidity Input Failure

If the Tracer ZN.520 has validated a relative humidity input and then the input becomes invalid, a humidity input failure diagnostic occurs.

### CO<sub>2</sub> Sensor Failure

If the Tracer ZN.520 has validated a CO<sub>2</sub> input and then the input becomes invalid, a CO<sub>2</sub> input failure diagnostic occurs.

### Generic AIP Failure

If the Tracer ZN.520 has validated a generic analog input and then the input becomes invalid, a generic analog input failure diagnostic occurs.

### Defrosting-Compressor Lockout

The defrost stat used with Tracer ZN.520 on DX units is wired in series with the condensing unit. When it opens to indicate a frost condition, the Tracer ZN.520 senses the open circuit and de-energizes the condensing unit output. A defrosting diagnostic is generated at this point.

## Maintenance Required

**Note: If power to the unit is cycled or discontinued for any reason, all maintenance timers are automatically reset.**

The “Maintenance Required” diagnostic is generated when the fan run-time exceeds the configurable limit. This diagnostic is useful for filter change notification.

### Local Fan Mode Failure

If the hardwired fan mode input to the Tracer ZN.520 controller is present and then becomes invalid, a local fan mode failure diagnostic is generated.

### Local Setpoint Failure

If the hardwired setpoint input to the Tracer ZN.520 controller is present and then becomes invalid, a local setpoint failure diagnostic is generated.

### Generic Temperature Failure

If the Tracer ZN.520 has validated a generic temperature input and then the input becomes invalid, a generic temperature input failure diagnostic occurs.

### Invalid Unit Configuration

If the Tracer ZN.520 has been configured improperly or loses its configuration, an invalid unit configuration diagnostic is generated. The unit must be re-configured with a valid configuration to correct this problem.

# Troubleshooting

## Diagnostics

**Table 28: Tracer™ ZN.520 Unit Controller diagnostics**

<b>Diagnostic</b>	<b>Unit Response</b>	<b>Latching/non-latching</b>	<b>Reset</b>
Low Coil Temperature Detect <sup>2</sup>	Fan— <b>OFF</b> Valves— <b>OPEN</b> Outdoor air damper— <b>CLOSED</b> Face bypass damper— <b>BYPASS</b> DX/electric heat— <b>OFF</b> Baseboard heat— <b>OFF</b>	Latching	Auto reset once within 24hrs. If safety generates a diagnostic more than once a communicated or manual reset will be necessary.
Low Air Flow - Fan Failure <sup>2</sup>	Fan— <b>OFF</b> Valves— <b>CLOSED</b> Outdoor air damper— <b>CLOSED</b> Face bypass damper— <b>BYPASS</b> DX/electric heat— <b>OFF</b> Baseboard heat— <b>OFF</b>	Latching	Communicated or manual reset
Space Temperature Failure <sup>4</sup>	Fan— <b>OFF</b> Valves— <b>CLOSED</b> Outdoor air damper— <b>CLOSED</b> Face bypass damper— <b>BYPASS</b> DX/electric heat— <b>OFF</b> Baseboard heat— <b>OFF</b>	Non-latching	Communicated or manual reset
Entering Water Temp Failure <sup>4</sup>	Fan— <b>ENABLED</b> Valves— <b>ENABLED</b> <sup>3</sup> Outdoor air damper— <b>ENABLED</b> <sup>3</sup> Face bypass damper— <b>ENABLED</b> <sup>3</sup> DX/electric heat— <b>ENABLED</b> <sup>3</sup> Baseboard heat— <b>OFF</b>	Non-latching	Communicated or manual reset
Discharge Air Temp Limit <sup>2</sup>	Fan— <b>OFF</b> Valves— <b>OPEN</b> Outdoor air damper— <b>CLOSED</b> Face bypass damper— <b>BYPASS</b> DX/electric heat— <b>OFF</b> Baseboard heat— <b>OFF</b>	Latching	Auto reset once within 24hrs. If safety generates a diagnostic more than once a communicated or manual reset will be necessary.
Discharge Air Temp Failure <sup>4</sup>	Fan— <b>OFF</b> Valves— <b>CLOSED</b> Outdoor air damper— <b>CLOSED</b> Face bypass damper— <b>BYPASS</b> DX/electric heat— <b>OFF</b> Baseboard heat— <b>OFF</b>	Non-latching	Communicated or manual reset
Outdoor Air Temp Failure <sup>4</sup>	Fan— <b>ENABLED</b> Valves— <b>ENABLED</b> Outdoor air damper— <b>MINIMUM POSITION</b> <sup>5</sup> Face bypass damper— <b>ENABLED</b> DX/electric heat— <b>ENABLED</b> Baseboard heat— <b>ENABLED</b>	Non-latching	Communicated or manual reset

# Troubleshooting

**Table 28: Tracer™ ZN.520 Unit Controller diagnostics**

<b>Diagnostic</b>	<b>Unit Response</b>	<b>Latching/non-latching</b>	<b>Reset</b>
<i>Humidity Input Failure<sup>d</sup></i>	<i>Fan—ENABLED Valves—ENABLED Outdoor air damper—ENABLED Face bypass damper—ENABLED DX/electric heat—ENABLED Baseboard heat—ENABLED</i>	<i>Non-latching</i>	<i>Communicated or manual reset</i>
<i>CO<sub>2</sub> Sensor Failure<sup>d</sup></i>	<i>Fan—ENABLED Valves—ENABLED Outdoor air damper—ENABLED Face bypass damper—ENABLED DX/electric heat—ENABLED Baseboard heat—ENABLED</i>	<i>Non-latching</i>	<i>Communicated or manual reset</i>
<i>Generic AIP Failure<sup>d</sup></i>	<i>Fan—ENABLED Valves—ENABLED Outdoor air damper—ENABLED Face bypass damper—ENABLED DX/electric heat—ENABLED Baseboard heat—ENABLED</i>	<i>Non-latching</i>	<i>Communicated or manual reset</i>
<i>Defrosting - Cmpr Lockout<sup>d</sup></i>	<i>Fan—ENABLED Valves—ENABLED Outdoor air damper—ENABLED Face bypass damper—ENABLED DX/electric heat—OFF Baseboard heat—ENABLED</i>	<i>Non-latching</i>	<i>Communicated or manual reset</i>
<i>Maintenance Required</i>	<i>Fan—ENABLED Valves—ENABLED Outdoor air damper—ENABLED Face bypass damper—ENABLED DX/electric heat—ENABLED Baseboard heat—ENABLED</i>	<i>Non-latching</i>	<i>Communicated or manual reset</i>
<i>Local Fan Mode Failure<sup>d</sup></i>	<i>Fan—ENABLED Valves—ENABLED Outdoor air damper—ENABLED Face bypass damper—ENABLED DX/Electric Heat—ENABLED Baseboard heat—ENABLED</i>	<i>Non-latching</i>	<i>Communicated or manual reset</i>
<i>Local Setpoint Failure<sup>d</sup></i>	<i>Fan—ENABLED Valves—ENABLED Outdoor air damper—ENABLED Face bypass damper—ENABLED DX/electric heat—ENABLED Baseboard heat—ENABLED</i>	<i>Non-latching</i>	<i>Communicated or manual reset</i>
<i>Generic Temperature Failure</i>	<i>Fan—ENABLED Valves—ENABLED Outdoor air damper—ENABLED Face bypass damper—ENABLED DX/electric heat—ENABLED Baseboard heat—ENABLED</i>	<i>Non-latching</i>	<i>Communicated or manual reset</i>

# Troubleshooting

**Table 28: Tracer™ ZN.520 Unit Controller diagnostics**

Diagnostic	Unit Response	Latching/non-latching	Reset
Invalid Unit Configuration <sup>2</sup>	Fan— <b>DISABLED</b> Valves— <b>DISABLED</b> Outdoor air damper— <b>DISABLED</b> Face bypass damper— <b>DISABLED</b> DX/electric heat— <b>DISABLED</b> Baseboard heat— <b>DISABLED</b>	Non-latching	Communicated or manual reset
Normal	Fans— <b>ENABLED</b> Valves— <b>ENABLED</b> Outdoor air damper— <b>ENABLED</b> Face bypass damper— <b>ENABLED</b> DX/electric heat— <b>ENABLED</b> Baseboard heat— <b>ENABLED</b>	Non-latching	Communicated or manual reset

Note<sup>1</sup>: The generic binary output (TB4-1, TB4-2) state is unaffected by all unit diagnostics.

Note<sup>2</sup>: During manual output test, these diagnostics make the green status LED light in a two-blink pattern. For more information see, Manual Output Test, on page 48 for more information.)

Note<sup>3</sup>: When the entering water temperature is required but not present, the Tracer™ ZN.520 Unit Controller generates a diagnostic to indicate the sensor loss condition. The controller automatically clears the diagnostic once a valid entering water temperature value is present (non-latching diagnostic). When the entering water temperature sensor fails, the controller prohibits all hydronic cooling operation, but allows the delivery of heat when heating is required. In the **cool** mode, all hydronic cooling is locked-out, but normal fan and outdoor air damper operation is permitted.

Note<sup>4</sup>: These diagnostics are non-latching and automatically reset when the input is present and valid.

Note<sup>5</sup>: When the outdoor air temperature sensor has failed or is not present, the Tracer™ ZN.520 Unit Controller generates a diagnostic to indicate the sensor loss condition. The controller automatically clears the diagnostic once a valid outdoor air temperature value is present (non-latching diagnostic). When the outdoor air temperature sensor fails or is not present, the controller prohibits economizer operation. A value of Enable or Disable for **nviEconEnable** overrides these decisions, regardless of the presence of an outdoor air temperature value or failure. For more information see, Interoperability, on page 12 for more information.) For more information see, Data Sharing—LonWorks, on page 46 for more information.)

## Translating Multiple Diagnostics

The controller senses and records each diagnostic independently of other diagnostics. It is possible to have multiple diagnostics present simultaneously. The diagnostics are reported in the order they occur.

## Resetting Diagnostics

There are many ways to reset unit diagnostics:

- Automatically by the controller
- By initiating a manual output test at the controller
- By cycling power to the controller
- By using a building automation system
- By using the Rover service tool

- By cycling the fan switch from off to any speed setting

### Automatically

The Tracer™ ZN.520 Unit Controller includes an automatic diagnostic reset function. This function attempts to automatically recover a unit when the Low Coil Temperature Detection diagnostic occurs. When this diagnostic occurs, the controller responds as defined in Table 28: Tracer™ ZN.520 Unit Controller diagnostics.

After the controller detects the Low Coil Temperature Detection diagnostic, the unit waits 30 minutes before invoking the automatic diagnostic reset function. The automatic diagnostic reset function clears the Low Coil Temperature Detection diagnostic and attempts to restore the controller to normal operation. The controller resumes normal operation until another di-

agnostic occurs.

If a Low Coil Temperature Detection diagnostic recurs within 24 hours after an automatic diagnostic reset, you must manually reset the diagnostic. See other possible methods for resetting diagnostics in this section.

### Manual output test

The **TEST** button on the controller may be used either during installation to verify proper end device operation or during troubleshooting. When depressed, the Test button, the controller exercises all outputs in a predefined sequence. The first and last steps of the sequence reset the controller diagnostics. (See "Manual Output Test" on page 48 for more information.)

### Cycling power

When turned-off, the controller's 24 VAC power, and re-applies

# Troubleshooting

power, the unit cycles through a power-up sequence and clears all timers.

By default, the controller attempts to reset all diagnostics at power-up. Diagnostics present at power-up and those that occur after power-up are handled according to the defined unit diagnostics sequences (For more information see, *Table 28: Tracer™ ZN.520 Unit Controller diagnostics, on page 52 for more information.*).

### Building automation system

Some building automation sys-

tems (i.e., Tracer Summit building automation system) can reset diagnostics in the Tracer™ ZN.520 unit controller. For more complete information, refer to the product literature for the building automation system.

### Rover service tool

Rover service tool can reset diagnostics in the Tracer™ ZN.520 unit controller. For more complete information, refer to the Rover Installation, Operation, and Programming manual.

### Diagnostic reset

Any device that can communicate the network variable nviRequest (enumeration “clear\_alarm”) can reset diagnostics in the Tracer™ ZN.520 unit controller. The controller also attempts to reset diagnostics whenever power is cycled.

### Cycling the fan switch

If the user cycles the fan speed switch from OFF to any speed, the controller resets all diagnostics. Diagnostics may recur immediately if the problem still exists.

## Questionable unit operation

### Fans

**Table 29: Fan outputs do not energize**

<b>Probable cause</b>	<b>Possible Explanation</b>
Unit wiring	The wiring between the controller outputs and the fan relays and contacts must be present and correct for normal fan operation.
No power to the controller	If the controller does not have power, the unit fan does not operate. For the Tracer™ ZN.520 Unit Controller to operate normally, it must have an input voltage of 24 VAC. When the green LED is off continuously, the controller does not have sufficient power or has failed.
Unit configuration	The controller must be properly configured based on the actual installed end devices and application. When the unit configuration does not match the actual end devices, the fans may not work correctly.
Random-start observed	After power-up, the controller always observes a random-start from 5 to 30 seconds. The controller remains off until the random-start time expires.
Power-up control wait	When power-up control wait is enabled (non-zero time), the controller remains off until one of two conditions occurs: <ol style="list-style-type: none"> <li>1. The controller exits power-up control wait once it receives communicated information.</li> <li>2. The controller exits power-up control wait once the power-up control wait time expires.</li> </ol>
Diagnostic present	A specific list of diagnostics affects fan operation. For more information see, <i>Tracer™ ZN.520 Unit Controller diagnostics, on page 52 for more information.</i> )
Manual output test	The controller includes a manual output test sequence you can use to verify output operation and associated output wiring. However, based on the current step in the test sequence, the unit fan may not be on. For more information see, <i>Manual Output Test, on page 48 for more information.</i> )
Fan mode OFF	When a local fan mode switch (provided on the Trane zone sensor) determines the fan operation, the off position controls the unit OFF.
Requested mode OFF	You can communicate a desired operating mode (such as OFF, HEAT, and COOL) to the controller. When OFF is communicated to the controller, the unit controls the fan OFF. There is no heating or cooling.
UNOCCUPIED operation	When the controller is in the UNOCCUPIED mode, the fan is cycled.
Cycling fan operation/continuous	The controller operates the fan continuously when in the OCCUPIED, OCCUPIED STANDBY, or OCCUPIED BYPASS mode. When the controller is in the unoccupied mode, the fan is cycled between HIGH speed and OFF with capacity.

# Troubleshooting

## Valves

**Table 30: Valves stay closed**

<b>Probable cause</b>	<b>Possible Explanation</b>
Unit wiring	The wiring between the controller outputs and the valve(s) must be present and correct for normal valve operation.
Random-start observed	After power-up, the controller always observes a random-start from 5 to 30 seconds. The controller remains off until the random-start time expires.
Unit configuration	The controller must be properly configured based on the actual installed end devices and application. When the unit configuration does not match the actual end devices, the valves may not work correctly.
Power-up control wait	When power-up control wait is enabled (non-zero time), the controller remains off until one of two conditions occurs: The controller exits power-up control wait once it receives communicated information. The controller exits power-up control wait once the power-up control wait time expires.
Diagnostic present	A specific list of diagnostic affects valve operation. For more information see, Tracer™ ZN.520 Unit Controller diagnostics, on page 52 for more information.)
Manual output test	The controller includes a manual output test sequence you can use to verify output operation and associated output wiring. However, based on the current step in the test sequence, the valve(s) may not be open. For more information see, Manual Output Test, on page 48 for more information.)
Fan mode off	When a local fan mode switch (provided on the Trane zone sensor) determines the fan operation, the off position controls the unit off and valves to close.
Requested mode off	You can communicate a desired operating mode (such as OFF, HEAT, and COOL) to the controller. When OFF is communicated to the controller, the unit controls the fan OFF. There is no heating or cooling (valves are closed).
Sampling logic	The controller includes entering water temperature sampling logic which is automatically invoked during 2-pipe and 4-pipe changeover when the entering water temperature is either too cool or too hot for the desired heating or cooling. For more information see, Entering Water Temperature Sampling, on page 43 for more information.) Example: A 2-pipe heat/cool changeover unit will not cool if the entering water temperature is too warm for cooling or if the entering water sensor is not present. The unit will not heat if the entering water temperature is too cool for heating. If failed the controller will close valve for one hour then reattempt sampling routine.

**Table 31: Valves stay open**

<b>Probable cause</b>	<b>Possible Explanation</b>
Unit wiring	The wiring between the controller outputs and the valve(s) must be present and correct for normal valve operation.
Unit configuration	The controller must be properly configured based on the actual installed end devices and application. When the unit configuration does not match the actual end devices, the valves may not work correctly.
Diagnostic present	A specific list of diagnostic affects valve operation. For more information see, Tracer™ ZN.520 Unit Controller diagnostics, on page 52 for more information.)
Manual output test	The controller includes a manual output test sequence you can use to verify output operation and associated output wiring. However, based on the current step in the test sequence, the valve(s) may be open. For more information see, Manual Output Test, on page 48 for more information.)
Sampling logic	The controller includes entering water temperature sampling logic which automatically invoked during 2-pipe and 4-pipe changeover when the entering water temperature is either too cool or too hot for the desired heating or cooling. For more information see, Entering Water Temperature Sampling, on page 43 for more information.)

# Troubleshooting

**Table 31: Valves stay open**

<b>Probable cause</b>	<b>Possible Explanation</b>
Freeze avoidance	When the fan is off with no demand for capacity (0%) and the outdoor air temperature is below the freeze avoidance setpoint, the controller opens the water valves (100%) to prevent coil freezing. This includes unoccupied mode when there is no call for capacity or any other time the fan is off.
Normal operation	The controller opens and closes the valves to meet the unit capacity requirements.

## DX/Electric Heat

**Table 32: DX or electric output(s) does not energize**

<b>Probable cause</b>	<b>Possible Explanation</b>
Unit wiring	The wiring between the controller outputs and the end devices must be present and correct for normal operation.
Unit configuration	The controller must be properly configured based on the actual installed end devices and application. When the unit configuration does not match the actual end devices, the unit may not work correctly.
Diagnostic present	A specific list of diagnostics affect compressor and electric heat operation. For more information see, Tracer™ ZN.520 Unit Controller diagnostics, on page 52 for more information.)
Manual output test	The controller includes a manual output test sequence you can use to verify output operation and associated output wiring. However, based on the current step in the test sequence, the DX or electric outputs may be OFF. For more information see, Manual Output Test, on page 48 for more information.)
Freeze avoidance	When the fan is OFF with no demand for capacity (0%) and the outdoor air temperature is below the freeze avoidance setpoint, the controller disables compressors and electric heat outputs. This includes <b>UNOCCUPIED</b> mode when there is no call for capacity or any other time the fan is OFF.
Normal operation	The controller energizes the outputs only as needed to meet the unit capacity requirements.

## Outside Air Damper

**Table 33: Outdoor air damper stays closed**

<b>Probable cause</b>	<b>Explanation</b>
Unit wiring	The wiring between the controller outputs and the outdoor air damper must be present and correct for normal damper operation.
Unit configuration	The controller must be properly configured based on the actual installed end devices and application. When the unit configuration does not match the actual end devices, the damper may not work correctly.
Random-start observed	After power-up, the controller always observes a random-start from 5 to 30 seconds. The controller remains OFF until the random-start time expires.
Power-up control wait	When power-up control wait is enabled (non-zero time), the controller remains OFF until one of two conditions occurs: <ol style="list-style-type: none"> <li>1. The controller exits power-up control wait once it receives communicated information.</li> <li>2. The controller exits power-up control wait once the power-up control wait time expires.</li> </ol>
Diagnostic present	A specific list of diagnostics affects outdoor air operation. For more information see, Tracer™ ZN.520 Unit Controller diagnostics, on page 52 for more information.)
Manual output test	The controller includes a manual output test sequence you can use to verify output operation and associated output wiring. However, based on the current step in the test sequence, the unit damper may not be open. For more information see, Manual Output Test, on page 48 for more information.)
Fan mode OFF	When a local fan mode switch (provided on the Trane zone sensor) determines the fan operation, the OFF position controls the unit OFF and damper to close.

# Troubleshooting

**Table 33: Outdoor air damper stays closed**

<b>Probable cause</b>	<b>Explanation</b>
Requested mode OFF	You can communicate a desired operating mode (such as OFF, HEAT, and COOL) to the controller. When OFF is communicated to the controller, the unit controls the fan OFF. There is no heating or cooling (valves are closed).
Freeze avoidance	When the fan is OFF and the outdoor air temperature is below the freeze avoidance setpoint, the controller disables economizing and keeps the outdoor air damper closed. This includes <b>UNOCCUPIED</b> mode when there is no call for capacity or any other time the fan is OFF.
<b>UNOCCUPIED</b> mode	When the controller is in the <b>UNOCCUPIED</b> mode, the outdoor air damper remains closed unless economizing is enabled.
Warm up and cool-down	The controller includes both a morning warm up and cool-down sequence to keep the outdoor air damper closed during the transition from <b>UNOCCUPIED</b> to <b>OCCUPIED</b> . This is an attempt to bring the space under control as quickly as possible.
Normal operation	The controller opens and closes the outdoor air damper based on the controller's occupancy mode and fan operation. Normally, the outdoor air damper is open during OCCUPIED, OCCUPIED STANDBY, and OCCUPIED BYPASS mode when the fan is running and closed during <b>UNOCCUPIED</b> mode unless the controller is economizing. For more information see, Modulating Outdoor Air Operation, on page 43 for more information.)

**Table 34: Outdoor air damper stays open**

<b>Probable Cause</b>	<b>Explanation</b>
Unit wiring	The wiring between the controller outputs and the outdoor air damper must be present and correct for normal damper operation.
Unit configuration	The controller must be properly configured based on the actual installed end devices and application. When the unit configuration does not match the actual end devices, the damper may not work correctly.
Manual output test	The controller includes a manual output test sequence you can use to verify output operation and associated output wiring. However, based on the current step in the test sequence, the unit damper may be open. For more information see, Manual Output Test, on page 48 for more information.)
Normal operation	The controller opens and closes the outdoor air damper based on the controller's occupancy mode and fan operation. Normally, the outdoor air damper is open during <b>OCCUPIED</b> , <b>OCCUPIED STANDBY</b> , and <b>OCCUPIED BYPASS</b> mode when the fan is running and closed during <b>UNOCCUPIED</b> mode unless the controller is economizing. For more information see, Modulating Outdoor Air Operation, on page 43 for more information.)



# Replacing Circuit Boards

---

## Tracer ZN.520 Unit Controller Replacement

1. Disconnect power or disable the circuit breaker to unit.
2. Remove bad or questionable Tracer ZN.520 controller circuit board.
3. Install controller in the unit with the heat-sink placement at the top of the control box. (See page 32).
4. Connect the power to the circuit board ONLY.
5. Connect Rover and properly configure the controller, unless a previously configured board is purchased.
6. Power down.
7. Connect the remaining input and output wiring to the controller.
8. Reapply power.
9. Complete sequence 7 and 8 above in the installation section of this manual.
10. Refer to BAS manual for instructions on how to install the new ZN.520 into BAS system.



# Appendix

## Hardwired Setpoint Adjustment

Table 35: Hardwired setpoint adjustment

Resistance ( $\Omega$ )	Setpoint (Deg F)
889.4	50
733.6	58
577.9	66
500	70
422.1	74
344.2	78
266.4	82
188.5	86
110.6	90

## Fan Switch Resistance Values

Table 36: Resistance values

Resistance (W)	Switch Position
16,300	High
10,700	Low
2,320	Auto
4,870	Off

## Hardwired Thermistor Values

Table 37: Hardwired 10k $\Omega$  thermistor values

Resistance	Temperature	Resistance	Temperature
87.5k $\Omega$	0°F	10.0k $\Omega$	77°F
74.6k $\Omega$	5°F	9.3k $\Omega$	80°F
63.8k $\Omega$	10°F	8.2k $\Omega$	85°F
54.6k $\Omega$	15°F	7.3k $\Omega$	90°F
46.9k $\Omega$	20°F	6.5k $\Omega$	95°F
40.4k $\Omega$	25°F	5.8k $\Omega$	100°F
34.8k $\Omega$	30°F	5.2k $\Omega$	105°F
30.2k $\Omega$	35°F	4.7k $\Omega$	110°F
26.2k $\Omega$	40°F	4.2k $\Omega$	115°F
22.8k $\Omega$	45°F	3.8k $\Omega$	120°F
20.0k $\Omega$	50°F	3.4k $\Omega$	125°F
17.5k $\Omega$	55°F	3.1k $\Omega$	130°F
15.3k $\Omega$	60°F	2.8k $\Omega$	135°F
13.5k $\Omega$	65°F	2.5k $\Omega$	140°F
11.9k $\Omega$	70°F	2.3k $\Omega$	145°F
10.5k $\Omega$	75°F	2.1k $\Omega$	150°F

# Appendix—Binary Configuration

## Binary Configuration

Table 38: Binary configuration details

Binary input or output	Function	Configuration	Description
BI 1	Low temp detection	Normally closed	Closed: BIP 1 is Normal (no diagnostic) Open: BIP 1 is Active (diagnostic)
BI 2	Condensate overflow	Normally closed	Closed: BIP 2 is Normal (no diagnostic) Open: BIP 2 is Active (diagnostic)
BI 3	Occupancy	Normally closed	Closed: BIP 3 is Normal (Occupied) Open: BIP 3 is Active (Unoccupied)
		Normally open	Open: BIP 3 is Normal (Occupied) Closed: BIP 3 is Active (Unoccupied) <sup>1</sup>
BI 4	Fan status <sup>2</sup>	Normally open	When the controller commands the fan on and the binary input remains open for one minute, BIP is normal (diagnostic). When the controller commands the fan on and the binary input closes, BIP is active (no diagnostic).
Defrost	Defrost	NA	When input is Open, BIP is Active (Defrost activated) When input is Closed, BIP is Normal (no Defrost)
J1-1	Fan high	Normally open	De-energized: Fan off Energized: Fan high
J1-2	Fan Medium\Exhaust	Normally open	De-energized: Fan\Exhaust off Energized: Fan Medium\Exhaust on
J1-3	Fan low	Normally open	De-energized: Fan off Energized: Fan low
TB4-1 and TB4-2	Generic binary output/base board heat	Normally open	De-energized: Output off (de-energized) Energized: Output on (energized)

1. The occupancy input applications vary for standalone and communicated instances. For more information, see Occupancy arbitration tables in the Appendix.

2. The fan status device is normally closed during normal fan operation. When the fan is off either from a fan failure or the controller commanding the fan off, the binary input device opens.



## Appendix—Unit Operation

### Unit Operation Based On The Effective HEAT/COOL Output

Table 39: Unit operation based on the effective heat/cool output

Application mode input (nviApplicMode)	Heat/cool mode input (nviHeatCool)	Effective heat/ cool mode output (nvoHeatCool)	Unit Operation
Auto	Auto	Determined by controller	Fan—Enabled Heating—Enabled Cooling—Enabled Damper—Enabled
	Heat	Heating	Fan—Enabled Heating—Enabled Cooling—Disabled Damper—Enabled
	Morning warm up	Morning warm up	Fan—Enabled Heating—Enabled Cooling—Disabled Damper—Disabled
	Cooling	Cooling	Fan—Enabled Heating—Disabled <sup>1</sup> Cooling—Enabled Damper—Enabled
	Pre-cool	Pre-cool	Fan—Enabled Heating—Disabled <sup>1</sup> Cooling—Enabled Damper—Disabled
	Off	Off	Fan—Disabled Heating—Disabled Cooling—Disabled Damper—Disabled
	Test	Test	Fan—Enabled Heating—Enabled Cooling—Enabled Damper—Enabled
	Fan only	Fan only	Fan—Enabled Heating—Disabled Cooling—Disabled Damper—Enabled
	Not present	Determined by controller	Fan—Enabled Heating—Enabled Cooling—Enabled Damper—Enabled
Heat	Any state	Heating	Fan—Enabled Heating—Enabled Cooling—Disabled Damper—Enabled
Morning warm up	Any state	Morning warm up	Fan—Enabled Heating—Enabled Cooling—Disabled Damper—Disabled

## Appendix—Unit Operation cont.

Table 39: Unit operation based on the effective heat/cool output

<i>Application mode input (nviApplicMode)</i>	<i>Heat/cool mode input (nviHeatCool)</i>	<i>Effective heat/ cool mode output (nvoHeatCool)</i>	<i>Unit Operation</i>
Cool	Any state	Cool	Fan—Enabled Heating—Disabled <sup>1</sup> Cooling—Enabled Damper
Pre-cool	Any state	Pre-cool	Fan—Enabled Heating—Disabled <sup>1</sup> Cooling—Enabled Damper—Disabled
Off	Any state	Off	Fan—Disabled Heating—Disabled Cooling—Disabled Damper—Disabled
Test	Any state	Determined by controller	Fan—Enabled Heating—Enabled Cooling—Enabled Damper—Enabled
Fan only	Any state	Fan only	Fan—Enabled Heating—Disabled Cooling—Disabled Damper—Enabled

1. Use of heat for supply air tempering and dehumidification remains available.

2. Night purge, Emergency heat, and Nul modes are not supported by the Tracer™ ZN.520 Unit Controller. If one of these modes is received by the controller, it is interpreted as Auto.



# Appendix—Data Lists

## Data Lists

Table 70 provides an input/output listing for the Tracer ZN.520 unit controller. The content of the lists conforms to both the LonMark Space Comfort Controller Functional Profile and the LonMark node object.

**Table 40 Input/output listing'**

Input	SNVT type	Output	SNVT type
<i>nviRequest</i>	<i>SNVT_obj_request</i>	<i>nvoStatus</i>	<i>SNVT_obj_status</i>
<i>nviSpaceTemp</i>	<i>SNVT_temp_p</i>	<i>nvoFileDirectory</i>	<i>SNVT_address</i>
<i>nviSetpoint</i>	<i>SNVT_temp_p</i>	<i>nvoSpaceTemp</i>	<i>SNVT_temp_p</i>
<i>nviSetptOffset</i>	<i>SNVT_temp_p</i>	<i>nvoUnitStatus</i>	<i>SNVT_hvac_status</i>
<i>nviOccSchedule</i>	<i>SNVT_tod_event</i>	<i>nvoEffectSetpt</i>	<i>SNVT_temp_p</i>
<i>nviOccManCmd</i>	<i>SNVT_occupancy</i>	<i>nvoEffectOccup</i>	<i>SNVT_occupancy</i>
<i>nviOccSensor</i>	<i>SNVT_occupancy</i>	<i>nvoHeatCool</i>	<i>SNVT_hvac_mode</i>
<i>nviApplicMode</i>	<i>SNVT_hvac_mode</i>	<i>nvoSetpoint</i>	<i>SNVT_temp_p</i>
<i>nviHeatCool</i>	<i>SNVT_hvac_mode</i>	<i>nvoDischAirTemp</i>	<i>SNVT_temp_p</i>
<i>nviFanSpeedCmd</i>	<i>SNVT_switch</i>	<i>nvoTerminalLoad</i>	<i>SNVT_lev_percent</i>
<i>nviComprEnable</i>	<i>SNVT_switch</i>	<i>nvoSpaceRH</i>	<i>SNVT_lev_percent</i>
<i>nviAuxHeatEnable</i>	<i>SNVT_switch</i>	<i>nvoOutdoorTemp</i>	<i>SNVT_temp_p</i>
<i>nviValveOverride</i>	<i>SNVT_hvac_overid</i>	<i>nvoSpaceCO2</i>	<i>SNVT_ppm</i>
<i>nviEmergOverride</i>	<i>SNVT_hvac_emerg</i>	<i>nvoEnterWaterTemp</i>	<i>SNVT_temp_p</i>
<i>nviSourceTemp</i>	<i>SNVT_temp_p</i>		
<i>nviSpaceRH</i>	<i>SNVT_lev_percent</i>		

1. LonMark certification pending

**Table 41 Configuration properties'**

Configuration property	SNVT type	SCPT reference	Description
<i>nciSndHrtBt</i>	<i>SNVT_time_sec</i>	<i>SCPTmaxSendTime (49)</i>	Send heartbeat
<i>nciSetpoints</i>	<i>SNVT_temp_setpt</i>	<i>SCPTsetPnts (60)</i>	Occupancy temperature setpoints
<i>nciUnitType</i>	<i>SNVT_hvac_type</i>	<i>SCPTvacUnitType (169)</i>	Unit type
<i>nciMinOutTm</i>	<i>SNVT_time_sec</i>	<i>SCPTminSendTime (52)</i>	Minimum send time
<i>nciRcvHrtBt</i>	<i>SNVT_time_sec</i>	<i>SCPTmaxRcvTime (48)</i>	Receive heartbeat
<i>nciLocation</i>	<i>SNVT_str_asc</i>	<i>SCPTlocation (17)</i>	Location label
<i>nciBypassTime</i>	<i>SNVT_time_min</i>	<i>SCPTbypassTime (34)</i>	Local bypass time
<i>nciSpaceRHSetpt</i>	<i>SNVT_lev_percent</i>		Space RH Setpoint
<i>nciOAMinPos</i>	<i>SNVT_lev_percent</i>		Minimum outside air position during occupied mode

Note': LonMark certification pending

## Appendix—Timeclock

### Setting the Time Clock

The time clock must be programmed for the unit to operate in occupied mode (under load). *If not programmed, the unit will run in the unoccupied mode.* Power must be supplied to the unit for the time clock to be set.

The following procedure covers:

- setting the current time and day
- setting the program (events)
- reviewing and changing the programs, and
- overriding programs (manually)

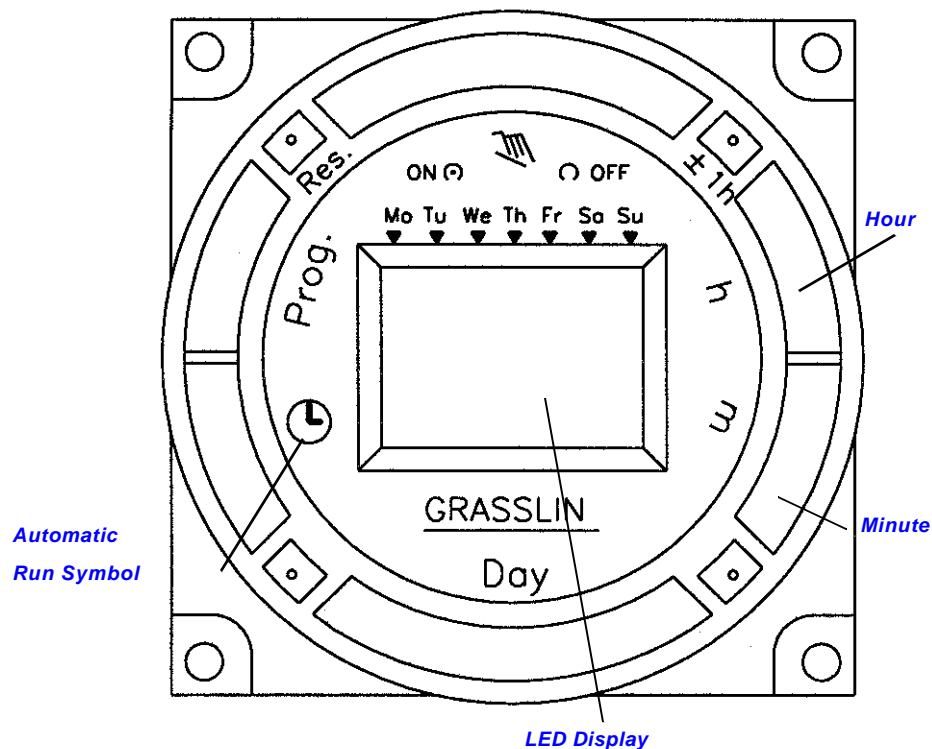

#### Set the Time and Day

The time clock (Figure 36) is located behind the access door on the top right of the unit.

1. Press Res. (Reset) to clear the display and any program data. The "day" numbers (1-7) will blink.
2. Hold h (Hour) in and toggle  $\pm 1h$  to select military or a.m./p.m. mode. If a.m/p.m. is

elected, AM appears in the display. Release h.

3. Press and hold (+) (Run). If daylight savings time is in effect,  $\pm 1h$  should appear in the display. If not, press  $\pm 1h$  to clear.
4. Still holding (+) down, set the current hour and minutes by pressing h and m respectively. Then set the day with the Day key using the number corresponding to the day of

the week (1 is Monday, 7 is Sunday).

5. Release (+) and the colon ":" in the display will begin flashing.

#### Set the Program

Determine in advance how you want the unit to operate.

For normal occupied operation, the unit "load" is set ON, whether in heating or cooling. This means

## Appendix—Timeclock

the unit will respond differently to changing conditions and maintain a higher comfort level.

For unoccupied operation or “no load” conditions, a lower comfort level is provided. The load can be switched off by using the program for periods when the room will be unoccupied.

*Note: If the room will be unoccupied, the time clock should be programmed accordingly to conserve energy. The position of the outside damper can allow too much outside air in an unoccupied space if the unit's time clock is set for “load” or occupied mode and can result in unnecessary unit cycling and undesirable heat transfer.*

*Remember that the program is easily changed and can also be overridden after it is initially set.*

1. Press the Prog. key. Spaces or fields for entering time (hours and minutes) appear as dashes separated by a colon.
2. Press Prog. again. The number of free (available) programs is given in this case to be “Fr20” or 20.
3. Press Prog. again to return to the event time mode.
4. Toggle the “Load” key on (●) 1 or off (○) to link the time with the action.

In the example from the preceding step, you would set the load ON.

5. Enter the time for the first program event.

*For example, should you want the unit to operate under load for an occupied period at 8:00 a.m., enter “08:00” AM on the display using the h and m keys. Better yet, enter the time*

*a half hour or so before the arrival of people, so the unit will bring the room up (or down” to the preset occupied temperature setpoints).*

6. If the program event you just entered will be the same every day (as indicated by *all* seven day numbers at the top of the display) you can press Prog. to lock in that event and go to the next event. If not and the program will vary during the week (e.g. different program for the weekend), don't press Prog. go to the following step.

*Note: If you press Prog. by mistake, simply continue to press Prog. until the event comes up in review and make the change.*

7. With the time and hour for the event set, select the day or days for which the event applies by pressing the Day key. Toggling the Day key gives you ten options for individual days or combinations that can be applied. Select one and lock it in by pressing Prog.

In the example, if you only want the unit to operate under load for the time set for weekdays, you would select “1 2 3 4 5” by pressing Day, then select another program event for the weekend.

8. Repeat the preceding steps to set the next program event. A “load: event is followed by an “unload” event. *For example if the unit is programmed for a load condition in the morning, you could program the unit to unload later in the day or at night when the room will become unoccupied for a period.* If the occupied and unoccupied periods vary widely but predictably, you can program a cycle of events

during any day or combination of days (up to 20 events)

9. Note: If only one event is programmed, the unit will remain in that load or unload condition all the time.
10. When all the events are programmed, press the (⊕) (run) key for normal operation. The current time as set will be displayed, along with the run symbol (⊕).

### Review and Change Programs



To review a program and events at any time, press Prog. at any time. Programs events will be displayed in the sequence they were entered with repeated presses of Prog.

To change a program, select the event as in the previous paragraph and alter the new data (day, hour minute) as desired to overwrite the old program. Press Prog to store the data.

To delete a program event, select the event again and press h and m until dashes appear in the time display. Press either Prog. or (⊕) until the dashes flash in the display.

To reset all program data, press Res.

### Override Program (Manual Operation)

While in the Run mode (⊕ symbol in display), press the hand  key to reverse the load status (e.g. if the load was ON, it is now OFF). A hand symbol  appears to indicate the override is active.

At the next scheduled event, automatic (program) control will resume eliminating the override.

To switch the load *permanently*

ON, press the  key a second time. [●] appears in the display.





## Appendix—Timeclock

---

To switch the load *permanently*

*OFF*, press the  key a third time. [O] appears in the display.

To return to automatic (pro-

grammed) operation, press the  key a fourth time. Run  appears in the display.

*NOTE: The Main Power Disconnect switch is located on the lower right side of the unit behind the right front cabinet panel. It is only used to remove power to the unit for servicing.*



# Appendix—Location Identifier

This area provided for the removable tag.

<table border="1"><tr><td data-bbox="191 575 418 674">NID: 01-00-1C-7B-DB-00 Serial # W97F 000000</td><td data-bbox="418 575 672 674">Location: Conference Room 101</td></tr></table>	NID: 01-00-1C-7B-DB-00 Serial # W97F 000000	Location: Conference Room 101	
NID: 01-00-1C-7B-DB-00 Serial # W97F 000000	Location: Conference Room 101		

# Location Identifier

---



# Location Identifier

---

# Location Identifier

---



**TRANE**

*The Trane Company*  
Worldwide Applied Systems Group  
LaCrosse, Wisconsin  
[www.trane.com](http://www.trane.com)

*An American Standard Company*

Literature Order Number	UV-SVP01A-EN
File Number	SV-TD-UV-000-SVP01A-EN-0700
Supersedes	New
Stocking Location	La Crosse

Since The Trane Company has a policy of continuous product improvement, it reserves the right to change design and specifications without notice.

## Free Manuals Download Website

<http://myh66.com>

<http://usermanuals.us>

<http://www.somanuals.com>

<http://www.4manuals.cc>

<http://www.manual-lib.com>

<http://www.404manual.com>

<http://www.luxmanual.com>

<http://aubethermostatmanual.com>

Golf course search by state

<http://golfingnear.com>

Email search by domain

<http://emailbydomain.com>

Auto manuals search

<http://auto.somanuals.com>

TV manuals search

<http://tv.somanuals.com>