

**TS-USL3,TS-USL3/N  
TS-USP3,TS-USP3/N  
USER'S MANUAL  
Intel® Socket 370 Celeron™ /  
Pentium® III CPU**

***Transcend***

***Your Supplier, Your Partner,  
Your Friend.***

# TS-USL3 Family Motherboard

Supporting Intel® Pentium® III/Celeron Series Processor  
66/100/133MHz Front Side Bus

## Intel® 815E Chipset

### Welcome !!

Congratulations on your purchase of this great value motherboard, with its range of special features and innovative onboard functions built around the advanced architecture of the new Intel® 815E Chipset. More details follow later in this manual.

### Our Website

Please come and visit us on our website at <http://www.transcendusa.com/> You'll find plenty of interesting information about this and many other quality Transcend products.

### Your User's Manual

This User's Manual is designed to help end users and system manufacturers to setup and install the motherboard. All of the information within has been carefully checked for accuracy. However, Transcend Information, Inc. (hereinafter referred to as "Transcend") carries no responsibility or liability for any errors or inaccuracies which this manual may contain. This includes references to products and software. In addition, the information and specifications are subject to change without prior notice.

### Disclaimer

Transcend provides this manual "as is" without any warranty of any kind, either expressed or implied, including – but not limited to – the implied warranties, conditions of merchantability or fitness for a particular purpose. Transcend, its management, employees, distributors and agents are in no way liable for any indirect, special, incidental or consequential damages, including loss of profits, loss of business, etc. This freedom from liability remains in effect even if Transcend has been advised of the possibility of such damages arising from any defect or error in this manual or product.

### Trademarks

All brands, product names and trademarks mentioned in this document are the properties of their respective owners or companies and are used solely for identification or explanation. It is Transcend policy to respect all product rights.

### Copyright

This manual may not, in whole or in part, be photocopied, reproduced, transcribed, translated or transmitted, in whatever form or language, without the prior written consent of the manufacturer, except for copies retained by the purchaser for personal archiving purposes.

Manual Version: 1.00

Release Date: November 2000

Copyright © 2000 Transcend Information, Inc.

# Table of Contents

|   |          |
|---|----------|
| <b>CHAPTER 1 INTRODUCTION</b>                       | <b>1</b> |
| 1.1 Essential Handling Precautions.....             | 1        |
| 1.2 Package Contents.....                           | 2        |
| 1.3 Specifications and Features.....                | 2        |
| <br>  |          |
| <b>CHAPTER 2 HARDWARE INSTALLATION</b>              | <b>5</b> |
| 2.1 Transcend TS-USL3 Motherboard.....              | 5        |
| 2.2 Layout of Transcend TS-USL3 Motherboard.....    | 6        |
| 2.3 Jumper Setup.....                               | 7        |
| 2.3.1 66/100/133MHz System Configuration.....       | 7        |
| 2.3.2 Using Jumper JP1 to Clear CMOS.....           | 8        |
| 2.3.3 Onboard Audio Setting.....                    | 10       |
| 2.3.4 Keyboard Wake Up.....                         | 10       |
| 2.3.5 VCC3 Adjust.....                              | 11       |
| 2.4 Connector Description.....                      | 12       |
| 2.4.1 Primary/Secondary IDE Connectors.....         | 12       |
| 2.4.2 Floppy Disk Drive Connector.....              | 13       |
| 2.4.3 Fan Power Connectors.....                     | 14       |
| 2.4.4 Memory Configuration.....                     | 15       |
| 2.4.5 Panel Connectors.....                         | 16       |
| 2.4.6 Wake-on-LAN Connector.....                    | 18       |
| 2.4.7 Power Connector.....                          | 19       |
| 2.4.8 IrDA-Compliant Infrared Module Connector..... | 20       |
| 2.4.9 Internal Serial Port Connector COMB .....     | 21       |
| 2.4.10 Internal Audio Connector.....                | 22       |

---

|                                 |   |           |
|---------------------------------|---|-----------|
| 2.4.11                          | USB 3/4 Connector.....                                  | 23        |
| 2.4.12                          | EEPROM for Storage of the Alert Envelope.....           | 23        |
| 2.5                             | External Back Panel I/O Ports.....                      | 24        |
| <b>CHAPTER 3 BIOS SETUP</b>     |   | <b>25</b> |
| 3.1                             | BIOS Setup .....  | 25        |
| 3.2                             | The Main Menu .....                                     | 25        |
| 3.3                             | Standard CMOS Features.....                             | 27        |
| 3.4                             | Advanced BIOS Features.....                             | 30        |
| 3.5                             | Advanced Chipset Features .....                         | 33        |
| 3.6                             | Integrated Peripherals .....                            | 36        |
| 3.7                             | Power Management Setup.....                             | 40        |
| 3.8                             | PnP/PCI Configuration Setup.....                        | 43        |
| 3.9                             | PC Health Status .....                                  | 45        |
| 3.10                            | Frequency/Voltage Control.....                          | 46        |
| 3.11                            | Load Fail-Safe Defaults.....                            | 48        |
| 3.12                            | Load Optimized Defaults.....                            | 48        |
| 3.13                            | Supervisor Password.....                                | 49        |
| 3.14                            | User Password.....                                      | 50        |
| 3.15                            | Save & Exit Setup.....                                  | 50        |
| 3.16                            | Exit Without Saving .....                               | 51        |
| <b>CHAPTER 4 SOFTWARE SETUP</b> |   | <b>52</b> |
| 4.1                             | INF Update for 815E Chipset .....                       | 52        |
| 4.2                             | VGA Driver Setup.....                                   | 53        |
| 4.3                             | Intel Security Controller Driver.....                   | 54        |
| 4.4                             | Audio Driver Setup.....                                 | 55        |
| <b>CHAPTER 5 BIOS UPGRADE</b>   |   | <b>58</b> |
| 5.1                             | How to Check Your BIOS File Name and Version .....      | 58        |
| 5.2                             | How to Download the Correct BIOS File from the Web..... | 58        |
| 5.3                             | How to Upgrade Your Motherboard BIOS .....              | 59        |
| <b>CHAPTER 6 APPENDIX</b>       |   | <b>60</b> |

## CHAPTER 1 INTRODUCTION

### 1.1 Essential Handling Precautions

***IMPORTANT. Read this page before unpacking your motherboard!***

- **Power Supply**

Be careful! Always ensure that the computer is disconnected from the power supply before working on the motherboard and its components.

- **Static Electricity**

Static electricity may cause damage to the delicate integrated circuit chips on your motherboard. Before handling the motherboard outside of its protective packaging, ensure that there is no static electric charge in your body. A static discharge sufficiently strong enough to damage computer components is not perceptible by a human. To avoid this risk, please observe these simple precautions while handling the motherboard and other computer components:

1. If possible, wear an anti-static wrist strap connected to a natural earth ground.
2. Touch a grounded or anti-static surface, or a metal fixture such as a pipe or the chassis of your system, before touching the motherboard.
3. When you have removed the motherboard from its anti-static packaging, try to hold it only by the edges, without touching any components.
4. Avoid contacting the components on add-on cards, motherboards, and modules with gold-colored connectors which plug into the expansion slots.
5. It is safest to handle system components only by their mounting brackets.
6. Keep components which are not connected to the system in the anti-static packaging whenever possible.

These precautions help to reduce the risk of static build-up and ensure any static discharge is harmless to your equipment.

- **Battery Replacement**

The battery which holds the system settings memory (CMOS RAM) on your motherboard should not require replacement for at least five years, probably much longer. In picture 2.2 (page 6), it is located near the lower left corner. Incorrect computer time and/or loss of time may indicate a weak motherboard battery.

Please replace your battery only with the same type, or a similar type recommended by the battery manufacturer. If the battery is replaced incorrectly, there is a risk of a short circuit or explosion. Used batteries should be disposed of in accordance with the manufacturer's instructions and local environmental regulations.

## • **Electric Screwdrivers**

To reduce the risk of damage to the motherboard due to excessive torque, avoid setting electric screwdrivers above 7.5 kg/cm.

## **1.2 Package Contents**

This motherboard package should contain the following items. Please check them as soon as you unpack. If you find any damaged or missing items, please contact your retailer.

- Motherboard X 1
- 1 X CD-ROM
- 1 X FDD cable
- User's Manual
- COM port cable x 1 (optional)
- Ultra DMA66/100 cable x 1
- USB Cable x 1 ( optional )

## **1.3 Specifications and Features**

### • **CPU**

- Supports Intel® Pentium III/Celeron™ Series

### • **Chipset**

- Intel® 815E (GMCH, ICH2); FSB: 66/100/133 MHz

### • **Display Cache Memory** (TS-USL3,TS-USL3/N only)

- AIMM (AGP Inline Memory Module) Card (Optional)

### • **DRAM Memory**

- Supports Synchronous DRAM
  - 3 X 168-pin DIMM module sockets on board
  - 8~512MB memory size
  - 8/16/32/64/128/256/512MB DIMM
  - 64 data bits structure only
-

- **On Board VGA**(TS-USL3,TS-USL3/N only)

- Full 2D/3D/Direct X acceleration
- Texture-mapped 3D with point-sampled,bilinear,trilinear,and anisotropic filtering
- Supports 640 by 480(16,256,High,True color)
- Supports 800 by 600(256,High,True color)
- Supports 1024 by 768(256,High,True color)
- Supports 1152 by 864(256,High,True color)
- Supports 1280 by 1024(256,High,True color)
- Supports 1600 by 1200(256 colors)

- **I/O Bus Slot**

- 3 X Master/Slave PCI Bus slots (PCI 2.2 compliant)
- 1 X CNR (Communication and Networking Riser) slot

- **Award BIOS**

- Supports PC99, Plug-and-Play
- Supports ACPI, APM, DMI, Green Feature

- **I/O Functions**

- Supports PIO Mode 3, 4, 5 ATAPI devices and Ultra DMA/33/66/100
- Supports 2 high speed UART 16550 COM ports
- Supports SPP/EPP/ECP LPT port
- Supports 3 mode/1.44MB/2.88MB floppy drive
- Supports PS/2 Mouse and PS/2 Keyboard
- Supports IrDA port
- Supports 4XUSB ports(2 by cable)
- Supports VGA port
- Supports Line-out, Line-in and MIC-in jack
- Supports Game/MIDI port
- Supports 10/100 Mbps LAN port(TS-USL3/N,TS-USP3/N only)

- **Switching Voltage Regulator**

- Intel VRM 8.4 compliant

- **Other Features**

- Year 2000 compliant
- Power failure resume
- Support Transcend ez BIOS
- BIOS Virus protection (warning)
- PS/2 Mouse and Keyboard Wake Up
- Supports Wake-on-LAN function
- Remote Ring Wake Up
- Time Wake Up
- Board voltage monitors for CPU core, +3.3V, +/-5.0V, +/-12.0V, VTT, 3.3VSB/5VSB
- CPU overheat alarm
- CPU fan auto-off in sleep mode

- **PCB Dimensions**

- Micro-ATX form factor, 4-layer PCB, 24.3cm x 22.5cm (9.6 in. x 8.9 in.)



## CHAPTER 2 HARDWARE INSTALLATION

### 2.1 Transcend TS-USL3 Motherboard

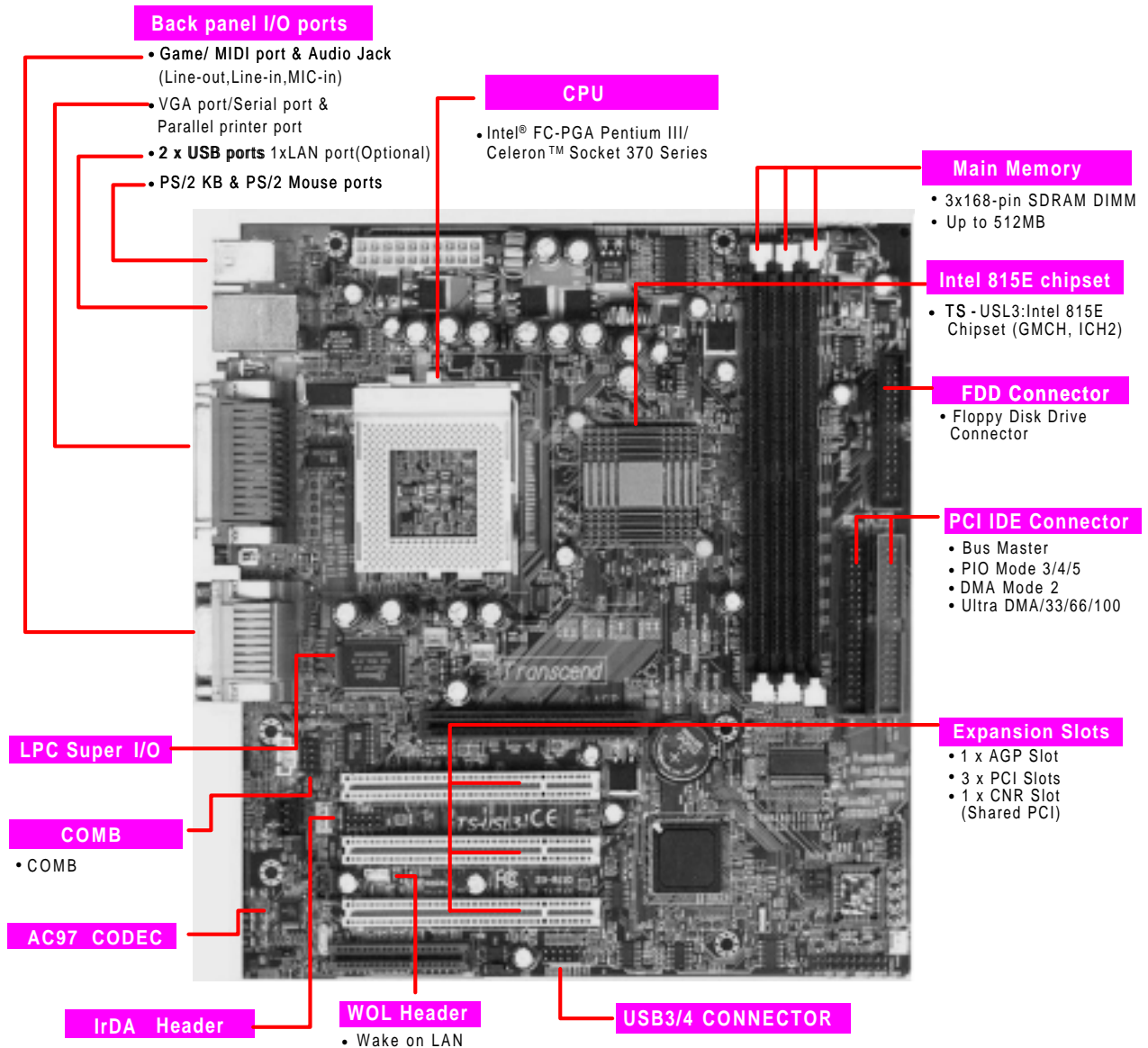

# 6

# HARDWARE INSTALLATION

## 2.2 Layout of Transcend TS-USL3 Motherboard

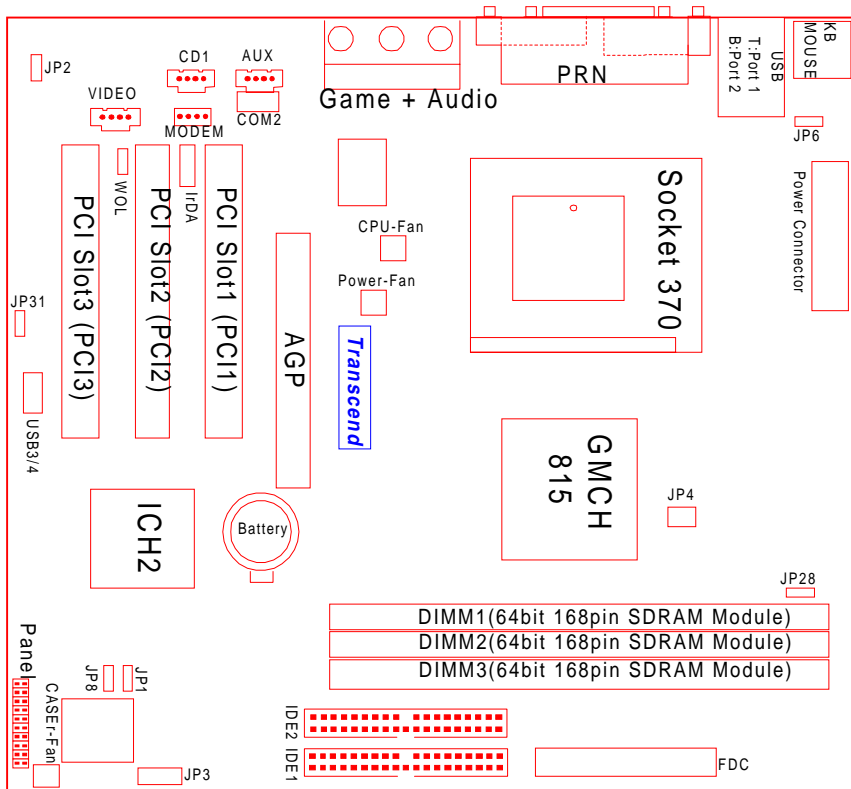

## 2.3 Jumper Setup

### 2.3.1 66/100/133 MHz System Configuration

The JP4 Jumper allows you to set the FSB (Front Side Bus) to 66/100/133MHz configuration. When the Jumper is set to “Auto”, the frequency range depends on your CPU type. When you set the FSB to 66MHz, you can select a system bus frequency from 66MHz to 99MHz through “CPU Host/PCI Clock” of “Frequency/Voltage Control” in the BIOS Setup menu. When you set the FSB to 100MHz, you can select a system bus frequency from 100MHz to 132MHz . When you set the FSB to 133MHz, you can select a system bus frequency from 133MHz to 166MHz .

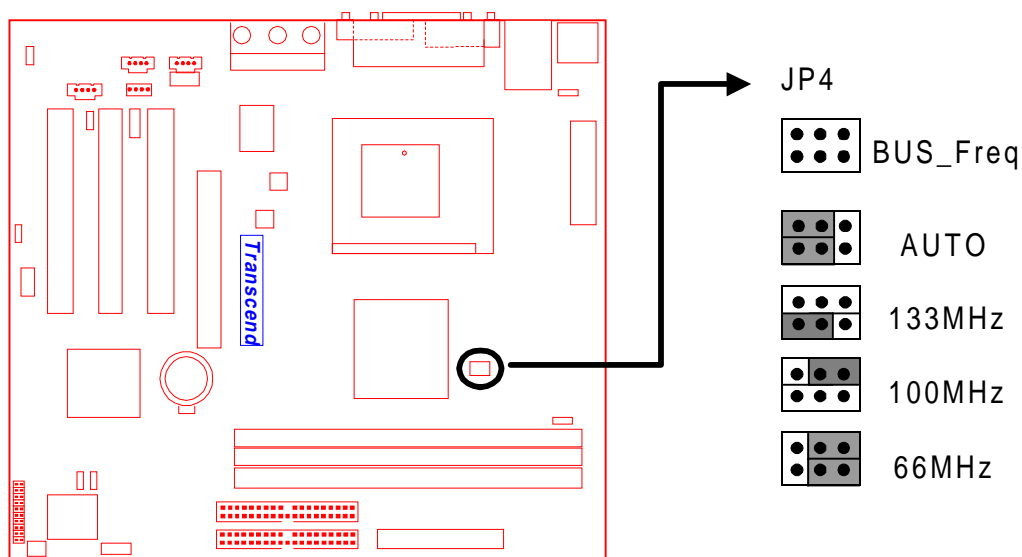

**66/100/133MHz FSB Configuration Jumper**

## 2.3.2 Using Jumper JP1 to Clear CMOS

To clear the CMOS data, you should turn off your computer's power and short pin1 and pin2 in JP1.

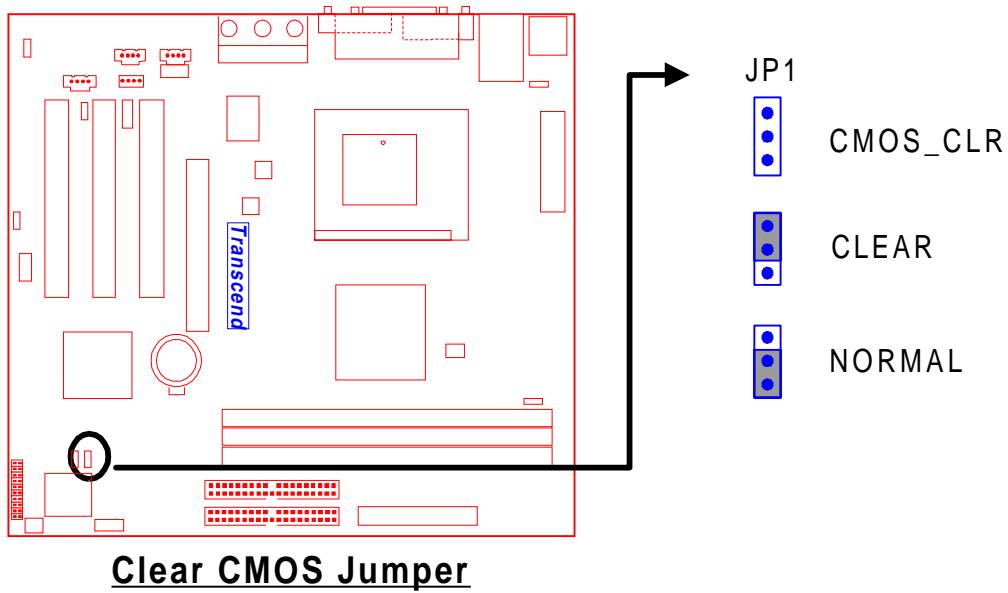

## 2.3.3 Onboard Audio Setting (JP2 ON-BOARD AUDIO)

The onboard audio CODEC can be enabled or disabled via this jumper to use an external CNR card. Disable the onboard audio CODEC, if you want to use a PCI Sound Card or an CNR Audio Card. When you install a CNR card, remember that the onboard audio CODEC uses the primary channel; therefore, for the onboard CODEC to function, you must set the CNR card to be secondary.

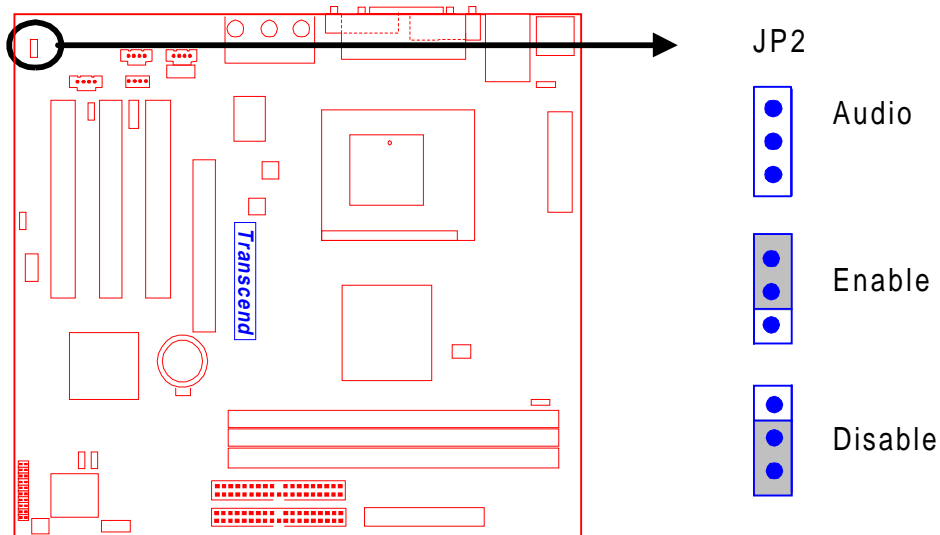

**Audio Selection Jumper**

## 2.3.4 Keyboard Wake Up (3-pin KB-AWK)

This function makes the Keyboard Power Up the system. Set this jumper to “Enable” if you’d like your Keyboard to Power Up your computer. Then, go to the “Power On Function” in the “Integrated Peripherals” in BIOS Setup, and choose the setting you prefer.

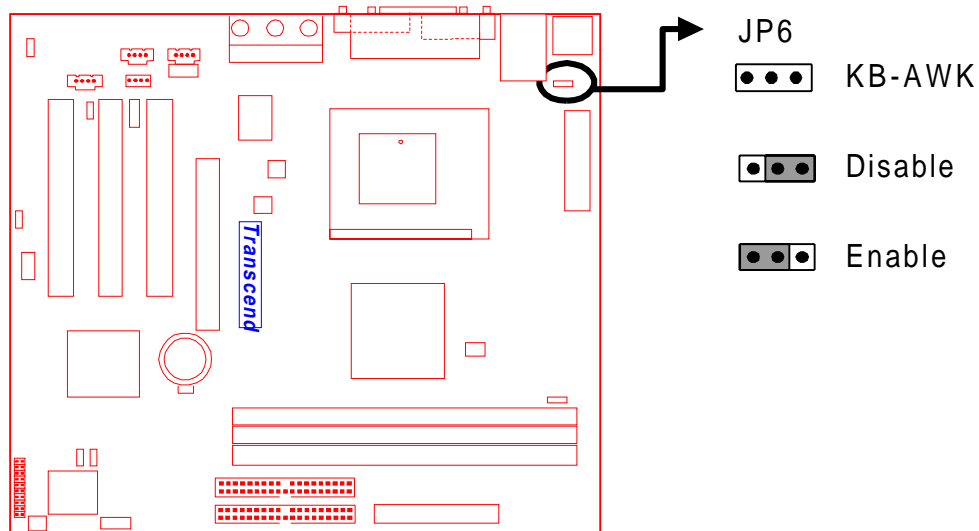

**Keyboard Wake Up**

## 2.3.5 VCC3 Adjust

Keep this selection fixed unless you are familiar with the system. Default is Medium.

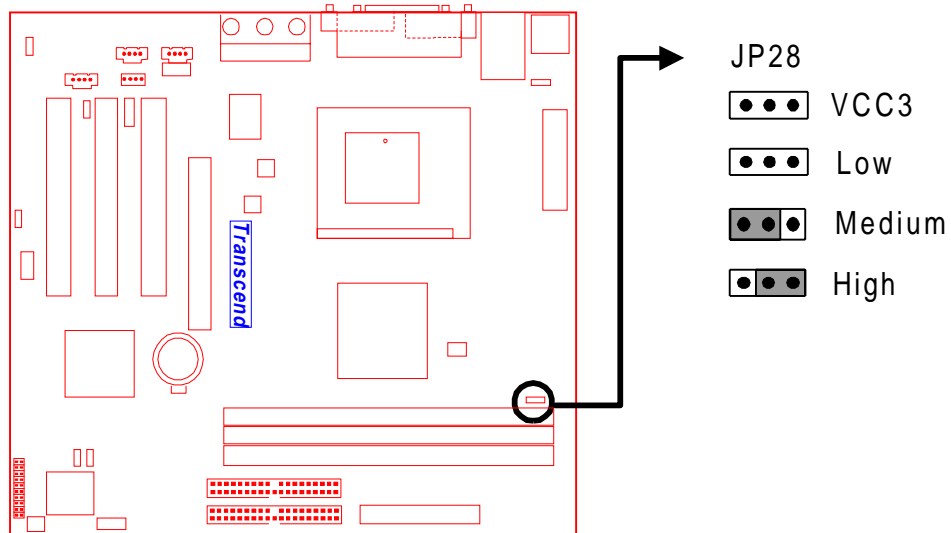

VCC3 Adjust

## 2.4 Connector Description

### 2.4.1 Primary/Secondary IDE Connectors

This motherboard supports two 40-pin IDE connectors marked as IDE1 (primary channel) and IDE2 (secondary channel). Each channel supports two IDE devices for a total of four devices. Connect your Hard Disk (the main one if you are using more than one) to the “Master” connector (at the end of the cable) and connect it to IDE1 (see important note below). If your HDD supports Ultra DMA/66, you must use an 80-wire cable, otherwise the HDD won't be able to reach this speed.

If you intend to operate two IDE devices from the same channel, one device must be set to “Master” mode and the other to “Slave” mode. A Hard Disk Drive, CD ROM Drive or other IDE device can have either setting, depending on device's jumper setting. Please refer to the device's manual for more information.

**NOTE: The Connectors must be attached to the IDE channels correctly. Make sure that the red stripe on the edge of the ribbon cable (this may be faint and could be a dotted line) is the nearest to PIN 1 (on the left as the motherboard is shown in the picture below).**

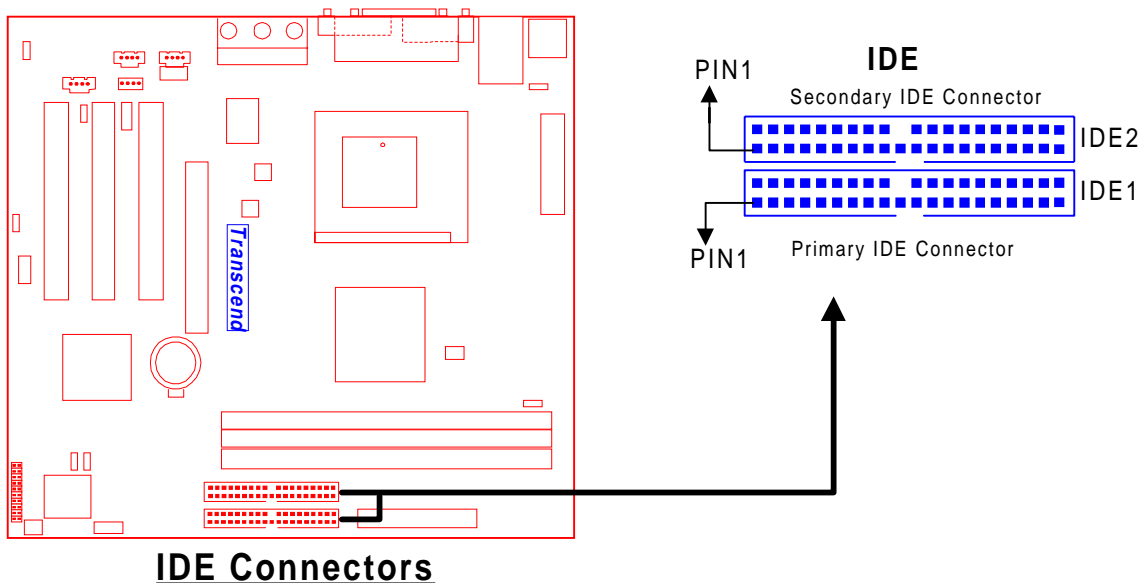



## 2.4.2 Floppy Disk Drive Connector (34-pin FDC)

This connector supports the floppy disk drive ribbon cable which is one of the items in your motherboard package. After connecting the single end to the board, connect the two plugs at the other end to the floppy drives. Remember, as in the last section, the red stripe on the edge of the ribbon cable must be the nearest to PIN 1 (on the left as shown below), or your connection won't work.

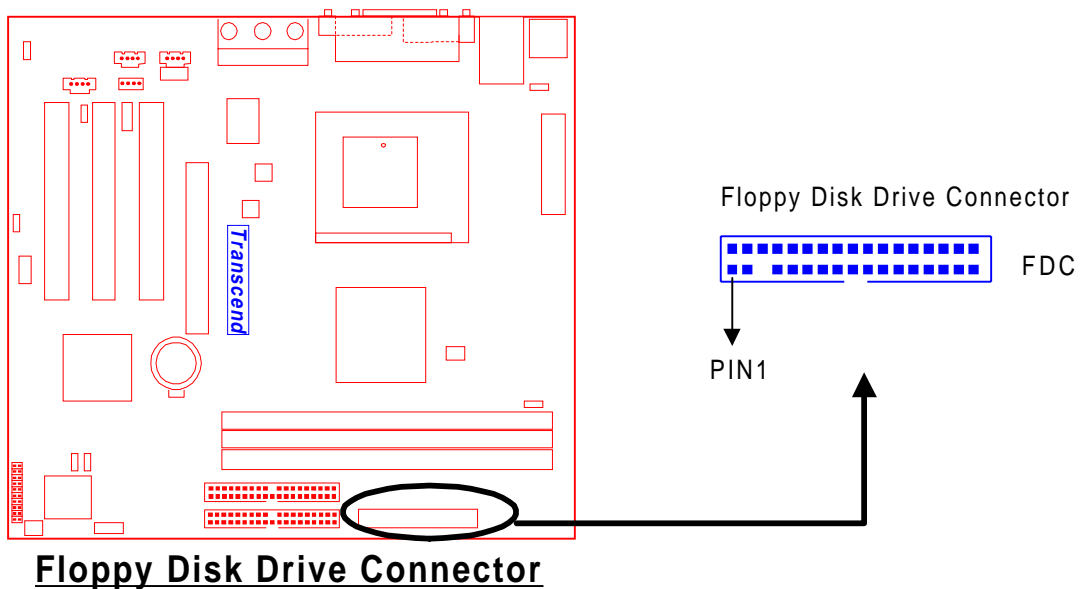

## 2.4.3 Fan Power Connectors

There are three fan power connectors on the motherboard: CPU-FAN, POWER-FAN, and CASE-FAN. Each connector provides +12V power. The cables can only be attached one way. If you try to put them in the wrong way, they won't fit. These connectors support cooling fans of 500 mA (6W) or less.

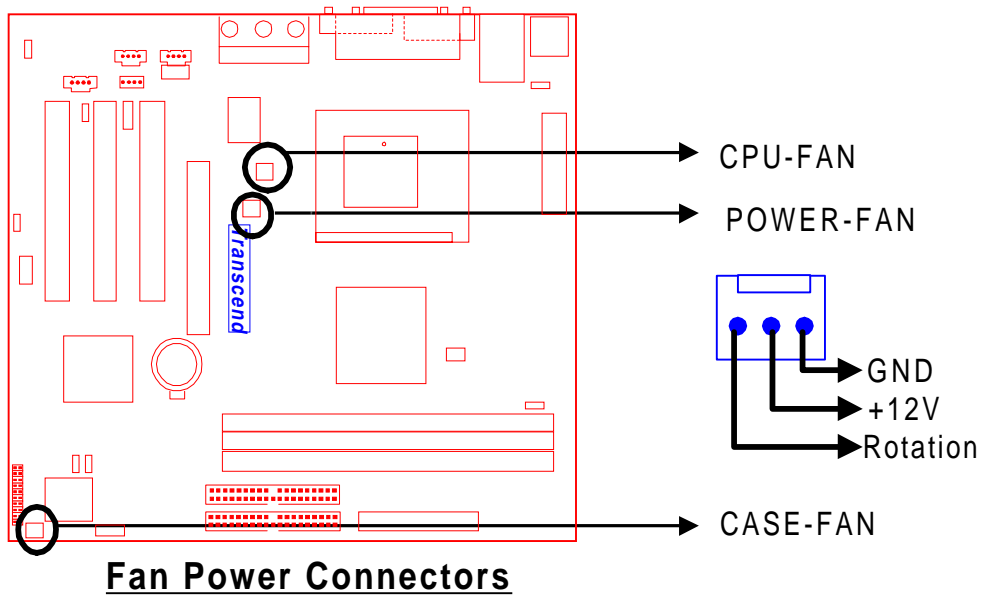

## 2.4.4 Memory Configuration

This motherboard support PC100/PC133 SDRAM DIMM memory modules. You can install either single-sided or double-sided memory modules into any socket, but cannot exceed 512 MB total.

**NOTE: This motherboard supports memory modules with 8/16/32/64/128/256/512MB.**

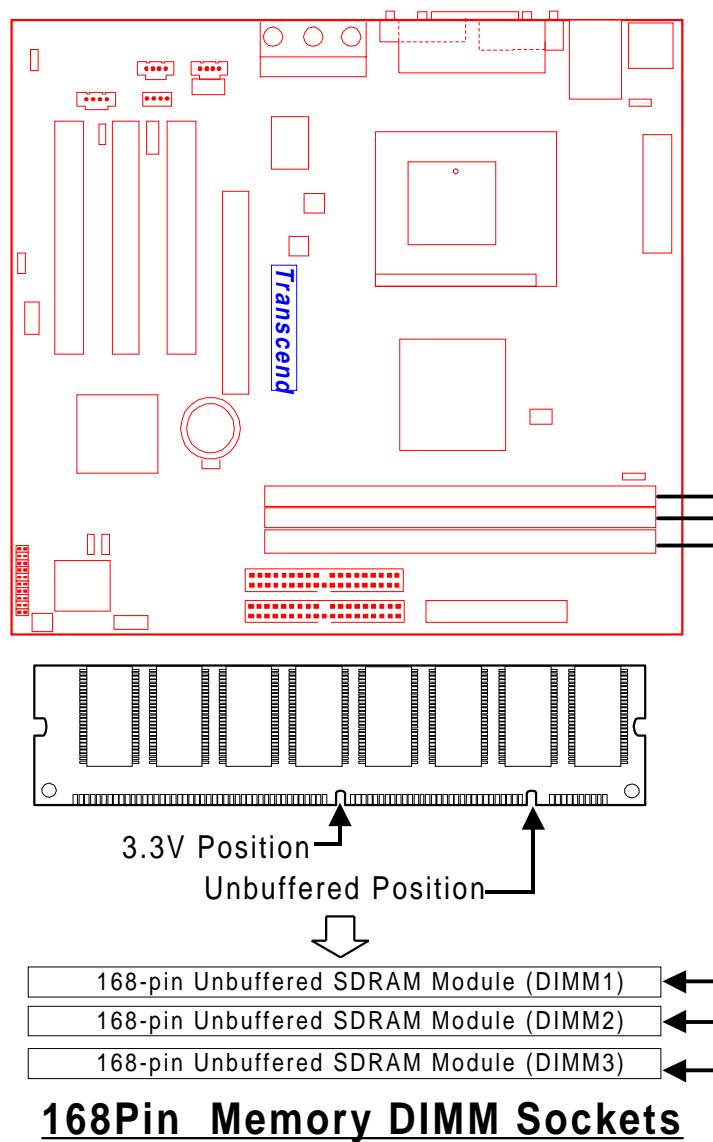

## 2.4.5 Panel Connectors

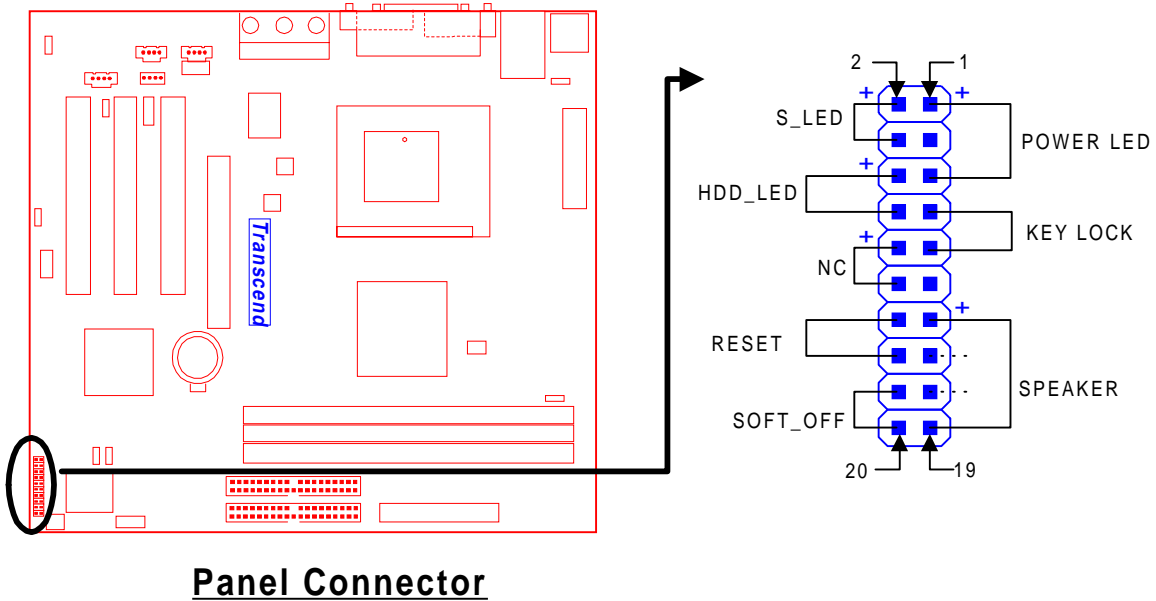

### Power LED Lead (3-pin POWER LED)

This 3-pin connector attaches to the power LED.

Pin1 : +5V

Pin3 : NC

Pin5 : GND

### Keylock Lead (2-pin KEYLOCK)

Use the keylock to enable or disable the Keyboard.

Pin7 : KEYLOCK

Pin9 : GND

### Speaker Lead (4-pin SPEAKER)

This 4-pin connector connects to the case-mounted speaker.

Pin13 : +5V

Pin15 : GND

Pin17 : NC

Pin19 : SPK

## **Suspend Mode LED Lead (2-pin S\_LED)**

The S\_LED will light when the suspend mode works.

Pin2 : +5V

Pin4 : GND

## **Hard Disk LED Lead (2-pin HDD\_LED)**

This 2-pin connector connects to the LED of the hard disk drive. The LED lights up when a HDD is active.

Pin6 : +5V

Pin8 : GND

## **Reset Switch Lead (2-pin RESET)**

This 2-pin connector connects to the case-mounted reset switch for rebooting your computer without turning off and on your power switch.

Pin14 & Pin16

## **Soft Power-Off Lead (2-pin SOFT\_OFF)**

Attach the SOFT\_OFF switch of the panel to this connector. Use the switch to Power On/Off your system.

Pin18 & Pin20

## 2.4.6 Wake-on-LAN Connector (3-pin WOL)

This connector connects to LAN cards with a Wake-on-LAN output. The system can be Powered Up when a wake-up packet or signal is received from the LAN card.

**NOTE:** This function requires that the “Wake-Up by PCI & WOL” function in the “Power Management Setup” is set to “Enabled” and that your system has an ATX power supply with at least 720mA +5V standby power.

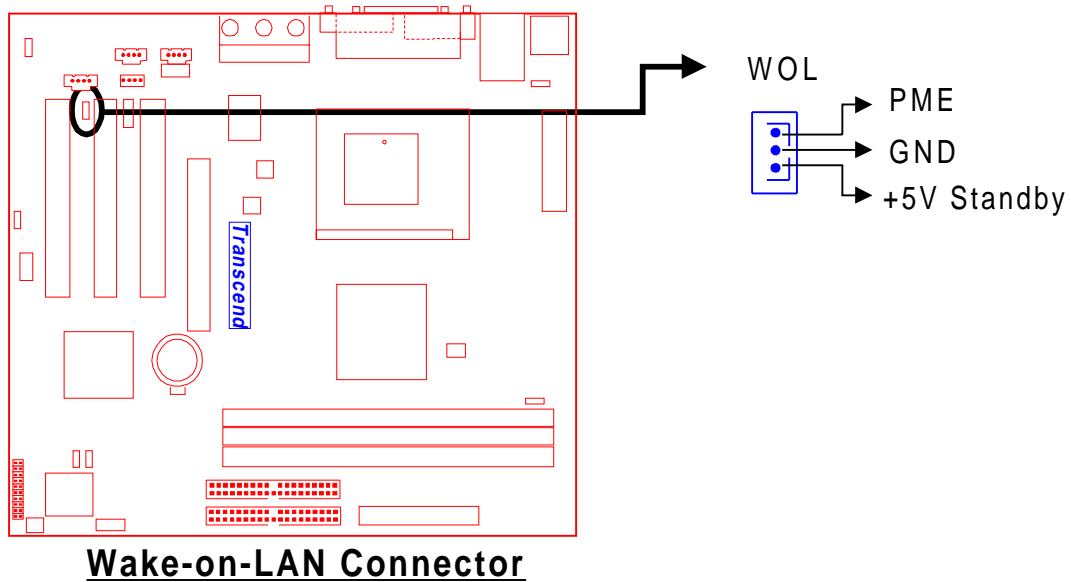

## 2.4.7 Power Connector (20-pin PWR-CONN)

Make sure you plug the ATX power supply connector in the right direction. The pin definition is shown below. **Make sure that your ATX power supply can support at least 720mA +5V standby power for the Advanced Configuration and Power Interface (ACPI) functions.**

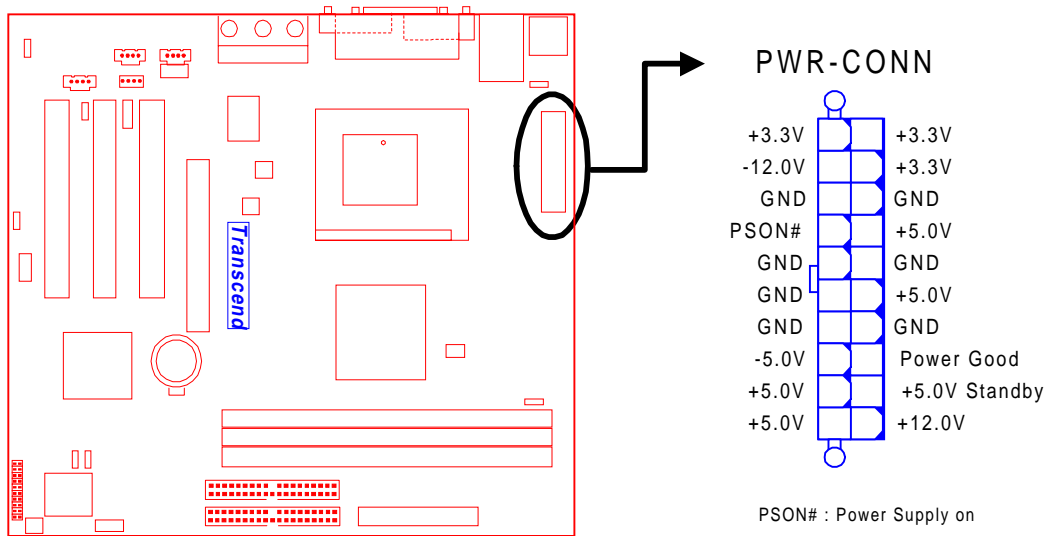

**Power Connector**

## 2.4.8 IrDA-Compliant Infrared Module Connector (10-pin IrDA)

The IrDA connector can be configured to support a wireless infrared module. With this module and application software such as Laplink or Win95 Direct Cable Connection, users can transfer files to or from laptops (notebooks), PDAs and printers. You must also configure the setting through “UART Mode Select” in “Integrated Peripherals” in BIOS setup to select “IrDA”. Connect the Standard IR (SIR) device to the onboard SIR connector according to the pin definitions. An optional Consumer Infrared (CIR) set connects to the CIR and SIR connectors simultaneously for both wireless transmitting and remote control functions through one external infrared module.

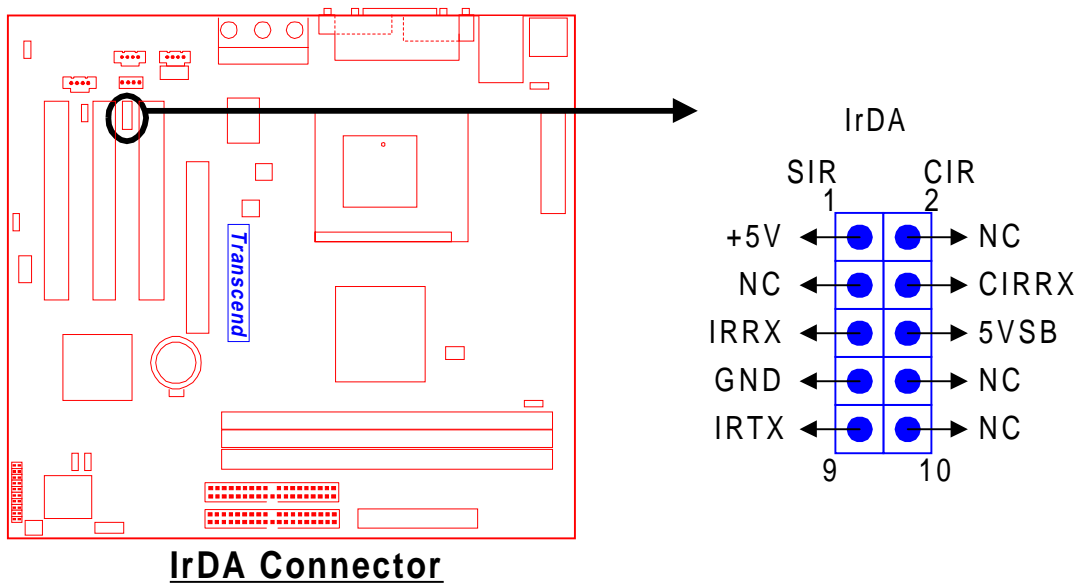



## 2.4.9 Internal Serial Port Connector COMB

You can use the provided serial port bracket to add a serial port for additional serial devices.

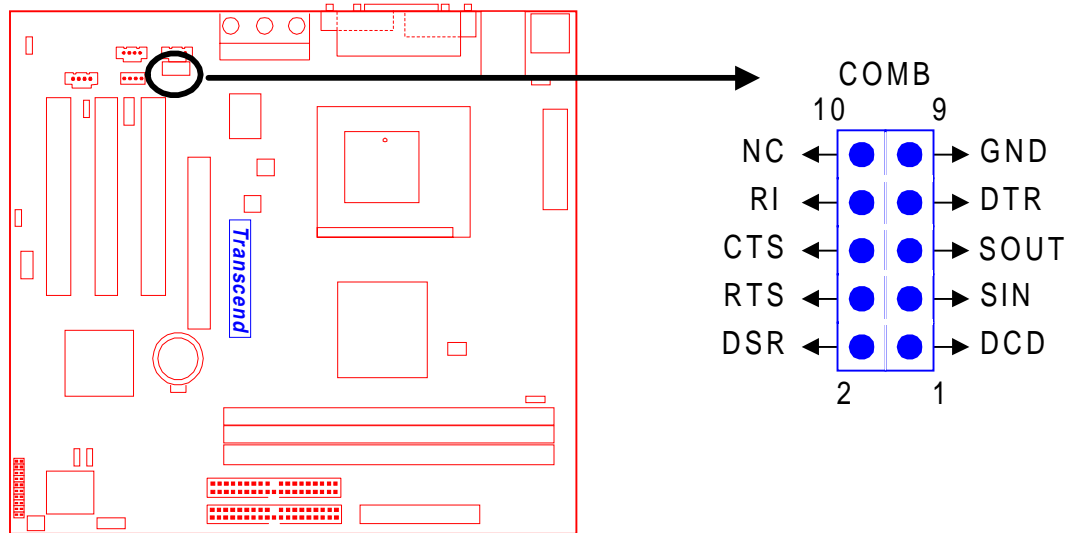

**Internal Serial Port Connector COMB**

## 2.4.10 Internal Audio Connector

These connectors allow you to receive stereo audio input from sound sources such as a CD-ROM, TV tuner, or MPEG card. The MODEM connector allows the onboard audio to interface a voice modem card with a matched connector. It also allows the sharing of mono\_in (such as a phone) and mono\_out (such as a speaker) between the onboard audio and the voice modem card.

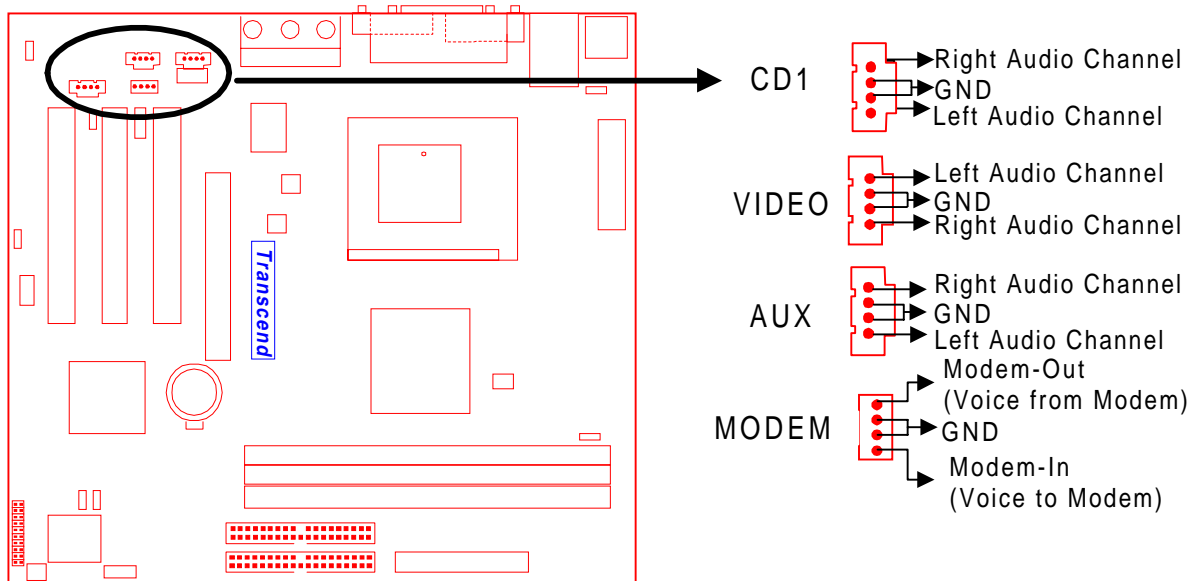

**Internal Audio Connectors**

## 2.4.11 USB 3/4 Connector

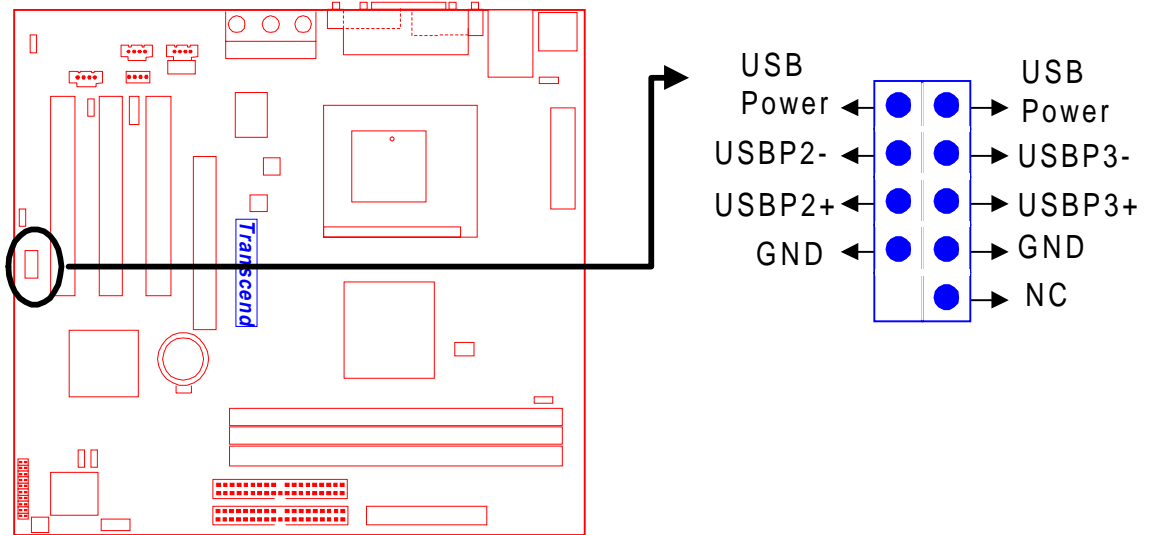

**USB 3/4 Connector**

## 2.4.12 EEPROM for storage of the alert envelope (JP31)

This function for TS-USL3/N TS-USP3/N only

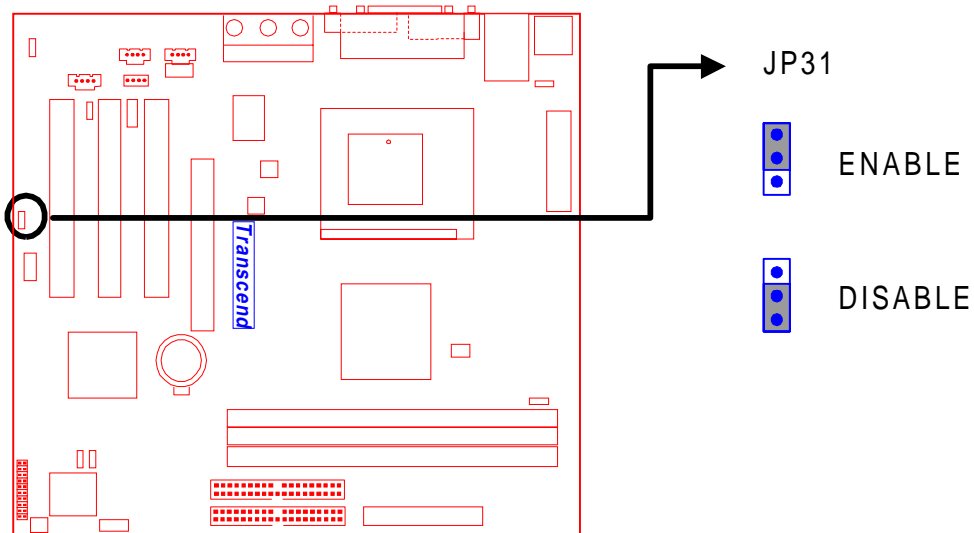

## 2.5 External Back Panel I/O Ports

There are 10 kinds of external connectors on the back panel of the motherboard.

The view angle of drawing shown here is from the back panel of the housing.

1. PS/2 Mouse Port (Green 6-pin MOUSE)
2. PS/2 Keyboard Port (Purple 6-pin KB)
3. USB (Universal Serial Bus) Ports 1 & 2 (Black two 4-pin USBs) & LAN Port (Black 8-pin LAN For TS-USL3/N TS-USP3/N only)
4. Parallel Port (Burgundy 25-pin PRN)
5. Serial Port COMA (Turquoise 9-pin COMA)
6. Display VGA Port (Blue 15-pin VGA)
7. Game Port/MIDI Port (Gold 15-pin GAME)
8. Line\_out (Lime Green 1/8" LINE\_OUT)(TS-USL3,TS-USL3/N only)
9. Line\_in (Light blue 1/8" LINE\_IN)
10. MIC\_in (Pink 1/8" MIC)

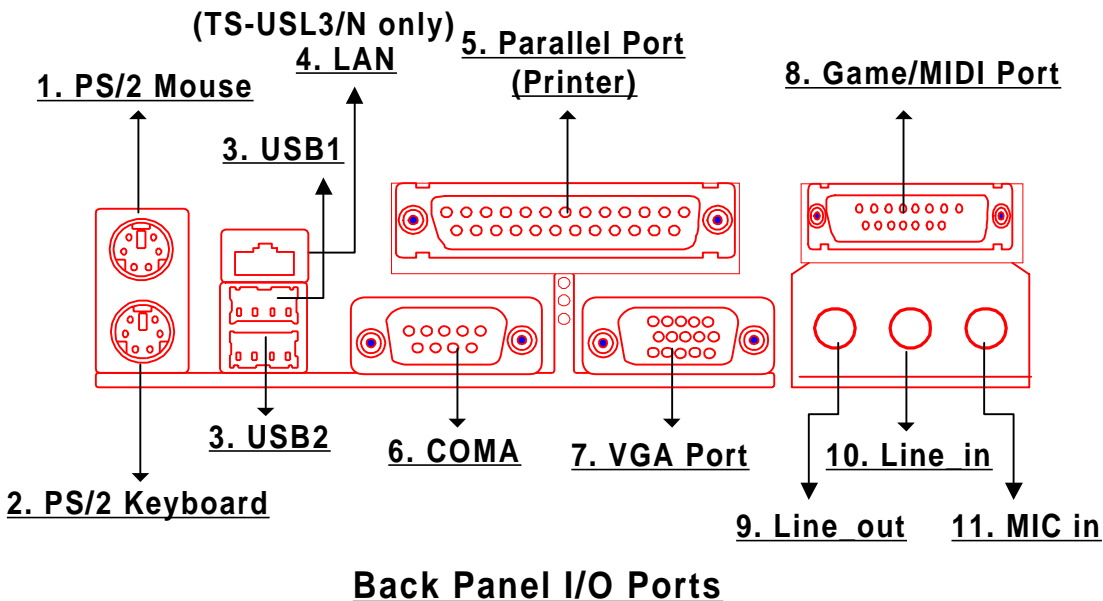

## CHAPTER 3 BIOS SETUP

### 3.1 BIOS Setup

Award BIOS has a built-in Setup program that allows users to modify the basic system configuration. This information is stored in CMOS RAM so it can retain the Setup information when the power is turned off. If the CMOS battery fails, this data will be lost. If that happens, please setup your configuration parameters again after replacing the battery. Please refer to Section 1.1, Essential Handling Precautions.

### 3.2 The Main Menu

As you turn on or reboot the system, the BIOS is immediately activated. It will read the system configuration information, and check the system through the Power On Self Test (POST). During the POST process, pressing the [Del] key allows you to enter the Award BIOS configuration system. The following screen will appear.

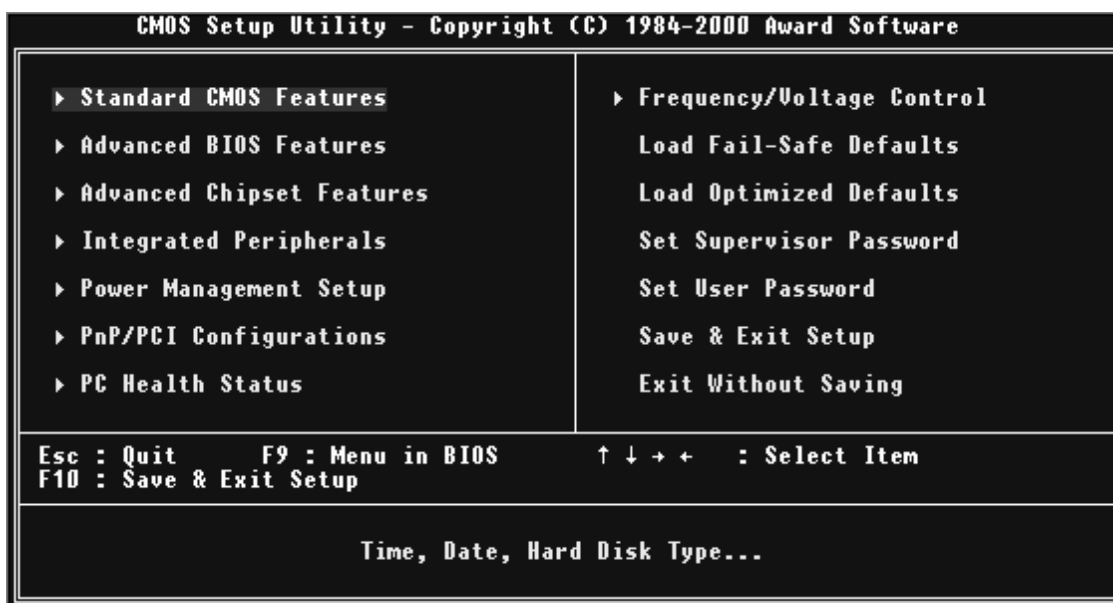

In the Award BIOS system, you can use the arrows (↑ ↓ → ←) to highlight an item, and press the [Enter] key to enter the sub-menu. The following keys help you navigate within Setup.

- [Esc] Main Menu: Quit and do not save changes to CMOS RAM
- Other pages: Exit the current page and return to the Main Menu
- [PgUp] Increase the numeric value or make changes
- [PgDn] Decrease the numeric value or make changes

|       |   |
|-------|---|
| [+]   | Increase the numeric value or make changes          |
| [-]   | Decrease the numeric value or make changes          |
| [F1]  | General help on setup navigation keys               |
| [F5]  | Load previous values from CMOS                      |
| [F6]  | Load the Fail-Safe Defaults from BIOS default table |
| [F7]  | Load the Optimized Defaults                         |
| [F10] | Save all the CMOS changes and exit                  |

The Following is a brief summary of each setup category.

- **Standard CMOS Features**

Options in the original PC AT-compatible BIOS

- **Advanced BIOS Features**

Award enhanced BIOS options

- **Advanced Chipset Features**

Available options specific to your system Chipset

- **Integrated Peripherals**

I/O subsystems that depend on the integrated peripheral controllers in your system

- **Power Management Setup**

Advanced Power Management (APM) and Advanced Configuration Power Interface (ACPI) options

- **PnP/PCI Configurations**

Plug and Play standard and PCI Local Bus configuration options

- **PC Health Status**

To display the fan status, CPU temperature, system temperature, etc., and provide the temperature monitoring option

- **Frequency/Voltage Control**

To control the frequency and voltage of the CPU

- **Load Fail-Safe Defaults**

To load the most basic BIOS default values required for your system to operate

- **Load Optimized Defaults**

To load the BIOS default values that are factory settings for optimal system performance

- **Set Supervisor/User Password**

To change, set, or disable a password

- **Save & Exit Setup**

To save settings in nonvolatile CMOS RAM and exit Setup

- **Exit Without Saving**

To abandon all changes and exit Setup

### 3.3 Standard CMOS Features

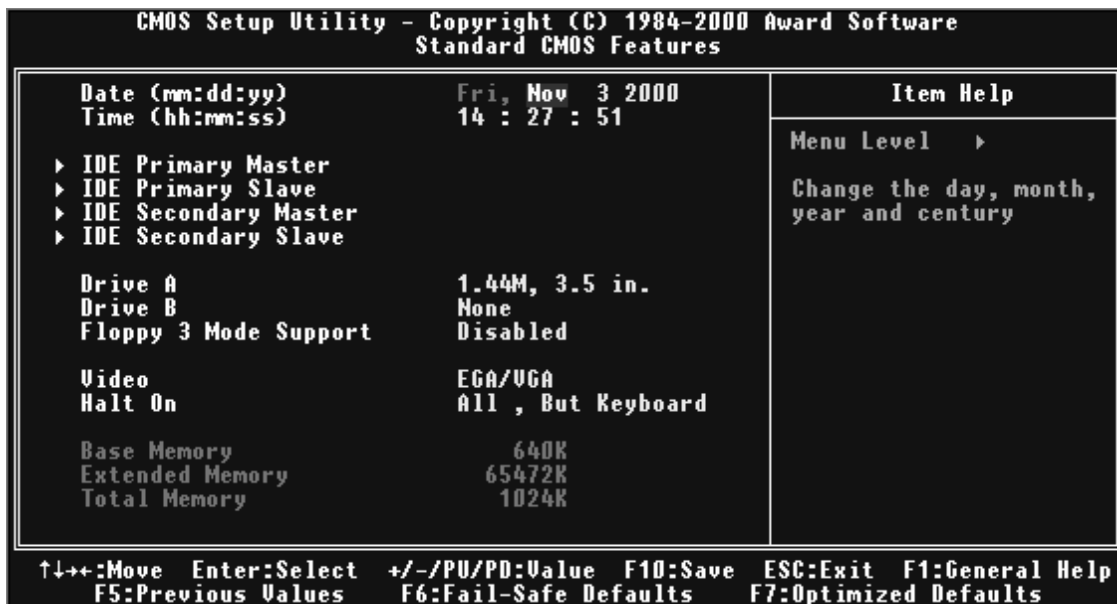

- **Date (mm:dd:yy)/Time (hh:mm:ss)**

Highlight the items and use [PageUp]/[PageDown] to change the value of Date/Time.

- **IDE Primary/Secondary Master/Slave**

Press [Enter] to enter the sub menu.

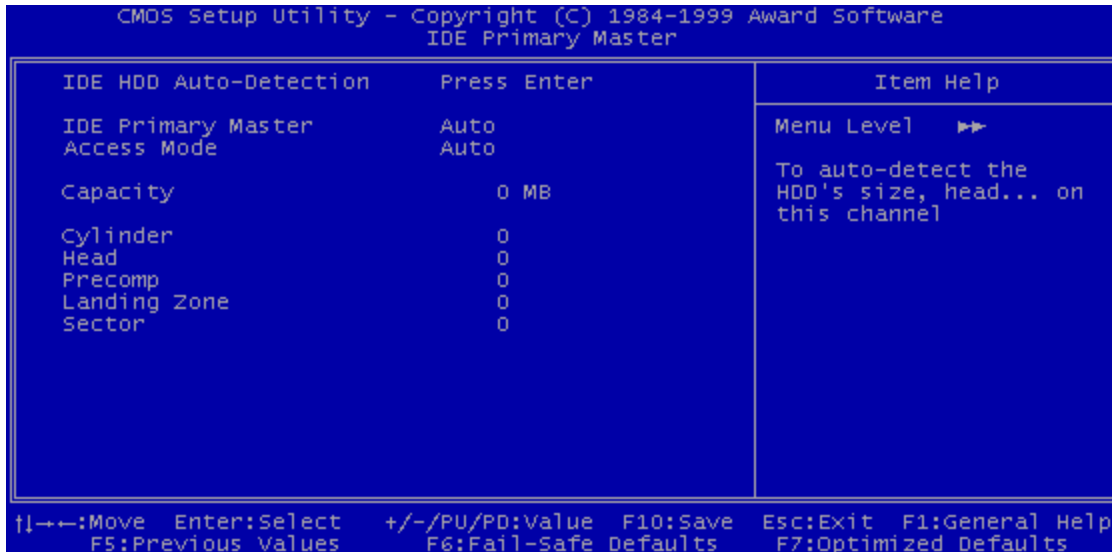

- IDE HDD Auto-Detection: Detect the HDD on this channel. If the detection is successful, it fills the remaining fields in this menu.
- IDE Primary/Secondary Master/Slave: We recommend that you select “AUTO” for all drives. The BIOS can automatically detect the specifications during POST while the system boots. You can also choose “Manual” to set the specifications yourself. As to “None”, it means there is no device installed on this IDE channel.
- Access Mode : “Normal”, “LBA”, “Large”, or “Auto”.
  - Normal: Maximum number of cylinders, heads, and sectors supported are 1024, 16, and 63 respectively.
  - LBA (Logical Block Addressing): During drive access, the IDE controller transforms the data address described by sector, head, and cylinder number into a physical block address. This significantly improves data transfer rates for drives with more than 1024 cylinders.
  - Large: For drives that do not support LBA and have more than 1024 cylinders.
  - Auto: The BIOS automatically determines the optimal access mode.
- Capacity: Disk drive capacity. Note that this size is slightly greater than the size of the formatted disk given by a disk-checking program.
- Cylinder: Number of cylinders
- Head: Number of heads



- Precomp: Write precompensation cylinder
- Landing Zone: Landing zone
- Sector: Number of sectors

## • Drive A/Drive B

Select the correct type of diskette drive(s) installed in the computer.

- None: No diskette drive installed
- 360K, 5.25 in.: 5-1/4-inch standard drive; 360 kilobyte capacity
- 1.2M, 5.25 in.: 5-1/4-inch high-density drive; 1.2 megabyte capacity
- 720K, 3.5 in.: 3-1/2-inch double-sided drive; 720 kilobyte capacity
- 1.44M, 3.5 in.: 3-1/2-inch double-sided drive; 1.44 megabyte capacity
- 2.88M, 3.5 in.: 3-1/2-inch double-sided drive; 2.88 megabyte capacity

## • Floppy Mode 3 Support

Supports some particular Japanese floppy drives (3-1/2-inch drive with 1.2 megabyte capacity).

## • Video

Select the type of primary video subsystem in your computer. The BIOS will detect the correct video type automatically. The BIOS supports a secondary video subsystem, but do not select it in this Setup.

- EGA/VGA: Enhanced Graphics Adapter/Video Graphics Array. For EGA, VGA, SEGA, SVGA or PGA monitor adapters.
- CGA 40: Color Graphics Adapter, powers up in 40-column mode.
- CGA 80: Color Graphics Adapter, powers up in 80-column mode.
- MONO: Monochrome adapter, including high resolution.

## • Halt On

During POST, the computer stops if the BIOS detects a hardware error. You can set the BIOS to ignore certain errors during POST and continue the boot-up process. The followings are the selections:

- All Errors: If the BIOS detects any non-fatal errors, POST stops and prompts you to take corrective action.
- No Errors: POST does not stop for any error.
- All, But Keyboard: If the BIOS detects any non-fatal errors except keyboard, POST stops and prompts you to take corrective action.

- All, But Diskette: If the BIOS detects any non-fatal error except floppy disk drive, POST stops and prompts you to take corrective action.
- All, But Disk/Key: If the BIOS detects any non-fatal error except floppy disk drive or keyboard, POST stops and prompts you to take corrective action.

### 3.4 Advanced BIOS Features

This "Advanced BIOS Features" option allows you to improve your system performance and setup system features according to your preferences.



#### • Virus Warning

When this function is enabled, you will receive a warning message if a program (specifically, a virus) attempts to write to the boot sector or the partition table of the hard disk drive. You should then execute an anti-virus program. Keep in mind that this feature protects the boot sector only, not the entire hard drive.

**NOTE: Many disk diagnostic programs that access the boot sector table can trigger the virus warning message. If you plan to run such a program, we recommend that you first disable the virus warning.**

---

- **CPU Internal Cache/External Cache**

Cache memory is additional memory that is much faster than conventional DRAM (system memory). 486-type CPUs and higher contain internal cache memory. Most, but not all, modern PCs have additional (external) cache memory. When the CPU requests data, the system transfers the requested data from the main DRAM into cache memory for even faster access by the CPU. The “External Cache” field may not appear if your system does not have external cache memory.

- **CPU L2 Cache ECC Checking**

Select “Enabled” to start the ECC function for L2 Cache.

- **Processor Number Feature**

Make the CPU Serial number function active. (Only in PIII CPU)

- **Quick Power On Self Test**

Select “Enabled” to reduce the amount of time required to run POST. The Quick POST skips certain steps. We recommend that you normally disable Quick POST. It’s better to find a problem during POST than to lose data during your work.

- **First/Second/Third/Other Boot Device**

The original IBM PCs load the DOS operating system from drive A (floppy disk). So, IBM PC-compatible systems are designed to search for an operating system first on drive A, and then on drive C (hard disk). However, the BIOS attempts to load the operating system from the devices in the sequence selected in these fields. In addition to the traditional drives A (“Floppy”) and C (“HDD-0”), options include “HDD-1”, “HDD-2”, “HDD-3”, and “CD-ROM”; plus a “SCSI” hard drive, a “LS/ZIP” drive and a “LAN” drive. If your boot device is not included in the list, you can set the “Boot Other Device” field to “Enabled”, and let the system detect the drive automatically.

- **Swap Floppy Drive**

This field is effective only in systems with two floppy drives. Selecting “Enabled” assigns physical drive B to logical drive A, and physical drive A to logical drive B.

- **Boot Up Floppy Seek**

When you select “Enabled”, the BIOS tests (seeks) floppy drives to determine whether they have 40 or 80 tracks. Only 360-KB floppy drives have 40 tracks. Drives with 720KB, 1.2MB, and 1.44MB capacity all have 80 tracks. Because very few modern PCs have 40-track floppy drives, we recommend that you set this field to “Disabled” to save time.

- **Boot Up NumLock Status**

Toggle between “On” and “Off” to control the state of the NumLock key when the system boots. When toggled “On”, the numeric keypad generates numbers instead of controlling cursor operations.

- **Gate A20 Option**

Choose “Fast” (default) or “Normal”. “Fast” allows RAM access above 1MB to use the fast Gate A20 line.

- **Typematic Rate Setting**

When this function is disabled, the following two items (Typematic Rate and Typematic Delay) are irrelevant. Keystrokes repeat at a rate determined by the keyboard controller in your system. When this function is enabled, you can select a typematic rate and typematic delay.

- **Typematic Rate (Chars/Sec)**

When the Typematic Rate setting is enabled, you can select a typematic rate (the rate at which character repeats) when you hold down a key of “6”, “8”, “10”, “12”, “15”, “20”, “24” or “30” characters per second.

- **Typematic Delay (Msec)**

When the Typematic Delay setting is enabled, you can select a typematic delay (the delay before key strokes begin to repeat) of “250”, “500”, “750” or “1000” milliseconds.

- **Security Option**

If you have set a password, you can select whether the password is required while the system boots, or only when you enter “Setup”.

- **OS Select for DRAM > 64MB**

Select “OS2” only if you are running OS/2 operating system with more than 64 MB of RAM on your system.

- **Report No FDD For WIN 95**

Select “Yes” to release IRQ6 when there is no floppy disk drive, for compatibility with WIN 95 logo certification.

- **Delay For HDD (Secs)**

Generally, you can set this field as “0”, but for some old Hard Disk Drives, you may need to increase the delay time for BIOS to detect what type it is.

## 3.5 Advanced Chipset Features

This option will change the values of the chipset registers and the system setting will alter. Do not change any values if you are unfamiliar with the chipset.



- **SDRAM CAS Latency Time**

This controls the SDRAM performance: default is AUTO. BIOS will auto detect the SPD information of the Memory Module and choose the proper setting.

- **SDRAM Cycle Time Tras/Trc**

Select the number of SDRAM clocks used per access cycle. Settings available are 7/9 or 5/7.

- **SDRAM RAS-to-CAS Delay**

This controls the latency between SDRAM active command and the read/write command. Leave it on the default setting.

- **SDRAM RAS Precharge Time**

This controls the idle clocks after issuing a precharge command to SDRAM. Leave it on the default setting.

- **System BIOS Cacheable**

Selecting "Enabled" allows caching of the system BIOS. This action can increase system performance.

- **Video BIOS Cacheable**

Selecting "Enabled" allows caching of the video BIOS. This action can increase system performance.

- **Memory Hole At 15M-16M**

Enabling this feature reserves memory address space (between 15 and 16MB) to ISA expansion cards that specifically require this setting. This makes between 15 and 16MB of memory unavailable to the system. Expansion cards can only access memory up to 16MB.

The default setting is "Disabled".

- **CPU Latency Timer**

The option determines the way that 815 does with the deferrable processor cycle.

- **Delayed Transaction**

PCI access speed is faster than ISA. So PCI will release the master bus to the ISA interface for accessing data. Then the master bus control will go back to PCI again.

- **Display Cache Frequency**

100/133 MHz depends on your AIMM Card.

- **AGP Graphics Aperture Size**

The Aperture is a portion of the PCI memory address range dedicated for graphics memory address space. Access to the aperture range is forwarded to AGP without translation. Available options are 64MB and 32MB.

- **System Memory Frequency**

Default is Auto. When the CPU is 133MHz you can choose 100/133MHz, but when the CPU is 100MHz, only the 100MHz selection will work.

- **On-Chip Video Window Size**

You can select the size of mapped memory for the VGA/AGP driver to use. The choices: "64MB", "32MB", and "Disabled".

### Onboard Display Cache Setting (Only for AIMM)

This field is displayed only if there is AIMM Installed.

- **Initial Display Cache**

Select "Enabled" if you want to use the onboard display cache. The suggested selection is "Enabled".

- **CAS# Latency**

Set the CAS Latency of the onboard display cache memory.

- **Paging Mode Control**

Open or close the paging mode control of the onboard display cache memory.

- **RAS-to-CAS Override**

The default value, "by CAS# LT", will let this field have the same configuration as the value of the field "CAS# Latency". Another option, "Override (2)", will set the value of this field to 2.

- **RAS# Timing**

Set the RAS timing of the onboard display cache memory.

- **RAS# Precharge Timing**

Set the RAS precharge timing of the onboard display cache memory.

### 3.6 Integrated Peripherals

This option will load the default BIOS values. Choose the option and the following message appears.

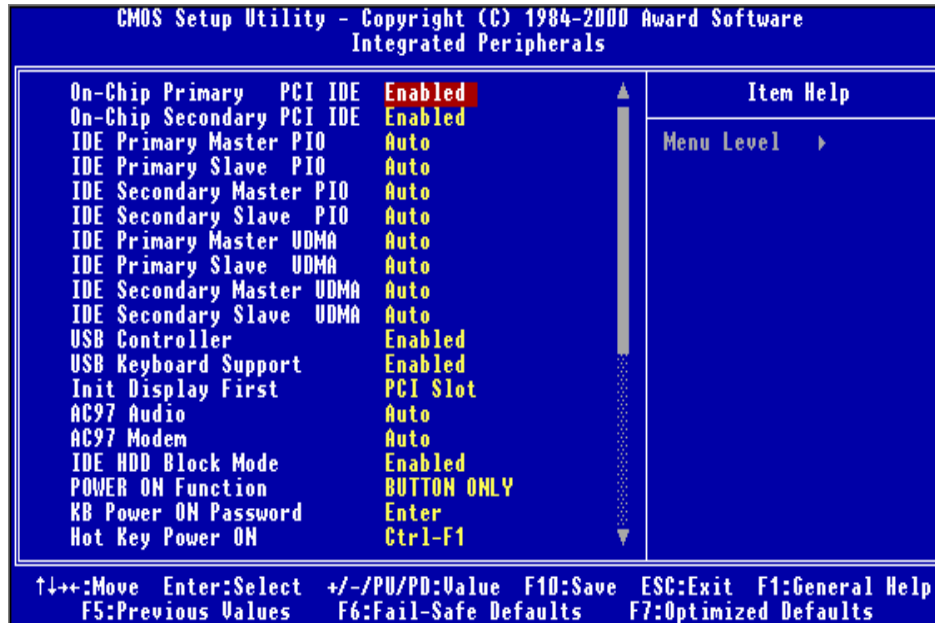

- **On-Chip Primary/Secondary PCI IDE**

The chipset contains a PCI IDE interface which supports two IDE channels. Select “Enabled” to activate the first and/or second IDE interface. Select “Disabled” to deactivate this interface when you install a primary and/or secondary add-in IDE interface.

- **IDE Primary/Secondary Master/Slave PIO**

The four IDE PIO (Programmed Input/Output) fields let you set a PIO mode (0-5) for each of the four IDE devices that the onboard IDE interface supports. Modes 0 through 5 provide successively increased performance. In “Auto” mode, the system automatically determines the best one for each device.



## • IDE Primary/Secondary Master/Slave UDMA

Ultra DMA/33/66/100 implementation is possible only if your IDE hard drive can support it, and if the operating environment includes a DMA driver (Windows 95 OSR2 or higher or a third-party IDE bus master driver). If both your hard disk drive and your system software can support Ultra DMA/33/66/100, select "Auto" to enable BIOS support.

## • USB Controller

Select "Enabled" if your system contains a Universal Serial Bus (USB) controller and USB peripheral(s).

## • USB Keyboard Support

Select "Enabled" if you use a USB Keyboard.

## • Init Display First

This item allows you to decide which to activate first: Onboard VGA/PCI/AGP.

## • AC97 Audio/MODEM

If you select "Enabled", BIOS will detect whether you are using Audio and/or Modem devices. When an Audio/MODEM device is detected, the onboard Audio/MODEM controller will be enabled. If you want to use your own Audio and or Modem card(s), set the field(s) to "Disabled". If not, set the field(s) to "Auto".

## • IDE HDD Block Mode

Block Mode is also called Block Transfer, Multiple Commands, or Multiple Sector Read/Write. If your IDE hard drive supports Block Mode (most newer drives do), select "Enabled" for automatic detection of the optimal number of Block Read/Write per sector the drive can support.

## • Power On Function

- Password: Power On only if you key in the correct password.
- Hot Key: You can use the hot key to Power On the system.
- Mouse Left: Power On with the Mouse Left Button.
- Mouse Right: Power On with the Mouse Right Button.

- Any Key: Press any key to Power On the system.
- Button only: Power On only by pushing the button on the case (Default).
- Keyboard 98: You can Power On the system with the [Power-On] key of Keyboard 98.

## ● **KB Power On Password**

Enter the Power On Password here. **Activated only when “Password” item is selected in the Power On Function Menu.**

**NOTE: If you want to use this function, please make sure that the “KB-AWK” jumper is set to “Enabled”.**

## ● **Hot Key Power On**

Choose [CTRL] +[ F1] ~ [F12] as a hot key to Power On the system. **Activated only when “Hot Key” is selected on the Power On Function Menu.**

## ● **Onboard FDC Controller**

You can use this function to enable or disable the onboard FDC controller.

## ● **Onboard Serial Port 1/Port 2**

Select an address and the corresponding interrupt for each of the first and second serial ports. The Choices: “Disabled”, “3F8/IRQ4”, “2F8/IRQ3”, “3E8/IRQ4”, “2F8/IRQ3”, and “Auto”. **The second serial port shares the resources (address and IRQ) with IrDA.**

## ● **UART Mode Select**

Choose the right type of infrared device:

- Normal: Normal operation
- IrDA: IrDA compliant serial infrared port
- ASKIR: Amplitude Shift Keyed Infrared Port

## ● **RxD, TxD Active**

Consult your IR peripheral documentation to select the combination of RxD and TxD.

## ● **IR Transmission Delay**

Consult your IR peripheral documentation to select “Enabled” or “Disabled” of the IR Transmission Delay.

## ● **UR2 Duplex Mode**

This item allows you to select the IR half/full duplex function.

---

## ● Use IR Pins

This option selects IR transmission routing. Two choices are:

RxD2,TxD2 -> COMB Connector

IR-Rx2Tx2 -> IR Connector

## ● Onboard Parallel Port

Select a logical LPT port name and matching address for the physical parallel (printer) port.

The choices: "378/IRQ7", "278/IRQ5", "3BC/IRQ7" and "Disabled".

## ● Parallel Port Mode

This field allows you to set the operation mode of the parallel port.

- SPP: Allows normal-speed operation, but in one direction only.

- EPP: Allows bi-directional parallel port operation at maximum speed.

- ECP: Allows DMA and bi-directional operation. It is faster than EPP mode.

- ECP + EPP: Allows normal speed operation in two-way mode.

## ● EPP Mode Select

Select EPP port type "1.7" or "1.9".

## ● ECP Mode Use DMA

Assign DMA channel "1" or "3" to the port for ECP mode operation.

## ● PWR-ON After PWR-Fail

Choose if you want the system to automatically Power On after the power has failed.

- Off: Disable this function

- On: Enable this function

- Former-Sts: Not only to Power On the system, but also to return it to its former status.

## ● Game Port Address

Set Joystick Game Port Address. The choices: "Disabled", "201", and "290"

## ● Midi Port Address

Set Midi Port Address. The choices: "Disabled", "330", "300" and "290"

## ● Midi Port IRQ

Assign IRQ 5 or 10 to the Midi Port.

### 3.7 Power Management Setup

The Power Management Setup allows you to configure your system to minimize energy consumption, according to your own style of computer use.



- **ACPI Function**

This item allows you to enable/disable the Advanced Configuration and Power Interface (ACPI).

- **ACPI Suspend Type**

Select the ACPI Suspend Type: “S1 (POS)” or “S3 (STR)”.

If your expansion cards do not support the STR function, you must leave this field on “S1 (POS)” setting. The STR (Suspend-to-RAM) is an energy-saving feature. It takes only a few seconds to wake up the system and return to the previous situation.

**NOTE: This feature (STR) requires an ATX power supply with at least 720mA + 5V standby power for ACPI functions. Otherwise, the system will fail to return from suspend mode.**

- **Power Management**

This category allows you to select the type (or degree) of power saving and is directly related to the following modes:

1. Suspend Mode
2. HDD Power Down

There are three selections for Power Management. Two of them have fixed mode settings.

1. Min. Power Saving:

Minimum power management mode. Inactivity period is defined below:

Suspend Mode = 1 hr.                      HDD Power Down = 15 min.

2. Max. Power Saving:

Maximum power management mode. Inactivity period is defined below:

Suspend Mode = 1 min.                      HDD Power Down = 1 min.

3. User Define:

Allows you to set each mode individually. Select the time-out period for each mode shown above.

- **Video Off Method**

Defines the Video Off features.

- Blank Screen:

- Only blanks the screen. Use this for monitors without power management and "green" features.

- V/H SYNC+BLANK:

- Blanks the screen and turns off vertical and horizontal scanning.

- DPMS:

- The DPMS (Display Power Management System) feature allows the BIOS to control the video display card if it supports the DPMS feature.

- **VIDEO Off In Suspend**

This determines the manner in which the monitor is blanked. Select "Yes" to blank the monitor when the system enters suspend mode.

- **Suspend Type**

Select Suspend Type: "Stop Grant" or "PWR ON Suspend".

- **MODEM Use IRQ**

You can select one of the following interrupt resources for modem use: "N/A", "3", "4", "5", "7", "9", "10", and "11".

- **Suspend Mode**

After the selected period of system inactivity (1 minute to 1 hour), all devices except the CPU will be shut down.

- **HDD Power Down**

After the selected period of system inactivity (1 to 15 minutes), the hard disk drive powers down while all other devices remain active. This feature doesn't effect SCSI hard drives.

- **Soft-Off by PWR-BTTN**

When set to "Instant-off", the ATX switch can be used as a normal system Power Off button. When set to "Delay 4 seconds", you need to press the Power-Off button down for more than 4 seconds if you want to Power Off the system.

- **Wake-Up by PCI & WOL**

Select "Enabled" if you want to Power On your system when a PCI or LAN event occurs.

- **Power On by Ring**

Select "Enabled" to Power On your system when the external Modem receives a call.

**NOTE: This function requires an external Modem which supports the Ring Wake-Up function.**

- **CPU Thermal-Throttling**

Select the CPU Thermal-Throttling rate. If BIOS detects that the CPU temperature is too high, it will slow down the CPU's speed according to this field. The choices: "87.5%", "75.0%", "62.5%", "50.0%", "37.5%", "25.0%" and "12.5%".

- **Resume by Alarm**

Select "Enabled" if you want to power up your system at a certain time on the same day every month or at a certain time every day.

- **Date/Time**

Set the Date and Time to Power On the system. **Activated only when the "Resume by Alarm" field is enabled.**

- **Reload Global Timer Events**

When "Enabled", an event occurring on any device listed below restarts the global timer from Standby Mode, and Powers On the system.

- Primary IDE 0
- Primary IDE 1
- Secondary IDE 0
- Secondary IDE 1
- FDD, COM, LPT Port
- PCI PIRQ[A-D]#

The settings in these fields enable or disable the detection of IDE, floppy, serial and parallel port activities for powering down state transition. Actually it detects the read/write to/from I/O ports.

### 3.8 PnP/PCI Configuration Setup



- **Reset Configuration Data**

Normally, you leave this field “Disabled”. Select “Enabled” to reset Extended System Configuration Data (ESCD) if you have just installed a new add-on card and the system reconfiguration has caused such a serious conflict that the operating system cannot boot. The setting will automatically be set back to “Disabled” the next time the system reboots.

- **Resources Controlled by**

The Award Plug and Play BIOS can automatically configure all the boot and Plug and Play (PnP) compatible devices. If you select “Auto”, all of the Interrupt Requests (IRQs) and DMA assignment fields will be activated as the BIOS automatically assigns them. The choices: “Auto” and “Manual”.

## • IRQ Resources

```

CMOS Setup Utility - Copyright (C) 1984-1999 Award Software
IRQ Resources

IRQ-3 assigned to PCI/ISA PnP
IRQ-4 assigned to PCI/ISA PnP
IRQ-5 assigned to PCI/ISA PnP
IRQ-7 assigned to PCI/ISA PnP
IRQ-9 assigned to PCI/ISA PnP
IRQ-10 assigned to PCI/ISA PnP
IRQ-11 assigned to PCI/ISA PnP
IRQ-12 assigned to PCI/ISA PnP
IRQ-14 assigned to PCI/ISA PnP
IRQ-15 assigned to PCI/ISA PnP

Item Help
Menu Level  >>
Legacy ISA for devices
compliant with the
original PC AT bus
specification, PCI/ISA
PnP for devices
compliant with the
Plug and Play standard
whether designed for
PCI or ISA bus
architecture

↑|←→:Move  Enter:Select  +/-/PU/PD:Value  F10:Save  Esc:Exit  F1:General Help
F5:Previous Values  F6:Fail-Safe Defaults  F7:Optimized Defaults

```

### • IRQ-n Assigned to

When the resources are controlled manually, assign each System Interrupt to one of the following, depending on which type of device is using the interrupt.

- Legacy ISA Devices requiring a specific interrupt (such as IRQ4 for serial port1), compliant with the original PC AT bus specification.
- PCI/ISA PnP devices, whether designed for PCI or ISA bus architecture, compliant with the Plug and Play standard.

### • PCI/VGA Palette Snoop

Some VGA cards, such as graphics accelerators or MPEG video cards, might not show colors properly. Select "Enabled" to correct this problem. If you don't have such problems, leave this field at "Disabled".

### • PCI n Assignment

Each PCI Slot can assign its own IRQ number. When you assign one and find out that the real IRQ is different from your assignment, the IRQ you assign must be taken over by another device like Printer, USB Controller, Midi, etc.



## 3.9 PC Health Status

This menu provides two thermo-protect functions (CPU warning temperature and shutdown temperature) and a hardware monitor center. These features let you know the health status of your PC.

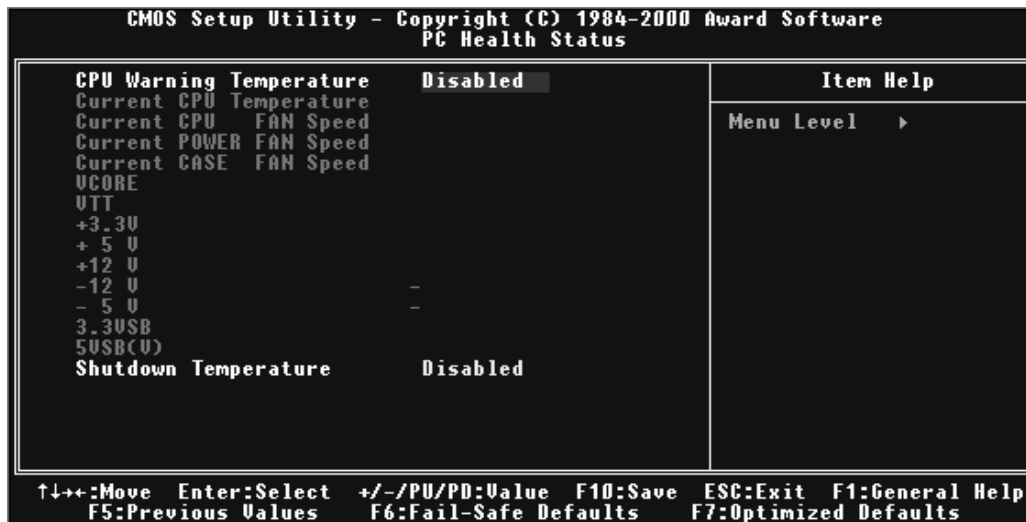

- **CPU Warning Temperature**

This field allows you to set the CPU warning temperature. You can choose from “50°C/122°F” to “70°C/158°F” or even “Disabled” if you like.

- **Current CPU/System Temperature**

These two fields display the CPU and the onboard system temperature.(For FC-PGA CPU only)

- **Current CPU/Power/Case Fan Speed**

These fields display the fan speeds for each of the fans - CPU, Power and Case.

- **VCORE**

This field displays the CPU working voltage.

- **VTT**

This field displays the GTL bus voltage.

- **+3.3V/+5V/+12V/-12V/-5V**

These fields show the power supply voltages.

- **3.3VSB/5VSB(V)**

This field displays the 3.3V/5V standby power supplied to the CMOS battery.

- **Shutdown Temperature**

This field allows you to set the CPU shutdown temperature.

The choices: "60°C/140°F", "65°C/149°F", "70°C/158°F" and "75°C/167°F".

### 3.10 Frequency/Voltage Control



- **CPU Vcore Select**

This option adjusts the CPU voltage.

Available selections are Default/+0.05V/+0.1V/+0.2V/+0.3V/+0.4V/-0.05V/-0.1V

- **Auto Defect DIMM/PCI Clk**

"Enable" can stop the frequency output for unused DIMM/PCI slots.

- **Spread Spectrum Modulated**

"Enable" provides spread Sepectrum for better EMI solution.

- **Clock By Slight Adjust**

This function allows you to set the FSB frequency of the CPU and the speed of PCI bus. When JP4 is set to Auto, the frequency setting depends on your CPU type. When JP4 is set to 66MHz, you can select the system bus frequency from 66MHz to 99 MHz. When JP4 is set to 100MHz, you can select the system bus frequency from 100MHz to 132MHz. When JP4 is set to 133MHz, you can select the system bus frequency from 133MHz to 166MHz. When you overclock the CPU too much, some devices on the motherboard might not function well, like onboard CODEC. When this situation happends, reduce the frequency.

- **CPU Ratio**

This function allows you to set the CPU internal frequency ratio. It determines the CPU internal frequency according to the following formula:

**CPU internal frequency = frequency ratio x system bus frequency.\***

\* System bus frequency is set in the previous field ("CPU Host/PCI Clock").

The choices: "3", "3.5", "4", "4.5", "5", "5.5", "6", "6.5", "7", "7.5", and "8" or "8.5", "9", "10", "10.5", "11", "11.5", "12". The two different tables depend on your CPU type.

**NOTE: Because Intel has locked the frequency ratio for new CPU settings, this field to adjust the frequency ratio is usually useless. However, it is effective for older version CPUs.**

### 3.11 Load Fail-Safe Defaults

This option allows you to load the troubleshooting default values permanently stored in the BIOS ROM. **NOTE:** These default settings are non-optimal and disable all high performance features.

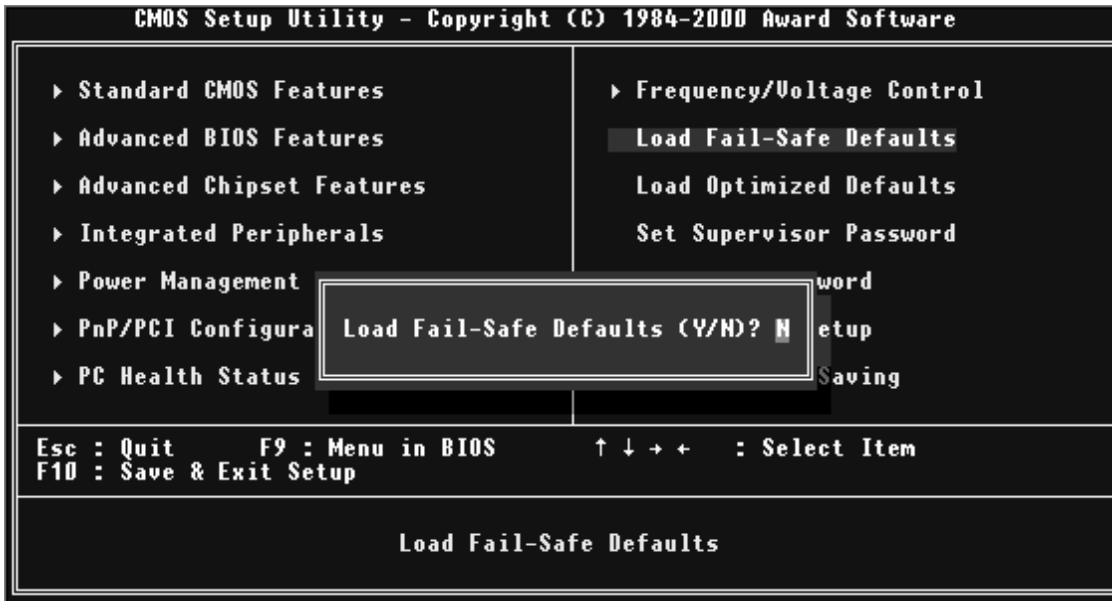

### 3.12 Load Optimized Defaults

This option allows you to load the default values to the system configuration fields. These default values are the optimized configuration settings for the system.

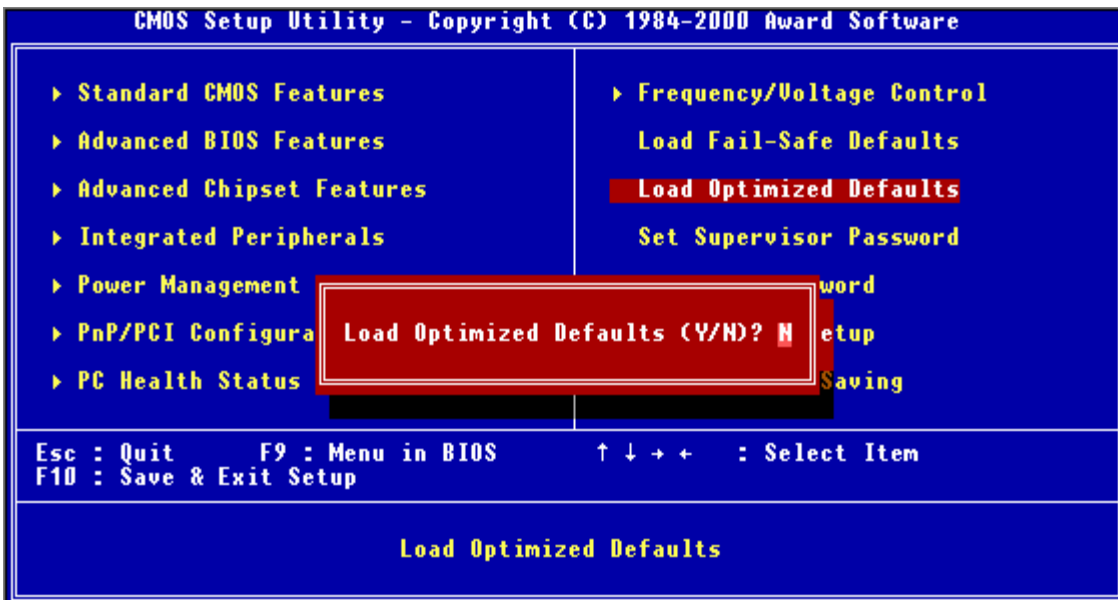

## 3.13 Supervisor Password

This option allows you to set a password to prevent others from changing the BIOS setting of your system.

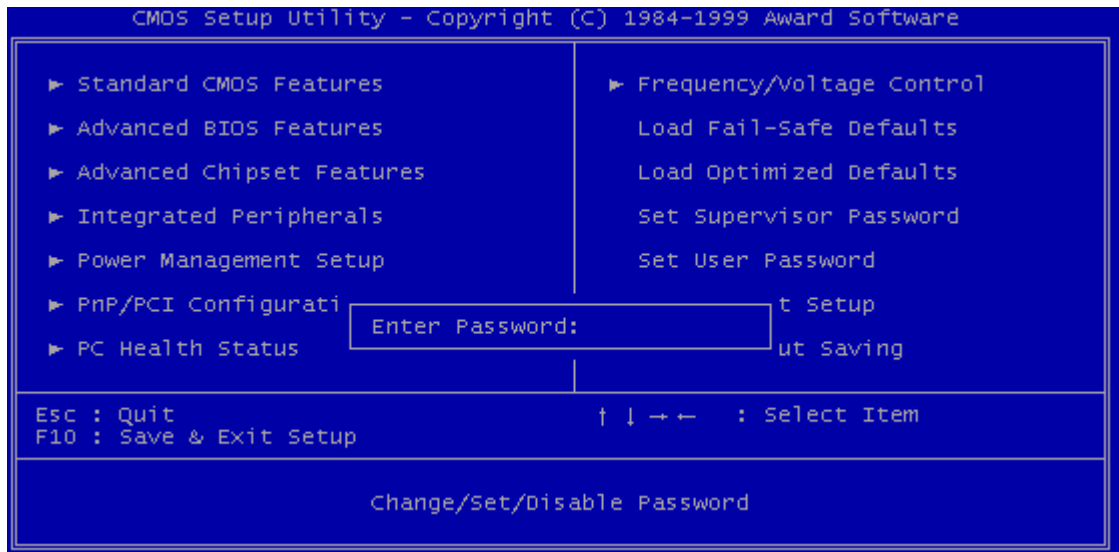

The password prevents any unauthorized use of your computer. If you set a password, the system prompts for the correct password before you boot or access “Setup”.

### To set a password:

1. At the prompt, type your password. Your password can be up to 8 alpha-numeric characters. When you type the characters, they appear as asterisks (\*) on the password screen box.
2. After typing the password, press [Enter] key.
3. At the next prompt, re-type your password and press [Enter] key again to confirm the new password. After the password entry, the screen automatically reverts to the main screen.

To disable the password, press [Enter] key when prompted to enter the password. The screen displays a message confirming that the password has been disabled.

### Forget the password?

If you forget the password, you can clear it by erasing the CMOS Real Time Clock (RTC) RAM with jumper 1 (CMOS\_CLR). To erase the RTC RAM:

1. Unplug your computer.
2. Set the JP1 to “CMOS\_CLR” for about 10 seconds, and then to the default setting.
3. Turn on your computer.
4. Hold down [Delete] key during the POST process and enter BIOS setup to reconfigure BIOS.

## 3.14 User Password

This option allows you to set a password to prevent others from changing the BIOS setting of your system. This operation is the same as Supervisor Password.

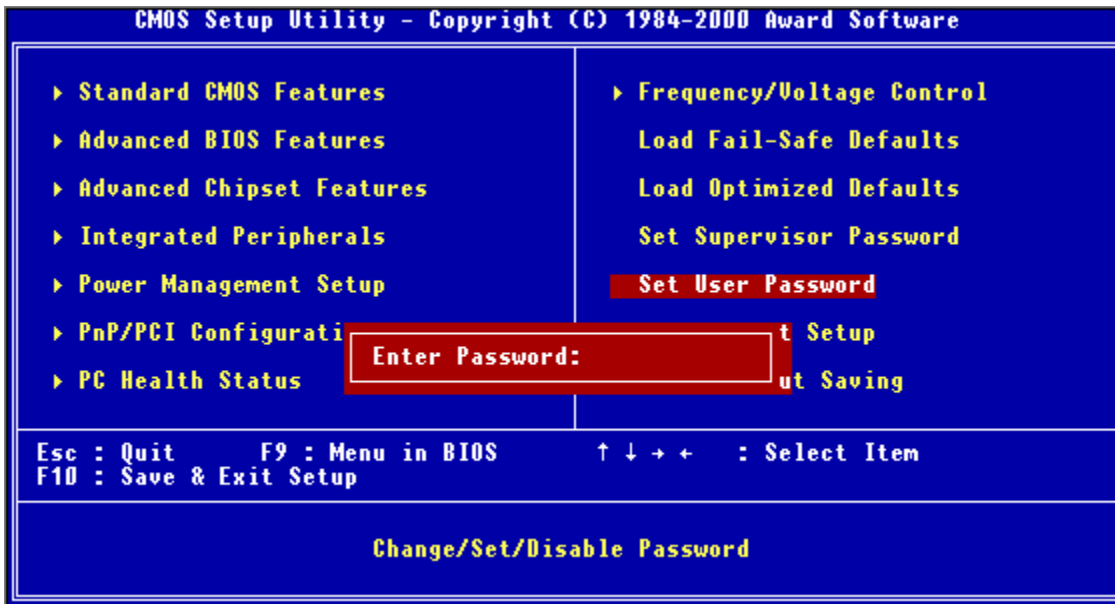

## 3.15 Save & Exit Setup

Save the settings and exit the BIOS utility.

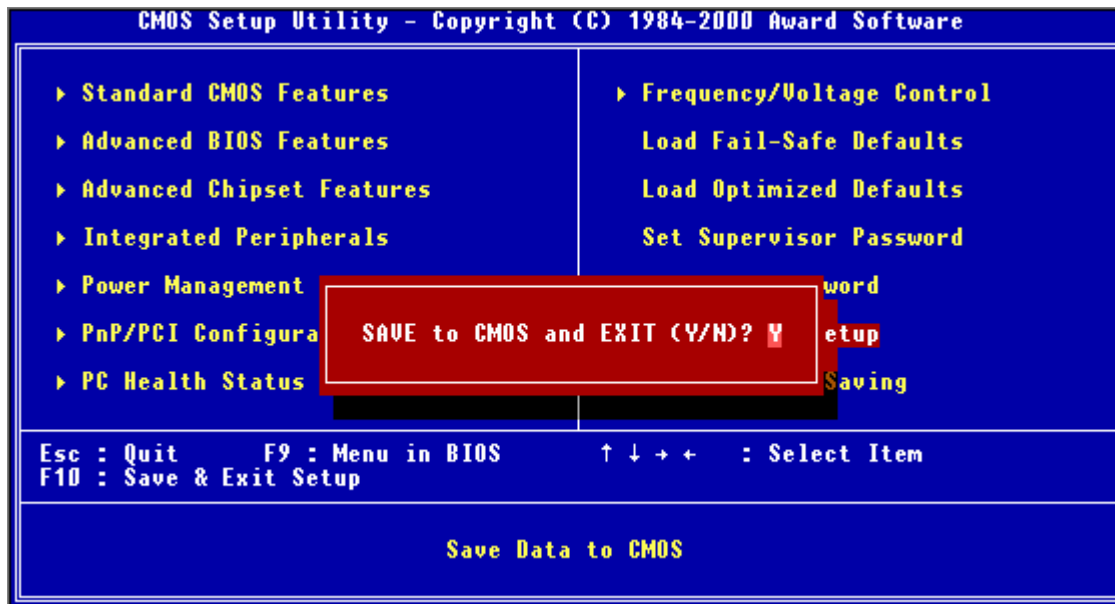

## 3.16 Exit Without Saving

Abort current changes and exit the BIOS utility.

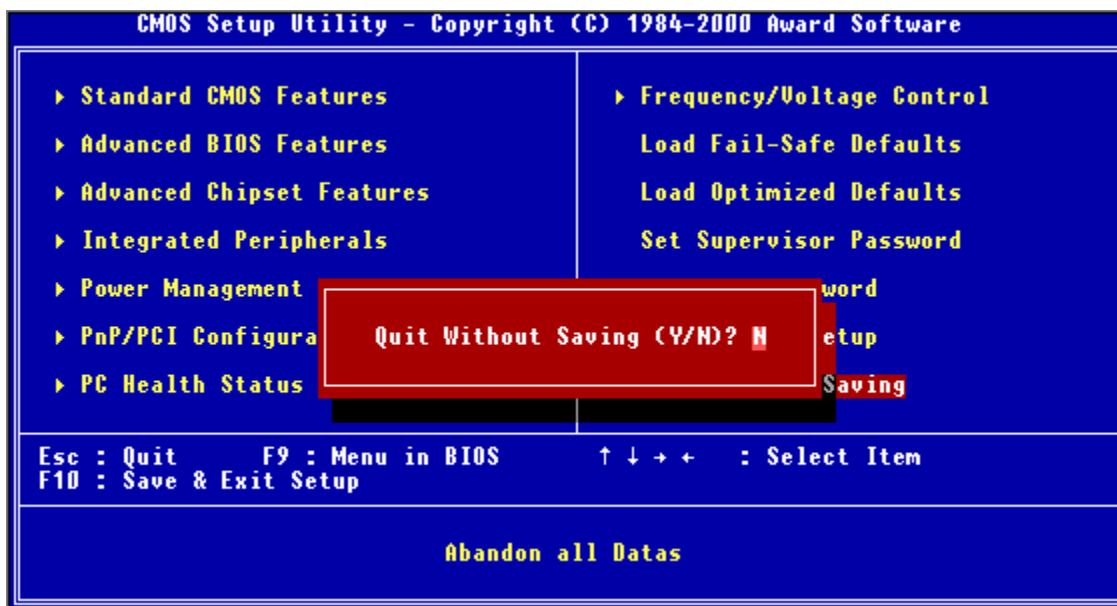

## CHAPTER 4 SOFTWARE SETUP

Insert the CD-ROM enclosed with your motherboard into the CD-ROM drive. After the autorun program has executed, please check the model name shown on the screen. If the model name doesn't match your motherboard model name, please select the correct one.

### 4.1 INF Update for 815E Chipset

This section introduces INF files in Windows 95/98 for the following items: System and Graphics, LPS Interface, SM Bus, PCI Bridge, Bus Master IDE, USB Host, and Controllers. Click **INF Update Utility for Intel 81X chipset** and follow the figures as shown below.



1 Click here

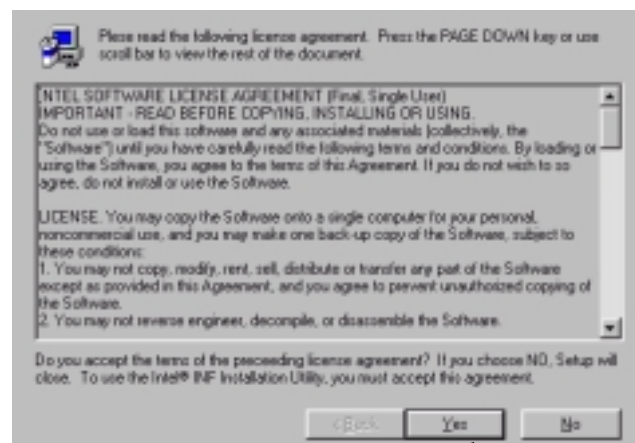

2 Click here

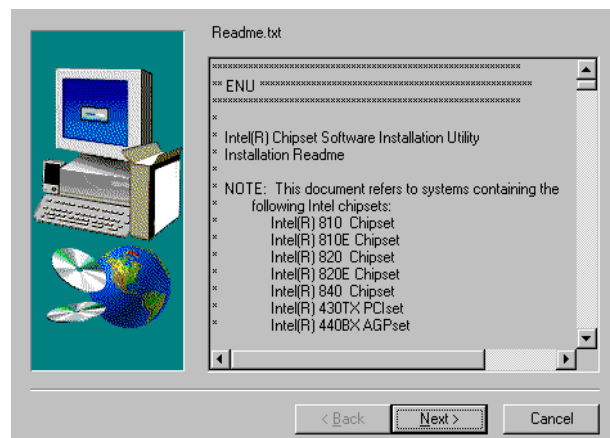

3 Click here

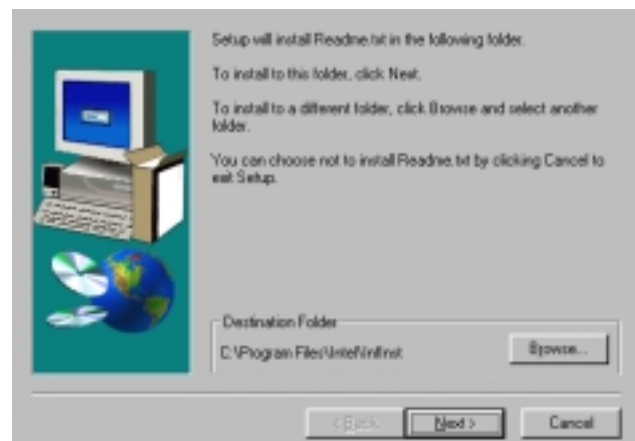

4 Click here



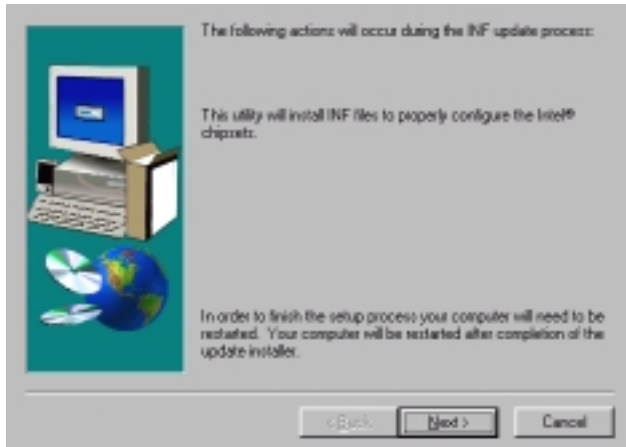

5 Click here

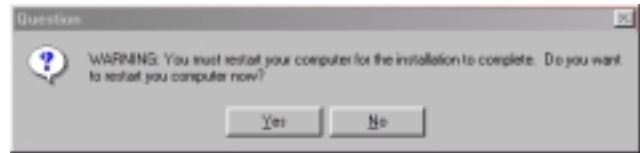

6 Click here

## 4.2 VGA Driver Setup

This section introduces Intel 815 system and graphics controller Driver. Click [VGA Driver Setup](#) and the follow the figures as shown below:

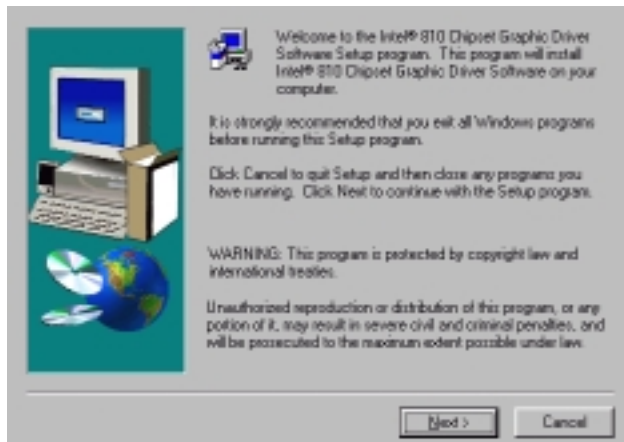

1 Click here

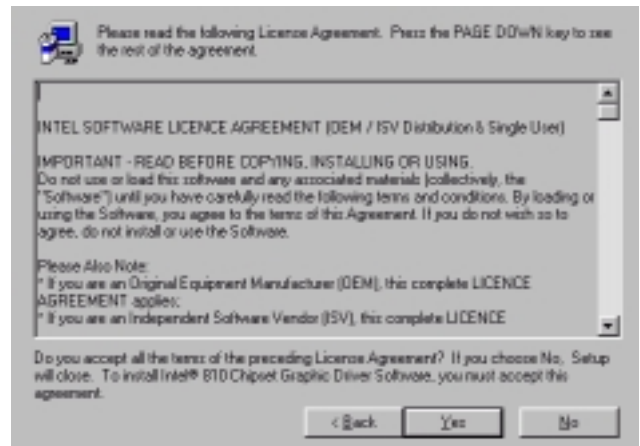

2 Click here

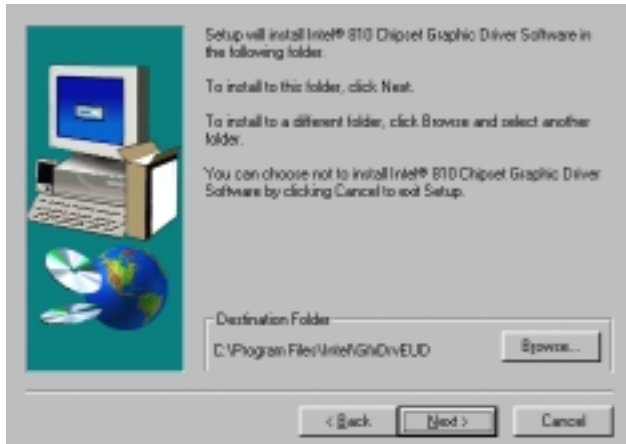

3 Click here



4 Click here

### 4.3 Intel Security Controller Driver

This section helps you to install a security controller for Windows 95/98. Click **Security Driver Setup** and follow the figures as shown below:

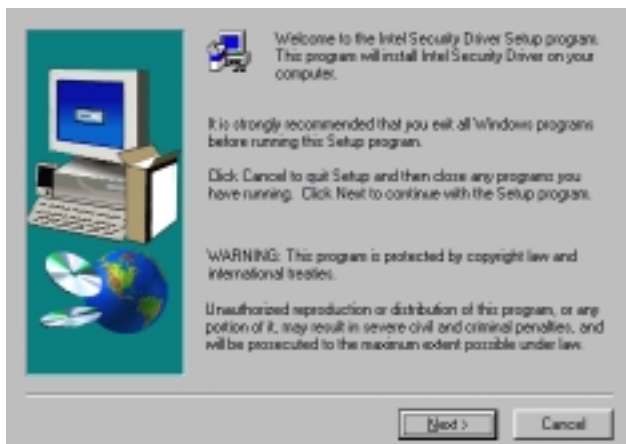

1 Click here

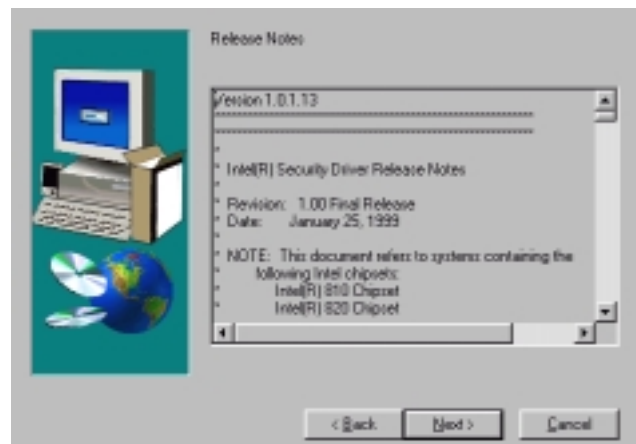

2 Click here

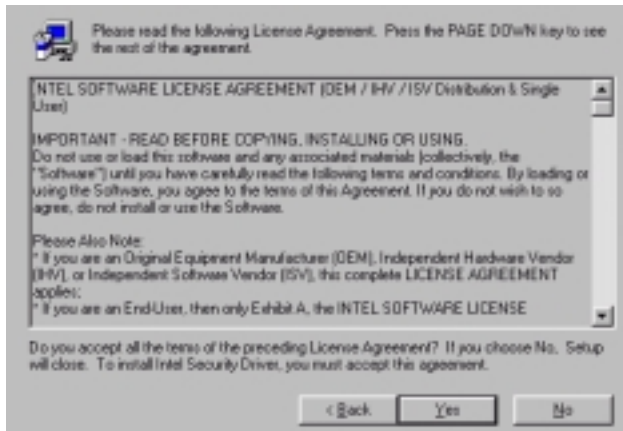

3 Click here

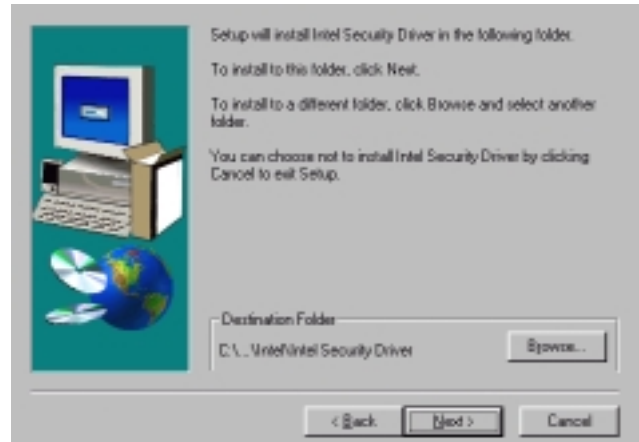

4 Click here

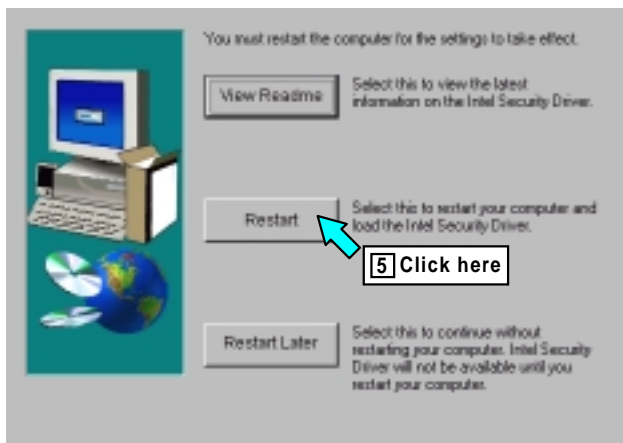

5 Click here

## 4.4 Audio Driver Setup

This section helps you to setup the onboard audio device. Click **Audio Driver Setup** and choose the operation system you use.

### A. Audio Driver for Windows 95/98/2000

The figures follow are captured from Windows 98SE. You can setup the Audio CODEC in almost the same way in Windows 95 and Windows 2000.

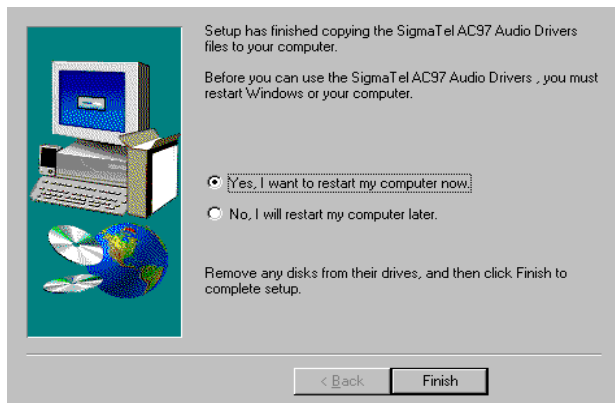
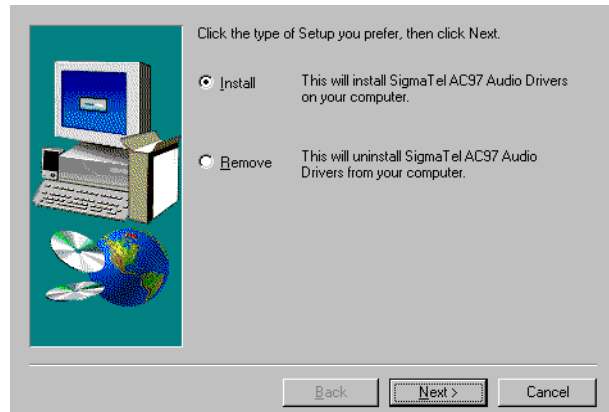
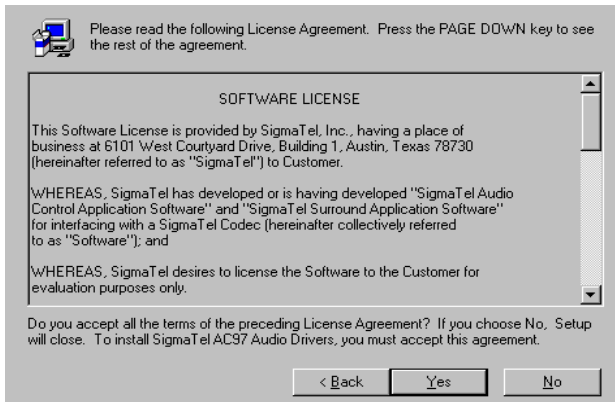
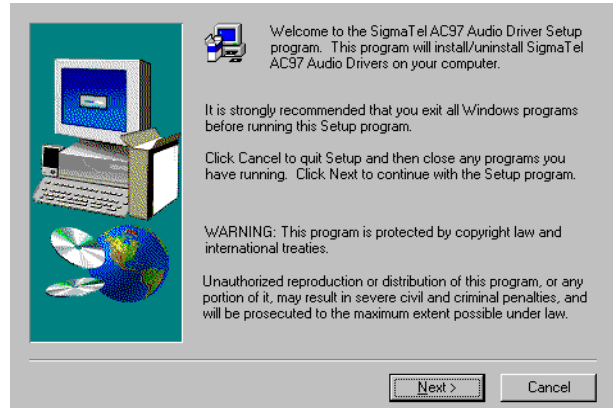
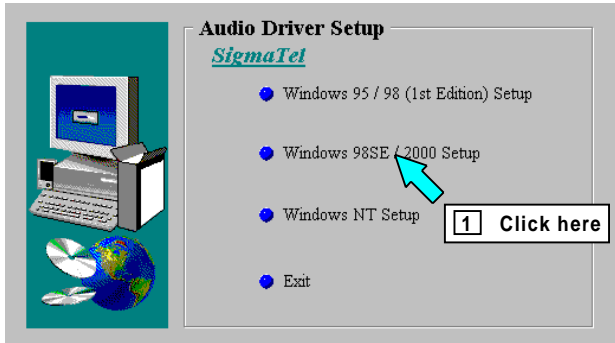

## B. Audio Driver for WindowsNT

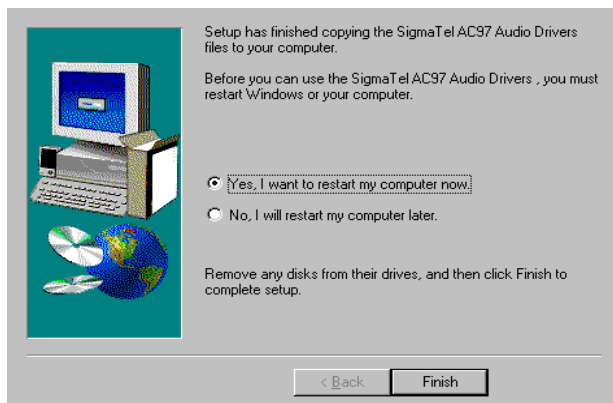
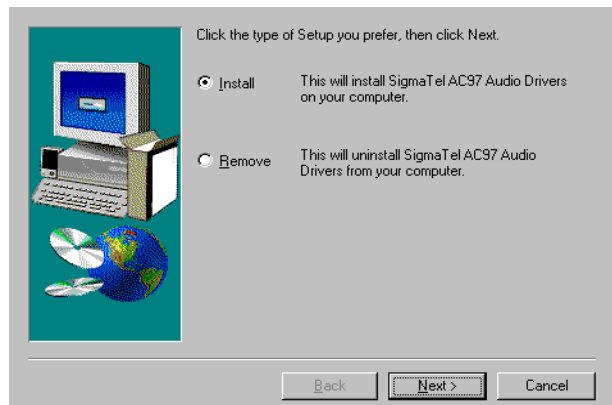
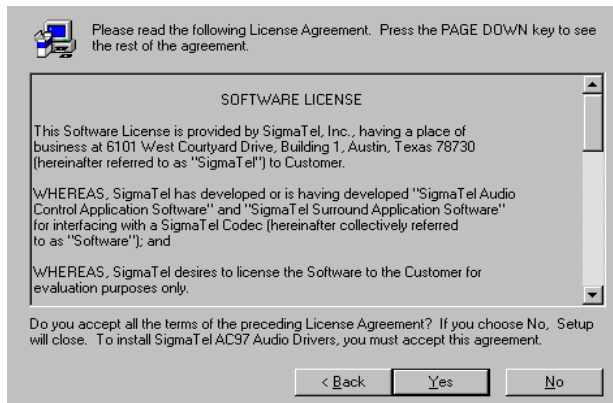
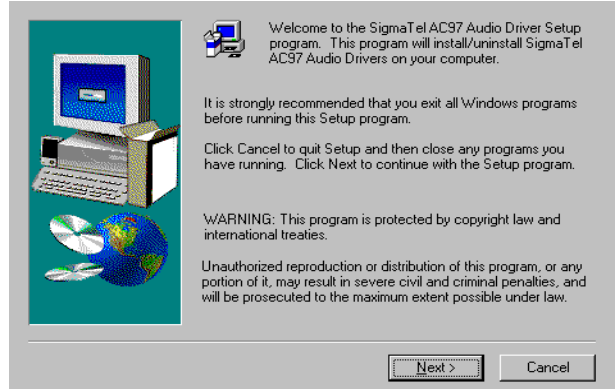
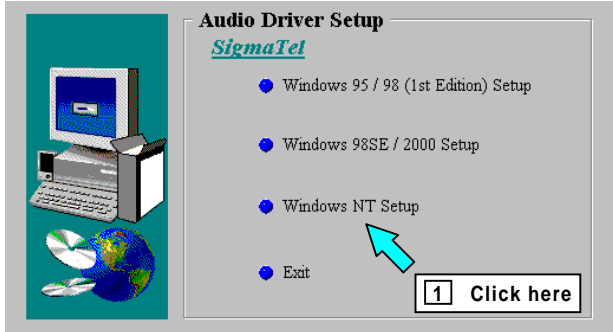

# SOFTWARE SETUP

---

## CHAPTER 5 BIOS UPGRADE

### Caution!

Only users familiar with the BIOS upgrade procedure are recommended to update the BIOS of the motherboard, and only when there is a need to do so. Please note that you must download and install the correct file for your motherboard or you may cause serious system malfunctions.

### 5.1 How to Check Your BIOS File Name and Version

Please turn on PC. The screen will display as follows (For example):

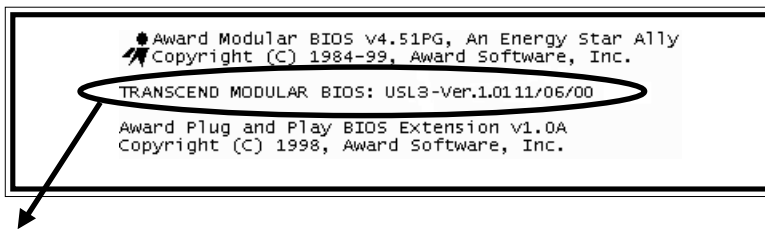

TRANSCEND MODULAR BIOS : USL3-Ver.1.01 11/06/00.

You can see the BIOS description on the third line.

USL3 - Ver 1.01 11/06/00

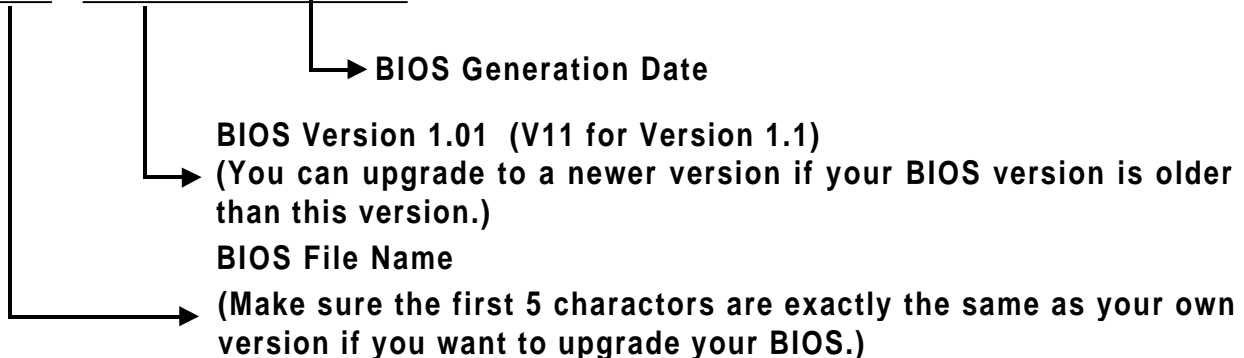

### 5.2 How to Download the Correct BIOS File from the Web

Please enter the Transcend website on: <http://www.transcendusa.com/>

On the front page, click on the "Motherboard" icon, which is the second one down. On the Motherboard page, click on the "BIOS" icon near the top. The BIOS page contains important information. Please take the time to read it carefully. Then go to the bottom of the BIOS page, click on "Slot 1" and choose your motherboard model.

Your BIOS file name must absolutely match the one shown on our web site. Download the suitable version to your disk.

**Warning : Your system could be damaged if the wrong BIOS version is accidentally used. If you are not sure what version you should choose, please contact us at: [techsupport@transcend.com.tw](mailto:techsupport@transcend.com.tw)**

## 5.3 How to Upgrade Your Motherboard BIOS

Please follow these 5 steps listed below to upgrade your BIOS.

Step 1: Make a record of your original or existing BIOS Setup parameters.

- Press [Del] during the Power On Self Test to enter BIOS Setup Program when you start your system.
- Write down the value of each parameter in order to reconfigure your system after BIOS updating.

Step 2: Make a System Disk

- Put a clean 3.5" disk in Drive A

MS-DOS: Key in **Format A:/S** and press [Enter].

Windows O/S: Select the **My Computer** icon.

Click [3.5" Floppy (A:)]

Select [File/Format] from Command Bar

Under **Format 3.5** Floppy (A:) **Menu** select

Format type = Full item, and

Other Options = Copy system files

Click [Start] button

Step 3: Download the updated **Bios.exe** file from the web site to a floppy disk.

(Ref 5.1 and 5.2)

Step 4: Type Bios.exe to decompress it.

Step 5: Please read the file **Readme.txt** carefully, and follow the instructions step by step.

Finish the BIOS upgrade.

Adapter Supplemental Information (For TS-USL3/N,TS-USP3/N only)

Server Adapter and Client Adapter Supplemental Information

=====

NOTE: For complete information on installing Intel network adapters,  
see the file\DRIVER\INTELLAN\MANUALS\GUIDE.PDF.

Readme Files for Windows"NT",NetWare",Unix,and Other Operating Systems.

=====

For more information on installing drivers for Windows NT 4.0, NetWare,  
and Unix, see the following files:

|                               |                                |
|-------------------------------|--------------------------------|
| Microsoft Windows             | .....\INFO\MS\MS.TXT           |
| Novell NetWare                | .....\INFO\NETWARE\NETWARE.TXT |
| SCO OpenServer                | .....\UNIX\SCO5\README.TXT     |
| SCO UnixWare 2.1              | .....\UNIX\UW2\README.TXT      |
| SCO UnixWare 7.x DDI 7 driver | .....\UNIX\UW7\README.TXT      |
| SCO UnixWare 7.x DDI 8 driver | .....\UNIX\UW7DDI8\README.TXT  |
| Other Operating Systems       | .....\INFO\OTHER\OTHER.TXT     |

Use any standard text editor or word processor to read, search, or print the files. These files are also viewable with the DOS Text Viewer in Setup. To use the viewer, type: SETUP /README at the DOS prompt.

Server Adapter Teaming Features

=====

Server adapters support advanced teaming features:

- Adapter Fault Tolerance (AFT)
- Adaptive Load Balancing (ALB)
- Fast EtherChannel\* (FEC)

For more information on these teaming features and how to set up teaming on specific adapters, see the file TEAMING.TXT in the \INFO\GENERAL directory.



## VLANS on PRO/100 Adapters

=====

A VLAN is a logical grouping of network devices put together as a LAN regardless of their physical grouping or collision domains. VLANs let a user see and access only specified network segments. This optimizes network efficiency and maintains security access restrictions. VLANs require special switches that are capable of supporting VLANs. All PRO/100+, PRO/100 S PCI and PRO/1000 adapters currently support VLANs when attached to a VLAN enabled switch. The PRO/100 VE and VM Desktop Adapters and Network Connections do not support VLANs.

A VLAN offers you the ability to group users and client PCs together into logical workgroups, a critical consideration when connecting clients to servers that are geographically dispersed across the building, campus, or enterprise network.

Typically, VLANs consist of a common set of coworkers within the same department but in different locations, a cross-functional team working on a joint project, or a diverse set of users sharing the same network application. Joining workers across the network forms logical working groups.

By using VLANs on your network, you can:

- Improve network performance
- Limit broadcast storms
- Improve adds, moves, and changes
- Minimize security problems
- Ease your management task

For overview information on Intel VLANs, visit the Intel Networking Web site:

<http://www.intel.com/network>

For more specific information, read the white paper on VLANs:

[http://www.intel.com/network/tech\\_brief/virtual\\_lans.htm](http://www.intel.com/network/tech_brief/virtual_lans.htm)

## Making Floppy Disks for NetWare and Windows Installation

=====

If you need to use a floppy disk to install the adapter drivers, use the MAKEDISK.BAT utility located in the \MAKEDISK directory on this CD.

MAKEDISK [operating system] [destination]  
where [operating system] is the OS for which you are creating the diskette, and [destination] is the drive letter and path (such as A:). If no destination is specified, the A: drive will be used.

The possible [operating system] options are:

NT = Microsoft Windows NT

W2K = Microsoft Windows\* 2000

W95 = Microsoft Windows 95

W98 = Microsoft Windows 98

NW = Novell NetWare servers and clients

DOS = Microsoft DOS and IBM OS

Make sure you have a 1.44 MB formatted, non-bootable diskette in the floppy drive when using this utility.

NOTE: This utility MUST be run from the \MAKEDISK directory.

Alternately, you can use the following .BAT files (located in the root directory on this CD) to simplify this process:

MAKEW95.BAT -- Creates a drivers disk for Windows 95.

MAKEW98.BAT -- Creates a drivers disk for Windows 98.

MAKENT.BAT -- Creates a drivers disk for Windows NT.

MAKEW2K.BAT -- Creates a drivers disk for Windows 2000.

MAKENW.BAT -- Creates a drivers disk for Novell NetWare servers and clients.

## Management Adapters

=====

For more information on the Management adapters, see the file MANAGE.TXT in the \INFO\GENERAL directory.

## DMI and SNMP Software Support

=====

This adapter provides Desktop Management Interface 2.0 and SNMP capability for your Management applications. Software for DMI and SNMP is located in the \dmi-snm directory on this CD.

For DMI-SNMP information for NetWare, see the dminet.txt file in the \dmi-snm\nwserver directory

owners.

For DMI-SNMP information for Windows NT, see the dmiwin.txt file in the \dmi-snm\win32 directory

## Push Installations

=====

If you are a network administrator interested in unattended installation of the adapter drivers (push installation), see the following readme files:

Windows 95/98...\push\win9x\w9xpush.txt

Windows NT.....\info\ms\ntpsh.txt

## Free Manuals Download Website

<http://myh66.com>

<http://usermanuals.us>

<http://www.somanuals.com>

<http://www.4manuals.cc>

<http://www.manual-lib.com>

<http://www.404manual.com>

<http://www.luxmanual.com>

<http://aubethermostatmanual.com>

Golf course search by state

<http://golfingnear.com>

Email search by domain

<http://emailbydomain.com>

Auto manuals search

<http://auto.somanuals.com>

TV manuals search

<http://tv.somanuals.com>