

Transition Networks
CPSMC08xx-100
8-Slot *PointSystem*™ Chassis

User's Guide
revision B

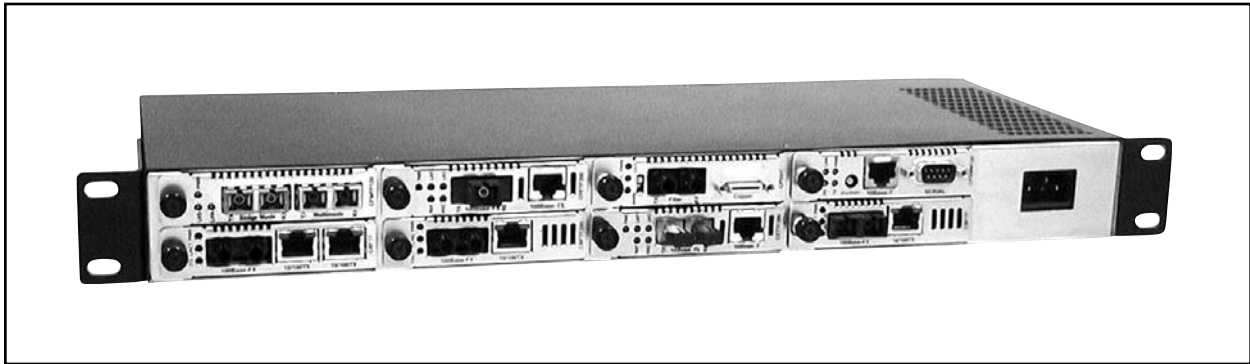

CPSMC0800-100 AC-powered
CPSMC0810-100 DC-powered

Compliance Information

CISPR22/EN55022 Class A + EN55024

CE Mark

FCC Regulations

This equipment has been tested and found to comply with the limits for a Class A digital device, pursuant to part 15 of the FCC rules. These limits are designed to provide reasonable protection against harmful interference when the equipment is operated in a commercial environment. This equipment generates, uses, and can radiate radio frequency energy and, if not installed and used in accordance with the instruction manual, may cause harmful interference to radio communications. Operation of this equipment in a residential area is likely to cause harmful interference, in which case the user will be required to correct the interference at the user's own expense.

Canadian Regulations

This digital apparatus does not exceed the Class A limits for radio noise for digital apparatus set out on the radio interference regulations of the Canadian Department of Communications.

Le présent appareil numérique n'émet pas de bruits radioélectriques dépassant les limites applicables aux appareils numériques de la Class A prescrites dans le Règlement sur le brouillage radioélectrique édicté par le ministère des Communications du Canada.

European Regulations

Warning

This is a Class A product. In a domestic environment this product may cause radio interference in which case the user may be required to take adequate measures.

Achtung !

Dieses ist ein Gerät der Funkstörgrenzwertklasse A. In Wohnbereichen können bei Betrieb dieses Gerätes Rundfunkstörungen auftreten. In diesem Fall ist der Benutzer für Gegenmaßnahmen verantwortlich.

Attention !

Ceci est un produit de Classe A. Dans un environnement domestique, ce produit risque de créer des interférences radioélectriques, il appartiendra alors à l'utilisateur de prendre les mesures spécifiques appropriées

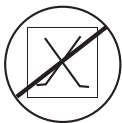

CAUTION: THE RJ CONNECTORS ON THE INDIVIDUAL MEDIA CONVERTER SLIDE-IN-MODULES ARE NOT INTENDED FOR CONNECTION TO THE PUBLIC TELEPHONE NETWORK. Failure to observe this caution could result in damage to the public telephone network.

Der Anschluss dieses Gerätes an ein öffentliches Telekommunikationsnetz in den EG-Mitgliedstaaten verstößt gegen die jeweiligen einzelstaatlichen Gesetze zur Anwendung der Richtlinie 91/263/EWG zur Angleichung der Rechtsvorschriften der Mitgliedstaaten über Telekommunikationsendeinrichtungen einschliesslich der gegenseitigen Anerkennung ihrer Konformität.

Trademark Notice

All trademarks and registered trademarks are the property of their respective owners.

Copyright Restrictions

© 2003 - 2004 Transition Networks.

All rights reserved. No part of this work may be reproduced or used in any form or by any means – graphic, electronic, or mechanical – without written permission from Transition Networks.

Printed in the U.S.A.

33270.B

Table of Contents

1	Introduction	4
1.1	Description	4
1.2	Unpacking the CPSMC08xx-100 Equipment	5
2	Slide-in-Modules	6
2.1	Media Converter Slide-in-Modules	6
2.1.1	Chassis Face Plates	
2.1.2	Calculating Power Consumption	6
2.1.3	Installing Media Converter Slide-in-Modules	7
2.1.4	Replacing Media Converter Slide-in-Modules	8
2.2	Management Modules	9
2.2.1	Three Types of Management Modules	9
2.2.2	Installing the Management Modules	10
2.2.3	Replacing the Management Modules	11
3	Powering the CPSMC08xx-100	12
3.1	Primary Power Supply	12
3.1.1	AC Power Supply	12
3.1.2	DC Power Supply	13
3.2	Auxiliary Power Supply	14
3.2.1	AC Auxiliary Power Supply	14
3.2.2	DC Auxiliary Power Supply	15
4	CPSMC08xx-100 Chassis	16
4.1	Installing the CPSMC08xx-100 Chassis	16
4.1.1	Table-Top Installation	16
4.1.2	Standard 19-Inch Rack Installation	16
4.1.3	Grounding Lugs	18
4.2	Cascade Option	19
4.3	Connecting the Slide-in-Modules to the Network	21
4.4	Operation	21
5	Network Management	22
5.1	Hardware Connections	22
6	Troubleshooting	24
	Technical Specifications	25
	Cable Specifications	26
	Contact Us	28
	Warranty	29

1 Introduction

1.1 Description

The Transition Networks *PointSystem*™ CPSMC08xx-100 is a 19-inch, rack-mountable chassis for selected Transition Networks media converter slide-in-modules. The chassis allows the network administrator to connect various copper and fiber-optic network media over protocols that include Ethernet, Fast Ethernet, DS3/E3, and OC-12. The chassis provides installation space for up to eight (8) single-slot or four (4) dual-slot media converter slide-in-modules in the front of the unit.



The CPSMC0800-100 comes equipped with an AC power supply. The CPSMC0810-100 comes equipped with a DC power supply. An optional, auxiliary AC or DC power supply with instant fail over operation is also available for either model. The primary power supply is accessed through the power inlet on the front panel, while auxiliary power is accessed through the auxiliary power inlet, located on the back panel.

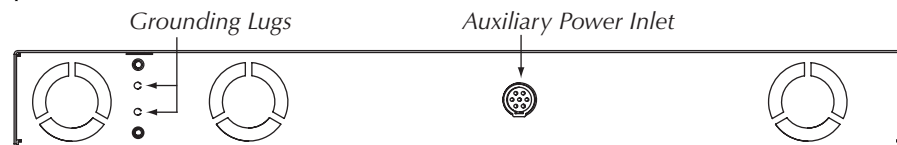

The CPSMC08xx-100 also comes equipped with a pair of grounding lugs for providing proper grounding of the chassis.

Multiple fans help remove heat from the chassis.

With installed *PointSystem*™ management module(s) (P/N CPSMM-120, -200, or -210), the CPSMC08xx-100 can be managed and monitored via:

- An SNMP application such as Transition Networks *FocalPoint*™ management software installed at a remote Network Management Station (NMS).
- A remote Web browser.
- A command-line interface (CLI) at an attached terminal.
- A command-line-interface (CLI) at a remote Telnet connection.

The management modules also make it possible to control up to eight (8) cascaded chassis, fully-populated with installed media converter slide-in-modules.

1.2 Unpacking the CPSMC08xx-100 Equipment

Use the following list to verify the shipment:

Item	Part Number
8-Slot chassis with AC power supply	CPSMC0800-100
8-Slot chassis with DC power supply	CPSMC0810-100
PointSystem™ chassis face plates (5)	CPSFP-200
Power Cord	(varies by country)
FocalPoint™ Software Disk (included with the management modules)	AI-7227
User's Guide	33270

The following items are optional accessories for the CPSMC08xx-100 8-slot PointSystem™ chassis.

Item	Part Number
External AC Power Supply	CPSMP-180 (optional)
External DC Power Supply	CPSMP-190 (optional)
1-slot Master Management Module	CPSMM-100 (optional)
2-slot Master Management Module	CPSMM-200 (optional)
Expansion Management Module	CPSMM-210 (optional)
Management Module Cascade Connector	6026 (optional)
23-inch Rack Mount Ears	CPSRE-238 (optional)
Selectable Media Converter Slide-in-Module(s)	(various P/N) - (optional)

2 Slide-in-Modules

2.1 Media Converter Slide-in-Modules

Transition Networks media converter slide-in-modules, installed in slots at the front of the chassis, allow the network administrator to connect various copper and fiber-optic network media over protocols that include Ethernet, Fast Ethernet, DS3/E3, and OC-12 as well as many others (see www.transition.com for a complete listing.)

NOTE: Refer to the user's guide that comes with each media converter slide-in-module for specific information on the module's cables, connectors, and LED indicators.

2.1.1 Chassis Face Plates

CAUTION: Slots in the CPSMC08xx-100 chassis without a slide-in-module installed **MUST** have a protective chassis face plate (P/N CPSFP-200) covering the empty slot for Class A compliance.

Install a chassis face plate over any unused chassis slot by aligning the hole in the face plate with the threaded hole in the chassis. Secure the face plate with the enclosed bolt.

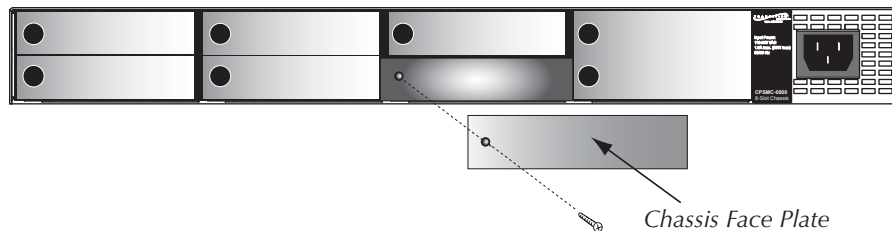

2.1.2 Calculating the Power Consumption

CAUTION: Before installing the media converter slide-in-modules, refer to the power consumption data for each individual media converter (provided in the User's Guide shipped with each media converter). **The combined power consumption of all devices must not exceed the available power supply.** Failure to observe this caution could result in diminishing system reliability.

In other words, the combined wattage of the CPSMC08xx-100 chassis **plus** all slide-in-modules must be **less than** the available power.

Contact Transition Networks Tech Support to ensure the power requirements for your specific application do not exceed the available power.

2.1.3 Installing the Media Converter Slide-in-Modules

CAUTION: Wear a grounding device and observe electrostatic discharge precautions when installing the media converter slide-in-module(s) into the chassis. **Failure to observe this caution could result in damage to, and subsequent failure of, the media converter slide-in-module(s).**

NOTE: The media converter slide-in-modules can be installed in any installation slot, in any order.

To install the media converter slide-in-module into the CPSMC08xx-100 chassis:

1. Remove the protective plate from the installation slot by removing the one (1) screw that secures the plate to the front of the chassis.

NOTE: If the slide-in-module requires two slots, remove the protective plates from two (2) adjacent installation slots.

2. Align the slide-in-module with the chassis installation slot so that the panel fastener screw is at the left of the slide-in-module.

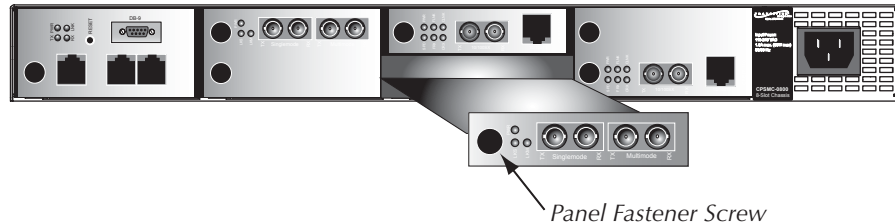

3. Carefully slide the slide-in-module into the installation slot, while aligning the module's circuit board with the installation guides.

NOTE: Ensure that the slide-in-module is firmly seated inside the chassis.

4. Push in and rotate the attached panel fastener screw clockwise to secure the slide-in-module to the chassis.
5. Repeat steps 1 through 4 for additional slide-in-module(s).

2.2.4 Replacing the Media Converter Slide-in-Modules

CAUTION: Wear a grounding device and observe electrostatic discharge precautions when replacing media converter slide-in-module(s). **Failure to observe this caution could result in damage to, and subsequent failure of, the media converter slide-in-module(s).**

NOTE: The media converter slide-in-modules can be hot-swapped.

To replace a media converter slide-in-module:

1. Remove the slide-in-module to be replaced by loosening the panel fastener screw that secures the module to the chassis front. Slide the module from the chassis.
2. Align the replacement slide-in-module with the chassis installation slot so that the panel fastener screw is to the left.

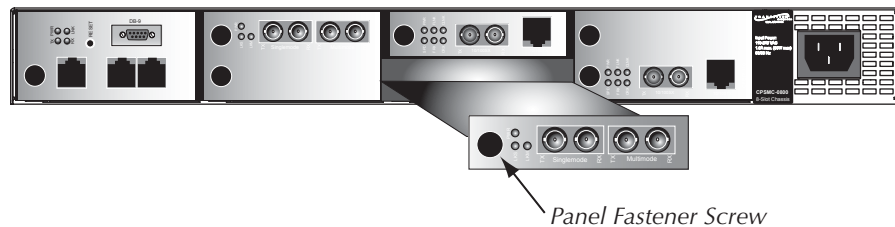

3. Carefully slide the replacement slide-in-module into the installation slot, while aligning the module's circuit board with the installation guides.

NOTE: Ensure that the slide-in-module is firmly seated inside the chassis.

4. Push in and rotate the attached panel fastener screw clockwise to secure the slide-in-module to the chassis.

2.2 Management Modules

Optional network management is provided by SNMP software embedded in Transition Networks *PointSystem*™ management module(s) that can be installed in the CPSMC08xx-100 chassis.

Transition Networks provides two such modules:

- CPSMM-120 Single-Slot Master Management Module.
- CPSMM-200 Dual-Slot Master Management Module.

Along with an additional expansion module:

- CPSMM-210 Single Slot Expansion Management Module

2.2.1 Three Types of Management Modules

CPSMM-120 Single-Slot Master Management Module

The optional CPSMM-120 Single-Slot Master Management Module can be installed to enable network management of a single CPSMC08xx-100 chassis .

Refer to the CPSMM-120 user's guide for more information on the CPSMM-120 Single-Slot Master Management Module.

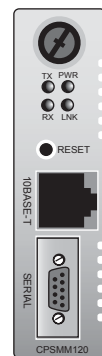

CPSMM-200 Dual-Slot Master Management Module

The optional CPSMM-200 Dual-Slot Master Management Module can also be installed in the CPSMC08xx-100 chassis to enable network management.

This module has all of the features of the CPSMM-120 plus a pair of cascade ports, which allow multiple *PointSystem*™ chassis to be connected.

Note also that this module requires **two** adjacent slots in the CPSMC08xx-100 chassis for installation.

Refer to the CPSMM-200/-210 user's guide for more information on the CPSMM-200 Dual-Slot Master Management Module.

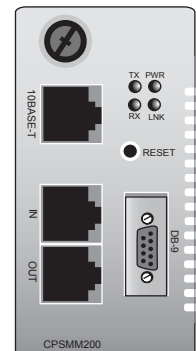

CPSMM-210 Single-Slot Expansion Management Module

The CPSMM-210 is used with the CPSMM-200 to connect up to eight (8) *PointSystem*™ chassis into one manageable stack.

Refer to the CPSMM-200/-210 user's guide for more information on the CPSMM-210 Single-Slot Expansion Management Module.

See section 4.3 *Cascade Option* for details on connecting multiple CPSMC08xx-100 chassis.

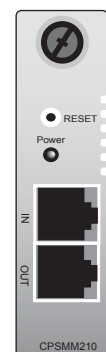

2.2.2 Installing the Management Modules

CAUTION: Wear a grounding device and observe electrostatic discharge precautions when installing the management module(s) in the CPSMC08xx-100 chassis. **Failure to observe this caution could result in damage to, and subsequent failure of, the management module.**

NOTE: Transition Networks recommends installing the management module into the left-most installation slots to keep the management cables separate from the media converter cables.

To install a management module into the CPSMC08xx-100 chassis:

1a. **CPSMM-200 Dual-Slot Master Management Module:**

If chassis face plates are covering the installation slots, remove two (2) management module protective plates from the two (2) installation slots at the far-left position of the chassis.

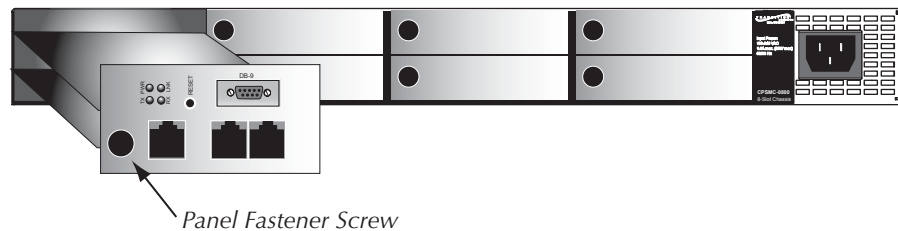

1b. **CPSMM-120 Single-Slot Master Management Module OR
CPSMM-210 Single-Slot Expansion Management Module:**

If chassis face plates are covering the installation slots, remove one (1) management module protective plate from one (1) installation slot at the far-left position of the chassis.

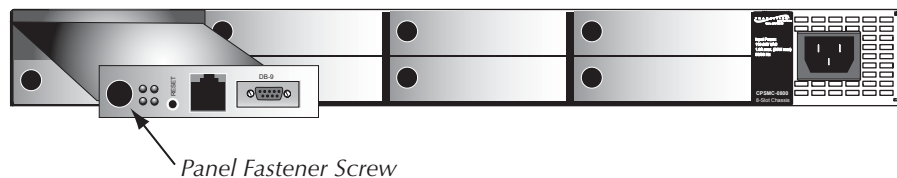

2. Align the management module with the *PointSystem*™ chassis installation slot so that the panel fastener screw is to the left of the module.
3. Carefully slide the management module into the installation slot, while aligning the module's circuit board with the installation guides.

NOTE: Ensure that management module is firmly seated inside the chassis.

4. e the attached panel fastener screw clockwise to secure the module to the chassis.

2.2.3 Replacing the Management Modules

CAUTION: Wear a grounding device and observe electrostatic discharge precautions when replacing media converter slide-in-module(s). **Failure to observe this caution could result in damage to, and subsequent failure of, the management module(s).**

NOTE: The management modules can be replaced while the chassis remains powered. However, **you must configure a new IP address for the replacement management module.** For more information, see the *FocalPoint™ 2.0* user's guide on the enclosed application CD or on-line at www.transition.com.

To replace a management module in the CPSMC08xx-100 chassis:

1. Remove the management module to be replaced by loosening the panel fastener screw that secures the module to the chassis front. Slide the module from the chassis.
2. Align the replacement module with the installation slot so that the panel fastener screw to the left of the module..

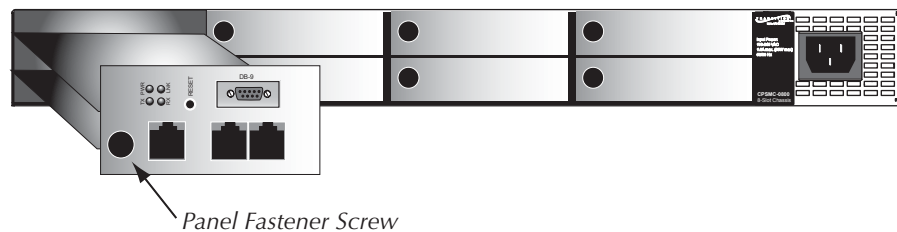

3. Carefully slide the replacement management module into the installation slot, while aligning the module's circuit board with the installation guides.

NOTE: Ensure that the management module is firmly seated inside the chassis.

4. Push in and rotate the attached panel fastener screw clockwise to secure the management module to the chassis.

3 Powering the CPSMC08xx-100

The CPSMC08xx-100 chassis can be powered through an AC or DC power supply. An optional auxiliary power supply, with instant fail over protection, is also available.

NOTE: The CPSMC08xx-100 chassis does not have an ON/OFF switch.

- Power up the chassis by connecting the power supply.
- Power-down the chassis by disconnecting power supply.

NOTE: Contact Technical Support for any questions concerning power supply.

3.1 Primary Power Supply

3.1.1 AC Power Supply

The CPSMC0800-100 includes an internal AC power supply, which is accessed through a power inlet on the front panel. The power cord is included.

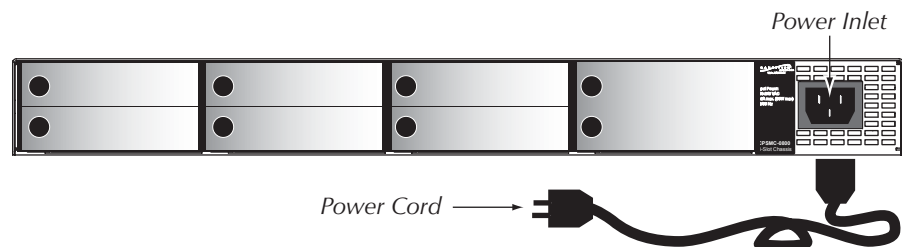

To power the CPSMM0800-100 chassis through the primary AC power supply:

1. Connect the female end of the power cord to the power inlet on the front panel of the chassis.
2. Plug the male end of the power cord into the correct voltage rack or wall socket.
3. Verify that the chassis is powered by observing the illuminated power LEDs on the installed slide-in-modules and by the chassis' fan operation.

3.1.2 DC Power Supply

- This product is intended to be used in a restricted access location. Proper earthing (grounding) is required to ensure safe operation. Grounding terminals are provided (section 4.1.3) for proper grounding of the device as per customer installation requirements and local electrical codes. Prior to installation, use a voltmeter/ohmmeter to check the wiring for the presence of earth ground.
- A readily accessible disconnect device as part of the building installation shall be incorporated into the fixed wiring. The disconnect device (a 48 VDC, 15 or 20A circuit breaker or switch) must be included in the ungrounded supply conductor. Overcurrent protection must be a 48 VDC, 15 or 20A fuse or circuit breaker.

Read and follow all warning notices & instructions marked on the product or included in the manual.

CAUTION: All installation and service must be performed by qualified service personnel.

The CPSMC0810-100 includes an internal DC power supply, which is accessed through the power terminal block on the front panel.

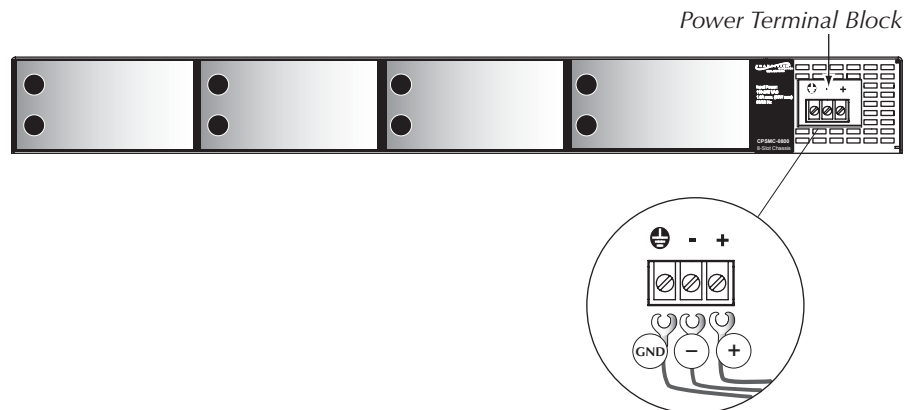

power supply

To power the CPSMM0810-100 chassis through the primary DC power supply:

1. Connect the +48-VDC terminal to the power terminal block connector marked "+". Turn the terminal screw clockwise to secure.
2. Connect the -48-VDC terminal to the power terminal block connector marked "-". Turn the terminal screw clockwise to secure.
3. Connect the ground terminal to the power terminal block connector marked "chassis ground". Turn the terminal screw clockwise to secure.
4. Verify that chassis is powered by observing the illuminated power LEDs on the installed slide-in-modules and by the chassis' fan operation.

3.2 Auxiliary Power Supply

The CPSMC08xx-100 chassis can also be supplied with auxiliary power from an external power converter, which is connected to the chassis through the auxiliary power inlet, located on the back panel. (Both AC and a DC external power converter are available from Transition Networks.)

Instant Fail Over Protection

The CPSMC08xx-100 has instant fail over protection when both the primary and auxiliary power supplies are connected to external power sources. The auxiliary power supply waits in stand-by -- ready to supply power to the chassis in the event of power failure from the primary power supply.

AC and DC Power Supplies

The CPSMC0800-100, with the internal AC power supply, can have either the AC-powered CPSMP-180 or the DC-powered CPSMP-190 as the Auxiliary power supply.

Likewise, the CPSMC0810-100, with the internal DC power supply, can have either the AC-powered CPSMP-180 or the DC-powered CPSMP-190 as the Auxiliary power supply.

power supply

3.2.1 AC Auxiliary Power Supply

To power the CPSMC08xx-100 chassis through the AC auxiliary power supply:

1. Connect the female end of the external power converter to the auxiliary power inlet on the back of the chassis.
2. Connect the female end of the power cord to the male end of the external power converter.
3. Plug the male end of the power cord into the correct voltage AC rack or wall socket.
4. Verify that Auxiliary power supply is connected properly by disconnecting the primary power supply, and then by observing the illuminated power LEDs on the installed slide-in-modules and by the chassis' fan operation.

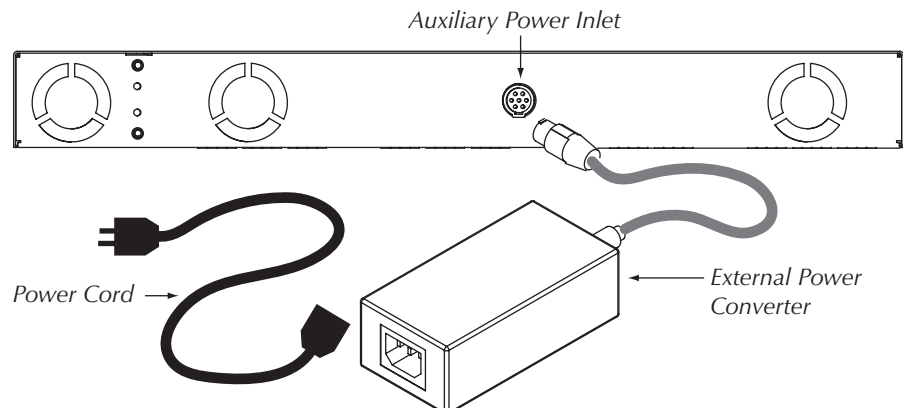

3.2.2 DC Auxiliary Power Supply

- This product is intended to be used in a restricted access location. Proper earthing (grounding) is required to ensure safe operation. Grounding terminals are provided (section 4.1.3) for proper grounding of the device as per customer installation requirements and local electrical codes. Prior to installation, use a voltmeter/ohmmeter to check the wiring for the presence of earth ground.
- A readily accessible disconnect device as part of the building installation shall be incorporated into the fixed wiring. The disconnect device (a 48 VDC, 15 or 20A circuit breaker or switch) must be included in the ungrounded supply conductor. Overcurrent protection must be a 48 VDC, 15 or 20A fuse or circuit breaker.

Read and follow all warning notices & instructions marked on the product or included in the manual.

CAUTION: All installation and service must be performed by qualified service personnel.

To power the CPSMC08xx-100 chassis through the DC auxiliary power supply:

1. Connect the female end of the external power converter to the auxiliary power inlet on the back of the chassis.
2. Connect the +48-VDC terminal to the connector marked "+". Turn the terminal screw clockwise to secure.
3. Connect the -48-VDC terminal to the connector marked "-". Turn the terminal screw clockwise to secure.
4. Connect the ground terminal to the connector marked "chassis ground". Turn the terminal screw clockwise to secure.
5. Verify that Auxiliary power supply is connected properly by disconnecting the primary power supply, and then by observing the illuminated power LEDs on the installed slide-in-modules and by the chassis' fan operation.

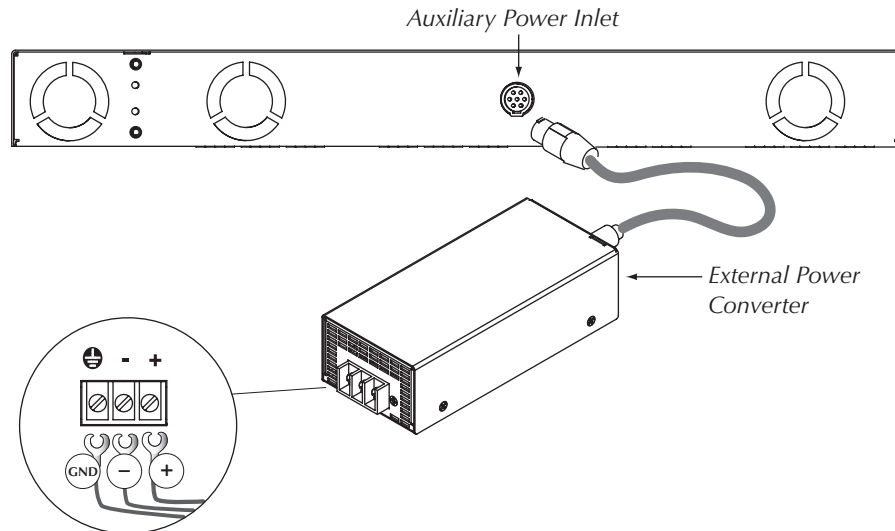

power supply

4 CPSMC08xx-100 Chassis

4.1 Installing the CPSMC08xx-100 Chassis

The CPSMC08xx-100 can be installed in a standard 19-inch rack or on a table, shelf, or other stable surface.

CAUTION: Install the chassis so that the air flow around it is not restricted.

4.1.1 Table-Top Installation

The CPSMC08xx-100 chassis is shipped with nine (9) rubber feet for optional installation on a table or other flat, stable surface in a well-ventilated area. If table-top installation is desired, remove the rubber feet from the card and place them on the bottom of the chassis. Distribute the feet so that the chassis is level when placed upright.

4.1.2 Standard 19-inch Rack Installation

The maximum recommended ambient temperature (T_{mra}) for the CPSMC08xx-100 chassis is 40°C. If the chassis is installed in a closed or multi-unit rack assembly, **the operating ambient temperature of the the rack environment may be greater than room ambient.**

NOTE: Rack-mounted equipment must be reliably grounded. Power supply connections **other than direct connection** to the branch circuit (e.g., use of power strips) should be employed.

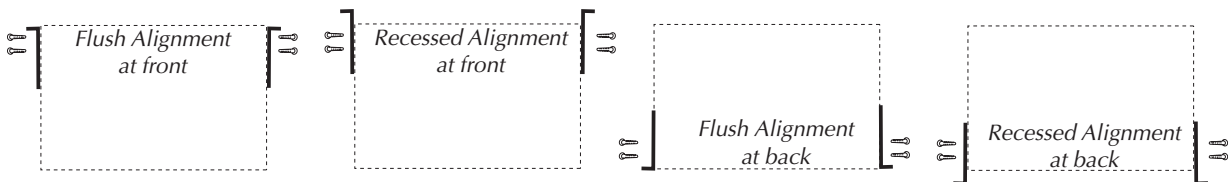

The CPSMC08xx-100 chassis is designed so that the installation brackets can be installed to align the chassis either **flush** against the front or back edge of the rack or **recessed** from the front or back edge of the rack.

WARNING: Select mounting bracket locations on the chassis that will keep the chassis balanced when mounted in the rack. Failure to observe this warning could allow the chassis to fall, resulting in equipment damage and/or possible injury to personnel.

To install the CPSMC08xx-100 chassis into a standard 19-inch rack:

1. Determine the preferred alignment of the chassis in the rack.

NOTE: Installation bracket mounting screws are provided. Rack mount screws and clip nuts are NOT provided.

2. Locate six (6) installation bracket mounting screws (provided) for each chassis to be installed.

WARNING: Mount the chassis evenly and securely onto the rack. Failure to observe this warning could allow the chassis to fall, resulting in equipment damage and/or possible injury to personnel.

3. Align the universal mounting bracket in the selected position against the side of the chassis so that the chassis installation holes are visible through the universal bracket installation holes.
4. Using a Phillips screwdriver, install the three (3) screws through the mounting bracket into the installation holes on side of the chassis.



5. Repeat steps 3 and 4 for the second mounting bracket.
6. Locate four (4) screws (not provided) and optional clip-nuts (not provided) for each chassis to be installed.
7. Carefully align the chassis at a secure and level position between the 19-inch site rack mounting rails.
8. Install two (2) screws through the right bracket into the right mounting rail and two (2) screws through the left bracket into the left mounting rail, using the clip nuts to secure, if necessary.

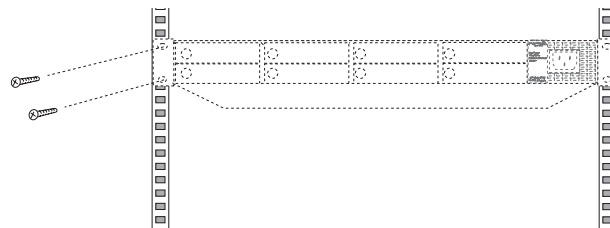

4.1.3 Grounding Lugs

The CPSMC08xx-100 comes equipped with grounding lugs, which are provided for a grounding conductor wire terminated with a **two-hole, compression-type, grounding connector**. The grounding wire -- which must be a copper conductor -- is not included with the chassis and must be provided by the customer/installer.

The electrical conducting path from the chassis must:

- Flow via the grounding lugs to the Common Bonding Network (CBN) for telecom installations; or to an alternate approved grounding system (if required) for non-telecom installations,
- Be of sufficiently low impedance to conduct fault currents likely to be imposed on the chassis, and
- Enable proper operation of any over-current protection devices.

The two-hole, compression-type, grounding connector **must be fastened to the grounding lugs with the enclosed, anti-rotation star-washers and lug-nut fasteners**. The required torque to the fasteners is specified by the connector's manufacturer.

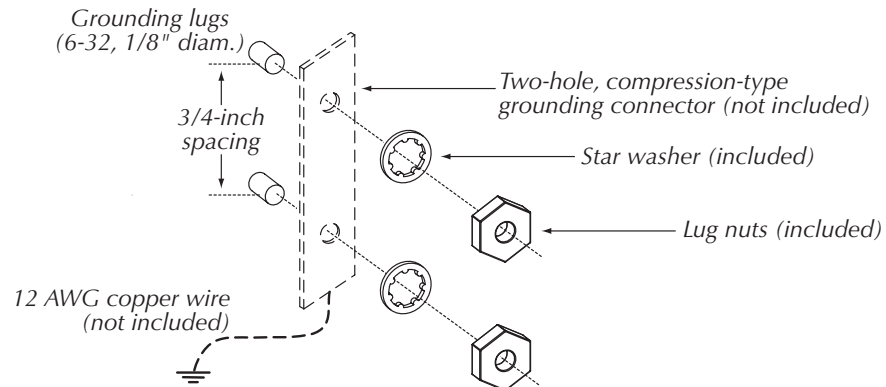

To properly ground the CPSMC08xx-100 chassis:

1. Obtain one (1) properly-terminated, grounding conductor (12 AWG copper wire gauge or larger) with a two-hole, compression-type, grounding connector. Note the manufacturer's applied torque that is required for the connector.
2. Attach the grounding conductor to the chassis by placing the two-hole, compression-type connector onto the grounding lugs and fasten with appropriate lock-washers and lug-nuts at the proper torque.
3. Attach the opposite end of the properly-terminated grounding conductor to the Common Bonding Network (CBN) for telecom installations, or to an approved grounding system (if required) for non-telecom installations.

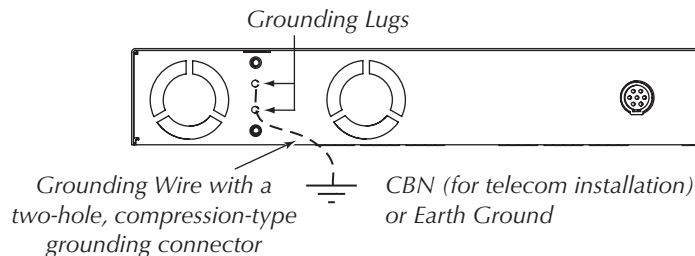

4.2 Cascade Option

The management module cascade option allows the network administrator to connect up to eight (8) CPSMC08xx-100 chassis into one manageable stack, providing a single management source for up to 55 installed media converter devices.

To create the cascade option, the CPSMM-200 Dual Slot Master Management Module is installed in the first chassis in the series. The CPSMM-210 Single-Slot Expansion Management Module is installed in each subsequent chassis.

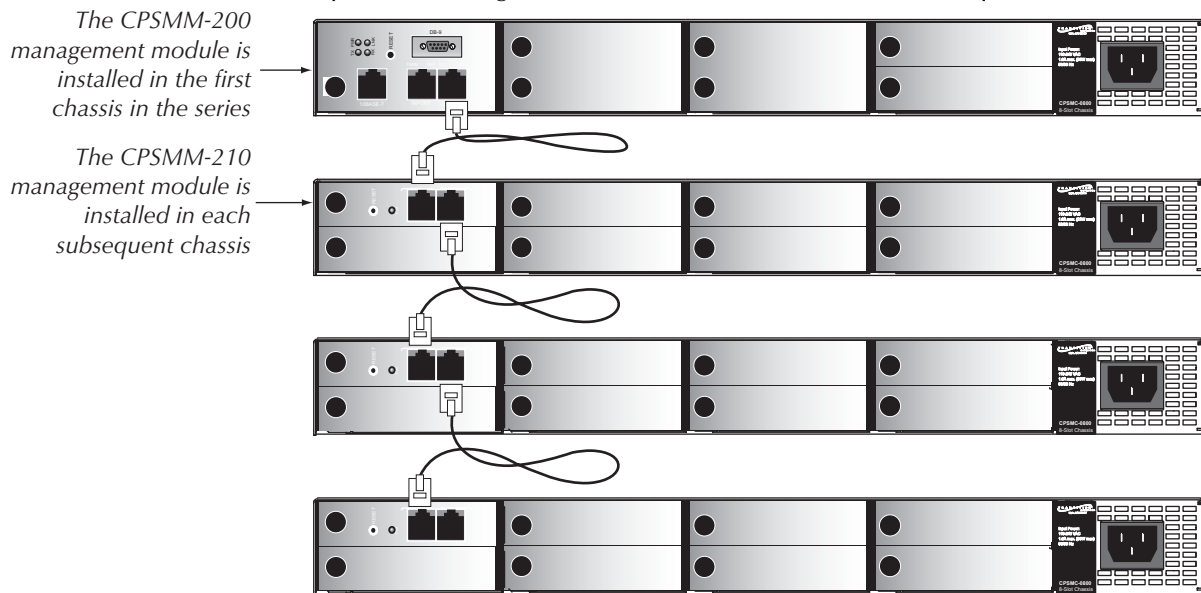

An alternative setup involves installing two CPSMM-200 Dual-Slot Master Management Modules into two adjacent chassis for redundant management.

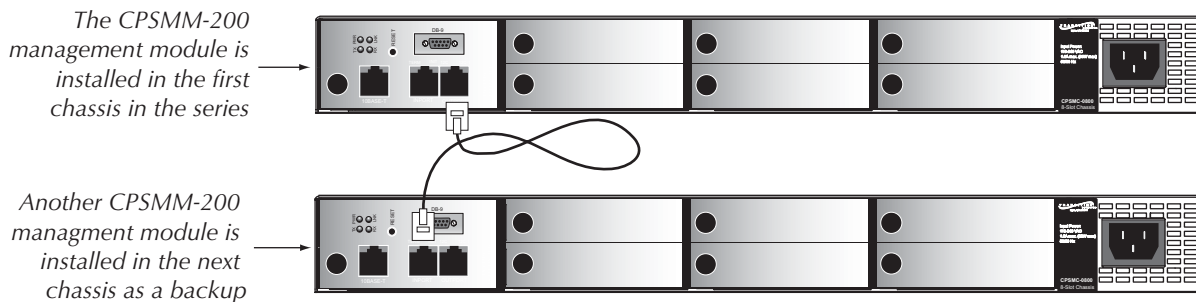

In this set-up, the two CPSMM-200 management modules auto-negotiate so that one module is in stand-by mode. If the primary management module fails, the stand-by module automatically takes over and manages the network.

chassis

To cascade two or more CPSMC08xx-100 chassis:

1. Locate one (1) Transition Networks management module cascade cable (with RJ-45 connectors installed at both ends) (P/N 6026) for each set of two (2) chassis to be cascaded.

NOTE: Transition Networks management module cascade cables are one (1) meter long. Ensure that the chassis are installed within one (1) meter of each other.

2. At the first chassis in the series: Plug the RJ-45 connector at one end of the cascade cable into the management module's RJ-45 port labeled "OUT".
3. At the next chassis in the series: Plug the RJ-45 connector at the other end of the cascade cable into the management module's RJ-45 port labeled "IN".
4. At the same chassis as in step 3: Plug the RJ-45 connector at one end of the cascade cable into the management module's RJ-45 port labeled "OUT".
5. At the next chassis in the series: Plug the RJ-45 connector at the other end of the cascade cable into the management module's RJ-45 port labeled "IN".
6. Repeat steps 4 and 5 until all chassis have been connected.

4.3 Connecting the Slide-in-Modules to the Network

Once the CPSMC08xx-100 chassis has been installed, the media converter slide-in-modules may be connected to the network.

CAUTION: Connect input/output network cables ONLY to media converter slide-in-module connectors within the same network protocol (such as Ethernet-to-Ethernet, Fast Ethernet-to-Fast Ethernet, ATM-to-ATM). Failure to observe this caution will cause data transfer to fail.

Refer to the user's guides included with the media converter slide-in-modules for cabling specifications and instructions.

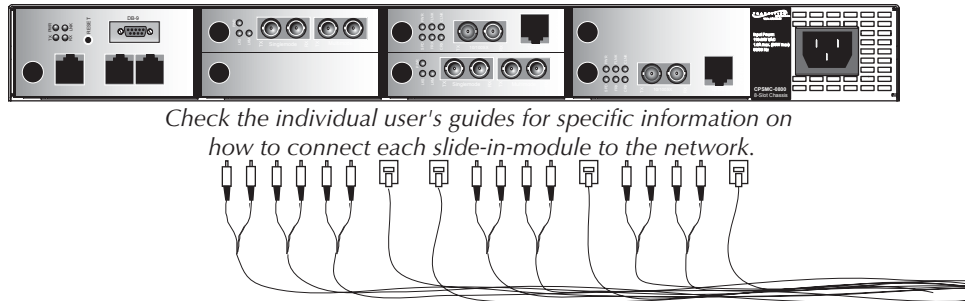

Check the individual user's guides for specific information on how to connect each slide-in-module to the network.

4.4 Operation

Daily operation of the CPSMC08xx-100 chassis requires no network administrator activity except for the occasional monitoring of the status LED indicators on the installed media converter slide-in-modules.

Each media converter slide-in-module and each management module has one or more LED indicators to help monitor the network.

Refer to the user's guide included with each management module and slide-in-module to interpret the LED indicators on the modules.

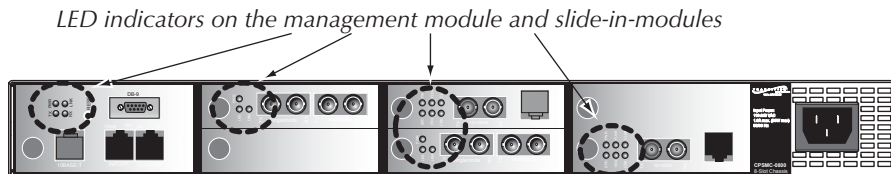

chassis

5 Network Management

The CPSMM100 firmware and the *FocalPoint*™ application are described in the ***FocalPoint*™ 2.0 Management Application and CPSMM100 Firmware** user's guide (P/N 33293). This manual is included on the application CD and is also available on-line at www.transition.com.

Transition Networks CPSMM100 firmware is embedded in the optional management modules (see section 2.2). The firmware allows the network administrator to configure and manage the CPSMC08xx-100 chassis from an attached terminal or from a remote, networked computer.

The firmware includes the Transition Networks **Command Line Interface** (CLI), a **telnet server**, a **Web browser**, and an **SNMP** (Simple Network Management Protocol) agent.

In addition, Transition Networks ***FocalPoint*™ application** can be installed in the networked computer to provide a graphical user interface to monitor the *PointSystem*™ chassis.

5.1 Hardware Connections

Network management can be accessed either through the DB-9 serial port or through the RJ-45 Ethernet port of the management modules.

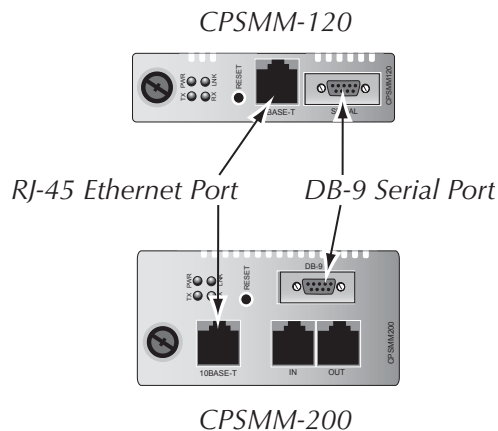

network mgmt.

DB-9 Serial Port

The DB-9 serial port allows the network administrator to configure and manage the CPSMC08xx-100 chassis using the SNMP Command-Line Interface (CLI) at an attached terminal or terminal emulator.

Use a null modem cable to attach a terminal to the DB-9 serial port on the management module as shown.

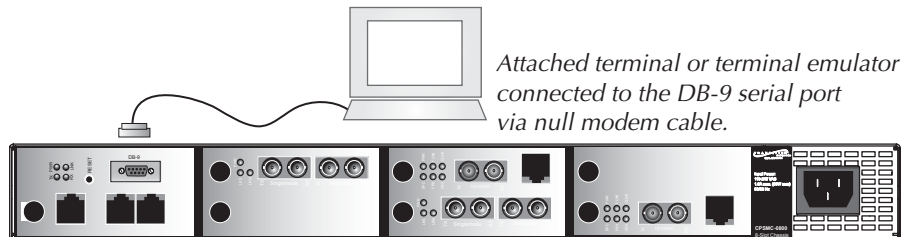

RJ-45 Ethernet Port

The RJ-45 Ethernet port allows the network administrator to manage the CPSMC08xx-100 chassis via a remote Network Management Station (NMS) in one of two ways:

1. Using the Transition Networks *FocalPoint*™ graphical user interface.
2. Using a remote Telnet connection.

Use an RJ-45 network cable to attach a terminal (via a network hub or switch) to the RJ-45 Ethernet port on the management module as shown.

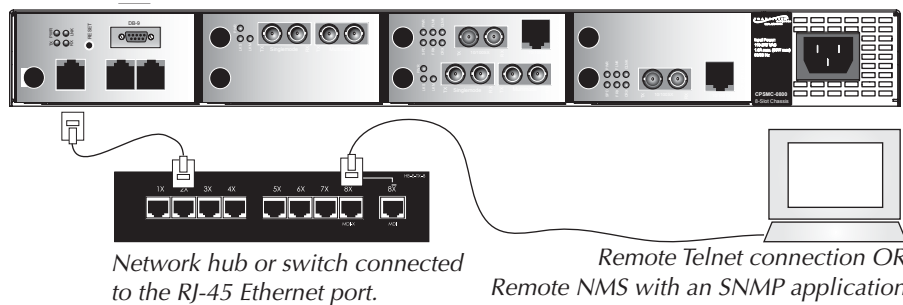

NOTE: To manage the *PointSystem*™ chassis via a remote NMS, both the RJ-45 Ethernet port and the NMS must be connected to a network with Internet access.

6 Troubleshooting

1. **Are ANY of the POWER LEDs on any of the slide-in-modules illuminated; AND/OR are the fans operating?**
YES
 - The chassis is receiving power. Proceed to the next step.**NO**
 - Ensure all power supply cables for proper connection.
 - Ensure the AC receptacle on the wall is supplying power.
 - If the fuse for the AC receptacle on the wall blows repeatedly, have the AC receptacle inspected by a qualified electrician.
 - Contact Tech Support: 1-800-260-1312, Int'l: 00-1-952-941-7600.

2. **Are ANY of the POWER LEDs on any of the slide-in-modules illuminated; but are the fans NOT operating?**
YES
 - The chassis is receiving power. Proceed to the next step.**NO**
 - Contact Tech Support: 1-800-260-1312, Int'l: 00-1-952-941-7600.

3. **For the management modules (CPSMM120, CPSMM200, CPSMM210), are ANY of the POWER LEDs NOT illuminated?**
NO
 - All management modules are receiving power. Proceed to the next step.**YES**
 For those management modules where the POWER LED is NOT illuminated:
 - Ensure the management module is firmly seated in the slot.
 - Press the RESET button on the management module.
 - Contact Tech Support: 1-800-260-1312, Int'l: 00-1-952-941-7600.

4. **For the remaining slide-in-modules, are ANY of the POWER LEDs NOT illuminated?**
NO
 - All slide-in-modules are receiving power. Proceed to the next step.**YES**
 For those slide-in-modules where the POWER LED is NOT illuminated:
 - Ensure the slide-in-module is firmly seated in the slot.
 - Contact Tech Support: 1-800-260-1312, Int'l: 00-1-952-941-7600.

4. **To determine if a fault is due to a software problem, consult the troubleshooting section of the *FocalPoint™ 2.0 Management Application and CPSMM100 Firmware User's Guide* (P/N 33293). This manual is available on the enclosed application CD and on-line at www.transition.com.**

5. **To determine if a fault is due to an individual or slide-in-module, consult the troubleshooting section of the user's guide for that particular module.**

6. **If none of the solutions listed in this section resolves the problem, contact Technical Support: U.S./Canada: 1-800-260-1312, International: 00-1-952-941-7600.**

Technical Specifications

For use with Transition Networks Model CPSMC08xx-100 or equivalent.

Dimensions 17 x 10.4 x 1.8 inches (432 x 264 x 46 mm)

Shipping Weight 8 lbs. (3.6 kg)

AC Power Supply

Power Input: 100-240 V, 50/60 Hz, 0.66-1.6 Amp (typical with a fully-loaded chassis)
 Power Output: +12 VDC at 5 Amp maximum.

DC Power Supply

Power Input: 48-VDC (38 to 58 VDC) @ 1.6 Amp (typical with a fully-loaded chassis)
 Power Output: +12 VDC at 8.3 Amp maximum.

MTBF (Mean Time Before Failure)	MIL217F2 V5.0 (hrs)	Bellcore7 V5.0 (hrs)
without fans	43,277	114,896
with three (3) fans	22,972	61,715

Environment

Tmra: 0 to 40°C (32° to 104°F) (Manufacturer's rated ambient temperature)
 Storage Temperature: -40 to 80°C (-40 to 176°F)
 Humidity: 5 to 95%, non condensing
 Altitude: 0 to 10,000 feet

Compliance EN 55022 Class A; EN 55024; FCC Class A; CE Mark

Warranty Lifetime

Product is certified by the manufacturer to comply with DHHS Rule 21/CFR, Subchapter J applicable at the date of manufacture.

The fiber optic transmitters on this device meets Class I Laser safety requirements per IEC-825/CDRH standards and complies with 21 CFR1040.10 and 21CFR1040.11.

CAUTION: Visible and Invisible Laser Radiation When Open. Do Not Stare Into Beam Or View Directly With Optical Instruments.

CAUTION: Use of controls, adjustments or the performance of procedures other than those specified herein may result in hazardous radiation exposure.

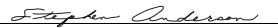
	Declaration of Conformity
Name of Mfg:	Transition Networks 6475 City West Parkway, Minneapolis MN 55344 USA
Model:	8-Slot PointSystem™ Chassis
Part Number:	CPSMC0800-100, CPSMC0810-100
Regulation:	EMC Directive 89/336/EEC
Purpose: To declare that the 8-Slot PointSystem™ Chassis to which this declaration refers is in conformity with the following standards. EN 55022:1994; EN 55024:1998; FCC Part 15 Class A; 21 CFR subpart J	
<i>I, the undersigned, hereby declare that the equipment specified above conforms to the above Directive(s) and Standard(s).</i>	
 Stephen Anderson, Vice-President of Engineering	April 1, 2003 Date

Cable Specifications

Null Modem Cable

The Null Modem Cable is used for connecting a terminal or terminal emulator to the management module's DB-9 connector to access the command-line interface.

The table below shows the pin assignments for the DB9 cable.

Function	Mnemonic	Pin
Carrier Detect	CD	1
Receive Data	RXD	2
Transmit Data	TXD	3
Data Terminal Ready	DTR	4
Signal Ground	GND	5
Data Set Ready	DSR	6
Request To Send	RTS	7
Clear To Send	CTS	8

25 Pin RS-232 Null Modem Cable

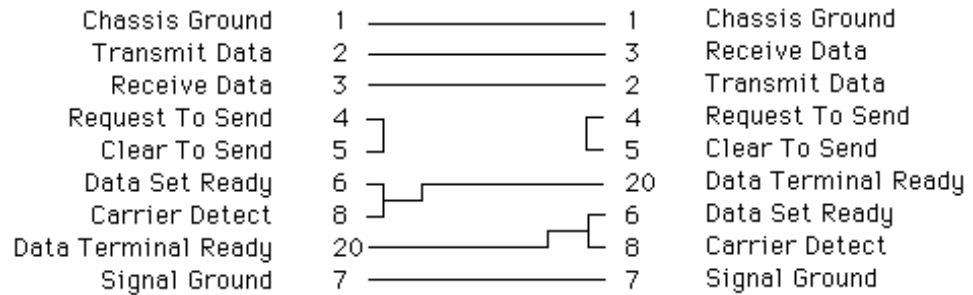

RJ-45 Cable

Category 5:

Gauge:	24 to 22 AWG
Attenuation:	22.0 dB /100m @ 100 MHz
Maximum Cable Distance:	100 meters

- Straight-through OR crossover cable may be used.
- Shielded twisted-pair (STP) OR unshielded twisted-pair (UTP) may be used.
- All pin pairs (1&2, 3&6, 4&5, 7&8) are active in a Gigabit Ethernet network.
- Use only dedicated wire pairs for the active pins:
(e.g., blue/white & white/blue, orange/white & white/orange, etc.)
- Do not use flat or silver satin wire.

COAX Cable

Coaxial cable media is used for circuits such as DS3, E1 and 10Base-2 Ethernet. The impedance of the coaxial cable is determined by the interface type, for example:

- 75 ohm for DS3.
- 50 ohm for 10Base-2 Ethernet.

Special attention should be given to the grounding requirements of coaxial cable circuits. Installation may require grounding at both cable ends or only one cable end or neither cable end.

Cable Shield Grounding

Media converter network cabling may be shielded or unshielded. Shielded cables **MUST** be grounded according to the specific requirements of the media and port type. For example:

- Shielded RJ-45 cable used for 100Base-Tx Ethernet **MUST** be grounded at both cable endpoints via shielded RJ-45 jacks.
- Shielded RS-232 cable **MUST** have the shield grounded at both cable endpoints via shielded RS-232 connectors.
- COAX cable used for 10Base-2 Ethernet **MUST** only be grounded at a single point.

The media converters provide a jumper option or other grounding mechanism as required. Special attention should be given to the grounding requirements of coaxial cable circuits. Installation may require grounding at both cable ends or only one cable end or neither cable end. See the individual media converter user's guide for cable/port grounding requirements.

Contact Us

Technical Support

Technical support is available 24 hours a day.

United States: **1-800-260-1312**

International: **00-1-952-941-7600**

Transition Now

Chat live via the Web with a Transition Networks Technical Support Specialist.

Log onto **www.transition.com** and click the **Transition Now** link.

Web-Based Seminars

Transition Networks provides 12-16 seminars per month via live web-based training.

Log onto **www.transition.com** and click the **Learning Center** link.

E-Mail

Ask a question anytime by sending an e-mail message to our technical support staff.

techsupport@transition.com

Address

Transition Networks

6475 City West Parkway
Minneapolis, MN 55344, USA

telephone: 952-941-7600

toll free: 800-526-9267

fax: 952-941-2322

Warranty

Limited Lifetime Warranty

Effective for products shipped May 1, 1999 and after. Every Transition Networks' labeled product purchased after May 1, 1999 will be free from defects in material and workmanship for its lifetime. This warranty covers the original user only and is not transferable.

This warranty does not cover damage from accident, acts of God, neglect, contamination, misuse or abnormal conditions of operation or handling, including over-voltage failures caused by use outside of the product's specified rating, or normal wear and tear of mechanical components. If the user is unsure about the proper means of installing or using the equipment, contact Transition Networks' free technical support services.

To establish original ownership and provide date of purchase, please complete and return the registration card accompanying the product or register the product online on our product registration page.

Transition Networks will, at its option:

- Repair the defective product to functional specification at no charge,
- Replace the product with an equivalent functional product, or
- Refund the purchase price of a defective product.

To return a defective product for warranty coverage, contact Transition Networks' technical support department for a return authorization number. Transition's technical support department can be reached through any of the following means:

Technical Support is available 24 hours a day via:

- phone 800-260-1312 x 200 or 952-941-7600 x 200
- fax 952-941-2322
- email techsupport@transition.com
- live web chat: Transition Now
- voice mail 800-260-1312 x 579 or 952-941-7600 x 579
- All messages will be answered within one hour.

Send the defective product postage and insurance prepaid to the following address:

CSI Material Management Center

c/o Transition Networks

508 Industrial Drive

Waconia, MN 55387 USA

Attn: RETURNS DEPT: CRA/RMA # _____

Failure to properly protect the product during shipping may void this warranty. The return authorization number must be written on the outside of the carton to ensure its acceptance. **We cannot accept delivery of any equipment that is sent to us without a CRA or RMA number.**

The customer must pay for the non-compliant product(s) return transportation costs to Transition Networks for evaluation of said product(s) for repair or replacement. Transition Networks will pay for the shipping of the repaired or replaced in-warranty product(s) back to the customer (any and all customs charges, tariffs, or/and taxes are the customer's responsibility).

Before making any non-warranty repair, Transition Networks requires a \$200.00 charge plus actual shipping costs to and from the customer. If the repair is greater than \$200.00, an estimate is issued to the customer for authorization of repair. If no authorization is obtained, or the product is deemed not repairable, Transition Networks will retain the \$200.00 service charge and return the product to the customer not repaired. Non-warranted products that are repaired by Transition Networks for a fee will carry a 180-day limited warranty. All warranty claims are subject to the restrictions and conventions set forth by this document.

Transition Networks reserves the right to charge for all testing and shipping incurred, if after testing, a return is classified as "No Problem Found."

THIS WARRANTY IS YOUR ONLY REMEDY. NO OTHER WARRANTIES, SUCH AS FITNESS FOR A PARTICULAR PURPOSE, ARE EXPRESSED OR IMPLIED. TRANSITION NETWORKS IS NOT LIABLE FOR ANY SPECIAL, INDIRECT, INCIDENTAL OR CONSEQUENTIAL DAMAGES OR LOSSES, INCLUDING LOSS OF DATA, ARISING FROM ANY CAUSE OR THEORY. AUTHORIZED RESELLERS ARE NOT AUTHORIZED TO EXTEND ANY DIFFERENT WARRANTY ON TRANSITION NETWORKS' BEHALF.

Free Manuals Download Website

<http://myh66.com>

<http://usermanuals.us>

<http://www.somanuals.com>

<http://www.4manuals.cc>

<http://www.manual-lib.com>

<http://www.404manual.com>

<http://www.luxmanual.com>

<http://aubethermostatmanual.com>

Golf course search by state

<http://golfingnear.com>

Email search by domain

<http://emailbydomain.com>

Auto manuals search

<http://auto.somanuals.com>

TV manuals search

<http://tv.somanuals.com>