



SISTM10xx-162-LR(T)

(6) 10/100Base-TX + (2) 100Base-FX

Industrial Managed Switch

Installation Manual

Rev. 1

25-October-2007

Notice

This manual contents are based on the below table listing software kernel version, hardware version, and firmware version. If the switch functions have any different from the manual contents description, please contact Transition Networks for more information.

Firmware Version	v1.02
Kernel Version	v3.22
Hardware Version	A5.00

FCC Warning

This Equipment has been tested and found to comply with the limits for a Class-A digital device, pursuant to Part 15 of the FCC rules. These limits are designed to provide reasonable protection against harmful interference in a residential installation. This equipment generates uses and can radiate radio frequency energy and, if not installed and used in accordance with the instructions, may cause harmful interference to radio communications. However, there is no guarantee that interference will not occur in a particular installation. If this equipment does cause harmful interference to radio or television reception, which can be determined by turning the equipment off and on, the user is encouraged to try to correct the interference by one or more of the following measures:

- Reorient or relocate the receiving antenna.
- Increase the separation between the equipment and receiver.
- Connect the equipment into an outlet on a circuit different from that to which the receiver is connected.
- Consult the dealer or an experienced radio/TV technician for help.

CE Mark Warning

This is a Class-A product. In a domestic environment this product may cause radio interference in which case the user may be required to take adequate measures.

Contents

Notice.....	1
FCC Warning	1
CE Mark Warning	1
Introduction	1
Features.....	1
Package Contents	2
Hardware Description	3
Physical Dimension.....	3
Front Panel	3
Reset Button	3
Bottom View.....	4
DIP-switch.....	4
LED Indicators	5
Ports	6
Cabling.....	8
Wiring the Power Inputs.....	8
Wiring the Fault Alarm Contact.....	8
Wiring the Fault Alarm Contact.....	9
Mounting Installation	10
DIN-Rail Mounting	10
Wall Mount Plate Mounting	11
Hardware Installation	11
Hardware Installation	12
Installation Steps	12
Network Application.....	13
X-Ring Application	14
Coupling Ring Application.....	15
Dual Homing Application.....	15
Web-Based Management	16
About Web-based Management	16
Preparing for Web Management.....	16
System Login	16

Port status.....	17
Single Port Information	18
Port Statistics.....	18
Port Control.....	19
Switch Setting.....	19
Port Mirroring	20
VLAN configuration.....	21
Port-based VLAN.....	22
802.1Q VLAN.....	23
802.1Q VLAN.....	24
Alert	27
Email Alert Configuration	27
Event Configuration	28
Power Alarm Configuration	29
IP Configuration	29
SNTP Configuration	30
IP Security	32
RSTP Configuration	32
System Configuration.....	33
Per Port Configuration	34
X-Ring.....	35
QoS Configuration	37
IGMP.....	38
Security Manager.....	39
SNMP Configuration	40
System Options.....	41
Community strings	41
Trap Manager	41
Configuration Backup.....	41
TFTP Restore Configuration	41
TFTP Backup Configuration.....	42
TFTP Update Firmware	42
Factory Default	43
System Reboot	43

Save Configuration	44
Rate Control.....	44
System Log.....	45
System Log Configuration.....	45
Event Configuration	46
Troubles shooting	48
Technical Specification.....	49

Introduction

The SISTRM10xx-162-LRx Managed Industrial Switch is a cost-effective solution and meets the high reliability requirements demanded by industrial applications. The switch can be easily managed through the Web GUI. By using fiber port can extend the connection distance that increases the network elasticity and performance. It also provides the X-Ring function that can prevent the network connection failure.

Features

- Conform to IEEE 802.3 10Base-T, 802.3u 100Base-TX/100Base-FX
- 6-port 10/100TX plus 2 100FX port industrial switch
- RJ-45 port support auto MDI/MDI-X function
- Store-and-Forward switching architecture
- Wide-range redundant power design
- DIN rail and wall mount design
- 2K MAC address table
- Web management GUI
- Per port supports 4 priority queues
- Provides Fiber link ability
- IEEE 802.3x flow control support
 - Flow control with full-duplex
 - Back pressure with half-duplex
- Support Class of service
- Support IGMP with Query mode for multi media application
- Supports ingress packet filter and egress rate limit.
- Support SNTP/SMTP
- Port mirror for TX or TX and RX packet.
- Alarm Relay output for system events
- Support X-Ring function
- Power polarity reverse protect
- 1Mbits Embedded memory
- Support Port based VLAN / 802.1 Q Tag VLAN
- IEEE 802.1p class of service and provide port base, Tag base and Type of service priority method
- Support DHCP client
- SNMP, Web Management, RMON supported
- TFTP firmware update and system configure restore and backup

Package Contents

Please refer to the package content list below to verify them against the checklist.

- SISTM10xx-162-LRx Managed Industrial Switch
- DC Jack $\phi 2.0/150\text{mm}$ RoHS
- User manual CD
- DIN-Rail Bracket (attached on the switch)
- One wall mount plate and six screws



SISTM10xx-162-LRx



DC Jack $\phi 2.0/150\text{mm}$ RoHS

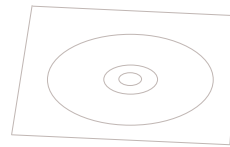

User Manual CD



Wall Mount Plate



Screws

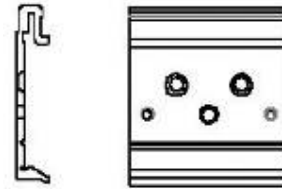

DIN-Rail Bracket (installed)

Compare the contents of the industrial switch with the standard checklist above. If any item is damaged or missing, please contact Transition Networks.

Hardware Description

In this paragraph, it will describe the Industrial switch's hardware spec, port, cabling information, and wiring installation.

Physical Dimension

54mm (w) x 135mm (h) x 105mm (d)

Front Panel

The Front Panel of the SISTM10xx-162-LRx Managed Industrial Switch is shown below:

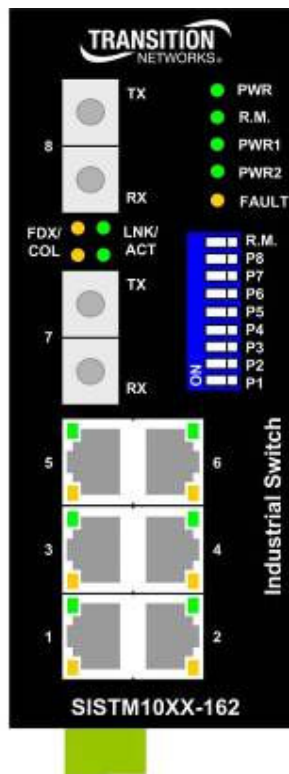

Reset Button

The reset button provides user a quick and easy way to restart and set the configuration back to default value.

- **Restart:** press the button for 2 seconds and release
- **Set to factory default value:** press the button for 5 seconds and release. The switch will

set all configurations back to default setting

Bottom View

The bottom view of the switch is shown below:

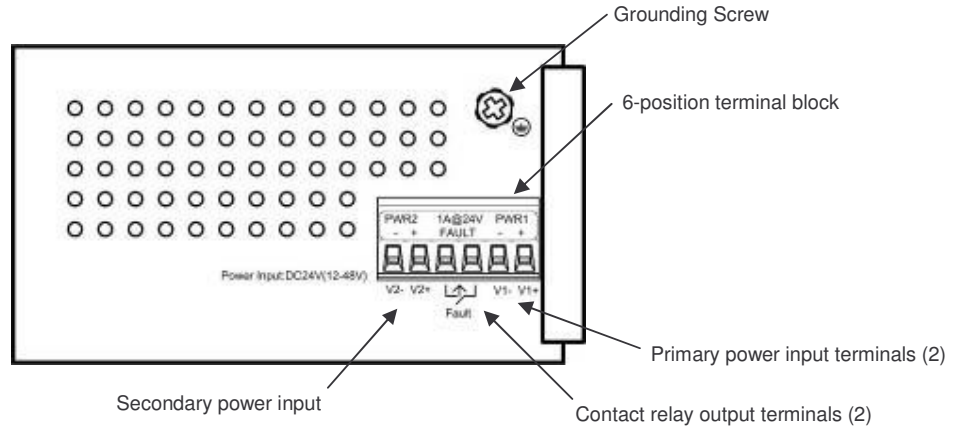

DIP-switch

The switch provides the 9 DIP-switch for configuring the relay alarm operation mode and the master ring operation mode. The default value of Dipswitch is **OFF**.

DIP Switch No	Status	Description
1	OFF	Disable port 1 Alarm
	ON	Enable port Alarm. If the port's link fails, the fault LED will light up
2	OFF	Disable port Alarm
	ON	Enable port Alarm. If the port's link fails, the fault LED will light up
3	OFF	Disable port Alarm
	ON	Enable port Alarm. If the port's link fails, the fault LED will light up
4	OFF	Disable port Alarm
	ON	Enable port Alarm. If the port's link fails, the fault LED will light up

5	OFF	Disable port Alarm
	ON	Enable port Alarm. If the port's link fails, the fault LED will light up
6	OFF	Disable port Alarm
	ON	Enable port Alarm. If the port's link fails, the fault LED will light up
7	OFF	Disable port Alarm
	ON	Enable port Alarm. If the port's link fails, the fault LED will light up
8	OFF	Disable port Alarm
	ON	Enable port Alarm. If the port's link fails, the fault LED will light up
9	OFF	Disable the ring master function
	ON	Enable the switch as the ring master in the X-Ring group

[NOTE]

1. When port alarm function is enabled, the fault LED will on and Alarm relay will activity when port failure occurs.
2. Please restart the switch after the X-Ring DIP switch is set.

LED Indicators

There are 7 diagnostic LEDs located on the front panel of the industrial switch. They provide real-time information of system and optional status. The following table provides description of the LED status and their meanings for the switch.

LED	Status	Meaning
Power	Green	The switch unit is power on
	Off	The switch unit is no power input
Power 1	Green	Power on
	Off	No power inputs
Power 2	Green	Power on

	Off	No power inputs
Fault	Yellow	Power failure or UTP port failure or Fiber port failure
	Off	No Power failure or UTP port failure or Fiber port failure occurs
R.M. (Ring Master)	Green	The industrial switch is the master of X-Ring group
	Off	The industrial switch is not a ring master in X-Ring group
LNK/ACT (Fiber port)	Green	The port is linking
	Blinks	The port is transmitting or receiving packets from the TX device
	Off	No device attached
FDX/COL (Fiber Port)	Yellow	The port is operating in full-duplex mode
	Blinks	Collision of Packets occurs in the port
	Off	The port in half-duplex mode or no device attached

Ports

RJ-45 ports

There are 6x 10/100Mbps auto-sensing ports for 10Base-T or 100Base-TX devices connection. The UTP ports will auto-sense for 10Base-T or 100Base-TX connections. Auto MDI/MDIX means that the switch can connect to another switch or workstation without changing straight through or crossover cabling. See the below figures for straight through and crossover cable schematic.

RJ-45 Pin Assignments

Pin Number	Assignment
1	Tx+
2	Tx-
3	Rx+
6	Rx-

[NOTE] "+" and "-" signs represent the polarity of the wires that make up each wire pair.

All ports on this industrial switch support automatic MDI/MDI-X operation, user can use straight-through cables (See figure below) for all network connections to PCs or servers, or to other switches or hubs. In straight-through cable, pins 1, 2, 3, and 6, at one end of the cable, are connected straight through to pins 1, 2, 3 and 6 at the other end of the cable. The table below shows the 10BASE-T/100BASE-TX MDI and MDI-X port pin outs.

Pin MDI-X	Signal Name	MDI Signal Name
1	Receive Data plus (RD+)	Transmit Data plus (TD+)
2	Receive Data minus (RD-)	Transmit Data minus (TD-)
3	Transmit Data plus (TD+)	Receive Data plus (RD+)
6	Transmit Data minus (TD-)	Receive Data minus (RD-)

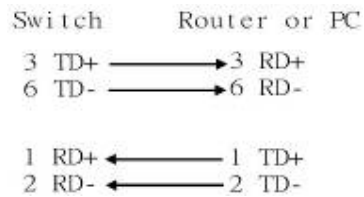

Straight Through Cable Schematic

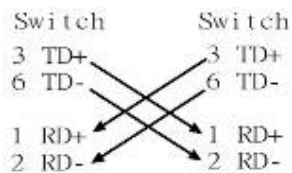

Cross Over Cable Schematic

Fiber Port

There are two 100Base-FX ports. The fiber port is ST type connector in multi mode (2Km) or single mode (30Km).

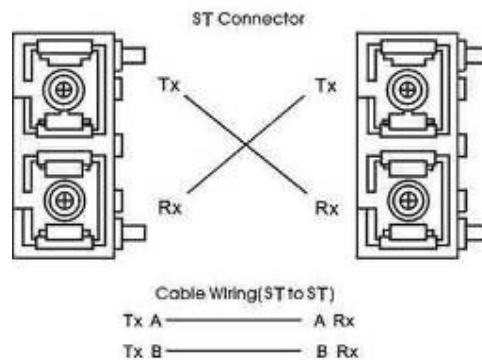

ATTENTION

This is a Class 1 Laser/LED product. Don't stare into the Laser/LED Beam.

Cabling

- Using four twisted-pair, Category 5 cabling for RJ-45 port connection. The cable between the converter and the link partner (switch, hub, workstation, etc.) must be less than 100 meters (328 ft.) long.
- Fiber segment using **single-mode** connector type must use 9/125 um single-mode fiber cable. User can connect two devices in the distance up to **30 Kilometers**.
- Fiber segment using **multi-mode** connector type must use 50 or 62.5/125 um multi-mode fiber cable. User can connect two devices up to **2Km** distances.

Wiring the Power Inputs

Please follow below steps to insert the power wire.

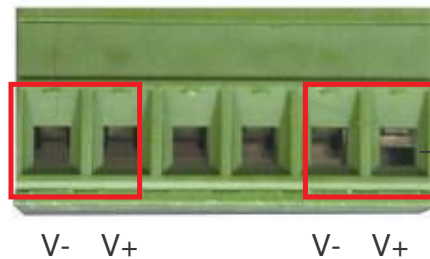

1. Insert the positive and negative wires into the V+ and V- connector on the terminal block connector.

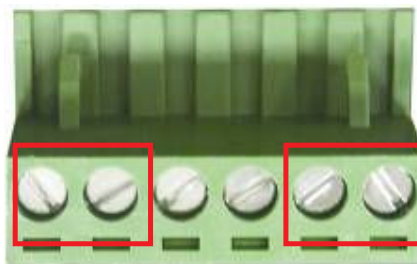

2. To tighten the wire-clamp screws for preventing the DC wires to loose.

[NOTE] The wire range of terminal block is from 12~ 24 AWG.

Wiring the Fault Alarm Contact

The fault alarm contact is in the middle of terminal block connector as below figure shows. By inserting the wires and set the DIP switch at "ON" status, it will detect the fault status which the power is failure or port link failure and form an open circuit. And, application example for the fault alarm contact as below:

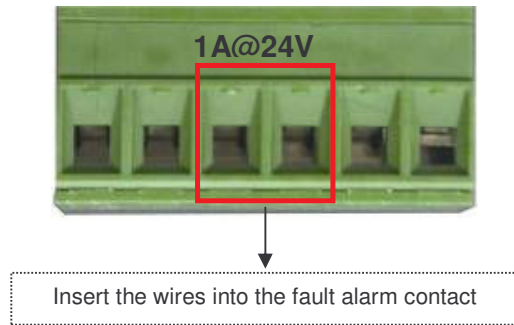

[NOTE] The wire range of terminal block is from 12~ 24 AWG.

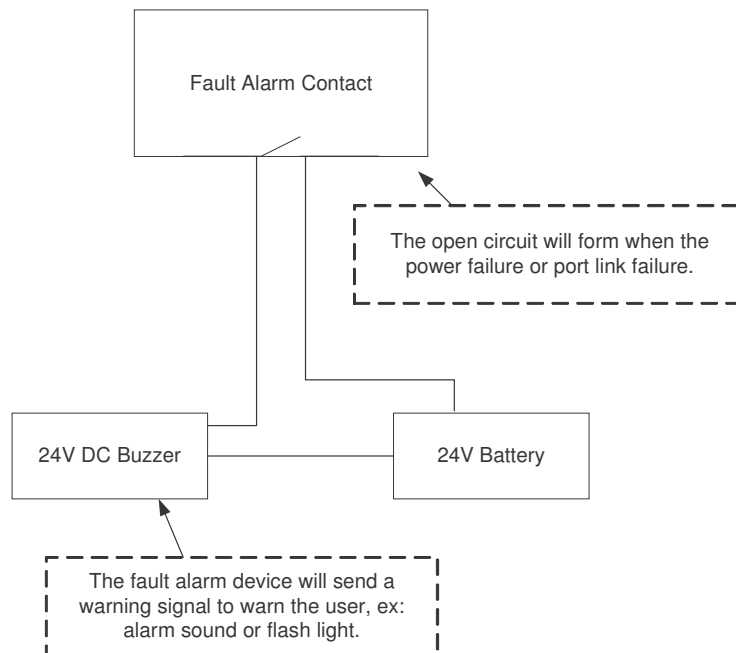

Mounting Installation

DIN-Rail Mounting

The DIN-Rail is screwed on the industrial switch when out of factory.

1. First, insert the top of DIN-Rail into the track.

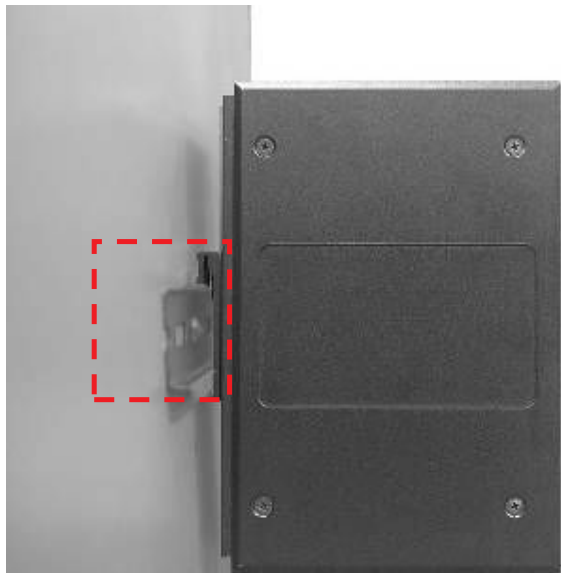

2. Then, lightly push the DIN-Rail into the track.

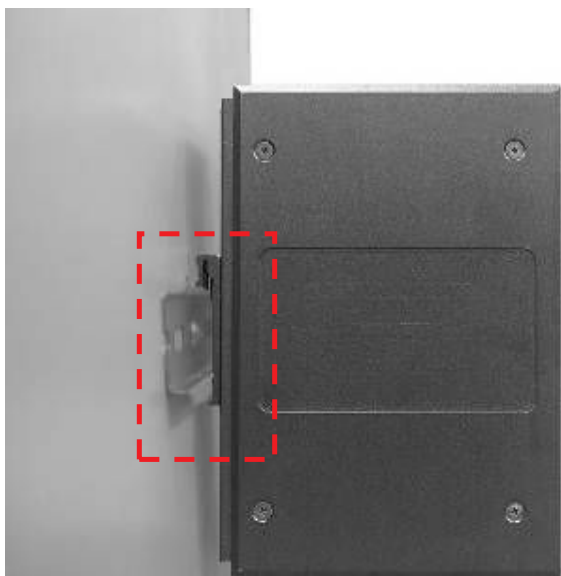

3. Check the DIN-Rail is tightly on the track.
4. To remove the industrial switch from the track, reverse steps above.

Wall Mount Plate Mounting

Follow the below steps to mount the industrial switch with wall mount plate.

1. Remove the DIN-Rail from the industrial switch; loose the screws to remove the DIN-Rail.
2. Place the wall mount plate on the rear panel of the industrial switch.
3. Use the screws to screw the wall mount plate on the industrial switch.
4. Use the hook holes at the corners of the wall mount plate to hang the industrial switch on the wall.
5. To remove the wall mount plate, reverse steps above.

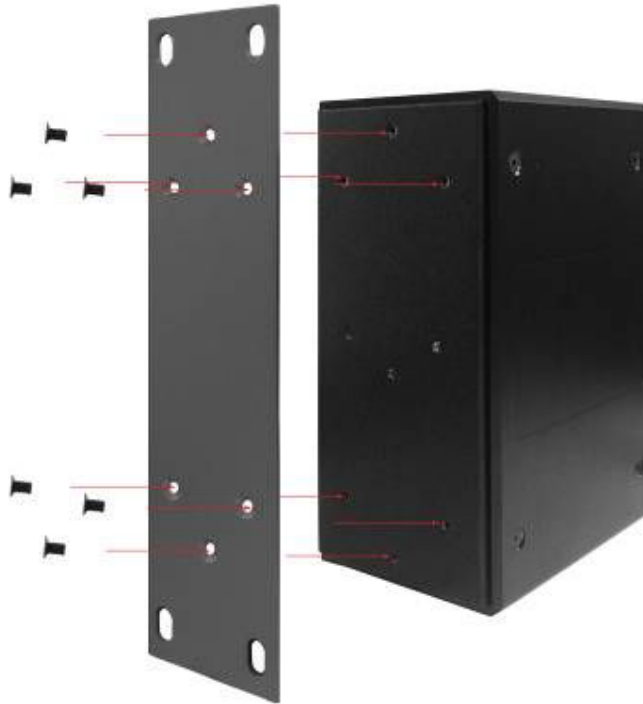

Screwing the wall mount plate on the Industrial media converter

Hardware Installation

Installation Steps

1. Unpacking the Industrial switch
2. Check the DIN-Rail is screwed on the Industrial switch. If the DIN-Rail is not screwed on the Industrial switch. Please refer to **DIN-Rail Mounting** section for DIN-Rail installation. If user want to wall mount the Industrial switch, then please refer to **Wall Mount Plate Mounting** section for wall mount plate installation.
3. To hang the Industrial switch on the DIN-Rail track or wall, please refer to the **Mounting Installation** section.
4. Power on the Industrial switch. How to wire the power; please refer to the **Wiring the Power Inputs** section. The power LED on the Industrial switch will light up. Please refer to the **LED Indicators** section for meaning of LED lights.
5. Prepare the twisted-pair, straight through Category 5 cable for Ethernet connection.
6. Insert one side of RJ-45 cable (category 5) into the Industrial switch Ethernet port (RJ-45 port) and another side of RJ-45 cable (category 5) to the network devices' Ethernet port (RJ-45 port), ex: Switch PC or Server. The UTP port (RJ-45) LED on the Industrial switch will light up when the cable connected with the network device. Please refer to the **LED Indicators** section for LED light meaning.

[NOTE] Be sure the connected network devices support MDI/MDI-X. If it does not support then use the crossover category-5 cable.

7. When all connections are all set and LED lights all show in normal, the installation is complete.

Network Application

This chapter provides some sample applications to help user to have more actual idea of industrial switch function application. A sample application of the industrial switch is as below:

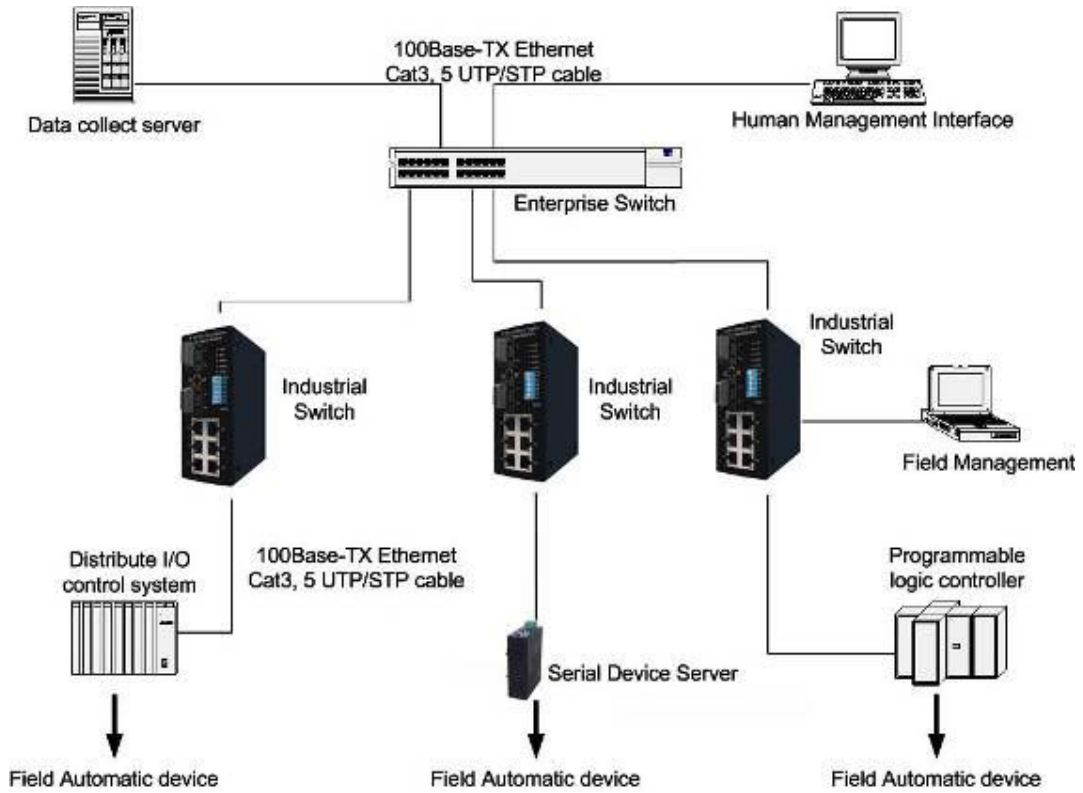

X-Ring Application

The industrial switch supports the X-Ring protocol that can help the network system to recovery from network connection failure within 300ms or less, and make the network system more reliable. The X-Ring algorithm is like as spanning tree protocol (STP) algorithm but it has faster recovery time than STP. The following figure is a sample X-Ring application.

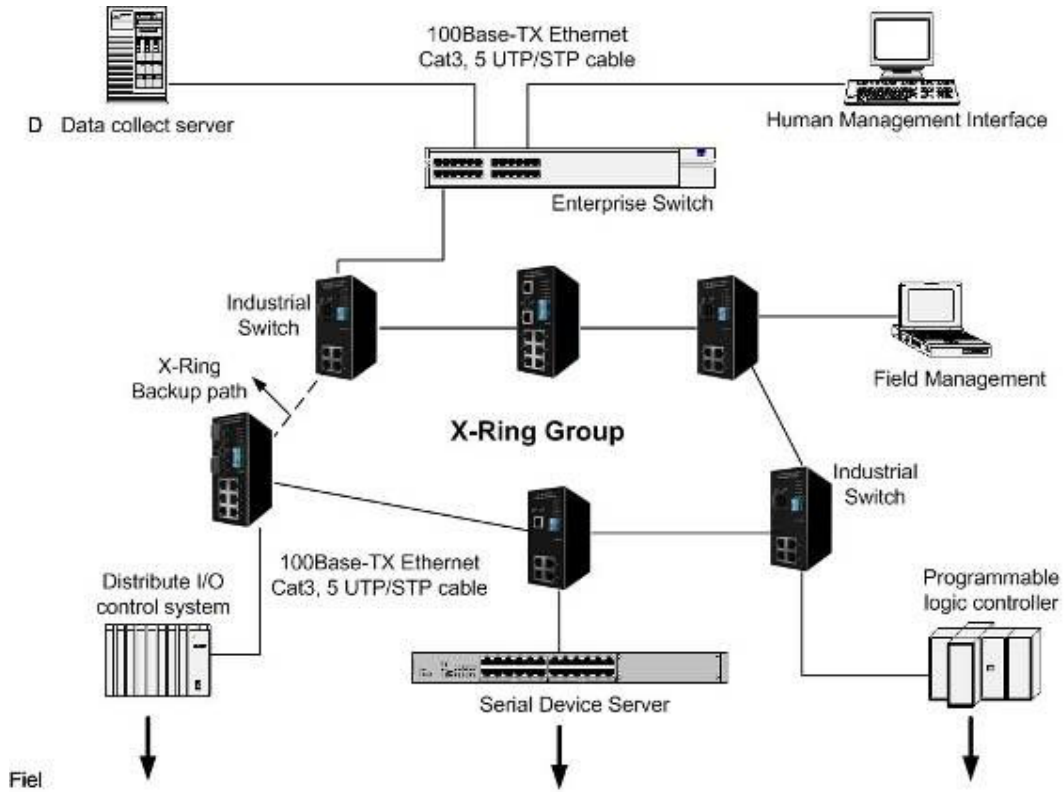

Coupling Ring Application

In the network, it may have more than one X-Ring group. By using the coupling ring function can connect each X-Ring for the redundant backup. It can ensure the transmissions between two ring groups will no failure. The following figure is a sample of coupling ring application.

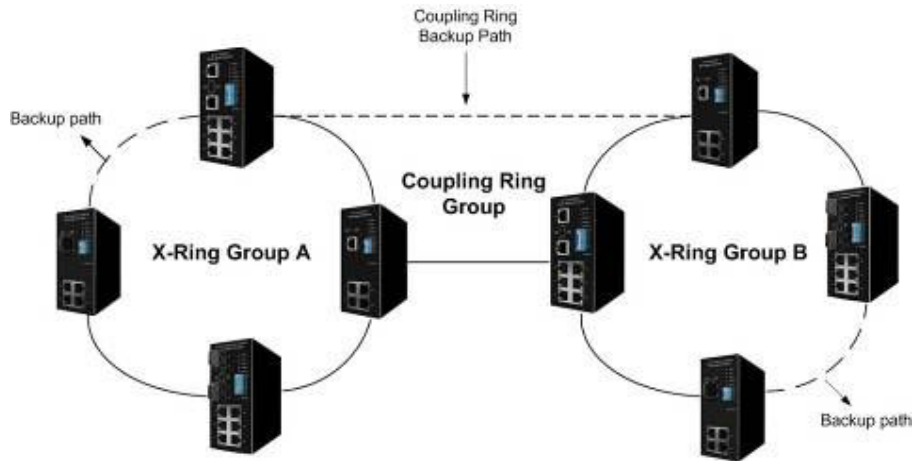

Dual Homing Application

Dual Homing function is to prevent a lost connection between X-Ring group and upper level/core switch. Assign two ports to be the Dual Homing port that is backup port in the X-Ring group. The Dual Homing function only works when the X-Ring function is active. Each X-Ring group only has one Dual Homing port.

[NOTE] In Dual Homing application architecture, the upper level switches need to enable the Rapid Spanning Tree protocol.

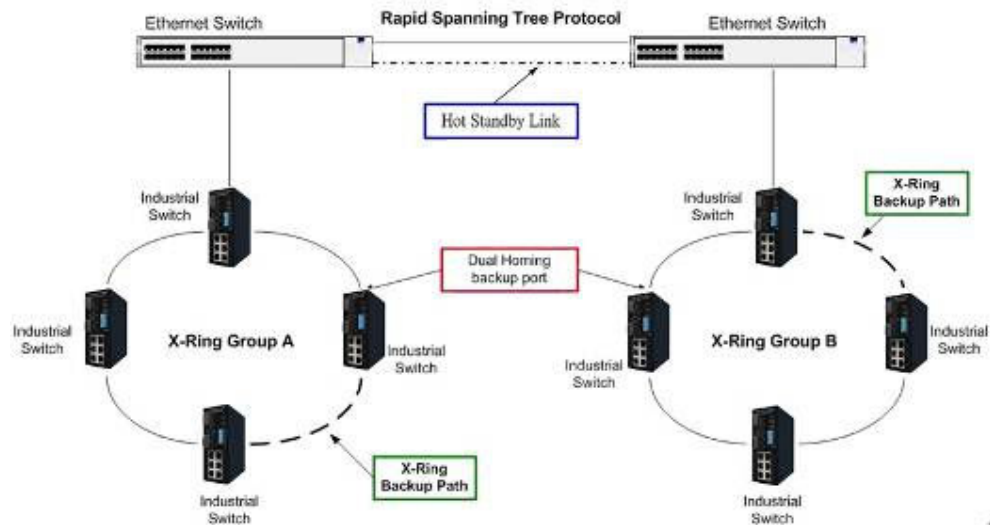

Web-Based Management

About Web-based Management

On CPU board of the switch there is an embedded HTML web site residing in flash memory, which offers advanced management features and allow users to manage the switch from anywhere on the network through a standard browser such as Microsoft Internet Explorer.

The Web-Based Management supports Internet Explorer 6.0. And, it is applied for Java Applets for reducing network bandwidth consumption, enhance access speed and present an easy viewing screen.

Preparing for Web Management

Before to use web management, install the industrial switch on the network and make sure that any one of PC on the network can connect with the industrial switch through the web browser. The industrial switch default value of IP, subnet mask, username and password is as below:

- IP Address: **192.168.16.1**
- Subnet Mask: **255.255.255.0**
- Default Gateway: **192.168.16.254**
- User Name: **root**
- Password: **root**

System Login

1. Launch the Internet Explorer on the PC
2. Key in "http://" + the IP address of the switch", and then Press "**Enter**".
3. The login screen will appear right after
4. Key in the user name and password. The default user name and password as "**root**"
5. Press "**Enter**" or "**OK**", and then the home screen of the Web-based management appears as below:

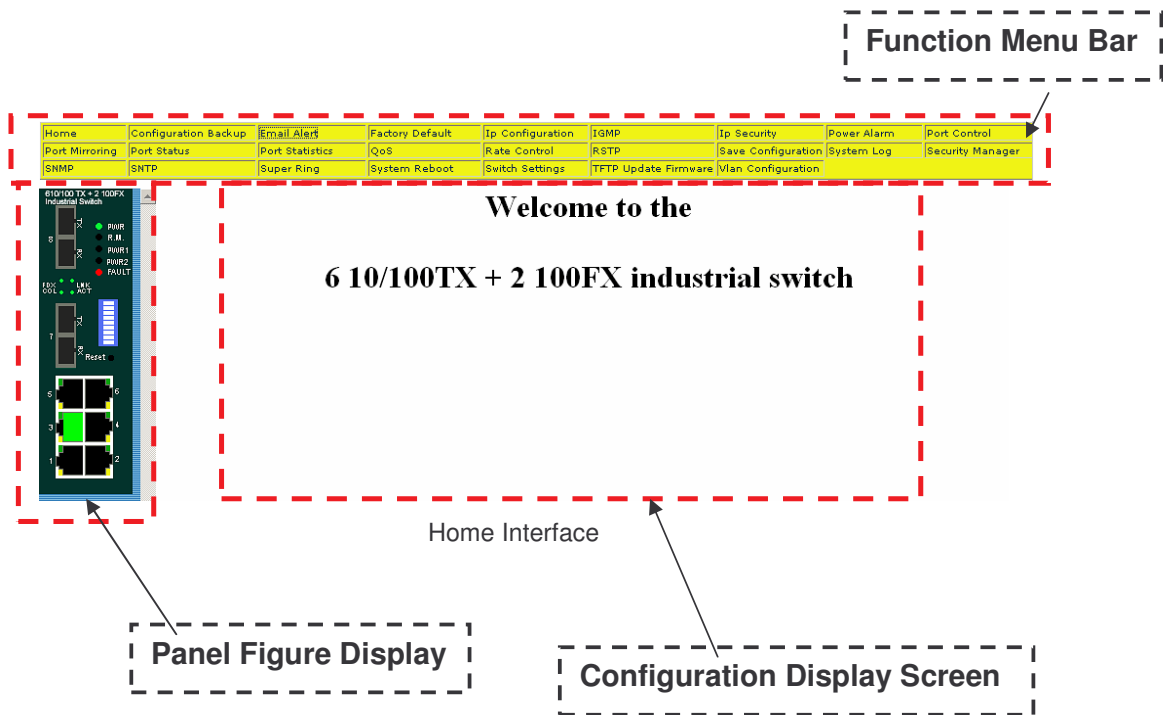

Port status

View every port status that depended on user's setting and the negotiation result

- **Port:** The port number
- **Type:** The speed mode, ex: 100TX = 100Mbps
- **Link:** "Down" means "No Link". "UP" is for "Link"
- **State:** Display port statuses "disable" or "enable". "Unlink" will be treated as "off"
- **Negotiation:** Display the auto negotiation mode: auto/force. "Config" means the value that user configured. "Actual" means the current value of the port
- **Speed Duplex:** Display port connection speed. "Config" means the value that user configured. "Actual" means the current value of the port
- **Flow Control:** Display the flow control status is "enable" or "disable" in full mode. "Config" means the value that user configured. "Actual" is for the current value of the port

Port Status									
Port	Type	Link	State	Negotiation	Speed Duplex		Flow Control		
					Config	Actual	Config	Actual	
Port.01	100TX	Down	Enable	Auto	100 Full	N/A	Symmetric	N/A	
Port.02	100TX	Down	Enable	Auto	100 Full	N/A	Symmetric	N/A	
Port.03	100TX	Down	Enable	Auto	100 Full	N/A	Symmetric	N/A	
Port.04	100TX	Down	Enable	Auto	100 Full	N/A	Symmetric	N/A	
Port.05	100TX	Up	Enable	Auto	100 Full	100 Full	Symmetric	Symmetric	
Port.06	100TX	Down	Enable	Auto	100 Full	N/A	Symmetric	N/A	
Port.07	100FX	Down	Enable	Force	100 Full	N/A	Asymmetric	N/A	
Port.08	100FX	Down	Enable	Force	100 Full	N/A	Asymmetric	N/A	

Port Status interface

Single Port Information

Click the port on the Panel figure on the web interface directly. Then, the single port information window will show up and display the port current information.

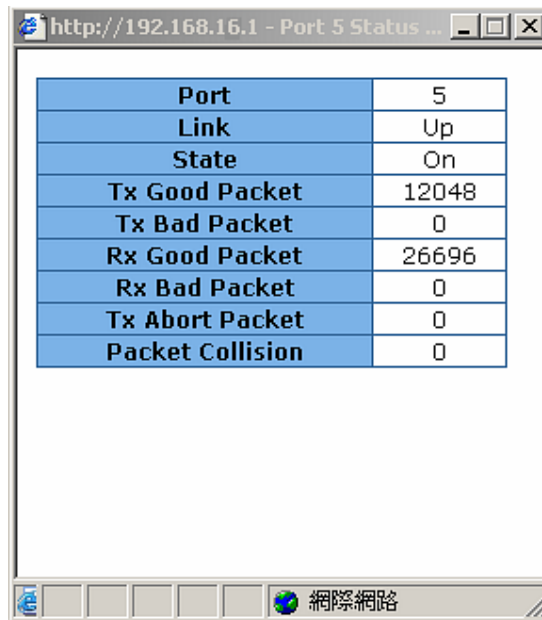

The screenshot shows a web browser window with the address bar displaying 'http://192.168.16.1 - Port 5 Status ...'. The main content area contains a table with the following data:

Port	5
Link	Up
State	On
Tx Good Packet	12048
Tx Bad Packet	0
Rx Good Packet	26696
Rx Bad Packet	0
Tx Abort Packet	0
Packet Collision	0

The browser's taskbar at the bottom shows the 'Internet Explorer' icon and the text '網際網路'.

Port information interface

Port Statistics

The following information provides the current port statistic information

- Click button to clean all counts

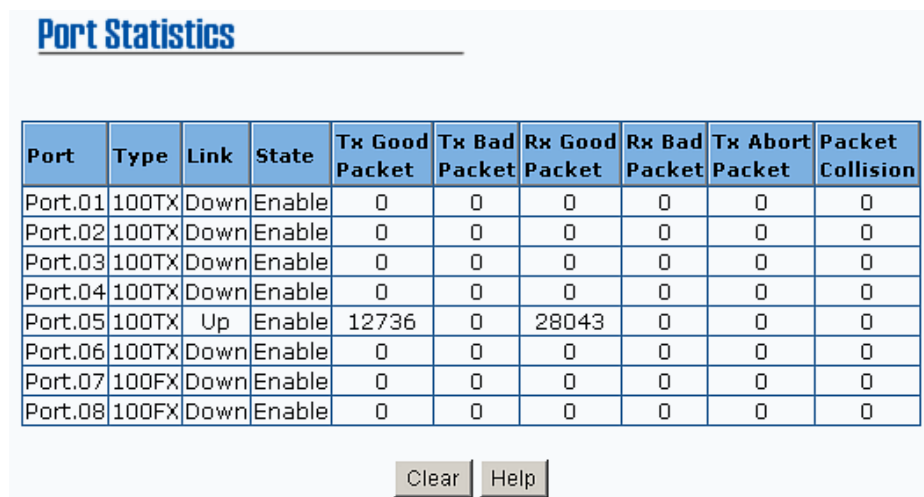

The screenshot shows a web interface titled 'Port Statistics'. It contains a table with the following data:

Port	Type	Link	State	Tx Good Packet	Tx Bad Packet	Rx Good Packet	Rx Bad Packet	Tx Abort Packet	Packet Collision
Port.01	100TX	Down	Enable	0	0	0	0	0	0
Port.02	100TX	Down	Enable	0	0	0	0	0	0
Port.03	100TX	Down	Enable	0	0	0	0	0	0
Port.04	100TX	Down	Enable	0	0	0	0	0	0
Port.05	100TX	Up	Enable	12736	0	28043	0	0	0
Port.06	100TX	Down	Enable	0	0	0	0	0	0
Port.07	100FX	Down	Enable	0	0	0	0	0	0
Port.08	100FX	Down	Enable	0	0	0	0	0	0

Below the table, there are two buttons: 'Clear' and 'Help'.

Port Statistics Interface

Port Control

Change the port status

- Select the port by scroll the **Port** column
- **State:** Disable or enable control of this port
- **Negotiation:** Set auto negotiation mode is Auto, Nway (specify the speed/duplex on this port and enable auto-negotiation), or Force
- **Speed:** Set the speed of the port
- **Duplex:** Set full-duplex or half-duplex mode of the port
- **Flow control:** Set flow control function is **Symmetric** or **Asymmetric** in Full Duplex mode. The default value is **Disable**
- And then, click button to apply all configuration
- When user select the port, user can see port current configure shows in below column

Port Configuration

Port	State	Negotiation	Speed	Duplex	Flow Control
Port.01					
Port.02	Enable	Auto	100	Full	Disable
Port.03					
Port.04					

Port	Type	Link	State	Negotiation	Speed Duplex		Flow Control		Group ID
					Config	Actual	Config	Actual	
Port.01	100TX	Down	Enable	Auto	100 Full	N/A	Disable	N/A	N/A

Port Control interface

Switch Setting

Assigning the system name, location and view the system information

- **System Name:** Assign the name of switch. The maximum length is 64 bytes
- **System Description:** Display the description of switch. Read only cannot be modified
- **System Location:** Assign the switch physical location. The maximum length is 64 bytes
- **System Contact:** Enter the name of contact person or organization
- **Firmware Version:** Display the switch's firmware version
- **Kernel Version:** Display the kernel software version

- **Hardware version:** Display the switch hardware version
- **MAC Address:** Display the unique hardware address assigned by manufacturer (default)

Switch Settings

System Description	6 10/100TX + 2 100FX Managed Industrial Switch
System Name	
System Location	
System Contact	

Firmware Version	v2.03
Kernel Version	v3.14
Hardware Version	A5.00
MAC Address	00003B3B4E24

Switch settings interface

[NOTE] Remember to execute the "Save Configuration" action, otherwise the new configuration will lose when switch power off.

Port Mirroring

The Port mirroring is a method for monitor traffic in switched networks. Traffic through ports can be monitored by one specific port. That is, traffic goes in or out monitored ports will be duplicated into mirror port.

- **Port Mirroring Mode:** Set mirror mode -- Disable, TX, and Both. The default value is "Disable"
- **Analysis Port:** It means mirror port can be used to see all monitor port traffic. User can connect mirror port to LAN analyzer or Netxray
- **Monitor Port:** The ports user wants to monitor. All monitor port traffic will be copied to mirror port. User can select max 7 monitor ports in the switch. User can choose which port that wants to monitor in only one mirror mode. Mark the **State** check box to select the port
- And then, click

Port Mirroring

Port Mirroring Mode : <input type="text" value="Disable"/>	
Analysis Port : <input type="text" value="None"/>	
Monitor Port	State
Port.01	<input type="checkbox"/>
Port.02	<input type="checkbox"/>
Port.03	<input type="checkbox"/>
Port.04	<input type="checkbox"/>
Port.05	<input type="checkbox"/>
Port.06	<input type="checkbox"/>
Port.07	<input type="checkbox"/>
Port.08	<input type="checkbox"/>

Port Mirroring interface

[NOTE]

1. Select the monitor mode as disable to disable the mirroring
 2. Remember to execute the "Save Configuration" action, otherwise the new configuration will lose when switch power off.
-

VLAN configuration

A Virtual LAN (VLAN) is a logical network grouping that limits the broadcast domain, which would, allow you to isolate network traffic so only the members of the VLAN will receive traffic from the same members of VLAN. Basically, creating a VLAN from a switch is logically equivalent of reconnecting a group of network devices to another Layer 2 switch. However, all the network devices are still plugged into the same switch physically.

The industrial switch supports port-based and 802.1Q (tagged-based) VLAN. In the default configuration, VLAN operation mode default is "Disable".

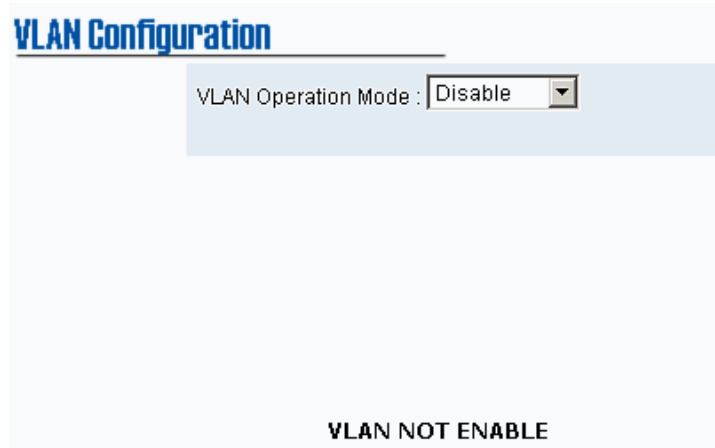

VLAN Configuration interface

Port-based VLAN

Packets can go among only members of the same VLAN group. Note all unselected ports are treated as belonging to another single VLAN. If the port-based VLAN enabled, the VLAN-tagging is ignored.

In order for an end station to send packets to different VLAN groups, it itself has to be either capable of tagging packets it sends with VLAN tags or attached to a VLAN-aware bridge that is capable of classifying and tagging the packet with different VLAN ID based on not only default PVID but also other information about the packet, such as the protocol.

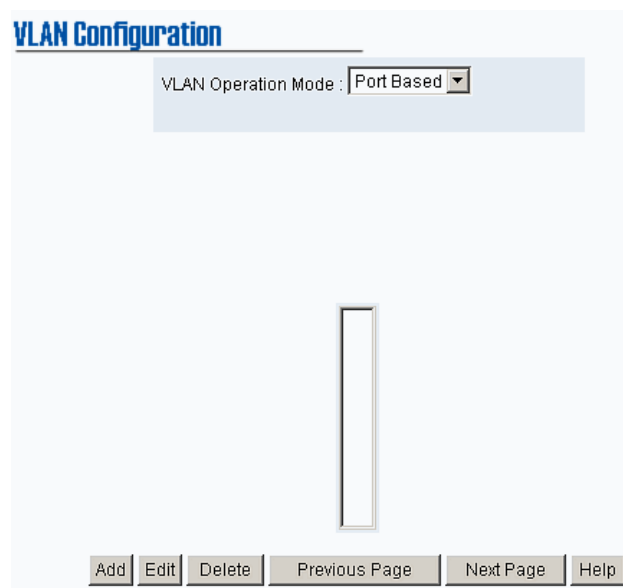

VLAN – PortBase interface

- Click **Add** to add a new VLAN group(The maximum VLAN group is up to 64 VLAN groups)
- Entering the VLAN name, group ID and grouping the members of VLAN group
- And then, click **Apply**

The screenshot shows the 'VLAN Configuration' interface. At the top, there is a dropdown menu for 'VLAN Operation Mode' set to 'Port Based'. Below this, there are input fields for 'Group Name' and 'VLAN ID' (containing the number '1'). A list of ports (Port.01 to Port.08) is shown on the left, with an 'Add' button and a 'Remove' button in the center. At the bottom, there are 'Apply' and 'Help' buttons.

VLAN—PortBase Add interface

- The VLAN group will list
- To view the another VLAN groups, click **Next Page**
- To delete unwanted VLAN, click **Delete** button
- To modify existing VLAN group, press **Edit** button

[NOTE] Remember to execute the “Save Configuration” action, otherwise the new configuration will lose when switch power off.

802.1Q VLAN

Tagged-based VLAN is an IEEE 802.1Q specification standard which it allows to create a VLAN across devices from different switch vendors. IEEE 802.1Q VLAN uses a technique to insert a “tag” into the Ethernet frames. Tag contains a VLAN Identifier (VID) that indicates the VLAN numbers.

All ports on the switch belong to default VLAN, VID is 1. The default VLAN can't be deleting. The maximum VLAN group is up to 64 VLAN groups.

The screenshot shows the 'VLAN Configuration' web interface. At the top, 'VLAN Operation Mode' is set to '802.1Q'. Below it, there is a checkbox for 'Management Vlan ID' which is currently unchecked, and a text input field containing '0'. An 'Apply' button is next to the input field. Below this is a navigation bar with two tabs: 'Basic' (selected) and 'Port VLAN ID'. The main area contains a table with one row labeled 'DEFAULT__1'. At the bottom, there are buttons for 'Add', 'Edit', 'Delete', 'Previous Page', 'Next Page', and 'Help'.

802.1q VLAN interface

Basic VLAN

- Click **Add** button
- **Management VLAN ID:** It is used for Remote Management Security. In fact, it can remote management that includes telnet, SNMP, and Web browse the switch, only when the port of VLAN group ID is equal to the Management VLAN ID. Fill the specific VLAN ID number in Management VLAN ID column and mark the check box, and then click **Apply** button to enable the function. For example: the management VLAN ID is 101, the VLAN group ID 101 includes the port 1, 2, and 4. Therefore, only port 1, 2, and 4 can remote management the switch. And, if the port is in two different VLAN groups and one of VLAN group ID is equal to the assigned Management VLAN ID, it still has the right to remote management the switch.
- **Group Name:** Assign a name for the new VLAN
- **VLAN ID:** Key in a VLAN ID (2~4094). The default is 1

- Grouping the ports and click **Add** button

VLAN Configuration

VLAN Operation Mode : 802.1Q

Management Vlan ID : 0 **Apply**

Basic | **Port VLAN ID**

Group Name

VLAN ID

Port.01
Port.02
Port.03
Port.04
Port.05
Port.06
Port.07
Port.08

Add

Remove

Next **Help**

802.1q VLAN –Add interface

- And then, click **Next** then follow interface as below.

VLAN Configuration

VLAN Operation Mode : 802.1Q

Management Vlan ID : 0 **Apply**

VLAN Name	V001		
VLAN ID	2		
UnTag Member			
Port.01	Untag	Port.02	Untag

Apply

- Click **Apply** to set the outgoing frames are VLAN-Tagged frames or untagged
 - **Tag:** Outgoing frames with VLAN-Tagged
 - **Untag:** Outgoing frames without VLAN-Tagged

Port VLAN ID

- Configure port VID settings
- **Port VLAN ID:** Enter the port VLAN ID
- And then, click **Apply**
- To reset back to default value, click **Default** button

VLAN Configuration

VLAN Operation Mode : 802.1Q

Management Vlan ID : 0 **Apply**

Basic

Port VLAN ID

Port	Port VLAN ID
Port.01 Port.02 Port.03 Port.04	<input style="width: 80%;" type="text" value="1"/>

Apply **Help**

Port	VLAN ID
Port.01	1

802.1q VLAN – Port VLAN ID interface

[NOTE] Remember to execute the “Save Configuration” action, otherwise the new configuration will lose when switch power off.

Alert

There are three kinds of alert – e-mail, event, and power alarm for user to configure.

Email Alert Configuration

When the specific events occur, the system will send the alert to the email account that is assigned by user. User can set up the mail server IP, mail account, and forwarded email account for receiving the event alert.

- **Email Alert:** To enable or disable the email alert function
- **SMTP Server IP Address:** Set up the mail server IP address
- **Authentication:** Mark the check box to enable and configure the email account and password for authentication
 - **Mail Account:** Set up the email account to receive the alert. Ex: johnadmin@123.com. The email account must exist on the mail server, which user had set up in **SMTP Server IP Address** column
 - **Password:** The email account password
 - **Confirm Password:** Re-confirm the password
- **E-mail Address of Recipient 1 ~ 4:** Assign up to 4 e-mail accounts also to receive the alert
- And then, click

Alert

Email Alert Configuration | Event Configuration | Power Alarm Configuration

E-mail Alert: ▾

SMTP Server IP Address :	<input type="text" value="0.0.0.0"/>
Sender's Email Address :	<input type="text"/>
<input type="checkbox"/> Authentication	
Mail Account :	<input type="text"/>
Password :	<input type="text"/>
Confirm Password :	<input type="text"/>
Email of Recipient 1 :	<input type="text"/>
Email of Recipient 2 :	<input type="text"/>
Email of Recipient 3 :	<input type="text"/>
Email of Recipient 4 :	<input type="text"/>

Email Alert Configuration interface

Event Configuration

The selected events that occur will send out the alert to the assigned SMTP server. Also, user can select port events for alerting.

- **System event selection:** 4 selections – Device cold start, Power status, SNMP Authentication Failure, and X-Ring topology changes. Mark the checkbox to select the event. When selected events occur, the system will send out the alerting
 - **Device cold start:** When the device executes cold start action, the system will send out the alert to the dedicate SMTP server
 - **Power status:** When the device power status has changed, the system will send out the alert to the dedicate SMTP server
 - **SNMP Authentication Failure:** When the SNMP authentication fail, the system will send out the alert to the dedicate SMTP server
 - **X-Ring topology change:** When the X-Ring topology has changed, the system will send out the alert to dedicate SMTP server
- **Port event selection:** Select the per port events. Per port has 3 selections – Link UP, Link Down, and Link UP & Link Down. Disable means no event is selected
 - **Link UP:** The system will send out an alert when port connection is up only
 - **Link Down:** The system will send out an alert message when port connection is down only
 - **Link UP & Link Down:** The system will send out an alert message when port connection is up and down
- After selected, click 

Alert

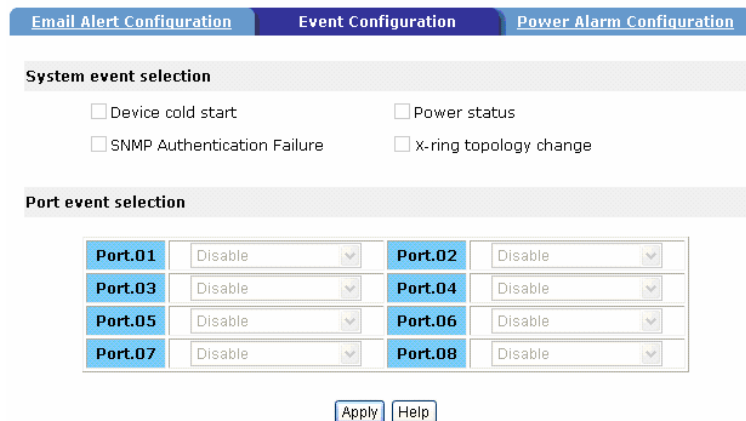

The screenshot shows the 'Event Configuration' tab in a web interface. It features three tabs: 'Email Alert Configuration', 'Event Configuration' (selected), and 'Power Alarm Configuration'. Under 'System event selection', there are four checkboxes: 'Device cold start', 'Power status', 'SNMP Authentication Failure', and 'x-ring topology change'. Under 'Port event selection', there is a table with 8 columns (Port.01 to Port.08) and 4 rows. Each cell contains a dropdown menu with 'Disable' selected. At the bottom, there are 'Apply' and 'Help' buttons.

Port.01	Disable	Port.02	Disable
Port.03	Disable	Port.04	Disable
Port.05	Disable	Port.06	Disable
Port.07	Disable	Port.08	Disable

Event Configuration interface

Power Alarm Configuration

Power alarm function enables the Relay alarm action. Without enabling power alarm function, the Relay alarm action will not work even the Relay alarm is set.

- Mark the check box and click  button

Alert

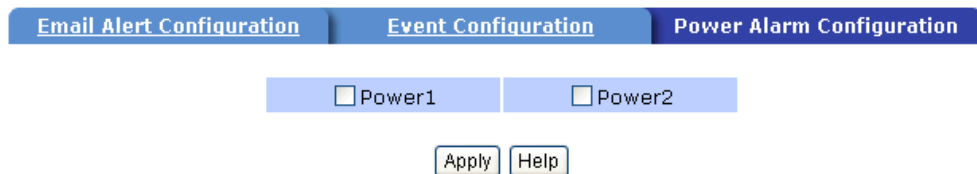

Power Alarm interface

IP Configuration

User can configure the IP Settings and DHCP client function

- **DHCP Client:** To enable or disable the DHCP client function. When DHCP client function is enabling, the industrial switch will be assigned the IP address from the network DHCP server. The default IP address will be replace by the DHCP server assigned IP address. After user click “Apply” button, a popup dialog show up. It is to inform the user that when the DHCP client is enabling, the current IP will lose and user should find the new IP on the DHCP server. To cancel the enabling DHCP client function, click “cancel”
- **IP Address:** Assign the IP address that the network is using. If DHCP client function is enabling, and then user don’t need to assign the IP address. And, the network DHCP server will assign the IP address for the industrial switch and display in this column. The default IP is 192.168.16.1
- **Subnet Mask:** Assign the subnet mask of the IP address. If DHCP client function is enabling, and then user do not need to assign the subnet mask
- **Gateway:** Assign the network gateway for the industrial switch. The default gateway is 192.168.16.254
- And then, click  button

IP Configuration

DHCP Client :

IP Address	<input type="text" value="192.168.16.1"/>
Subnet Mask	<input type="text" value="255.255.255.0"/>
Gateway	<input type="text" value="192.168.16.254"/>

IP configuration interface

SNTP Configuration

User can configure the SNTP (Simple Network Time Protocol) settings. The SNTP allows user to synchronize switch clocks in the Internet.

- **SNTP Client:** To enable or disable SNTP function to get the time from the SNTP server
- **Daylight Saving Time:** To enable or disable daylight saving time function. When daylight saving time is enabling, user need to configure the daylight saving time period
- **UTC Timezone:** Set the switch location time zone. The following table lists the different location time zone for the reference. User also can drag down the list to find the time zone user want it.

Local Time Zone	Conversion from UTC	Time at 12:00 UTC
November Time Zone	- 1 hour	11 am
Oscar Time Zone	-2 hours	10 am
ADT - Atlantic Daylight	-3 hours	9 am
AST - Atlantic Standard EDT - Eastern Daylight	-4 hours	8 am
EST - Eastern Standard CDT - Central Daylight	-5 hours	7 am
CST - Central Standard MDT - Mountain Daylight	-6 hours	6 am
MST - Mountain Standard PDT - Pacific Daylight	-7 hours	5 am
PST - Pacific Standard ADT - Alaskan Daylight	-8 hours	4 am
ALA - Alaskan Standard	-9 hours	3 am
HAW - Hawaiian Standard	-10 hours	2 am
Nome, Alaska	-11 hours	1 am
CET - Central European FWT - French Winter MET - Middle European	+1 hour	1 pm

MEWT - Middle European Winter SWT - Swedish Winter		
EET - Eastern European, USSR Zone 1	+2 hours	2 pm
BT - Baghdad, USSR Zone 2	+3 hours	3 pm
ZP4 - USSR Zone 3	+4 hours	4 pm
ZP5 - USSR Zone 4	+5 hours	5 pm
ZP6 - USSR Zone 5	+6 hours	6 pm
WAST - West Australian Standard	+7 hours	7 pm
CCT - China Coast, USSR Zone 7	+8 hours	8 pm
JST - Japan Standard, USSR Zone 8	+9 hours	9 pm
EAST - East Australian Standard GST Guam Standard, USSR Zone 9	+10 hours	10 pm
IDLE - International Date Line NZST - New Zealand Standard NZT - New Zealand	+12 hours	Midnight

- **SNTP Sever IP:** Set the SNTP server IP address
- **Switch Timer:** Display the switch current time
- **Daylight Saving Period:** Set up the Daylight Saving beginning and ending time. Daylight Saving beginning and ending time will be different in every year
- **Daylight Saving Offset (mins):** Configure the offset value
- And then, click button

[NOTE] Remember to execute the “Save Configuration” action, otherwise the new configuration will lose when switch power off.

SNTP Configuration

SNTP Client :

Daylight Saving Time :

UTC Timezone	<input type="button" value="(GMT)Greenwich Mean Time: Dublin, Edinburgh, Lisbon, London"/>	
SNTP Server IP	<input type="text" value="0.0.0.0"/>	
Switch Timer	<input type="text"/>	
Daylight Saving Period	<input type="text" value="20040101 00:00"/>	<input type="text" value="20040101 00:00"/>
Daylight Saving Offset(mins)	<input type="text" value="0"/>	

SNTP Configuration

IP Security

IP security function allows user to assign 10 specific IP addresses that have permission to access the switch through the web browser for the securing switch management.

- **Enable the IP Security:** Mark the check box to enable the IP security function
- **Security IP 1 ~ 10:** Assign up to 10 specific IP address. Only these 10 IP address can access and manage the switch through the Web browser
- And then, click **Apply** button to apply the configuration

[NOTE] Remember to execute the "Save Configuration" action, otherwise the new configuration will lose when switch power off.

Security IP1	0.0.0.0
Security IP2	0.0.0.0
Security IP3	0.0.0.0
Security IP4	0.0.0.0
Security IP5	0.0.0.0
Security IP6	0.0.0.0
Security IP7	0.0.0.0
Security IP8	0.0.0.0
Security IP9	0.0.0.0
Security IP10	0.0.0.0

IP Security Interface

RSTP Configuration

The Rapid Spanning Tree Protocol (RSTP) is an evolution of the Spanning Tree Protocol and provides for faster spanning tree convergence after a topology change. The system also supports STP and the system will auto detect the connected device that is running STP or RSTP protocol.

System Configuration

- User can view spanning tree information about the Root Bridge
- User can modify RSTP state. After modification, click **Apply** button
 - **RSTP mode:** user must enable or disable RSTP function before configure the related parameters
 - **Priority (0-61440):** a value used to identify the root bridge. The bridge with the lowest value has the highest priority and is selected as the root. If the value changes, user must reboot the switch. The value must be multiple of 4096 according to the protocol standard rule
 - **Max Age (6-40):** the number of seconds a bridge waits without receiving Spanning-tree Protocol configuration messages before attempting a reconfiguration. Enter a value between 6 through 40
 - **Hello Time (1-10):** the time that controls switch sends out the BPDU packet to check RSTP current status. Enter a value between 1 through 10
 - **Forward Delay Time (4-30):** the number of seconds a port waits before changing from its Rapid Spanning-Tree Protocol learning and listening states to the forwarding state. Enter a value between 4 through 30

[NOTE]

1. Must follow the rule to configure the MAX Age, Hello Time, and Forward Delay Time
 $2 \times (\text{Forward Delay Time value} - 1) \geq \text{Max Age value} \geq 2 \times (\text{Hello Time value} + 1)$
 2. Remember to execute the "Save Configuration" action, otherwise the new configuration will lose when switch power off
-

Rapid Spanning Tree

System Configuration

Per Port Configuration

RSTP Mode	Enable
Priority (0-61440)	32768
Max Age (6-40)	20
Hello Time (1-10)	2
Forward Delay Time (4-30)	15

Priority must be a multiple of 4096
 $2 \times (\text{Forward Delay Time} - 1)$ should be greater than or equal to the Max Age.
The Max Age should be greater than or equal to $2 \times (\text{Hello Time} + 1)$.

Apply

Root Bridge Information

Bridge ID	8000001122334455
Root Priority	32768
Root Port	Root
Root Path Cost	0
Max Age	20
Hello Time	2
Forward Delay	15

RSTP– System Configuration Interface

Per Port Configuration

Configure path cost and priority of every port

- Select the port in Port column
- **Path Cost:** The cost of the path to the other bridge from this transmitting bridge at the specified port. Enter a number 1 through 200000000
- **Priority:** Decide which port should be blocked by priority in LAN. Enter a number 0 through 240. The value of priority must be the multiple of 16
- **Admin P2P:** Some of the rapid state transactions that are possible within RSTP are dependent upon whether the port concerned can only be connected to exactly one other bridge (i.e. it is served by a point-to-point LAN segment), or can be connected to two or more bridges (i.e. it is served by a shared medium LAN segment). This function allows the P2P status of the link to be manipulated administratively. True is P2P enabling. False is P2P disabling
- **Admin Edge:** The port directly connected to end stations cannot create bridging loop in the network. To configure the port as an edge port, set the port to "True" status
- **Admin Non Stp:** The port includes the STP mathematic calculation. True is not including STP mathematic calculation. False is including the STP mathematic calculation
- And then, click button

[NOTE] Remember to execute the "Save Configuration" action, otherwise the new configuration will lose when switch power off.

Rapid Spanning Tree

System Configuration
Per Port Configuration

Port	Path Cost (1-200000000)	Priority (0-240)	Admin P2P	Admin Edge	Admin Non Stp
<div style="border: 1px solid black; padding: 2px;"> Port.01 ▲ Port.02 Port.03 Port.04 Port.05 ▼ </div>	<input type="text" value="200000"/>	<input type="text" value="128"/>	Auto ▼	True ▼	False ▼

priority must be a multiple of 16

RSTP Port Status

Port	Path Cost	Port Priority	Admin P2P	Admin Edge	Stp Neighbor	State	Role
Port.01	200000	128	True	True	False	Disabled	Disabled
Port.02	200000	128	True	True	False	Disabled	Disabled
Port.03	200000	128	True	True	False	Disabled	Disabled
Port.04	200000	128	True	True	False	Disabled	Disabled
Port.05	200000	128	True	False	True	Forwarding	Root
Port.06	200000	128	True	True	False	Disabled	Disabled
Port.07	200000	128	True	True	False	Disabled	Disabled
Port.08	200000	128	True	True	False	Disabled	Disabled

RSTP – Per Port Configuration interface

X-Ring

X-Ring provides a faster redundant recovery than Spanning Tree topology. The action is similar with STP or RSTP, but the algorithms not the same.

In the X-Ring topology, every switch should enable X-Ring function and assign two member ports in the ring. Only one switch in the X-Ring group would be set as a backup switch that one of two member ports would be blocking, called backup port, and another port is called working port. Other switches are called working switches and their two member ports are called working ports. When the network connection failure, the backup port will automatically become a working port to recovery the failure.

The switch supports one Dipswitch for setting the switch as the ring master or slave mode. The ring master has the rights to negotiate and place command to other switches in the X-Ring group. If there are 2 or more switches are in master mode, then software will select the switch with lowest MAC address number as the ring master. The X-Ring master ring mode will be enabling by the DIP Switch. When the switch is set to the master ring mode, the X-Ring configuration interface will display the switch as the master ring message. Also, user can identify the switch as the ring master from the R.M. LED panel of the LED panel on the switch.

The system also supports the coupling ring that can connect 2 or more X-Ring group for the redundant backup function and dual homing function that prevent connection lose between X-Ring group and upper level/core switch.

- **Enable X-Ring:** To enable the X-Ring function. Marking the check box to enable the X-Ring function.
- **1st & 2nd Working Ports:** Assign two ports as the member ports. One port will be working port and one port will be the backup port. The system will automatically decide which port is working port and which port is backup port.
- **Enable Coupling Ring:** To enable the coupling ring function. Marking the check box to enable the coupling ring function.
- **Coupling port:** Assign the member port.
- **Control port:** Set the switch as the master switch in the coupling ring.
- **Enable Dual Homing:** Set up one of port on the switch to be the Dual Homing port. In an X-Ring group, maximum Dual Homing port is one. Dual Homing only work when the X-Ring function enable.
- And then, click  to apply the configuration.

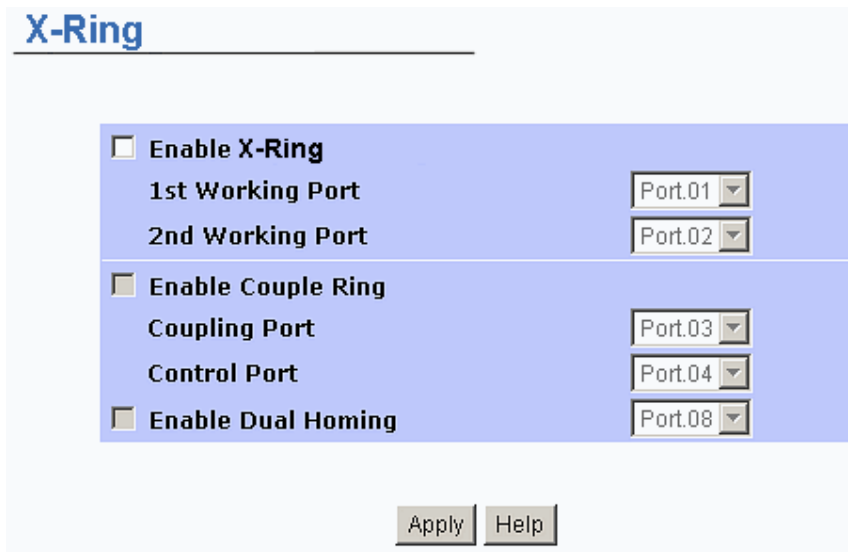

X-Ring	
<input type="checkbox"/> Enable X-Ring	
1st Working Port	Port.01
2nd Working Port	Port.02
<input type="checkbox"/> Enable Couple Ring	
Coupling Port	Port.03
Control Port	Port.04
<input type="checkbox"/> Enable Dual Homing	Port.08

Apply Help

X-Ring Interface

[NOTE]

1. When the X-Ring function enable, user must disable the RSTP. The X-Ring function and RSTP function cannot exist at the same time.
 2. Remember to execute the "Save Configuration" action, otherwise the new configuration will lose when switch power off.
-

QoS Configuration

Configure QoS setting of the every port

- **Oos Policy:** Select the QoS policy rule
 - **Using the 8,4,2,1 weight fair queue scheme:** The switch will follow 8:4:2:1 rate to process priority queue from Hi to lowest queue. For example: the system will process 8 high queue packets, 4 middle queue packets, 2 low queue packets, and the one lowest queue packets at the same time
 - **Use the strict priority scheme:** The higher queue will always be process first, except higher queue is empty
- **Priority Type:** Every port has 5 priority type selections
 - **Port-base:** The port priority will follow the **default port priority** that user have assigned – High, middle, low, or lowest
 - **COS only:** The port priority will only follow the **COS priority** that user have assigned
 - **TOS only:** The port priority will only follow the **TOS priority** that user have assigned
 - **COS first:** The port priority will follow the COS priority first, and then other priority rule
 - **TOS first:** The port priority will follow the TOS priority first, and the other priority rule
- **COS priority:** Set the COS priority level 0~7
- **TOS priority:** The system provides 0~63 TOS priority level. Each level has 4 types of priority – high, mid, low, and lowest. The default value is “Lowest” priority for each level. When the IP packet is received, the system will check the TOS level value in the IP packet has received. For example: user set the TOS level 25 is high. The port 1 is following the TOS priority policy only. When the packet received by port 1, the system will check the TOS value of the received IP packet. If the TOS value of received IP packet is 25(priority = high), and then the packet priority will have highest priority.

[NOTE] QoS and Rate control cannot be existed at the same time.

QoS

Qos Policy

- Use an 8,4,2,1 weighted fair queuing scheme
- Use a strict priority scheme

Priority Type:

Port.01	Port.02	Port.03	Port.04	Port.05	Port.06	Port.07	Port.08
Port-based ▾	Port-based ▾	Port-based ▾	Port-based ▾	Port-based ▾	Port-based ▾	Port-based ▾	Port-based ▾

Default Port Priority:

Port.01	Port.02	Port.03	Port.04	Port.05	Port.06	Port.07	Port.08
Lowest ▾	Lowest ▾	Lowest ▾	Lowest ▾	Lowest ▾	Lowest ▾	Lowest ▾	Lowest ▾

Apply Help

COS

Priority	0	1	2	3	4	5	6	7
	Lowest ▾	Lowest ▾	Lowest ▾	Lowest ▾	Lowest ▾	Lowest ▾	Lowest ▾	Lowest ▾

Apply Help

TOS

Priority	0	1	2	3	4	5	6	7
	Lowest ▾	Lowest ▾	Lowest ▾	Lowest ▾	Lowest ▾	Lowest ▾	Lowest ▾	Lowest ▾
Priority	8	9	10	11	12	13	14	15
	Lowest ▾	Lowest ▾	Lowest ▾	Lowest ▾	Lowest ▾	Lowest ▾	Lowest ▾	Lowest ▾
Priority	16	17	18	19	20	21	22	23
	Lowest ▾	Lowest ▾	Lowest ▾	Lowest ▾	Lowest ▾	Lowest ▾	Lowest ▾	Lowest ▾
Priority	24	25	26	27	28	29	30	31
	Lowest ▾	Lowest ▾	Lowest ▾	Lowest ▾	Lowest ▾	Lowest ▾	Lowest ▾	Lowest ▾
Priority	32	33	34	35	36	37	38	39
	Lowest ▾	Lowest ▾	Lowest ▾	Lowest ▾	Lowest ▾	Lowest ▾	Lowest ▾	Lowest ▾
Priority	40	41	42	43	44	45	46	47
	Lowest ▾	Lowest ▾	Lowest ▾	Lowest ▾	Lowest ▾	Lowest ▾	Lowest ▾	Lowest ▾
Priority	48	49	50	51	52	53	54	55
	Lowest ▾	Lowest ▾	Lowest ▾	Lowest ▾	Lowest ▾	Lowest ▾	Lowest ▾	Lowest ▾
Priority	56	57	58	59	60	61	62	63
	Lowest ▾	Lowest ▾	Lowest ▾	Lowest ▾	Lowest ▾	Lowest ▾	Lowest ▾	Lowest ▾

Apply Help

QoS configuration Interface

IGMP

The Internet Group Management Protocol (IGMP) is an internal protocol of the Internet Protocol (IP) suite. IP manages multicast traffic by using switches, routers, and hosts that support IGMP. Enabling IGMP allows the ports to detect IGMP queries and report packets and manage IP multicast traffic through the switch. IGMP have three fundamental types of message as follows:

Message	Description
Query	A message sent from the querier (IGMP router or switch) asking for a response from each host belonging to the multicast group.
Report	A message sent by a host to the querier to indicate that the host wants to be or is a member of a given group indicated in the report message.
Leave Group	A message sent by a host to the querier to indicate that the host has quit to be a member of a specific multicast group.

User can enable **IGMP protocol** and **IGMP Query** function in here. User will see the IGMP snooping information in this section -- difference multicast group VID and member port, and IP multicast addresses range from 224.0.0.0 through 239.255.255.255.

IGMP

IP Address	VLAN ID	Member Port
235.080.068.083	1	****5****

IGMP Protocol:

IGMP Query :

IGMP Snooping interface

[NOTE] Remember to execute the “Save Configuration” action, otherwise the new configuration will lose when switch power off.

Security Manager

Change web management login user name and password for the management security issue

1. **User name:** Key in the new user name(The default is “admin”)
2. **Password:** Key in the new password(The default is “admin”)
3. **Confirm password:** Re-type the new password

4. And then, click

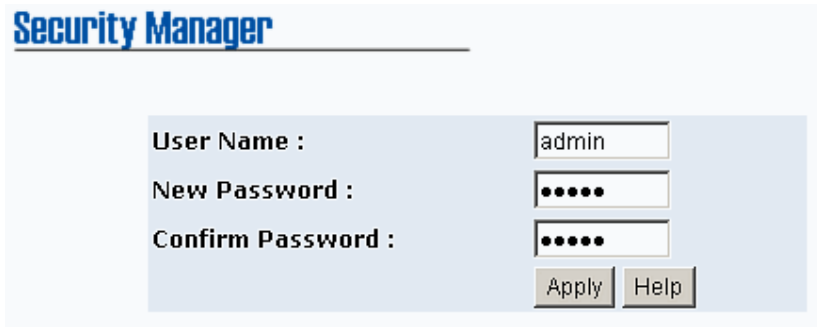

The screenshot shows the 'Security Manager' interface. It features three input fields: 'User Name' with the value 'admin', 'New Password' with five dots, and 'Confirm Password' with five dots. Below these fields are two buttons: 'Apply' and 'Help'.

Security Manager interface

[NOTE] Remember to execute the “Save Configuration” action, otherwise the new configuration will lose when switch power off.

SNMP Configuration

The SNMP is a Protocol that governs the transfer of information between management and agent. The switch supports SNMP V1.

User can define management stations as trap managers and to enter SNMP community strings. User also can define a name, location, and contact person for the switch. Fill in the system options data, and then click Apply to update the changes.

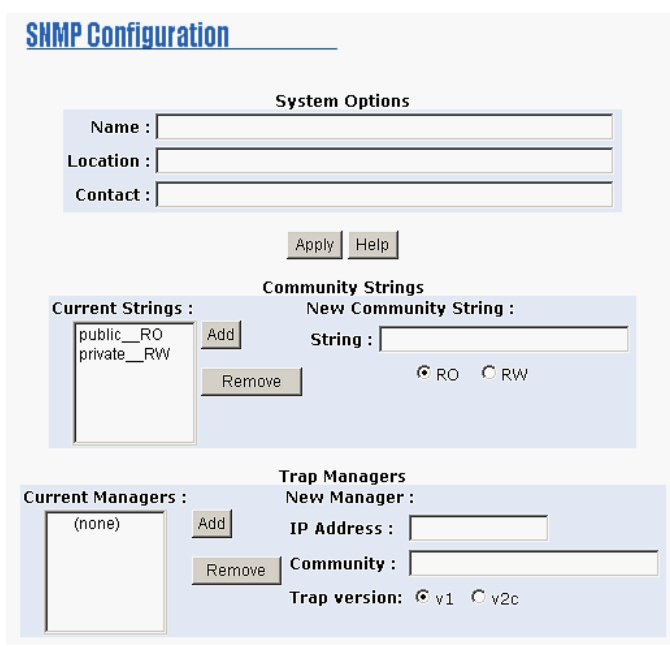

The screenshot shows the 'SNMP Configuration' interface. It is divided into three main sections: 'System Options', 'Community Strings', and 'Trap Managers'.
1. **System Options:** Contains three input fields for 'Name', 'Location', and 'Contact'.
2. **Community Strings:** Includes a list of 'Current Strings' (public_RO, private_RW) with 'Add' and 'Remove' buttons. It also has a 'New Community String' section with a 'String' input field and radio buttons for 'RO' (selected) and 'RW'.
3. **Trap Managers:** Includes a list of 'Current Managers' (none) with 'Add' and 'Remove' buttons. It also has a 'New Manager' section with 'IP Address' and 'Community' input fields, and radio buttons for 'Trap version' (v1 selected, v2c).

SNMP Management interface

System Options

- **Name:** Enter a name for the switch
- **Location:** Enter the switch physical location
- **Contact:** Enter the name of contact person or organization

Community strings

Serve as a password.

- **Strings:** Key in the name of string
- **RO:** Read only. Enables requests accompanied by this string to display MIB-object information
- **RW:** Read write. Enables requests accompanied by this string to display MIB-object information and to set MIB objects
- And then, click

Trap Manager

A trap manager is a management station that receives traps, the system alerts generated by the switch. If no trap manager is defined, no traps will issue. Create a trap manager by entering the IP address of the station and a community string.

- **IP Address:** Key in the trap device IP
- **Community Strings:** The trap device community strings
- And then, click

Configuration Backup

In Configuration Backup, user can restore the backup configuration into the industrial switch. Also, user can backup the configuration to TFTP server.

TFTP Restore Configuration

User can restore flash ROM value from TFTP server, but user must put the backup image in TFTP server, industrial switch will download the image back to the flash.

- **TFTP Server IP Address:** Key in the TFTP server IP
- **Restore File Name:** Key in the restore file image name
- And then, click

Configuration Backup

TFTP Restore Configuration TFTP Backup Configuration

TFTP Server IP Address	0.0.0.0
Restore File Name	data.dat

Apply Help

TFTP Restore Configuration interface

TFTP Backup Configuration

User can save current flash ROM value from the industrial switch to the TFTP server, then go to the TFTP restore configuration page to restore the image value back to the industrial switch.

- **TFTP Server IP Address:** Key in the TFTP server IP
- **Backup File Name:** Key in the file image name
- And then, click

Configuration Backup

TFTP Restore Configuration TFTP Backup Configuration

TFTP Server IP Address	0.0.0.0
Backup File Name	data.dat

Apply Help

TFTP Backup Configuration interface

TFTP Update Firmware

It provides the functions to allow a user to update the switch firmware. Before updating, make sure user have user TFTP server ready and the firmware image is on the TFTP server.

- **TFTP Server IP Address:** Key in user TFTP server IP
- **Firmware File Name:** Key in the name of firmware image

- And then, click **Apply**

TFTP Update Firmware

TFTP Server IP Address	192.168.16.2
Firmware File Name	image.bin

Apply **Help**

TFTP Update Firmware interface

Factory Default

Reset Switch to default configuration. Except the IP address, subnet mask, default gateway, username, and password will remain as user configured.

- Click **Default** button to reset switch to default setting

Factory Default

Please click **[Default]** button to restore factory default setting.

Default **Help**

Factory Default interface

System Reboot

Reboot the Switch in software reset

- Click **Reboot** button to reboot the switch

System Reboot

Please click **[Reboot]** button to restart switch device.

Reboot

System Reboot interface

Save Configuration

Save the industrial switch configuration to the flash memory. Power off the industrial switch without the saving, all changed configuration will lost.

- Click the  button to save the configuration



Save Configuration Interface

Rate Control

Set up every port's bandwidth rate and packet limitation type

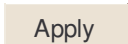
- **Limit Packet type:** Select the packet type that wants to filter. The packet types have all type packet, broadcast/multicast/unknown unicast packet, broadcast/multicast packet, and broadcast packet only. The broadcast/multicast/unknown unicast packet, broadcast/multicast packet, and broadcast packet only are only for ingress packet. The egress rate only supports all type packets
- **Band Width:** The port1 ~ port 8, supports port ingress and egress rate control. For example, assume port 1 is 10Mbps, users can set its effective egress rate as 1Mbps, ingress rate is 500Kbps. The switch performs the ingress rate by packet counter to meet the specified rate
- **Ingress:** Select the port effective ingress rate. The valid range options are 128kbps, 256Kbps, 512Kbps, 1MB, 2MB, 4MB, and 8MB. The default value is "disable"
- **Egress for all:** Select the port effective egress rate. The valid range options are 128kbps, 256Kbps, 512Kbps, 1MB, 2MB, 4MB, and 8MB. The default value is "disable"
- And then, click  button to apply the configuration

Rate Control

	Limit Packet Type	Ingress	Egress for All
Port.01	Broadcast/Multicast/Unknown Unicast ▼	Disable ▼	Disable ▼
Port.02	Broadcast/Multicast/Unknown Unicast ▼	Disable ▼	Disable ▼
Port.03	Broadcast/Multicast/Unknown Unicast ▼	Disable ▼	Disable ▼
Port.04	Broadcast/Multicast/Unknown Unicast ▼	Disable ▼	Disable ▼
Port.05	Broadcast/Multicast/Unknown Unicast ▼	Disable ▼	Disable ▼
Port.06	Broadcast/Multicast/Unknown Unicast ▼	Disable ▼	Disable ▼
Port.07	Broadcast/Multicast/Unknown Unicast ▼	Disable ▼	Disable ▼
Port.08	Broadcast/Multicast/Unknown Unicast ▼	Disable ▼	Disable ▼

Apply Help

Rate Control Interface

[NOTE]

1. Remember to execute the "Save Configuration" action, otherwise the new configuration will lose when switch power off.
 2. Qos and Rate control cannot be existed at the same.
-

System Log

Set up system log events and view the system log events

System Log Configuration

- Click **Reload** button to get newest system log event
- To clear the log events, click **Clear** button
- If log event list more than one page, drag down the list to switch to different page.
- **System Log Client Mode:** user can select in Client Only, Server Only, or Both mode
- **System Log Server IP:** Assign the system log server IP
- And then, click **Apply** button to apply the configuration

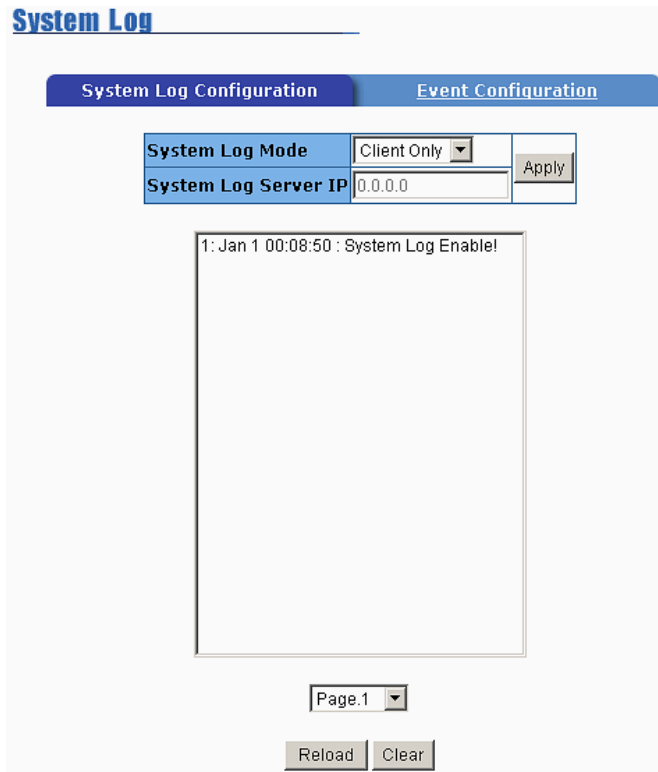

System Log Configuration interface

Event Configuration

User can select the system log events. When selected events occur, the system will send out the log information. Also, per port log events can be selected.

- **System event selection:** 4 selections – Device cold start, Power status, SNMP Authentication Failure, and X-Ring topology change. Mark the checkbox to select the event. When selected events occur, the system will produce the logs
 - **Device cold start:** When the device executes cold start action, the system will produce a log message
 - **Power status:** When the device power status has changed, the system will produce a log message
 - **SNMP Authentication Failure:** When the SNMP authentication fails, the system will produce a log message
 - **X-Ring topology change:** When the X-Ring topology has changed, the system will produce a log message.
- **Port event selection:** Select the per port events. Per port have 3 selections – Link UP, Link Down, and Link UP & Link Down. Disable means no event is selected.
 - **Link UP:** The system will produce a log message when port connection is up only
 - **Link Down:** The system will produce a log message when port connection is down only
 - **Link UP & Link Down:** The system will produce a log message when port connection is up and down

- After selected, click

System Log

System Log Configuration

Event Configuration

System event selection

- Device cold start Power status
 SNMP Authentication Failure X-ring topology change

Port event selection

Port.01	Disable <input type="button" value="v"/>	Port.02	Disable <input type="button" value="v"/>
Port.03	Disable <input type="button" value="v"/>	Port.04	Disable <input type="button" value="v"/>
Port.05	Disable <input type="button" value="v"/>	Port.06	Disable <input type="button" value="v"/>
Port.07	Disable <input type="button" value="v"/>	Port.08	Disable <input type="button" value="v"/>

Event Configuration interface

Troubles shooting

- Verify that is using the right power cord/adapter (DC 12-48V), please don't use the power adapter with DC output bigger than 48V, or it will burn this converter down.
- Select the proper UTP cable to construct user network. Please check that is using the right cable. use unshielded twisted-pair (UTP) or shield twisted-pair (STP) cable for RJ-45 connections: 100Ω Category 3, 4 or 5 cable for 10Mbps connections or 100Ω Category 5 cable for 100Mbps connections. Also be sure that the length of any twisted-pair connection does not exceed 100 meters (328 feet).
- **Diagnosing LED Indicators:** the Switch can be easily monitored through panel indicators to assist in identifying problems, which describes common problems user may encounter and where user can find possible solutions.
- If the power indicator does turn on when the power cord is plugged in, user may have a problem with power cord. Than check for loose power connections, power losses or surges at power outlet. If user still cannot resolve the problem, contact user local dealer for assistance.
- If the Industrial switch LED indicators are normal and the connected cables are correct but the packets still cannot transmit. Please check user system's Ethernet devices' configuration or status.

Technical Specification

Standard	<p>IEEE 802.3 10Base-T Ethernet</p> <p>IEEE 802.3u 100Base-TX and 100Base-FX Fast Ethernet</p> <p>IEEE802.3x Flow Control and Back-pressure</p> <p>IEEE802.1d spanning tree / IEEE802.1w rapid spanning tree</p> <p>IEEE802.1p class of service</p> <p>IEEE802.1Q VLAN Tag</p>
Protocol	CSMA/CD
Management	<p>SNMP management</p> <p>Web interface management</p> <p>One default button for system default setting</p>
SNMP MIB	<p>RFC 1213 MIBII</p> <p>RFC 1493 Bridge MIB</p> <p>RMON RFC 1757</p> <p>RFC 2674 VLAN MIB</p> <p>RFC 1643 Ethernet like MIB</p> <p>RFC 1215 Trap MIB</p> <p>Private MIB for switch information, X-Ring, port alarm, TFTP firmware upgrade, reset, port mirror, IP security management, IGMP management MIB.</p>
SNMP Trap	<p>Up to 3 Trap stations</p> <p>Cold start</p> <p>Port link Up</p> <p>Port link down</p> <p>Authentication Failure</p> <p>Private Trap for power status</p> <p>Port Alarm configuration</p> <p>Fault alarm, X-Ring</p>
Technology	Store and forward switching architecture
Transfer Rate	<p>14,880 pps for 10Base-T Ethernet port</p> <p>148,800 pps for 100Base-TX/FX Fast Ethernet port</p>
Transfer packet size	64bytes to 1522 bytes (with VLAN tag)

Packet filter	<p>4 types of packet filter rule with different packet combination:</p> <ul style="list-style-type: none"> ■ All of packet ■ Broadcast/ multicast/ unknown unicast packet ■ Broadcast/ multicast packet ■ Broadcast packet only
MAC address	2K MAC address table
Memory Buffer	1Mbits
LED	<p>Per port: Link/Activity (Green), Full duplex/Collision (Yellow)</p> <p>Per unit: Power (Green), Power 1 (Green), Power 2 (Green), Fault (Yellow), Master (Green)</p>
Network Cable	<p>10Base-T: 2-pair UTP/STP Cat. 3, 4, 5 cable EIA/TIA-568 100-ohm (100m)</p> <p>100Base-TX: 2-pair UTP/STP Cat. 5 cable EIA/TIA-568 100-ohm (100m)</p>
Optical cable	<ul style="list-style-type: none"> ■ ST (Multi-mode): 50/125um or 62.5/125um ■ ST (Single mode): 9/125um ■ Available distance: 2KM (Multi-mode) / 30KM (single-mode) ■ Wavelength: 1310nm (multi-mode/ single mode)
Back-plane	1.6Gbps
Packet throughput ability	1.19Mpps @64bytes
Power Supply	<p>12 ~48 VDC</p> <p>Redundant power with polarity reverse protects function and connective removable terminal block for master and slave power.</p>
Power consumption	7.68 Watts
X-Ring	2 ports for X-Ring to provide redundant backup feature and the recovery time below 300ms and start by Web interface management. The ring port can be defined by Web interface.
VLAN	<p>Port based VLAN</p> <p>IEEE802.1Q Tag VLAN.</p> <p>Both of port based and Tag based VLAN group up to 64 VLANs.</p>
Class of service	<p>IEEE802.1p class of service</p> <p>Per port provides 4 priority queues.</p>
Quality of service	The quality of service determined by port, Tag and Ipv4 Type of service.

Spanning tree	IEEE802.1d spanning tree IEEE802.1w rapid spanning tree.
IGMP	IGMP v1 and Query mode Up to 256 groups.
SMTP	Support SMTP to synchronize system clock in Internet
SNTP	Support SMTP Server and 4 e-mail accounts for receiving event alert
Management IP security	IP address security to prevents unauthorized intruder
Port mirror	TX packet only Both of TX and RX packet
Firmware update	TFTP firmware update TFTP backup and restore
Alarm	One relay output for port breakdown and power fail Dipswitch to mask link down port Alarm Relay current carry ability: 1A @ DC24V
Bandwidth control	<ul style="list-style-type: none"> ■ Ingress packets filter and egress packet limit. ■ The egress rate control supports all of packet type and the limit rates are 128kbps, 256Kbps, 512Kbps, 1MB, 2MB, 4MB, and 8MB. ■ Ingress filter packet type combination rule for Broadcast/Multicast/Unknown Unicast packet, Broadcast/Multicast packet, Broadcast packet only and all of packet. ■ The ingress packet filter rate can be set follow as:1Mbps、2Mbps、4Mbps、8Mbps、16Mbps、32Mbps、64Mbps.
DHCP client	DHCP client function to obtain IP address from DHCP serve
Install	DIN rail kit and wall mount ear for wall mount or DIN-type cabinet install
Operation Temp.	Standard Operating Temp. Model: -10C to 60C (14F to 140F) Wide Operating Temp. Model: -40C to +75C (-40F to 167F)
Operation Humidity	5% to 95% (Non-condensing)
Storage Temperature	-40C to +85C

Case Dimension	IP-30, 54 mm (W) x 135 mm (H) x 105mm (D)
EMI	FCC Class A, CE EN61000-4-2 (ESD), CE EN61000-4-3 (RS), CE EN-61000-4-4 (EFT), CE EN61000-4-5 (Surge), CE EN61000-4-6 (CS), CE EN61000-4-8, CE EN61000-4-11, CE EN61000-4-12, CE EN61000-6-2, CE EN61000-6-4
Safety	UL, cUL, CE/EN60950-1
Stability testing	IEC60068-2-32 (Free fall) IEC60068-2-27 (Shock) IEC60068-2-6 (Vibration)

Free Manuals Download Website

<http://myh66.com>

<http://usermanuals.us>

<http://www.somanuals.com>

<http://www.4manuals.cc>

<http://www.manual-lib.com>

<http://www.404manual.com>

<http://www.luxmanual.com>

<http://aubethermostatmanual.com>

Golf course search by state

<http://golfingnear.com>

Email search by domain

<http://emailbydomain.com>

Auto manuals search

<http://auto.somanuals.com>

TV manuals search

<http://tv.somanuals.com>